



Quick Installation Guide

Access Point

This document will guide you through the basic installation process for your new D-Link Nuclias Cloud-Managed AX1800 Access Point

DBA-X1230P

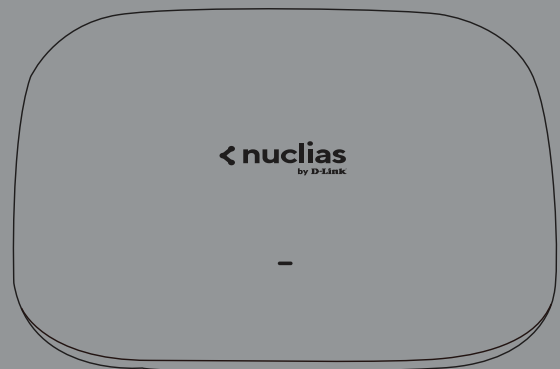

Documentation is also available on
the D-Link website

Before You Begin

This installation guide provides instructions for installing the DBA-X1230P on your network. Additional documentation is also available on the D-Link support website.

- **D-Link Nuclias User Manual:** For additional information and instructions on how to configure the device using the D-Link Nuclias Cloud.
- **DBA-X1230P User Manual:** For additional information and instructions on how to configure the device using the web user interface.

Package Contents

This DBA-X1230P package should include the following items:

- 1 x DBA-X1230P
- 1 x Power adapter (optional)*
- 1 x Mounting kit

If any of the above items are damaged or missing, please contact your local D-Link reseller.

*If the power adapter is not included, it can be purchased separately. Please contact your local D-Link reseller.

Setup Preparation

Please ensure that the following items are readily available before continuing the installation process:

- An active D-Link Nuclias account.
- An active Internet connection to connect to the D-Link Nuclias cloud.
- A valid device license. Contact your D-Link Nuclias service provider for more information.

System Requirements

- A PC or laptop with a working Ethernet adapter or wireless interface.
- Mozilla Firefox 52.0 or higher, Internet Explorer 11 or higher, Safari 10.1 or higher, Google Chrome 59 or higher.
- OS X 10.8.5, Windows 7, Linux (Ubuntu 12).

Hardware Overview

LED Indicators

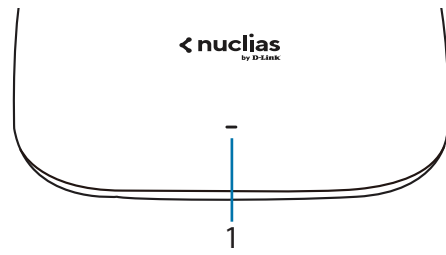

Figure 1: Front Panel LED

#	LED	Status	Description
1	Power/Cloud	Solid orange	The DBA-X1230P is booting up.
		Blinking orange	The DBA-X1230P is resetting to its default settings or is upgrading its firmware.
		Blinking green	The DBA-X1230P is connecting to the D-Link Nuclias cloud.
		Solid green	The DBA-X1230P is in cloud mode.
		Solid red	The DBA-X1230P is not working properly in cloud mode.

Table 1: LED Description

Interface Connectors

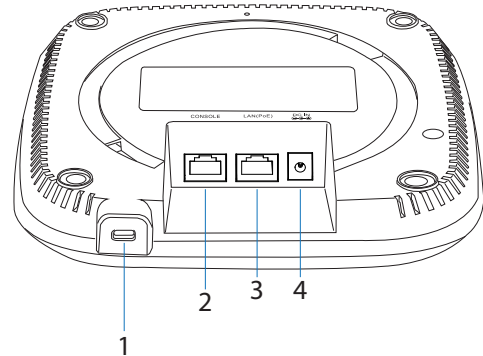

Figure 2: Rear Connectors

#	Connector	Description
1	Lock slot	Slot to use with the lock plate for inserting a physical lock to secure the DBA-X1230P to the mounting plate (optional).
2	Console port	Directly manage the AP with no wireless connection through the console port.
3	PoE LAN port	Gigabit RJ-45 port for data and Power over Ethernet (PoE) power.
4	Power input	Input for the power adapter (optional).

Table 2: Interface Description

Powering the Access Point

The DBA-X1230P can be powered using one of the following two methods:

Using Power over Ethernet (PoE)

Use a standard Ethernet cable to connect the LAN port on the DBA-X1230P to a PoE power source device such as a PoE switch or PoE injector.

(Optional) Using the Power Adapter

Connect the power connector of the adapter to the power input on the DBA-X1230P and plug the adapter into a nearby power outlet.

Configuring the Access Point

Using D-Link Nuclias

Note: To use D-Link Nuclias, the DBA-X1230P must be connected to the Internet.

The DBA-X1230P is designed to be managed through the D-Link Nuclias cloud. Refer to the D-Link Nuclias User Manual for detailed configuration instructions.

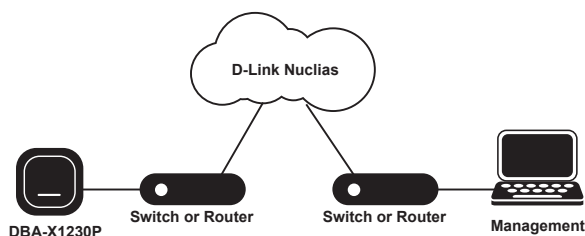

Figure 3: Connecting through D-Link Nuclias

1. On an Internet-connected PC, open a web browser and go to **www.nuclias.com**.
2. Enter your D-Link Nuclias user name and password.

If a device's login credentials are modified using Nuclias Cloud, the local username and password will also reflect the changes made. To learn more about configuring your password, please refer to the Nuclias Cloud manual.

Manual Configuration

Note: D-Link recommends manually configuring the device before mounting it.

If you are unable to connect to the D-Link Nuclias cloud, you may need to manually configure the DBA-X1230P using its web user interface (UI).

Refer to the DBA-X1230P User Manual for detailed configuration instructions.

Use one of the following methods to access the web user interface:

Connecting through Ethernet

Note: The management PC must be in the same subnet as the DBA-X1230P.

1. Use an Ethernet cable to connect the DBA-X1230P to the management PC or to the switch or router the management PC is connected to.
2. Open a web browser and type in the default host name of the DBA-X1230P and press **Enter**. The default host name is **DBA-X1230P-XXXX** where **XXXX** represents the last 4 characters of the MAC address listed on the device label located on the bottom of the device.
3. When prompted, enter the default login credentials:
User name: **admin**
Password: **admin**

Connecting Wirelessly

1. Connect the management PC to the default SSID of the DBA-X1230P. The SSID will be in the format **DBA-X1230P-XXX** where **XXXX** represents the last 4 characters of the MAC address listed on the device label located on the bottom of the device.
2. Open a web browser and type in the default host name of the DBA-X1230P and press **Enter**. The default host name is **DBA-X1230P-XXXX** where **XXXX** represents the last 4 characters of the MAC address listed on the device label located on the bottom of the device.
3. When prompted, enter the default login credentials:
User name: **admin**
Password: **admin**

Attaching the Rubber Pads

The included rubber pads can be placed on the bottom of the device to prevent the device from damaging the surface it is placed on.

1. Remove the rubber pads from the adhesive strip.
2. Stick one pad on each foot on the bottom panel of the access point.

Mounting on a Solid Wall or Ceiling

1. (Optional) Attach the included lock plate to the mounting plate using the included screws.

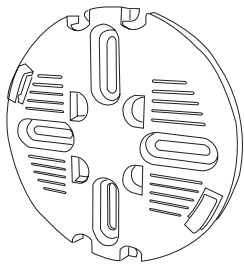

Figure 4: Attaching the Lock Plate

2. Use the mounting plate to mark the location where to drill the holes in the wall or ceiling.

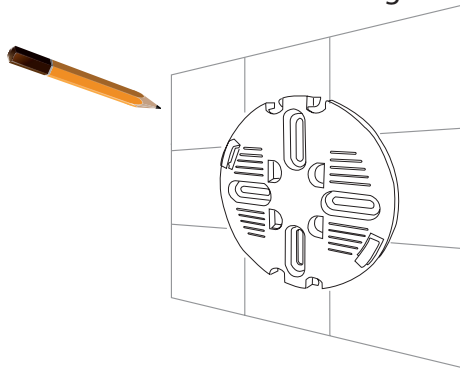

Figure 5: Mounting Panel Marking

3. Drill holes on the markings and place the included anchors into the drilled holes.

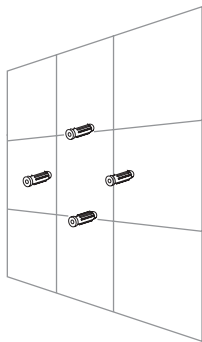

Figure 6: Placing Anchors

4. Align and place the mounting plate on top of the anchors and use the included screws to secure the mounting plate to the surface.

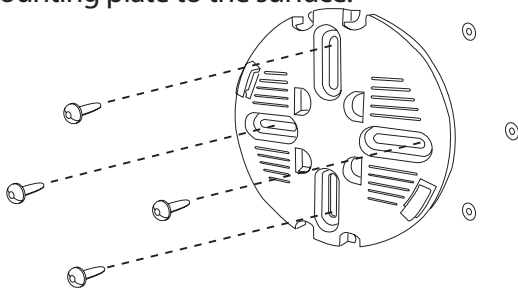

Figure 7: Securing the Mounting Plate

5. Connect the Ethernet cable and power adapter (optional) to the device.

6. Slide the DBA-X1230P onto the mounting plate.

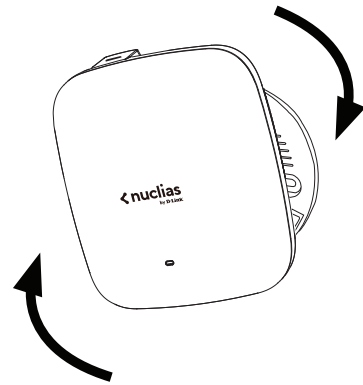

Figure 8: Placing The Access Point

Mounting on a Ceiling Crossbar

1. (Optional) Attach the included lock plate to the mounting plate using the included screws.

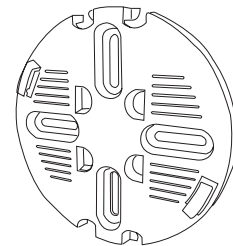

Figure 9: Attaching the Lock Plate

2. Clip the two included ceiling brackets onto the ceiling crossbar. Make sure both brackets are positioned in line with each other.

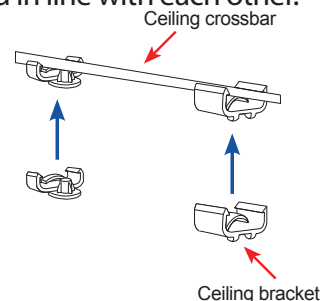

Figure 10: Attaching the Ceiling Brackets

3. Using the included screws, secure the mounting plate to the ceiling brackets.

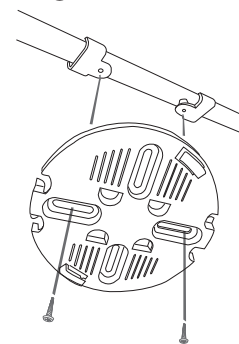

Figure 11: Attaching Mounting Plate

4. Connect the Ethernet cable and power adapter (optional) to the device.

- Slide the DBA-X1230P onto the mounting plate.

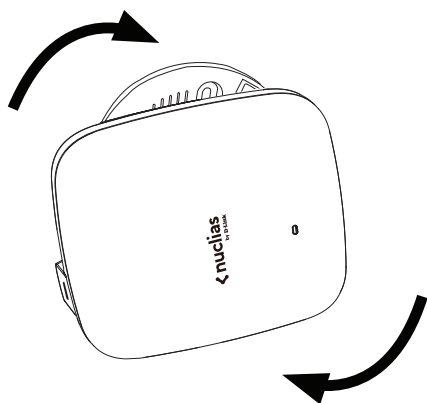

Figure 12: Securing the Access Point

Locking the DBA-X1230P

If the lock plate was attached, insert a lock through the device's lock slot to secure the DBA-X1230P to the mounting plate.

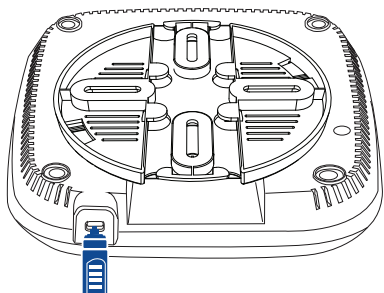

Figure 13: Inserting a Physical Lock

Reboot/Reset the Access Point

If necessary, the DBA-X1230P can be manually rebooted or reset to factory default settings.

Rebooting the Device

Press and hold down the reset button between **2 to 5 seconds** and release to reboot the device.

Resetting the Device

Press and hold down the reset button between **6 to 15 seconds** and release to reset the device to its factory default settings.

Press and hold down the reset button for **more than 15 seconds** and release to reset the device to its factory default settings and force the device to load an alternate firmware.

Troubleshooting

The DBA-X1230P receives its configuration settings and is managed through the D-Link Nuclias cloud.

If you are experiencing problems connecting to the D-Link Nuclias cloud, check your Internet connection. If you still cannot connect to the service, additional configuration on the device may be required. Refer to the DBA-X1230P User Nuclias Cloud Manual for detailed information on how to manually configure the device.

Additional Information

For additional support, please refer to the user manual, or visit your local D-Link support website.

Warning: The DBA-X1230P is designed to receive PoE power only from an 802.3at compliant source, or from a D-Link-approved power adapter. Connecting an access point to a Power over Ethernet (PoE) device that is not approved by D-Link can damage the equipment.

Appendix - Statements

ErP Power Usage

This device is an Energy Related Product (ErP) that automatically switches to a power-saving Network Standby mode within 1 minute of no packets being transmitted. It can also be turned off through a power switch to save energy when it is not needed.

Network Standby: 7.27 watts

Switched Off: 0.06 watts

Federal Communication Commission Interference Statement

This equipment has been tested and found to comply with the limits for a Class B digital device, pursuant to Part 15 of the FCC Rules. These limits are designed to provide reasonable protection against harmful interference in a residential installation. This equipment generates, uses and can radiate radio frequency energy and, if not installed and used in accordance with the instructions, may cause harmful interference to radio communications. However, there is no guarantee that interference will not occur in a particular installation. If this equipment does cause harmful interference to radio or television reception, which can be determined by turning the equipment off and on, the user is encouraged to try to correct the interference by one of the following measures:

- Reorient or relocate the receiving antenna.
- Increase the separation between the equipment and receiver.
- Connect the equipment into an outlet on a circuit different from that to which the receiver is connected.
- Consult the dealer or an experienced radio/TV technician for help.

Non-modifications Statement:

Any changes or modifications not expressly approved by the party responsible for compliance could void the user's authority to operate this equipment.

Caution:

This device complies with Part 15 of the FCC Rules. Operation is subject to the following two conditions:

- (1) This device may not cause harmful interference, and
- (2) this device must accept any interference received, including interference that may cause undesired operation.

This device and its antenna(s) must not be co-located or operating in conjunction with any other antenna or transmitter except in accordance with FCC multi-transmitter product procedures. For product available in the USA/Canada market, only channel 1~11 can be operated. Selection of other channels is not possible.

Note

The country code selection is for non-USA models only and is not available to all USA models. Per FCC regulations, all WiFi product marketed in the USA must be fixed to USA operational channels only.

RF Frequency Requirements

This device is for indoor use only when using all channels in the 5.15 to 5.25 GHz frequency range. High power radars are allocated as primary users of the 5.25 to 5.35 GHz and 5.65 to 5.85 GHz bands. These radar stations can cause interference with and/or damage this device. This device will not operate on channels which overlap the 5600-5650 MHz band.

It is restricted to indoor environments only.

IMPORTANT NOTICE:

FCC Radiation Exposure Statement

This equipment complies with FCC radiation exposure limits set forth for an uncontrolled environment. This equipment should be installed and operated with minimum distance 23.7cm between the radiator and your body.

Innovation, Science and Economic Development Canada (ISED) Statement:

This Class B digital apparatus complies with Canadian ICES-003.

Cet appareil numérique de la classe B est conforme à la norme NMB-003 du Canada.

Innovation, Science and Economic Development Canada (ISED) Statement:

This device complies with ISED licence-exempt RSS standard(s). Operation is subject to the following two conditions:

- (1) this device may not cause interference, and
- (2) this device must accept any interference, including interference that may cause undesired operation of the device.

Le présent appareil est conforme aux CNR d'ISED applicables aux appareils radio exempts de licence. L'exploitation est autorisée aux deux conditions suivantes :

- (1) l'appareil ne doit pas produire de brouillage, et
- (2) l'utilisateur de l'appareil doit accepter tout brouillage radioélectrique subi, même si le brouillage est susceptible d'en compromettre le fonctionnement.

(i) the device for operation in the band 5150-5250 MHz is only for indoor use to reduce the potential for harmful interference to co-channel mobile satellite systems;

(i) les dispositifs fonctionnant dans la bande 5150-5250 MHz sont réservés uniquement pour une utilisation à l'intérieur afin de réduire les risques de brouillage préjudiciable aux systèmes de satellites mobiles utilisant les mêmes canaux;

Operations in the 5.25-5.35 GHz band are restricted to indoor usage only.

Les opérations dans la bande de 5.25-5.35 GHz sont limités à un usage intérieur seulement.

Radiation Exposure Statement

This equipment complies with ISED radiation exposure limits set forth for an uncontrolled environment. This equipment should be installed and operated with minimum distance 26.6cm between the radiator and your body.

Déclaration d'exposition aux radiations

Cet équipement est conforme aux limites d'exposition aux rayonnements ISED établies pour un environnement non contrôlé. Cet équipement doit être installé et utilisé avec un minimum de 26.6cm de distance entre la source de rayonnement et votre corps.

Japan Voluntary Control Council for Interference Statement

この装置は、クラス B 情報技術装置です。この装置は、家庭環境で使用することを目的としていますが、この装置がラジオやテレビジョン受信機に近接して使用されると、受信障害を引き起こすことがあります。

取扱説明書に従って正しい取り扱いをして下さい。

VCCI-B

Japan Voluntary Control Council for Interference Statement

This is a Class B product based on the standard of the VCCI Council. If this is used near a radio or television receiver in a domestic environment, it may cause radio interference. Install and use the equipment according to the instruction manual.

電波法により5GHz帯は屋内使用に限ります。

Product and Warranty Information

To find out more about D-Link products or marketing information, please visit the website <http://www.dlink.com>.

The D-Link Limited Lifetime Warranty information is available at <http://warranty.dlink.com/>

D-Link[®]
Building Networks for People



Ver. 1.00(WW)_90x130
2021/02/02