

DCS-3110

Release 1.0

# Megapixel PoE Network Camera

## User Manual

Business Class Networking

# Table of Contents

<b>Product Overview</b> .....	<b>4</b>	Network Setup .....	39
Package Contents.....	4	Dynamic DNS .....	45
System Requirements .....	4	Image Setup .....	46
Introduction.....	5	Audio and Video.....	47
Features.....	6	Motion Detection .....	49
Hardware Overview .....	8	Time and Date .....	52
Connections.....	8	Event Setup .....	53
ICR and Built-in Microphone .....	9	Add Server .....	55
Compact Flash Card Slot.....	9	Add Media .....	56
Hardware Installation .....	10	Add Event.....	59
		Add Recording .....	60
<b>Software Installation</b> .....	<b>12</b>	Advanced .....	61
		DI and DO .....	61
<b>Configuration</b> .....	<b>15</b>	RS485 .....	62
Installation Wizard .....	15	ICR .....	64
PPPoE Setup .....	17	Access List.....	65
Web-based Configuration Utility .....	23	Maintenance .....	66
Live Video .....	24	Device Management .....	66
Using RTSP Players .....	25	Backup and Restore .....	67
Using 3GPP Mobile Phones .....	26	Firmware Update .....	68
Camera .....	27	Status.....	69
Snapshot.....	29	Device Info .....	69
Client Setup .....	30	Logs .....	70
Setup .....	31	Help .....	71
Wizard.....	31		
Internet Connection Setup Wizard .....	31	<b>D-ViewCam Installation</b> .....	<b>72</b>
Motion Detection Setup Wizard.....	36	Add a Camera.....	75

<b>Megapixel PoE Network Camera Features .....</b>	<b>80</b>
<b>Megapixel PoE Network Camera Installation .....</b>	<b>81</b>
<b>Networking Basics .....</b>	<b>83</b>
Check your IP address .....	83
Statically Assign an IP address .....	84
<b>Reset and Restore .....</b>	<b>85</b>
<b>External I/O Port .....</b>	<b>86</b>
<b>Technical Specifications.....</b>	<b>87</b>
<b>Contacting Technical Support.....</b>	<b>89</b>
<b>Warranty .....</b>	<b>90</b>
<b>Registration.....</b>	<b>96</b>

## Package Contents

- D-Link DCS-3110 Megapixel PoE Network Camera
- CAT5 Ethernet Cable
- Power Adapter
- Screws
- Manual and Software on CD
- Quick Install Guide



**Note:** Using a power supply with a different voltage than the one included with your product will cause damage and void the warranty for this product.

If any of the above items are missing, please contact your reseller.

## System Requirements

- Windows® XP or Windows Vista®
- At least 256MB of memory (512MB recommended)
- Internet Explorer 6.x or higher
- VGA card resolution: 800 x 600 or above
- CPU: 1.7GHz or above (2.8GHz plus processor with 512MB memory and a 32MB video card is required for multiple camera viewing and recording in IP surveillance program)
- An available Ethernet connection

# Introduction

DCS-3110 is an ideal network camera for professional surveillance and security applications. This camera adopts a 1.3 mega-pixel progressive scan CMOS sensor and the motion JPEG stream covers three times larger scene which is also at least three times higher than analog CCTV cameras. This is also a very important consideration in video surveillance applications, where a high resolution image helps to identify a criminal.

Two video streams with different configurations can be activated simultaneously to address different requirements for live viewing and recording. Multicast video/audio stream helps to reduce the network transmission load. When a multicast-enabled router is used, the network camera can serve multiple clients at the same time.

The DCS-3110 has a built-in removable IR-cut filter and is designed for both indoor/outdoor (with enclosure) day/night applications. The camera is equipped with one digital input and one digital output. An RS-485 port is designed for external pan/tilt/zoom devices. An 802.3af compliant power over Ethernet (PoE) module is built-in to ease the installation process.

With the free-bundled 32-channel recording software (D-ViewCam), this network camera provides a total solution for high quality live viewing and reliable recording.

# Features

- **Powerful Surveillance** - The DCS-3110 is designed to target the high-end surveillance market. As mentioned earlier, a 1.3 mega-pixel progressive scan CMOS sensor covers three times larger view. The DCS-3110 is a powerful network camera for both day and night applications. It effectively reduces motion blur and distortion as well as jagged edges of recorded images. With a removable IR-cut filter, the Network Camera always provides high-quality images in both daytime and nighttime. An RS-485 port is designed for external pan/tilt/zoom devices. It supports DC12V output for external devices like IR light.
- **Sharp Image Monitoring** - DCS-3110 provides high quality real-time videos in MPEG-4 and JPEG compression with VGA/QVGA/QQVGA resolution. It is also suitable for narrow space surveillance, like an elevator.
- **View Live Video from a 3G Mobile Phone** - The live video feed of the Network Camera can be pulled from the 3G cellular network by using a compatible cell phone or PDA with a 3G video player. Users are offered a flexible and convenient way to remotely monitor a home or office in real time, anywhere within the 3GPP service area.
- **Wired PoE Access** - For effective surveillance in or around a building, this camera comes with a built-in 802.3af compliant Power Over Ethernet (PoE) module, which eases the installation process and also gives you the freedom to place the camera where it's needed. In addition, the 10/100BASE-TX Ethernet port provides convenient connection to an Ethernet network or to broadband Internet via a router.
- **Smart & Easy To Use** - The software allows you to view up to 32 cameras on a single computer screen at one central location. Users can set up automated e-mail alerts to be instantly informed of unusual activities. In addition, this network camera supports the universal plug-n-play (UPnP™) feature, which allows computers running on Windows® XP/Vista to automatically recognize the camera and adds it to the network. Sign up with one of the free Dynamic DNS services available on the web to assign a domain name to the camera (e.g.mycamera.dlinkddns.com). This allows users to remotely access the camera without having to remember the IP address.

- **Supported Protocols** - DCS-3110 supports a wide variety of protocols such as RTSP, FTP, SMTP, NTP and HTTP. In addition, the camera supports UPnP and DDNS.
- **Web Configuration** - Using a Web browser, administrators can configure and manage the network camera directly from its own web page via your network or the Internet. Up to 20 user accounts can be created with privilege settings controlled by the administrator.
- **Connection to External Devices** - Supporting auxiliary Input/Output connectors, you can connect the Network Camera to a variety of external devices such as IR-sensors, switches and alarm relays. Combined with programmable alarm equipment, you can develop a variety of security applications that are triggered on alarm-based events. The Network Camera provides an industry standard in/out external connector for connectivity.
- **MPEG4 Multicast Stream Support** – Unicast video is delivered through point-to-point transmission. On the other hand, with a multicast stream, the server streams to a multicast IP address on the network, and clients receive the stream by subscribing to the IP address. Because there is only one stream from the server regardless of the number of clients receiving the stream, a multicast stream requires the same amount of bandwidth as a single unicast stream containing the same content. Using a multicast stream preserves network bandwidth.
- **Samba Client Support** – DCS-3110 has a built-in Samba client for NAS, and hence does not require a direct connection to a PC or any other hardware or software to capture and transfer images.

**Note:** Use of audio or video equipment for recording the image or voice of a person without their knowledge and consent is prohibited in certain states or jurisdictions. Nothing herein represents a warranty or representation that the D-Link product provided herein is suitable for the end-user's intended use under the applicable laws of his or her state. D-Link disclaims any liability whatsoever for any end-user use of the D-Link product, which fails to comply with applicable state, local, or federal laws.

# Hardware Overview

## Connections

### Rear View

#### Microphone Connector:

The camera has an internal built-in microphone. To use an external microphone, plug it into the microphone connector.

#### Status LED

**Blinking Red:** indicates power is being supplied to the camera.

**Solid Green:** indicates that a connection has been established via Ethernet port.

**Blinking Green:** indicates traffic movement in the camera.

If the Ethernet connection is not established the Status LED will not glow.

#### Audio Out Connector:

Use the Audio Out connector for 2-way audio connection. Speakers (not included) may be connected to the camera for 2-way audio communication.

#### Reset Button

Reset is initiated when the reset button is pressed once and held 30 seconds until the power LED flashes through its cycle twice.

#### Mic On/Off Switch:

Select to turn the microphone On or Off.

#### Power Receptor

Receptor for the supplied power adapter.

#### Ethernet Port (PoE)

Connect the Network Camera to your network using a CAT5 Ethernet cable. This port supports the NWay protocol, allowing the network camera to automatically detect or negotiate the transmission speed of the network.

The Ethernet port can also be used to power the camera by using a PoE switch.

#### DI/DO:

The DCS-3110 provides a general I/O terminal block. The I/O connectors provide the physical interface to send and receive digital signals to and from a variety of external devices.

#### DC12V output :

Support for external device (like IR light)

#### RS485:

Port is designed for external pan/tilt/zoom devices.

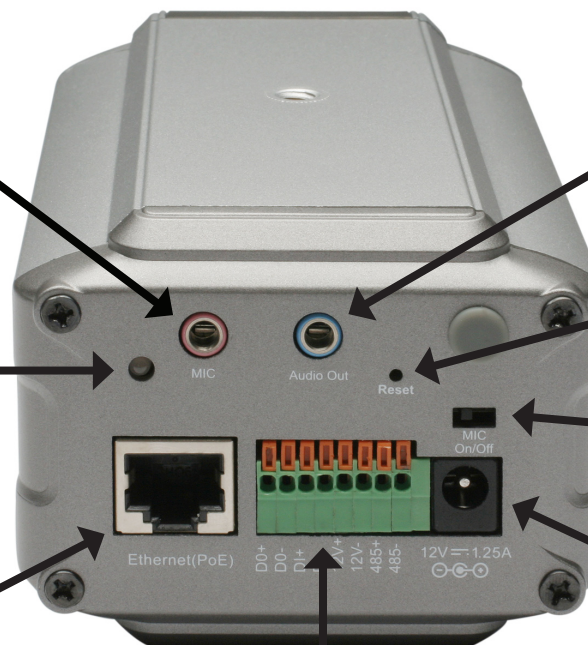



# Interfaces

## Front View

### ICR and Built-in Microphone

### Compact Flash Card Slot

#### IR-Cut Removable (ICR) Sensor

The IR-Cut removable sensor will judge the light conditions and then switches from color to B/W accordingly.

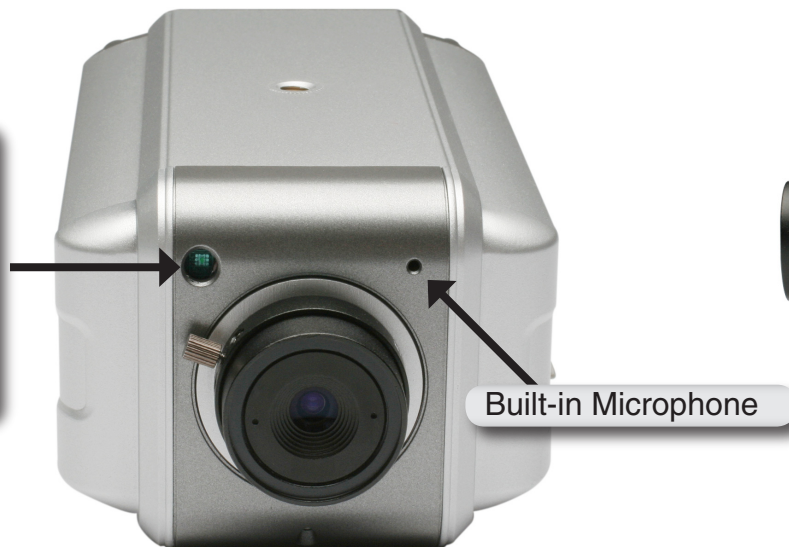

#### CF card slot

CompactFlash (CF) is a mass storage device format used in portable electronic devices. The CF card slot can be seen at the side of the network camera.

**Note:** Ensure to remove the rubber strip before using it.

# Hardware Installation

## Connect the Ethernet Cable

Connect an Ethernet cable to the Ethernet port located on the Network Camera's back panel and attach it to the network.



## Connect Using Power-Over-Ethernet

Once you connect an Ethernet cable to your PoE switch or adapter, the Power LED on the DCS-3110 will turn green to indicate a proper connection.

## Attach the External Power Supply

Attach the supplied power adapter to the DC power input connector located on the Network Camera's back panel (labeled DC 12V) and connect the other end to an AC power outlet.



**Note:** The LED on the network camera will turn green, when you have a proper connection. The light might go on and off and your computer may show an intermittent loss of connectivity, this is normal until you have configured your Network Camera.

The package comes with a camera stand with a swivel ball screw head that can be attached to the Network Camera bottom socket cavity. Attach the camera stand to the Network Camera and station it for your application. There are holes located in the base of the camera stand allowing the camera to be mounted to the ceiling, or any wall securely.



# Software Installation

Turn on the computer and insert the D-Link DCS-3110 CD into the CD-ROM drive. The following step-by-step instructions displayed are shown when using Windows Vista® operating system. The steps and screens are similar when using other Windows® operating systems.

Click on **Installation Wizard**



The Installation Setup Wizard window will pop up. Click **Next** to continue.

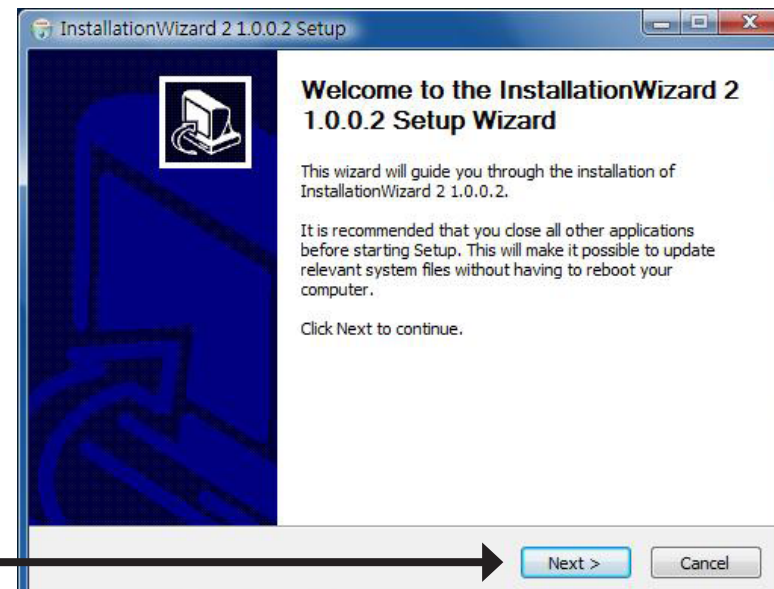

Click **Next**

Click **I Agree** to accept the License Agreement.

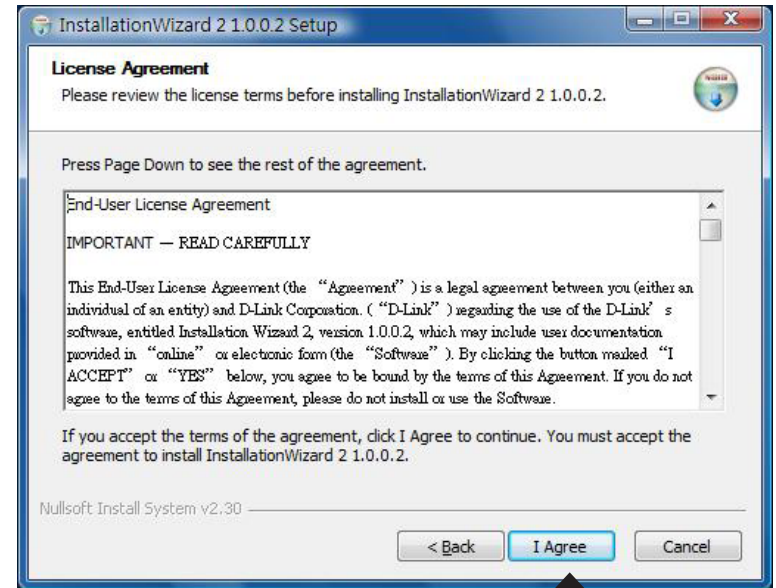

Click **I Agree**

Click the **Browse** button if you would like to change the destination of installation, otherwise click **Install** to continue.

**Note:** Installation may take several minutes to complete.

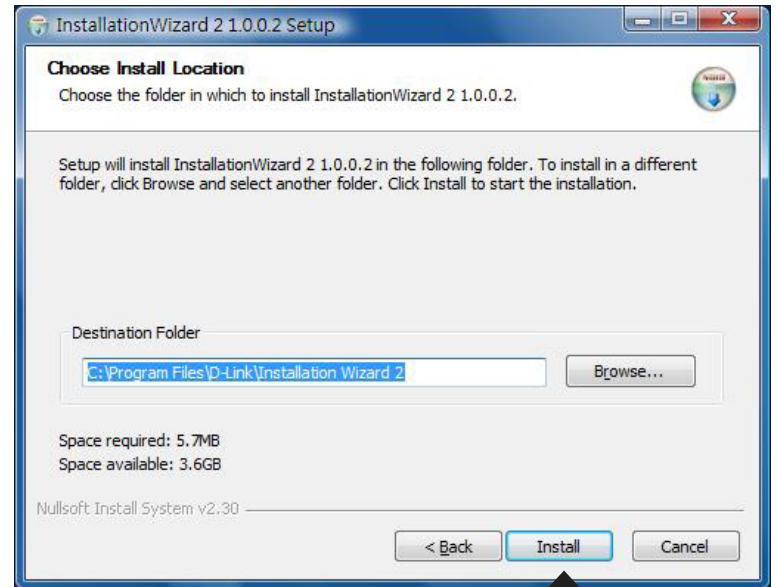

Click **Install**

Click **Finish** to complete installation and the D-Link Installation Wizard window will pop up for camera configuration.

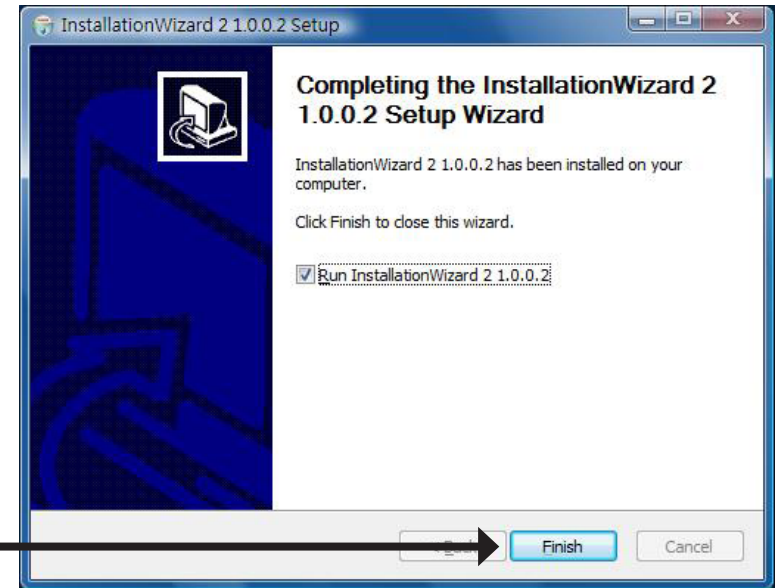

Click **Finish**

# Configuration Installation Wizard

If the **D-Link Installation Wizard** window does not pop up after completion of software installation, click on the icon that was created in your Windows Start Menu.

The Installation Wizard will appear and show the MAC address and IP address of the DCS-3110, which may appear to be different from the actual address depending on what your device is connected to. If you have a DHCP server on your network, there will be a valid IP address displayed here.

To begin setup, select the DCS-3110 located in the camera list and click **Manual Setup** located on the left of the Installation Wizard.

Click Manual Setup

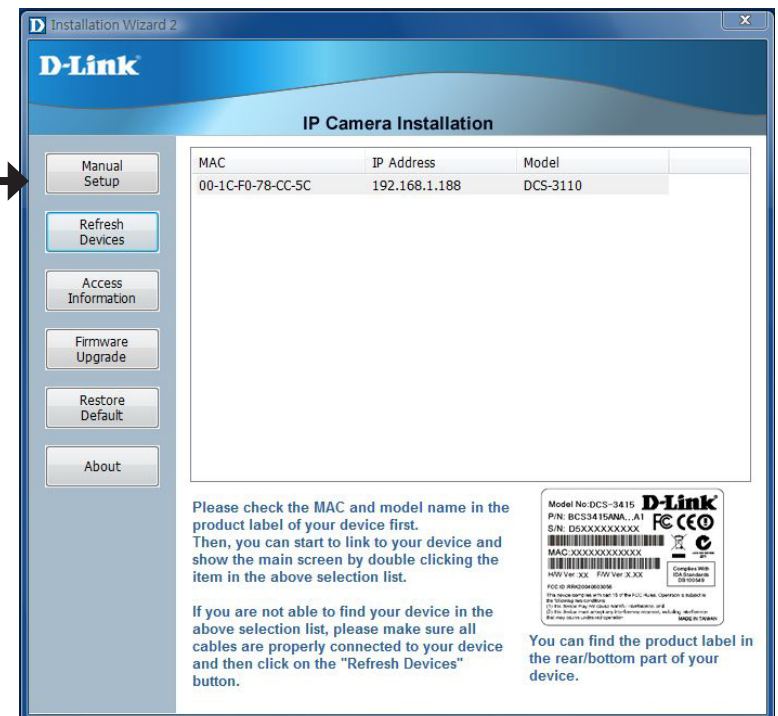

Enter a password, and confirm the password for the admin ID and click **Next**.

**Note:** The default administrator username is set to admin and the password may be left blank. The password can be changed after installation.

Click Next

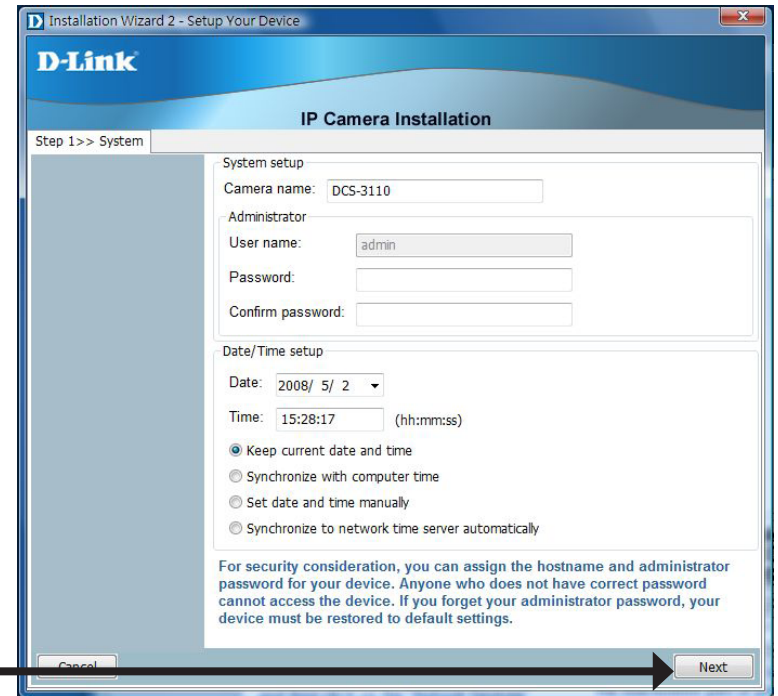



## PPPoE Setup

The **Network Type** prompt will pop up to ask if you want to setup a PPPoE for the device. Click **No** for quick setup and skip to the next page.

**Note:** By using PPPoE, users can virtually dial from one machine to another over an Ethernet network, establish a point to point connection between them and then securely transport data packets over the connection.

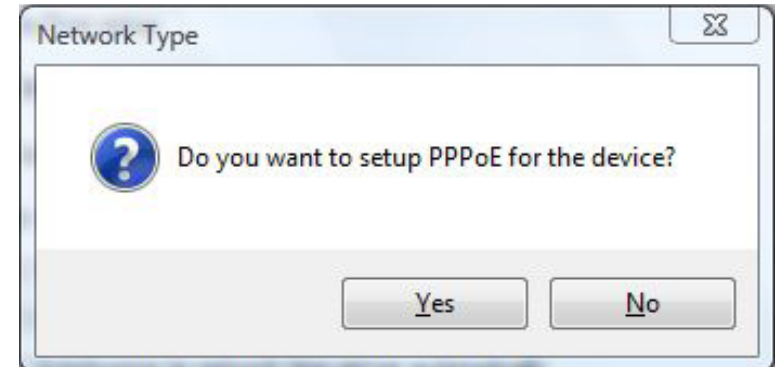

If you have selected **Yes**, enter the username and password provided by your ISP to connect to the Internet by PPPoE.

Click **Next** and skip to the setup screen as seen in page 19.

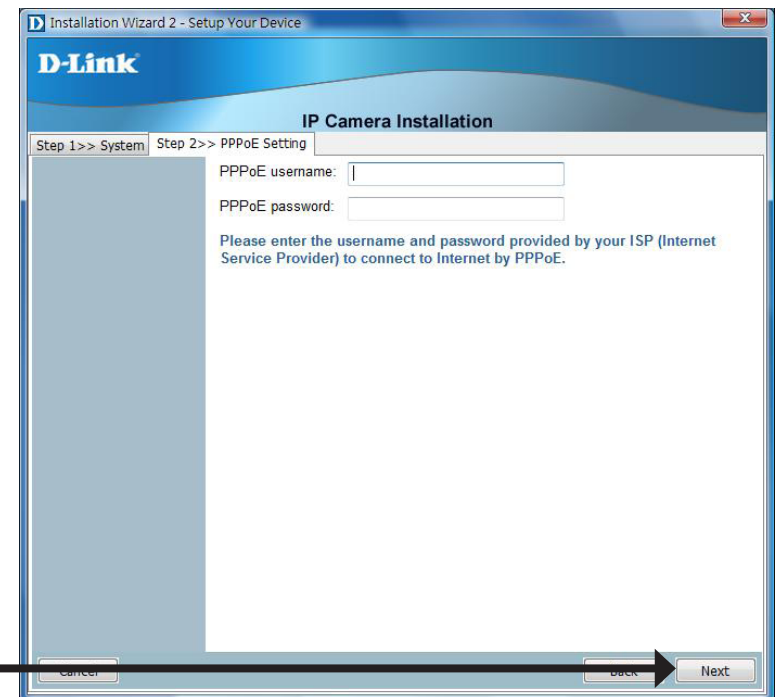

Click **Next**

Check the **Get IP by DHCP Server automatically** box to obtain a new IP address every time the camera starts up. Click **Next** to continue.

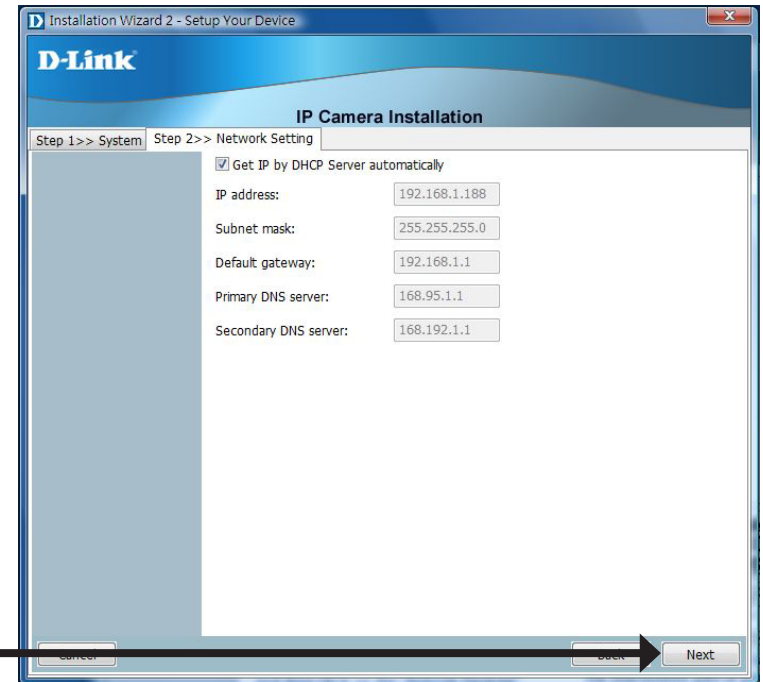

Click Next

Select **UPnP Port Forwarding** if your router supports this function. If not, choose **Manual** to manually enter your port numbers. Click **Next** to continue.

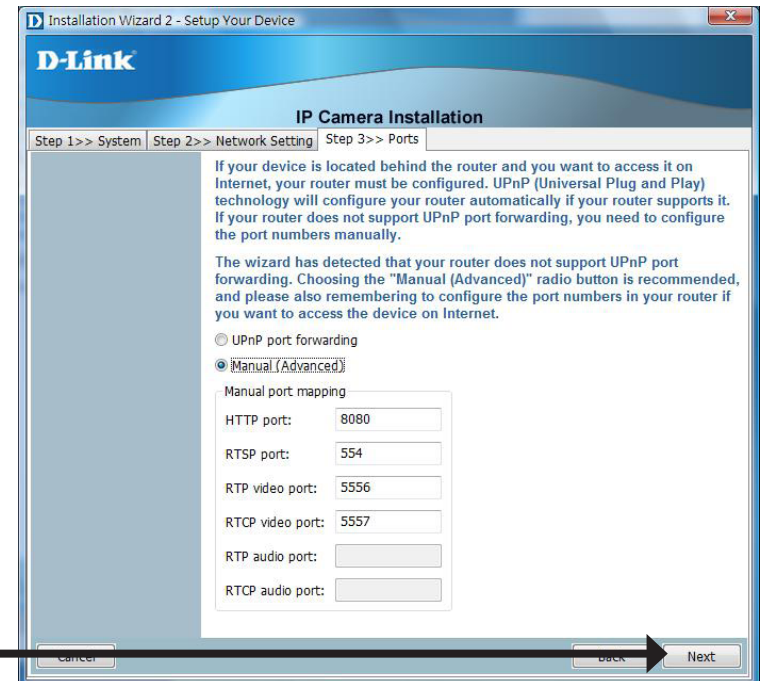

Click Next

Select **Enable DDNS** if you have subscribed to a Dynamic DNS account and would like your camera to update its IP address automatically. Enter all the relevant account information.

Click **Next** to continue.

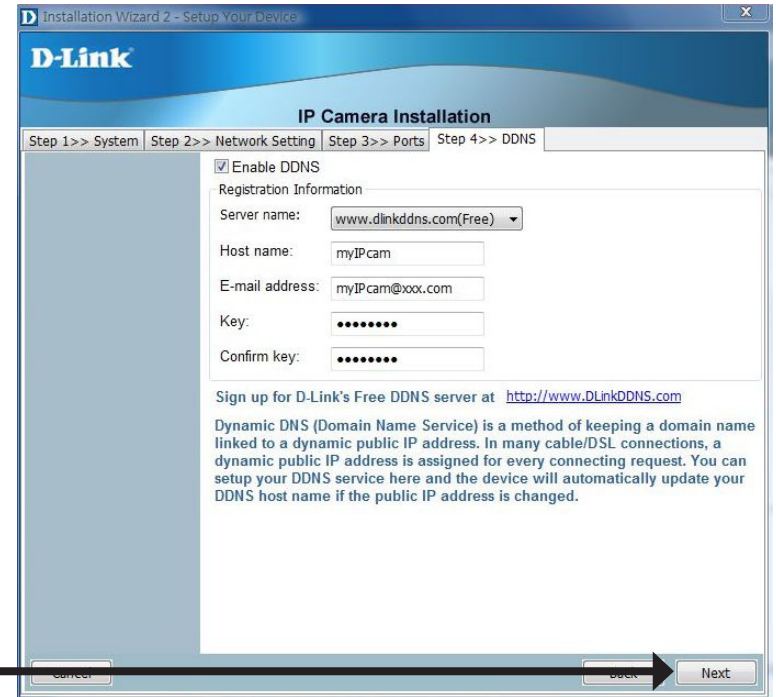

Click **Next**

A window will pop up asking you if you want to access the DCS-3110 via mobile phone. Clicking **Yes** will set the video resolution to 176x144. Click **No** to continue.

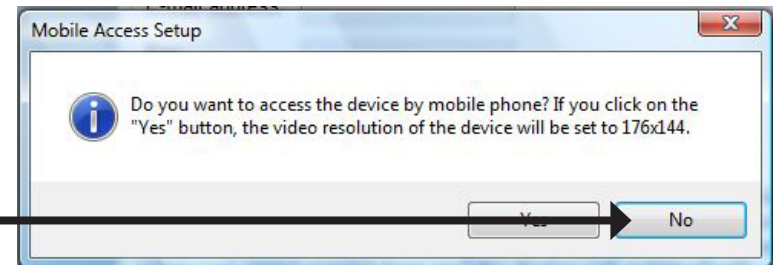

Click **No**

Click **Apply** to save and activate the settings listed in the window to the device. Application may take a few minutes to process.

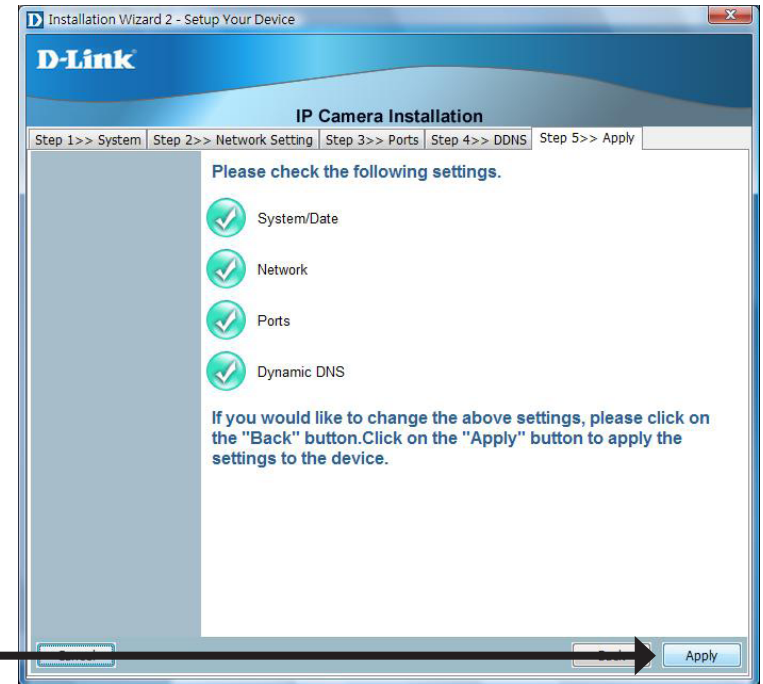

A window will pop up to confirm the installation was successful. Click **OK** to continue.

A new window will pop up displaying the lists to access your device, click **Add to my favorite** to save the address and then click **Exit** to complete installation.

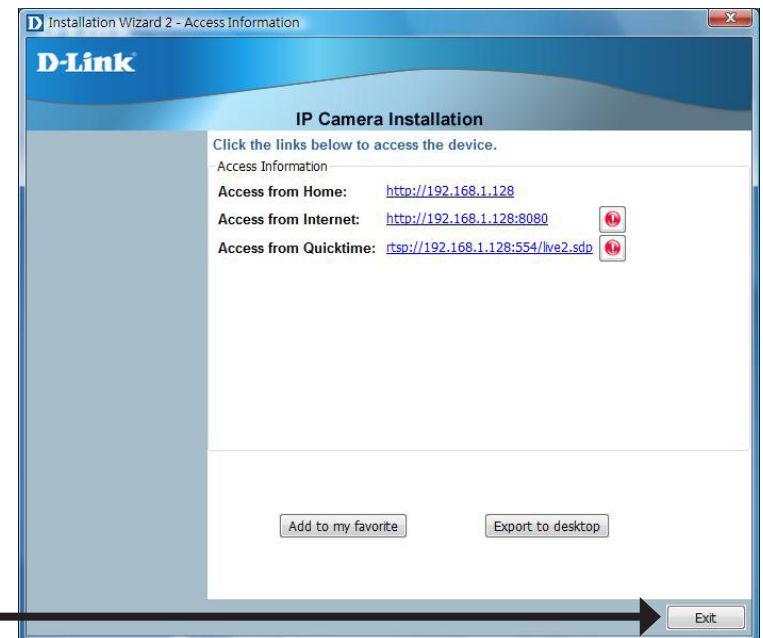

Double-click **DCS-3110** in the Installation Wizard window to launch the camera's web configuration utility.

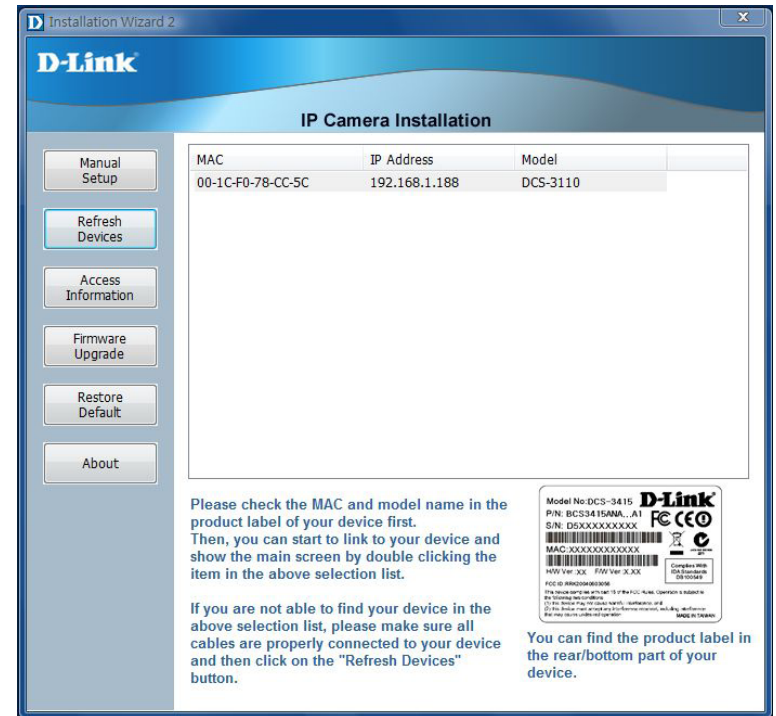

Enter **admin** as the default username and leave the password blank. Click **OK** to continue.

**Note:** If you have changed your password, please enter your new password.

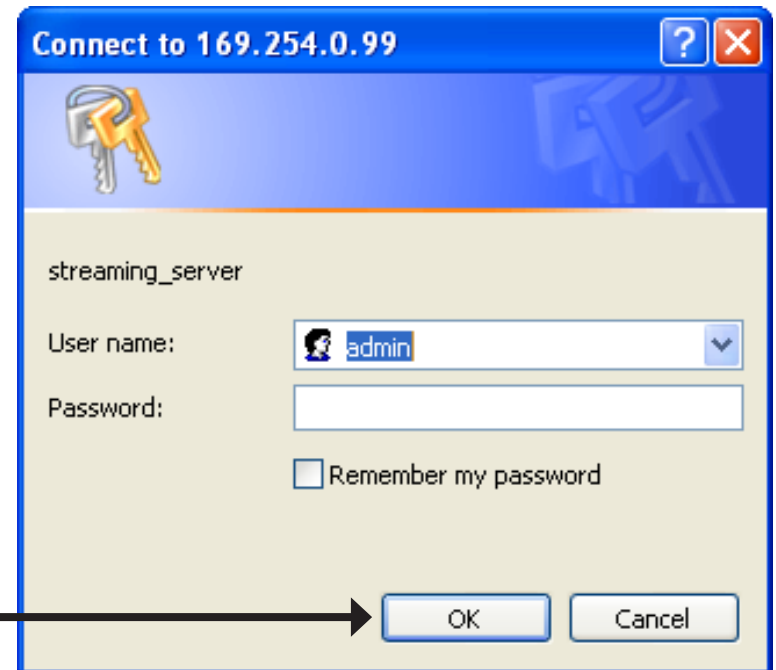

Click **OK**

This section shows your camera's live video. You can control your settings using the buttons below.



# Web-based Configuration Utility

This section will show you how to configure your new D-Link Network Camera using the Web-based Configuration Utility.

To access the configuration utility, open a web-browser such as Internet Explorer and enter the IP address of your Network Camera (<http://192.168.0.120>)

**Note:** In the example, this address is 192.168.0.120. Your address may differ.

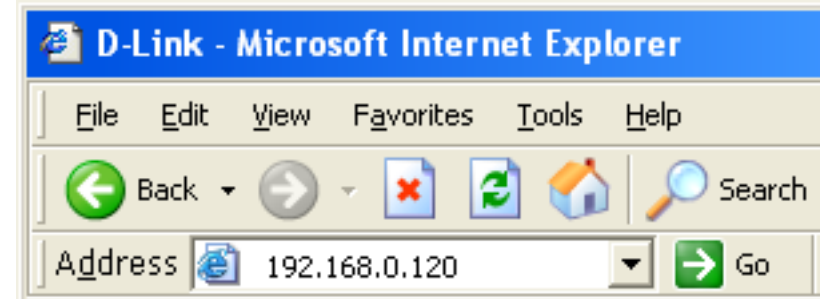

Type **Admin** in the user name field and leave the password blank by default. Click **OK** to continue.

**Note:** You may refer to page 66 to change the password for your admin account.



Click **OK**

# Live Video





As seen by Mozilla Firefox and Netscape users, Quick Time player is invoked to stream the live video.





## Using RTSP Players

Use one of the following media players that support RTSP streaming to view MPEG-4 streaming media.

-  Quick Time Player
-  Real Player
-  VLC media player
-  mpegable Player
-  pvPlayer

1. Launch a RTSP player.
2. Choose **File > Open URL**.
3. Type the URL command in the text box and then click **OK**.

URL command = `rtsp://<ip address of your camera>:<rtsp port>/<access name for stream1 or stream2>`

**Note:** Please refer to pages 39-44 for the settings of your RTSP port and stream files.

For example:

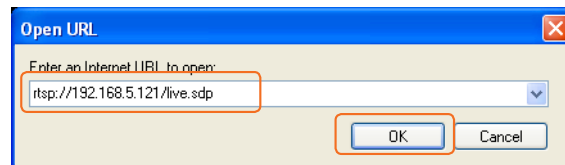

4. You can view the live video in your player, as shown in the figure.



## Using 3GPP Mobile Phones

To view streaming media using mobile phones, make sure the Network Camera is setup on the Internet.

To utilize this feature, please check the Network Settings for your camera.

1. Most of the players on 3GPP mobile phones do not support RTSP authentication, make sure the authentication mode of RTSP streaming is set to **Disable**. For more information, see RTSP Streaming on page 42.
2. The 3G network bandwidth is limited, therefore users cannot use large size videos. Please set the video and audio streaming parameters as listed below. For more information, see **Audio and Video** on page 47.

Video Mode	MPEG-4
Frame size	176 x 144
Maximum frame rate	5 fps
Intra frame period	1S
Video quality (Constant bit rate)	40kbps
Audio type (GSM-AMR)	12.2kbps

3. Set the RTSP port to 554, since most ISPs and players do not support other port numbers.
4. Launch the players on 3GPP mobile phones, (ex. Real Player). Type the URL command in the player.

**URL Command** = rtsp://<public ip address of your camera>:<rtsp port>/<access name for stream1/stream2>

# Camera

This section shows your camera's live video. You can control your settings using the buttons below.

 **Client Settings:** Click this button to access the Client Settings.

 **Snapshot:** Captures a still picture of a video.

 **Logout:** Logout the camera server and close the browser.



 Enable/Disable the digital zoom feature. After selecting this icon, a small pop-up window will appear (see below).

## Disable Digital

**Zoom:** Select this to disable the digital zoom feature.

**Zoom Factors:** Adjust the threshold of the zoom in and zoom out. You can also adjust and position the zoom area by dragging the box in the window.

 Click this icon to hide the window.

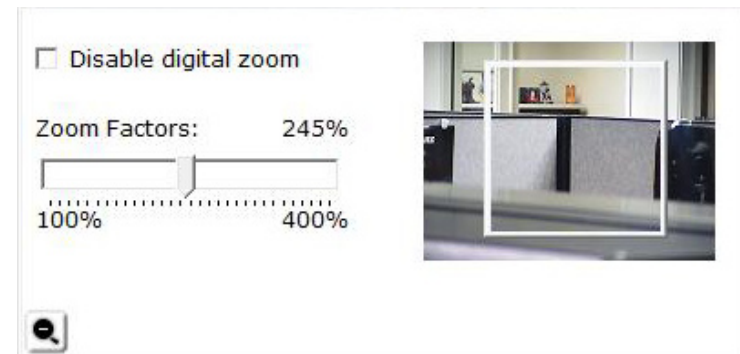

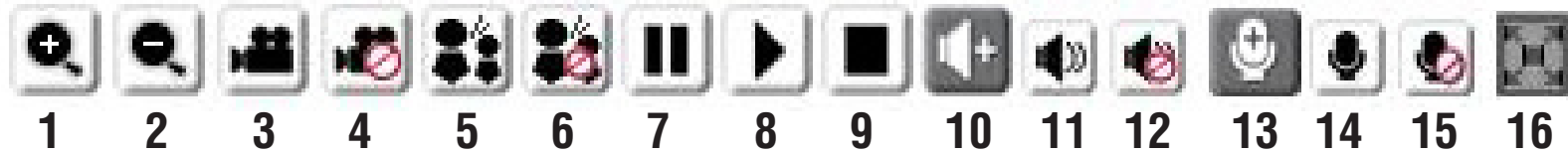

1/2	<b>Digital Zoom</b> - Refer to the previous page for more information.
3/4	<b>Start/Stop Recording</b> - Click to start recording. Video clips will be recorded in MP4 format to your computer. Press the button again (#4) to stop recording. If you close your web browser, the video will stop recording.
5/6	<b>Talk/Stop Talk</b> - Click this button (#5) to talk to people around the Network Camera if there is an external speaker connected to the camera and you have a microphone connected to your computer. Press the icon again (#6) to stop talking or disable this function.
7/8	<b>Resume/Pause</b> - Click this button (#8) to start or resume the transmission of video streaming. Click the button again (#7), the video will pause.
9	<b>Stop</b> - Click to stop the transmission of video streaming. Click the resume button (#8) to begin streaming.
10	<b>Speaker Volume</b> - When the mute function is not active, move the slider bar to adjust the volume of the speakers that are connected to your network camera.
11/12	<b>Speaker Mute/Unmute</b> - Click (#12) to mute the external speaker that is connected to the network camera. Press again (#11) to unmute the speaker.
13	<b>Microphone Level</b> - When the mute function is not active, move the slider bar to adjust the level of the microphone that is connected to your network camera (external or built-in).
14/15	<b>Microphone Mute/Unmute</b> - Click (#15) to turn off the microphone (external or built-in) that is connected to your network camera. Press again (#14) to turn the microphone back on.
16	<b>Full screen:</b> To enlarge the video to full screen.

# Snapshot

After you have clicked **Snapshot** a pop-up window with an image of live video taken by the DCS-3110 will appear.



# Client Setup

To configure the settings for media streaming and recording, please read the following definitions.

**Stream Options:** Select which video stream profile to use.

**Protocol Options:** There are 4 protocols for you to choose for video streaming.

**UDP Protocol:** This is recommended because it is an ideal protocol for transmitting real-time audio and video data, which can tolerate some lost packets.

**UDP Unicast:** Stream to a single computer.

**UDP Multicast:** Stream to multiple computers using multicast streaming.

**TCP:** Provides higher quality video streaming than UDP and provides error correction. However, transmission speed will be reduced.

**HTTP Protocol:** Offers the highest image and video quality. However, packet loss will diminish image quality when bandwidth becomes restricted. If the network is protected by a firewall and it opens HTTP port (80) only, HTTP protocol must be selected. In this mode, audio is disabled and only video can be viewed. UDP connections will not be available to remote users if all four ports have not been forwarded (as shown on page 43). Only the HTTP port must be forwarded for remote users to make an HTTP connection (video only).

**Record Options:** Allows the user to specify a destination folder and prefix filename for the recorded video.

Product Page: DCS-3110 Firmware Version: 1.00

**D-Link**

DCS-3110 // LIVE VIDEO SETUP ADVANCED MAINTENANCE STATUS HELP

Camera  
Snapshot  
Client Setup  
Logout

**CONNECTION TYPE**  
Here you can configure the audio and video settings as well as the type of connection your camera uses when viewing it on a network.  
Save Settings Don't Save Settings

**STREAM OPTIONS**  
 Stream1  
 Stream2

**MEDIA OPTIONS**  
 Video and Audio  
 Video Only  
 Audio Only

**PROTOCOL OPTIONS**  
 UDP unicast  
 UDP multicast  
 TCP  
 HTTP

**RECORD OPTIONS**  
Folder: C:\Record Browse...  
File Name Prefix: CLIP  
 Add date and time suffix to file name  
Save Settings Don't Save Settings

**Helpful Hints..**

**Stream Options** - This camera can send 2 streams simultaneously, it can have different configuration for each stream, you can find stream setup at the Setup/Video and Audio setup page.

**Media Options** -  
• Video and Audio: Stream Video and Audio data at the same time with synchronization.  
• Video only: Stream video data only.  
• Audio only: Stream Audio data only.

**Protocol Options** -  
• UDP Protocol: This allows quality real-time performance for audio and video. Some packets may be lost due to network burst traffic and images may be obscured.  
• TCP Protocol: Packet loss is less likely to occur and video displays are more accurate.

**Record Option** -  
• Folder: Select target record folder. Default folder is C:\Record, if this folder doesn't exist, system will create it when first recording. If this folder is invalid, it will cause recording fail. It can assign a network folder.  
• File name prefix: Add every recorded file with this file name prefix.  
• Add date and time suffix to file name: If checked every file name will

# Setup Wizard

To quickly configure your network camera, click **Internet Connection Setup Wizard** or click **Manual Internet Connection Setup** to manually configure your network camera.

To quickly configure your network camera's motion detection settings, click **Motion Detection Setup Wizard** and skip to page 36. If you want to enter your settings without running the wizard, click **Manual Motion Detection Setup** and skip to page 49.

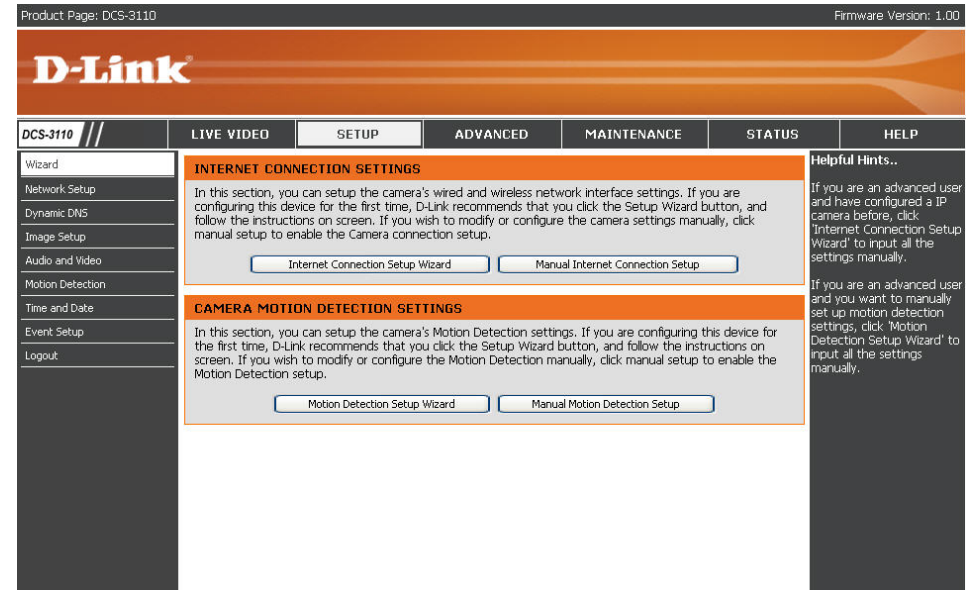

## Internet Connection Setup Wizard

This wizard will guide you through a step-by-step process to configure your new D-Link Camera and connect the camera to the internet. Click **Next** to continue.

### WELCOME TO D-LINK SETUP WIZARD - INTERNET CONNECTION

This wizard will guide you through a step-by-step process to configure your new D-Link Camera and connect the camera to the internet. To set-up your motion detection, please click "Cancel" to close this wizard. Otherwise click "Next" to begin.

- Step 1: Setup LAN Settings
- Step 2: Setup Internet Settings
- Step 3: Setup DDNS Settings
- Step 4: Camera Name Settings
- Step 5: Setup Time Zone

Click **Next**

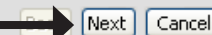

Select **DHCP** if you are unsure which settings to pick. Click **Next** to continue and skip to page 34.

**STEP 1: SETUP LAN SETTINGS**

Please select whether your camera will connect to the Internet with a DHCP connection or Static IP address. If your camera is connected to a router, or you are unsure which settings to pick, D-Link recommends that you keep the default selection of DHCP connection. Otherwise, click on Static IP address to manually assign and IP address before clicking on the Next button.

DHCP  
 PPPoE  
 Static IP Client

IP address   
Subnet mask   
Default Gateway   
Primary DNS   
Secondary DNS

Click **Next**



Select **PPPoE** if the camera is directly connected to the Internet through a DSL modem and your ISP (Internet Service Provider) requires you to use PPPoE for the Internet connection. Click **Next** to continue and skip to Step 2 on page 33.

**STEP 1: SETUP LAN SETTINGS**

Please select whether your camera will connect to the Internet with a DHCP connection or Static IP address. If your camera is connected to a router, or you are unsure which settings to pick, D-Link recommends that you keep the default selection of DHCP connection. Otherwise, click on Static IP address to manually assign and IP address before clicking on the Next button.

DHCP  
 PPPoE  
 Static IP Client

IP address   
Subnet mask   
Default Gateway   
Primary DNS   
Secondary DNS

Click **Next**





Select **Static IP** if your Internet Service Provider has provided you with connection settings, or you wish to set a static address within your home network. Click **Next** to continue.

**STEP 1: SETUP LAN SETTINGS**

Please select whether your camera will connect to the Internet with a DHCP connection or Static IP address. If your camera is connected to a router, or you are unsure which settings to pick, D-Link recommends that you keep the default selection of DHCP connection. Otherwise, click on Static IP address to manually assign and IP address before clicking on the Next button.

DHCP  
 PPPoE  
 Static IP Client

IP address	<input type="text" value="192.168.0.100"/>
Subnet mask	<input type="text" value="255.255.255.0"/>
Default Gateway	<input type="text" value="192.168.0.1"/>
Primary DNS	<input type="text" value="192.168.0.1"/>
Secondary DNS	<input type="text"/>

Click Next



If you have selected PPPoE, enter your username and password. Click **Next** to continue.

**STEP 2: SETUP INTERNET SETTINGS**

Please enter your ISP Username and Password. This will be the case if your ISP uses PPPoE. Contact your ISP if you are unsure.

User name	<input type="text"/>
Password	<input type="text"/>
Confirm password	<input type="text"/>

Click Next



If you have a Dynamic DNS account and would like the camera to update your IP address automatically, enable DDNS and enter your host information. Click **Next** to continue.

**STEP 3: SETUP DDNS SETTINGS**

If you have a Dynamic DNS account and would like the camera to update your IP address automatically, enable DDNS and enter in your host information below. Please click on the Next button to continue.

Enable DDNS

Server name

Host name

User name

Password

Confirm password

Click **Next**

Enter a name for your camera and click **Next** to continue.

**STEP 4: SERVER NAME SETTINGS**

D-Link recommends that you rename your camera for easy accessibility. You can then identify and connect your camera via this name. Please click on Next button.

Camera Name

Click **Next**

Configure the correct time to ensure that all events will be triggered, captured, and scheduled at the right time. Click **Next** to continue.

**STEP 5: SETUP TIME ZONE**

Please configure the correct time to ensure that all events triggered, captured and scheduled at the correct time and day and then click on the Next button.

Current Time 07 Jan 2008 01:35:53

Time Zone

Enable Daylight Saving

Daylight Saving Dates	Month	Week	Day of Week	Time
DST Start	<input type="text" value="Oct"/>	<input type="text" value="2nd"/>	<input type="text" value="Sun"/>	<input type="text" value="1 am"/>
DST End	<input type="text" value="Mar"/>	<input type="text" value="1st"/>	<input type="text" value="Sat"/>	<input type="text" value="1 am"/>

Click **Next**

Once you have selected **Dynamic**, **PPPoE**, or **Static**, you will see a summary of your camera's settings. Click **Apply** to save and activate your settings.

Click **Apply**



**STEP 6: SETUP COMPLETE**

Below you should see a summary of your camera settings. Click back to review or modify settings. Click Restart to apply the settings below. Please note these settings as you will require this information when accessing your camera on the network or via your web browser.

IP address:	PPPoE
Camera Name:	DCS-3110
Time Zone:	-8
DDNS:	OFF
PPPoE:	ON

## Motion Detection Setup Wizard

This wizard will guide you through a step-by-step process to configure your new D-Link Camera's motion detection functions. Click **Next** to continue.

### WELCOME TO D-LINK SETUP WIZARD - MOTION DETECTION

This wizard will guide you through a step-by-step process to configure your camera's motion detection functions. To setup the internet connection settings, please click "Cancel" to close this wizard. Otherwise click "Next" to begin.

- Step 1: Specify motion detection Area Settings
- Step 2: Motion Detection Schedule
- Step 3: Alerts and Notifications

Click **Next**

Next Cancel

This section will allow you to enable or disable motion detection as well as control the sensitivity of your camera's ability to detect movement. Specify the window area, window name, and sensitivity of detection as well as the type of recording (either snapshot or video clip). Click **Next** to continue.

### STEP 1: SPECIFY MOTION DETECTION AREA SETTINGS

This section will allow you to enable or disable motion detection as well as control the sensitivity of your camera's ability to detect movement. Please specify the window area, window name and sensitivity of detection before clicking on the Next button.

Enable motion detection  Snapshot  Video Clip

DCS-3110(UDP-AV) 2000/01/08 21:05:04



Window Name:  
desktop1

Sensitivity:  
90%

Percentage:  
10%

New Save

Back Next Cancel

Click **Next**

This section will allow you to specify the time and date your camera records motion.

**Note:** Recording camera footage will take up space on your hard drive. Its recommended that you have sufficient disk space for **Always** function.

Click **Next**

**STEP 2: MOTION DETECTION SCHEDULE**

This section allows you to specify the time and dates that your camera records motion. Please note that recorded camera footage will take up space on your hard drive. It is therefore recommended that you have sufficient disk space for 'Always' function.

Sun
  Mon
  Tue
  Wed
  Thu
  Fri
  Sat

**Time**
 Always
   
 From  to  to

This step allows you to specify how you will receive the events notification of your camera, either via using email or FTP. You will need to enter all the relevant information for your email account or FTP settings. Click **Next** to continue.

Click **Next**

**STEP 3: ALERTS AND NOTIFICATION**

This final step allows you to specify how you receive notification of camera events. Choose between an email notification or alternatively you can setup an FTP Notification. You will need your email account settings or FTP details. If you are unsure of this information, please contact your ISP. Once you have entered this information, please click on the Next button.

Do not notify me
   
 Notify me by E-mail
   
     User name 
  
     Password 
  
     SMTP(mail) Server 
  
     Return E-mail Address 
  
     Recipient email address 
  
 Notify me by FTP
   
     User name 
  
     Password 
  
     Server address 
  
     Remote folder name 
  
     Server port 
  
     Passive mode

You have completed the Motion Detection Wizard. Click **Apply** to save your settings.

**STEP 4: SETUP COMPLETE**

You have completed your camera setup. Please click the Back button if you want to review or modify your settings or click on the Apply button to save and apply your settings.

Motion Detection:	Disable
Event:	Take Snapshot
Schedule Day:	Sun, Mon, Tue, Wed, Thu, Fri, Sat
Schedule Time:	Always
Alerts and Notification:	Do not notify me

Click **Apply**



# Network Setup

**LAN Settings:** Settings for your local area network.

**DHCP:** Select this connection if you have a DHCP server running on your network and would like a dynamic IP address to be assigned to your camera automatically.

**Static IP Client:** You may enter a static or fixed IP address for your camera.

**IP Address:** Enter an IP address.

**Subnet Mask:** The default value is “255.255.255.0.” Used to determine if the destination is in the same subnet.

**Default Gateway:** The gateway used to forward frames to destinations in a different subnet. Invalid gateway settings may cause the failure of transmissions to a different subnet. Usually the IP address of your router.

**Primary DNS:** Primary domain name server that translates names to IP addresses.

**Secondary DNS:** Secondary domain name server to backup the primary one.

**Enable UPnP Presentation:** Allows a user to find, view, and control this camera via a presentation page or “Network Neighborhood” without configuration.

## How does UPnP work?

UPnP™ networking technology provides automatic IP configuration and dynamic discovery of devices added to a network. Services and capabilities offered by networked devices, such as printing and file sharing, are available among each other without bothersome network configuration. In the case of Network Cameras, you will see Network Camera shortcuts at My Network Places.

Product Page: DCS-3110 Firmware Version: 1.00

**D-Link**

DCS-3110 // LIVE VIDEO SETUP ADVANCED MAINTENANCE STATUS HELP

Wizard  
Network Setup  
Dynamic DNS  
Image Setup  
Audio and Video  
Motion Detection  
Time and Date  
Event Setup  
Logout

**NETWORK SETUP**  
You can configure your LAN and internet settings from here.  
Save Settings Don't Save Settings

**LAN SETTINGS**

DHCP  
 Static IP Client

IP address: 172.17.0.40  
Subnet mask: 255.255.255.0  
Default router: 172.17.0.254  
Primary DNS: 192.168.168.210  
Secondary DNS: 192.168.168.250

Enable UPnP presentation  
 Enable UPnP forwarding

**PPPOE SETTINGS**

Enable  Disable

User name: \_\_\_\_\_  
Password: \_\_\_\_\_  
Confirm password: \_\_\_\_\_  
Connect Status: none

**HTTP**

Authentication: basic  
HTTP port: 80  
Secondary HTTP port: 8080  
Access name for stream1: video.mjpg  
Access name for stream2: video2.mjpg

**FTP**

FTP port: 21

**RTSP STREAMING**

Authentication: disable  
Access name for stream1: live.mpeg  
Access name for stream2: live2.mpeg  
RTSP port: 554  
RTP port for video: 5556  
RTCP port for video: 5557  
RTP port for audio: 5558  
RTCP port for audio: 5559

Enable multicast for stream 1  
Multicast group address: 239.128.1.99  
Multicast video port: 5560  
Multicast RTCP video port: 5561  
Multicast audio port: 5562  
Multicast RTCP audio port: 5563  
Multicast TTL[1-255]: 15

Enable multicast for stream 2  
Multicast group address: 239.128.1.100  
Multicast video port: 5564  
Multicast RTCP video port: 5565  
Multicast audio port: 5566  
Multicast RTCP audio port: 5567  
Multicast TTL[1-255]: 15

**TWO WAY AUDIO**

Two way audio port: 5060

Save Settings Don't Save Settings

**SECURITY**

Copyright © 2008 D-Link Corporation/D-Link Systems, Inc. All rights reserved.

Enabling UPnP port forwarding allows the Network Camera to open a secondary HTTP port on the router. You have to add the secondary HTTP port number behind the Network Camera's public address in order to access the Network Camera from the Internet. For example, when the HTTP port is set to 80 and the secondary HTTP port is set to 8080, refer to the list below for the Network Camera's IP address.

From the Internet	In a local area network
http://203.67.124.123:8080	http://192.168.4.160 or http://192.168.4.160:8080

If the PPPoE settings are incorrectly configured or the Internet access is not working, restore the Network Camera to factory default settings.

**Enable UPnP Port Forwarding:** Enables the camera to add the port forwarding entry into the router automatically when this option is enabled.

**PPPoE Settings:** Enable this setting if your ISP (DSL service) is using PPPoE. You may already have both **Username** and **Password** given by your ISP, or you may check with your ISP. The **Connect Status** will be determined automatically by the system.

**HTTP:** You may configure two HTTP ports for your camera. HTTP ports allow you to connect to the camera via a standard web browser. These ports can be set to a number other than the default TCP ports 80 and 8080. A corresponding port must be opened on the router. For example, if the port is changed to 1010, users must type in the web browser "http://192.168.0.100:1010" instead of "http://192.168.0.100".

**Authentication:** Choose either **Basic** where the password is not encrypted, or **Digest** where the password is encrypted during the transmission to the web server.

**Note:** *Ensure to restart your browser, if you select **Digest** mode.*

**Basic authentication:** When selected, the password is sent in plain text format; there can be potential risks of being intercepted.

**Digest authentication:** When selected, user credentials are encrypted in MD5 algorithm and thus provide better protection against unauthorized accesses.

**HTTP Port:** The default value is 80.



**Secondary HTTP** The default value is 8080.

**Port:** After you have enabled the **Authentication**, you will need to configure and use the access name to access your video file. For example, **http://camera ip/video.mjpg** (video.mjpg is the **Access name**, you can modify it here)

**Access name for stream1:** The default name is video.mjpg.

**Access name for stream2:** The default name is video2.mjpg.

**Access name for stream 1 / Access name for stream 2 :** The access name is used to differentiate the streaming source. When using Mozilla Firefox or Netscape to access the Network Camera, and the video mode is set to JPEG, users will receive continuous JPEG pictures. This technology, known as "server push", allows the Network Camera to feed live pictures to Mozilla Firefox and Netscape. Use the following command to obtain the JPEG file:

http://<ip address>:<http port>/<access name for stream1 or stream2>

For example, when the access name for stream 1 is set to video.mjpg:

1. Launch Mozilla Firefox or Netscape
2. Type the URL command in the address field. Press Enter.
3. The JPEG image will be displayed in your web browser.

**FTP Port:** Default port is 21. If you want to change the port number, you will need to specify the port when connecting to the FTP server. For example, **FTP://68.5.1.81:60** (if you use port 60 for your FTP server)

**RTSP Streaming:** This setting enables you to connect to a camera by using streaming mobile device(s), such as a mobile phone or PDA.

**Authentication:** Select either **Basic** where the password is not encrypted, or **Digest** where the password is encrypted during the transmission to the web server. After you have enabled the **Authentication**, you will need to configure and use the access name to access your video file. **RTSP://camera ip/live.sdp** (live.sdp is the default access name, you can modify it here)

**Access name for stream1:** The default name is live.sdp.

**Access name for stream2:** The default name is live2.sdp.

The accessibility of the RTSP streaming for the three authentication modes are listed in the following table.

	Quick Time player	Real Player	VLC media player	mpegable Player	pvPlayer
<b>Disable</b>	O	O	O	O	O
<b>Basic</b>	O	O	X	X	X
<b>Digest</b>	O	X	X	X	X

O indicates that the authentication mode is supported by the RTSP player.

X indicates that the authentication mode is NOT supported by the RTSP player.

**Access name for stream 1 / Access name for stream 2** : The access name is used to differentiate the streaming source. When using a RTSP player to access the Network Camera, and the video mode is set to MPEG-4, use the following RTSP URL command to request a transmission of streaming data.

rtsp://<ip address>:<rtsp port>/<access name for stream1 or stream2>

For example, when the access name for stream 1 is set to live.sdp:

- 1 : Launch a RTSP player.
- 2 : Choose **File** > **Open URL**. This opens the URL dialog box.
- 3 : Type the URL command in the text box.

For example:

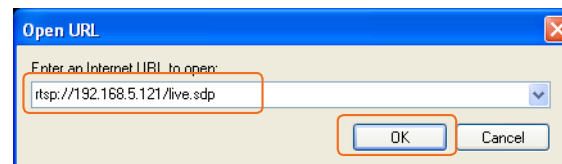

- 4 : The live video will be displayed in your player.



**RTSP port:**

The port number that you use for RSTP streaming, the default port number is 554. **RTP** (Real Time Protocol) **Port** is used to streaming audio and video while **RTCP** (Real Time Control Protocol) port is used to monitor QoS of RTP stream.

***Note:** RTP video port and RTP audio port must be an “even” number. The numbers of RTCP video port and RTCP audio port must equal to the numbers of RTP video port and RTP audio port, plus one repetitively.*

**RTP port for video:**

Default port number is 5556.

**RTCP port for video:**

Default port number is 5557.

**Multicast group address:**

You may choose to enable multicast for your camera audio and video streaming so that your **cameras (sources)** and the **receivers (clients)** can establish the connection to send and receive contents.

An IP Multicast group address is used to send and receive content. Sources use this group address as the destination address while sending their data packets. Receivers use this group address to inform the network that they are interested in receiving packets sent to that group.

For example, if some content is associated with group 239.1.1.1, the source will send data packets destined to 239.1.1.1. Receivers for that content will inform the network that they are interested in receiving data packets sent to the group 239.1.1.1. The receiver “joins” 239.1.1.1. The Multicast address ranges from 224.0.0.0 to 239.255.255.255, or, equivalently, 224.0.0.0/4

#### **Multicast video**

**port:** Default port number is 5560, or please choose between 1024 and 65534.

#### **Multicast RTCP**

**video port:** Default port number is 5561, or please choose between 1024 and 65534.

#### **Multicast RTCP**

**audio port:** Default port number is 5563, or please choose between 1024 and 65534.

#### **Multicast TTL**

**{1~255}:** Set a Time to Live(TTL) value for multicast packet, please choose between 1 and 255.

#### **Two way**

**audio port:** The two way audio port in DSC-3415 is set to 5060, by default. It can also be assigned to another port number between 1025 and 65535. This Network Camera supports two way audio communication so that operators can transmit and receive audio simultaneously. By using the camera’s built-in microphone and an external speaker, users can communicate with people present around the Network Camera.

**Note:** *Since JPEG only transmits a series of JPEG images to the client, to utilize this feature, make sure the video mode is set to MPEG-4 and the media option is set to Video and Audio.*

Unicast video transmission delivers a stream through point-to-point transmission. On the other hand, multicast video transmission sends a stream to the multicast group address and allows multiple clients to acquire the stream by requesting a copy from the Multicast group address.

The five ports can be changed between 1025 and 65535. The multicast RTP port must be an even number and the multicast RTCP port is multicast RTP port number plus one, and thus always be odd. When the multicast RTP port changes, the multicast RTCP port will change accordingly.

# Dynamic DNS

DDNS (Dynamic Domain Name Server) will hold a DNS host name and synchronize the public IP address of the modem when it has been modified. The username and password are required when using the DDNS service.

**Enable DDNS:** Click to enable the DDNS function.

**Server Name:** Select your Dynamic DNS provider from the drop down menu.

**Host Name:** Enter the host name of the DDNS server.

**Username:** Enter your username or e-mail used to connect to the DDNS

**Password:** Enter your password used to connect to the DDNS server.

**Status:** Displays the current connection status.

The screenshot shows the D-Link DCS-3110 web interface. At the top, it displays 'Product Page: DCS-3110' and 'Firmware Version: 1.00'. The D-Link logo is prominently featured. Below the logo is a navigation bar with tabs for 'LIVE VIDEO', 'SETUP', 'ADVANCED', 'MAINTENANCE', 'STATUS', and 'HELP'. The 'SETUP' tab is selected, and a sidebar on the left lists various setup options: Wizard, Network Setup, Dynamic DNS (selected), Image Setup, Audio and Video, Motion Detection, Time and Date, Event Setup, and Logout. The main content area is titled 'DDNS' and contains the following text: 'The Dynamic DNS feature allows you to host a server (Web, FTP, Game Server, etc...) using a domain name that you have purchased (http://www.whateveryournameis.com) with your dynamically assigned IP address. Most broadband Internet Service Providers assign dynamic (changing) IP addresses. Using a DDNS service provider, your friends can enter your host name to connect to your game server no matter what your IP address is.' Below this text is a link to 'Sign up for D-Link's Free DDNS service at: www.DLinkDDNS.com' and two buttons: 'Save Settings' and 'Don't Save Settings'. The 'DDNS SETTING' section includes a checked 'Enable DDNS' checkbox, a 'Server name' dropdown menu set to 'www.dlinkddns.com(Free)', and input fields for 'Host name' (myipcam), 'User name' (yourname), 'Password' (masked with dots), and 'Confirm password' (masked with dots). The 'Status' field is set to 'none'. At the bottom of the settings section are 'Save Settings' and 'Don't Save Settings' buttons. A 'Helpful Hints...' section on the right explains that Dynamic DNS is useful for DSL or Cable service providers that change the modem IP address periodically, allowing a website domain name to be used for camera connections instead of an IP address.

# Image Setup

You may configure the color, brightness, and orientation settings of the video image. Preview of the image will be shown in the window of Live Video. Click **Save Settings** to save your changes.

**Color:** Select either for **Color** or **B/W (black and white, monochrome)** video display.

**Power line frequency:** Select either 50 or 60Hz.

**Video Flip** will vertically rotate the video while **Mirror** will horizontally rotate the video. You may check both options if the camera is being installed upside down.

**White balance:** Choose either **Auto** or **Fix**.

**Brightness:** Select the brightness level ranged from -5 to +5.

**Overlay title and time stamp on video:** Select to add a date and time stamp on the video.

The screenshot displays the D-Link DCS-3110 web interface. At the top, it shows 'Product Page: DCS-3110' and 'Firmware Version: 1.00'. The main navigation bar includes 'LIVE VIDEO', 'SETUP', 'ADVANCED', 'MAINTENANCE', 'STATUS', and 'HELP'. The 'SETUP' menu is expanded to show 'Image Setup' selected. The 'IMAGE SETUP' section contains a note: 'Note: If parameters are changed without saving, they will be effective until the next system power up.' Below this are 'Save Settings' and 'Don't Save Settings' buttons. The 'LIVE VIDEO' section shows a video preview of a desk with a laptop, a globe, and a monitor. The 'IMAGE SETTINGS' panel includes the following options:

- Color: Color (dropdown)
- Power line frequency: 60 Hz (dropdown)
- Video orientation:  Flip,  Mirror
- White balance: Auto (dropdown)
- Brightness: +0 (dropdown)
- Overlay title and time stamp on video:

At the bottom of the settings panel are 'Save Settings' and 'Don't Save Settings' buttons. A 'Helpful Hints..' section on the right provides additional information: 'Brightness field has eleven levels ranged from -5 to +5.', 'Flip image - This will flip the image vertically.', and 'Mirror - This will flip the image horizontally in such a way that your left side will be on the left side of the screen and vice versa.'

## Audio and Video

Settings for two video streams (stream 1 and stream 2) can be configured here. You may configure one setting for computer display and the other one for mobile display.

**Mode:** Select either **JPEG** or **MPEG4**. In JPEG mode, the video frames are independent. However, MPEG4 consumes much less network bandwidth than JPEG.

**Frame Size:** Select **176x144**, **352x240**, or **640x480**. It is recommended using 176x144 for mobile viewing and 640x480 for computer viewing.

**Maximum frame rate:** 1 is the minimum value while 30 is the maximum value. It is recommended choosing 30 for computer viewing and 5 for mobile viewing.

**Video quality:** This limits the maximum refresh frame rate, which can be combined with the “**Fixed quality**” to optimize the bandwidth utilization and video quality. If the User wants to fix the bandwidth utilization regardless of the video quality, choose “**Constant bit rate**” and select the desired bandwidth.

**Mute:** Select this to mute audio.

**Internal microphone input gain:** Select an internal microphone input gain from the drop-down list.

It is necessary to find the optimum gain that transmits the best audio for listening.

**Note:** “dB” stands for decibels, a logarithmic unit of measurement in acoustics . The higher the decibel number, the louder the sound.

The screenshot shows the D-Link DCS-3110 web interface. The top navigation bar includes 'LIVE VIDEO', 'SETUP', 'ADVANCED', 'MAINTENANCE', 'STATUS', and 'HELP'. The 'SETUP' tab is selected, and the 'AUDIO AND VIDEO' configuration page is displayed. The page is titled 'AUDIO AND VIDEO' and contains the following sections:

- VIDEO QUALITY SETTINGS FOR STREAM1:**
  - Mode: MPEG-4
  - Frame size: 640x480
  - Maximum frame rate: 8 fps
  - Video quality:
    - Constant bit rate (512 Kbps)
    - Fixed quality (Good)
- VIDEO QUALITY SETTINGS FOR STREAM2:**
  - Mode: MPEG-4
  - Frame size: 176x144
  - Maximum frame rate: 5 fps
  - Video quality:
    - Constant bit rate (40 kbps)
    - Fixed quality (Good)
- AUDIO SETTINGS:**
  - Use: Internal
  - Mute
  - Internal microphone input gain: -10.5 dB
  - External microphone input:  0db  20db
  - Audio type:  AAC  GSM-AMR
  - AAC bit rate: 128 Kbps
  - GSM-AMR bit rate: 12.2 Kbps

Helpful Hints... Higher frame size, frame rate and bit rate rate gives better video quality. At the same time, it requires more network bandwidth. For best viewing results on a mobile phone, we suggest setting the Frame Rate to 5fps and the Bit Rate to 20 kbps. Higher audio bit rate gives better sound quality. At the same time, it requires more network bandwidth.

**External microphone input:** Select the external microphone input gain from the list.

**Audio type:** AAC (Advanced Audio Coding): A wide band audio coding algorithm that exploits two primary coding strategies to dramatically reduce the amount of data needed to convey high-quality digital audio. Select a higher bit rate number for better audio quality.

**GSM-AMR:** A standard adapted audio codec by the 3GPP video (3rd Generation Partnership Project). It is an Adaptive Multi Rate-Narrow Band (AMRNB) speech codec. Select a higher bit rate number for better audio quality.

**AAC bit rate:** Select an AAC bit rate from the list. Higher bit rate means higher audio quality but it takes more network bandwidth to transmit.

**GSM-AMR bit rate:** Select the GSM-AMR bit rate from the list. Higher bit rate means higher audio quality but it takes more network bandwidth to transmit.



# Motion Detection

Enabling Motion Detection will allow up to three windows that can be created with different settings for monitoring. This allows your camera to serve as a security device that will record when motion is detected.

**Enable motion detection:** Check this option to turn on the motion detection feature.

**Window name:** Create your own name for the monitored area/window. It will show at the top of the motion window.

**Sensitivity:** Set the measurable difference between two sequential images that would indicate motion.

**Percentage:** Set the amount of motion in the window being monitored that is required to initiate a motion detected alert. If this is set to 100%, this means that motion must be detected within the whole window to trigger a snapshot.

**Note:** Setting a higher sensitivity and a lower percentage will make motion easier to be detected.

**New:** Click to add a new window. A maximum of three motion windows can be opened simultaneously. Use your mouse to drag the window frame to re-size or the title bar to move. Clicking on the 'x' at the upper right corner of the window will close the window.

**Save:** Save the related settings of that window.

Product Page: DCS-3110 Firmware Version: 1.00

**D-Link**

DCS-3110 // LIVE VIDEO SETUP ADVANCED MAINTENANCE STATUS HELP

Wizard  
Network Setup  
Dynamic DNS  
Image Setup  
Audio and Video  
Motion Detection  
Time and Date  
Event Setup  
Logout

**MOTION DETECTION**

In order to use motion detection you must first check the Enable Motion Detection checkbox. A maximum of 3 windows can be created each with their own separate Sensitivity ranges.

**MOTION SETTINGS**

Enable motion detection

DCS-3110(UDP-AV) 2008/05/02 13:50:13

Window Name: desktop1

Sensitivity: 90%

Percentage: 10%

New Save

**Helpful Hints..**

**Sensitivity** - Sets the sensitivity for motion detection. Red bars on the Sensitivity Bar indicate the level of sensitivity for motion detection. As motion is detected the level will rise depending on the frequency of the movement.

**Percentage** - Adjusting the percentage allows you to set a requirement on how much of the motion window must be filled by movement. Example: If you set this to 50%, then the selected window must be half filled by a moving object before it triggers motion detection.

To enable motion detection, follow the steps below:

1. Click **New** to add a new motion detection window.
2. Enter a name in the **Window Name** field.
3. Define the sensitivity to moving objects and the space ratio of all alerted pixels by moving the **Sensitivity** and **Percentage** slide bar.
4. Click **Save** to apply the changes.
5. Select **Enable motion detection** to activate motion detection.

**Note:** Drag to resize the window and click X to close the window.

The Percentage Indicator will rise or fall depending on the image variation. When motions are detected by the Network Camera and are judged to exceed the defined threshold, a red bar rises. Meanwhile, the motion detection window will be outlined in red. Utilizing this device as a trigger source, photos or videos can be captured instantly and sent to the remote server (Email, FTP).

A green bar indicates that even though motions are detected, the event will not be triggered because the image variations are still falling under the defined threshold.

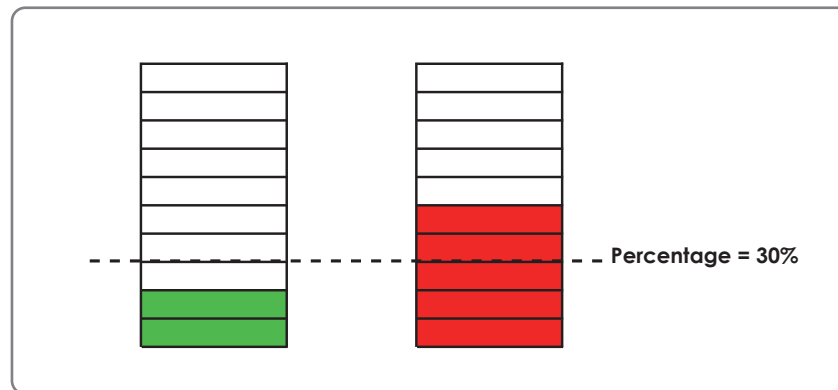

## How does motion detection work?

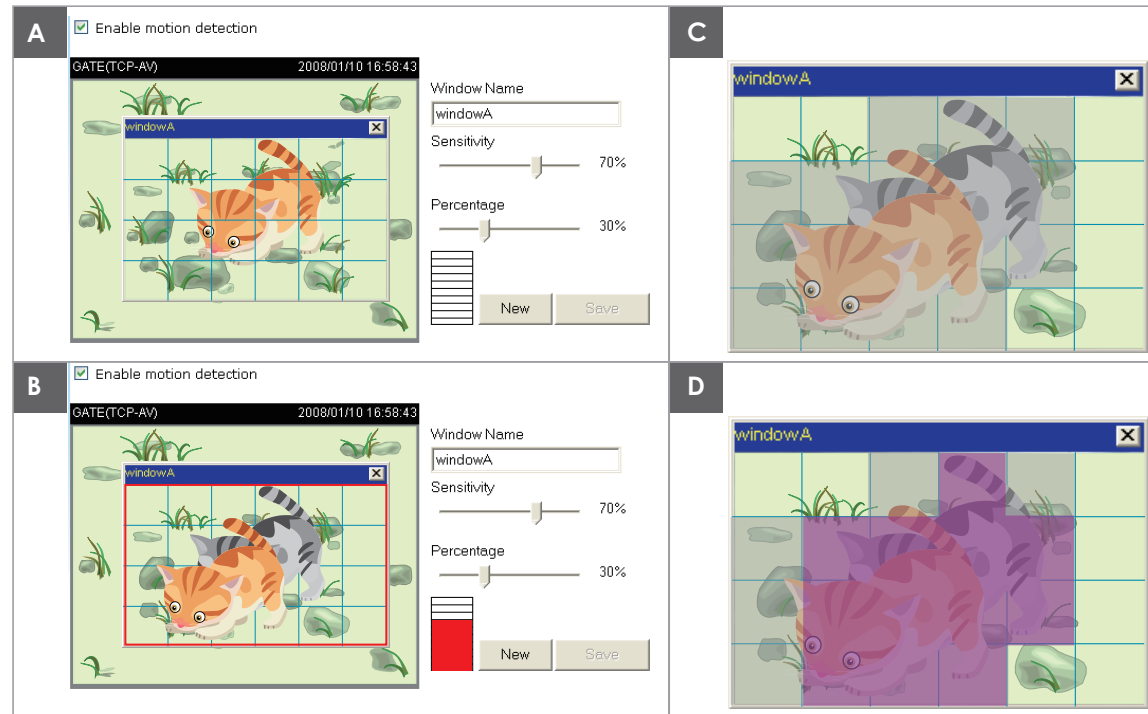

There are two parameters for setting the motion detection: **Sensitivity** and **Percentage**. In the illustration above, frame A and frame B are two sequential images. Pixel differences between the two frames are detected and highlighted in gray (frame C), and will be compared with the sensitivity setting. Sensitivity is a value that expresses the sensitivity to moving objects. Higher sensitivity settings are expected to sense a slight movement while smaller sensitivity settings tend to neglect it. When the sensitivity is set to 70%, the Network Camera defines the pixels in the purple areas as “alerted pixels” (frame D). Percentage is a value that expresses the proportion of “alerted pixels” to all pixels in the motion detection window. In this case, 50% of pixels are identified as “alerted pixels”. When the percentage is set to 30%, the motions are judged to exceed the defined threshold; therefore, the motion window will be outlined in red.

For applications that require higher security management, it is suggested to set higher sensitivity settings and smaller percentage values.

# Time and Date

Automatically or manually configure, update, and maintain the internal system clock for your camera.

**Current Server Time:** Displays current time.

**Time Zone:** Select your time zone from the drop-down menu.

**Enable Daylight Saving:** Select this to enable the daylight saving time (DST). During DST, the system clock moves one hour ahead.



**Note:** To utilize this feature, ensure to set the time zone of your network camera. Then starting and ending time of the DST is displayed upon selecting the option.

**Daylight Saving Dates:** You may configure the daylight saving date and time.

**Automatic Time Configuration:** Enable this feature to obtain time configuration automatically from NTP server.

**NTP Server:** Network Time Protocol (NTP) synchronizes the DCS-3110 with an Internet time server. Choose the one that is closest to your location.

**Update Interval:** The time interval for updating the time information from NTP server.

**Set the date and time manually:** This option allows you to set the time and date manually.

**Copy Your Computer's Time Settings:** This will synchronize the time information from your PC.

Product Page: DCS-3110 Firmware Version: 1.00

**D-Link**

DCS-3110 // LIVE VIDEO SETUP ADVANCED MAINTENANCE STATUS HELP

Wizard  
Network Setup  
Dynamic DNS  
Image Setup  
Audio and Video  
Motion Detection  
Time and Date  
Event Setup  
Logout

**TIME AND DATE**

The Time Configuration option allows you to configure, update, and maintain the correct time on the internal system clock. From this section you can set the time zone that you are in and set the NTP (Network Time Protocol) Server. Daylight Saving can also be configured to automatically adjust the time when needed.

Save Settings Don't Save Settings

**TIME CONFIGURATION**

Current Server Time: 02 May 2008 13:48:38  
Time Zone: GMT-08:00 Las Vegas, San Francisco, Vancouver  
Enable Daylight Saving:   
Daylight Saving Dates:  
DST Start: Jan 1st Tue 12 am  
DST End: Jan 1st Tue 12 am

**AUTOMATIC TIME CONFIGURATION**

Enable  Disable  
NTP server: << Select NTP Server >>  
Update interval: One hour

**SET THE DATE AND TIME MANUALLY**

Year: 2008 Month: 05 Day: 02  
Hour: 13 Minute: 48 Second: 38  
Copy Your Computer's Time Settings

Save Settings Don't Save Settings

**SECURITY**

Copyright © 2008 D-Link Corporation/D-Link Systems, Inc. All rights reserved.

Helpful Hints..  
Good timekeeping is important for accurate logs and scheduled firewall rules.

# Event Setup

There are four sections in **Event Setup** page.

- Event
- Server
- Media
- Recording

1. To add a new item - event, server or media click **Add**. A pop-up will appear and update the fields accordingly.
2. To delete the selected item from the pull-down menu of event, server or media click **Delete**.
3. Click on the item name to pop up a window for modifying.

**Note:** You can add up to four events, five servers and five media fields.

Product Page: DCS-3110 Firmware Version: 1.00

**D-Link**

DCS-3110 // LIVE VIDEO SETUP ADVANCED MAINTENANCE STATUS HELP

Wizard  
Network Setup  
Dynamic DNS  
Image Setup  
Audio and Video  
Motion Detection  
Time and Date  
Event Setup  
Logout

**EVENT SETUP**  
There are four sections in Event Setup page. They are event, server, media and recording. Click Add to pop a window to add a new item of event, server, media or recording. Click Delete to delete the selected item from event, server, media or recording. Click on the item name to pop a window to edit it. There can be at most three events and two recording. There can be at most five server and five media configurations.

**SERVER**

Name	Type	Address/Location
<a href="#">myftp</a>	ftp	ftp.yourip.com

Add [v] Delete

**MEDIA**

Media freespace: 4800KB

Name	Type
<a href="#">sendvideo</a>	videoclip

Add [v] Delete

**EVENT**

Name	Status	Sun	Mon	Tue	Wed	Thu	Fri	Sat	Time	Trigger
<a href="#">event1</a>	ON	V	V	V	V	V	V	V	00:00~24:00	motion

Add event1 [v] Delete

**RECORDING**

Name	Status	Sun	Mon	Tue	Wed	Thu	Fri	Sat	Time	Source	Destination
<a href="#">myrec1</a>	ON	V	V	V	V	V	V	V	00:00~24:00	stream1	CF

Add myrec1 [v] Delete

**Helpful Hints..**  
Suggest setting server and media first before setting event. The servers and media which selected in event list are not be able to modify or delete. Please remove them first from the event if you want to delete or modify them. Recommend using different media in different event to make use all media be produced and received correctly. If using the same media in different events and the events trigger almost simultaneously, the servers in the second triggered event will not receive any media; there would be only notifications.

## Application

A typical application is that when motion is detected, the DCS-3110 Network Camera sends images to a FTP server or via e-mail as notifications. For example, as seen in the illustration below, an event can be triggered by many sources, such as motion detection or external digital input devices. When an event is triggered, you can specify what kind of action will be performed. You can configure the Network Camera to send snapshots or videos to your email address or FTP site.

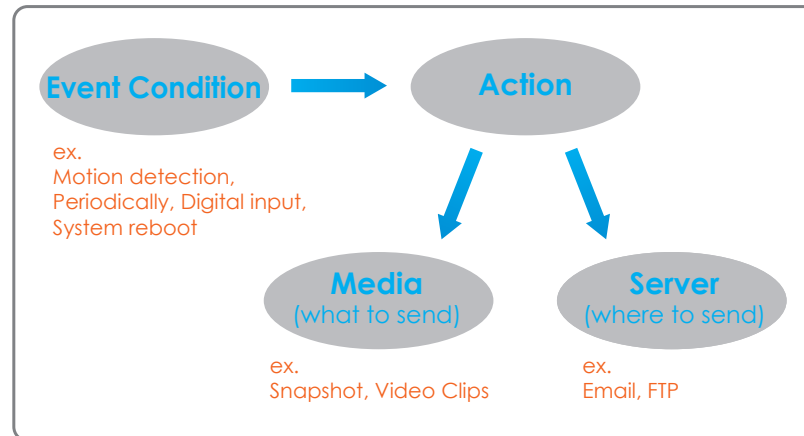

To start plotting an event, it is suggested to configure server and media columns first so that the Network Camera will know what action shall be performed when a trigger is activated.

## Add Server

Configure up to 5 servers to store the media.

**Server Name:** Unique name of your server.

**Email:** Select this to enable and apply your email account setting for your camera.

**FTP:** Select this to access a granted folder on the external FTP server.

**HTTP:** Select this to use a web server to store the media.

**Network Storage:** Only one network storage device is supported.

Product Page: DCS-3110 Firmware Version: 1.00

**D-Link**

DCS-3110 // LIVE VIDEO SETUP ADVANCED MAINTENANCE STATUS HELP

Wizard  
 Network Setup  
 Dynamic DNS  
 Image Setup  
 Audio and Video  
 Motion Detection  
 Time and Date  
 Event Setup  
 Logout

**SERVER**  
 You can set at most 5 different servers here for different event.  
 Test Save Settings Don't Save Settings

**SERVER TYPE**

Server name: myftp

Email

Sender email address: myname@myip.com  
 Recipient email address: yourname@yourip.com  
 Server address: myip.com  
 User name: yourname  
 Password: .....

FTP

Server address: ftp.yourip.com  
 Server port: 21  
 User name: yourname  
 Password: .....

Remote folder name: ipcam  
 Passive mode

HTTP

URL: http://www.yourip.com  
 User name: yourname  
 Password: .....

Network storage

Network storage location: \\thenas\dsk1\volumn\_1  
 (for example: \\my\_nas\disk\folder)  
 Workgroup: yourname  
 User name: yourname  
 Password: .....

Primary WINS server: .....

Test Save Settings Don't Save Settings

**Helpful Hints..**

**"Server name"** The unique name for server. There are four kinds of servers supported. They are email server, FTP server, HTTP server and network storage.

**Email server:**  
**"Sender email address"** The email address of the sender.  
**"Recipient email address"** The email address of the recipient.

**FTP server:**  
**"Remote folder name"** Granted folder on the external FTP server. The string must conform to that of the external FTP server. Some FTP servers cannot accept preceding slash symbol before the path without virtual path mapping. Refer to the instructions for the external FTP server for details. The folder privilege must be open for upload.  
**"Passive Mode"** Check it to enable passive mode in transmission.

**HTTP server:**  
**"URL"** The URL to upload the media.

**Network storage:** Only one network storage is supported.  
**"Network storage location"** The path to upload the media.  
**"Workgroup"** The workgroup for network storage.  
 After input the setting of server, user can click on Test to test whether the setting is correct. The testing result will be shown in a pop-up window.

**SECURITY**

Copyright © 2008 D-Link Corporation/D-Link Systems, Inc. All rights reserved.

## Add Media

There are three types of media, **Snapshot**, **Video Clip** and **System Log**.

**Media Name:** Enter an unique name for media.

**Snapshot:** Select this feature to enable camera to take snapshot.

**Source:** The source of stream: **stream1** or **stream2**.

**Send pre-event image(s) [0~7]:** The number of pre-event images.

**Send post-event image(s) [0~7]:** The number of post-event images. Refer page 57 for more information.

**File name prefix:** The prefix name will be added on the file name.

**Add date and time suffix to file name:** Check it to add timing information as file name suffix. Refer page 57 for more information.

**Video clip:** Select this feature to enable camera to take video clip.

**Source:** The source of stream: **stream1** or **stream2**.

**Pre-event recording:** The interval of pre-event recording in seconds.

**Maximum duration:** The maximal recording file duration in seconds. Refer page 58 for more information.

**Maximum file size:** The maximal file size would be generated.

**File name prefix:** The prefix name will be added on the file name of the video clip. Refer page 58 for more information.

**System log:** Select this feature to enable camera to display system log.

Product Page: DCS-3110 Firmware Version: 1.00

**D-Link**

DCS-3110 // LIVE VIDEO SETUP ADVANCED MAINTENANCE STATUS HELP

Wizard  
Network Setup  
Dynamic DNS  
Image Setup  
Audio and Video  
Motion Detection  
Time and Date  
Event Setup  
Logout

**MEDIA**

You can set at most 5 different media here for different event.

Save Settings Don't Save Settings

**MEDIA TYPE**

Media name: sendvideo

Snapshot

Source: Stream1

Send 1 pre-event image(s) [0~7]

Send 1 post-event image(s) [0~7]

File Name Prefix:

Add date and time suffix to file name

Video Clip

Source: Stream2

Pre-event recording: 0 seconds [0~9]

Maximum duration: 5 seconds [1~10]

Maximum file size: 500 kbytes [50~800]

File Name Prefix: alert

System log

Save Settings Don't Save Settings

**Helpful Hints..**

"Media name" The unique name for media. There are three kinds of media. They are snapshot, video clip and system log.

**Snapshot:**

"Source" The source of stream, stream1 or stream2.

"Send Pre-event images" The number of pre-event images.

"Send Post-event images" The number of post-event images.

"File name prefix" The prefix name will be added on the file name of the snapshot images.

"Add date and time suffix to file name" Check it to add timing information as file name suffix.

**Video clip:**

"Source" The source of stream, stream1 or stream2.

"Pre-event recording" The interval of pre-event recording in seconds. There are two limitations for video clip file.

"Maximum duration" The maximal recording file duration in seconds.

"Maximum file size" The maximal file size would be generated.

"File name prefix" The prefix name will be added on the file name of the video clip.



### Send post-event image (s) [0~7]

Specify to capture the number of images after a trigger is activated. A maximum of seven images can be generated.

For example:

If both the Send pre-event images and Send post-event images are set to seven, a total of 15 images are generated after a trigger is activated.

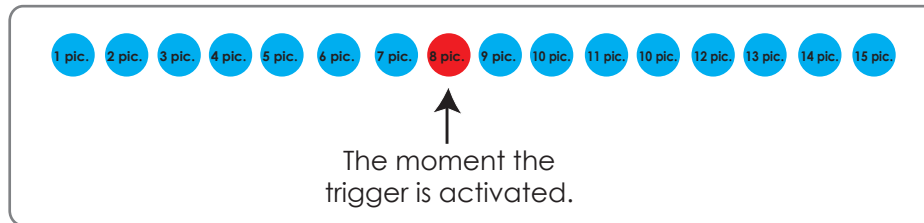

### Add date and time suffix to file name

Select this option to add date and time to the file name suffix.

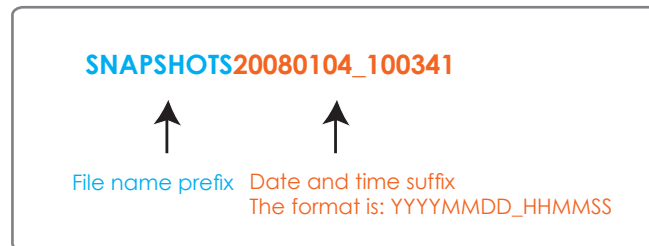

### Maximum duration

Specify the maximal recording duration in seconds. You can set up to ten seconds.

For example:

If the Pre-event recording is set to five seconds and the Maximum duration is set to ten seconds, the Network Camera continues to record for another four seconds after a trigger is activated.

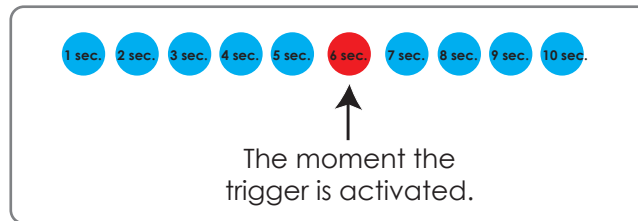

### File name prefix

Enter the text that will be added at the beginning of the file name.



## Add Event

Create and schedule up to 3 events with their own settings here.

**Event name:** Enter a name for the event.

**Enable this event:** Select to activate this event.

**Priority:** Set the priority for this event. The event with higher priority will be executed first.

**Delay:** Select the delay time before checking next event. It is being used for both events of motion detection and digital input trigger.

**Trigger:** The input type that triggers the event.

**Video motion detection:** Motion is detected during live video monitoring. Select the windows that need to be monitored.

**Periodic:** The event is triggered in specified intervals. The unit of trigger interval is minute.

**Digital input:** External trigger input to the camera.

**System boot:** Triggers an event when the system boots up.

**Time:** Select **Always** or enter the time interval.

**Trigger D/O:** Select to trigger digital output for specific number of seconds when an event occurs.

**CF Card:** To record media to the CF card when an event is triggered.

Product Page: DCS-3110 Firmware Version: 1.00

**D-Link**

DCS-3110 // LIVE VIDEO SETUP ADVANCED MAINTENANCE STATUS HELP

Wizard  
Network Setup  
Dynamic DNS  
Image Setup  
Audio and Video  
Motion Detection  
Time and Date  
Event Setup  
Logout

**EVENT**  
You can set at most 3 events like motion detection or digital input trigger here and arrange the detection schedule at the same time.  
Save Settings Don't Save Settings

**EVENT**  
Event name: event1  
 Enable this event  
Priority: High  
Delay for 10 seconds before detecting next event. [For motion detection and digital input]

**TRIGGER**  
 Video motion detection  
Detect motion in  desktop1  
Note: Please configure [Motion Detection](#) first.  
 Periodic  
Trigger every 1 minutes  
 Digital input  
 System boot

**EVENT SCHEDULE**  
 Sun  Mon  Tue  Wed  Thu  Fri  Sat  
Time  
 Always  
 From 00:00 to 24:00

**ACTION**  
 Trigger D/O for 1 seconds  
 myftp  
Attached media: sendvideo  
 CF  
Attached media: sendvideo  
Folder: event\_rec CF Test  
Save Settings Don't Save Settings

**Helpful Hints...**  
"Priority" The event with higher priority will be executed first.  
"Delay second(s) before detecting next event" The delay to check next event. It is used in motion detection and digital input trigger type.  
There are four kinds of trigger supported.  
"Video motion detection" Select the windows which need to be monitored.  
"Periodic" The event is triggered in specified intervals. The unit of trigger interval is minute.  
"System boot" The event is triggered when the system boot up.  
"Sun ~ Sat" Select the days of the week to perform the event.  
"Time" show "Always" or input the time interval.  
The default action are triggering DO and storing media on CF card. If there are servers configured, the user can select them from "Server name", too.  
"Trigger DO" Check it to trigger digital output for specific seconds when event is triggered.

## Add Recording

Here you can configure and schedule the recording settings.

**Recording entry name:** The unique name of the entry.

**Enable this recording:** Select this to enable the recording function.

**Priority:** Set the priority for this entry. The entry with a higher priority value will be executed first.

**Source:** The source of stream.

**Recording schedule:** Scheduling the recording entry.

**Recording settings:** Configuring the setting for the recording.

**Destination:** Select the folder where will store the recording file.

**Total cycling recording size:** Please input a HDD volume between 1MB and 200GB for recording space. The recording data will replace the oldest one when total recording size exceeds this value. For example, if each recording file is 6MB, and the total cycling recording size is 600MB, then the camera will record 100 files to the specified location (folder) and then will delete the oldest file and create new file for cycling recording. Please note that if the HDD empty space is not enough, the recording will stop. Before you setup this option please make sure your HDD has enough space and it is better to not save other files in the same folder as recording files.

**Size of each file for recording:** File size for each recording file. You may input the value in the range of 200-6000.

**File Name Prefix:** The prefix name will be added on the file name of the recording file(s).

The screenshot shows the D-Link DCS-3110 web interface. The top navigation bar includes 'LIVE VIDEO', 'SETUP', 'ADVANCED', 'MAINTENANCE', 'STATUS', and 'HELP'. The 'SETUP' tab is selected, and the 'Recording' configuration page is displayed. The page is titled 'RECORDING' and contains the following sections:

- RECORDING:** A section with a 'Save Settings' button and a 'Don't Save Settings' button. Below it, there is a 'Recording entry name' field with the value 'myrec1'. There are three checkboxes: 'Enable this recording' (checked), 'Priority: normal' (dropdown), and 'Source: Stream1' (dropdown).
- RECORDING SCHEDULE:** A section with a 'Time' dropdown set to 'Always'. There are also 'From' and 'to' time fields set to '00:00' and '24:00' respectively.
- RECORDING SETTINGS:** A section with a 'Destination' dropdown set to 'CF'. Below it, there is a 'Folder: myrec' field. There are three input fields: 'Total cycling recording size: 1000 kbytes [1000~200000000]', 'Size of each file for recording: 200 kbytes [200~6000]', and 'File Name Prefix: camrec'. There are 'Save Settings' and 'Don't Save Settings' buttons at the bottom.

On the right side of the page, there is a 'Helpful Hints..' section with the following text:

- Recording :** Enable this option if you want to upload the recording to a shared folder on the network.
- Recording schedule :** Select the day(s) according to when you want the camera to make a video clip.
- Always :** This enables the camera to make video clips continuously.
- From :** The time range specified for the video clip. For example: the video clip will start at eight o'clock in the morning, and stop at five o'clock in the afternoon when input the following time period - [From 08:00 to 17:00].
- Destination :** Please input the network path of your network storage, it will like "\DNS(IPCamRecord)". If the network storage need authentication, please enter your user name and password here.

# Advanced DI and DO

The I/O connector provides the physical interface for digital output (DO) and digital input (DI) that is used for connecting such external alarm devices as IR-Sensors and alarm relays to the network camera.

**DI and DO:** Settings for both Digital input signal and digital output signal can be configured here.

**Digital input trigger condition:** Please select **High** or **Low** for digital input trigger condition. When an external device is connected to the digital input pins, the state of the voltage will be monitored. (Max. Input 500mA, 12Vdc)

**Digital output:** Select **Grounded** or **Open** to define normal status of the digital output. The camera will show whether the trigger is activated or not.

The screenshot displays the D-Link web interface for the DCS-3110 camera. The top navigation bar includes 'LIVE VIDEO', 'SETUP', 'ADVANCED', 'MAINTENANCE', 'STATUS', and 'HELP'. The 'ADVANCED' tab is selected, and the 'DI AND DO' configuration page is shown. The page contains the following information:

- Product Page:** DCS-3110
- Firmware Version:** 1.00
- D-Link Logo**
- Navigation:** LIVE VIDEO, SETUP, **ADVANCED**, MAINTENANCE, STATUS, HELP
- Left Sidebar:** DI and DO (selected), R548S, ICR, Access List, Logout
- Main Content Area:**
  - DI AND DO**

The I/O connector provides the physical interface for digital output (DO) and digital input (DI) that is used for connecting a diversity of external alarm devices to the PTZ IP camera such as IR-Sensors and alarm relays.

The digital input is used for connecting external alarm devices and once triggered images will be taken and e-mailed.

Buttons: Save Settings, Don't Save Settings
  - DI AND DO**

Digital input: The active state is  ; the current state detected is **High**

Digital output: The active state is  ; the current state detected is **Open**
- Helpful Hints..**

The IP camera provides a general I/O terminal block with one digital input and one relay switch for device control. Pin 1 and pin2 can be connected to an external sensor and the state of voltage will be monitored from the initial state 'LOW'. The relay switch of pin 3 and pin 4 can be used to turn on or off the external device. Please refer to manual for detail connection diagram.

# RS485

With digital PTZ (Pan/Tilt/Zoom) feature enabled, it is possible to zoom in and out video received from the DCS-3110.

## Enable PTZ Operation

To utilize this feature, please connect the DCS-3110 to a PTZ scanner via RS485 interface and follow the instructions given below. Three PTZ drivers are supported:

- DynaDome/SmartDOME
- Lilin PIH-7x00
- Pelco D protocol

**Note:** If none of the above PTZ drivers is supported by your PTZ scanner, please select **Custom camera**.

1. Connect to your PTZ scanner, set the Camera ID, PTZ driver, and Port settings.
2. Select **Enable PTZ Operation** and then click **Save** to take effect.
3. The PTZ control buttons will be displayed in the main page.

## Preset Position

Click **Preset Position** to set the preset position for the Network Camera. A total of 20 preset positions can be configured.

To set a preset position, follow the steps given below:

1. Adjust the Network Camera to a desired position using the buttons on the right side of the window.
2. In the **Preset position name** text box, enter a descriptive name for the preset position. You can enter up to 40 characters in the text box.
3. Click **Add**. The preset position name will appear in the drop-down list.

To remove a preset position from the list, select a preset position name from the drop-down list and then click **Delete**.

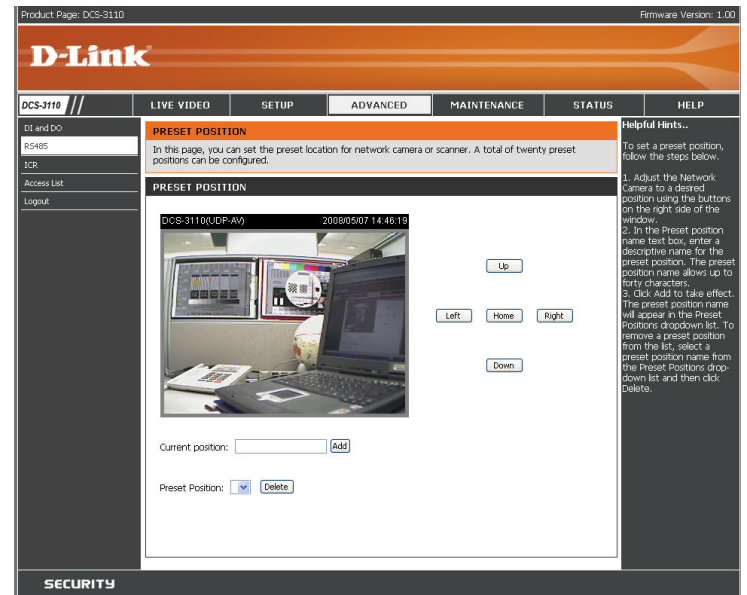
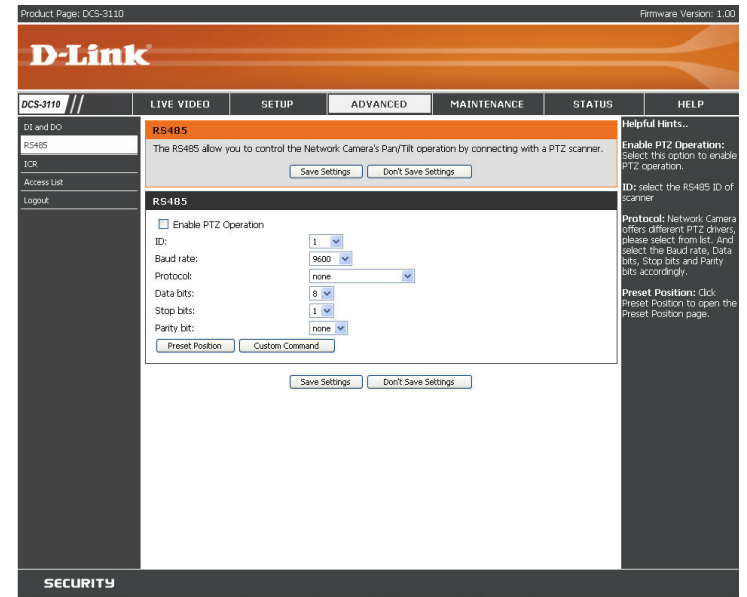

## Custom Command

Click **Custom Command** to open the Custom Command page. In this page, you can set addition command buttons for controlling the PTZ scanner. A total of five command buttons can be configured.

To add a new control button, follow the steps below.

1. In the **Button name** text box, enter the descriptive name for the control button.
2. Refer to the PTZ scanner and enter the command.
3. Click **Save** to take effect and click **Close** to quit this page.
4. The new custom command button will be displayed in the main page.

### NOTE :

*If Custom camera is selected as the PTZ driver, the PTZ control buttons will not take effect. Please go to **Configuration > Camera control > Custom Command** to set the commands in the Control settings session. Please refer to the user manual of the PTZ scanner for the command.*

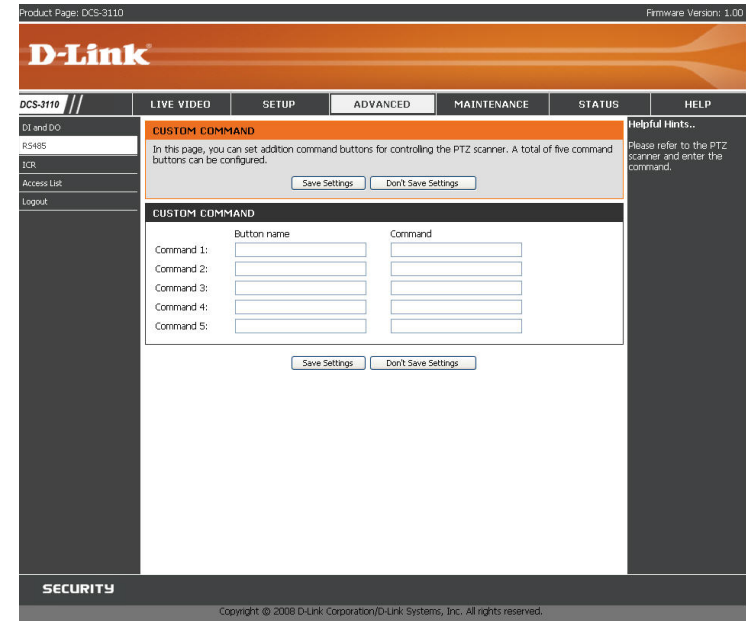

# ICR

**ICR** - IR-Cut Removable(ICR) filter is a switch mechanical design of two different sensor filters. It provides the best light conditions both during the day and night. The following options are:

**Auto:** The Network Camera automatically switches between day and night mode by judging the level of ambient light. This mode is accessible only when the exposure mode is set to **Auto**.

**Day Mode:** In this mode the Network Camera switches on the infrared cut filter at all times, which will block the infrared light from reaching the sensor so that the colors are not distorted.

**Night Mode:** The Network Camera switches off the infrared cut filter to allow the infrared light to pass through. This helps the Network Camera to see more clearly in low light conditions.

**Schedule Mode:** The Network Camera switches between day and night mode based on a specific schedule. Ensure to enter the starting and ending time for the day mode. Note that the time format is [hh:mm] and is expressed in 24-hour clock time. By default, the starting time and ending time of day mode are set to 07:00 and 18:00.

**D-Link**

DCS-3110 // LIVE VIDEO SETUP **ADVANCED** MAINTENANCE STATUS HELP

DI and DO  
RS485  
ICR  
Access List  
Logout

**ICR**

An IR (Infrared) Cut-Removable(ICR) filter can be disengaged from the image path for increased sensitivity in low light environments. The ICR filter will automatically engage depending on the ambient light, allowing the camera to be effective in day/night environments.

1. Select the Day/Night from the radio button. The available options are Automatic, Schedule mode, Day mode and Night mode.
2. The default value is Automatic.

Save Settings Don't Save Settings

**ICR**

IR-Cut Removable filter trigger condition:

Automatic  
 Day mode  
 Night mode  
 Schedule mode

Day mode(24hr)  
 From 07:00 to 18:00

Save Settings Don't Save Settings

**Helpful Hints..**

**ICR :**

**Automatic:** The day/Night mode is set automatically. It is normally set in the Day mode and changes to the Night mode in a dark place.

**Day mode:** The Day mode means disable the IR Cut Filter.

**Night mode:** The Night mode means enable the IR Cut Filter.

**Schedule modes:** Set the Day/Night mode using the schedule. Fill in the time so the Day/Night mode is normally set to Day mode and it enters the Day mode at the start time and returns to the Night mode at the end time.

**SECURITY**



# Access List

The Access List page will allow you to configure access permissions for each user.

**Allow list:** The list of IP addresses that have the access right to the camera.

**Start IP address:** The starting IP Address of the devices (such as a computer) that have permission to access the video of the camera. Click **Add** to save the changes made.

**Note:** A total of ten lists can be configured for both columns.

**End IP address:** The ending IP Address of the devices (such as a computer) that have permission to access the video of the camera.

**Delete allow list:** Remove the customized setting from the Allow List.

**Deny list:** The list of IP addresses that have no access right to the camera.

**Delete deny list:** Remove the customized setting from the Delete List.

For example:

When the range of allowed list is set from 1.1.1.0 to 192.255.255.255 and the range of denied list is set from 1.1.1.0 to 170.255.255.255, Only users' IP located between 171.0.0.0 and 192.255.255.255 can access the Network Camera.

Product Page: DCS-3110 Firmware Version: 1.00

**D-Link**

DCS-3110 // LIVE VIDEO SETUP **ADVANCED** MAINTENANCE STATUS HELP

DI and DO  
RS485  
ICR  
Access List  
Logout

**ACCESS LIST**  
Here you can set access permissions for users to view your DCS-3110.

**ALLOW LIST**

Start IP address   
End IP address    
Delete allow list 1.0.0.0 ~ 255.255.255.255

**DENY LIST**

Start IP address   
End IP address    
Delete deny list

**Helpful Hints...**

**Allow List:**  
"Start IP Address" The starting IP Address of the devices (such as a computer) that have permission to access the video of the camera.  
"End IP Address" The ending IP Address of the devices (such as a computer) that have permission to access the video of the camera.  
"Delete Allow List" Remove the customized setting from the Allow List.

**Deny List:**  
"Start IP Address" The starting IP Address of the devices (such as a computer) that don't have permission to access the video of the camera.  
"End IP Address" The ending IP Address of the devices (such as a computer) that don't have permission to access the video of the camera.  
"Delete Deny List"

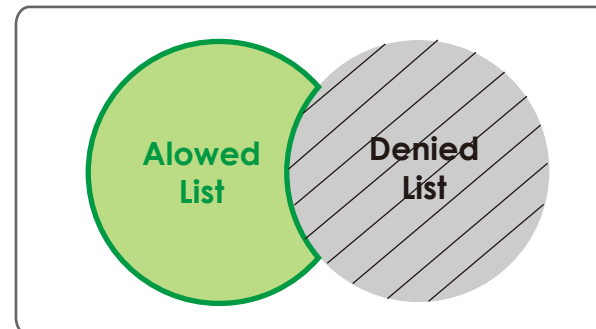

# Maintenance

## Device Management

You can modify both the camera's name and the administrator's password, as well as add more user accounts for accessing the camera.

**Admin password setup:** Modify the password for the administrator's account.

**Add user account:** Add a new user account.

**Username:** Enter a username for the new account.

**Password:** Enter a password for the new account.

**Privilege:** Select the access rights for the new user.

**Manage user:** Manage the accounts for existing users.

**Authentication:** The access rights for existing users.

**Camera Name:** Create a unique name for your camera and you can access the camera using this name in your web-browser. For example: `http://DCS-3110` (by default).

Product Page: DCS-3110 Firmware Version: 1.00

**D-Link**

DCS-3110 // LIVE VIDEO SETUP ADVANCED MAINTENANCE STATUS HELP

Device Management

**DEVICE MANAGEMENT**

You can change to camera's administrative password as well as adding more user accounts for accessing the camera.

**ADMIN PASSWORD SETUP**

Password:

Retype password:

**ADD USER ACCOUNT**

User name:

Password:

Confirm password:

Privilege:

Administrator

Normal User

Guest

**MANAGE USER**

User name:

User password:

Authentication:

Administrator

Normal User

Guest

**CAMERA NAME**

Camera Name:

**Helpful Hints..**

For security reasons, it is recommended that you change the Login Name and Password for the Administrator accounts. Be sure to write down the new Login Names and Passwords to avoid having to reset the camera in the event that they are forgotten.

Camera name: You can access this device by using the name in your web-browser. For example: By default you can enter `http://DCS_3110`.

**SECURITY**

Copyright © 2008 D-Link Corporation/D-Link Systems, Inc. All rights reserved.

# Backup and Restore

The Backup and Restore page will allow you to turn the front panel LED off, restore factory default settings, and reboot the camera.

**Turn off the LED indicator:** Select this option to turn off the LED next to the lens. This will prevent anyone from observing the operation of the network camera.

**Restore:** Click the **Restore** button to reset the camera back to its factory default settings. This will remove all the configuration settings that were made previously.

**Reboot:** Click the **Reboot** button to restart the camera.

Product Page: DCS-3110 Firmware Version: 1.00

**D-Link**

DCS-3110 // LIVE VIDEO SETUP ADVANCED MAINTENANCE STATUS HELP

Device Management  
Backup and Restore  
Firmware Update  
Logout

**BACKUP AND RESTORE**  
You can turn off the front panel LED, restore to factory default and reboot the camera.

**SYSTEM**  
 Turn off the LED indicator

**CF SETUP**  
Format CF card Remove CF card

**RESTORE**  
Restore all settings to factory default. Default

**REBOOT**  
Reboot the system Reboot

**Helpful Hints...**  
"Turn off the front panel LED" Check this option to turn off the LED next to the lens. This will prevent anyone from observing the operation of the IP Camera.  
"Restore to Factory Default" This option will reset the camera back to its factory default settings. This will remove all the configuration settings that were made previously.  
"Reboot" This option will restart the camera.  
Note: Please **Format CF card** before use. The entire data in the CF card will be erased after formatting.  
Note: Before you unplug the CF card from the slot, please select **"Remove CF card"** to ensure that your data is secure.

**Note:** Please format your CF card before use. All data in the CF card will be erased after formatting.

**Note:** Before you unplug the CF card from the slot, please select **Remove CF card** to ensure that your data has been completely stored before the removal.

# Firmware Update

Your current firmware version and date will be displayed on your screen. You may go to the D-Link Support page to check for the latest firmware version available.

To upgrade the firmware on your DCS-3110, please download and save the latest firmware version from the D-Link support site to your local hard drive. Locate the file on your local hard drive by clicking the **Browse** button. Then, open the file and click the **Upload** button to start the firmware upgrade.

**Current firmware version:** It will be automatically determined and displayed by the system.

**Current firmware date:** It will be automatically determined and displayed by the system.

**File Path:** Locate the file (upgraded firmware) on your hard drive using the browse feature.

**Upload:** Start uploading and upgrading the new firmware to your camera.

Product Page: DCS-3110 Firmware Version: 1.00

**D-Link**

DCS-3110 // LIVE VIDEO SETUP ADVANCED MAINTENANCE STATUS HELP

Device Management  
Backup and Restore  
Firmware Update  
Logout

**FIRMWARE UPDATE**

A new firmware upgrade may be available for your "DCS-3110". It is recommended to keep your "DCS-3110" firmware up-to-date to maintain and improve the functionality and performance of your internet camera. Click here [D-Link Support Page](#) to check for the latest firmware version available.

To upgrade the firmware on your "DCS-3110", please download and save the latest firmware version from the D-Link Support Page to your local hard drive. Locate the file on your local hard drive by clicking the Browse button. Once you have found and opened the file using the browse button, click the "Upload" button to start the firmware upgrade.

**FIRMWARE INFORMATION**

Current Firmware Version:	1.00
Current Firmware Date:	14 Mar 2008

**FIRMWARE UPGRADE**

File Path:

**Helpful Hints..**

Firmware updates are released periodically to improve the functionality of your IP camera and also to add new features. If you run into a problem with a specific feature of the IP camera, check our support site by clicking on the [D-Link Support Page](#) on our support site link and see if an updated firmware is available for your IP camera.

# Status

## Device Info

This page displays all the details information about your device and network connection.

Product Page: DCS-3110 Firmware Version: 1.00

**D-Link**

DCS-3110 // LIVE VIDEO SETUP ADVANCED MAINTENANCE STATUS HELP

Device Info  
Logs  
Logout

**DEVICE INFO**  
All of your network connection details are displayed on this page. The firmware version is also displayed here.

**BASIC INFORMATION**

Camera Name:	DCS-3110
Date and Time:	08 Jan 2000 21:01:25
Firmware Version:	1.00, 14 Mar 2008
IP address:	172.17.5.40
Subnet mask:	255.255.255.0
Default router:	172.17.5.254
Primary DNS:	192.168.168.210
Secondary DNS:	192.168.168.250
PPPoE:	OFF
DDNS:	OFF

**Helpful Hints..**  
All of your WAN and LAN connection details are displayed here.

# Logs

This page displays the log information of your camera. You can configure a remote log server so that you can view your log details remotely.

**Enable remote log:** Click to enable this feature so that the camera can send camera log files to a remote server.

**Log server settings:** Configure the settings for the log server.

**IP Address:** The IP address of the remote server.

**Port:** The port number of the remote log server. The default port is 514.

**Save:** Click to save the settings.

**Current Log:** The system log file that displayed by the system. The content of the file reveals useful information about camera configuration and connectivity status after the camera boots up.

Product Page: DCS-3110 Firmware Version: 1.00

**D-Link**

DCS-3110 // LIVE VIDEO SETUP ADVANCED MAINTENANCE STATUS HELP

Device Info  
Logs  
Logout

**LOG**  
View a summary of device information here.

**REMOTE LOG**

Enable remote log

Log server settings:

IP address:

Port:

**CURRENT LOG**

```

Jan 8 16:55:24 syslogd 1.4.1: restart.
Jan 8 16:55:28 [DRM Service]: Starting DRM service.
Jan 8 16:55:42 [SYS]: Serial number = 001CF078CC5C
Jan 8 16:55:42 [SYS]: System starts at Sat Jan 8 16:55:42 UTC 2000
Jan 8 16:55:42 [NET]: === NET INFO ===
Jan 8 16:55:42 [NET]:
Jan 8 16:55:43 [SYS]: Recording entry 0 stop
Jan 8 16:55:43 [SYS]: Recording entry 1 stop
Jan 8 16:55:43 [EVENT MGR]: reload config file
Jan 8 16:55:45 [uartd]: UartD_Select_Dispatch(): Read UART device /dev/ttyS0 error.
Jan 8 17:09:38 [RTSP SERVER]: Start one session, IP=172.17.5.92
Jan 8 17:10:31 [RTSP SERVER]: Stop one session, IP=172.17.5.92
Jan 8 17:23:09 [RTSP SERVER]: Start one session, IP=172.17.5.92
Jan 8 17:23:31 [RTSP SERVER]: Stop one session, IP=172.17.5.92
Jan 8 17:36:17 [RTSP SERVER]: Start one session, IP=172.17.5.92
Jan 8 17:37:31 [RTSP SERVER]: Stop one session, IP=172.17.5.92
Jan 8 20:58:30 [RTSP SERVER]: Start one session, IP=172.17.5.92
Jan 8 20:58:40 [RTSP SERVER]: Stop one session, IP=172.17.5.92
Jan 8 20:59:48 [RTSP SERVER]: Start one session, IP=172.17.5.92
Jan 8 20:59:51 [RTSP SERVER]: Stop one session, IP=172.17.5.92
Jan 8 21:03:38 [RTSP SERVER]: Start one session, IP=172.17.5.92
Jan 8 21:05:33 [RTSP SERVER]: Stop one session, IP=172.17.5.92
Jan 8 21:07:45 [RTSP SERVER]: Start one session, IP=172.17.5.92
Jan 8 21:08:06 [RTSP SERVER]: Stop one session, IP=172.17.5.92
Jan 8 21:08:09 [RTSP SERVER]: Start one session, IP=172.17.5.92
Jan 8 21:08:16 [RTSP SERVER]: Stop one session, IP=172.17.5.92
May 2 13:48:44 [RTSP SERVER]: Start one session, IP=172.17.5.92
  
```

**Helpful Hints...**

"Enable remote log" checked can send log message to remote log server.

"IP address" remote log server IP.

"Port" the default port is 514, if you need specify port, please use port number between 1024 to 65535.

Check the log frequently to detect unauthorized network usage.

# Help

Product Page: DCS-3110 Firmware Version: 1.00

---



DCS-3110 // 
 LIVE VIDEO
SETUP
ADVANCED
MAINTENANCE
STATUS
HELP

<p>Menu</p> <p>Live Video</p> <p>Setup</p> <p>Maintenance</p> <p>Status</p> <p>Logout</p>	<div style="background-color: #e67e22; color: white; padding: 2px 5px; font-weight: bold;">SUPPORT MENU</div> <ul style="list-style-type: none"> <li>Live Video</li> <li>Setup</li> <li>Maintenance</li> <li>Status</li> </ul>
	<div style="background-color: #34495e; color: white; padding: 2px 5px; font-weight: bold;">LIVE VIDEO</div> <ul style="list-style-type: none"> <li>Camera</li> <li><a href="#">Snapshot</a></li> <li><a href="#">Client Settings</a></li> <li>Logout</li> </ul>
	<div style="background-color: #34495e; color: white; padding: 2px 5px; font-weight: bold;">SETUP</div> <ul style="list-style-type: none"> <li><a href="#">Wizard</a></li> <li><a href="#">Network Setup</a></li> <li><a href="#">Dynamic DNS</a></li> <li><a href="#">Image Setup</a></li> <li><a href="#">Audio and Video</a></li> <li><a href="#">Motion Detection</a></li> <li><a href="#">Time and Date</a></li> <li><a href="#">Event Setup</a></li> <li><a href="#">Camera Control</a></li> <li><a href="#">Access List</a></li> <li><a href="#">DI and DO</a></li> <li>Logout</li> </ul>
	<div style="background-color: #34495e; color: white; padding: 2px 5px; font-weight: bold;">MAINTENANCE</div> <ul style="list-style-type: none"> <li><a href="#">Device Management</a></li> <li><a href="#">Backup and Restore</a></li> <li><a href="#">Firmware Update</a></li> <li>Logout</li> </ul>
	<div style="background-color: #34495e; color: white; padding: 2px 5px; font-weight: bold;">STATUS</div> <ul style="list-style-type: none"> <li><a href="#">Device Info</a></li> <li><a href="#">Logs</a></li> <li>Logout</li> </ul>

# D-ViewCam Installation

D-ViewCam software is included for the administrator to manage up to 32 D-Link network cameras remotely. The administrator can use the software to configure the advanced settings for the camera. D-ViewCam is a complete management tool and includes all configurative settings.

Insert the CD into the CD-ROM drive. A menu screen will appear as shown below.

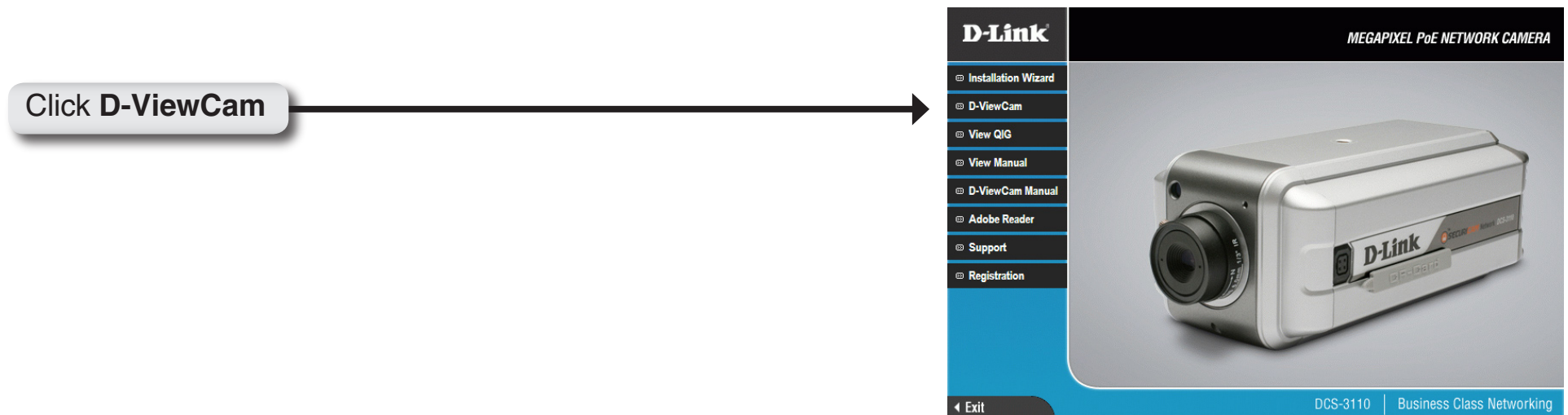

D-ViewCam provides English, Traditional Chinese and Simplified Chinese language versions. Select a language version and click **OK** to continue.

Click **OK**





Click **Next** to continue.

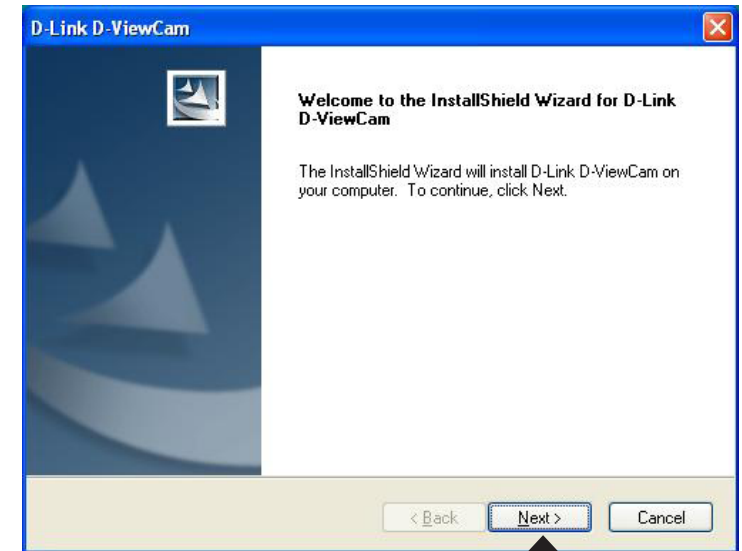

Click **Next**

Click **Browse** if you would like to choose a specific folder for the installation, otherwise click **Next** to continue.

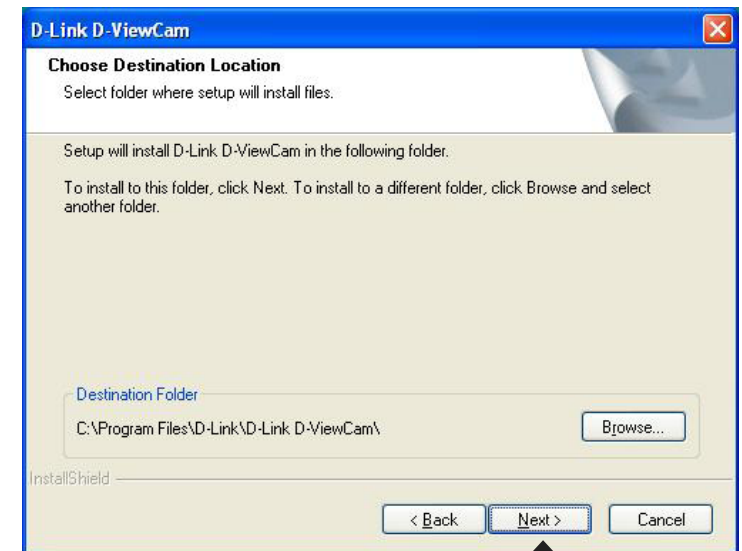

Click **Next**

Click **Next** to start the installation.

**Note:** The D-ViewCam installation process may take several minutes to complete.

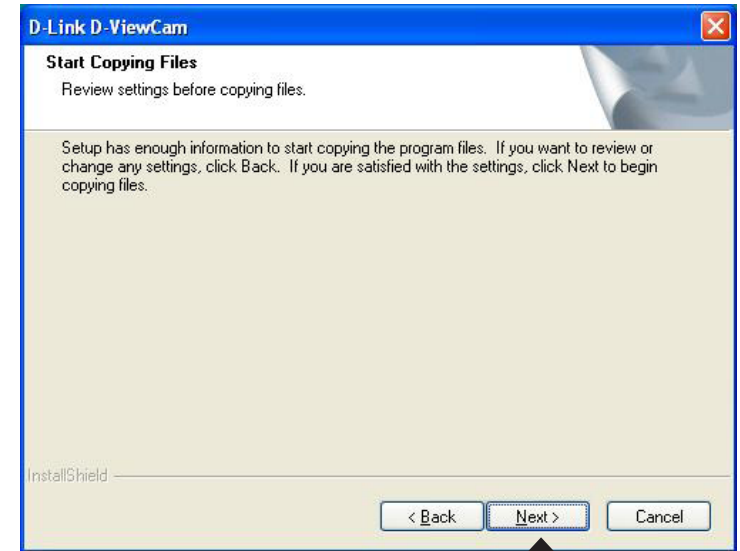

Click **Next**

Click **Finish** to complete the installation.

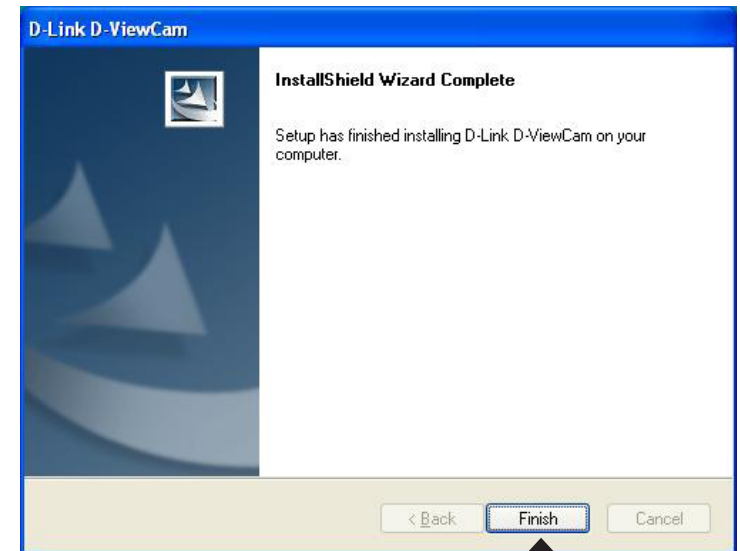

Click **Finish**

# Add a Camera

This section will show you how to start and add a camera to the D-ViewCam system.

To start D-ViewCam, select **Start > All Programs > D-Link > D-Link D-ViewCam**.



Enter **admin** as the default username and leave the password blank. Click  to log into the system and access the Add Camera Wizard.

**Note:** Please refer to page 48 in the D-ViewCam user manual to change your password.

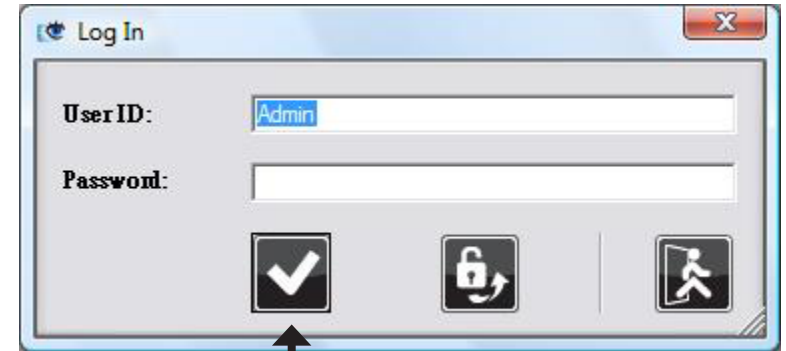

Click

Welcome to the Add Camera Wizard. Use this wizard to add your cameras to the D-ViewCam system.

**Note:** Use the left or right arrow to navigate the wizard.

Click  to continue.

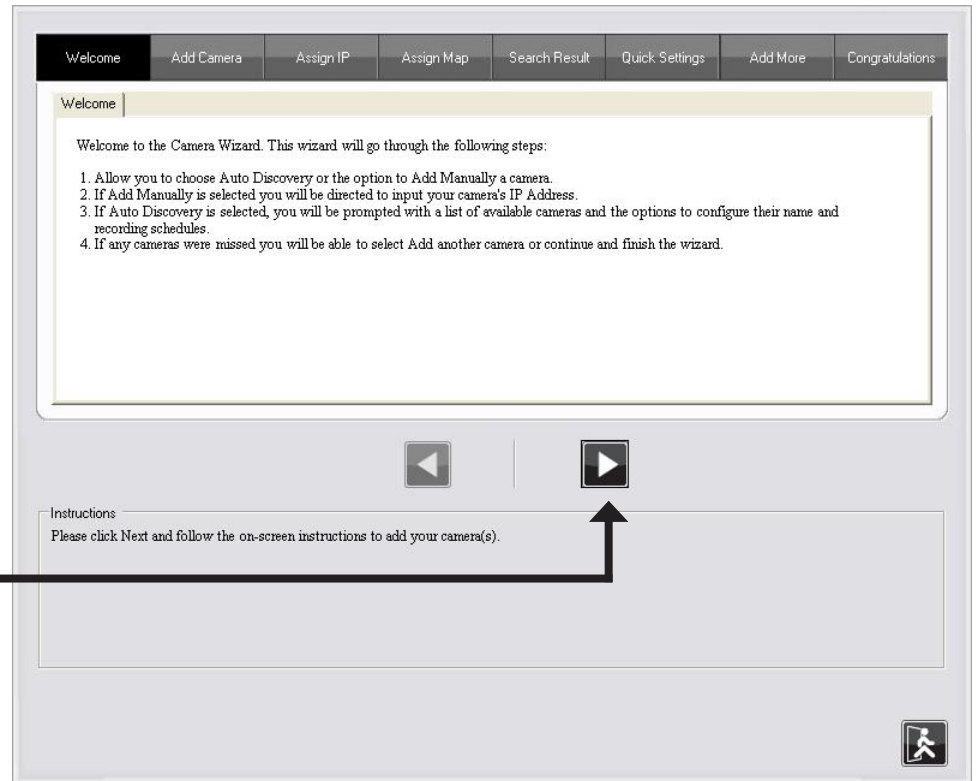

Click 

Select which method to add your camera(s). You can select **Auto Discovery** to automatically search for your camera(s), or select **Add Manually** to add your camera(s) using the camera's IP address. Click **Next** to continue.

If you select **Auto Discovery**, the system will search all cameras that are located on the same LAN with same subnet. The system will place all the cameras at the default map called **My Map**. Click **Next** to continue.

If you choose **Add Manually**, enter the IP address or domain name, http port, model name, camera ID and password.

Click the “?” button to auto detect the camera's model name, then the model name will appear in the **Model Name** box.

Click **Next** to continue.

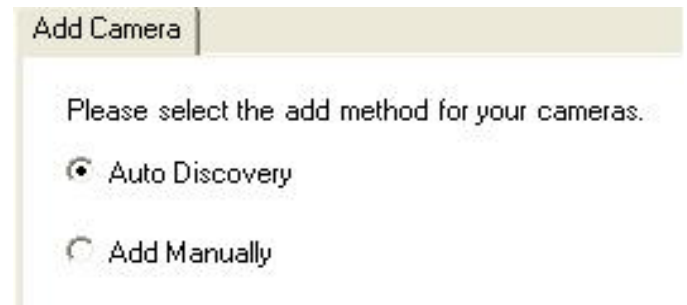

Add Camera

Please select the add method for your cameras.

Auto Discovery

Add Manually

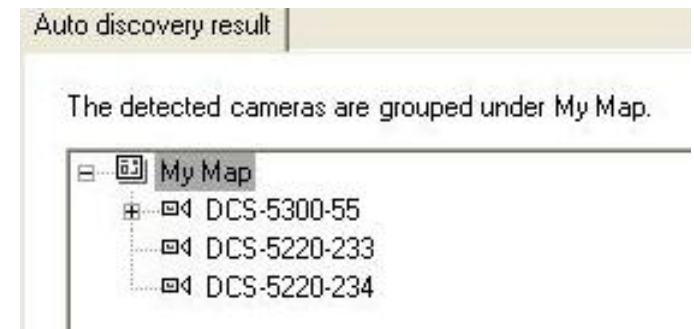

Auto discovery result

The detected cameras are grouped under My Map.

- My Map
  - DCS-5300-55
  - DCS-5220-233
  - DCS-5220-234

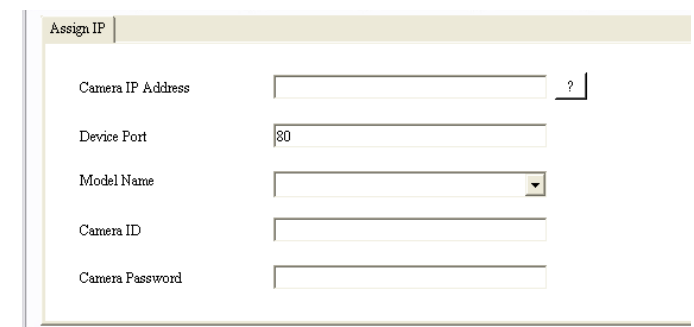

Assign IP

Camera IP Address  ?

Device Port

Model Name

Camera ID

Camera Password

D-ViewCam shows the detected network camera(s) information. You can select the recording mode for each camera.

- **24/7 Continuous Recording:** Continuously records 24 hours a day, 7 days a week.
- **24/7 Motion Detection Recording:** Continuously monitors, but only records when motion is detected.
- **Office Hours Only:** Continuously monitors during office hours (8:00AM to 6:00PM), and only records when motion is detected.
- **Non-Office Hours Only:** Continuously monitors during non-office hours (6:00PM to 8:00AM), and only records when motion is detected.

**Note:** Excluding 24/7 Continuous Recording, all other schedule recording modes can only record when motion is detected. Please refer to the user manual for more information.

Click **Next** to continue.

Quick Settings

The discovered cameras information showed as below:

Camera Name	Model	Schedule Recording Type	Status	IP Address	MAC Address
DCS-5300-55	DCS-5300	None	Active	10.129.1.55	000D887D6DC4
DCS-5220-233	DCS-5220	None	Active	10.129.1.233	001346DC3BC3
DCS-5220-234	DCS-5220	None	Active	10.129.1.234	001346DC3BEB

Select **Yes** to add other cameras, or select **No** if you have no additional cameras to add. Click **Next** to continue.



The **Add Camera wizard** is now complete. Click **Close** to access the D-ViewCam's main screen.



## Your D-ViewCam Installation is Complete!

**Note:** Please refer to the *D-ViewCam user manual* for information about using *D-ViewCam*.

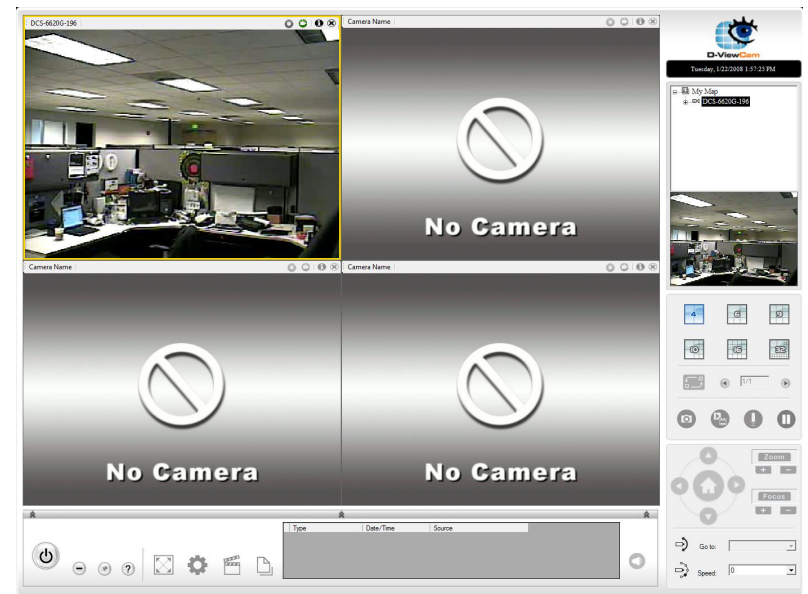

# Frequently Asked Questions

This chapter provides solutions to problems that may occur during the installation and operation of the DCS-3110. Read the following descriptions if you are having any problems.

## Megapixel PoE Network Camera Features

### 1. What is a Megapixel PoE Network Camera?

The Megapixel PoE Network Camera is a stand-alone system connecting directly to an Ethernet or Fast Ethernet network. The Megapixel PoE Network Camera differs from a conventional PC Camera because it has an integrated system with built-in CPU and web-based solutions, providing a low cost solution that can transmit high quality video images for monitoring. The Megapixel PoE Network Camera can be remotely managed, accessed and controlled using a web browser from any computer over an Intranet or Internet.

### 2. What is the maximum number of users that can access DCS-3110 simultaneously?

The maximum number of users that can log onto the Megapixel PoE Network Camera at the same time is 10. Please keep in mind the overall performance of the transmission speed will be reduced if many users have logged on to the camera simultaneously.

There is no limit on the number of users when a multicast-enabled router is being used. The multicast protocol helps reduce the network bandwidth consumption.

Note that the Network Camera must be configured to enable multicast streaming. For more information, see RTSP Streaming on page 41.

### 3. What algorithm is used to compress the digital image?

The Megapixel PoE Network Camera utilizes MPEG-4 simple profile or MJPEG Mode image compression technology providing high quality images. MJPEG is a standard for image compression and it can be applied to various web browsers and application software without installing any extra software

### 4. Can I capture still images from the Megapixel PoE Network Camera?

Yes you can capture still images using the snapshot function.



## Megapixel PoE Network Camera Installation

### 1. Can the Network Camera be used outdoors?

The Megapixel PoE Network Camera is not weatherproof. It needs to be equipped with a weatherproof case for outdoor use but it is not recommended.

### 2. When physically connecting the Network Camera to a network, what network cabling is required?

The Megapixel PoE Network Camera uses Category 5 UTP cable allowing 10 Base-T and 100 Base-T networking solutions.

### 3. Can the Network Camera be setup as a PC-cam on a computer?

No, the Megapixel PoE Network Camera is used only on an Ethernet or Fast Ethernet network. The D-Link DSB-C110, DSB-C310, can be used as a PC Camera (Webcam).

### 4. Can the Network Camera be connected to the network if it consists only of private IP addresses?

Yes, the Megapixel PoE Network Camera can be connected to a LAN using only a private IP address.

### 5. Can the Network Camera be installed and work if a firewall exists on the network?

If a firewall exists on the network, port 80 is open for ordinary data communication. The DCS-3110 uses port 5002 for streaming audio and port 5003 for streaming video. These ports (or the ports you have specified in the Setup Tab in the Configuration screen) need to be opened on the firewall.

### 6. Why am I unable to access the Network Camera from a web browser?

If a router or firewall is used on the network, the correct ports for the DCS-3110 may not be configured on the router or firewall. To correct the problem, you need to determine if the DCS-3110 is behind a router or firewall and if the router or firewall is properly configured for the ports the DCS-3110 is using. Refer to Page 40 for help in opening the correct ports on a router or firewall for use with the DCS-3110. Other possible problems might be due to the network cable. Try replacing your network cable. Test the network interface of the product by connecting a local computer to the unit. If the problem is not solved, the Megapixel PoE Network Camera might be faulty.

### 7. Why does the Network Camera work locally but not externally?

- This might be caused by network firewall protection. The setting of the firewall may need to be changed in order for the Megapixel PoE Network Camera to be accessible outside of your local LAN. Check with the Network Administrator for your network.
- Make sure that your Megapixel PoE Network Camera isn't conflicting with any Web server you may have running on your network.
- The default router setting might be a possible reason. Check that the configuration of the router settings allows the Megapixel PoE Network Camera to be accessed outside of your local LAN.

### **8. I connected the Network Camera directly to a computer with a cross-over Ethernet cable and received a Windows error upon running the installation Wizard?**

- This Windows error will occur if the Megapixel PoE Network Camera is connected to a computer that is not properly configured with a valid IP address. Turn off DHCP from the Network Settings in Windows and configure the computer with a valid IP address or connect the camera to a router with DHCP enabled.
- This error can also occur if the Installation Wizard icon had been clicked more than once from the setup wizard.

### **9. Noisy images occur. How can I solve the problem?**

The video images might be noisy if the Megapixel PoE Network Camera is used in a very low light environment. To solve this issue you need more lighting.

### **10. The images appear to be of poor quality, how can I improve the image quality?**

- Make sure that your computer's display properties are set above 256 colors. Using 16 or 256 colors on your computer will produce dithering artifacts in the image, making the image appear to be of poor quality.
- The configuration on the Megapixel PoE Network Camera image display is incorrect. Through the **Setup > Image Setup** section of the Web management you need to adjust the image related parameters such as brightness, white balance and power line frequency for fluorescent light.

# Networking Basics

## Check your IP address

After you install your new D-Link adapter, by default, the TCP/IP settings should be set to obtain an IP address from a DHCP server (i.e. wireless router) automatically. To verify your IP address, please follow the steps below.

Click on **Start > Run**. In the run box type *cmd* and click **OK**. (Windows Vista® users type *cmd* in the **Start Search** box.)

At the prompt, type *ipconfig* and press **Enter**.

This will display the IP address, subnet mask, and the default gateway of your adapter.

If the address is 0.0.0.0, check your adapter installation, security settings, and the settings on your access point. Some firewall software programs may block a DHCP request on newly installed adapters.

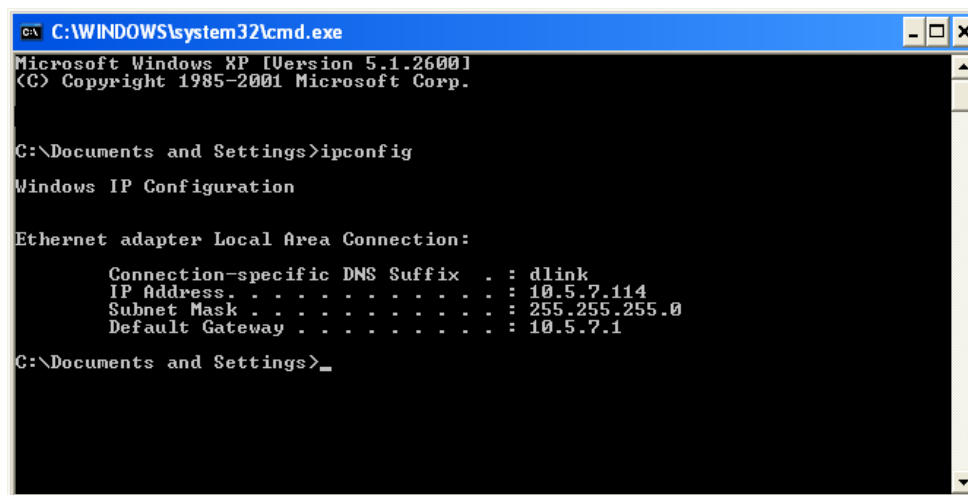
A screenshot of a Windows XP command prompt window. The title bar reads "C:\WINDOWS\system32\cmd.exe". The window content shows the following text:

```
Microsoft Windows XP [Version 5.1.2600]
(C) Copyright 1985-2001 Microsoft Corp.

C:\Documents and Settings>ipconfig

Windows IP Configuration

Ethernet adapter Local Area Connection:

    Connection-specific DNS Suffix  . : dlink
    IP Address. . . . .                : 10.5.7.114
    Subnet Mask . . . . .              : 255.255.255.0
    Default Gateway . . . . .          : 10.5.7.1

C:\Documents and Settings>_
```

If you are connecting to a wireless network at a hotspot (e.g. hotel, coffee shop, airport), please contact an employee or administrator to verify their wireless network settings.

## Statically Assign an IP address

If you are not using a DHCP capable gateway/access point, or you need to assign a static IP address, please follow the steps below:

### Step 1

Windows Vista® - Click on **Start > Control Panel > Network and Internet > Network and Sharing Center > Manage Network Connections.**

Windows® XP - Click on **Start > Control Panel > Network Connections.**

### Step 2

Right-click on the **Local Area Connection** which represents your D-Link network adapter and select **Properties.**

### Step 3

Highlight **Internet Protocol (TCP/IP)** and click **Properties.**

### Step 4

Click **Use the following IP address** and enter an IP address that is on the same subnet as your network or the LAN IP address on your access point.

Example: If the network camera's LAN IP address is 192.168.0.1, make your IP address 192.168.0.X where X is a number between 2 and 99. Make sure that the number you choose is not in use on the network. Set Default Gateway the same as the LAN IP address of your access point (192.168.0.1).

Set Primary DNS the same as the LAN IP address of your access point (192.168.0.1). The Secondary DNS is not needed or you may enter a DNS server from your ISP.

### Step 5

Click **OK** to save your settings.

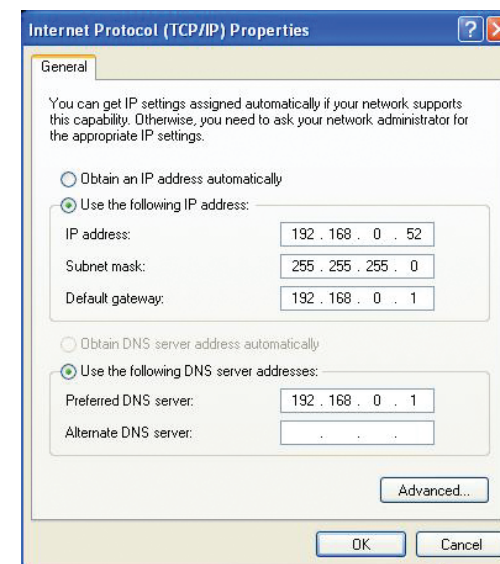

# Reset and Restore

There is a button hidden in the pinhole beside the Ethernet socket. It is used to **reset** the system or **restore** the factory default settings. Sometimes resetting the **DCS-3110** will return the system back to a normal state. If the system still has problems after reset, restore the factory settings and install again:

## RESET:

1. Lightly insert a paper clip (or a similar sized tool) into the reset hole on the back of the camera, press lightly and then release the button.
2. The LED on the front of the camera will begin blinking red and green.
3. When the LED stops the blinking the reset has completed.

## RESTORE:

1. Insert the paperclip or other tool and hold the button in.
2. Wait for the LED on the front of the camera to blink red and green and hold the button for 30 seconds.
3. Withdraw the tool after the second cycle of the LED blinking and a factory restore has been completed.

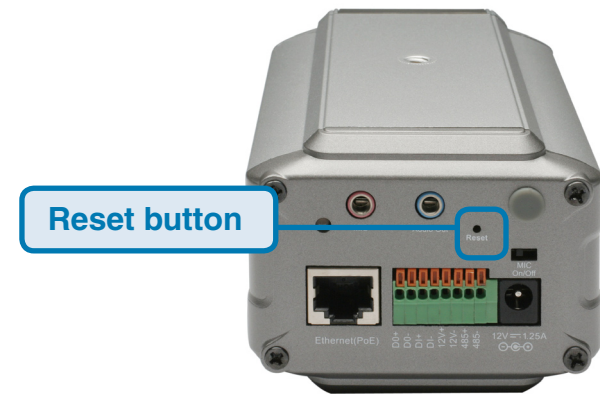

Restoring the factory defaults will result in the loss of any previous settings and will require running the Installation Wizard to return the **DCS-3110** to a normal state.

# External I/O Port

## DI/DO Diagram

Pin 1~4 are used to connect with digital input and digital output devices. Refer to the following illustration for connection method.

The **DCS-3110** provides a general I/O terminal block with one digital input and one relay switch for device control. The relay switch of DO+ and DO- can be used to turn on or off the external device. DI+ and DI- can be connected to an external sensor and the state of voltage will be monitored from the initial state 'LOW'.

The I/O connector provides the physical interface for digital output (DO) and digital input (DI) that is used for connecting a diversity of external alarm devices to the Network Camera such as IR-Sensors and alarm relays.

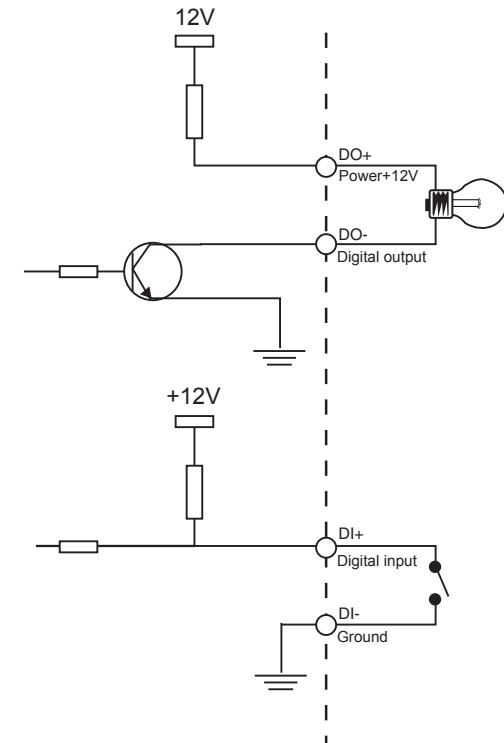

The digital input is used for connecting external alarm devices and once triggered images will be taken and e-mailed.

# Technical Specifications

## NETWORK PROTOCOL SUPPORT

- IPv4, TCP/IP, RTSP/ RTP/ RTCP, HTTP, SMTP, FTP, NTP, DNS, DHCP, UPnP, DDNS, PPPoE, IGMP, Samba client, IP Filtering, 3GPP

## BUILT-IN NETWORK INTERFACES

- 10/100BASE-TX Ethernet port, RJ45

## VIDEO ALGORITHM SUPPORT

- JPEG for still image
- Compression: MJPEG & MPEG-4
- Streaming: Simultaneous dual-streaming
- MPEG-4 streaming over UDP, TCP, or HTTP
- MPEG-4 multicast streaming
- MJPEG streaming over HTTP
- Supports 3GPP mobile surveillance
- Camera live viewing for up to 10 clients

## VIDEO RESOLUTION

- MJPEG video with resolution up to 1280x1024 (1.3 Megapixel)
- MPEG-4 video with resolution up to 640x480 (VGA)
- Up to 30fps at 176 x 144
- Up to 30fps at 320 x 240
- Up to 30fps at 640 x 480
- Up to 8 frames at 1280x1024

## VIDEO FEATURES

- Adjustable image size, quality, and bit rate
- Time stamp and text overlays
- 3 configurable motion detection windows
- Flip & mirror
- Configurable brightness
- AGC, AWB, AES

## VIDEO BIT RATE

- 20K to 4M

## SENSOR & LENS SPECIFICATIONS

- 1/4" 1.3mega-pixel progressive color CMOS sensor
- 6 mm megapixel lens, F1.6
- Removable IR-cut filter: Auto/Schedule/Manual
- Minimum illumination: 1.5 Lux, F2.0

## AUDIO

- Compression and bit rate:  
GSM-AMR speech compression, bit rate: 4.75 kbps ~12.2 kbps  
MPEG-4 AAC audio encoding, bit rate: 16 kbps ~128 kbps
- Interface: Built-in microphone, external microphone input, external speaker output
- Supports two-way audio by SIP protocol
- Supports hardware and software audio mute

## EVENT MANAGEMENT

- Motion detection weekly schedule
- Event notification and upload snapshots/video clips via using HTTP, SMTP, or FTP
- Multiple HTTP, SMTP, or FTP server setup
- Multiple event notification setups for flexible application
- Multiple recording methods for easier backup

## SECURITY

- Administrator and user group protected
- Password authentication
- HTTP and RTSP digest encryption

## SURVEILLANCE SOFTWARE FUNCTIONS

- Remote management/control of up to 32 cameras
- Viewing of up to 32 cameras on one screen
- Supports all management functions provided in web interface
- Scheduled motion triggered, or manual recording options

## REMOTE MANAGEMENT

- Configuration accessible via web browser
- Take snapshots/video clips and save to CF card, local hard drive or NAS via web browser

### SYSTEM REQUIREMENTS

- Operating System: Microsoft Windows® XP/Vista
- Browser: Internet Explorer, Firefox, Netscape, Mozilla, Opera browser

### SUPPORTED PDA, MOBILE PHONES & SOFTWARE

Handsets with 3GPP player

- Packet Video Player 3.0
- QuickTime 6.5
- Real Player 10.5

### PHYSICAL & ENVIRONMENTAL

#### LAN

- IEEE 802.3 compliance
- IEEE 802.3u compliance
- Support Full-Duplex operations
- 802.3x Flow Control support for Full-Duplex mode
- Supported IEEE 802.3af standard (PoE)

#### FRONT-END STORAGE

- CF card slot for local recording of MP4 file

#### EXTERNAL DEVICE INTERFACE

- One D/I and one D/O for external sensor and alarm
- RS485 interface for external scanner
- DC12V output for external accessory

#### DIAGNOSTIC LED

- 2 color LED

#### POWER INPUT

- 100-240Vac, 50/60Hz, 12V, 1.25A<sub>dc</sub>.

#### POWER CONSUMPTION

- MAX 4 W

#### DIMENSIONS

- 80 (W) X 143.8 (D) X 62 (H) (MM)

#### WEIGHT

- 521 gm

#### OPERATION TEMPERATURE

- 0° to 40° C (32° to 104° F)

#### STORAGE TEMPERATURE

- -20° to 70° C (-4° to 158° F)

#### HUMIDITY

- 20% to 80% non-condensing

#### EMISSION (EMI), SAFETY & OTHER CERTIFICATIONS

- FCC
- CE
- C-Tick

<sup>1</sup> The mobile device must have 3G support and subscribe to 3G service from the phone service provider. The playback device must be equipped with 3G video playback such as RealPlayer™ or PacketVideo™.