



User Manual

HD Mini Bullet Outdoor Network Camera

DCS-7010L

Preface

D-Link reserves the right to revise this publication and to make changes in the content hereof without obligation to notify any person or organization of such revisions or changes. Information in this document may become obsolete as our services and websites develop and change. Please refer to the www.mydlink.com website for the most current information.

Manual Revisions

Revision	Date	Description
1.1	August 23, 2012	DCS-7010L Revision A1 with firmware version 1.00

Trademarks

D-Link and the D-Link logo are trademarks or registered trademarks of D-Link Corporation or its subsidiaries in the United States or other countries. All other company or product names mentioned herein are trademarks or registered trademarks of their respective companies.

Copyright © 2012 D-Link Corporation.

All rights reserved. This publication may not be reproduced, in whole or in part, without prior expressed written permission from D-Link Corporation.

Table of Contents

Product Overview.....	5	Live Video	37
Package Contents.....	5	Setup	39
Introduction.....	6	Setup Wizard	39
System Requirements	6	Network Setup.....	45
Features.....	7	Dynamic DNS	48
Hardware Overview	8	Image Setup	49
Front	8	Audio and Video.....	51
Cable Harness.....	9	Preset.....	53
Internal	10	Motion Detection	55
Installing an SD Card	11	Time and Date.....	56
Installation	12	Event Setup.....	57
Zero Configuration Setup.....	12	SD Card	65
Camera Installation Wizard	15	Advanced.....	66
Manual Hardware Installation.....	23	Digital Input/Output.....	66
Mounting the Camera.....	24	ICR and IR.....	67
Positioning the Camera	25	HTTPS.....	68
mydlink.....	27	Access List.....	69
Camera Status	28	SNMP	70
Live Video	29	Maintenance.....	71
Playback	30	Device Management	71
Settings	31	System	72
Recording Settings.....	32	Firmware Upgrade.....	73
Advanced Settings	34	Status	74
Events.....	35	Device Info	74
Configuration.....	36	Logs	75
Using the Configuration Interface.....	36	Help.....	76

DI/DO Specifications	77
Technical Specifications	78
Safety Statements	81

Product Overview

Package Contents



DCS-7010L HD Mini Bullet Outdoor Network Camera



CAT5 Ethernet cable



Power adapter



CD-ROM with User Manual and software



Quick Installation Guide



Mounting Bracket and Mounting Kit



If any of the above items are missing, please contact your reseller.

Note: Using a power supply with a different voltage than the one included with your product will cause damage and void the warranty for this product.

Introduction

Congratulations on your purchase of the DCS-7010L HD Mini Bullet Outdoor Network Camera. The DCS-7010L is a versatile and unique solution for your small office or home. Unlike a standard webcam, the DCS-7010L is a complete system with a built-in CPU and web server that transmits high quality video images for security and outdoor surveillance. The DCS-7010L can be accessed remotely, and controlled from any PC/Notebook over your local network or through the Internet via a web browser. The simple installation and intuitive web-based interface offer easy integration with your Ethernet/Fast Ethernet network. The DCS-7010L weatherproof housing and Power over Ethernet make it an ideal solution for a complete and cost-effective surveillance solution with an easy clutter-free installation. The remote monitoring, infrared, motion detection and event notifications features enable you be truly responsive to your surveillance deployment.

System Requirements

- Computer with Microsoft Windows® 7, Vista®, or XP (for CD-ROM Setup Wizard), Mac OS or Linux
- PC with 1.3GHz or above; at least 128MB RAM
- Internet Explorer 7 or above , Firefox 3.5 or above, Safari 4 and Chrome 8.0 or above
- Existing 10/100 Ethernet-based network
- A MicroSD memory card (optional) is required for recording to onboard storage. SDHC Class 6 or above is recommended.
- Broadband Internet connection

Features

Simple to Use

The DCS-7010L is a stand-alone system with a built-in CPU, requiring no special hardware or software. The DCS-7010L supports both ActiveX mode for Internet Explorer and Java mode for other browsers such as Firefox® and Safari®.

Supports a Variety of Platforms

Supporting TCP/IP networking, HTTP, and other Internet related protocols. The DCS-7010L can also be integrated easily into other Internet/Intranet applications because of its standards-based features. The DCS-7010L offers Ethernet/Fast Ethernet connectivity, making the DCS-7010L easy to integrate into your existing network environment. The DCS-7010L works with a 10Mbps Ethernet based network or 100Mbps Fast Ethernet based network for traditional wired environments.

Web Configuration

Using a standard Web browser, administrators can configure and manage the Network Camera directly from its own Web page via Intranet or Internet. This means you can access your DCS-7010L anytime, anywhere in the world.

Broad Range of Applications

With today's high-speed Internet services, the Network Camera can provide the ideal solution for delivering live video images over the Intranet and Internet for remote monitoring. The Network Camera allows remote access using a Web browser for live image viewing, and allows the administrator to manage and control the Network Camera anytime, anywhere in the world. Many applications exist, including industrial and public monitoring of homes, offices, banks, hospitals, child-care centers, and amusement parks.

Remote Monitoring Utility

The D-ViewCam application adds enhanced features and functionality for the Network Camera and allows administrators to configure and access the Network Camera from a remote site via Intranet or Internet. Other features include image monitoring, recording images to a hard drive, viewing up to 32 cameras on one screen, and taking snapshots.

IR LED for Day and Night Functionality

The built-in infrared LEDs enables night time viewing of up to 32 feet (10 meters).

IP65 Weatherproof Housing

The DCS-7010L uses an IP66 weatherproof housing, allowing you to rest assured that in the toughest of conditions, it will continue to provide round-the-clock surveillance.

PoE (Power over Ethernet) for Flexible Installation

The DCS-7010L can draw all the power it needs from a powered Ethernet port meaning installation is simple and clutter free.

Hardware Overview Front

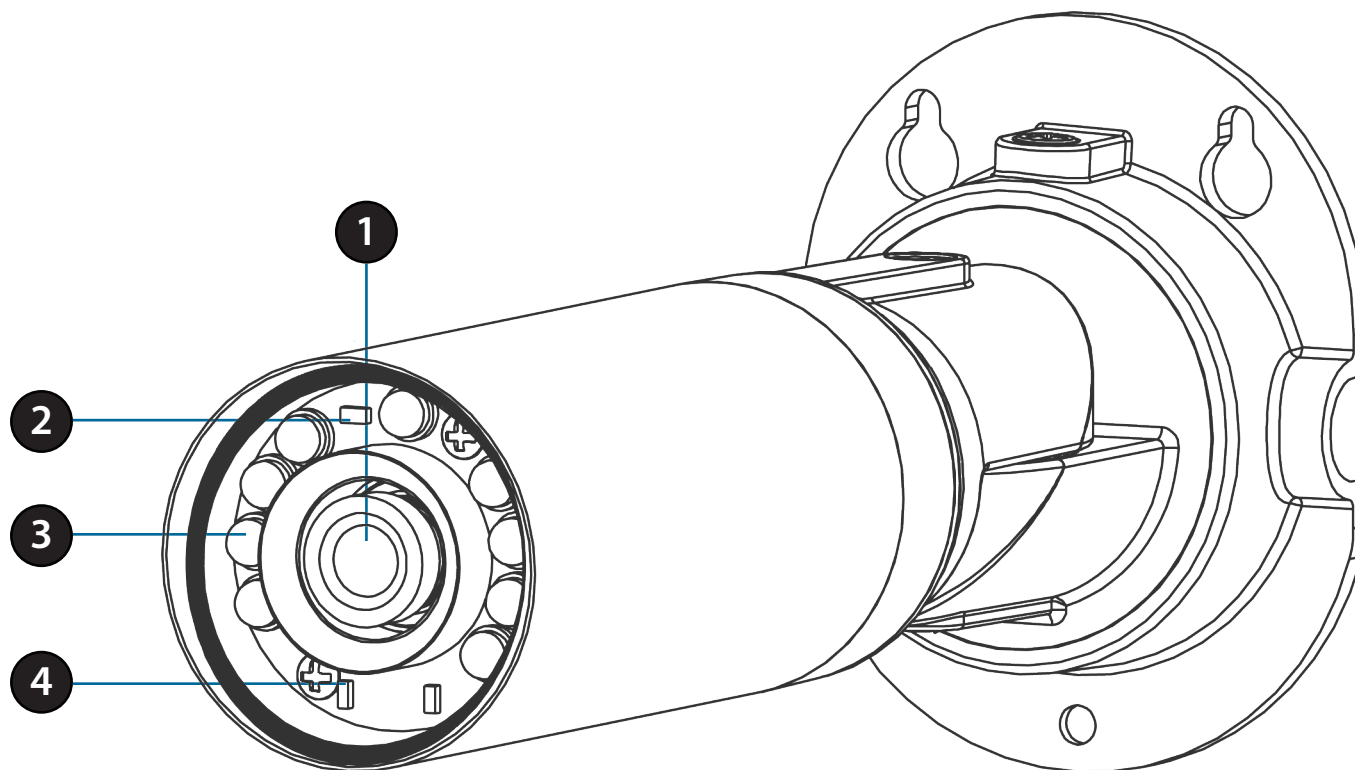

1	Camera Lens	Records video of the surrounding area
2	ICR Sensor	The IR-Cut Removable sensor measures the lighting conditions and switches between color and infrared accordingly
3	IR LEDs	Infrared LEDs illuminate the camera's field of view at night
4	Power/Status LED	Indicates the camera's current status

Cable Harness

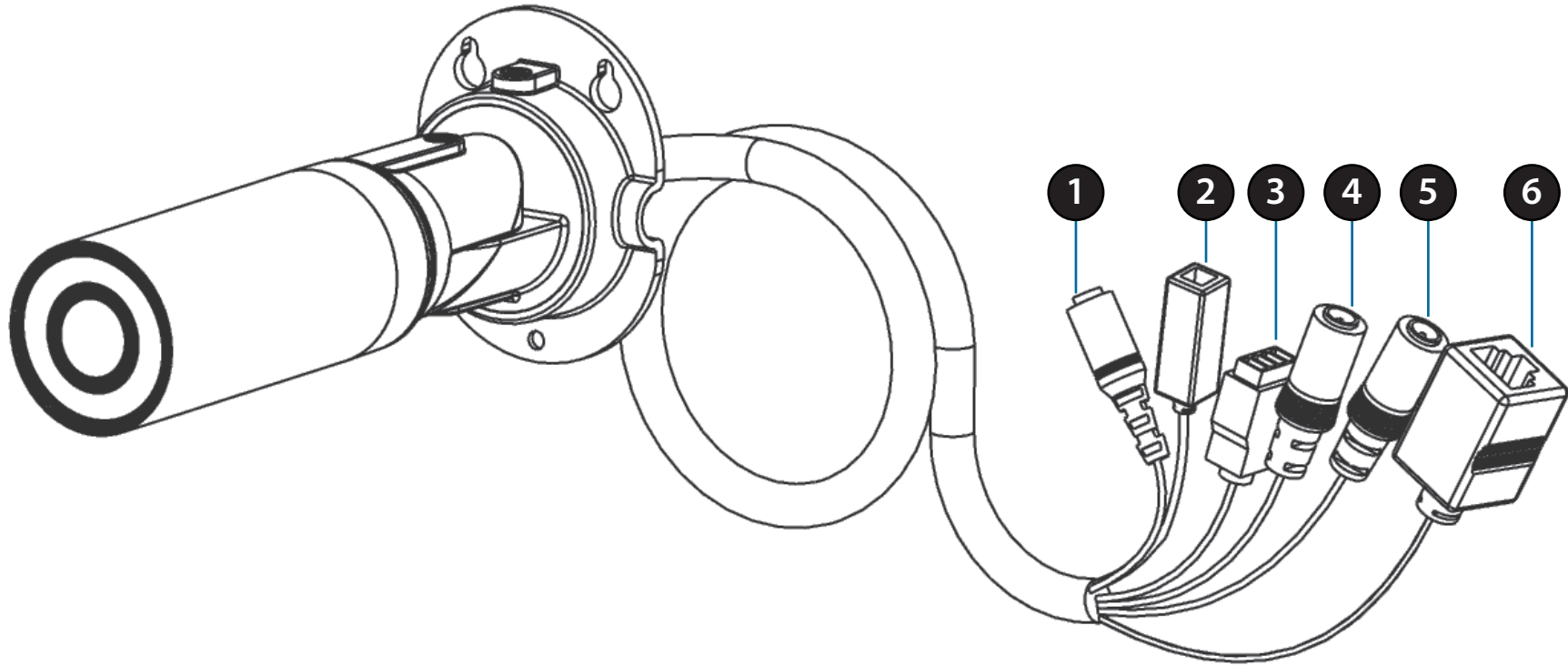

1	Power Connector	Power receptor for the provided power adapter
2	Reset Button	Press and hold the recessed button for 10 seconds to reset the camera
3	DI/DO Connector	I/O connectors for external devices
4	Audio Out (Green)	Connects to a speaker
5	Audio In (Red)	Connects to a microphone
6	Ethernet Port	Connects to an RJ45 Ethernet cable or PoE cable to connect to your network

Internal

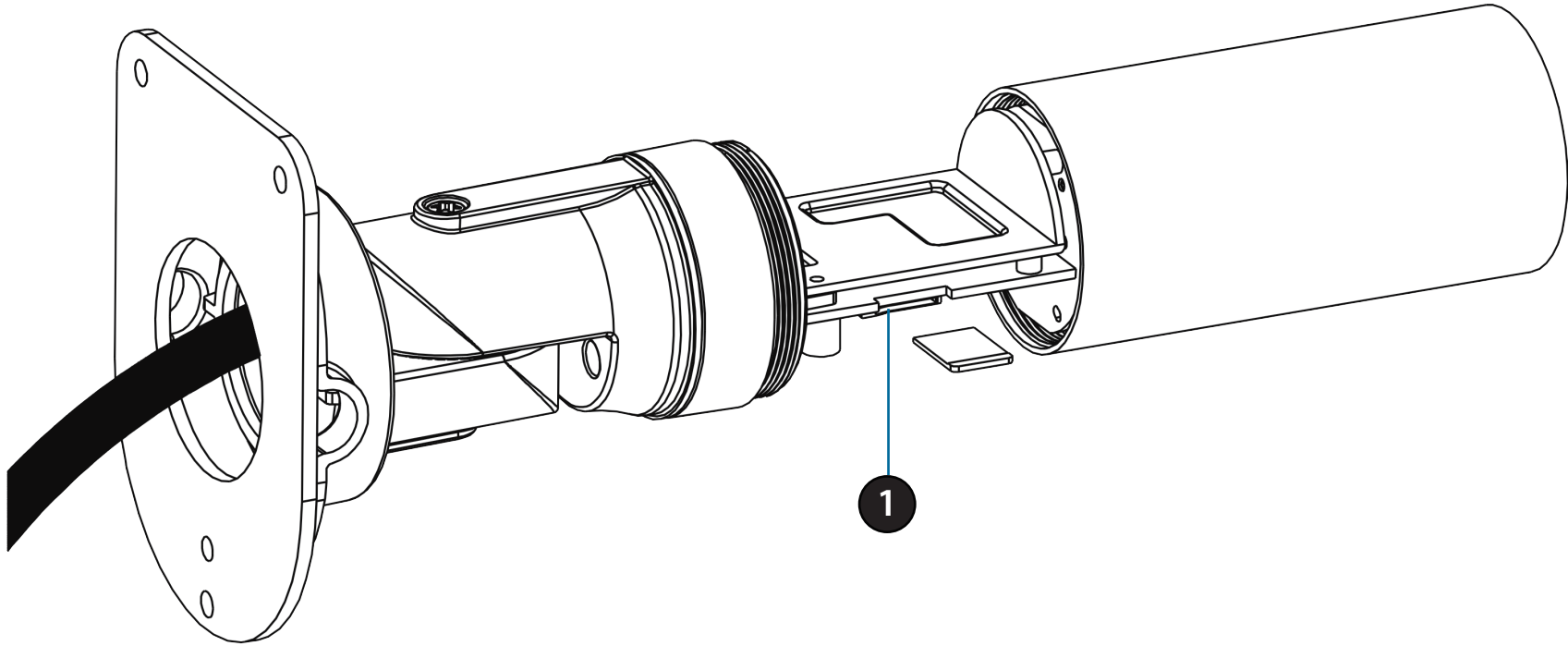

1	Micro SD Card Slot	Insert a MicroSD card for Local storage for storing recorded image and video
---	---------------------------	--

Note: For step-by-step instruction on how to insert an SD card please skip to "Installing an SD Card" on page 11.

Installing an SD Card

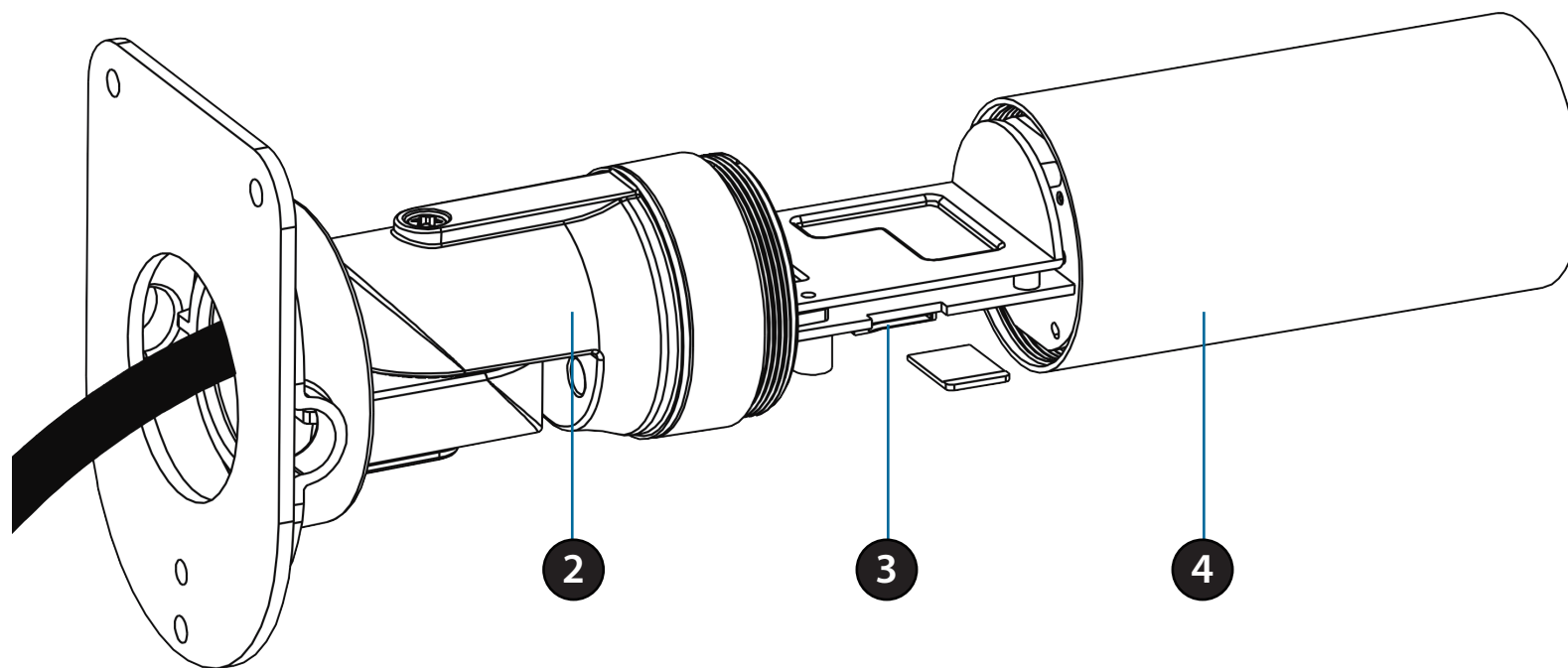

Step 1:

Place the camera face down on a non-slip flat surface.

Step 2:

Unscrew the weatherproof sheath by holding the base of the camera firmly and rotating the barrel counter-clockwise. Exercise caution when removing the weatherproof sheath to avoid damaging the internal components.

Step 3:

Insert your MicroSD card into the slot with the notch oriented to the rear of the camera.

Step 4:

Replace the weatherproof sheath ensuring a tight fit.

Note: To ensure that the camera stays weatherproof, users are advised to ensure that the weatherproof sheath is secured firmly in place.

Installation

Zero Configuration Setup

If you have a mydlink-enabled Cloud Router, you can take advantage of Zero Configuration. Zero Configuration automatically configures your camera's settings for you, and adds it to your mydlink account automatically. This type of setup allows you to set up your camera by simply plugging it in and connecting it to your router.

Connect your camera to your mydlink-enabled Cloud Router and Zero Configuration will automatically configure your DCS-7010L and automatically add the camera to your mydlink account. After the short time it takes to do this you can remotely access your camera from the www.mydlink.com website to manage and monitor your DCS-7010L.

Connect the Ethernet Cable

Connect the provided Ethernet cable to the cable harness Ethernet coupler .

Connect the other end of the provided Ethernet cable to your network.

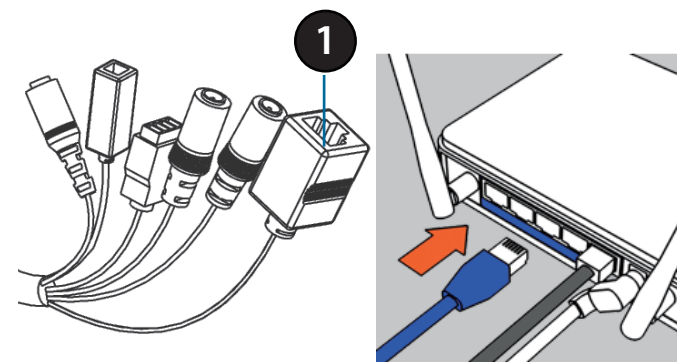

Attach the External Power Supply

Attach the external power supply to the cable harness power coupler.

Connect the adapter to a wall outlet or power strip.

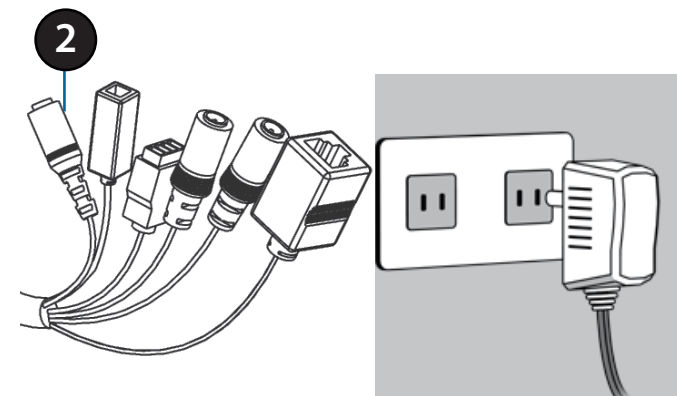

1	Ethernet Cable	Pre attached Ethernet cable
2	Power Cable	Pre attached power cable

Check Your mydlink Account

From any computer, open a web browser, go to <http://www.mydlink.com> and log into your account. Once mydlink detects your camera, a **New Device Found!** notice will appear in the bottom-left corner. Click on the device name to continue.

A summary and confirmation notification will appear with the automatically configured details. Make a note of the details and click **OK** to add the camera to your account.

Zero Configuration is now complete and your camera has been added to your mydlink account. You can now view your camera on the mydlink Live View tab.

Your camera is now set up, and you can skip to "mydlink" on page 27 to learn more about the mydlink features of this camera, or to "Configuration" on page 36 for advanced configuration of your camera.

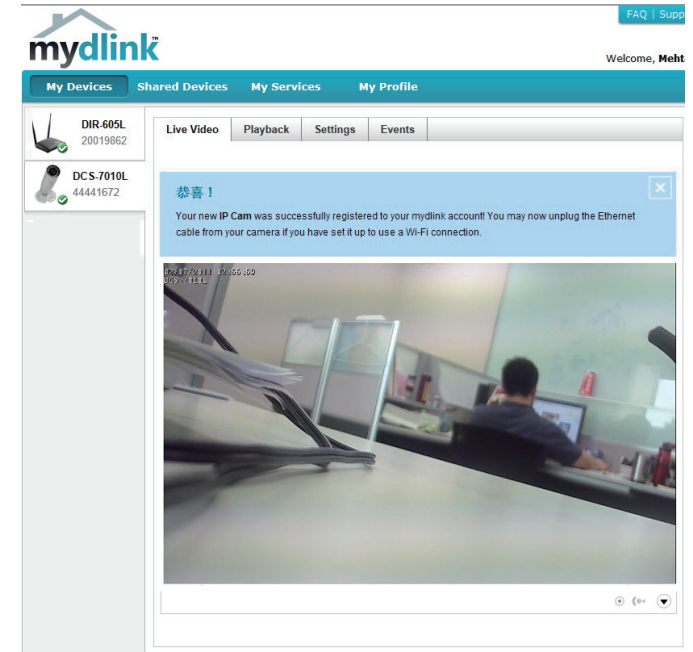

Camera Installation Wizard

Insert the Installation CD-ROM into your computer's optical drive to start the autorun program.

The CD-ROM will open the Camera Installation Wizard. Simply click **Setup Your Camera** to go through the Installation Wizard, which will guide you through the installation process from connecting your hardware to configuring your camera.

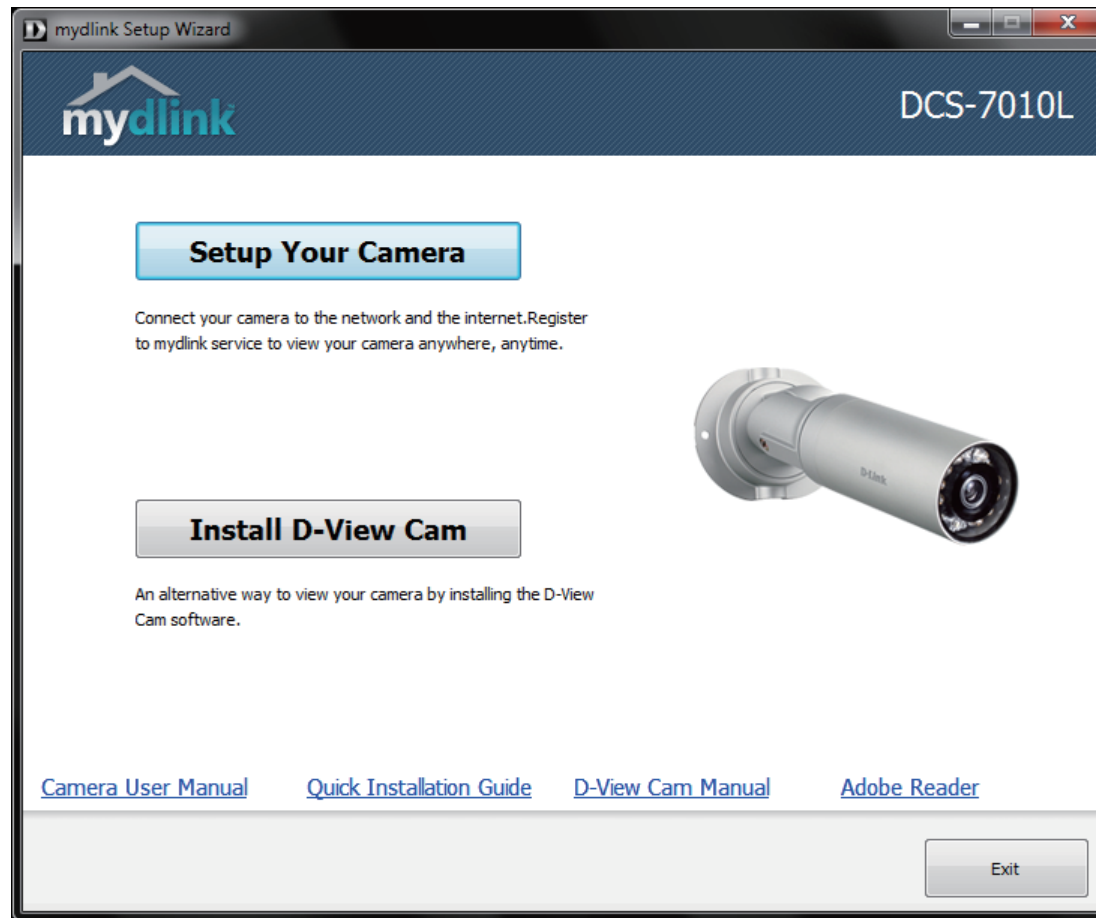

Select your preferred language for the installation from the drop down menu and click on **Start** to continue.

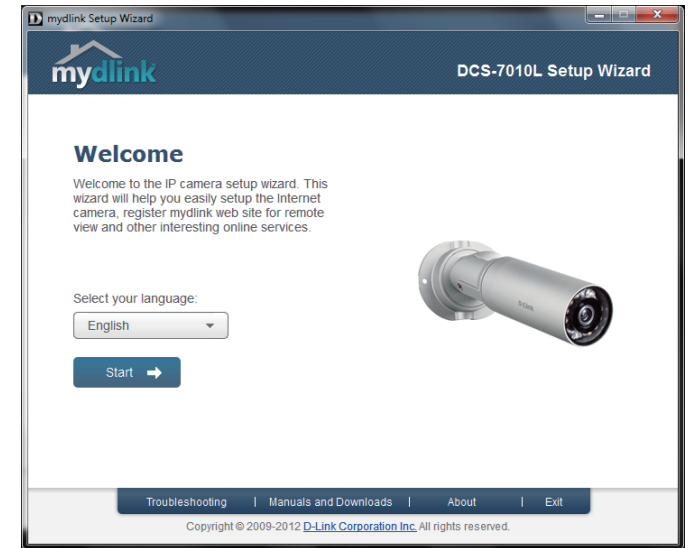

Connect the included Ethernet cable to the internal network cable connector of the DCS-7010L and attach it to the network.

Click **Next** to continue.

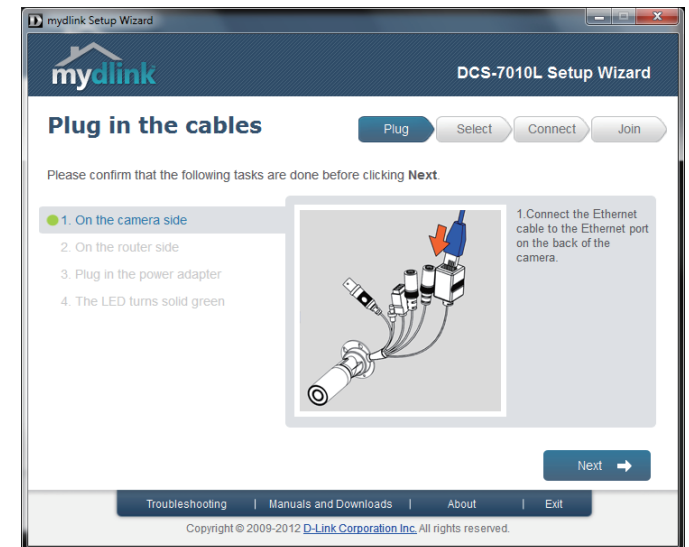

Connect the other end of the same Ethernet cable to a router.

Click **Next** to continue.

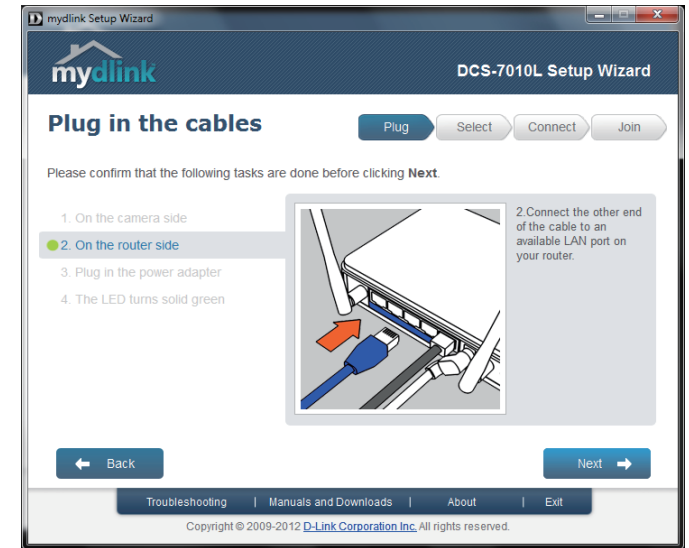

Attach the external power supply to the power connector located inside the DCS-7010L and connect it to your wall outlet or power strip.

Click **Next** to continue.



Section 2: Installation

The LED on the front of the DCS-7010L will blink, then turn solid green once it successfully connects to your network. Click **Next** to proceed.

If the LED continues to stay red, check your connections or click on the "What should I do if the LED stays red?" link for more information.



Select your camera from the list, then click **Next**. If you have multiple cameras, you can identify them by the MAC ID printed on the label on the back of your camera.

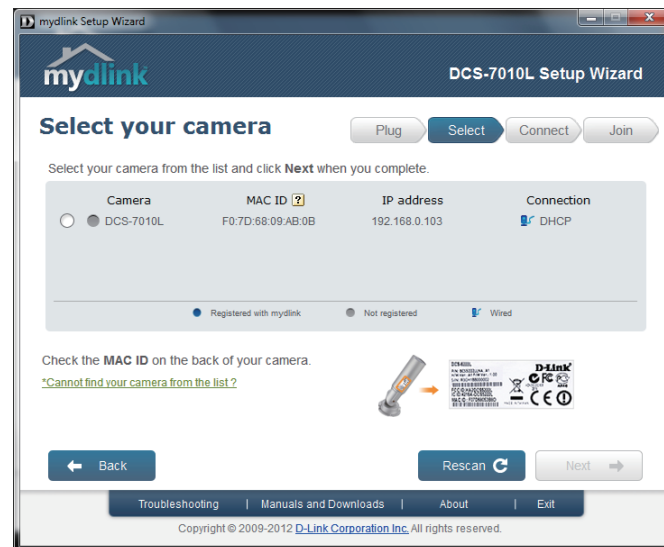

Section 2: Installation

If you wish to remove the camera from a previously registered mydlink account, press and hold the reset button on the rear panel for at least 10 seconds and click **Restart** to restart the wizard.

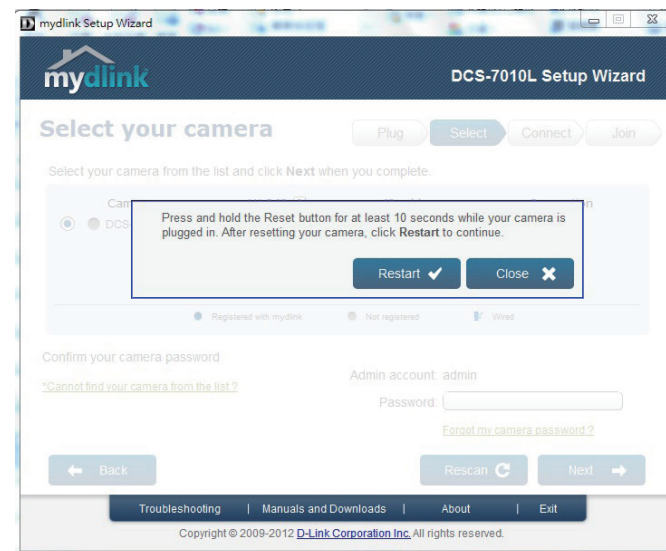

After you have selected your camera from the list, you will be asked to create and confirm a password for it. The password is case sensitive and must contain at least 2 letters.

Click **Next** to continue.

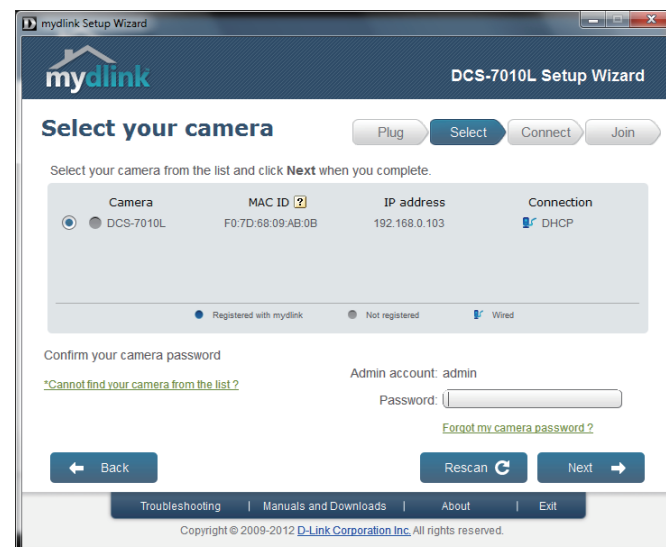

If you do not have a mydlink account then complete the mydlink account registration form with your details.



Make sure to select the **I accept mydlink terms and conditions** box, and click the **Next** button.

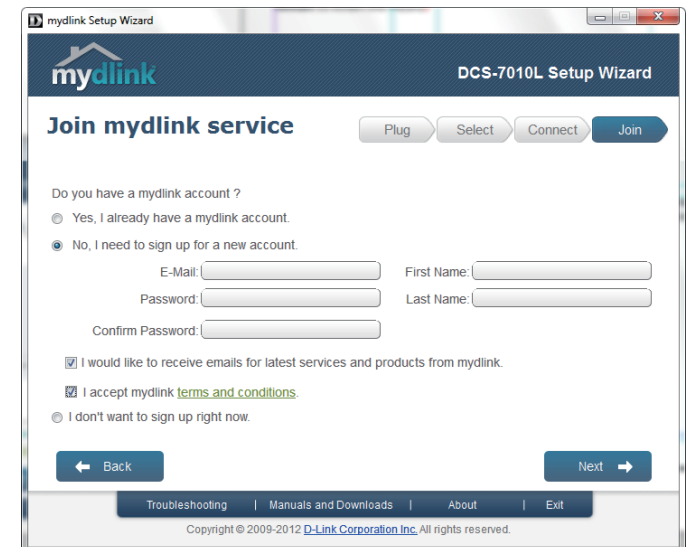

If you already have a mydlink account, enter your login details and click **Next** to proceed.

mydlink Setup Wizard

Join mydlink service

Do you have a mydlink account ?

- Yes, I already have a mydlink account.
- No, I need to sign up for a new account.
- I don't want to sign up right now.

Please enter your mydlink account.

E-Mail:

Password:

[Forgot password ?](#)

Troubleshooting | Manuals and Downloads | About | Exit

Copyright © 2009-2012 D-Link Corporation Inc. All rights reserved.

Confirm your mydlink account details and give the camera a unique name and click **Done**.

mydlink Setup Wizard

Join mydlink service

■ Now you can use the information below to login [mydlink](#) website. click **Done** to visit mydlink website to see camera live view.

Account: untitled.london@gmail.com
Password: xxxxxx

■ You can also learn more about mobile applications for your iPhone & Android phone on [mydlink](#) website.

■ Camera name:

■ [More details about your camera.](#)

Add a shortcut for mydlink to my desktop and create a browser bookmark.

Troubleshooting | Manuals and Downloads | About | Exit

Copyright © 2009-2012 D-Link Corporation Inc. All rights reserved.

Confirm your camera login details and IP address details and click **Done**.



Your DCS-7010L camera is now set up. Log on to your mydlink account and explore the exciting benefits available to you.

Your camera is now set up, and you can skip to "mydlink" on page 27 to learn more about the mydlink features of this camera, or to "Configuration" on page 36 for advanced configuration of your camera.

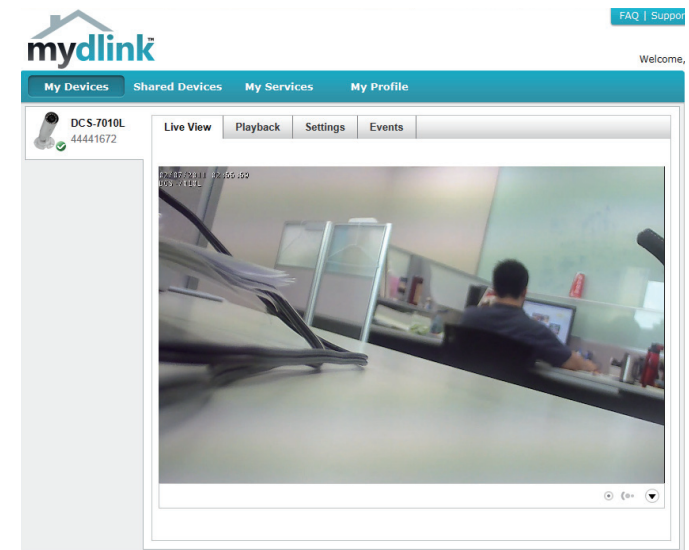

Manual Hardware Installation

If you wish to set up your camera without using the Camera Setup Wizard, please follow these steps.

Note: In order to use the mydlink features of this product, you will need to go through the Camera Setup Wizard.

Connect the Ethernet Cable

Connect the provided Ethernet cable to the cable harness Ethernet coupler .

Connect the other end of the provided Ethernet cable to your network.

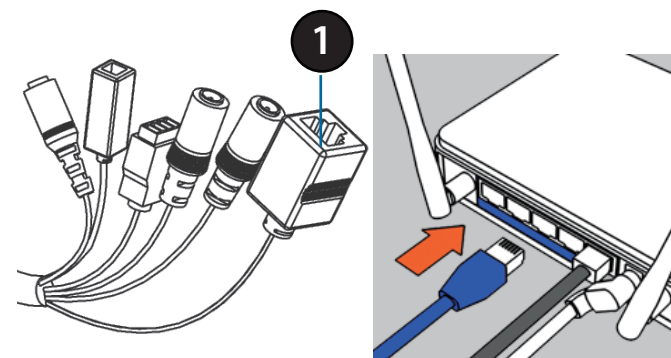

Attach the External Power Supply

Attach the external power supply to the cable harness power coupler.

Connect the adapter to a wall outlet or power strip.

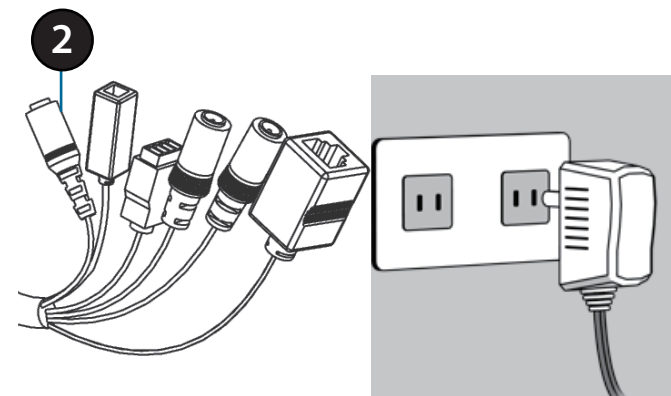

1	Ethernet Cable	Pre attached Ethernet cable
2	Power Cable	Pre attached power cable

Mounting the Camera

The DCS-7010L is suitable for mounting to a wall using the bracket provided.

Note: In order to use the mydlink features of this product, you will need to go through the Camera Setup Wizard.

Step 1

Position the mounting bracket in the desired location.

Step 2

Mark the surface behind the mounting bracket with a pencil

Step 3

Use a 6mm drill bit to make required holes approximately 25mm deep.

Step 4

Insert wall anchors and affix the bracket using the screws provided.

Step 5

Ensure the cable is seated in the cable channel.

Step 6

Suspend the camera from the two protruding studs near the top of the mounting bracket.

Step 7

Insert and tighten the remaining screw into the hole on the camera base.

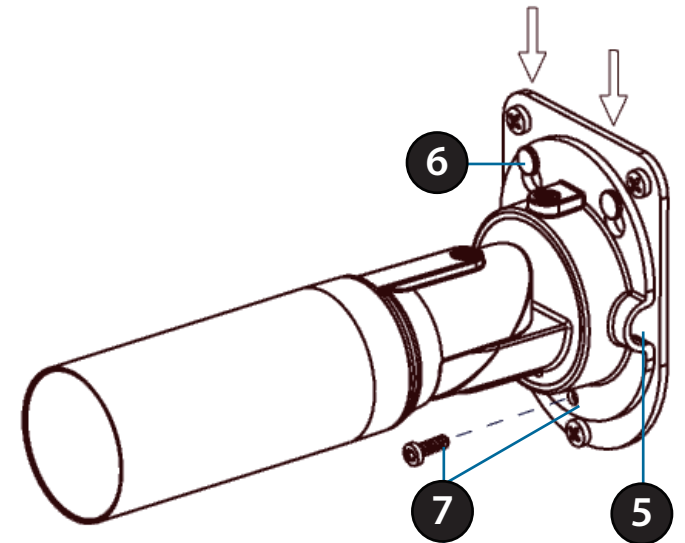
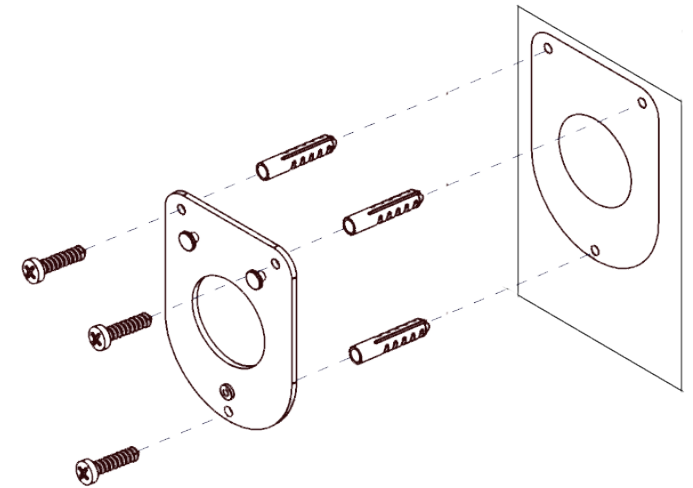

Positioning the Camera

The DCS-7010L can be adjusted to ensure optimal viewing when mounted by following the steps outlined..

Step 1

Using a Torx Security screwdriver, loosen the screw on the top of the camera housing.

Step 2

Swivel the camera along it's horizontal axis until you achieve the desired angle.

Step 3

Using a Torx Security screwdriver, tighten the screw on the top of the camera housing firmly.

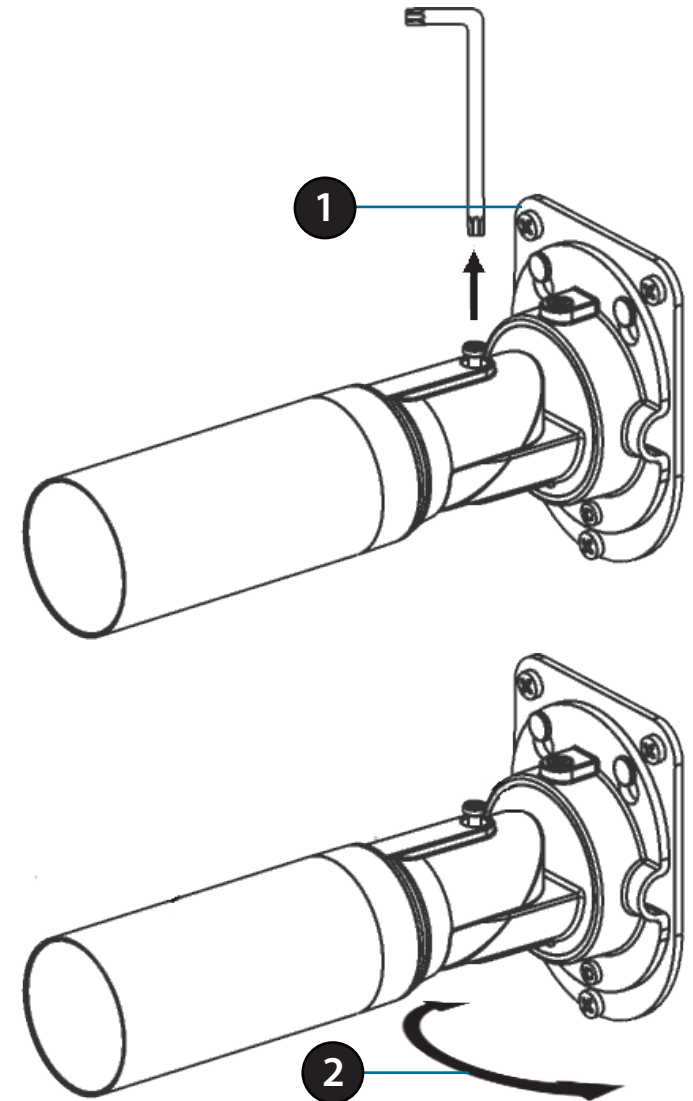

Step 4

Rotate the camera around its vertical axis by adjusting the base.

Step 5

Rotate the camera to adjust for positioning by rotating the barrel.

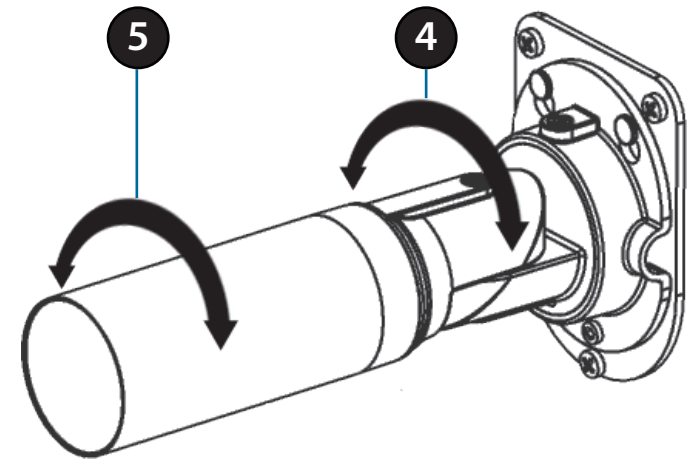

mydlink

After registering your DCS-7010L camera with a mydlink account in the Camera Installation Wizard. You will be able to remotely access your camera from the www.mydlink.com website. After signing in to your mydlink account, you will see a screen similar to the following:

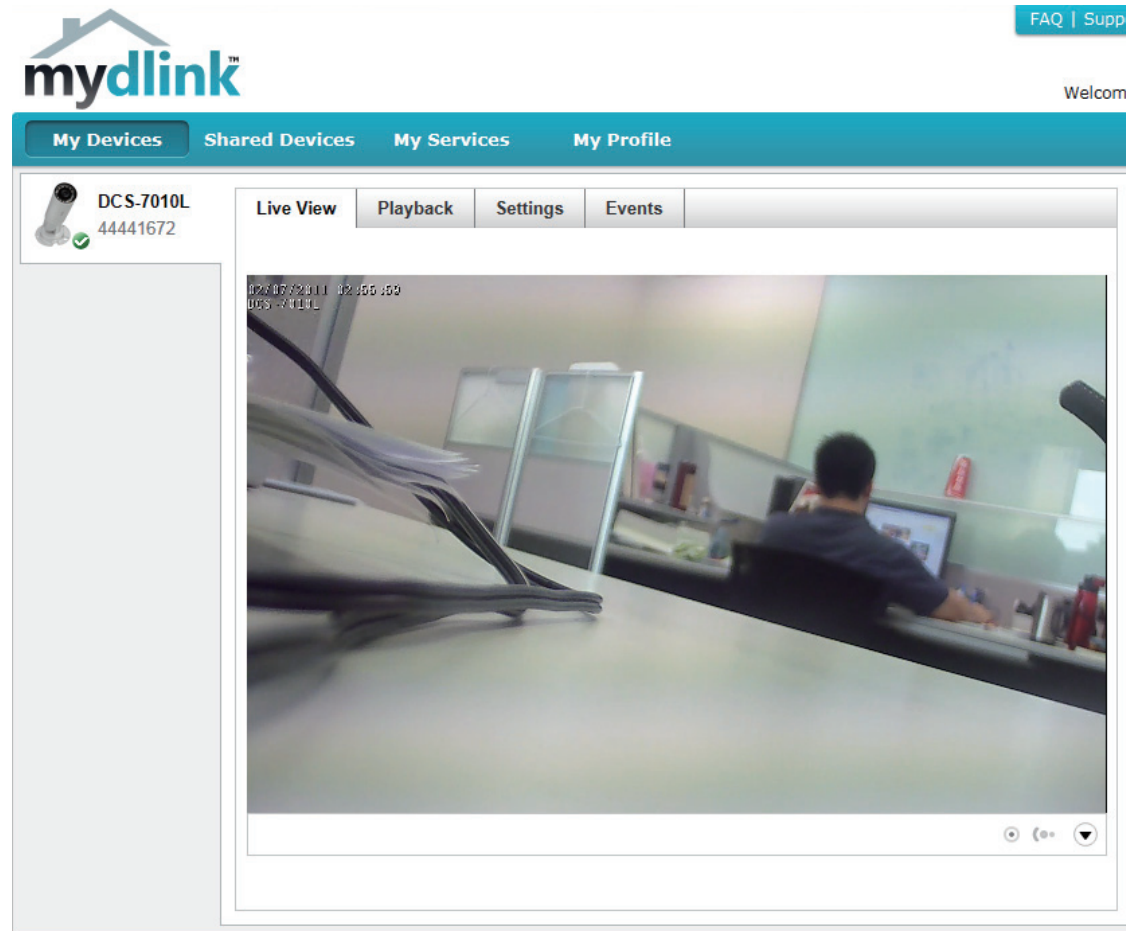

Note: The above screenshot is representative only. The mydlink website is constantly improving and so may appear different.

Camera Status

Here, you can see the online status of each of your cameras. Your online status may be one of the following:



A green checkmark indicates that your camera is online and ready to use.



A yellow exclamation point indicates that your camera is online, but the camera password has changed. You will need to enter your new camera password to access your camera again.



A red X indicates that your camera is offline and currently cannot be accessed remotely.









If your camera is offline, try the following:

- Check to make sure that the Internet connection to your camera is working properly.
- Try restarting your Internet router.
- Check your camera's Ethernet and power cable connections and make sure they are secure.
- Check to make sure that the LED on your camera is lit solid green.

If you still cannot access your camera, reset your camera and run the Camera Installation Wizard again from the CD-ROM included in your package.

Live Video

In the main part of the screen, the Live Video tab will be selected by default. If the camera is available, a Live Video feed will be displayed. Video will be shown at VGA resolution (640x480) if viewing your camera from a PC on the same local network, or at QVGA resolution (320x240) if viewing your camera from a PC on a remote network.

	Options Toggle	Click on this icon to reveal the various Live View options.
	Motion Detection	This icon indicates whether motion detection is in process.
	Recording	This icon indicates whether recording is in process.
	Snapshot	Click on this button to take a snapshot from the video stream.
	Day/Night Mode	Click on this button to engage the infrared
	Audio	Click on this button to toggle the audio stream on or off.
	Brightness	Adjust the slider control to account for brightness.
	Zoom	Adjust the slider control to zoom in or out.

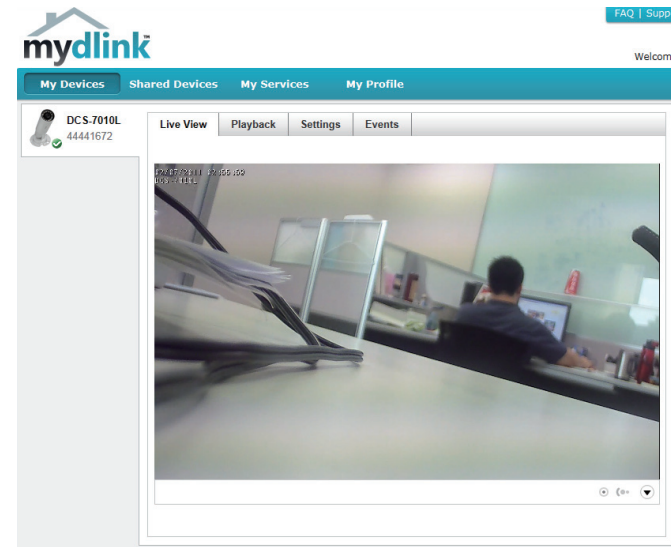

Playback

The Playback tab allows you to review pre-recorded footage captured to an inserted microSD card.

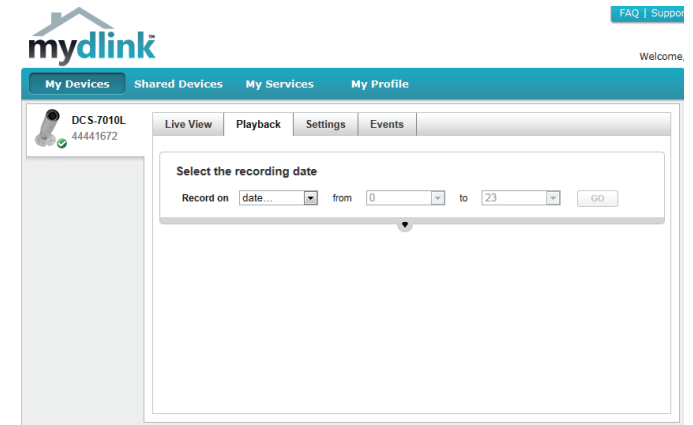

Select the date of the footage you wish to preview from the drop down menu, then choose from the recordings available for playback.

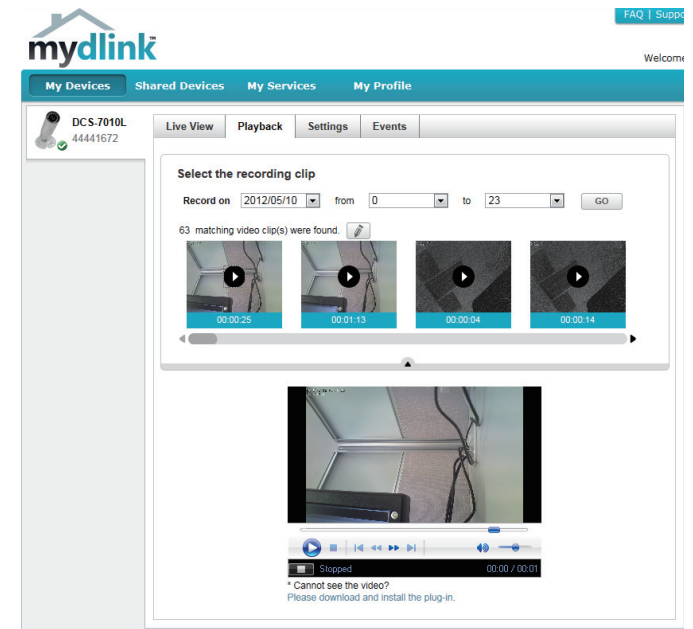

Settings

The Settings tab contains several options for you to control how your DCS-7010L operates.

Camera Name: Click on the **Edit** button to change how the camera name appears.

mydlink No: This is the unique mydlink number for your device.

Model name: This shows the model name of the camera.

MAC: The shows the Media Access Control (MAC) address of the camera.

Camera Activated on: The date the camera was registered to the mydlink service.

Event Notification Settings: E-mail notification of events can be switched on or off.

The screenshot shows the mydlink web interface for a DCS-7010L camera. The 'Settings' tab is active, displaying the following information:

- General Information:**
 - Camera Name: DCS-7010L (with an Edit button)
 - mydlink No.: 44441672
 - Model Name: DCS-7010L
 - MAC: F07D6809AB0B
 - Camera activated on: 2012-06-06 14:33:53
- Event Notification:**
 - Send me alert notifications: E-mail (with a Save button)
- Event Trigger Settings with Recording:**
 - Do not record any video clips.
 - Record video clips by motion detection.
 - Record video clips by schedule.
- Advanced Settings:**
 - Username: admin
 - Camera Password: ***** (with a Show password checkbox)
 - Advanced Setting button





Recording Settings: Each of the recording settings will open a further menu.

The Recording Settings section shows the following options:

- Do not record any video clips.
- Record video clips when motion is detected.
- Record video clips by schedule.

Recording Settings

Record video clips when motion is detected: Select this option to enable the automatic recording when motion is detected.

	Add Detection Area: Click on this icon to draw areas that will trigger automatic recording when motion is detected.
	Remove Detection Area: Click on this icon to erase areas from regions that trigger automatic recording when motion is detected.
	Clear Detection Area: This will remove all detection areas
	Refresh Snapshot: This will refresh the current snapshot of the monitored area.
	Increase/Decrease Sensitivity Increase the motion detection sensitivity

Email Notification: Toggles notification by email on or off.

Video Clips Recording Mode: In the event that the microSD card can not store further recordings, the user can choose to record over previous recordings or to be notified and cease recording.

Do not record any video clips.

Record video clips by motion detection.

1 Motion detection



02/07/2011 05:59:05
DCS-7010L

2 Video clips recording mode

The inserted MicroSD card can store about 0 days of video maximum.

When the MicroSD card is full:

Continue recording & overwrite the oldest video.

Stop recording & notify me.

Record Video Clips by Schedule: This option enables either continuous or recurring scheduled recording.

Email Notification: Toggles notification by email on or off.

Video Clips Recording Mode: In the event that the microSD card can not store further recordings, the user can choose to record over previous recordings or to be notified and cease recording.

Record video clips by schedule.

1 Schedule setup

Record video:

Continuously.

Only on: Sun Mon Tue Wed Thu Fri Sat

From to

2 E-mail notification

Enable e-mail notification

I want to send e-mail from:

Sender E-mail Address:

SMTP Mail Server:

Port: (range 1 to 65535)

User Name:

Password:

Use SSL-TLS:

*The notification will be sent to the e-mail address registered in mydlink.

I want the e-mail notification to include:

Single snapshot, with notifications sent every seconds

3 Video clips recording mode

The inserted MicroSD card can store about 0 days of video maximum.

When the MicroSD card is full:

Continue recording & overwrite the oldest video.

Stop recording & notify me.

Advanced Settings

Show password: Checking this box will show the password.

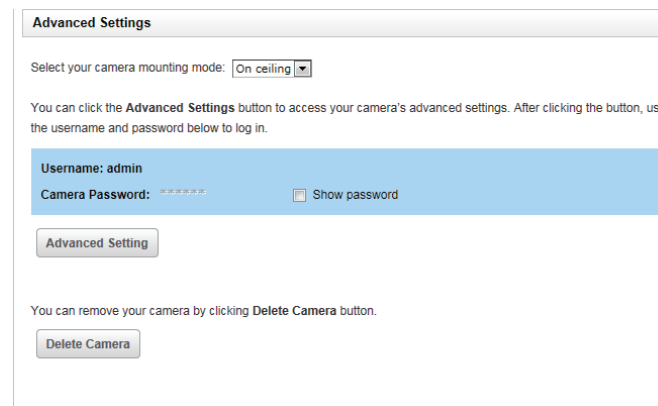

Advanced Setting: Clicking on the **Advanced Setting** button will open a secondary window allowing full configuration of the DCS-7010L

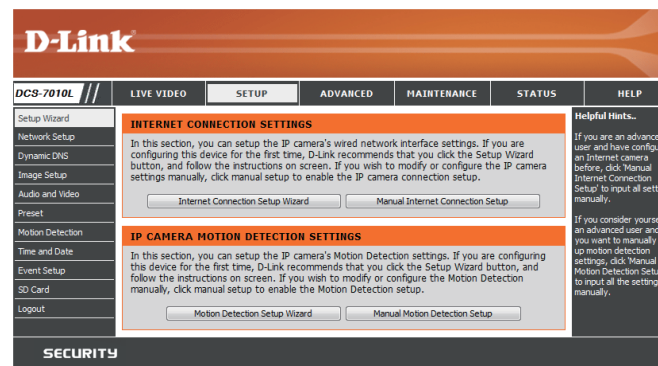
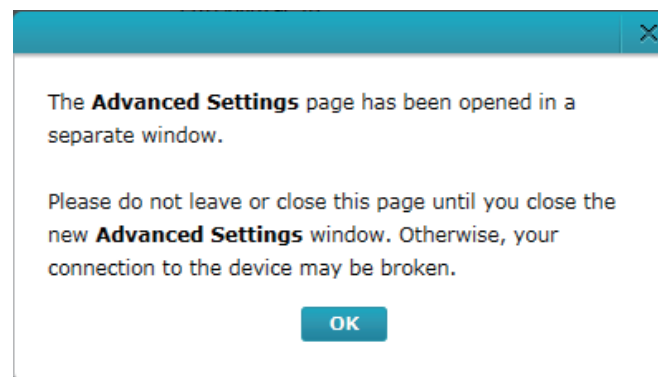

Events

The Events tab contains options for you to keep track of your DCS-7010L event notifications.

Select from the available options to manage your event log.



Mark Page as Read: Clicking this button will mark the current page of event notifications as read.



Mark all as Read: Clicking this button will mark all event notifications as read.

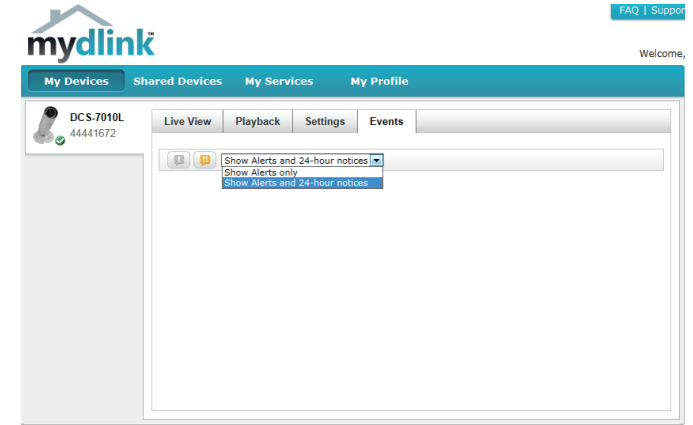

Configuration

Using the Configuration Interface

After completing the Camera Installation Wizard, you are ready to use your camera. The camera's built-in Web configuration utility is designed to allow you to easily access and configure your DCS-7010L. At the end of the wizard, click **Go To Camera**, or enter the IP address of your camera into a web browser, such as Mozilla Firefox. To log in, use the User name **admin** and the password you created in the Installation Wizard. If you did not create a password, the default password is blank. After entering your password, click **OK**.









Live Video

This section shows your camera's live video. You may select any of the available icons listed below to operate the camera. You may also select your language using the drop-down menu on the left side of the screen.

You can zoom in and out on the live video image using your mouse. Right-click to zoom out or left-click to zoom in on the image.

SD Status: This option displays the status of the SD card. If no SD card has been inserted, this screen will display the message "Card Invalid."

IO Status: This option displays the status of your I/O device if a device has been connected.





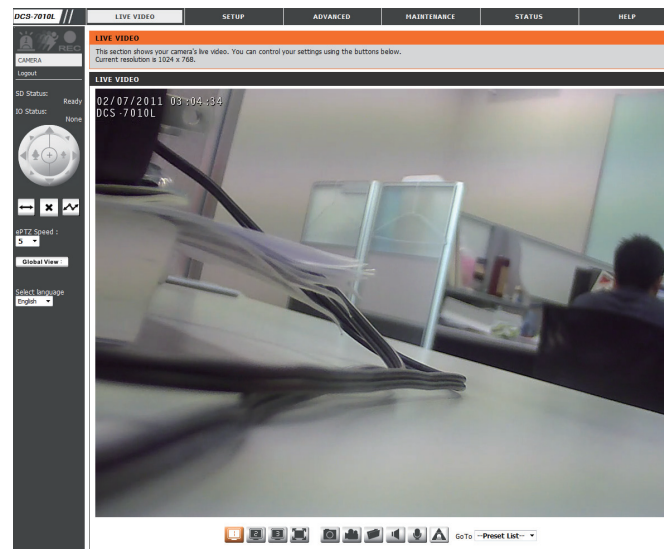





	Digital Input Indicator	This indicator will change color when a digital input signal is detected.
	Motion Trigger Indicator	This indicator will change color when a trigger event occurs. Note: The video motion feature for your camera must be enabled.
	Recording Indicator	When a recording is in progress, this indicator will change color.
	Control Pad	This control pad can be used to electronically pan, tilt, and zoom (ePTZ) within the camera's predefined view area, if one has been defined.
	Auto Pan	Starts the automatic panning function. The ROI will pan from back and forth within the FOV
	Stop	Stops the camera ePTZ motion
	Preset Path	Starts the camera's motion along the predefined path

ePTZ Speed: You may select a value between 0 and 64. 0 is the slowest and 64 is the fastest.



Global View: This window indicates the total field of view (FOV) of the camera. The red box indicates the visible region of interest (ROI).

Language: You may select the interface language using this menu.

- | | |
|---|--|
|  Video Profile 1 |  Record a Video Clip |
|  Video Profile 2 |  Set a Storage Folder |
|  Video Profile 3 |  Listen/Stop Audio In (from microphone) |
|  Full screen mode |  Start/Stop Audio Out (to speaker) |
|  Taking a Snapshot |  Start/Stop Digital Output |

Go To: If any presets have been defined, selecting a preset from this list will (**Preset List**) display it.

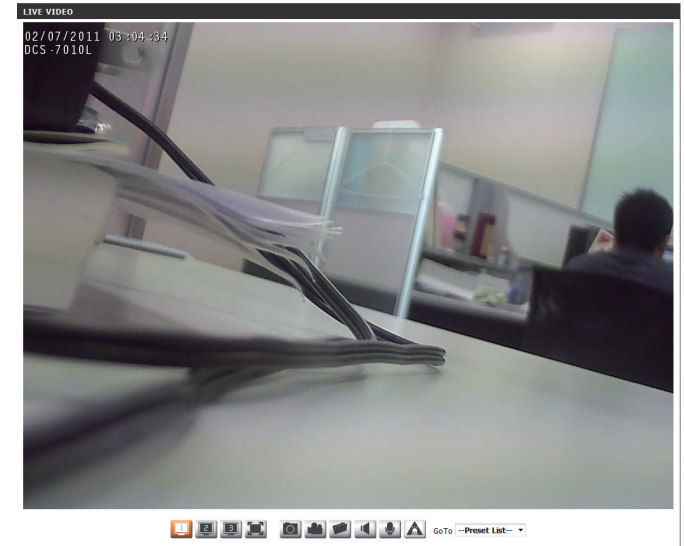

Setup Setup Wizard

To configure your Network Camera, click **Internet Connection Setup Wizard**. Alternatively, you may click **Manual Internet Connection Setup** to manually configure your Network Camera and skip to "Network Setup" on page 45.

To quickly configure your Network Camera's motion detection settings, click **Motion Detection Setup Wizard**. If you want to enter your settings without running the wizard, click **Manual Motion Detection Setup** and skip to "Motion Detection" on page 55.

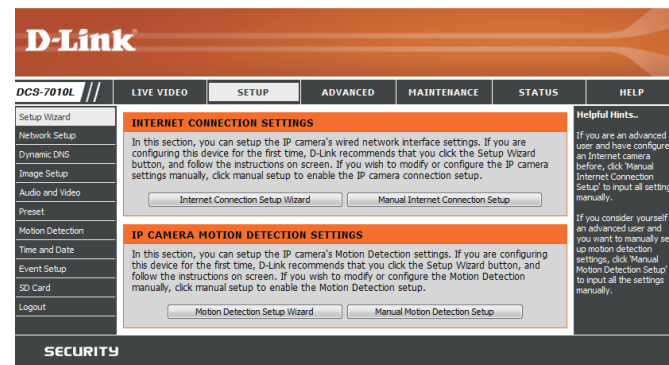

Internet Connection Setup Wizard

This wizard will guide you through a step-by-step process to configure your new D-Link Camera and connect the camera to the internet. Click **Next** to continue.

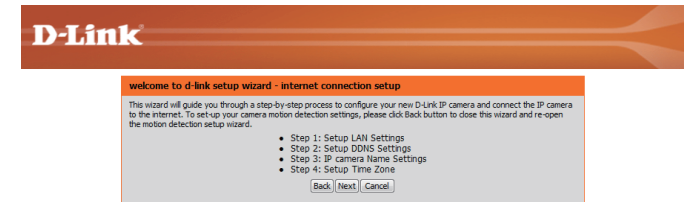

Note: Select DHCP if you are unsure of which settings to choose.

Click **Next** to continue.

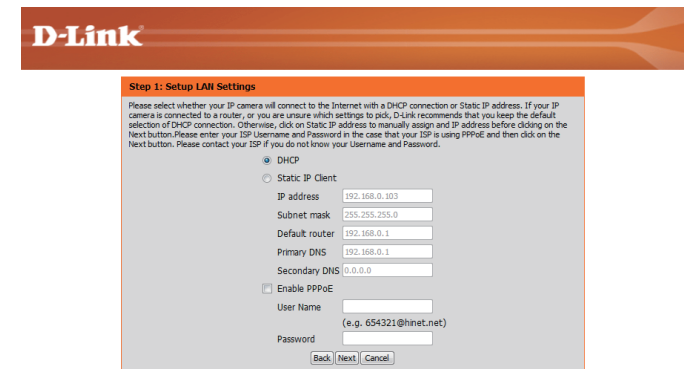

Section 4: Configuration

Select **Static IP** if your Internet Service Provider has provided you with connection settings, or if you wish to set a static address within your home network. Enter the correct configuration information and click **Next** to continue.

If you are using PPPoE, select **Enable PPPoE** and enter your user name and password, otherwise click **Next** to continue.

If you have a Dynamic DNS account and would like the camera to update your IP address automatically, Select **Enable DDNS** and enter your host information. Click **Next** to continue.

Enter a name for your camera and click **Next** to continue.

D-Link

Step 1: Setup LAN Settings

Please select whether your IP camera will connect to the Internet with a DHCP connection or Static IP address. If your IP camera is connected to a router, or you are unsure which settings to pick, D-Link recommends that you keep the default selection of DHCP connection. Otherwise, click on Static IP address to manually assign and IP address before clicking on the Next button. Please enter your ISP Username and Password in the case that your ISP is using PPPoE and then click on the Next button. Please contact your ISP if you do not know your Username and Password.

DHCP
 Static IP Client

IP address
Subnet mask
Default router
Primary DNS
Secondary DNS

Enable PPPoE

User Name
(e.g. 654321@hinet.net)

Password

D-Link

Step 2: Setup DDNS Settings

If you have a Dynamic DNS account and would like the IP camera to update your IP address automatically, enable DDNS and enter in your host information below. Please click on the Next button to continue.

Enable DDNS

Server Address <<

Host Name
User Name
Password
Verify Password
Timeout (hours)

D-Link

Step 3: IP camera Name Settings

D-Link recommends that you rename your IP camera for easy accessibility. You can then identify and connect to your IP camera via this name. Please assign a name of your choice before clicking on the Next button.

IP camera Name

Section 4: Configuration

Configure the correct time to ensure that all events will be triggered as scheduled. Click **Next** to continue.

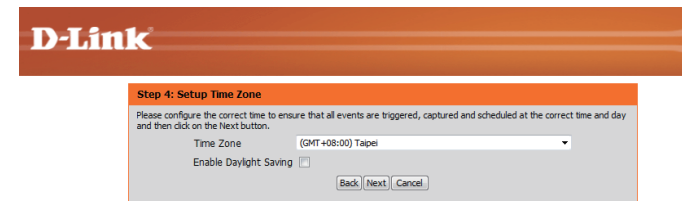

Confirm the settings are correct and click **Apply** to save them..

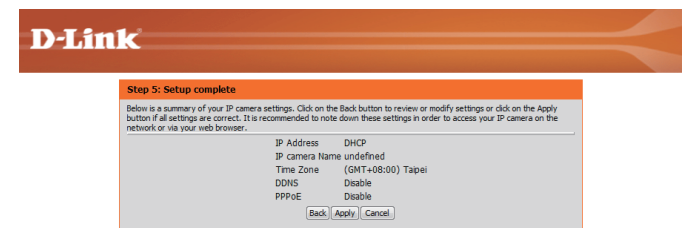

The settings will be saved to the DCS-7010L and the camera will restart.

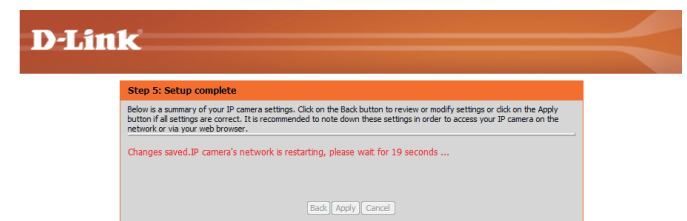

Motion Detection Setup Wizard

This wizard will guide you through a step-by-step process to configure your camera's motion detection functions.

Click **Next** to continue.

Step 1

This step will allow you to enable or disable motion detection, specify the detection sensitivity, and adjust the camera's ability to detect movement.

You may specify whether the camera should capture a snapshot or a video clip when motion is detected.

Please see the **Motion Detection** section on "Motion Detection" on page 55 for information about how to configure motion detection.

Step 2

This step allows you to enable motion detection based on a customized schedule. Specify the day and hours. You may also choose to always record whenever motion is detected.

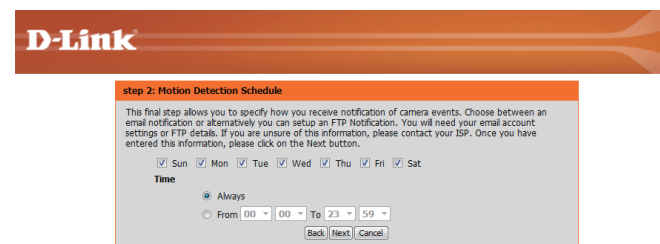
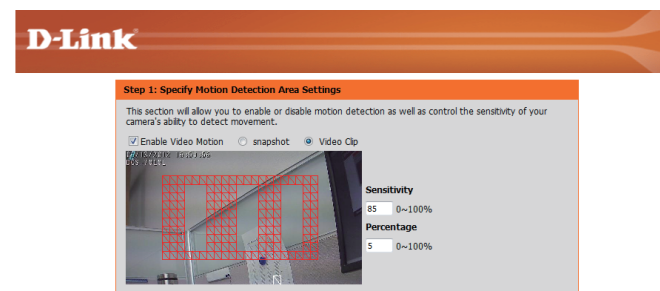
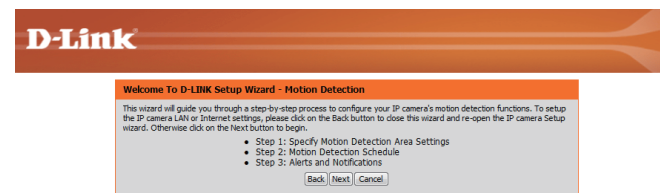

Step 3

This step allows you to specify how you will receive event notifications from your camera. You may choose not to receive notifications, or to receive notifications via e-mail or FTP.

Please enter the relevant information for your e-mail or FTP account.

Click **Next** to continue.

The screenshot shows the 'Step 3: Alerts and Notification' configuration screen. It features a D-Link logo at the top. Below the logo, there is a title bar for 'Step 3: Alerts and Notification'. The main content area contains a paragraph of instructions: 'This final step allows you to specify how you receive notification of camera events. Choose between an email notification or alternatively you can setup an FTP Notification. You will need your email account settings or FTP details. If you are unsure of this information, please contact your ISP. Once you have entered this information, please click on the Next button.' There are two radio button options: 'Do not notify me' (unselected) and 'Email' (selected). Under the 'Email' option, there are input fields for 'Sender email address', 'Recipient email address', 'Server address', 'User name', 'Password', and 'Port' (with '25' entered). Under the 'FTP' option, there are input fields for 'Server address', 'Port' (with '21' entered), 'User name', 'Password', and 'Remote folder name'. At the bottom right, there are 'Back', 'Next', and 'Cancel' buttons.

Step 4

You have completed the Motion Detection Wizard.

Please verify your settings and click **Apply** to save them.

The screenshot shows the 'Step 4: Setup Complete' configuration screen. It features a D-Link logo at the top. Below the logo, there is a title bar for 'Step 4: Setup Complete'. The main content area contains a paragraph of instructions: 'You have completed your IP camera setup. Please click the Back button if you want to review or modify your settings or click on the Apply button to save and apply your settings.' Below this, there is a summary of settings: 'Motion Detection : Enable', 'EVENT : Video Clip', 'Schedule Day : Sun , Mon , Tue , Wed , Thu , Fri , Sat ,', 'Schedule Time : Always', and 'Alerts and Notification : Email'. At the bottom right, there are 'Back', 'Apply', and 'Cancel' buttons.

Please wait a few moments while the camera saves your settings and restarts.

The screenshot shows the 'Step 4: Setup Complete' configuration screen, similar to the previous one. It features a D-Link logo at the top. Below the logo, there is a title bar for 'Step 4: Setup Complete'. The main content area contains a paragraph of instructions: 'You have completed your IP camera setup. Please click the Back button if you want to review or modify your settings or click on the Apply button to save and apply your settings.' Below this, there is a red message: 'Changes saved. IP camera's network is restarting, please wait for 6 seconds ...'. At the bottom right, there are 'Back', 'Apply', and 'Cancel' buttons.

Network Setup

Use this section to configure the network connections for your camera. All relevant information must be entered accurately. After making any changes, click the **Save Settings** button to save your changes.

LAN Settings: This section lets you configure settings for your local area network.

DHCP: Select this connection if you have a DHCP server running on your network and would like your camera to obtain an IP address automatically.

If you choose DHCP, you do not need to fill out the IP address settings.

Static IP Client: You may obtain a static or fixed IP address and other network information from your network administrator for your camera. A static IP address may simplify access to your camera in the future.

IP Address: Enter the fixed IP address in this field.

Subnet Mask: This number is used to determine if the destination is in the same subnet. The default value is 255.255.255.0.

Default Gateway: The gateway used to forward frames to destinations in a different subnet. Invalid gateway settings may cause the failure of transmissions to a different subnet.

Primary DNS: The primary domain name server translates names to IP addresses.

Secondary DNS: The secondary DNS acts as a backup to the primary DNS.

D-Link

DCS-7010L // LIVE VIDEO SETUP ADVANCED MAINTENANCE STATUS HELP

NETWORK SETUP
You can configure your LAN and Internet settings here.
Save Settings Don't Save Settings

LAN SETTINGS

DHCP

Static IP Client

IP address: 192.168.0.103
Subnet mask: 255.255.255.0
Default router: 192.168.0.1
Primary DNS: 192.168.0.1
Secondary DNS: 0.0.0.0

Enable UPnP presentation
 Enable UPnP port forwarding
Forwarding Port: 1024 (Test)
Forwarding Status: UPnP forwarding is inactive

PPPOE SETTINGS

Enable Disable
User Name:
Password:
Confirm password:
PPPOE Status: PPPOE is inactive.

HTTP

HTTP port: 80
Access name for stream1: video1.mjpg
Access name for stream2: video2.mjpg
Access name for stream3: video3.mjpg

HTTPS

HTTPS port: 443

RTSP

Authentication: Disable
RTSP port: 554
Access name for stream1: live1.sdp
Access name for stream2: live2.sdp
Access name for stream3: live3.sdp

COS SETTINGS

Enable CoS
VLAN ID: 1 [0-4095]
Live video: 0
Live audio: 0
Event/Alarm: 0
Management: 0

QOS SETTINGS

Enable QoS
Live video: 0
Live audio: 0

Helpful Hints.

Select DHCP Connection if you are running a DHCP server on your network and would like an IP address assigned to your IP camera automatically.

UPnP: Enabling UPnP settings will allow you to configure your IP camera as an UPnP device in the network.

PPPOE Setting: If you use the IP camera to connect directly to the Internet, you will need to enter the username and password which were given to you when you set up your account with your Internet Service Provider. If the camera is behind a router or a gateway, you do not need to configure this setting.

HTTP: HTTP Port is the port you allocate in order to connect to the IP camera via a standard web browser.

HTTPS: HTTPS Port in a IP camera connects it with a PC via a secure web browser.

RTSP: RTSP Port is the port you allocate in order to connect to a IP camera by using streaming mobile device(s), such as a mobile phone or PDA.

CoS (Class of Service): Coarsely-grained traffic control based on the L2 protocol. Class of Service technologies do not guarantee a level of service in terms of bandwidth and delivery time, they offer a "best-effort".

QoS (Quality of Service): Fine-grained traffic control, a resource reservation control mechanism. Quality of service guarantees are important if the network capacity is insufficient, especially for real-time streaming multimedia applications.

Enable UPnP Presentation: Enabling this setting allows your camera to be configured as a UPnP device on your network.

Enable UPnP Port Forwarding: Enabling this setting allows the camera to add port forwarding entries into the router automatically on a UPnP capable network.

Enable PPPoE: Enable this setting if your network uses PPPoE.

User Name / Password: Enter the username and password for your PPPoE account. Re-enter your password in the Confirm Password field. You may obtain this information from your ISP.

HTTP Port: The default port number is 80.

Access Name for Stream 1~3: The default name is video#.mjpg, where # is the number of the stream.

HTTPS Port: You may use a PC with a secure browser to connect to the HTTPS port of the camera. The default port number is 443.

RTSP Port: The port number that you use for RTSP streaming to mobile devices, such as mobile phones or PDAs. The default port number is 554. You may specify the address of a particular stream. For instance, live1.sdp can be accessed at rtsp://x.x.x.x/video1.sdp where the x.x.x.x represents the ip address of your camera.

LAN SETTINGS	
<input checked="" type="radio"/> DHCP	
<input type="radio"/> Static IP Client	
IP address	<input type="text" value="192.168.0.103"/>
Subnet mask	<input type="text" value="255.255.255.0"/>
Default router	<input type="text" value="192.168.0.1"/>
Primary DNS	<input type="text" value="192.168.0.1"/>
Secondary DNS	<input type="text" value="0.0.0.0"/>
<input checked="" type="checkbox"/> Enable UPnP presentation	
<input type="checkbox"/> Enable UPnP port forwarding	
Forwarding Port	<input type="text" value="1024"/> <input type="button" value="Test"/>
Forwarding Status	UPnP forwarding is inactive

PPPOE SETTINGS	
<input type="radio"/> Enable	<input checked="" type="radio"/> Disable
User Name	<input type="text"/>
Password	<input type="text"/>
Confirm password	<input type="text"/>
PPPoE Status	PPPoE is inactive.

HTTP	
HTTP port	<input type="text" value="80"/>
Access name for stream1	<input type="text" value="video1.mjpg"/>
Access name for stream2	<input type="text" value="video2.mjpg"/>
Access name for stream3	<input type="text" value="video3.mjpg"/>

HTTPS	
HTTPS port	<input type="text" value="443"/>

RTSP	
Authentication	<input type="text" value="Disable"/>
RTSP port	<input type="text" value="554"/>
Access name for stream1	<input type="text" value="live1.sdp"/>
Access name for stream2	<input type="text" value="live2.sdp"/>
Access name for stream3	<input type="text" value="live3.sdp"/>

Enable CoS: Enabling the Class of Service setting implements a best-effort policy without making any bandwidth reservations.

Enable QoS: Enabling QoS allows you to specify a traffic priority policy to ensure a consistent Quality of Service during busy periods. If the Network Camera is connected to a router that itself implements QoS, the router's settings will override the QoS settings of the camera.

Enable IPv6: Enable the IPV6 setting to use the IPV6 protocol. Enabling the option allows you to manually set up the address, specify an optional IP address, specify an optional router and an optional primary DNS.

Enable Multicast for stream The DCS-7010L allows you to multicast each of the available streams via group address and specify the TTL value for each stream. Enter the port and TTL settings you wish to use if you do not want to use the defaults.

COS SETTINGS

Enable CoS
 VLAN ID [0~4095]
 Live video
 Live audio
 Event/Alarm
 Management

QOS SETTINGS

Enable QoS
 Live video
 Live audio
 Event/Alarm
 Management

IPV6

Enable IPv6

 Manually setup the IP address
 Optional IP address / Prefix length /
 Optional default router
 Optional primary DNS

MULTICAST

Enable multicast for stream 1
 Multicast group address
 Multicast video port
 Multicast RTCP video port
 Multicast audio port
 Multicast RTCP audio port
 Multicast TTL [1~255]
 Enable multicast for stream 2
 Multicast group address
 Multicast video port
 Multicast RTCP video port
 Multicast audio port
 Multicast RTCP audio port
 Multicast TTL [1~255]
 Enable multicast for stream 3
 Multicast group address
 Multicast video port
 Multicast RTCP video port
 Multicast audio port
 Multicast RTCP audio port
 Multicast TTL [1~255]

Dynamic DNS

DDNS (Dynamic Domain Name Server) will hold a DNS host name and synchronize the public IP address of the modem when it has been modified. A user name and password are required when using the DDNS service. After making any changes, click the **Save Settings** button to save your changes.

Enable DDNS: Select this checkbox to enable the DDNS function.

Server Address: Select your Dynamic DNS provider from the pull down menu or enter the server address manually.

Host Name: Enter the host name of the DDNS server.

User Name: Enter the user name or e-mail used to connect to your DDNS account.

Password: Enter the password used to connect to your DDNS server account.

Timeout: Enter the DNS timeout values you wish to use.

Status: Indicates the connection status, which is automatically determined by the system.

The screenshot shows the D-Link DCS-7010L web interface. The main navigation bar includes 'LIVE VIDEO', 'SETUP', 'ADVANCED', 'MAINTENANCE', 'STATUS', and 'HELP'. The left sidebar lists various setup options, with 'Dynamic DNS' selected. The main content area is titled 'DYNAMIC DNS' and contains a 'DYNAMIC DNS SETTING' form. The form has the following fields and values:

- Enable DDNS:
- Server Address: <<
- Host Name:
- User Name:
- Password:
- Verify Password:
- Timeout: (hours)
- Status: Inactive

At the bottom of the form are two buttons: 'Save Settings' and 'Don't Save Settings'. To the right of the form is a 'Helpful Hints...' section with the following text:

Dynamic DNS is useful if you have a DSL or Cable service provider that changes your modem IP address periodically. This will allow you to assign a website domain name to your IP camera instead of connecting through an IP address.

Image Setup

In this section, you may configure the video image settings for your camera. A preview of the image will be shown in Live Video.

Enable Privacy Mask: The Privacy Mask setting allows you to specify up to 3 rectangular areas on the camera's image to be blocked/excluded from recordings and snapshots.

You may click and drag the mouse cursor over the camera image to draw a mask area. Right clicking on the camera image brings up the following menu options:

Disable All: Disables all mask areas

Enable All: Enables all mask areas

Reset All: Clears all mask areas.

Anti Flicker: If the video flickers, try enabling this setting.

Mirror: This will mirror the image horizontally.

Flip: This will flip the image vertically. When turning Flip on, you may want to consider turning Mirror on as well.

Power Line: Select the frequency used by your power lines to avoid interference or distortion.

White Balance: Use the drop-down box to change white balance settings to help balance colors for different environments. You can choose from Auto, Outdoor, Indoor, Fluorescent, and Push Hold.

The screenshot shows the D-Link DCS-7010L web interface. The top navigation bar includes tabs for LIVE VIDEO, SETUP, ADVANCED, MAINTENANCE, STATUS, and HELP. The main content area is titled 'IMAGE SETUP' and contains the following sections:

- PRIVACY MASK AREA OF VIDEO SETTING:** Includes a checkbox for 'Enable Privacy Mask Setting' and a live video preview. A list of instructions is provided:
 - Privacy mask: mask 3 privacy area(s) on video.
 - Click the right mouse button on the video control to show the popmenu.
 - Press the left mouse button, drag and drop to set the privacy area.
 - Privacy area can be enabled or disabled.
 - After you finish all privacy mask settings, click the Save button.
- IMAGE SETTINGS:** A list of settings with radio buttons and dropdown menus:
 - Anti Flicker: On (radio), Off (radio)
 - Mirror: On (radio), Off (radio)
 - Flip: On (radio), Off (radio)
 - Power Line: 60 Hz (radio), 50 Hz (radio)
 - White Balance: Auto (dropdown)
 - Exposure Mode: Auto (dropdown), Max Gain: 24 dB
 - Denoise: 0 (dropdown)
 - Brightness: 4 (dropdown)
 - Contrast: 4 (dropdown)
 - Saturation: 128 (dropdown)
 - Sharpness: 4 (dropdown)
- Helpful Hints...:** A sidebar containing detailed instructions for Privacy Mask, Anti Flicker, Mirror, Flip, Power Line, White Balance, Exposure Mode, Max Gain, and Denoise.

Exposure Mode: Changes the exposure mode. Use the drop-down box to set the camera for Indoor, Outdoor, or Night environments, or to Moving to capture moving objects. The Low Noise option will focus on creating a high-quality picture without noise. You can also create 3 different custom exposure modes. The Max Gain setting will allow you to control the maximum amount of gain to apply to brighten the picture.

Denoise: This setting controls the amount of noise reduction that will be applied to the picture.

Brightness: Adjust this setting to compensate for backlit subjects.

Contrast: Adjust this setting to alter the color intensity/strength.

Saturation: This setting controls the amount of coloration, from grayscale to fully saturated.

Sharpness: Specify a value from 0 to 8 to specify how much sharpening to apply to the image.

Reset Default: Click this button to reset the image to factory default settings.

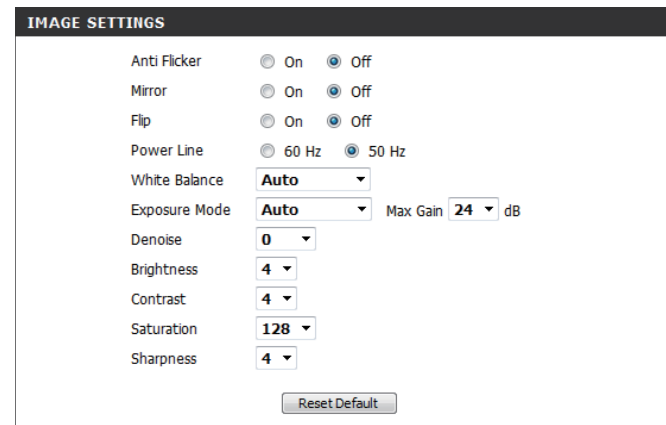

The screenshot shows the 'IMAGE SETTINGS' configuration panel. It includes the following settings:

- Anti Flicker: On Off
- Mirror: On Off
- Flip: On Off
- Power Line: 60 Hz 50 Hz
- White Balance: Auto (dropdown)
- Exposure Mode: Auto (dropdown) Max Gain: 24 dB (dropdown)
- Denoise: 0 (dropdown)
- Brightness: 4 (dropdown)
- Contrast: 4 (dropdown)
- Saturation: 128 (dropdown)
- Sharpness: 4 (dropdown)

A 'Reset Default' button is located at the bottom right of the panel.

Audio and Video

You may configure up to 3 video profiles with different settings for your camera. Hence, you may set up different profiles for your computer and mobile display. In addition, you may also configure the two-way audio settings for your camera. After making any changes, click the **Save Settings** button to save your changes.

Aspect ratio: Set the aspect ratio of the video to 4:3 standard or 16:9 widescreen.

Mode: Set the video codec to be used to JPEG, MPEG-4, or H.264.

Frame size: Frame size determines the total capture resolution, and View window area determines the Live Video viewing window size. If the Frame size is larger than the Live Video size, you can use the ePTZ controls to look around.

16:9 1280 x 800, 1280 x 720, 800 x 450,
640 x 360, 480 x 270, 320 x 176,
176 x 144

4:3 1024 x 768, 800 x 600, 640 x 480,
480 x 360, 320 x 240, 176 x 144

Note: If your View window area is the same as your Frame size, you will not be able to use the ePTZ function.

Maximum frame rate: A higher frame rate provides smoother motion for videos, and requires more bandwidth. Lower frame rates will result in stuttering motion, and requires less bandwidth.

D-Link

DCS-7010L // LIVE VIDEO SETUP ADVANCED MAINTENANCE STATUS HELP

Setup Wizard
Network Setup
Dynamic DNS
Image Setup
Audio and Video
Preset
Motion Detection
Time and Date
Event Setup
SD Card
Logout

AUDIO AND VIDEO

This section allows you to configure the sound and video of your camera. You can configure different settings depending on whether you are viewing content from a PC or a Mobile Phone / PDA.

Save Settings Don't Save Settings

VIDEO SETTINGS

Aspect ratio **16:9** Warning: Change the aspect ratio will clear the settings of privacy mask and preset and motion detection.

Save Default

VIDEO PROFILE 1

Mode **H.264**
Frame size **1280x800**
View window area **1280x800**
Maximum frame rate **25**
Video quality
Constant bit rate 1M
Fixed quality Excellent

VIDEO PROFILE 2

Mode **JPEG**
Frame size **640x360**
View window area **640x360**
Maximum frame rate **25**
Video quality **Excellent**

VIDEO PROFILE 3

Mode **H.264**
Frame size **320x176**
View window area **320x176**
Maximum frame rate **25**
Video quality
Constant bit rate 512K
Fixed quality Excellent

AUDIO SETTINGS

Encoding **6.726**
 Audio in off
Audio in gain level **20dB**
 Audio out off
Audio out volume level **10**

Save Settings Don't Save Settings

Helpful Hints.

Higher frame size, frame rate and bit rate gives better video quality. At the same time, it requires more network bandwidth.

For best viewing results on a mobile phone, we suggest setting the Frame Rate to 5fps and the Bit Rate to 64 Kbps.

Aspect Ratio: An aspect ratio is the ratio between the width and height of an image.

Mode: It can be H.264, JPEG, or MPEG4. In JPEG mode, the video frames are independent; MPEG4 consumes much less network bandwidth than JPEG, and H.264 can use less bandwidth but better image quality.

Frame Size: 7 options exist for the sizes of the video display. It is recommended using 176x144 for mobile viewing and 1280x800 for computer viewing.

View window area: The viewing region of the current video stream.

Max frame rate: The maximum number of frames that is displayed in 1 second. 30fps is the highest video quality for this camera. In general, any frame rate above 15 fps is imperceptible to the human eye.

Video Quality: This limits the maximal refresh frame rate, which can be combined with the "Fixed quality" to optimize the bandwidth utilization and video quality. If the User wants to fix the bandwidth utilization regardless of the video quality, choose "constant bit rate" and select the desired bandwidth.

Audio Settings: You can use the option to switch the external microphone on/off or adjust the volume.

Video Quality: This limits the maximum frame rate, which can be combined with the "Fixed quality" option to optimize the bandwidth utilization and video quality. If fixed bandwidth utilization is desired regardless of the video quality, choose "Constant bit rate" and select the desired bandwidth.

Constant bit rate: The bps will affect the bit rate of the video recorded by the camera. Higher bit rates result in higher video quality.

Fixed quality: Select the image quality level for the camera to try to maintain. High quality levels will result in increased bit rates.

Encoding Select the audio encoding codec to fine tune bandwidth usage, storage and recording quality.

Audio in off: Selecting this checkbox will mute incoming audio.

Audio in gain level: This setting controls the amount of gain applied to incoming audio to increase its volume.

Audio out off: Selecting this checkbox will mute outgoing audio.

Audio out volume level: This setting controls the amount of gain applied to outgoing audio to increase its volume.

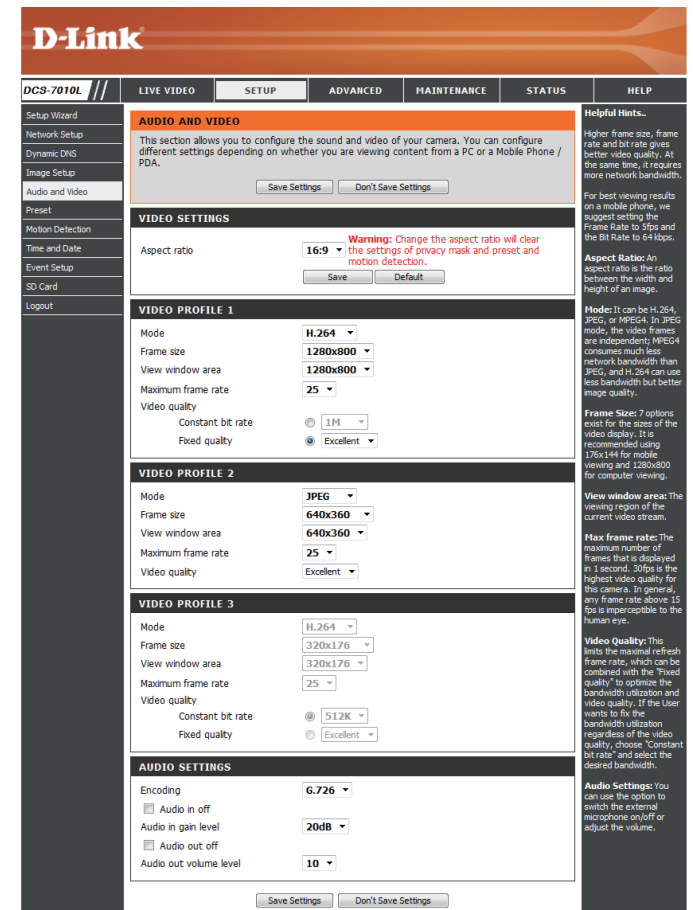

Preset

This screen allows you to set preset points for the ePTZ function of the camera, which allows you to look around the camera's viewable area by using a zoomed view. Presets allow you to quickly go to and view a specific part of the area your camera is covering, and you can create preset sequences, which will automatically change the camera's view between the different presets according to a defined order and timing you can set.

Note: If your View window area is the same as your Frame size, you will not be able to use the ePTZ function.

Video Profile: This selects which video profile to use.

ePTZ Speed: You may select a value between 0 and 64. 0 is the slowest and 64 is the fastest.

Arrow Buttons and Home Button: Use these buttons to move to a specific part of the viewing area, which you can then set as a preset. Click the Home button to return to the center of the viewing area.

Input Preset Name: Enter the name of the preset you want to create, then click the **Add** button to make a new preset. If an existing preset has been selected from the Preset List, you can change its name by typing in a new name, then clicking the **Rename** button.

Preset List: Click this drop-down box to see a list of all the presets that have been created. You can select one, then click the **GoTo** button to change the displayed camera view to the preset. Clicking the **Remove** button will delete the currently selected preset.

Preset Sequence: This section allows you to create a preset sequence, which automatically moves the camera's view between a set of preset views.



Preset List: To add a preset to the sequence, select it from the drop-down box at the bottom of this window, set the **Dwell time** to determine how long the camera view will stay at that preset, then click the **Add** button. The preset name will appear in the list, followed by the dwell time to view that preset for.

You can rearrange your presets in the sequence by selecting a preset in the sequence, then clicking the arrow buttons to move it higher or lower in the current sequence.

Clicking the trash can button will remove the currently selected preset from the sequence.

If you want to change the dwell time for a preset, select it from the list, enter a new dwell time, then click the **Update** button.

The screenshot displays two main sections of the configuration interface:

- PRESET:** This section contains an input field for "Input Preset Name" with an "Add" button and a "Rename" button. Below it is a "Preset List" dropdown menu with a "GoTo" button and a "Remove" button. A red note indicates "Support(0-9,A-Z,a-z,-,*,/,_)".
- PRESET SEQUENCE:** This section shows a "Preset Name : Dwell time" label above a large empty box. To the right of the box are three vertical buttons: an up arrow, a trash can, and a down arrow. Below the box is a "Preset List" dropdown menu with an "Add" button, and a "Dwell time : 10" input field with an "Update" button. A red note indicates "Second(s)[3-30]".

Motion Detection

Enabling Video Motion will allow your camera to use the motion detection feature. You may draw a finite motion area that will be used for monitoring. After making any changes, click the **Save Settings** button to save your changes.

Enable Video Motion: Select this box to enable the motion detection feature of your camera.

Sensitivity: Specifies the measurable difference between two sequential images that would indicate motion. Please enter a value between 0 and 100.

Percentage: Specifies the amount of motion in the window being monitored that is required to initiate an alert. If this is set to 100%, motion is detected within the whole window will trigger a snapshot.

Draw Motion Area: Draw the motion detection area by dragging your mouse in the window (indicated by the red square).

Erase Motion Area: To erase a motion detection area, simply click on the red square that you wish to remove.

Right clicking on the camera image brings up the following menu options:

Select All: Draws a motion detection area over the entire screen.

Clear All: Clears any motion detection areas that have been drawn.

Restore: Restores the previously specified motion detection areas.

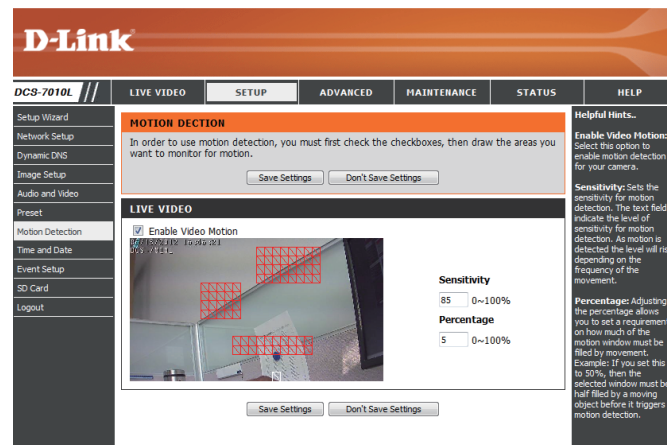

Time and Date

This section allows you to automatically or manually configure, update, and maintain the internal system clock for your camera. After making any changes, click the **Save Settings** button to save your changes.

Time Zone: Select your time zone from the drop-down menu.

Enable Daylight Saving: Select this to enable Daylight Saving Time.

Auto Daylight Saving: Select this option to allow your camera to configure the Daylight Saving settings automatically.

Set Date and Time Manually: Selecting this option allows you to configure the Daylight Saving date and time manually.

Offset: Sets the amount of time to be added or removed when Daylight Saving is enabled.

Synchronize with NTP Server: Enable this feature to obtain time automatically from an NTP server.

NTP Server: Network Time Protocol (NTP) synchronizes the DCS-7010L with an Internet time server. Choose the one that is closest to your location.

Set the Date and Time Manually: This option allows you to set the time and date manually.

Copy Your Computer's Time Settings: This will synchronize the time information from your PC.

DCS-7010L // LIVE VIDEO SETUP ADVANCED MAINTENANCE STATUS HELP

TIME AND DATE
You can set the current time for the IP camera.
Save Settings Don't Save Settings

TIME CONFIGURATION
Time Zone: GMT+08:00 Taipei
 Enable Daylight Saving
 Auto Daylight Saving
 Set date and time manually
 Offset: +2:00
 Start time: 5:00 Sunday
 End time: 10:00 Sunday

AUTOMATIC TIME CONFIGURATION
 Synchronize with NTP Server
 NTP Server: ntp.dlink.com.tw << Select NTP Server >>

SET DATE AND TIME MANUALLY
 Set date and time manually
 Year: 2012 Month: 6 Day: 7
 Hour: 10 Minute: 20 Second: 34
 Copy Your Computer's Time Settings

Save Settings Don't Save Settings

Helpful Hints.
Good timekeeping is important for accurate logs and scheduled renewal rules.
Time Zone: Select your time zone from the drop-down menu.
Enable Daylight Saving: Select this to enable the daylight saving time.
Auto Daylight Saving: When you select it, the clock is automatically adjusted according to the daylight saving time of the selected time zone.
Offset: Select the time offset, if your location observes daylight saving time.
Synchronize with NTP Server: With the option selected, the camera will synchronize the time settings with the NTP server over the Internet whenever the camera starts up. If the timeserver cannot be reached, no time settings will be applied.
NTP Server: Network Time Protocol (NTP) synchronizes the IP camera with an Internet time server. Choose the one that is closest to your location.
Copy Your Computer's Time Settings: This will synchronize the time information from your PC.

Event Setup

In a typical application, when motion is detected, the DCS-7010L sends images to a FTP server or via e-mail as notifications. As shown in the illustration below, an event can be triggered by many sources, such as motion detection. When an event is triggered, a specified action will be performed. You can configure the Network Camera to send snapshots or videos to your e-mail address or FTP site.

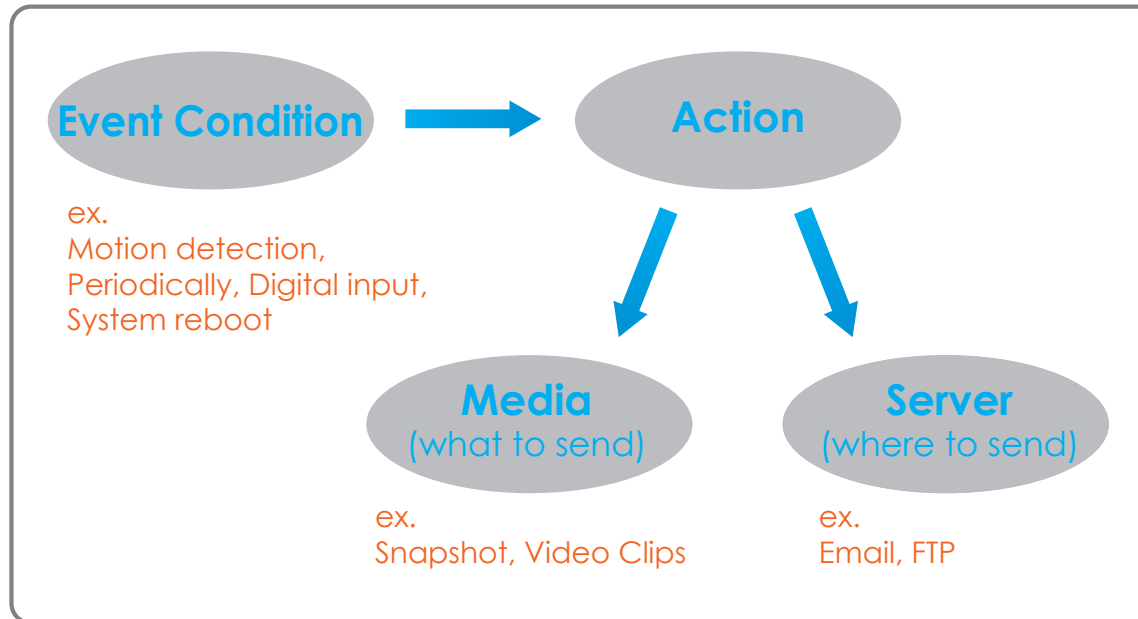

To start plotting an event, it is suggested to configure server and media columns first so that the Network Camera will know what action shall be performed when a trigger is activated.

The Event Setup page includes 4 different sections.

- Event
- Server
- Media
- Recording

1. To add a new item - "event, server or media," click **Add**. A screen will appear and allow you to update the fields accordingly.
2. To delete the selected item from the pull-down menu of event, server or media, click **Delete**.
3. Click on the item name to pop up a window for modifying.

D-Link

DCS-7010L // LIVE VIDEO SETUP ADVANCED MAINTENANCE STATUS HELP

Setup Wizard
Network Setup
Dynamic DNS
Image Setup
Audio and Video
Preset
Motion Detection
Time and Date
Event Setup
SD Card
Logout

EVENT SETUP

There are four sections in Event Setup page. They are event, server, media and recording. Click Add to pop a window to add a new item of event, server, media or recording. Click Delete to delete the selected item from event, server, media or recording. Click on the item name to pop a window to edit it. There can be at most 2 events and 1 recording. There can be at most 5 server and 5 media configurations.

SERVER

Name	Type	Address/Location
Add	▼	Delete

MEDIA

Media freespace: 6700KB

Name	Type	Source
Add	▼	Delete

EVENT

Name	Status	Sun	Mon	Tue	Wed	Thu	Fri	Sat	Time	Trigger
Add	▼									

RECORDING

Name	Status	Sun	Mon	Tue	Wed	Thu	Fri	Sat	Time	Source	Destination
Add	▼										

Helpful Hints.

Suggest setting server and media first before setting event. The servers and media which selected in event list are not be able to modify or delete. Please remove them first from the event if you want to delete or modify them. Recommend using different media in different event to make use all media be produced and received correctly. If using the same media in different events and the events trigger almost simultaneously, the servers in the second triggered event will not receive any media; there would be only notifications.

Add Server

You can configure up to 5 servers to save snapshots and/or video to. After making any changes, click the **Save Settings** button to save your changes.

Server Name: Enter the unique name of your server.

E-mail: Enter the configuration for the target e-mail server account.

FTP: Enter the configuration for the target FTP server account.

Network Storage: Specify a network storage device. Only one network storage device is supported.

SD Card: Use the camera's onboard SD card storage.

D-Link

DCS-7010L // LIVE VIDEO SETUP ADVANCED MAINTENANCE STATUS HELP

SERVER

You can set at most 5 different servers here for different event.

[Test] [Save Settings] [Don't Save Settings]

SERVER TYPE

Server Name:

Email

Sender email address

Recipient email address

Server address

User name

Password

Port

This server requires a secure connection (StartTLS)

FTP

Server address

Port

User name

Password

Remote folder name

Passive mode

Network storage

Network storage location

(for example: \\my_nas\disk\folder)

Workgroup

User name

Password

Primary WINS server

SD Card

[Test] [Save Settings] [Don't Save Settings]

Helpful Hints...

Server name The unique name for server. There are four kinds of servers supported. They are email server, FTP server, HTTP server and network storage.

Sender email address The email address of the sender.

Recipient email address The email address of the recipient.

FTP server: "Remote folder name" Granted folder on the external FTP server. The string must conform to that of the external FTP server. Some FTP servers cannot accept preceding slash symbol before the path without virtual path mapping. Refer to the instructions for the external FTP server for details. The folder privilege must be open for upload.

Passive Mode Check it to enable passive mode in transmission.

Network storage: Only one network storage is supported.

Network storage location The path to upload the media.

Workgroup The workgroup for network storage.

SD card: Use the SD card for recording media.

Add Media

There are three types of media, **Snapshot**, **Video Clip**, and **System Log**. After making any changes, click the **Save Settings** button to save your changes.

Media Name: Enter a unique name for media type you want to create.

Snapshot: Select this option to set the media type to snapshots.

Source: Set the video profile to use as the media source. Refer to **Audio and Video** on "Audio and Video" on page 51 for more information on video profiles.

Send pre-event image(s) [0~4]: Set the number of pre-event images to take. Pre-event images are images taken before the main event snapshot is taken.

Send post-event image(s) [0~7]: Set the number of post-event images to take. Post-event images are images taken after the main event snapshot is taken. You can set up to 7 post-event images to be taken.

File name prefix: The prefix name will be added on the file name.

Add date and time suffix to file name: Check it to add timing information as file name suffix.

Video clip: Select this option to set the media type to video clips.

Source: Set the video profile to use as the media source. Refer to "Audio and Video" on page 51 for more information on video profiles.

Pre-event recording: This sets how many seconds to record before the main event video clip starts. You can record up to 4 seconds of pre-event video.

Maximum duration: Set the maximum length of video to record for your video clips.

Maximum file size: Set the maximum file size to record for your video clips.

File name prefix: This is the prefix that will be added to the filename of saved video clips.

System log: Select this option to set the media type to system logs. This will save the event to the camera system log, but will not record any snapshots or video.

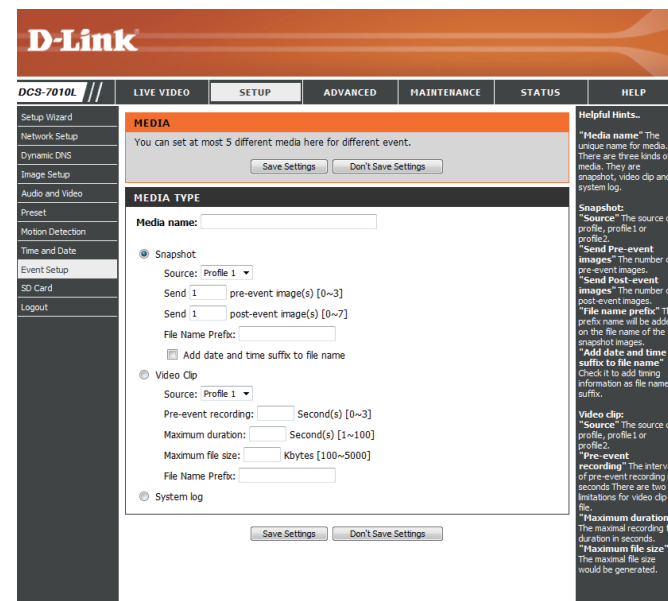

Add Event

Create and schedule up to 2 events with their own settings here. After making any changes, click the **Save Settings** button to save your changes.

Event name: Enter a name for the event.

Enable this event: Select this box to activate this event.

Priority: Set the priority for this event. The event with higher priority will be executed first.

Delay: Select the delay time before checking the next event. It is being used for both events of motion detection and digital input trigger.

Trigger: Specify the input type that triggers the event.

Digital Input: Initiates recording after receiving a digital input event.

Video Motion Detection: Motion is detected during live video monitoring. Select the windows that need to be monitored.

Periodic: The event is triggered in specified intervals. The trigger interval unit is in minutes.

System Boot: Triggers an event when the system boots up.

Network Lost: Triggers an event when the network connection is lost.

Time: Select **Always** or enter the time interval.

Server: Specify the location where the event information should be saved to.

Add Recording

Here you can configure and schedule the recording settings. After making any changes, click the **Save Settings** button to save your changes.

Recording entry name: The unique name of the entry.

Enable this recording: Select this to enable the recording function.

Priority: Set the priority for this entry. The entry with a higher priority value will be executed first.

Source: The source of the stream.

Recording schedule: Scheduling the recording entry.

Recording settings: Configuring the setting for the recording.

Destination: Select the folder where the recording file will be stored.

Total cycling recording size: Please input a HDD volume between 1MB and 2TB for recording space. The recording data will replace the oldest record when the total recording size exceeds this value. For example, if each recording file is 6MB, and the total cyclical recording size is 600MB, then the camera will record 100 files in the specified location (folder) and then will delete the oldest file and create new file for cyclical recording.

Please note that if the free HDD space is not enough, the recording will stop. Before you set up this option please make sure your HDD has enough space, and it is better to not save other files in the same folder as recording files.

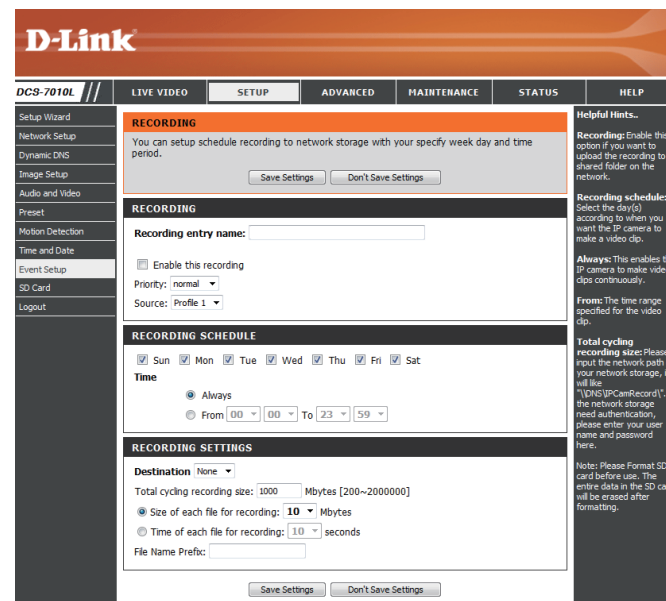

Size of each file for recording: If this is selected, files will be separated based on the file size you specify.

Time of each file for recording: If this is selected, files will be separated based on the maximum length you specify.

File Name Prefix: The prefix name will be added on the file name of the recording file(s).

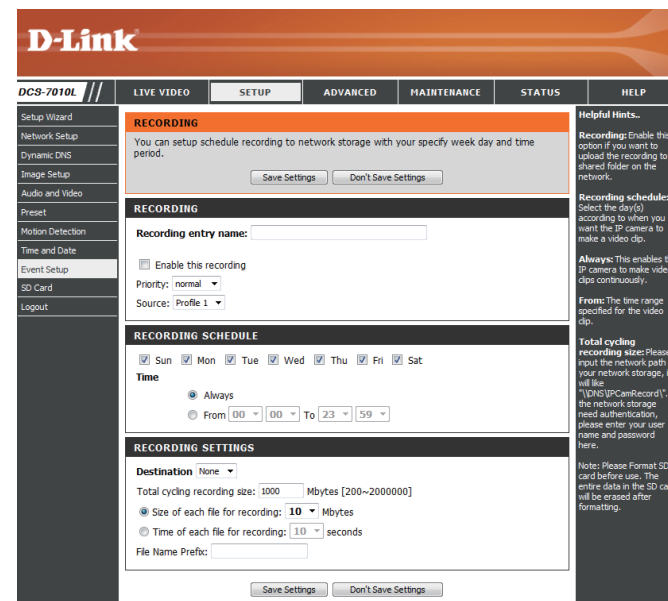

SD Card

Here you may browse and manage the recorded files which are stored on the SD card.

Format SD Card: Click this icon to automatically format the SD card and create "picture" & "video" folders.

View Recorded Picture: If the picture files are stored on the SD card, click on the picture folder and choose the picture file you would like to view.

Playback Recorded Video: If video files are stored on the SD card, click on the video folder and choose the video file you would like to view.

Refresh: Reloads the file and folder information from the SD card.

The screenshot shows the D-Link DCS-7010L web interface. The main content area is titled "SD CARD" and contains the following elements:

- Format SD Card:** A button to format the SD card and create "picture" and "video" folders.
- SD Card:** A section where you can browse and manage recorded files.
- Files per Page:** A dropdown menu set to 10, with a "Refresh" button.
- SD Status:** Ready.
- Table of Files:**

Delete	File	Num of files	Size
<input type="checkbox"/>	Video	3	
<input type="checkbox"/>	Picture	0	
- Format SD Card:** A button below the table.
- Total:** 1976528KB, Used: 1976528KB, Free: 0KB.
- OK:** A button to confirm the action.

Helpful Hint: Click this icon, system will automatically format SD card and create "picture" & "video" folders.

View recorded picture: If SD stored recorded picture files, enter picture link and choose which picture file you desire to view. You will view picture via image viewer SW. (ie. Windows Image Viewer)

Playback recorded video: If SD stored recorded video files, enter video link and choose which video file you desire to playback. Windows will guide you to download video file (AVI format) so that you can playback file via video decoder SW. (ie. Windows Media Player)

Advanced Digital Input/Output

This screen allows you to control the behavior of digital input and digital output devices. The I/O connector provides the physical interface for digital output (DO) and digital input (DI) that is used for connecting a variety of external alarm devices such as IR-Sensors and alarm relays. The digital input is used for connecting external alarm devices and once triggered images will be taken and e-mailed. After making any changes, click the **Save Settings** button to save your changes.

Select D/I or D/O Mode: The camera will send a signal when an event is triggered, depending upon the type of device connected to the DI circuit.

N.C. stands for **Normally Closed**. This means that the normal state of the circuit is closed. Therefore events are triggered when the device status changes to "Open."

N.O. stands for **Normally Open**. This means that the normal state of the circuit is open. Therefore events are triggered when the device status changes to "Closed."

LED: You may specify whether or not to illuminate the status LED on the camera.



ICR and IR

Here you can configure the ICR and IR settings. An IR(Infrared) Cut-Removable(ICR) filter can be disengaged for increased sensitivity in low light environments.

Automatic: The Day/Night mode is set automatically. Generally, the camera uses Day mode and switches to Night mode when needed.

Day Mode: Day mode enables the IR Cut Filter.

Night Mode: Night mode disables the IR Cut Filter.

Schedule Mode: Set up the Day/Night mode using a schedule. The camera will enter Day mode at the starting time and return to Night mode at the ending time.

IR Light Control: The camera can enable or disable the IR (infrared) light according to your preferences. This setting provides additional controls depending on your specific application.

Off: The IR light will always be off.

On: The IR light will always be on.

Sync: The IR light will turn on when the ICR sensor is on.

Schedule: The IR light will turn on or off according to the schedule that you specify below.

D-Link

DCS-7010L // LIVE VIDEO SETUP ADVANCED MAINTENANCE STATUS HELP

ICR AND IR

An IR(Infrared) Cut-Removable(ICR) filter can be disengaged from the image path for increased sensitivity in low light environments. The ICR filter will automatically engage depending on the ambient light, allowing the camera to be effective in day/night environments.

- Select the Day/Night from the radio button. The available options are Automatic, Schedule mode, Day mode and Night mode.
- The default value is Automatic.

Light Sensor Sensitivity
Light sensor sensitivity has Low, Medium, and High three different levels. You may get current camera light illumination by clicking Refresh button to set proper level of Light sensor sensitivity. For example, when level sets at High less than 30lux, camera will switch Day & Night mode to Night mode.

IR Light
The built-in IR light illuminators will be activated automatically or manually so as to supplement the low light situation without additional equipment.

Save Settings Don't Save Settings

ICR

Removable IR-Cut filter trigger condition:

Automatic Sensitivity: Medium: <20lux 10~20 lux Refresh

Day mode

Night mode

Schedule mode

Day mode(24hr)
From 07 To 18

IR LIGHT

IR Light Control Medium: 20m

Off

On

Sync. With ICR

Schedule

IR Light Control On(24hr)
From 07 To 18

Save Settings Don't Save Settings

Helpful Hints...

Automatic: The day/Night mode is set automatically. It is normally set in the Day mode and changes to the Night mode in a dark place.

Day mode: The Day mode means disable the IR Cut Filter.

Night mode: The Night mode means enable the IR Cut Filter.

Schedule mode: Set the Day/Night mode using the schedule. Fill in the time so the Day/Night mode is normally set to Day mode and it enters the Day mode at the start time and returns to the Night mode at the end time.

IR Light Control: In poor light conditions, open IR Light Control to automatically turn on the light to enable you to take clear picture. The IR Light Control has 4 options: Off, On, Sync. with ICR, and Schedule. Off: This option disable the IR Light Control. On: This option automatically opens the IR Light Control to enable a camera to take clear images in poor light conditions. Sync. with ICR: In this option, the IR Light Control will open automatically and follow the ICR setting. Schedule: In this option, you have to customize the setting to set the time period you want. Please set the Start time and the End time of your chosen schedule.

HTTPS

This page allows you to install and activate an HTTPS certificate for secure access to your camera. After making any changes, click the **Save Settings** button to save your changes.

Enable HTTPS Secure Connection: Enable the HTTPS service.

Create Certificate Method: Choose the way the certificate should be created. Three options are available:

Create a self-signed certificate automatically
 Create a self-signed certificate manually
 Create a certificate request and install

Status: Displays the status of the certificate.

Note: The certificate cannot be removed while the HTTPS is still enabled. To remove the certificate, you must first uncheck **Enable HTTPS secure connection**.

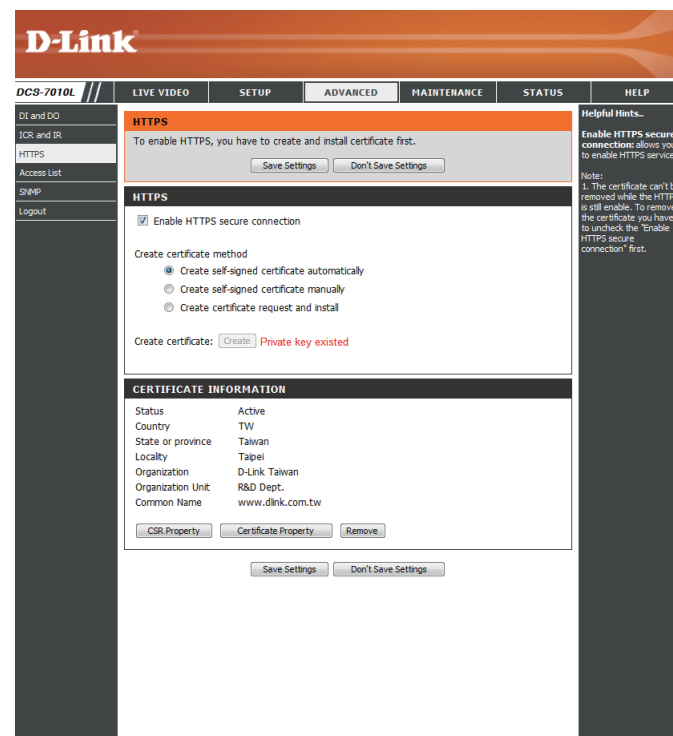

Access List

Here you can set access permissions for users to view your DCS-7010L.

Allow list: The list of IP addresses that have the access right to the camera.

Start IP address: The starting IP Address of the devices (such as a computer) that have permission to access the video of the camera. Click **Add** to save the changes made.

Note: A total of seven lists can be configured for both columns.

End IP address: The ending IP Address of the devices (such as a computer) that have permission to access the video of the camera.

Delete allow list: Remove the customized setting from the Allow List.

Deny list: The list of IP addresses that have no access rights to the camera.

Delete deny list: Remove the customized setting from the Delete List.

For example:

When the range of the Allowed List is set from 1.1.1.0 to 192.255.255.255 and the range of the Denied List is set from 1.1.1.0 to 170.255.255.255. Only users with IPs located between 171.0.0.0 and 192.255.255.255 can access the Network Camera.

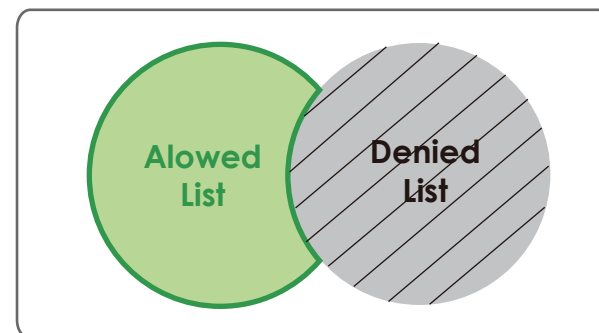

SNMP

Here you can enable and name SNMP settings.

Enable SNMP: Enable this option to allow local SNMP management.

Read/Write Community Enter a name for the read community of your SNMP server.

Read Only Community Enter a name for the write community of your SNMP server.

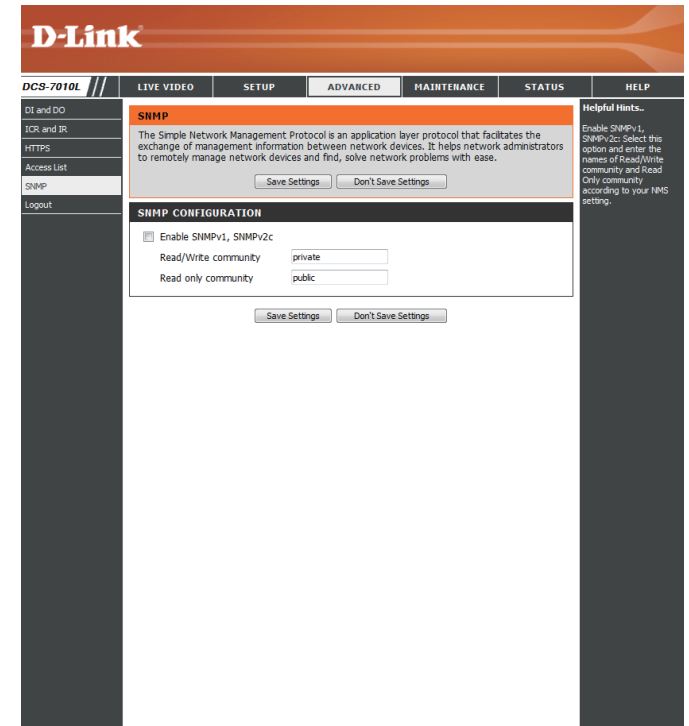

Maintenance

Device Management

You may modify the name and administrator's password of your camera, as well as add and manage the user accounts for accessing the camera. You may also use this section to create a unique name and configure the OSD settings for your camera.

Admin Password Setting: Set a new password for the administrator's account.

Add User Account: Add new user account.

User Name: The user name for the new account.

Password: The password for the new account.

User List: All the existing user accounts will be displayed here. You may delete accounts included in the list, but you may want to reserve at least one as a guest account.

Camera Name: Create a unique name for your camera that will be added to the file name prefix when creating a snapshot or a video clip.

Enable OSD: Select this option to enable the On-Screen Display feature for your camera.

Label: Enter a label for the camera, which will be shown on the OSD when it is enabled.

Show Time: Select this option to enable the time-stamp display on the video screen.

D-Link

DCS-7010L // LIVE VIDEO SETUP ADVANCED MAINTENANCE STATUS HELP

ADMIN

Here you can change the administrator's password for your IP camera as well as add and/or delete user account(s). You can configure the information, such as IP camera's name and time via this page. You can also enable the OSD (On-Screen Display) feature in order to display the IP camera name and time stamp for your video recordings.

ADMIN PASSWORD SETTING

New Password 63 characters maximum

Retype Password

ADD USER ACCOUNT

User Name 20 users maximum

New Password 63 characters maximum

Retype Password

USER LIST

User Name -- User list --

DEVICE SETTING

IP camera Name DCS-7010L 63 characters maximum

Enable OSD

Label DCS-7010L 63 characters maximum

Show time

Helpful Hints...

Enabling OSD, the IP camera name and time will be displayed on the video screen for the user.

For security purposes, it is recommended that you change the password for your administrator account. Be sure to write down the new password to avoid having to reset the IP camera in the event that it is forgotten.

System

In this section, you may backup, restore and reset the camera configuration, or reboot the camera.

Save To Local Hard Drive: You may save your current camera configuration as a file on your computer.

Load From Local Hard Drive: Locate a pre-saved configuration by clicking **Browse** and then restore the pre-defined settings to your camera by clicking **Load Configuration**.

Restore to Factory Default: You may reset your camera and restore the factory settings by clicking **Restore Factory Defaults**.

Reboot Device: This will restart your camera.



Firmware Upgrade

The camera's current firmware version will be displayed on this screen. You may visit the D-Link Support Website to check for the latest available firmware version.

To upgrade the firmware on your DCS-7010L, please download and save the latest firmware version from the D-Link Support Page to your local hard drive. Locate the file on your local hard drive by clicking the **Browse** button. Select the file and click the **Upload** button to start upgrading the firmware.

Current Firmware Version: Displays the detected firmware version.

Current Product Name: Displays the camera model name.

File Path: Locate the file (upgraded firmware) on your hard drive by clicking **Browse**.

Upload: Uploads the new firmware to your camera.



Status

Device Info

This page displays detailed information about your device and network connection.

The screenshot shows the D-Link web interface for the DCS-7010L camera. The top navigation bar includes links for LIVE VIDEO, SETUP, ADVANCED, MAINTENANCE, STATUS (selected), and HELP. The left sidebar contains links for Device Info (selected), Log, and Logout. The main content area is titled "DEVICE INFO" and contains a message: "All of your network connection details are displayed on this page. The firmware version is also displayed here." Below this is an "INFORMATION" table with the following data:

INFORMATION	
IP camera Name	DCS-7010L
Time & Date	Thu Jun 7 10:24:08 2012
Firmware Version	0.01.11
MAC Address	F0:7D:68:0F:DD:76
IP Address	192.168.0.104
IP Subnet Mask	255.255.255.0
Default Gateway	192.168.0.1
Primary DNS	192.168.0.1
Secondary DNS	0.0.0.0
PPPoE	Disable
DDNS	Disable
Agent Version	2.0.15-b6

On the right side, there is a "Helpful Hints.." section with the text: "This page displays all the information about the IP camera and network settings."

Logs

This page displays the log information of your camera. You may download the information by clicking **Download**. You may also click **Clear** to delete the saved log information.

D-Link

DCS-7010L // LIVE VIDEO SETUP ADVANCED MAINTENANCE STATUS HELP

Device Info
Log
Logout

SYSTEM LOG
The system log records IP camera events that have occurred.

CURRENT LOG

1. 2012-06-07 10:15:38 admin LOGIN OK FROM 192.168.0.100
2. 2012-06-06 19:15:05 SYSTEM SET IR LIGHT ON
3. 2012-06-06 19:14:29 SYSTEM SET IR LIGHT OFF
4. 2012-06-06 19:14:04 SYSTEM SET IR LIGHT ON
5. 2012-06-06 19:13:51 SYSTEM SET IR LIGHT OFF
6. 2012-06-06 18:40:59 admin LOGIN OK FROM 192.168.0.100
7. 2012-06-06 18:39:58 IP CAMERA ACQUIRE DHCP IP 192.168.0.104
8. 2012-06-06 18:39:54 SYSTEM SET IR LIGHT ON
9. 2012-06-06 18:39:54 SYSTEM BOOTING
10. 2012-06-06 18:39:22 Hardware Restore Factory Default
11. 2012-06-06 18:36:49 admin FROM 192.168.0.100 SET VIDEO CODEC Need Reset
12. 2012-06-06 18:36:49 admin FROM 192.168.0.100 SET PROFILE 1 Viewer window area 800x600
13. 2012-06-06 18:36:49 admin FROM 192.168.0.100 SET PROFILE 1 Frame Size 800x600
14. 2012-06-06 18:36:31 admin FROM 192.168.0.100 SET VIDEO CODEC Need Reset
15. 2012-06-06 18:36:31 admin FROM 192.168.0.100 SET ASPECT RATIO 4:3
16. 2012-06-06 18:35:22 SYSTEM SET IR LIGHT ON
17. 2012-06-06 18:35:02 SYSTEM SET IR LIGHT OFF
18. 2012-06-06 18:29:46 admin LOGIN OK FROM 192.168.0.100
19. 2012-06-06 18:27:37 IP CAMERA ACQUIRE DHCP IP 192.168.0.104
20. 2012-06-06 18:27:31 NETWORK RECONNECT

First Page Previous 20 Next 20

Clear Download

Helpful Hints..
You can save the log to your local hard IP camera by clicking the Download button, and you can clear the log by clicking on the Clear button.

Help

This page provides helpful information regarding camera operation.

The screenshot shows the D-Link DCS-7010L web interface. At the top is the D-Link logo. Below it is a navigation bar with tabs for LIVE VIDEO, SETUP, ADVANCED, MAINTENANCE, STATUS, and HELP. The HELP tab is selected. On the left side, there is a sidebar with 'Help' and 'Logout' links. The main content area is titled 'HELP' and contains a list of links for each menu item: LIVE VIDEO (Camera), SETUP (Setup Wizard, Network Setup, Dynamic DNS, Image Setup, Audio and Video, Preset, Motion Detection, Time and Date, Event Setup, SD Card), ADVANCED (DI and DO, ICR and IR, HTTPS, Access List), MAINTENANCE (Admin, System, Firmware Upgrade), and STATUS (Device Info, Log). At the bottom of the page, there is a 'SECURITY' section.

D-Link

DCS-7010L // LIVE VIDEO SETUP ADVANCED MAINTENANCE STATUS HELP

Help
Logout

HELP

- [LIVE VIDEO](#)
- [SETUP](#)
- [MAINTENANCE](#)
- [ADVANCED](#)
- [STATUS](#)

LIVE VIDEO

- [Camera](#)

SETUP

- [Setup Wizard](#)
- [Network Setup](#)
- [Dynamic DNS](#)
- [Image Setup](#)
- [Audio and Video](#)
- [Preset](#)
- [Motion Detection](#)
- [Time and Date](#)
- [Event Setup](#)
- [SD Card](#)

ADVANCED

- [DI and DO](#)
- [ICR and IR](#)
- [HTTPS](#)
- [Access List](#)

MAINTENANCE

- [Admin](#)
- [System](#)
- [Firmware Upgrade](#)

STATUS

- [Device Info](#)
- [Log](#)

SECURITY

DI/DO Specifications

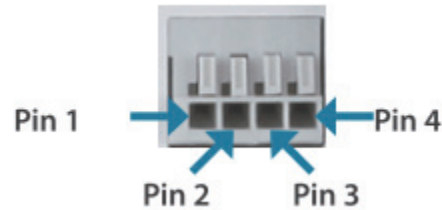

PIN	FUNCTION	NOTE
1	Digital Out (DO)	Uses an open-drain NFET transistor with the source connected to GND in camera. If used with an external relay, a diode must be connected in parallel with the load for protection against voltage transients. Max loading is 100 mA.
2	Digital In (DI)	A switch from DI to DC 5 V, activated by setting NO. or NC.
3	DC5V OUTPUT	DC 5 V Output / Max. 100 mA
4	GND	GND

Internal 5V Power

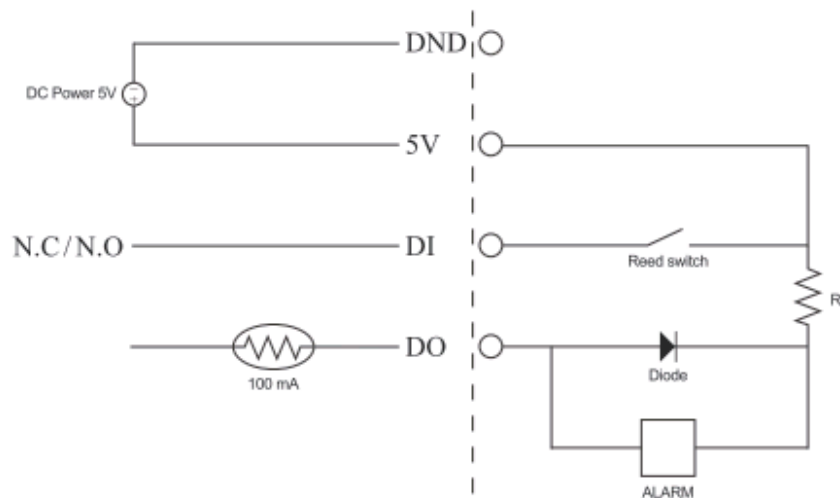

External 3~12V Power

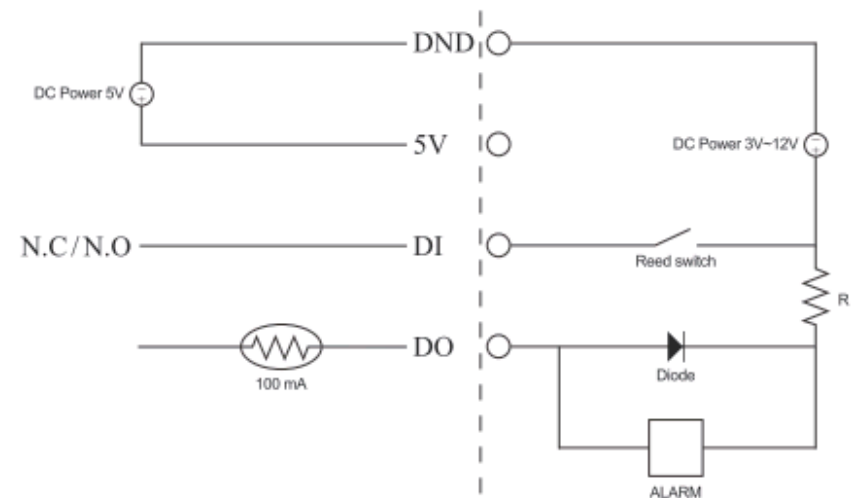

Technical Specifications

Camera	Camera Hardware Profile	<ul style="list-style-type: none"> ▪ 1/4" Megapixel progressive CMOS sensor ▪ 10 meter IR illumination distance ▪ Minimum illumination: 0 lux with IR LED on ▪ Built-in Infrared-Cut Removable (ICR) Filter module ▪ 10x digital zoom 	<ul style="list-style-type: none"> ▪ Focal length: 4.3 mm ▪ Aperture: F2.0 ▪ Angle of view: <ul style="list-style-type: none"> ▪ (D) 60° ▪ (H) 47° ▪ (V) 37°
	Camera Housing	IP-66 compliant weatherproof housing	Wire-in bracket
	Image Features	<ul style="list-style-type: none"> ▪ Configurable image size, quality, frame rate, and bit rate ▪ Time stamp and text overlays ▪ Configurable motion detection windows 	<ul style="list-style-type: none"> ▪ Configurable privacy mask zones ▪ Configurable shutter speed, brightness, saturation, contrast, and sharpness
	Video Compression	<ul style="list-style-type: none"> ▪ Simultaneous H.264/MPEG-4/MJPEG format compression ▪ H.264/MPEG-4 multicast streaming 	<ul style="list-style-type: none"> ▪ JPEG for still images
	Video Resolution	16:9 - 1280 x 800, 1280 x 720, 800 x 450, 640 x 360, 480 x 270, 320 x 176, 176 x 144	4:3 - 1024 x 768, 800 x 600, 640 x 480, 480 x 360, 320 x 240, 176 x 144
	Audio Support	G.726	G.711
	External Device Interface	<ul style="list-style-type: none"> ▪ 10/100 BASE-TX Fast Ethernet port ▪ Supports 802.3af PoE 	<ul style="list-style-type: none"> ▪ MicroSD/SDHC card slot
Network	Network Protocols	<ul style="list-style-type: none"> ▪ IPv6 ▪ IPv4 ▪ TCP/IP ▪ UDP ▪ ICMP ▪ DHCP client ▪ NTP client (D-Link) ▪ DNS client ▪ DDNS client (D-Link) ▪ SMTP client ▪ FTP client 	<ul style="list-style-type: none"> ▪ HTTP / HTTPS ▪ Samba client ▪ PPPoE ▪ UPnP port forwarding ▪ RTP / RTSP/ RTCP ▪ IP filtering ▪ QoS ▪ CoS ▪ Multicast ▪ IGMP ▪ ONVIF compliant
	Security	Administrator and user group protection Password authentication	HTTP and RTSP digest encryption

Appendix A: Technical Specifications

System Management	System Requirements for Web Interface	<ul style="list-style-type: none"> ▪ Browser: Internet Explorer, Firefox, Chrome, Safari 	
	Event Management	<ul style="list-style-type: none"> ▪ Motion detection ▪ Event notification and uploading of snapshots/video clips via e-mail or FTP 	<ul style="list-style-type: none"> ▪ Supports multiple SMTP and FTP servers ▪ Multiple event notifications ▪ Multiple recording methods for easy backup
	Remote Management	<ul style="list-style-type: none"> ▪ Take snapshots/video clips and save to local hard drive or NAS via web browser 	<ul style="list-style-type: none"> ▪ Configuration interface accessible via web browser
	Mobile Support	Windows 7/Vista/XP system, Pocket PC, or mobile phone	mydlink mobile app for iOS and Android mobile devices
	D-ViewCam™ System Requirements	<ul style="list-style-type: none"> ▪ Operating System: Microsoft Windows 7/Vista/XP ▪ Web Browser: Internet Explorer 7 or higher 	<ul style="list-style-type: none"> ▪ Protocol: Standard TCP/IP
	D-ViewCam™ Software Functions	<ul style="list-style-type: none"> ▪ Remote management/control of up to 32 cameras ▪ Viewing of up to 32 cameras on one screen 	<ul style="list-style-type: none"> ▪ Supports all management functions provided in web interface ▪ Scheduled motion triggered, or manual recording options
General	Weight	267 g +-5%	
	External Power Adapter	Input: 100 to 240 V AC, 50/60 Hz	Output: 5 V DC, 1.2 A
	Power Consumption	5.4 watts +- 5%	
	Temperature	Operating: -25 to 50 °C (-13 to 122 °F)	Storage: -20 to 70 °C (-4 to 158 °F)
	Humidity	Operating: 20% to 80% non-condensing	Storage: 5% to 95% non-condensing
	Certifications	CE CE LVD	FCC C-Tick

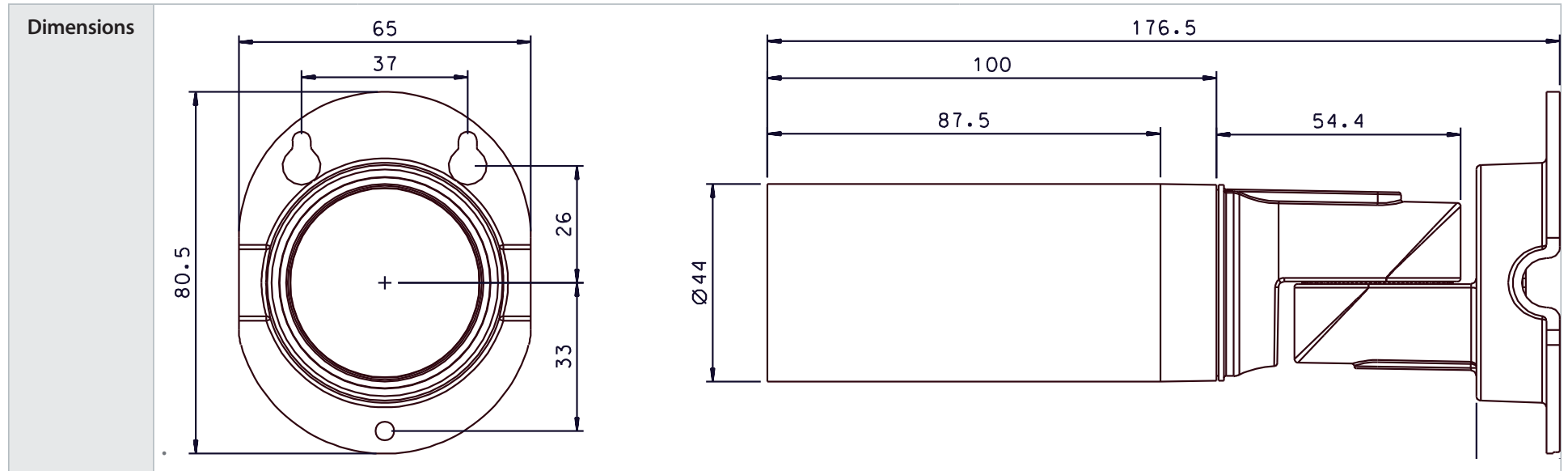

Safety Statements

CE Mark Warning:

This is a Class B product. In a domestic environment, this product may cause radio interference, in which case the user may be required to take adequate measures.

FCC Statement:

This equipment has been tested and found to comply with the limits for a Class B digital device, pursuant to part 15 of the FCC Rules. These limits are designed to provide reasonable protection against harmful interference in a residential installation. This equipment generates, uses, and can radiate radio frequency energy and, if not installed and used in accordance with the instructions, may cause harmful interference to radio communication. However, there is no guarantee that interference will not occur in a particular installation. If this equipment does cause harmful interference to radio or television reception, which can be determined by turning the equipment off and on, the user is encouraged to try to correct the interference by one or more of the following measures:

- Reorient or relocate the receiving antenna.
- Increase the separation between the equipment and receiver.
- Connect the equipment into an outlet on a circuit different from that to which the receiver is connected.
- Consult the dealer or an experienced radio/TV technician for help.

FCC Caution:

Any changes or modifications not expressly approved by the party responsible for compliance could void the user's authority to operate this equipment.

This device complies with Part 15 of the FCC Rules. Operation is subject to the following two conditions:

(1) This device may not cause harmful interference, and (2) this device must accept any interference received, including interference that may cause undesired operation.

IMPORTANT NOTICE:

FCC Radiation Exposure Statement:

This equipment complies with FCC radiation exposure limits set forth for an uncontrolled environment. This equipment should be installed and operated with minimum distance 20cm between the radiator & your body. This transmitter must not be co-located or operating in conjunction with any other antenna or transmitter.

The availability of some specific channels and/or operational frequency bands are country dependent and are firmware programmed at the factory to match the intended destination. The firmware setting is not accessible by the end user.

For detailed warranty information applicable to products purchased outside the United States, please contact the corresponding local D-Link office.

Industry Canada Notice:

This device complies with RSS-210 of the Industry Canada Rules. Operation is subject to the following two conditions:

(1) This device may not cause harmful interference, and (2) this device must accept any interference received, including interference that may cause undesired operation.

IMPORTANT NOTE:

Radiation Exposure Statement:

This equipment complies with IC radiation exposure limits set forth for an uncontrolled environment. This equipment should be installed and operated with minimum distance 20cm between the radiator & your body.