

Hardware Installation Guide

Product Model: DGS-1510 Series

Gigabit Ethernet SmartPro Switch

Release 1.60



Information in this document is subject to change without notice. Reproduction in any manner whatsoever, without the written permission of D-Link Corporation, is strictly forbidden.

Trademarks used in this text: D-Link and the D-LINK logo are trademarks of D-Link Corporation; Microsoft and Windows are registered trademarks of Microsoft Corporation.

Other trademarks and trade names may be used in this document to refer to either the entities claiming the marks and names or their products. D-Link Corporation disclaims any proprietary interest in trademarks and trade names other than its own.

© 2018 D-Link Corporation. All rights reserved.

October, 2018 P/N 651GS15100A5G

FCC Warning

This equipment has been tested and found to comply with the limits for a Class A digital device, pursuant to Part 15 of the FCC Rules. These limits are designed to provide reasonable protection against harmful interference when the equipment is operated in a commercial environment. This equipment generates, uses, and can radiate radio frequency energy and, if not installed and used in accordance with this manual, may cause harmful interference to radio communications. Operation of this equipment in a residential area is likely to cause harmful interference in which case the user will be required to correct the interference at his expense.

CE Mark Warning

This equipment is compliant with Class A of CISPR 32. In a residential environment this equipment may cause radio interference.

VCCI Warning

この装置は、クラス A 情報技術装置です。この装置を家庭環境で使用すると電波妨害を引き起こすことがあります。この場合には使用者が適切な対策を講ずるよう要求されることがあります。

VCCI-A

BSMI Notice

此為甲類資訊技術設備，於居住環境中使用時，可能會造成射頻擾動，在此種情況下，使用者會被要求採取某些適當的對策。

Safety Compliance

Warning: Class 1 Laser Product:

- **EN:** When using a fiber optic media expansion module, never look at the transmit laser while it is powered on. Also, never look directly at the fiber TX port and fiber cable ends when they are powered on.
- **FR:** Ne regardez jamais le laser tant qu'il est sous tension. Ne regardez jamais directement le port TX (Transmission) à fibres optiques et les embouts de câbles à fibres optiques tant qu'ils sont sous tension.

Table of Contents

Intended Readers	v
Typographical Conventions	v
Notes, Notices, and Cautions	v
Safety Instructions	vi
Safety Precautions.....	vi
General Precautions for Rack-Mountable Products	vii
Protecting Against Electrostatic Discharge	viii
1. Introduction	9
Switch Description	9
Package Contents.....	9
Features	9
Front-Panel Components.....	11
Ports.....	12
Reset Button	13
LED Indicators	13
Rear Panel Components.....	16
Side Panel Components	17
Smart Fans	19
2. Installation	21
Installation Guidelines.....	21
Installing the Switch without a Rack	21
Attaching Brackets to a Switch for Rack Mounting.....	21
Installing the Switch in a Standard 19" Rack.....	22
Installing Transceivers into the Transceiver Ports.....	22
Power On (AC Power)	23
Power Failure (AC Power).....	23
Installing Power Cord Clip	24
Installing the RPS into a Rack-mount Chassis	27
DPS-700	27
3. Connecting the Switch.....	29
Switch to End Node	29
Switch to another Switch.....	29
Switch to a Server.....	30
4. Introduction to Switch Management	31
Management Options.....	31
Connecting the Console Port.....	31
Connecting to the Switch for the First Time.....	33
Creating a User Account.....	34
Configuring the IP Address.....	34
SNMP Settings.....	35
Traps.....	36
Management Information Base (MIB).....	36
5. Web-based Switch Configuration.....	37
Introduction	37
Logging onto the Web Manager	37
Web-based User Interface	38
Areas of the User Interface.....	38
Appendix A – Technical Specifications	40
General	40

Physical and Environmental.....	40
Performance.....	42
LED Indicators	44
Per Switch.....	44
Per RJ45 Port	44
Per SFP Port.....	45
Per SFP+ Port.....	45
Port Functions	45
Appendix B – Cables and Connectors	48
Ethernet Cable	48
Console Cable	49
Appendix C – ERPS Information.....	52
Warranties & Technical Support.....	53

Intended Readers

Intended Readers
Typographical Conventions
Notes, Notices, and Cautions
Safety Instructions
General Precautions for Rack-Mountable Products
Protecting Against Electrostatic Discharge

The **DGS-1510 Series Hardware Installation Guide** contains information about the configuration and management of the switch. This manual is intended for network administrators familiar with network management concepts and terminology. For all practical reasons all the switches in this series will simply be referred to as the **Switch** throughout this manual. All example screenshots are taken from the **DGS-1510-28XMP** switch.

Typographical Conventions

Convention	Description
[]	In a command line, square brackets indicate an optional entry. For example: [copy filename] means that optionally you can type copy followed by the name of the file. Do not type the brackets.
Bold Font	Indicates a button, a toolbar icon, menu, or menu item. For example: Open the File menu and choose Cancel . Used for emphasis. May also indicate system messages or prompts appearing on screen. For example: You have mail .
<i>Courier New Font</i>	Indicates commands and responses to prompts that must be typed exactly as printed in the manual.
Initial capital letter	Indicates a window name. Names of keys on the keyboard have initial capitals. For example: Click Enter .
<i>Italics</i>	Indicates a window name or a field. Also can indicate a variables or parameter that is replaced with an appropriate word or string. For example: type <i>filename</i> means that the actual filename should be typed instead of the word shown in italic.
Menu Name > Menu Option	Menu Name > Menu Option indicates the menu structure. Device > Port > Port Properties means the Port Properties menu option under the Port menu option that is located under the Device menu.

Notes, Notices, and Cautions



NOTE: A note indicates important information that helps you make better use of your device.



NOTICE: A notice indicates either potential damage to hardware or loss of data and tells you how to avoid the problem.



CAUTION: A caution indicates a potential for property damage, personal injury, or death.

Safety Instructions

Use the following safety guidelines to ensure your own personal safety and to help protect your system from potential damage. Throughout this safety section, the caution icon () is used to indicate precautions that need to be reviewed and followed.

Safety Precautions

To reduce the risk of bodily injury, electrical shock, fire, and damage to the equipment observe the following precautions:

- Observe and follow service markings.
- Do not service any product except as explained in the system documentation.
- Opening or removing covers that are marked with the triangular symbol with a lightning bolt may expose the user to electrical shock.
 - Only a trained service technician should service components inside these compartments.
- If any of the following conditions occur, unplug the product from the electrical outlet and replace the part or contact your trained service provider:
 - Damage to the power cable, extension cable, or plug.
 - An object has fallen into the product.
 - The product has been exposed to water.
 - The product has been dropped or damaged.
 - The product does not operate correctly when the operating instructions are correctly followed.
- Keep your system away from radiators and heat sources. Also, do not block cooling vents.
- Do not push any objects into the openings of the system. Doing so can cause fire or electric shock by shorting out interior components.
- Use the product only with approved equipment.
- Allow the product to cool before removing covers or touching internal components.
- Operate the product only from the type of external power source indicated on the electrical ratings label. If unsure of the type of power source required, consult your service provider or local power company.
- To help avoid damaging the system, be sure the voltage selection switch (if provided) on the power supply is set to match the power available at the Switch's location:
 - 115 volts (V)/60 hertz (Hz) in most of North and South America and some Far Eastern countries such as South Korea and Taiwan
 - 100 V/50 Hz in eastern Japan and 100 V/60 Hz in western Japan
 - 230 V/50 Hz in most of Europe, the Middle East, and the Far East
- Also, be sure that attached devices are electrically rated to operate with the power available in your location.
- Use only approved power cable(s). If you have not been provided with a power cable for your system or for any AC-powered option intended for your system, purchase a power cable that is approved for use in your country. The power cable must be rated for the product and for the voltage and current marked on the product's electrical ratings label. The voltage and current rating of the cable should be greater than the ratings marked on the product.
- To help prevent electric shock, plug the system and peripheral power cables into properly grounded electrical outlets. These cables are equipped with three-prong plugs to help ensure proper grounding. Do not use adapter plugs or remove the grounding prong from a cable. If using an extension cable is necessary, use a 3-wire cable with properly grounded plugs.
- Observe extension cable and power strip ratings. Make sure that the total ampere rating of all products plugged into the extension cable or power strip does not exceed 80 percent of the ampere ratings limit for the extension cable or power strip.
- To help protect the system from sudden, transient increases and decreases in electrical power, use a surge suppressor, line conditioner, or uninterruptible power supply (UPS).
- Position system cables and power cables carefully; route cables so that they cannot be stepped on or tripped over. Be sure that nothing rests on any cables.

- Do not modify power cables or plugs. Consult a licensed electrician or your power company for site modifications. Always follow your local/national wiring rules.
- When connecting or disconnecting power to hot-pluggable power supplies, if offered with your system, observe the following guidelines:
 - Install the power supply before connecting the power cable to the power supply.
 - Unplug the power cable before removing the power supply.
 - If the system has multiple sources of power, disconnect power from the system by unplugging all power cables from the power supplies.
- Move products with care; ensure that all casters and/or stabilizers are firmly connected to the system. Avoid sudden stops and uneven surfaces.

General Precautions for Rack-Mountable Products

Observe the following precautions for rack stability and safety. Also, refer to the rack installation documentation accompanying the system and the rack for specific caution statements and procedures.

- Systems are considered to be components in a rack. Thus, "component" refers to any system as well as to various peripherals or supporting hardware.



CAUTION: Installing systems in a rack without the front and side stabilizers installed could cause the rack to tip over, potentially resulting in bodily injury under certain circumstances. Therefore, always install the stabilizers before installing components in the rack. After installing system/components in a rack, never pull more than one component out of the rack on its slide assemblies at one time. The weight of more than one extended component could cause the rack to tip over and may result in serious injury.

- Before working on the rack, make sure that the stabilizers are secured to the rack, extended to the floor, and that the full weight of the rack rests on the floor. Install front and side stabilizers on a single rack or front stabilizers for joined multiple racks before working on the rack.
- Always load the rack from the bottom up, and load the heaviest item in the rack first.
- Make sure that the rack is level and stable before extending a component from the rack.
- Use caution when pressing the component rail release latches and sliding a component into or out of a rack; the slide rails can pinch your fingers.
- After a component is inserted into the rack, carefully extend the rail into a locking position, and then slide the component into the rack.
- Do not overload the AC supply branch circuit that provides power to the rack. The total rack load should not exceed 80 percent of the branch circuit rating.
- Ensure that proper airflow is provided to components in the rack.
- Do not step on or stand on any component when servicing other components in a rack.



NOTE: A qualified electrician must perform all connections to DC power and to safety grounds. All electrical wiring must comply with applicable local or national codes and practices.



CAUTION: Never defeat the ground conductor or operate the equipment in the absence of a suitably installed ground conductor. Contact the appropriate electrical inspection authority or an electrician if uncertain that suitable grounding is available.



CAUTION: The system chassis must be positively grounded to the rack cabinet frame. Do not attempt to connect power to the system until grounding cables are connected. Completed power and safety ground wiring must be inspected by a qualified electrical inspector. An energy hazard will exist if the safety ground cable is omitted or disconnected.

Protecting Against Electrostatic Discharge

Static electricity can harm delicate components inside the system. To prevent static damage, discharge static electricity from your body before touching any of the electronic components, such as the microprocessor. This can be done by periodically touching an unpainted metal surface on the chassis.

The following steps can also be taken to prevent damage from electrostatic discharge (ESD):

- When unpacking a static-sensitive component from its shipping carton, do not remove the component from the antistatic packing material until ready to install the component in the system. Just before unwrapping the antistatic packaging, be sure to discharge static electricity from your body.
- When transporting a sensitive component, first place it in an antistatic container or packaging.
- Handle all sensitive components in a static-safe area. If possible, use antistatic floor pads, workbench pads and an antistatic grounding strap.

1. Introduction

Switch Description
Package Contents
Features
Front-Panel Components
Rear Panel Components
Side Panel Components

This **Hardware Installation Guide** is a detailed document explaining information about the hardware installation, configuration, specifications, guidelines, and maintenance of a D-Link switch.

Switch Description

The **DGS-1510 Series** is D-Link's next generation SmartPro Switch. It features built-in 10Gbps SFP+ ports targeted for SME/SMB core deployment to improve connectivity between core switches and edge switches. The DGS-1510 Series also implements D-Link's innovative 3rd generation Green Ethernet technology (IEEE 802.3az) by not only saving power over inactive links, but also turning off LEDs on a customized schedule and allowing ports to automatically enter the hibernated state.

In the **DGS-1510 Series**, the following switches are available: **DGS-1510-20**, **DGS-1510-28**, **DGS-1510-28P**, **DGS-1510-28X**, **DGS-1510-28XMP**, **DGS-1510-52**, **DGS-1510-52X**, and **DGS-1510-52XMP**. Some features, throughout this guide, will apply to all the switches within the **DGS-1510 Series**. When referring to these universal features, we will simply refer to the product as the **Switch**.

Package Contents

When purchasing a D-Link DGS-1510 Series Switch, a list of items will be included in the package of the Switch. Open the shipping carton of the Switch and carefully unpack its contents. The carton should contain the following items:

- One D-Link DGS-1510 Series Switch.
- One Quick Installation Guide.
- One AC power cord.
- One console cable.
- One power cord cable clip.
- One mounting kit (two brackets and screws).
- Four rubber feet with adhesive backing.
- One CD that includes a digital copy of the CLI Reference Guide, Web UI Reference Guide, Hardware Installation Guide, D-View module, D-Link Network Assistant, and D-Link Network Assistant Guide.



NOTE: If any item is missing or damaged, please contact your local D-Link Reseller for replacement.

Features

The list of features below highlights the significant features of the Switch.

- Supports Virtual Stacking. D-Link Single IP Management (SIM).
- Supports Physical Stacking, using the SFP+ ports with 40G (Full Duplex) in topologies Linear and Ring.

- Supports a 16,384 MAC address table.
- Supports Flow Control (802.3x) in full-duplex compliant.
- Supports Jumbo Frames of up to 9,216 bytes
- Supports Spanning Tree with 802.1D 2004 STP/RSTP and 802.1Q 2005 MSTP.
- Supports Loopback Detection (LBD).
- Supports Link Aggregation (802.3ad and 802.3AX) with a maximum of 32 groups per Switch.
- Supports Port Mirroring.
- Supports Layer 2 Multicast Filtering.
- Supports IGMP Snooping (v1, v2, v3 awareness) with up to 512 snooping groups and 128 static multicast addresses. MLD Snooping (v1, v2 awareness) with up to 512 snooping groups and 128 static multicast addresses. IGMP Snooping and MLD Snooping share 128 static groups and 512 snooping groups.
- Supports Virtual LAN (802.1Q) with up to 4K static VLAN groups and 4K dynamic VLAN groups.
- Supports Port-based VLAN.
- Supports MAC-based VLAN.
- Supports 802.1v Protocol-based VLAN.
- Supports Asymmetric VLAN.
- Supports Auto Voice and Surveillance VLAN.
- Supports IP Interfaces with up to 16 IP interfaces.
- Supports Gratuitous ARP.
- Supports IPv6 Ready Phase 2 compliancy.
- Supports Static Routing.
- Supports Quality of Service (QoS) with Queue Handling and Class of Service (CoS).
- Supports Access Control List (ACL) with Ingress ACL, Time-based ACL, and ACL Statistics.
- Supports Secure Shell (SSHv2) with IPv4/IPv6 access.
- Supports Secure Sockets Layer (SSL) versions 1, 2, and 3 with IPv4/IPv6 access.
- Supports Port Security of up to 128 MAC addresses.
- Supports Broadcast and Multicast Storm Control.
- Supports Traffic Segmentation
- Supports D-Link SafeGuard Engine.
- Supports ARP Spoofing Prevention.
- Supports IP-MAC-Port Binding (IMPB). This feature includes DHCP Snooping, IP Source Guard, Dynamic ARP Inspection, DHCPv6 Guard, RA Guard, IPv6 Snooping, IPv6 Source Guard, and IPv6 ND Snooping.
- Supports DoS Attack Prevention.
- Supports Port-based Network Access Control (PNAC) better known as 802.1X. This feature includes Local and RADIUS database, Port-based Access Control, and MAC-based Access Control (MAC).
- Supports Web-based Access Control (WAC).
- Supports Japanese Web-based Access Control (JWAC).
- Supports Guest VLAN.
- Supports 15 User Account Privilege Levels.
- Supports Compound Authentication.
- Supports Link Layer Discovery Protocol (LLDP) with LLDP-MED.
- Supports Accessibility using multiple interfaces like the Command Line Interface (CLI), Web-based Graphical User Interface (Web-based GUI), and more.
- Supports Telnet Server and Client from IPv4 and IPv6.
- Supports Trivial File Transfer Protocol (TFTP) Client.
- Supports Simple Network Management Protocol (SNMP) version 1, 2c, and 3. Also supports SNMP Traps.

- Supports DHCP Client.
- Supports Dynamic Host Configuration Protocol (DHCP) Relay.
- Supports Traps and Logs.
- Support Multiple Images.
- Supports Password Encryption (MD5/SHA1).
- Supports Simple Network Time Protocol (SNTP).
- Support Power Saving using the Link Status Mode.
- Support Time-based Power-over-Ethernet (PoE).
- Supports IEEE 802.3az compliance.
- Supports Optical Transceiver Digital Diagnostic Monitoring (DDM).
- Supports D-Link Discovery Protocol (DDP).
- Supports Ethernet Ring Protection Switching (ERPS). For more information, refer to **Appendix C – ERPS Information**.
- Supports Network Time Protocol (NTP).
- Supports Telnet Client.
- Supports MIBs like MIBII, Bridge MIB, SNMPv2 MIB, RMON MIB, RMONv2 MIB, Ether-like MIB, 802.3 MAU MIB, 802.1p MIB, RADIUS Authentication Client MIB, Ping MIB, L2 Specific MIB, Private MIB, Entity MIB, and ZoneDefense MIB.

Front-Panel Components

On the front panel of the Switch there are Ethernet RJ45/SFP/SFP+ ports, a Console port, a Reset button, a Mode button (only of PoE supported switches), and LED indicators.

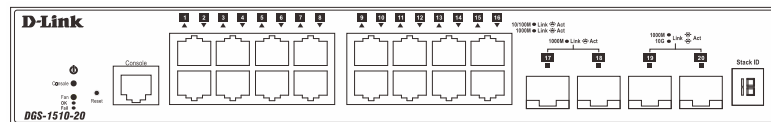

Figure 1-1 Front panel view of a DGS-1510-20 Switch

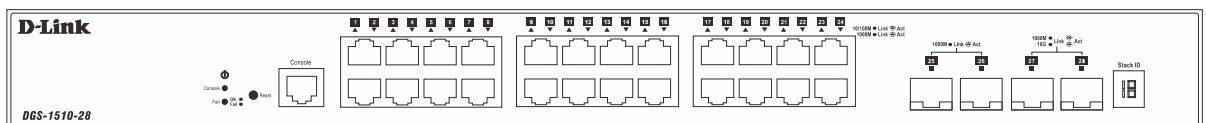

Figure 1-2 Front panel view of a DGS-1510-28 Switch

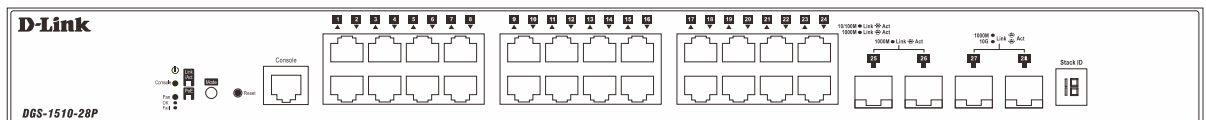

Figure 1-3 Front panel view of a DGS-1510-28P Switch

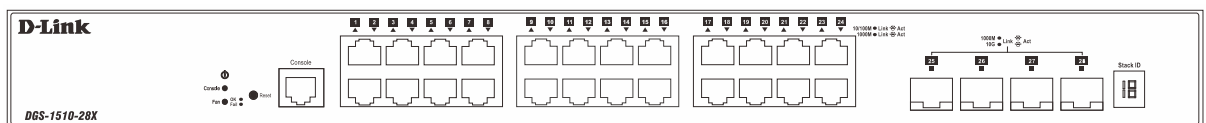

Figure 1-4 Front panel view of a DGS-1510-28X Switch

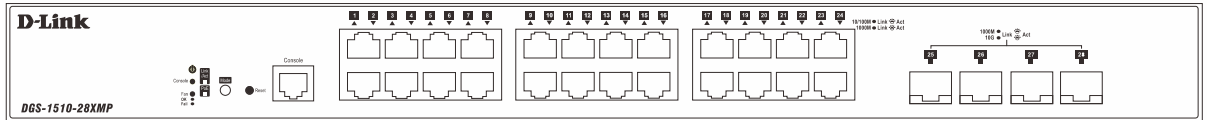

Figure 1-5 Front panel view of a DGS-1510-28XMP Switch

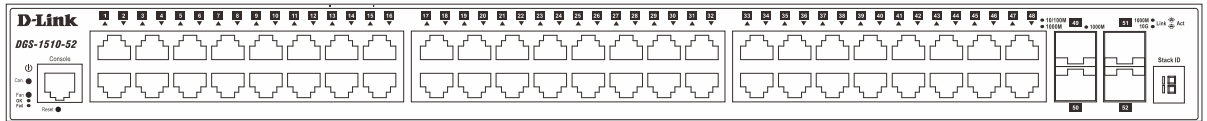

Figure 1-6 Front panel view of a DGS-1510-52 Switch

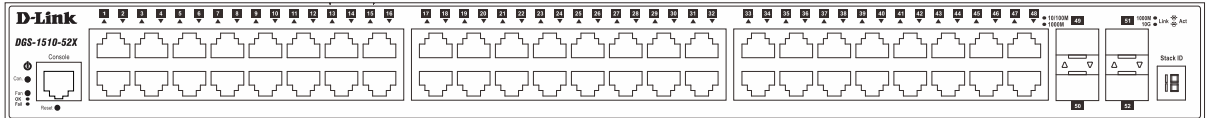

Figure 1-7 Front panel view of a DGS-1510-52X (HW: A1) Switch

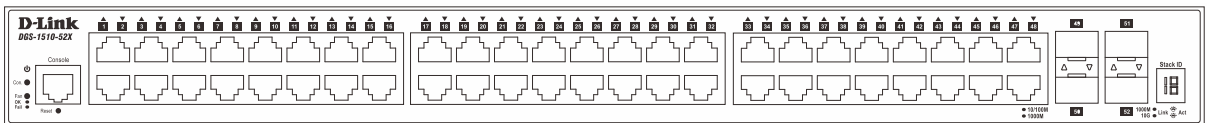

Figure 1-8 Front panel view of a DGS-1510-52X (HW: A2) Switch

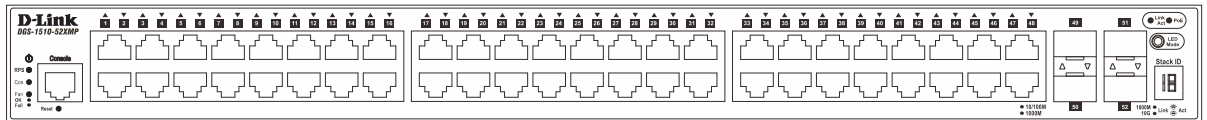

Figure 1-9 Front panel view of a DGS-1510-52XMP Switch

Ports

The Type and Number of ports available on the Switch are listed out below:

- **DGS-1510-20:**
 - Sixteen Copper Ports (10BASE-T/100BASE-TX/1000BASE-T),
 - Two SFP Ports (1000BASE),
 - Two Dual Speed SFP+ Ports (1000BASE/10GBASE),
 - One Console Port (RJ-45),
- **DGS-1510-28:**
 - Twenty-four Copper Ports (10BASE-T/100BASE-TX/1000BASE-T),
 - Two SFP Ports (1000BASE),
 - Two Dual Speed SFP+ Ports (1000BASE/10GBASE),
 - One Console Port (RJ-45),
- **DGS-1510-28P:**
 - Twenty-four Copper PoE Ports (10BASE-T/100BASE-TX/1000BASE-T),
 - Two SFP Ports (1000BASE),
 - Two Dual Speed SFP+ Ports (1000BASE/10GBASE),
 - One Console Port (RJ-45),
- **DGS-1510-28X:**
 - Twenty-four Copper Ports (10BASE-T/100BASE-TX/1000BASE-T),
 - Four SFP/SFP+ Ports (1000BASE/10GBASE),

- One Console Port (RJ-45),
- **DGS-1510-28XMP:**
 - Twenty-four Copper PoE Ports (10BASE-T/100BASE-TX/1000BASE-T),
 - Four SFP/SFP+ Ports (1000BASE/10GBASE),
 - One Console Port (RJ-45),
- **DGS-1510-52:**
 - Forty-eight Copper Ports (10BASE-T/100BASE-TX/1000BASE-T),
 - Two SFP Ports (1000BASE),
 - Two Dual Speed SFP+ Ports (1000BASE/10GBASE),
 - One Console Port (RJ-45),
- **DGS-1510-52X (HW: A1):**
 - Forty-eight Copper Ports (10BASE-T/100BASE-TX/1000BASE-T),
 - Four SFP/SFP+ Ports (1000BASE/10GBASE),
 - One Console Port (RJ-45),
- **DGS-1510-52X (HW: A2):**
 - Forty-eight Copper Ports (10BASE-T/100BASE-TX/1000BASE-T),
 - Four SFP/SFP+ Ports (1000BASE/10GBASE),
 - One Console Port (RJ-45),
- **DGS-1510-52XMP:**
 - Forty-eight Copper PoE Ports (10BASE-T/100BASE-TX/1000BASE-T),
 - Four SFP/SFP+ Ports (1000BASE/10GBASE),
 - One Console Port (RJ-45),

Reset Button

On the front panel of the Switch is a **Reset** button. The Switch will reboot or reset to factory default settings depending on how long this button is pressed.

- Press and hold the **Reset** button for less than 5 seconds (release before 5 seconds) to reboot the Switch. All unsaved configurations will be lost.
- Press and hold the **Reset** button for more than 5 seconds (release between 6 and 10 seconds) to reset the software configuration of the Switch to the factory default settings. All the port LEDs will light up (solid amber) for 2 seconds to indicate the start of the factory reset procedure.

LED Indicators

The Switch's front panel presents LED indicators for Power, Console, Master (Stack Control), Stack ID and Link/Act indicators for all the ports. The **DGS-1510-28P**, **DGS-1510-28XMP**, and **DGS-1510-52XMP** switches are equipped with an additional PoE light, to indicate whether the ports are running in Power over Ethernet mode.

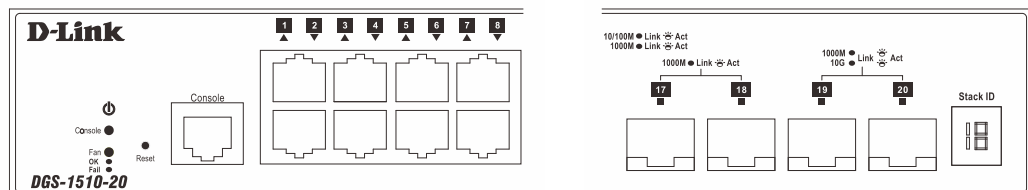

Figure 1-10 LED indicators for a DGS-1510-20 Switch

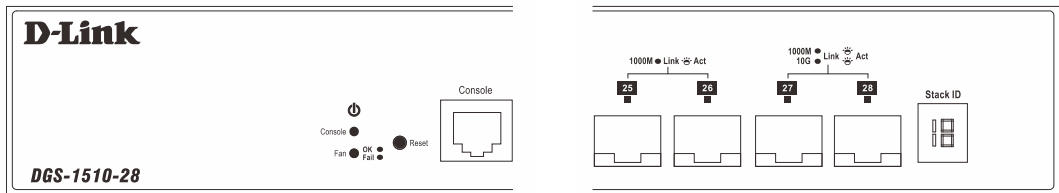

Figure 1-11 LED indicators for a DGS-1510-28 Switch

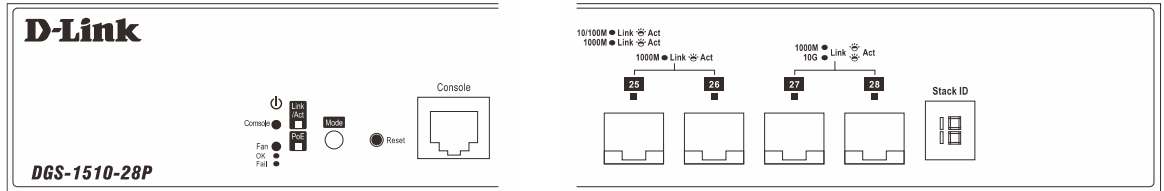

Figure 1-12 LED indicators for a DGS-1510-28P Switch

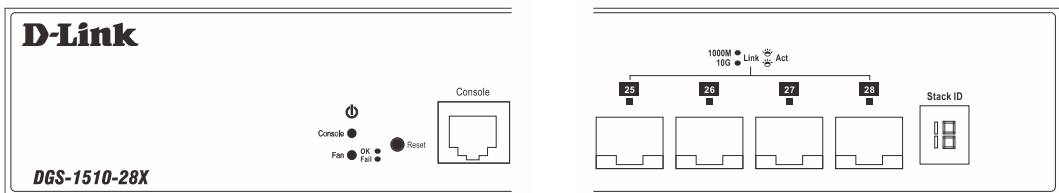

Figure 1-13 LED indicators for a DGS-1510-28X Switch

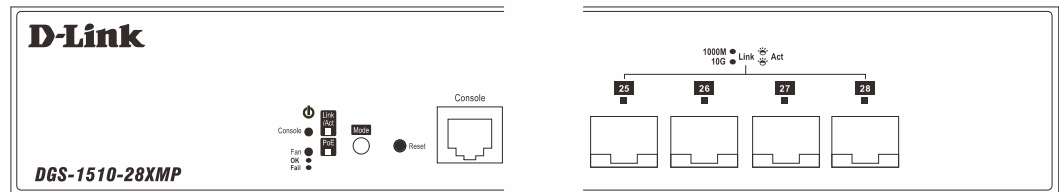

Figure 1-14 LED indicators for a DGS-1510-28XMP Switch

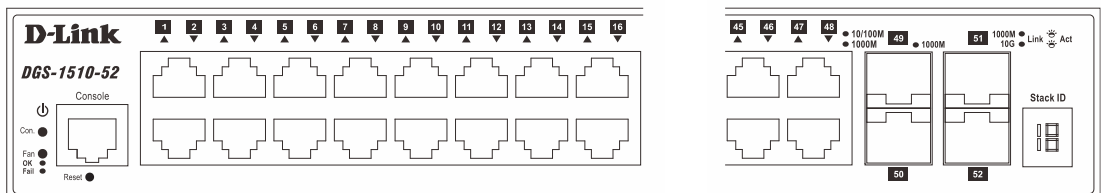

Figure 1-15 LED indicators for a DGS-1510-52 Switch

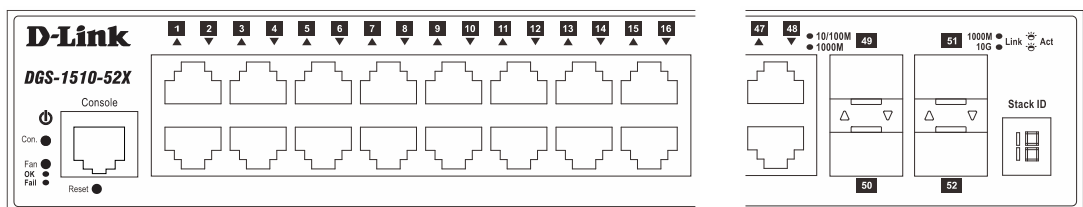

Figure 1-16 LED indicators for a DGS-1510-52X (HW: A1) Switch

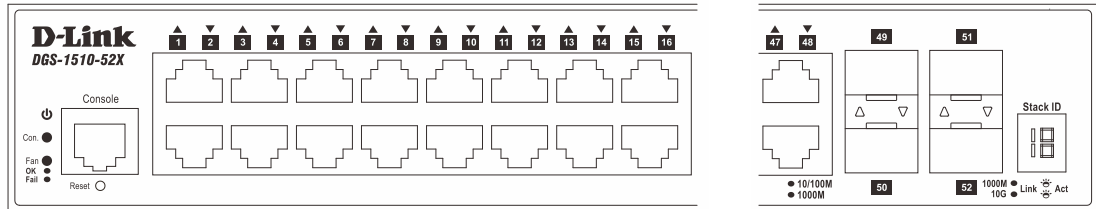

Figure 1-17 LED indicators for a DGS-1510-52X (HW: A2) Switch

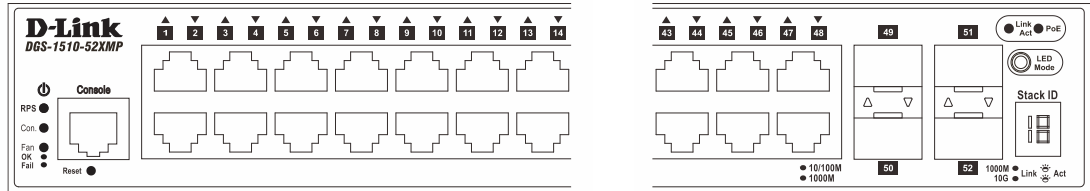



Figure 1-18 LED indicators for a DGS-1510-52XMP Switch

A separate table below describes LED indicators in more detail.

LED	Description
Power 	This LED will light green after powering the Switch on to indicate the ready state of the device. The indicator is dark when the Switch is no longer receiving power (i.e. powered off).
Console	This LED will blink green during the Power-On Self-Test (POST). When the POST is finished, the LED goes dark. The indicator will light steady green when a user is logged in through the console port.
Fan	This LED will light green after the diagnostics have passed with no errors. This LED will light red when any of the fans has failed.
Link/Act LEDs	The Switch has LED indicators for Link and Activity. Copper Ports: The LED will light steady green when there is a secure connection (or link) to a 1000Mbps Ethernet device or steady orange when there is a secure connection (or link) to a 10/100Mbps Ethernet device at any of the copper ports. The LED will blink green when a 1000Mbps port is active or blink orange when a 10/100Mbps port is active. The LED remains dark when there is no link or activity. SFP Ports: The LED will light steady green when there is a secure connection (or link) to a 1000Mbps Ethernet device at any of the SFP ports. The LED remains dark when there is no link or activity. SFP+ Ports: The LED will light steady green when there is a secure connection (or link) to a 10Gbps Ethernet device or steady orange when there is a secure connection (or link) to a 1Gbps Ethernet device at any of the SFP+ ports. The LED will blink green when a 10Gbps port is active or blink orange when a 1Gbps port is active. The LED remains dark when there is no link or activity.
PoE	Only the DGS-1510-28P , and DGS-1510-28XMP , and DGS-1510-52XMP switches are equipped with a PoE LED. When this light is on with a solid green light, it means that the corresponding ports are feeding power to the PoE devices plugged in. When this light is on with a solid orange light, it means that the port is in an error condition state. When this light is off, it means that the ports are not supplying power to the devices plugged into the ports.
Stack ID	For standalone Switches, this will display number “1”. For stacked Switches, this indicates the position in the stacking box ID. The Stack ID is assigned either by the user (static mode) or by the system (automatic mode). When “1” to “6” is displayed, this indicates the stacking position of the switch. An “H” indicates the device was

LED	Description
	assigned as the stacking Master. “h” means the device was selected to be the Backup Master. A “G” is displayed when the Safeguard Engine feature enters the exhausted mode. An “E” is displayed when an error was found during the system self-test.

For more information about LED Indicators, refer to **LED Indicators**.

Rear Panel Components

On the rear panel of the Switch there are an AC power socket, an electrical grounding point, and a security lock.

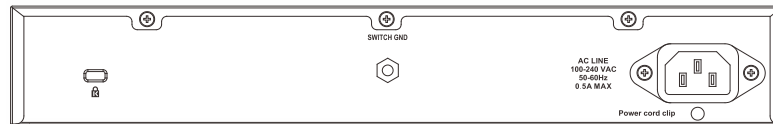

Figure 1-19 Rear panel view of a DGS-1510-20 Switch

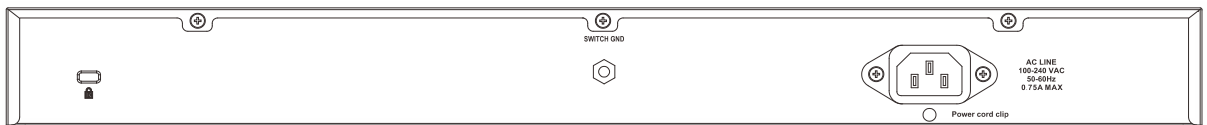

Figure 1-20 Rear panel view of a DGS-1510-28 Switch

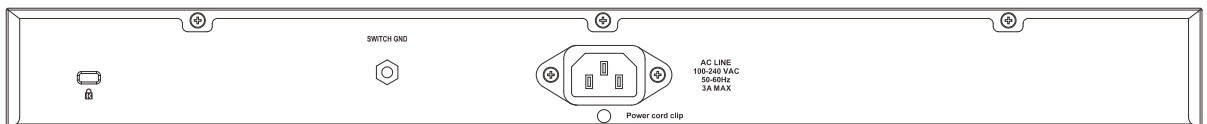

Figure 1-21 Rear panel view of a DGS-1510-28P Switch

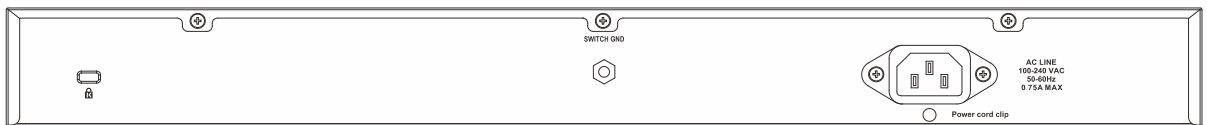

Figure 1-22 Rear panel view of a DGS-1510-28X Switch

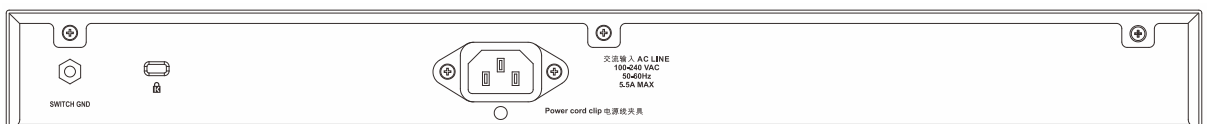

Figure 1-23 Rear panel view of a DGS-1510-28XMP Switch

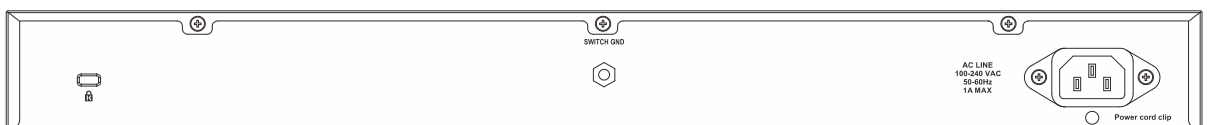

Figure 1-24 Rear panel view of a DGS-1510-52 Switch

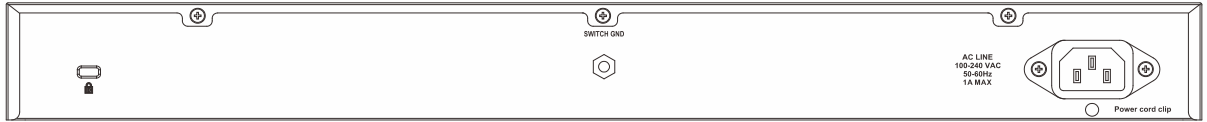

Figure 1-25 Rear panel view of a DGS-1510-52X (HW: A1) Switch

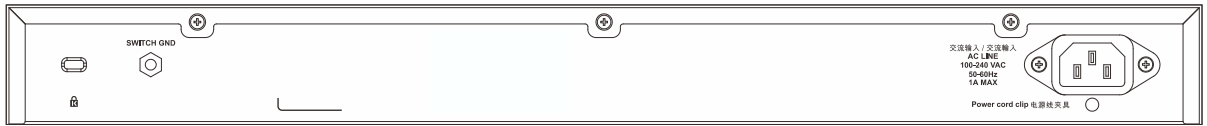

Figure 1-26 Rear panel view of a DGS-1510-52X (HW: A2) Switch



Figure 1-27 Rear panel view of a DGS-1510-52XMP Switch

The AC power connector is a standard three-pronged connector that supports the power cord. Plug-in the female connector of the provided power cord into this socket, and the male side of the cord into a power outlet. The Switch automatically adjusts the power setting to any supply voltage in the range from 100 to 240 VAC at 50 to 60 Hz.

Side Panel Components

On the side panels of the Switch there are heat vents and fans to dissipate heat. Do not block these openings. Leave at least 6 inches of space at the rear and sides of the Switch for proper ventilation. Without proper heat dissipation and air circulation, system components might overheat which could lead to system failure or even severely damaged components.

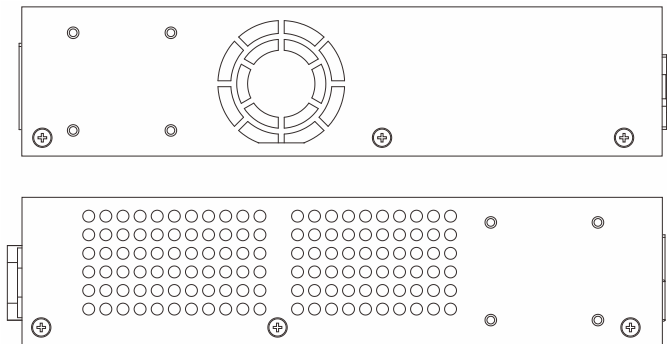

Figure 1-28 Side panels view of a DGS-1510-20 Switch

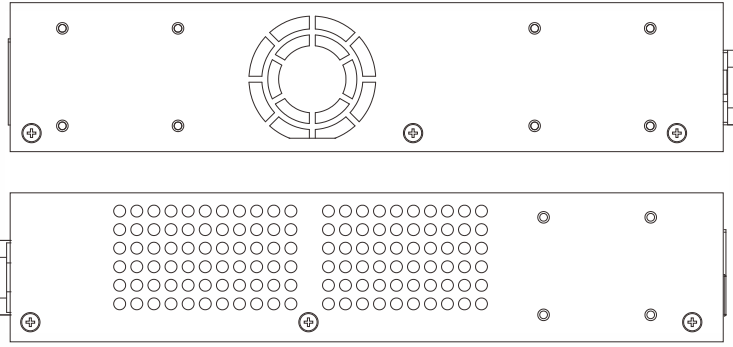

Figure 1-29 Side panels view of a DGS-1510-28 Switch

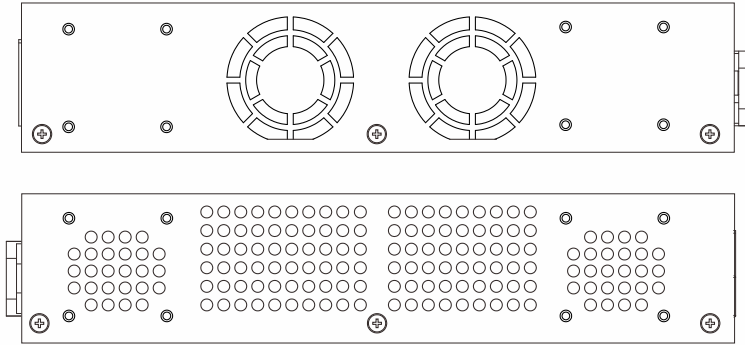

Figure 1-30 Side panels view of a DGS-1510-28P Switch

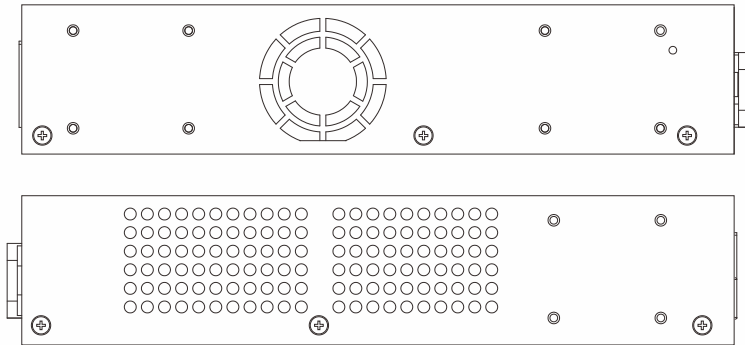

Figure 1-31 Side panels view of a DGS-1510-28X Switch

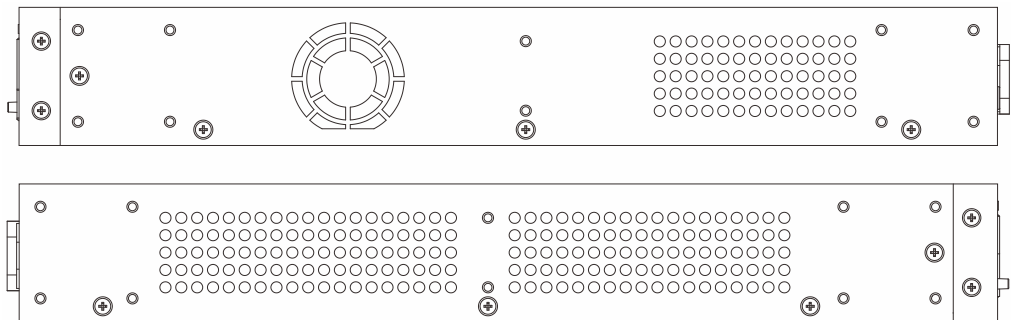

Figure 1-32 Side panels view of a DGS-1510-28XMP Switch

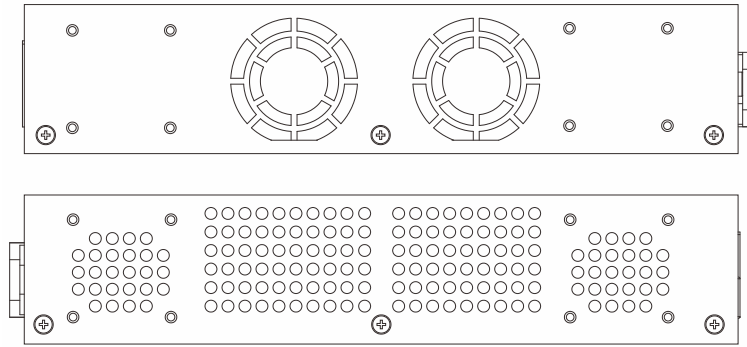

Figure 1-33 Side panels view of a DGS-1510-52 Switch

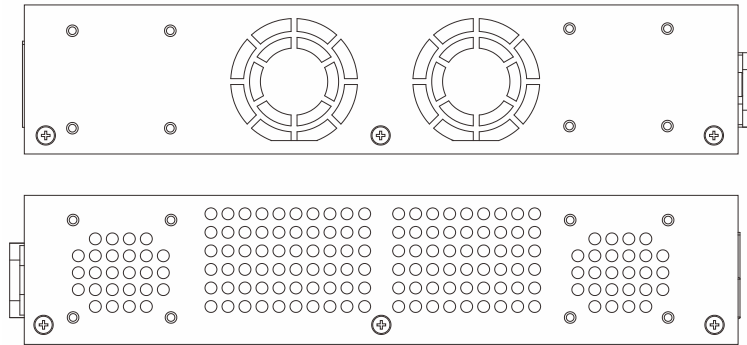

Figure 1-34 Side panels view of a DGS-1510-52X (HW: A1) Switch

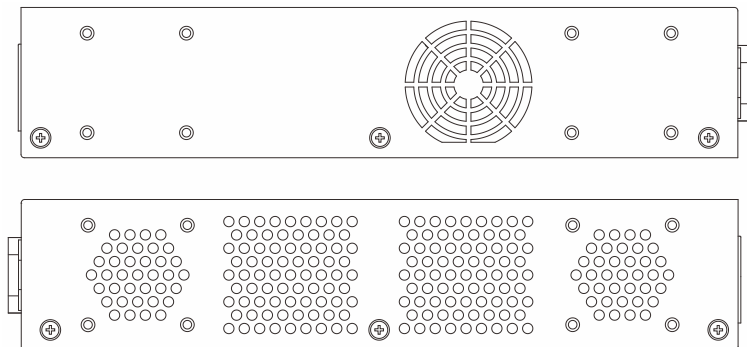

Figure 1-35 Side panels view of a DGS-1510-52X (HW: A2) Switch

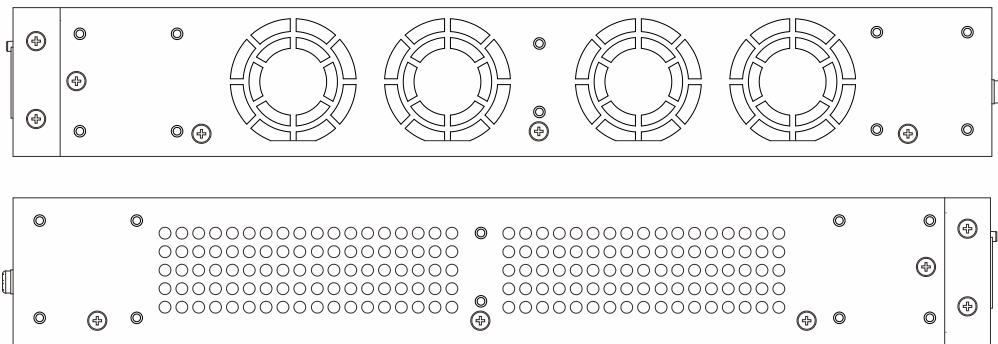

Figure 1-36 Side panels view of a DGS-1510-52XMP Switch

Smart Fans

The DGS-1510 Series Switches includes **smart fans** that will automatically change their speed depending on the internal temperature detected by the sensors built-in the Switch's hardware.

The following will explain at what temperature the speed of the fan(s) will change:

- **DGS-1510-20:** The fan speed will change from:
 - Low Speed to High Speed at 48.0°C.
 - High Speed to Low Speed at 43.0°C.
- **DGS-1510-28:** The fan speed will change from:
 - Low Speed to High Speed at 48.0°C.
 - High Speed to Low Speed at 43.0°C.
- **DGS-1510-28P:** The fan speed will change from:
 - Low Speed to High Speed at 36.0°C.
 - High Speed to Low Speed at 31.0°C.
- **DGS-1510-28X:** The fan speed will change from:
 - Low Speed to High Speed at 48.0°C.
 - High Speed to Low Speed at 43.0°C.
- **DGS-1510-28XMP:** The fan speed will change from:
 - Low Speed to High Speed at 36.0°C.
 - High Speed to Low Speed at 31.0°C.
- **DGS-1510-52:** The fan speed will change from:
 - Low Speed to High Speed at 47.0°C.
 - High Speed to Low Speed at 42.0°C.
- **DGS-1510-52X (HW: A1):** The fan speed will change from:
 - Low Speed to High Speed at 47.0°C.
 - High Speed to Low Speed at 42.0°C.
- **DGS-1510-52X (HW: A2):** The fan speed will change from:
 - Low Speed to Medium Speed at 34.7°C. Medium Speed to High Speed at 44.7°C.
 - High Speed to Medium Speed at 39.7°C. Medium Speed to Low Speed at 29.7°C.
- **DGS-1510-52XMP:** The fan speed will change from:
 - Low Speed to Medium Speed at 34.7°C. Medium Speed to High Speed at 44.7°C.
 - High Speed to Medium Speed at 39.7°C. Medium Speed to Low Speed at 29.7°C.

2. Installation

Installation Guidelines *Power On (AC Power)*

Installation Guidelines

Please follow these guidelines for setting up the Switch:

- Install the Switch on a sturdy, level surface that can support at least 6 kg (13.2 lb). Do not place heavy objects on the Switch.
- The power outlet should be within 1.82 meters (6 feet) of the Switch.
- Visually inspect the power cord and see that it is fully secured to the AC power port.
- Make sure that there is proper heat dissipation from and adequate ventilation around the Switch. Leave at least 10 cm (4 inches) of space at the front and rear of the Switch for ventilation.
- Install the Switch in a fairly cool and dry place for the acceptable temperature and humidity operating ranges.
- Install the Switch in a site free from strong electromagnetic field generators (such as motors), vibration, dust, and direct exposure to sunlight.
- When installing the Switch on a level surface, attach the rubber feet to the bottom of the device. The rubber feet cushion the Switch, protect the casing from scratches and prevent it from scratching other surfaces.

Installing the Switch without a Rack

First, attach the rubber feet included with the Switch if installing on a desktop or shelf. Attach these cushioning feet on the bottom at each corner of the device. Allow enough ventilation space between the Switch and any other objects in the vicinity.

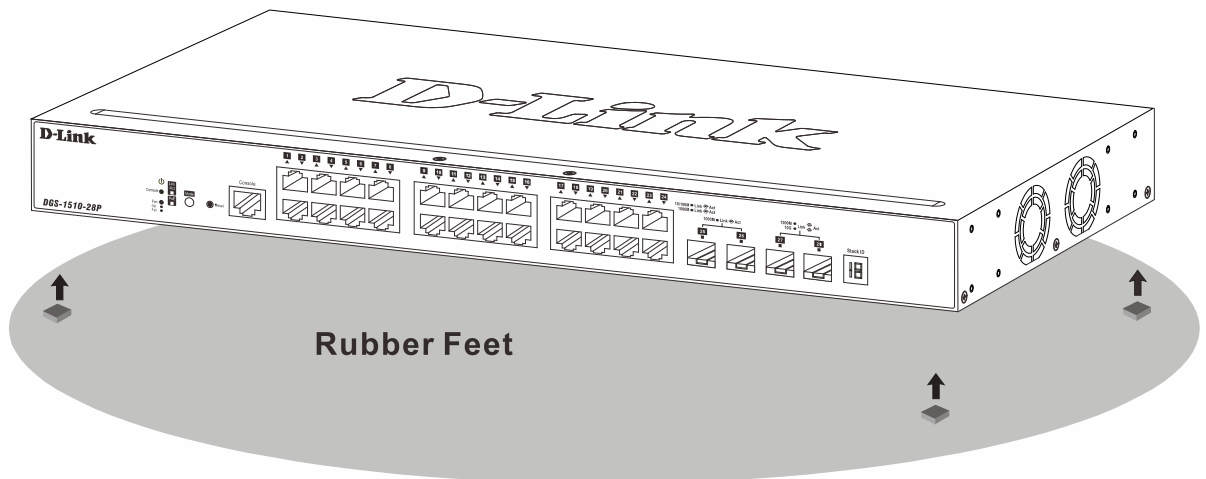

Figure 2-1 Attach rubber feet to the Switch

Attaching Brackets to a Switch for Rack Mounting

The Switch is mounted to a standard 19" rack using mounting brackets. Use the following diagrams as a guide.

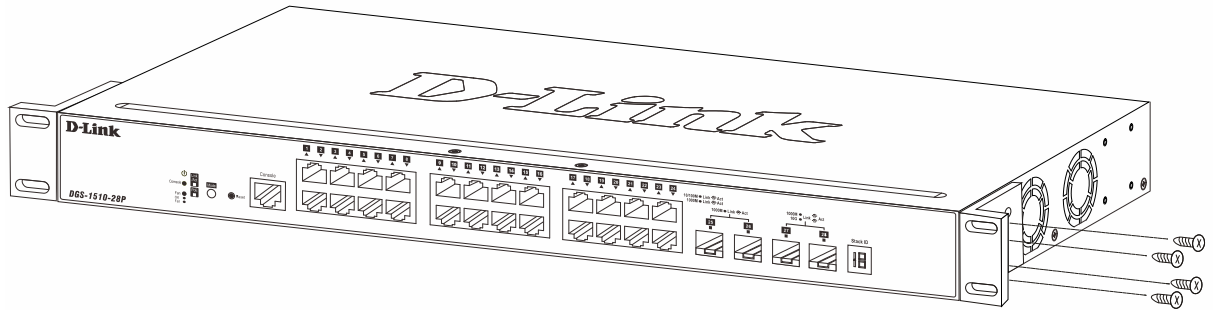

Figure 2-2 Attach mounting brackets to the Switch

Fasten the mounting brackets to the Switch using the screws provided. With the brackets attached securely, the Switch can be mounted in a standard rack, as shown below.



NOTE: Please review the Installation Guidelines above before installing the Switch in a rack. Make sure there is adequate space around the Switch to allow for proper airflow, ventilation and cooling.

Installing the Switch in a Standard 19" Rack

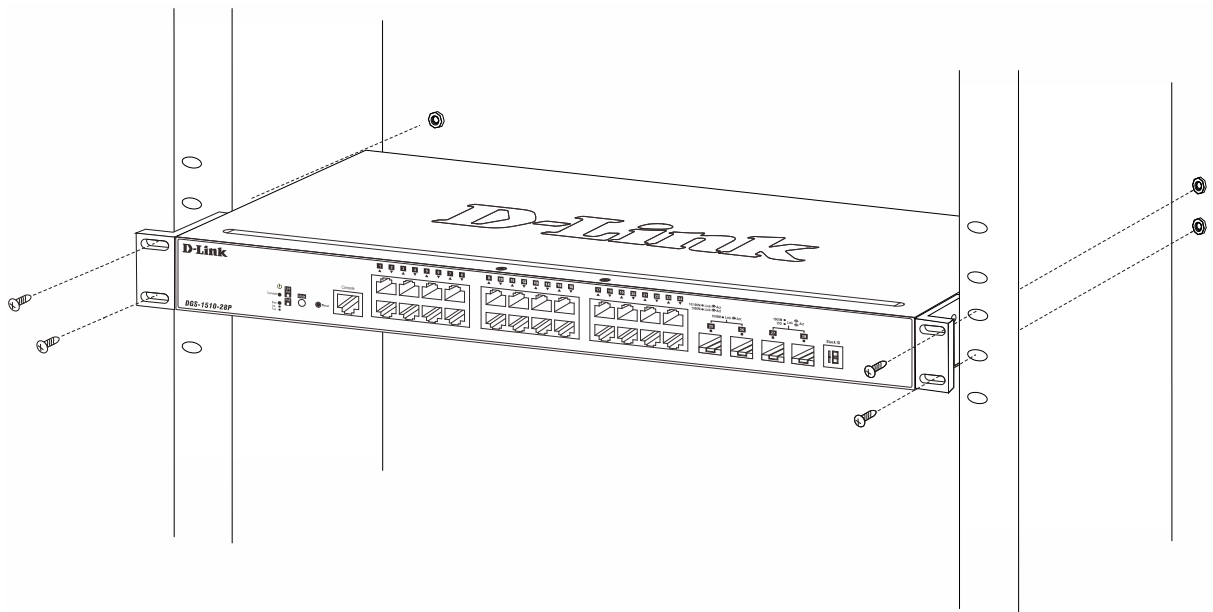

Figure 2-3 Mount the Switch in a rack



CAUTION: Installing systems in a rack without the front and side stabilizers installed could cause the rack to tip over, potentially resulting in bodily injury under certain circumstances. Therefore, always install the stabilizers before installing components in the rack. After installing components in a rack, do not pull more than one component out of the rack on its slide assemblies at one time. The weight of more than one extended component could cause the rack to tip over and may result in injury.

Installing Transceivers into the Transceiver Ports

The Switch is equipped with SFP (Small Form Factor Portable) and SFP+ ports, which are used with fiber-optical transceiver cabling. SFP ports support full-duplex transmissions, auto-negotiation, and

can be uplinked with various other switches across a gigabit network. The SFP ports support data rates of up to 1Gbit/s and the SFP+ ports support data rates of up to 10Gbit/s.

See the figure below for installing the transceiver in the transceiver port on the Switch.

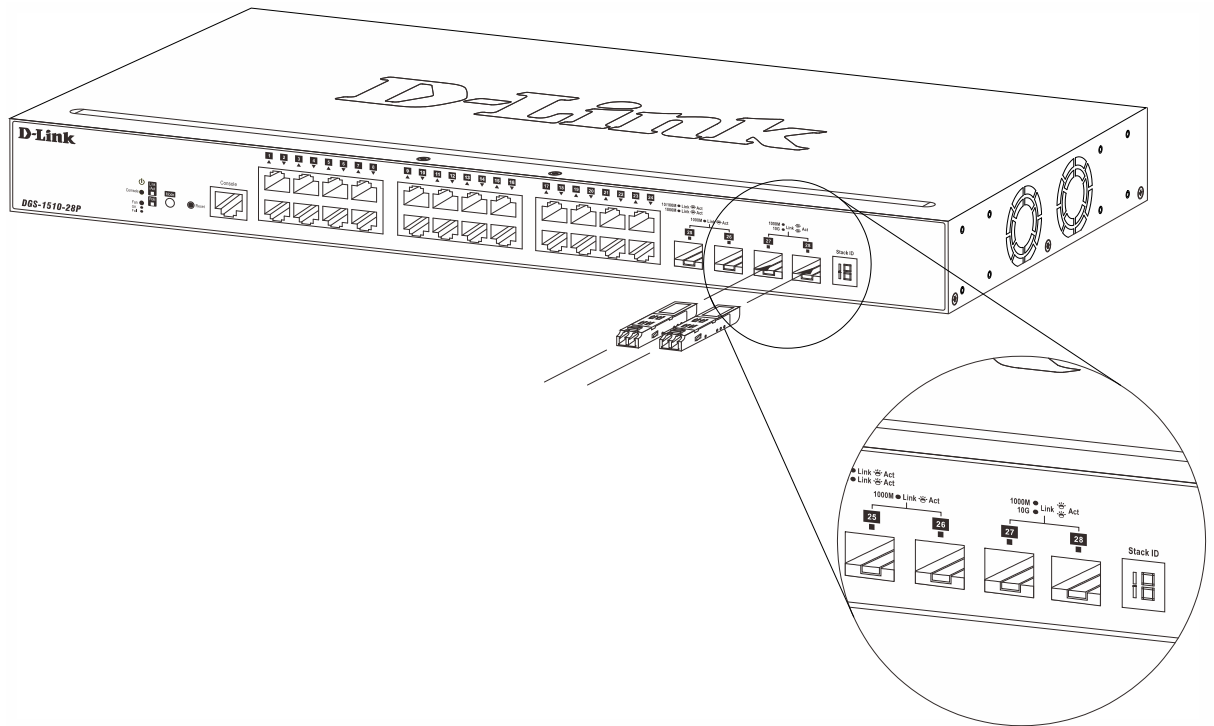

Figure 2-4 Inserting fiber-optic transceivers into a Switch

For a full list of supported transceivers, compatible with this switch series, refer to **Port Functions**.

NOTE: Only use pluggable optical modules and Direct-Attach Cables (DAC) that meet the following regulatory requirements:



- Class 1 Laser Product
- UL and/or CSA registered component for North America
- FCC 21 CFR Chapter 1, Sub-chapter J in accordance with FDA & CDRH requirements
- IEC/EN 60825-1/-2: 2007 2nd edition or later, European Standard

Power On (AC Power)

Plug one end of the AC power cord into the power socket of the Switch and the other end into the local power source outlet. After the system powered on, the LED's blink green to indicate that the system is booting up.

Power Failure (AC Power)

In the event of a power failure, just as a precaution, unplug the power cord from the Switch. After the power returns, plug the power cord back into the power socket of the Switch.

Installing Power Cord Clip

To prevent accidental removal of the AC power cord, it is recommended to install the power cord clip together with the power cord.



NOTE: The DGS-1510-52XMP does not support the installation of the power cord clip.

With the rough side facing down, insert the Tie Wrap into the hole below the power socket.

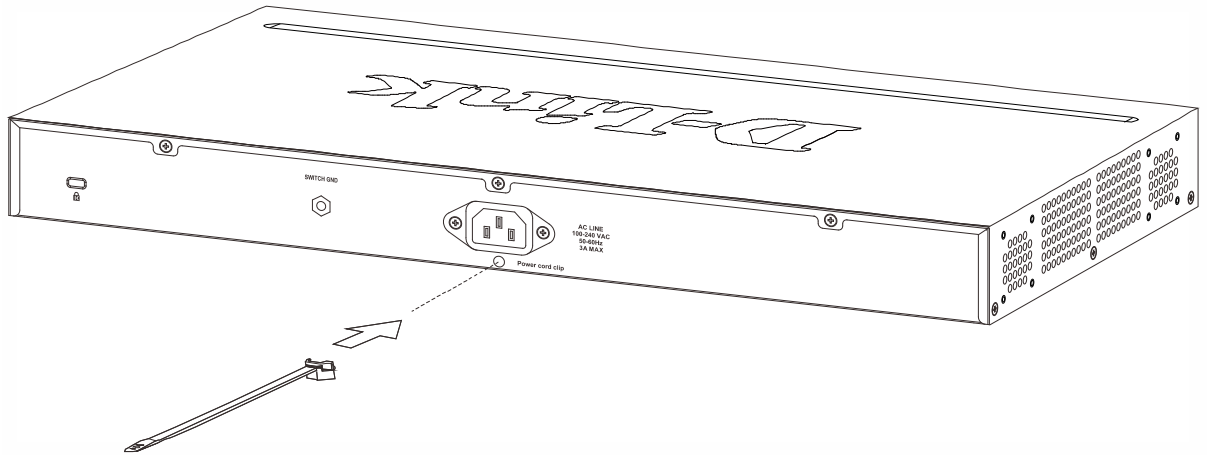

Figure 2-5 Insert Tie Wrap to the Switch

Plug the AC power cord into the power socket of the Switch.

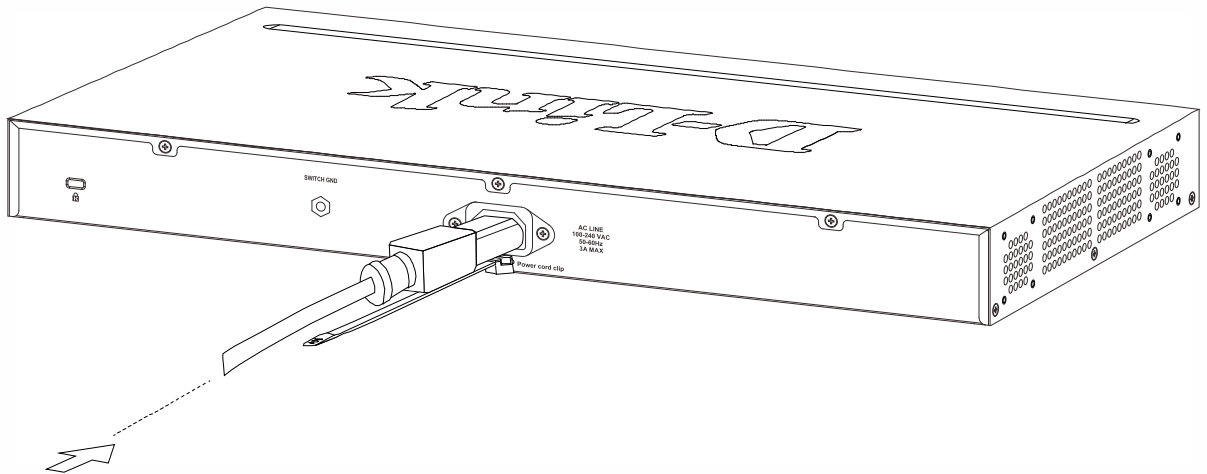

Figure 2-6 Connect the power cord to the Switch

Slide the Retainer through the Tie Wrap until the end of the cord.

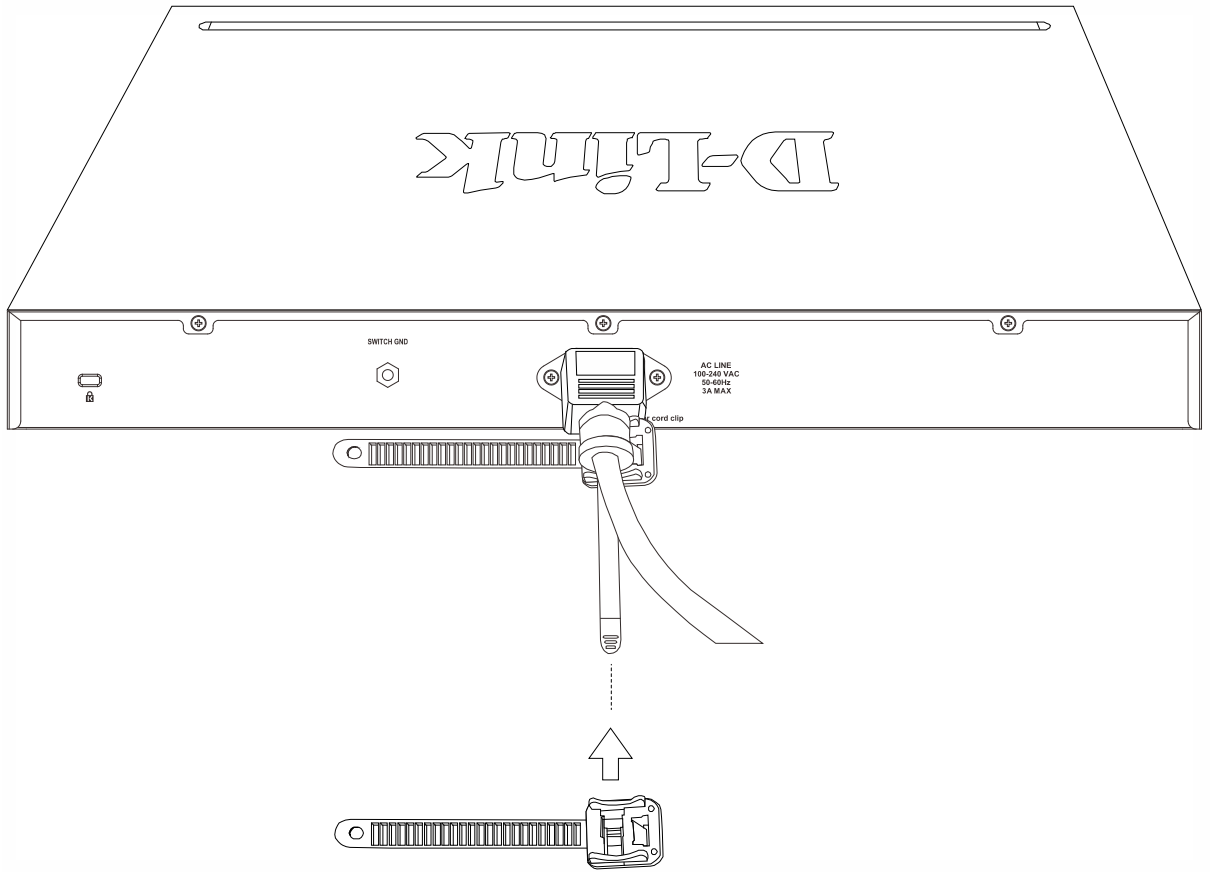

Figure 2-7 Slide the Retainer through the Tie Wrap

Circle the tie of the Retainer around the power cord and into the locker of the Retainer.

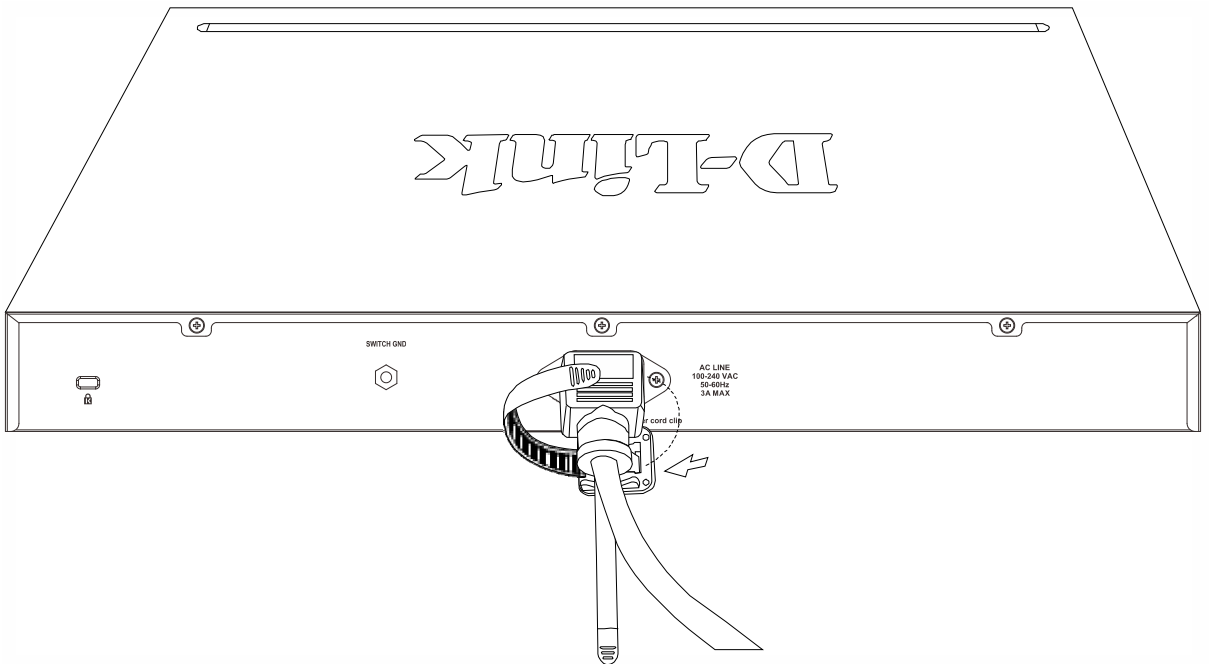

Figure 2-8 Circle around the power cord

Fasten the tie of the Retainer until the power cord is secured.

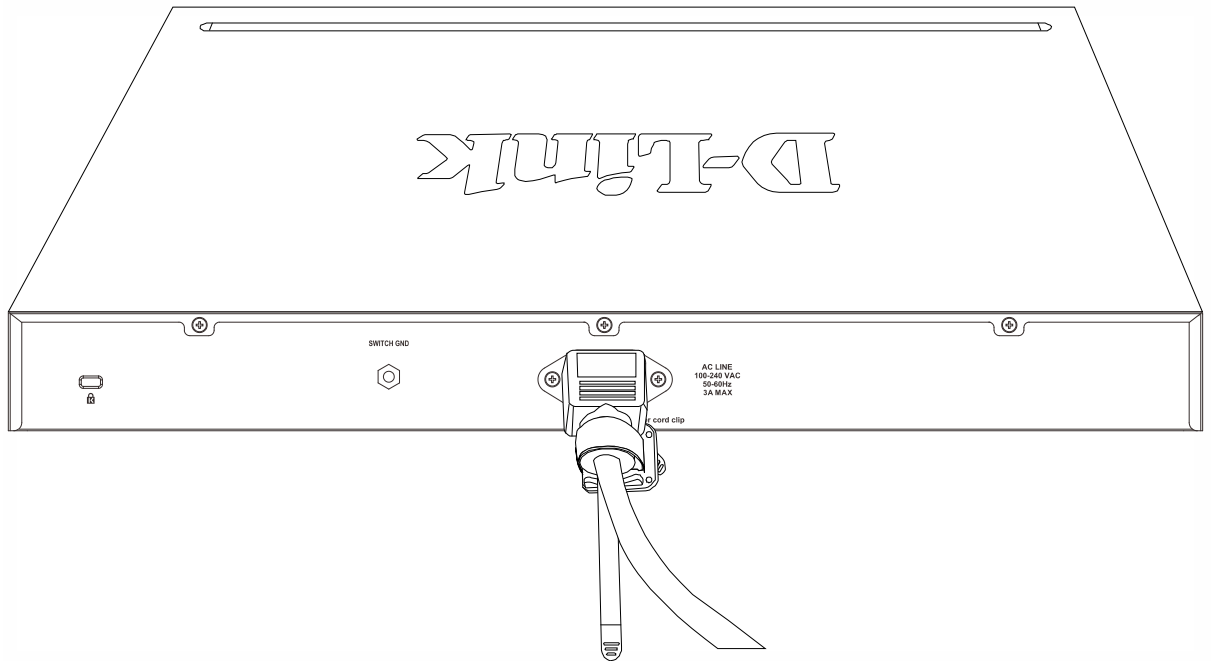

Figure 2-9 Secure the power cord

Installing the RPS into a Rack-mount Chassis

The DPS-700 is a redundant power supply unit designed to conform to the voltage requirements of the switches being supported.

The DPS-700 can only be used with the DGS-1510-52XMP.



CAUTION: DO NOT connect the RPS to AC power before the DC power cable is connected. This might damage the internal power supply.

DPS-700

The DPS-700 is connected to the Master Switch using a 22-pin DC power cable. A standard, three-pronged AC power cable connects the redundant power supply to the main power source.

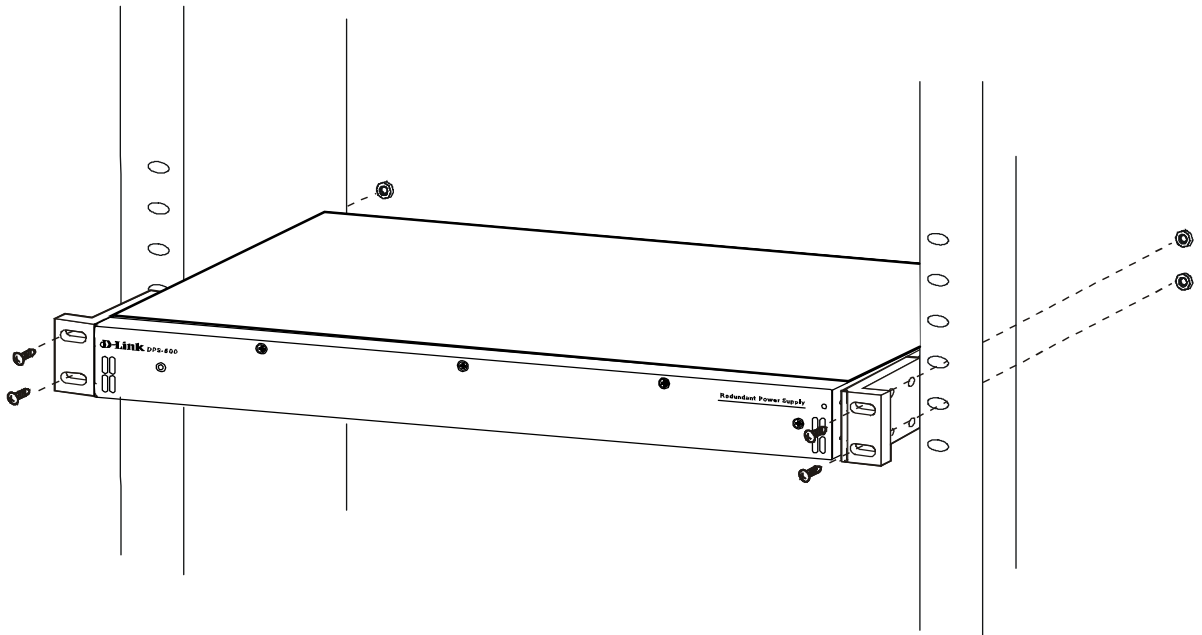

Figure 2-10 Front view of the DPS-700

1. Insert one end of the 22-pin DC power cable into the receptacle on the Switch and the other end into the Redundant Power Supply unit.
2. Using a standard AC power cable, connect the redundant power supply to the main AC power source. A green LED on the front of the DPS-700 will glow to indicate a successful connection.
3. Re-connect the Switch to the AC power source. The LED indicator will show that a redundant power supply is now in operation.
4. No configuration in the Switch's firmware is needed for this installation.



NOTE: See the RPS Quick Installation Guide for more information.

REAR PANEL OF DGS-1510-52XMP

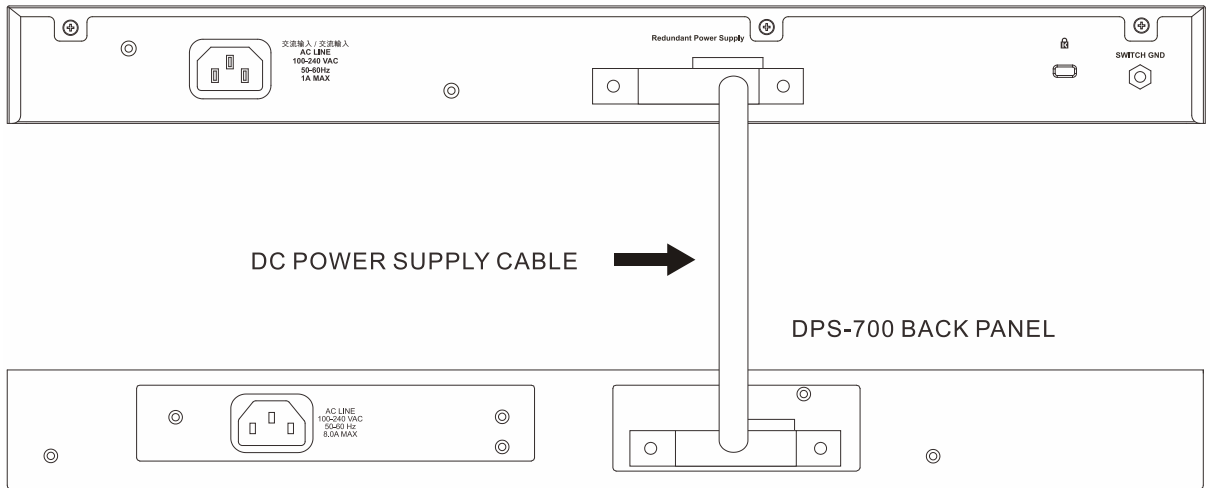

Figure 2-11 Rear view of the DPS-700 connected to a DGS-1510-52XMP



CAUTION: Do not connect the DPS-700 to the DGS-1510-52XMP by using the 14-pin DC power cable. It may cause damage when using the wrong DC power cable. ONLY use the 22-pin DC power cable.

3. Connecting the Switch

Switch to End Node
Switch to another Switch
Switch to a Server

Switch to End Node

An End Node can be any networking device, plugged into any of the networking ports of the Switch, where data transmission ends. Typical end nodes are computers. End nodes are generally outfitted with a 10/100/1000Mbps RJ-45 Ethernet Network Interface Card (NIC) that can connect to the Switch via a twisted-pair UTP/STP cable. Connect the end node to any of the copper ports of the Switch. The Link/Act LEDs for each Ethernet port turns green or amber when the link is active. A blinking LED indicates packet activity on that port.

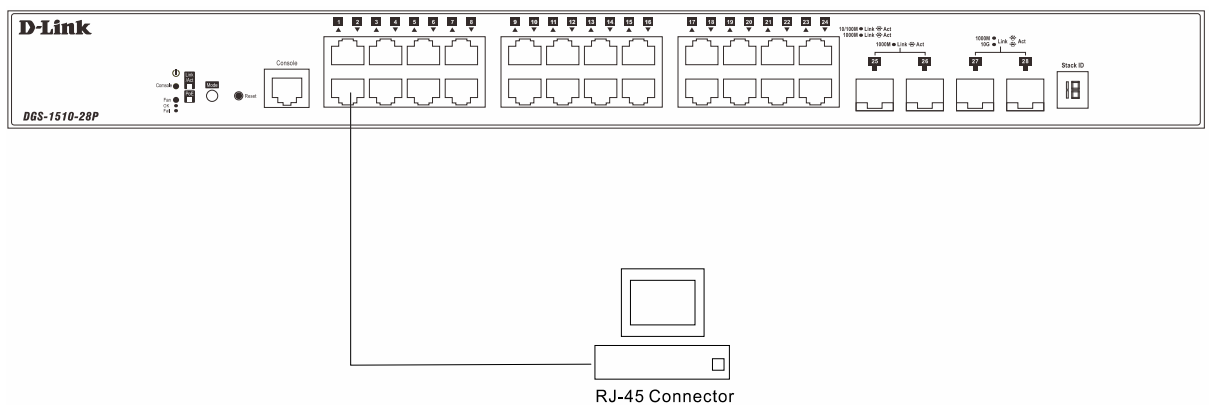

Figure 3-1 End Node to Switch Connection

Switch to another Switch

There is a great deal of flexibility on how connections are made using the appropriate cabling.

- Connect a 10BASE-T switch port to the Switch via a twisted-pair Category 3, 4 or 5 UTP/STP cable.
- Connect a 100BASE-TX switch port to the Switch via a twisted-pair Category 5 UTP/STP cable.
- Connect 1000BASE-T switch port to the Switch via a twisted pair Category 5e UTP/STP cable.
- Connect switch supporting a fiber-optic uplink to the Switch's SFP ports via fiber-optic cabling.

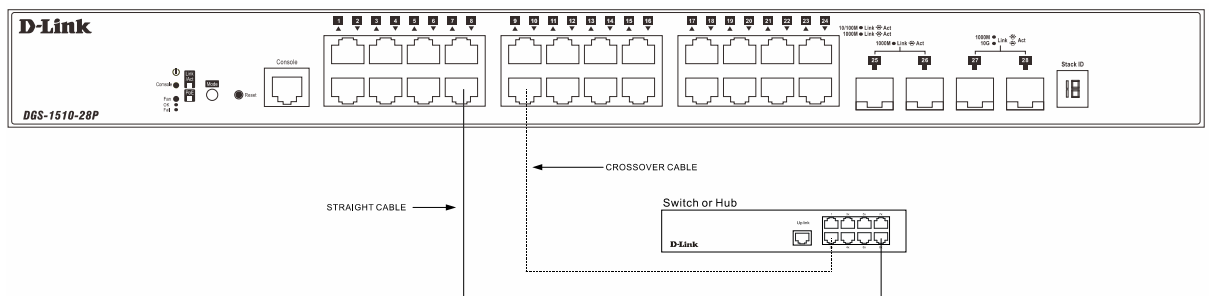

Figure 3-2 Switch to Switch Connection

Switch to a Server

The Combo Copper/SFP ports are ideal for connecting a network backbone, server or server farm to the Switch. The copper ports operate at a speed of 10/100/1000Mbps in half-duplex or full-duplex mode. The fiber-optic ports can operate at both 100/1000Mbps in full-duplex mode. The Link LED turns green when a connection is made.

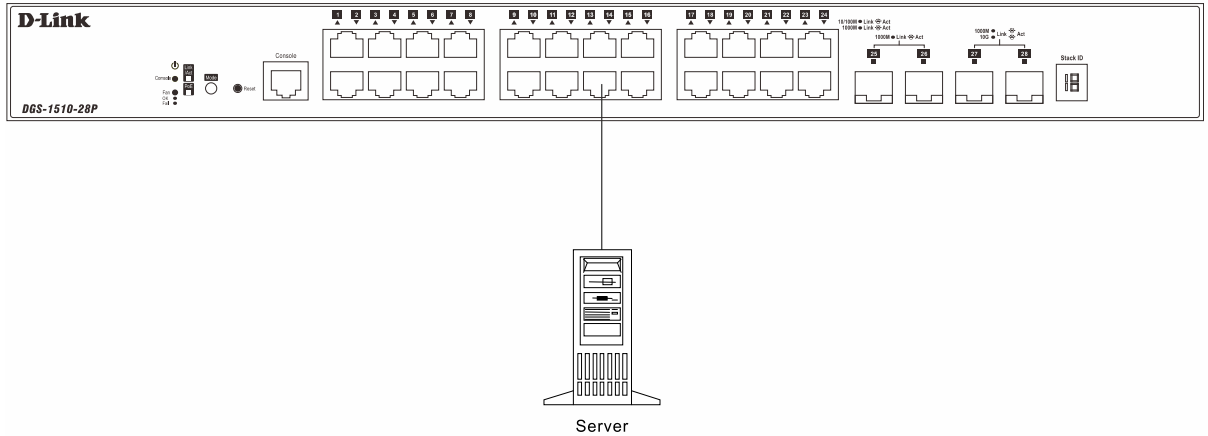

Figure 3-3 Server to Switch Connection

4. Introduction to Switch Management

Management Options
Connecting the Console Port
SNMP Settings

Management Options

This Switch can be managed, out-of-band, through the console port on the front panel or in-band using Telnet. Alternatively, the web-based management can be used, accessible through a web browser.

Command Line Interface (CLI) Management

The user can connect a computer or terminal to the serial console port to access the Switch. The Command Line Interface (CLI) provides complete access to all Switch management features. When connecting to the Switch by means of Telnet or SSH, the same CLI can be accessed for Switch management. For more detailed information about the CLI, refer to the *CLI Reference Guide*.

SNMP-based Management

The Switch can also be managed with an SNMP-compatible console program. The Switch supports SNMPv1, SNMPv2c, and SNMPv3. The SNMP agent decodes the incoming SNMP messages and responds to requests with MIB objects stored in the database. The SNMP agent updates the MIB objects to generate statistics and counters.

Web-based User Interface (Web UI) Management

The user can connect a computer to any one of the frontal ports of the Switch, other than the console port, to access the Web UI of the Switch by means of a Web browser and entering the IP address of the Switch. This management interface is a more graphically representation of the features that can be viewed and configured on this Switch. Most of the features available from the CLI can be accessed through the Web UI. Web browsers like Microsoft's Internet Explorer, Mozilla Firefox or Google Chrome can be used. For more detailed information about the Web UI, refer to the *Web UI Reference Guide*.

Connecting the Console Port

This section describes how to access the CLI through the serial port. To connect to the serial port, a special **Console Cable** must be used. This cable is included with this product's packaging. The cable referred to as an RS-232 to RJ-45 connector cable specifically pinned to connect to this switch's serial port by using the correct pin configuration.

For more information about the pin layout of this cable, refer to **Appendix B**.

To connect to the console port of the Switch, use the following steps:

- Connect the RS-232 end of the console cable to the **Serial Port** of the management PC.
- Connect the RJ-45 end of the console cable to the **Console Port** of the Switch.
- Open the **HyperTerminal** application (or any terminal emulation program capable of emulating a VT-100 terminal connection) on the management PC and configure the **Properties** of this connection.
 - The **Bits per second** should be **115200** baud.
 - The **Data bits** should be **8**.

- The **Parity** should be **None**.
- The **Stop bits** should be **1**.
- The **Flow control** should be **None**.

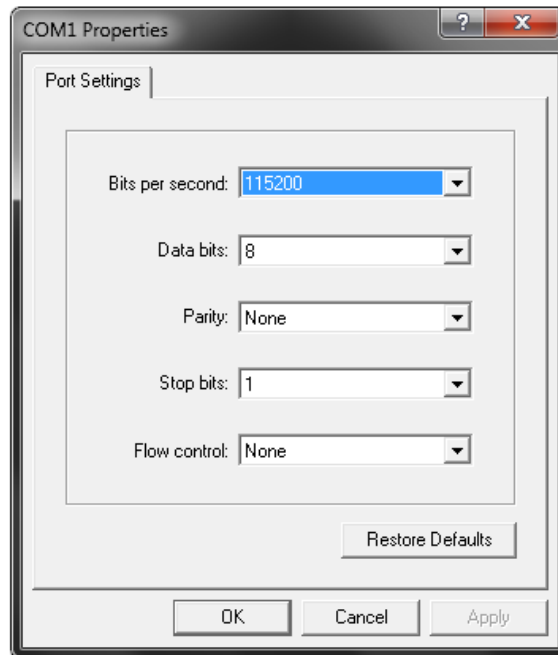

Figure 4-1 HyperTerminal Connection Properties

- Now the Switch can be turned on and access to the Switch's CLI will be available.



NOTE: Access to the console port can be made at any time while the Switch is on. There is no need to turn the Switch off when plugging the console cable into the console port.

Connecting to the Switch for the First Time

After successfully connecting to the Switch's console and the Switch was turned on, the boot-up procedure will be displayed, as shown below.

```
Boot Procedure V1.00.016
-----
Power On Self Test ..... 100 %

MAC Address   : 3C-1E-04-A1-B9-E0
H/W Version   : A1

Please Wait, Loading V1.60.008 Runtime Image ..... 100 %
UART init ..... 100 %
Starting runtime image
Device Discovery ..... 100 %
Configuration init ..... 100 %

Switch con0 is now available

Press any key to login...
```

During the boot-up procedure, we can find the PROM version, MAC address, Hardware Version, and Firmware Version used by this Switch.



NOTE: Both the default **username** and **password** is *admin*.

Enter the username and password when prompt to do so and press enter after each entry. The CLI prompt will immediately be available, as shown below.

```
DGS-1510-28XMP Gigabit Ethernet SmartPro Switch

Command Line Interface
Firmware: Build 1.60.008
Copyright (C) 2018 D-Link Corporation. All rights reserved.

User Access Verification

Username:admin
Password:*****

Switch#
```

Now the Switch can be configured.



CAUTION: For security reasons, it is highly recommended to configure a personal username and password for this Switch.

Creating a User Account

This section will discuss how to create a login username and password on this Switch. This login details will be applied not only for access to the CLI, but also for access to the Web UI, Telnet, SSH, and SSL interfaces. The same username and password will be used for these connections.

To create a user account, enter the following commands.

```
Switch> enable
Switch# configure terminal
Switch(config)# username Administrator password 12345
Switch(config)# username Administrator privilege 15
Switch(config)# line console
Switch(config-line)# login local
Switch(config-line)#
```

In the above example,

- We accessed the **Privileged EXEC Mode** by entering the command **enable**.
- Then we entered the **Global Configuration Mode** by entering the command **configure terminal**.
- Then we created a user account with the username of '**Administrator**' and gave it the password of '**12345**' by entering the command **username Administrator password 12345**.
- Then we assigned the privilege level of 15 to this user account by entering the command **username Administrator privilege 15**. The highest level access is 15 and the lowest level access is 1.
- Then we entered the **LINE Configuration Mode** by entering the command **line console**.
- Then we configured the Switch to allow access to the management interface by using locally configured user accounts. The command is **login local**.



NOTE: CLI configuration commands only modify the running configuration file and are not saved when the Switch is rebooted. To save all your configuration changes in non-volatile storage, you must use the **copy running-configuration start-up-configuration** command to copy the running configuration file to the start-up configuration. For more information, refer to the *CLI Reference Guide*.

Configuring the IP Address

Each networking node, within a network, must use a unique IP Address. This IP address is used to communicate with other networking devices in the network. The IP address of the Switch is also important to be able to access the Web UI of this Switch.

There are two methods in which a Switch can obtain an IP address.

- The Switch can obtain an IP address from a DHCP server located within the local network. By default, this option is not enabled.
- The administrator can manually configure an IP address for this Switch.

To find out what the IP address of the Switch is, we again need to access the Switch management interface through the CLI. Take note of the following example.

```
Switch> show ip interface

Interface vlan1 is enabled, Link status is down
  IP Address is 10.90.90.90/8 (Manual)
  ARP timeout is 20 minutes.
  Proxy ARP is disabled
  IP Local Proxy ARP is disabled
  gratuitous-send is disabled, interval is 0 seconds

Total Entries: 1

Switch>
```

In the above example, the command **show ip interface** is used to display information about the IP interfaces created on this Switch. In this display we see that the IP address for this switch is **10.90.90.90** and the CIDR notation for the subnet mask is **/8** which translates to **255.0.0.0**. This information can however be modified, as show below.

```
Switch> enable
Switch# configure terminal
Switch(config)# interface vlan 1
Switch(config-if)# ip address 192.168.1.1 255.255.255.0
Switch(config-if)#
```

In the above example,

- We accessed the **Privileged EXEC Mode** by entering the command **enable**.
- Then we entered the **Global Configuration Mode** by entering the command **configure terminal**.
- Then we entered the **VLAN Configuration Mode** of the default VLAN, which is VLAN 1, by entering the command **interface vlan 1**.
- Then we changed the IP address of the Switch to 192.168.1.1 and the subnet mask to 255.255.255.0 by entering the command **ip address 192.168.1.1 255.255.255.0**.

SNMP Settings

The Simple Network Management Protocol (SNMP) is an OSI Layer 7 (Application Layer) designed specifically for managing and monitoring network devices. SNMP enables network management stations to read and modify the settings of gateways, routers, switches and other network devices. Use SNMP to configure system features for proper operation, monitor performance and detect potential problems in the Switch, switch group or network.

Managed devices that support SNMP include software (referred to as an agent), which runs locally on the device. A defined set of variables (managed objects) is maintained by the SNMP agent and used to manage the device. These objects are defined in a Management Information Base (MIB), which provides a standard presentation of the information controlled by the on-board SNMP agent. SNMP defines both the format of the MIB specifications and the protocol used to access this information over the network.

The Switch supports SNMPv1, SNMPv2c, and SNMPv3. The administrator may specify which SNMP version to use to monitor and control the Switch. The three SNMP versions vary in the level of security provided between the management station and the network device.

In SNMPv1 and SNMPv2, user authentication is accomplished using 'community strings', which function like passwords. The remote user SNMP application and the Switch SNMP must use the same community string. SNMP packets from any station that has not been authenticated are ignored (dropped).

The default community strings for the Switch used for SNMPv1 and SNMPv2 management access are:

- **public** - Allows authorized management stations to retrieve MIB objects.
- **private** - Allows authorized management stations to retrieve and modify MIB objects.

SNMPv3 uses a more sophisticated authentication process that is separated into two parts. The first part is to maintain a list of users and their attributes that are allowed to act as SNMP managers. The second part describes what each user on that list can do as an SNMP manager.

The Switch allows groups of users to be listed and configured with a shared set of privileges. The SNMP version may also be set for a listed group of SNMP managers. Thus, a group of SNMP managers can be created to view read-only information or receive traps using SNMPv1 while assigning a higher level of security to another group, granting read/write privileges using SNMPv3.

Using SNMPv3 individual users or groups of SNMP managers can be allowed to perform or be restricted from performing specific SNMP management functions. The functions allowed or restricted are defined using the Object Identifier (OID) associated with a specific MIB. An additional layer of security is available for SNMPv3 in that SNMP messages may be encrypted.

Traps

Traps are messages that alert network personnel of events that occur on the Switch. The events can be as serious as a reboot (someone accidentally turned OFF the Switch), or less serious like a port status change. The Switch generates traps and sends them to the trap recipient (or network manager). Typical traps include trap messages for Authentication Failure, Topology Change and Broadcast\Multicast Storm.

Management Information Base (MIB)

The Switch in the Management Information Base (MIB) stores management and counter information. The Switch uses the standard MIB-II Management Information Base module. Consequently, values for MIB objects can be retrieved from any SNMP-based network management software. In addition to the standard MIB-II, the Switch also supports its own proprietary enterprise MIB as an extended Management Information Base. The proprietary MIB may also be retrieved by specifying the MIB Object Identifier. MIB values can be either read-only or read-write.



NOTE: For customers interested in D-View, D-Link Corporation's proprietary SNMP management software, go to <http://dview.dlink.com.tw/> and download the software and manual.

5. Web-based Switch Configuration

Introduction

Logging onto the Web Manager

Web-based User Interface

Introduction

Most software functions of the Switch can be managed, configured, and monitored via the embedded Web User Interface (Web UI). Manage the Switch from remote stations anywhere on the network through a standard browser, such as Internet Explorer (version 7 and later), Mozilla Firefox, Chrome, or Safari. The browser acts as a universal access tool and can communicate directly with the Switch using the HTTP protocol.

Logging onto the Web Manager

To access the Web UI, simply open a standard web browser on the management PC, enter the Switch's default IP address into the address bar of the browser and press the **Enter** key.



NOTE: The default IP address of this switch is **10.90.90.90**, with a subnet mask of **255.0.0.0**.



Figure 5-1 IP address in Internet Explorer



NOTE: The default username is *admin* and the default password is *admin*.

This will open the user authentication window, as seen below.

Connect to 10.90.90.90	
User Name	<input type="text" value="admin"/>
Password	<input type="password" value="....."/>
Language	<input type="text" value="English"/> ▾
<input type="button" value="Login"/> <input type="button" value="Reset"/>	

Figure 5-2 Enter Network Password Window

Enter the **User Name** and **Password** in the corresponding fields and click **Login**. This will open the Web UI. Management features available in the Web UI of the Switch are explained below.

Web-based User Interface

The user interface provides access to various Switch configuration and management windows, it allows the user to view performance statistics, and permits graphical monitoring of the system status.

Areas of the User Interface

The Web UI on the Switch can be divided into distinct **Areas**. Different areas in the Web UI provide different manageability options to simplify configuration and feature monitoring.

After accessing the Web UI in the **Standard Mode**, the following will be displayed:

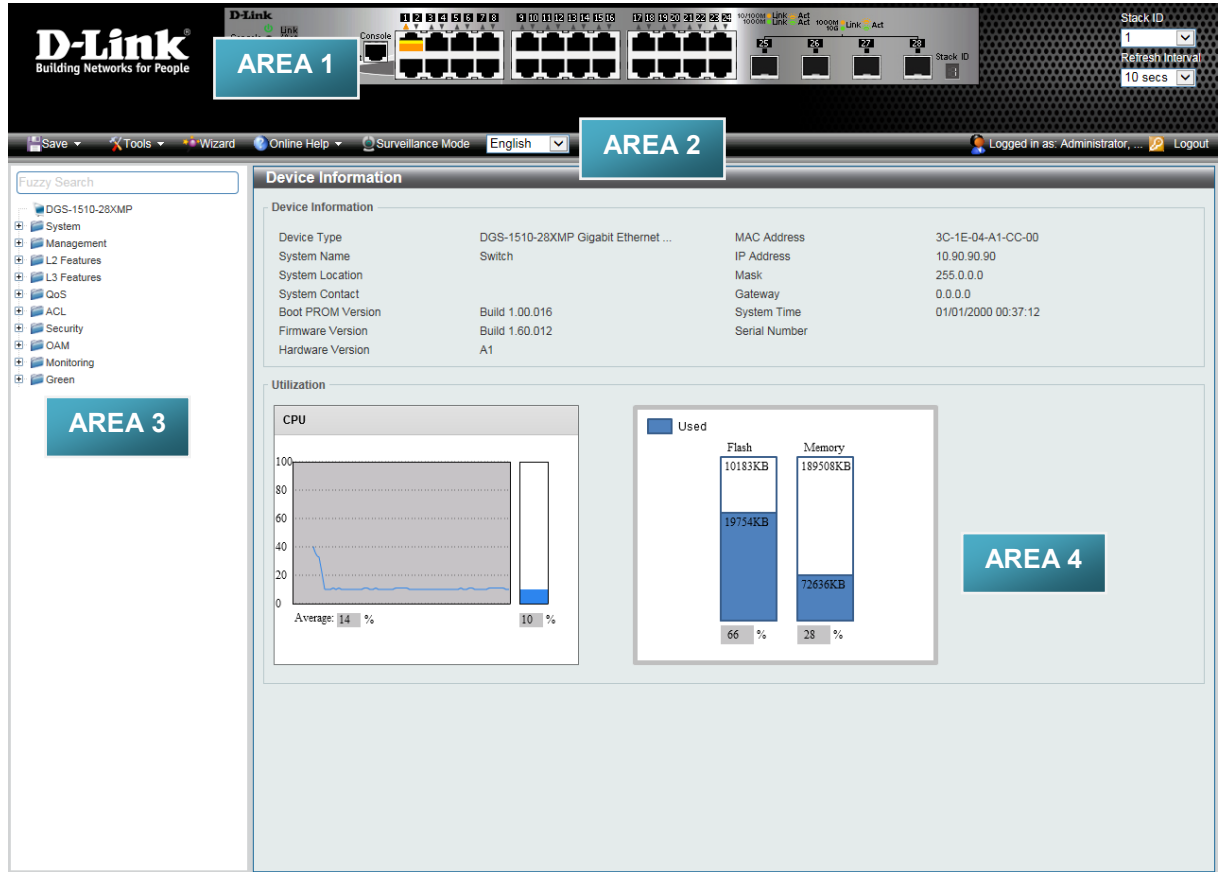

Figure 5-3 Web UI (Standard Mode)

The following **Areas** can be observed in the above window.

Area Number	Description
AREA 1	In this area, a graphical near real-time image of the front panel of the Switch is displayed with ports and expansion modules. Port activity is displayed, depending on the specified mode. Some management functions like port monitoring are also accessible here. Click the D-Link logo to go to the D-Link website.
AREA 2	In this area is a toolbar used to access functions like Save , Tools , the Wizard , Online Help , accessing the Web UI in the Surveillance Mode , customized Language preference, and a Logout option. The user account and IP address currently logged into the Web UI will also be displayed in this toolbar.
AREA 3	In this area, the software features available in the Web UI of the Switch are grouped into folders containing hyperlinks that will open window frames in area 4.

Area Number	Description
	There is also a search option in this area that can be used to search for specific feature keywords in the Web UI to easily find the link to the set of features.
AREA 4	In this area, configuration and monitoring window frames are available based on the selections made in area 3.

After accessing the Web UI in the **Surveillance Mode**, the following will be displayed:

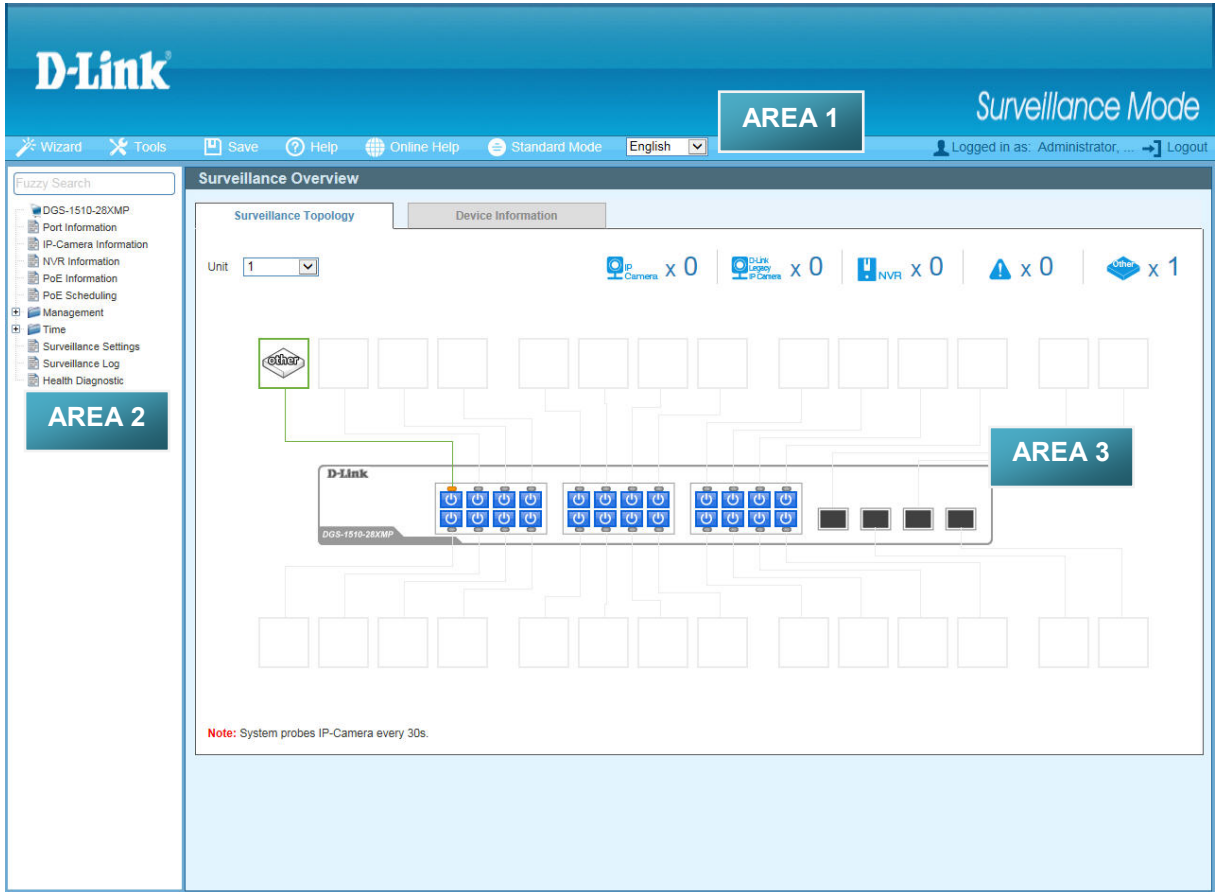

Figure 5-4 Web UI (Surveillance Mode)

The following **Areas** can be observed in the above window.

Area Number	Description
AREA 1	In this area is a toolbar used to access functions like the Wizard , Tools , Save , Help , Online Help , accessing the Web UI in the Standard Mode , customized Language preference, and a Logout option. The user account and IP address currently logged into the Web UI will also be displayed in this toolbar.
AREA 2	In this area, the software features available in the Web UI of the Switch are grouped into folders containing hyperlinks that will open window frames in area 3. There is also a search option in this area that can be used to search for specific feature keywords in the Web UI to easily find the link to the set of features.
AREA 3	In this area, configuration and monitoring window frames are available based on the selections made in area 2.

Appendix A – Technical Specifications

General

Feature	Detailed Description		
Standards	IEEE 802.1AB Link Layer Discovery Protocol IEEE 802.1D-2004 Spanning Tree Protocol IEEE 802.1p Priority Queues IEEE 802.1Q-2005 Virtual LAN IEEE 802.1S Multiple Spanning Tree Protocol IEEE 802.1W Rapid Spanning Tree Protocol IEEE 802.1X Port-based Authentication IEEE 802.3i 10BASE-T Ethernet IEEE 802.3u 100BASE-TX Fast Ethernet IEEE 802.3ab 1000BASE-T Gigabit Ethernet IEEE 802.3ad Link Aggregation IEEE 802.3ae 10GBASE-X/10GBASE-R/10GBASE-W IEEE 802.3af Power over Ethernet IEEE 802.3at Power over Ethernet IEEE 802.1az Energy-Efficient Ethernet IEEE 802.3x Flow Control support for Full-Duplex mode IEEE 802.3z 1000BASE-T Gigabit Ethernet		
Data Transfer Rates		Half-duplex	Full-duplex
	Ethernet	10 Mbps	20 Mbps
	Fast Ethernet	100 Mbps	200 Mbps
	Gigabit Ethernet	-	2 Gbps
	10 Gigabit Ethernet	-	20 Gbps
Stacking Topology	Duplex Ring, Duplex Chain		
Network Cables	UTP/STP Category 3, 4, 5 for 10BASE-T UTP/STP Category 5 Enhanced for 1000BASE-T UTP/STP Category.5, 5 Enhanced for 100BASE-TX EIA/TIA-568 100Ω screened twisted-pair (STP) (100m)		

Physical and Environmental

Feature	Detailed Description	
Internal Power Supply	DGS-1510-20:	100-240 VAC, 50/60 Hz, 24 Watt
	DGS-1510-28:	100-240 VAC, 50/60 Hz, 30 Watt
	DGS-1510-28P:	100-240 VAC, 50/60 Hz, 253 Watt
	DGS-1510-28X:	100-240 VAC, 50/60 Hz, 30 Watt
	DGS-1510-28XMP:	100-240 VAC, 50/60 Hz, 430 Watt
	DGS-1510-52:	100-240 VAC, 50/60 Hz, 54 Watt
	DGS-1510-52X (HW: A1):	100-240 VAC, 50/60 Hz, 54 Watt

Feature	Detailed Description	
	DGS-1510-52X (HW: A2):	100-240 VAC, 50/60 Hz, 54 Watt
	DGS-1510-52XMP:	100-240 VAC, 50/60 Hz, 589 Watt
Fans	The IC Sensor detects the temperature on the switch automatically, and adjusts the speed. The amount of fans that are installed per Switch are listed below:	
	DGS-1510-20:	1 fan
	DGS-1510-28:	1 fan
	DGS-1510-28P:	2 fans
	DGS-1510-28X:	1 fan
	DGS-1510-28XMP:	2 fans
	DGS-1510-52:	2 fans
	DGS-1510-52X (HW: A1):	2 fans
	DGS-1510-52X (HW: A2):	1 fan
	DGS-1510-52XMP:	4 fans
Maximum Power Consumption	DGS-1510-20:	20.3 Watt
	DGS-1510-28:	21.2 Watt
	DGS-1510-28P:	29.0 Watt (PoE off) and 238.7 Watt (PoE on)
	DGS-1510-28X:	22.3 Watt
	DGS-1510-28XMP:	38.4 Watt (PoE off) and 436.3 Watt (PoE on)
	DGS-1510-52:	38.4 Watt
	DGS-1510-52X (HW: A1):	44.22 Watt
	DGS-1510-52X (HW: A2):	48 Watt
	DGS-1510-52XMP:	53.9 Watt (PoE off) and 468.6 Watt (PoE on)
Standby Power Consumption	DGS-1510-20:	11.4 Watt (100V) and 12.2 Watt (240V)
	DGS-1510-28:	14.6 Watt (100V) and 15.2 Watt (240V)
	DGS-1510-28P:	22.7 Watt (100V) and 21.0 Watt (240V)
	DGS-1510-28X:	14.6 Watt (100V) and 15.2 Watt (240V)
	DGS-1510-28XMP:	24.5 Watt (100V) and 28.2 Watt (240V)
	DGS-1510-52:	27.3 Watt (100V) and 27.6 Watt (240V)
	DGS-1510-52X (HW: A1):	28.6 Watt (100V) and 28.9 Watt (240V)
	DGS-1510-52X (HW: A2):	30.4 Watt (100V) and 30.3 Watt (240V)
	DGS-1510-52XMP:	38.0 Watt (100V) and 38.6 Watt (240V)
Temperature	Operating:	-5 °C ~ 50 °C (23 °F ~ 122 °F)
	Storage:	-20 °C ~ 70 °C (-4 °F ~ 158 °F)
Humidity	Operating:	0 % ~ 95 % (non-condensing)
	Storage:	0 % ~ 95 % (non-condensing)

Feature	Detailed Description	
Dimensions	DGS-1510-20:	280 mm (W) 180 mm (D) 44 mm (H)
	DGS-1510-28:	441 mm (W) 210 mm (D) 44 mm (H)
	DGS-1510-28P:	441 mm (W) 210 mm (D) 44 mm (H)
	DGS-1510-28X:	441 mm (W) 210mm (D) 44mm (H)
	DGS-1510-28XMP:	441 mm (W) 310 mm (D) 44 mm (H)
	DGS-1510-52:	441 mm (W) 210 mm (D) 44 mm (H)
	DGS-1510-52X (HW: A1):	441 mm (W) 210 mm (D) 44 mm (H)
	DGS-1510-52X (HW: A2):	441 mm (W) 210 mm (D) 44 mm (H)
	DGS-1510-52XMP:	441 mm (W) 309 mm (D) 44 mm (H)
Weight	DGS-1510-20:	1.235 kg
	DGS-1510-28:	2.000 kg
	DGS-1510-28P:	2.536 kg
	DGS-1510-28X:	2.000 kg
	DGS-1510-28XMP:	4.246 kg
	DGS-1510-52:	2.400 kg
	DGS-1510-52X (HW: A1):	2.397 kg
	DGS-1510-52X (HW: A2):	3.1 kg
	DGS-1510-52XMP:	5.41 kg
MTBF	DGS-1510-20:	882152.3682 hours
	DGS-1510-28:	516593.2513 hours
	DGS-1510-28P:	243090.6950 hours
	DGS-1510-28X:	516593.2513 hours
	DGS-1510-28XMP:	274796.3861 hours
	DGS-1510-52:	433434.1606 hours
	DGS-1510-52X (HW: A1):	416789.0227 hours
	DGS-1510-52X (HW: A2):	423302.2461 hours
	DGS-1510-52XMP:	195178.1349 hours
EMI/EMC; Test Reports	CE Class A, FCC Class A, VCCI Report Class A, C-Tick Report Class A, BSMI, CCC.	
Safety Certifications and Test Reports	UL/CSA 60950-1, IEC 60950-1:2001, BSMI.	

Performance

Feature	Detailed Description
Transmission Method	Store-and-forward.
Packet Buffer	DGS-1510-20/28/28P/28X/28XMP: 1.5 MB per device.

Feature	Detailed Description	
	DGS-1510-52/52X (HW: A1 and A2)/52XMP: 3 MB per device.	
Wire Speed	Wire speed operation on all FE/GE/10GE ports.	
Switching Capacity	DGS-1510-20:	76 Gbps
	DGS-1510-28:	92 Gbps
	DGS-1510-28P:	92 Gbps
	DGS-1510-28X:	128 Gbps
	DGS-1510-28XMP:	128 Gbps
	DGS-1510-52:	140 Gbps
	DGS-1510-52X (HW: A1):	176 Gbps
	DGS-1510-52X (HW: A2):	176 Gbps
	DGS-1510-52XMP:	176 Gbps
Packet Forwarding Rate (64 Byte System)	DGS-1510-20:	56.54 Mpps (Mega Packets Per Second)
	DGS-1510-28:	68.45 Mpps (Mega Packets Per Second)
	DGS-1510-28P:	68.45 Mpps (Mega Packets Per Second)
	DGS-1510-28X:	95.24 Mpps (Mega Packets Per Second)
	DGS-1510-28XMP:	95.24 Mpps (Mega Packets Per Second)
	DGS-1510-52:	104.16 Mpps (Mega Packets Per Second)
	DGS-1510-52X (HW: A1):	130.95 Mpps (Mega Packets Per Second)
	DGS-1510-52X (HW: A2):	130.95 Mpps (Mega Packets Per Second)
	DGS-1510-52XMP:	130.95 Mpps (Mega Packets Per Second)
Priority Queues	8 Priority Queues per port.	
MAC Address Table	Supports the following: <ul style="list-style-type: none"> • Up to 16,384 MAC addresses • Up to 512 static MAC addresses 	
Physical Stacking	Supports the following: <ul style="list-style-type: none"> • Two dedicated stacking ports on the front panel of the Switch. The last two SFP+ ports are used for physical stacking. • Provides bi-directional redundant stacking topology • Linear and Ring stacking topologies • Up to 40 Gbps full-duplex bandwidth • Up to 6 units per stack • Backup master • Inter-stacking trunking and mirroring 	
Virtual Stacking / Clustering	Supports the following: <ul style="list-style-type: none"> • D-Link Single IP Management version 1.6 • Manage up to 32 devices in a virtual stack with a single IP address 	

LED Indicators

Per Switch

LED Indicator	Color	Status	Description
Power	Green	Solid light	Power on
		Blinking	Performing System Self-test
		Light off	Power off
Console	Green	Solid light	Console on
		Light off	Console off
Fan	Green	Solid light	Diagnostics passed and in normal operation
	Red	Solid light	Fan failure
Stack ID	Green	Capable 1-6, H, h, E, G	<p>One of the following will be displayed:</p> <ul style="list-style-type: none"> 1-6: Indicates the Unit ID of the Switch H: Indicates the Switch is the Primary Master h: Indicates the Switch is the Backup Master E: As error occurred during System Self-test G: The Safeguard Engine is entering the exhausted mode <p>The Stack ID (Unit ID) is assigned either by the user (static mode) or by the system (automatic mode). When the Switch is assigned as the primary or backup master in the stack, the Stack ID will toggle between the letters 'H' or 'h' and the Unit ID.</p>
Port LED Mode Indicator (DGS-1510-28P, DGS-1510-28XMP, and DGS-1510-52XMP Only)	An LED Mode Select Button to switch two modes in turn for all 10/100/1000Mbps ports: <ul style="list-style-type: none"> Link/Act/Speed Mode PoE Mode 		
	Green	Solid light	An LED Mode Select Button to switch Link/Act/Speed Mode
		Solid light	An LED Mode Select Button to switch PoE Mode

Per RJ45 Port

LED Indicator	Color	Status	Description
Link/Act/Speed Mode	Green	Solid light	When there is a secure connection (or link) to 1000Mbps Ethernet device at any of the ports
		Blinking	When there is reception or transmission of data occurring at 1000Mbps
	Orange	Solid light	When there is a secure connection (or link) to 10/100Mbps Ethernet device at any of the ports
		Blinking	When there is reception or transmission of data occurring at 10/100Mbps
	Off	Light off	No link
PoE Mode	Green	Solid light	Power feeding
	Orange	Solid light	Error condition

LED Indicator	Color	Status	Description
(DGS-1510-28P, DGS-1510-28XMP, and DGS-1510-52XMP Only)	Off	Light off	No power feeding

Per SFP Port

LED Indicator	Color	Status	Description
Link/Act	Green	Solid light	When there is a secure connection (or link) to 1000Mbps Ethernet device at any of the ports
		Blinking	When there is reception or transmission of data occurring at 1000Mbps

Per SFP+ Port

LED Indicator	Color	Status	Description
Link/Act	Green	Solid light	When there is a secure connection (or link) to 10G bps Ethernet device at any of the ports
		Blinking	When there is reception or transmission (i.e. Activity--Act) of data occurring at a 10G bps port
	Orange	Solid light	When there is a secure connection (or link) to 1000Mbps Ethernet device at any of the ports
		Blinking	When there is reception or transmission (i.e. Activity--Act) of data occurring at a 1000Mbps port
	Off	Light off	Link down

Port Functions

Feature	Detailed Description
Console Port	RJ-45 interface for Out-Of-Band (OOB) CLI configuration
Copper Ports	Compliant with the following standards: <ul style="list-style-type: none"> IEEE 802.3 compliance IEEE 802.3u compliance IEEE 802.3ab compliance IEEE 802.3az compliance (100/1000Mbps)
	Supports the following full-duplex operations: <ul style="list-style-type: none"> IEEE 802.3x Flow Control support for Full-Duplex mode IEEE 802.3af compliance (DGS-1510-28P, DGS-1510-28XMP, and DGS-1510-52XMP Only) IEEE 802.3at compliance (DGS-1510-28P, DGS-1510-28XMP, and DGS-1510-52XMP Only)
SFP Ports	Compliant with the following standards: <ul style="list-style-type: none"> IEEE 802.3z compliance
	Supports to following SFP transceivers:

Feature	Detailed Description
	<ul style="list-style-type: none"> • DEM-302S-LX (1000BASE-LX, Single-mode, 2 km) • DEM-310GT (1000BASE-LX, Single-mode, 10 km) • DEM-311GT (1000BASE-SX, Multi-mode, 550 m) • DEM-312GT2 (1000BASE-SX, Multi-mode, 2 km) • DEM-314GT (1000BASE-LHX, Single-mode, 50 km) • DEM-315GT (1000BASE-ZX, Single-mode, 80 km) • DGS-712 (1000BASE-TX) <p>Supports to following WDM transceivers:</p> <ul style="list-style-type: none"> • DEM-302S-BXD/BCU (1000BASE-BX, Single-mode, 2 km) • DEM-330T/R (1000BASE-BX, Single-Mode, 10 km) • DEM-331T/R (1000BASE-BX, Single-Mode, 40 km)
<p>SFP+ Ports</p>	<p>Compliant with the following standards:</p> <ul style="list-style-type: none"> • IEEE 802.3ae compliance • IEEE 802.3z compliance <p>Supports to following SFP/WDM transceivers:</p> <ul style="list-style-type: none"> • All supported SFP/WDM transceivers will work in SFP+ ports <p>Supports to following SFP+ transceivers:</p> <ul style="list-style-type: none"> • DEM-431XT-DD (10GBASE-SR SFP+ Transceiver, 80 m: OM1 & OM2 MMF 300 m: OM3 MMF) • DEM-431XT (10GBASE-SR SFP+ Transceiver (w/o DDM), 80 m: OM1 & OM2 MMF 300 m: OM3 MMF) • DEM-432XT-DD (10GBASE-LR SFP+ Transceiver, 10 km) • DEM-432XT (10GBASE-LR SFP+ Transceiver (w/o DDM), 10 km) • DEM-433XT-DD (10GBASE-ER SFP+ Transceiver, 40 km) • DEM-433XT (10GBASE-ER SFP+ Transceiver (w/o DDM), 40 km) • DEM-434XT (10GBASE-ZR SFP+ Transceiver (w/o DDM), 80 km) • DEM-436XT-BXU (10GBASE-LR BiDi SFP+ Transceiver (w/o DDM), 20 km, TX: 1270 nm, RX: 1330 nm) • DEM-436XT-BXD (10GBASE-LR BiDi SFP+ Transceiver (w/o DDM), 20 km, TX: 1330 nm, RX: 1270 nm) <p>Supports to following SFP+ Direct Attached Cables (DAC):</p> <ul style="list-style-type: none"> • DEM-CB100S-10-GbE (SFP+, 1 m, Direct Attach Cable), for stacking • DEM-CB300S-10-GbE (SFP+, 3 m Direct Attach Cable), for stacking • DEM-CB700S-10-GbE (SFP+, 7 m Direct Attach Cable), for stacking
<p>PoE Ports (DGS-1510-28P, DGS-1510-28XMP, and DGS-1510-52XMP Only)</p>	<p>Supports the following:</p> <ul style="list-style-type: none"> • IEEE 802.3af PoE and IEEE 802.3at PoE+ compliance • Power (ports 1 to 24) to PD devices up to 15.4 Watt per port (802.3af) or 30 Watt per port (802.3at) and more sufficiently is able to provide power to PD devices • The auto-discovery feature automatically recognizes the connection of the PD device and immediately provides power • Automatically disable ports if the port current is over 600mA while. Other ports will remain active

Feature	Detailed Description		
	<ul style="list-style-type: none"> Active circuit protection automatically disables the port if there is a short while other ports remain active For 802.3af/at capable devices it will provide the power for the following classifications below: 		
	Class	Usage	Max Power used by PD
	0	Default	0.44 Watt to 12.95 Watt
	1	Optional	0.44 Watt to 3.84 Watt
	2	Optional	3.84 Watt to 6.49 Watt
	3	Optional	6.49 Watt to 12.95 Watt
	4	Optional (802.3at Only)	12.95 Watt to 25.5 Watt
<ul style="list-style-type: none"> Follow the PSE pin out standard. For an alternative solution, send the power over pins 1, 2, 3, and 6 of 8 wires. Use Category 3, 6A UTP cable for 802.3af or Category 5e, 6A UTP cable for 802.3at The PoE switch works with all D-Link 802.3af and 802.3at capable devices and with all non-802.3af and non-802.3at capable D-Link Access Points, IP Cameras and IP Phones The total PoE power budget of the: <ul style="list-style-type: none"> DGS-1510-28P is 193 Watts DGS-1510-28XMP is 370 Watts DGS-1510-52XMP is 370 Watts or 740 Watts with DPS-700 			

Appendix B – Cables and Connectors

Ethernet Cable

When connecting the Switch to another switch, a bridge or hub, a normal cable is necessary. Please review these products for matching cable pin assignment. The following diagrams and tables show the standard RJ-45 connector and their pin assignments.

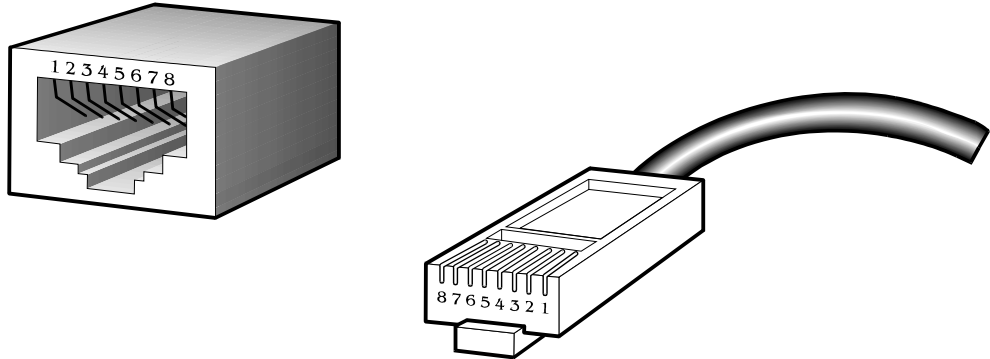

Figure B-1 Standard RJ-45 port and connector

RJ-45 PIN Assignments:

Pin	MDI-X Port	MDI-II Port
1	RD+ (receive)	TD+ (transmit)
2	RD- (receive)	TD- (transmit)
3	TD+ (transmit)	RD+ (receive)
4	1000BASE-T	1000BASE-T
5	1000BASE-T	1000BASE-T
6	TD- (transmit)	RD- (receive)
7	1000BASE-T	1000BASE-T
8	1000BASE-T	1000BASE-T

Console Cable

When connecting the Switch to a PC, a Console cable is necessary. The following diagrams and tables show the standard Console-to-DJ-45 receptacle/connector and their pin assignments.

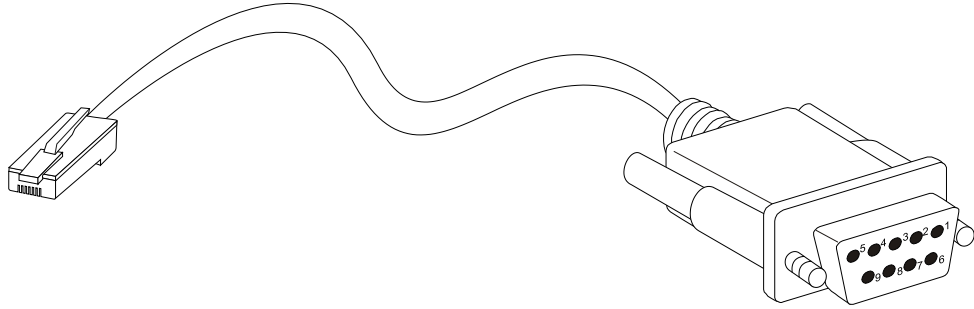

Figure B-2 Console-to-RJ-45 Cable

Console-to-RJ-45 PIN Assignments:

Pin	Console (DB9/RS232)	RJ-45
1	Not Used	Not Used
2	RXD	Not Used
3	TXD	TXD
4	Not Used	GND
5	GND (shared)	GND
6	Not Used	RXD
7	Not Used	Not Used
8	Not Used	Not Used

Redundant Power Supply (RPS) Cable

When connecting the Switch to a Redundant Power Supply, an RPS cable is necessary. Please review these products for matching cable pin assignment. The following diagrams and tables show the standard RPS receptacle/connector and their pin assignments.

22-pin DC power cable

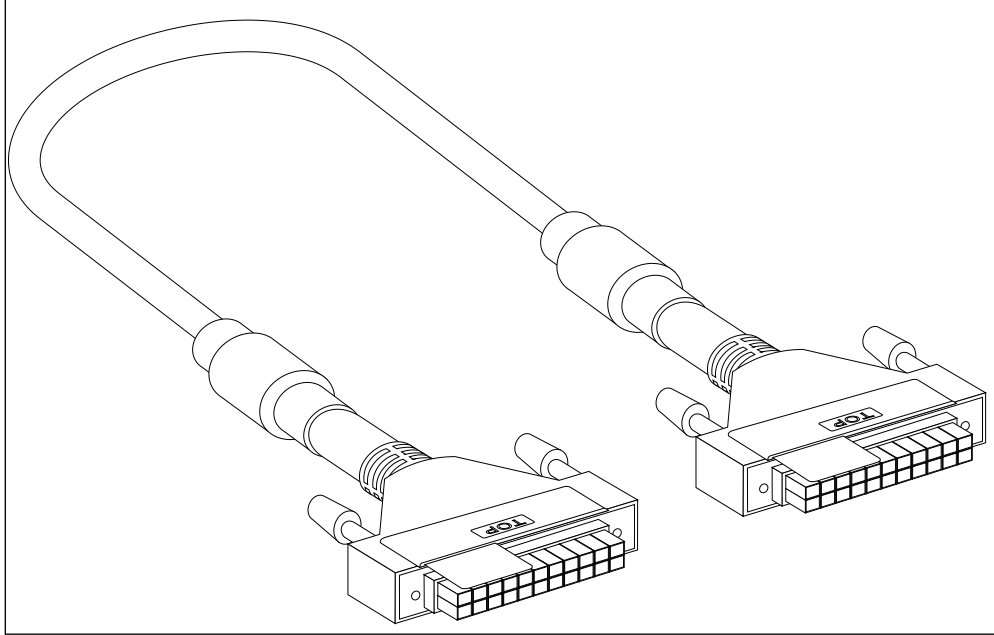

Figure B-2 Redundant Power Supply (RPS) 22-pin DC Power Cable

RPS 22-pin DC Power Cable Pin Assignments		
Pin	Device	DPS-700
1	-54Vrtn	-54Vrtn
2	-54V	-54V
3	+12V	+12V
4	+12V	+12V
5	+12V	+12V
6	+12V	+12V
7	NC/GND	GND
8	+12Ven	+12Ven
9	LS-54V	LS-54V
10	-54V	-54V
11	-54Vrtn	-54Vrtn
12	GND	NC/GND
13	GND	GND
14	RPS Present	Status_2
15	Status_1	RPS PG
16	Status_2	RPS Present
17	RPS PG	Status_1

18	GND	GND
19	+12VRTNsen	+12VRTNsen
20	LS+12V	LS+12V
21	-54Vsen	-54Vsen
22	-54VRTNsen	-54VRTNsen

Appendix C – ERPS Information

Only hardware-based ERPS (external PHY) supports the fast link drop interrupt feature with a recovery time of 50ms.

Model Name	ERPS	Port 1 to 20
DGS-1510-20	Hardware-based	
	Software-based	V

Model Name	ERPS	Port 1 to 8	Port 9 to 28
DGS-1510-28 DGS-1510-28P	Hardware-based	V	
DGS-1510-28X DGS-1510-28XMP	Software-based		V

Model Name	ERPS	Port 1 to 8	Port 9 to 24	Port 25 to 32	Port 33 to 52
DGS-1510-52	Hardware-based	V		V	
	Software-based		V		V

Model Name	ERPS	Port 1 to 8	Port 9 to 24	Port 25 to 32	Port 33 to 48	Port 49 and 50	Port 51 and 52
DGS-1510-52X (HW: A1)	Hardware-based	V		V		V	
	Software-based		V		V		V

Model Name	ERPS	Port 1 to 16	Port 17 to 24	Port 25 to 40	Port 41 to 48	Port 49 to 52
DGS-1510-52X (HW: A2) DGS-1510-52XMP	Hardware-based		V		V	
	Software-based	V		V		V

Subject to the terms and conditions set forth herein, D-Link Systems, Inc. ("D-Link") provides this Limited Warranty:

- Only to the person or entity that originally purchased the product from D-Link or its authorized reseller or distributor, and
- Only for products purchased and delivered within the fifty states of the United States, the District of Columbia, U.S. Possessions or Protectorates, U.S. Military Installations, or addresses with an APO or FPO.

Limited Warranty: D-Link warrants that the hardware portion of the D-Link product described below ("Hardware") will be free from material defects in workmanship and materials under normal use from the date of original retail purchase of the product, for the period set forth below ("Warranty Period"), except as otherwise stated herein.

Limited Lifetime Warranty for the product is defined as follows:

- Hardware: For as long as the original customer/end user owns the product, or five (5) years after product discontinuance, whichever occurs first (excluding power supplies and fans)
- Power supplies and fans: Three (3) Year
- Spare parts and spare kits: Ninety (90) days

The customer's sole and exclusive remedy and the entire liability of D-Link and its suppliers under this Limited Warranty will be, at D-Link's option, to repair or replace the defective Hardware during the Warranty Period at no charge to the original owner or to refund the actual purchase price paid. Any repair or replacement will be rendered by D-Link at an Authorized D-Link Service Office. The replacement hardware need not be new or have an identical make, model or part. D-Link may, at its option, replace the defective Hardware or any part thereof with any reconditioned product that D-Link reasonably determines is substantially equivalent (or superior) in all material respects to the defective Hardware. Repaired or replacement hardware will be warranted for the remainder of the original Warranty Period or ninety (90) days, whichever is longer, and is subject to the same limitations and exclusions. If a material defect is incapable of correction, or if D-Link determines that it is not practical to repair or replace the defective Hardware, the actual price paid by the original purchaser for the defective Hardware will be refunded by D-Link upon return to D-Link of the defective Hardware. All Hardware or part thereof that is replaced by D-Link, or for which the purchase price is refunded, shall become the property of D-Link upon replacement or refund.

Limited Software Warranty: D-Link warrants that the software portion of the product ("Software") will substantially conform to D-Link's then current functional specifications for the Software, as set forth in the applicable documentation, from the date of original retail purchase of the Software for a period of ninety (90) days ("Software Warranty Period"), provided that the Software is properly installed on approved hardware and operated as contemplated in its documentation. D-Link further warrants that, during the Software Warranty Period, the magnetic media on which D-Link delivers the Software will be free of physical defects. The customer's sole and exclusive remedy and the entire liability of D-Link and its suppliers under this Limited Warranty will be, at D-Link's option, to replace the non-conforming Software (or defective media) with software that substantially conforms to D-Link's functional specifications for the Software or to refund the portion of the actual purchase price paid that is attributable to the Software. Except as otherwise agreed by D-Link in writing, the replacement Software is provided only to the original licensee, and is subject to the terms and conditions of the license granted by D-Link for the Software. Replacement Software will be warranted for the remainder of the original Warranty Period and is subject to the same limitations and exclusions. If a material non-conformance is incapable of correction, or if D-Link determines in its sole discretion that it is not practical to replace the non-conforming Software, the price paid by the original licensee for the non-conforming Software will be refunded by D-Link; provided that the non-conforming Software (and all copies thereof) is first returned to D-Link. The license granted respecting any Software for which a refund is given automatically terminates.

Non-Applicability of Warranty: The Limited Warranty provided hereunder for Hardware and Software portions of D-Link's products will not be applied to and does not cover any refurbished product and any product purchased through the inventory clearance or liquidation sale or other sales in which D-Link, the sellers, or the liquidators expressly disclaim their warranty obligation pertaining to the product and in that case, the product is being sold "As-Is" without any warranty whatsoever including, without limitation, the Limited Warranty as described herein, notwithstanding anything stated herein to the contrary.

Submitting A Claim: The customer shall return the product to the original purchase point based on its return policy. In case the return policy period has expired and the product is within warranty, the customer shall submit a claim to D-Link as outlined below:

- The customer must submit with the product as part of the claim a written description of the Hardware defect or Software nonconformance in sufficient detail to allow D-Link to confirm the same, along with proof of purchase of the product (such as a copy of the dated purchase invoice for the product) if the product is not registered.
- The customer must obtain a Case ID Number from D-Link Technical Support at 1-877-453-5465, who will attempt to assist the customer in resolving any suspected defects with the product. If the product is considered defective, the customer must obtain a Return Material Authorization ("RMA") number by completing the RMA form and entering the assigned Case ID Number at <https://rma.dlink.com/>.
- After an RMA number is issued, the defective product must be packaged securely in the original or other suitable shipping package to ensure that it will not be damaged in transit, and the RMA number must be prominently marked on the outside of the package. Do not include any manuals or accessories in the shipping package. D-Link will only replace the defective portion of the product and will not ship back any accessories.
- The customer is responsible for all in-bound shipping charges to D-Link. No Cash on Delivery ("COD") is allowed. Products sent COD will either be rejected by D-Link or become the property of D-Link. Products shall be fully insured by the customer and shipped to **D-Link Systems, Inc., 17595 Mt. Herrmann, Fountain Valley, CA 92708**. D-Link will not be held responsible for any packages that are lost in transit to D-Link. The repaired or replaced packages will be shipped to the customer via UPS Ground or any common carrier selected by D-Link. Return shipping charges shall be prepaid by D-Link if you use an address in the United States, otherwise we will ship the product to you freight collect. Expedited shipping is available upon request and provided shipping charges are prepaid by the customer.

D-Link may reject or return any product that is not packaged and shipped in strict compliance with the foregoing requirements, or for which an RMA number is not visible from the outside of the package. The product owner agrees to pay D-Link's reasonable handling and return shipping charges for any product that is not packaged and shipped in accordance with the foregoing requirements, or that is determined by D-Link not to be defective or non-conforming.

What Is Not Covered: The Limited Warranty provided herein by D-Link does not cover: Products that, in D-Link's judgment, have been subjected to abuse, accident, alteration, modification, tampering, negligence, misuse, faulty installation, lack of reasonable care, repair or service in any way that is not contemplated in the documentation for the product, or if the model or serial number has been altered, tampered with, defaced or removed; Initial installation, installation and removal of the product for repair, and shipping costs; Operational adjustments covered in the operating manual for the product, and normal maintenance; Damage that occurs in shipment, due to act of God, failures due to power surge, and cosmetic damage; Any hardware, software, firmware or other products or services provided by anyone other than D-Link; and Products that have been purchased from inventory clearance or liquidation sales or other sales in which D-Link, the sellers, or the liquidators expressly disclaim their warranty obligation pertaining to the product. While necessary maintenance or repairs on your Product can be performed by any company, we recommend that you use only an Authorized D-Link Service Office. Improper or incorrectly performed maintenance or repair voids this Limited Warranty.

Disclaimer of Other Warranties: EXCEPT FOR THE LIMITED WARRANTY SPECIFIED HEREIN, THE PRODUCT IS PROVIDED "AS-IS" WITHOUT ANY WARRANTY OF ANY KIND WHATSOEVER INCLUDING, WITHOUT LIMITATION, ANY WARRANTY OF MERCHANTABILITY, FITNESS FOR A PARTICULAR PURPOSE AND NON-INFRINGEMENT. IF ANY IMPLIED WARRANTY CANNOT BE DISCLAIMED IN ANY TERRITORY WHERE A PRODUCT IS SOLD, THE DURATION OF SUCH IMPLIED WARRANTY SHALL BE LIMITED TO NINETY (90) DAYS. EXCEPT AS EXPRESSLY COVERED UNDER THE LIMITED WARRANTY PROVIDED HEREIN, THE ENTIRE RISK AS TO THE QUALITY, SELECTION AND PERFORMANCE OF THE PRODUCT IS WITH THE PURCHASER OF THE PRODUCT.

Limitation of Liability: TO THE MAXIMUM EXTENT PERMITTED BY LAW, D-LINK IS NOT LIABLE UNDER ANY CONTRACT, NEGLIGENCE, STRICT LIABILITY OR OTHER LEGAL OR EQUITABLE THEORY FOR ANY LOSS OF USE OF THE PRODUCT, INCONVENIENCE OR DAMAGES OF ANY CHARACTER, WHETHER DIRECT, SPECIAL, INCIDENTAL OR CONSEQUENTIAL (INCLUDING, BUT NOT LIMITED TO, DAMAGES FOR LOSS OF GOODWILL, LOSS OF REVENUE OR PROFIT, WORK STOPPAGE, COMPUTER FAILURE OR MALFUNCTION, FAILURE OF OTHER EQUIPMENT OR COMPUTER PROGRAMS TO WHICH D-LINK'S PRODUCT IS CONNECTED WITH, LOSS OF INFORMATION OR DATA CONTAINED IN, STORED ON, OR INTEGRATED WITH ANY PRODUCT RETURNED TO D-LINK FOR WARRANTY SERVICE) RESULTING FROM THE USE OF THE PRODUCT, RELATING TO WARRANTY SERVICE, OR ARISING OUT OF ANY BREACH OF THIS LIMITED WARRANTY, EVEN IF D-LINK HAS BEEN ADVISED OF THE POSSIBILITY OF SUCH DAMAGES. THE SOLE REMEDY FOR A BREACH OF THE FOREGOING LIMITED WARRANTY IS REPAIR, REPLACEMENT OR REFUND OF THE DEFECTIVE OR NON-CONFORMING PRODUCT. THE MAXIMUM LIABILITY OF D-LINK UNDER THIS WARRANTY IS LIMITED TO THE PURCHASE PRICE OF THE PRODUCT COVERED BY THE WARRANTY. THE FOREGOING EXPRESS WRITTEN WARRANTIES AND REMEDIES ARE EXCLUSIVE AND ARE IN LIEU OF ANY OTHER WARRANTIES OR REMEDIES, EXPRESS, IMPLIED OR STATUTORY.

Governing Law: This Limited Warranty shall be governed by the laws of the State of California. Some states do not allow exclusion or limitation of incidental or consequential damages, or limitations on how long an implied warranty lasts, so the foregoing limitations and exclusions may not apply. This Limited Warranty provides specific legal rights and you may also have other rights which vary from state to state.

Trademarks: D-Link is a registered trademark of D-Link Systems, Inc. Other trademarks or registered trademarks are the property of their respective owners.

Copyright Statement: No part of this publication or documentation accompanying this product may be reproduced in any form or by any means or used to make any derivative such as translation, transformation, or adaptation without permission from D-Link Corporation/D-Link Systems, Inc., as stipulated by the United States Copyright Act of 1976 and any amendments thereto. Contents are subject to change without prior notice. Copyright 2004 by D-Link Corporation/D-Link Systems, Inc. All rights reserved.

CE Mark Warning: This is a Class A product. In a residential environment, this product may cause radio interference, in which case the user may be required to take adequate measures.

FCC Statement: This equipment has been tested and found to comply with the limits for a Class A digital device, pursuant to part 15 of the FCC Rules. These limits are designed to provide reasonable protection against harmful interference in a commercial installation. This equipment generates, uses, and can radiate radio frequency energy and, if not installed and used in accordance with the instructions, may cause harmful interference to radio communication. However, there is no guarantee that interference will not occur in a particular installation. Operation of this equipment in a residential environment is likely to cause harmful interference to radio or television reception. If this equipment does cause harmful interference to radio or television reception, which can be determined by turning the equipment off and on, the user is encouraged to try to correct the interference by one or more of the following measures:

- Reorient or relocate the receiving antenna.
- Increase the separation between the equipment and receiver.
- Connect the equipment into an outlet on a circuit different from that to which the receiver is connected.
- Consult the dealer or an experienced radio/TV technician for help.

For detailed warranty information applicable to products purchased outside the United States, please contact the corresponding local D-Link office.

Product Registration

Register your D-Link product online at <http://support.dlink.com/register/>

Product registration is entirely voluntary and failure to complete or return this form will not diminish your warranty rights.

Technical Support

U.S. and Canadian customers

This guide is only for initial configuration. Please refer to the user manual to learn more or visit <http://www.mydlink.com> for more information. Also feel free to contact us. U.S. and Canadian customers can contact D-Link Technical Support through our website.

USA

<http://support.dlink.com>

Canada

<http://support.dlink.ca>

Europe customers

TECHNICAL SUPPORT	dlink.com/support
TECHNISCHE UNTERSTÜTZUNG	
ASSISTANCE TECHNIQUE	
ASISTENCIA TÉCNICA	
SUPPORTO TECNICO	
TECHNISCHE ONDERSTEUNING	
POMOC TECHNICZNA	
TECHNICKÁ PODPORA	
TECHNICKÁ PODPORA	
TECHNIKAI TÁMOGATÁS	
TEKNISK SUPPORT	
TEKNISK SUPPORT	
TEKNISK STØTTE	
TEKNINEN TUKI	
ASSISTÊNCIA TÉCNICA	
ΤΕΧΝΙΚΗ ΥΠΟΣΤΗΡΙΞΗ	
TEHNIČKA PODRŠKA	
TEHNIČNA PODPORA	
SUPPORT TEHNIC	
ТЕХНИЧЕСКА ПОДДРЪЖКА	

Australia customers

Tel: 1300-700-100

24/7 Technical Support

Web: <http://www.dlink.com.au>

E-mail: support@dlink.com.au

India customers

Tel: +91-832-2856000 or 1860-233-3999

Web: www.dlink.co.in

E-Mail: helpdesk@in.dlink.com

Singapore, Thailand, Indonesia, Malaysia, Philippines,

Vietnam customers

Singapore - www.dlink.com.sg

Thailand - www.dlink.co.th

Indonesia - www.dlink.co.id

Malaysia - www.dlink.com.my

Philippines - www.dlink.com.ph

Vietnam - www.dlink.com.vn

Korea customers

Tel : +82-2-2028-1810

Monday to Friday 9:00am to 6:00pm

Web : <http://d-link.co.kr>

E-mail : g2b@d-link.co.kr

New Zealand customers

Tel: 0800-900-900

24/7 Technical Support

Web: <http://www.dlink.co.nz>

E-mail: support@dlink.co.nz

South Africa and Sub Sahara Region customers

Tel: +27 12 661 2025

08600 DLINK (for South Africa only)

Monday to Friday 8:30am to 9:00pm South Africa Time

Web: <http://www.d-link.co.za>

E-mail: support@za.dlink.com

D-Link Middle East - Dubai, U.A.E. customers

Plot No. S31102,

Jebel Ali Free Zone South,

P.O.Box 18224, Dubai, U.A.E.

Tel: +971-4-8809022

Fax: +971-4-8809066 / 8809069

Technical Support: +971-4-8809033

General Inquiries: info.me@me.dlink.com

Tech Support: support.me@me.dlink.com

Egypt customers

1, Makram Ebeid Street -

City Light Building - floor 5

Nasrcity - Cairo, Egypt

Tel.: +2 02 23521593 - +2 02 23520852

Technical Support: +2 02 26738470

General Inquiries: info.eg@me.dlink.com

Tech Support: support.eg@me.dlink.com

Kingdom of Saudi Arabia customers

Office # 84 ,

Al Khaleej Building (Mujamathu Al-Khaleej)

Opp. King Fahd Road, Olaya

Riyadh - Saudi Arabia

Tel: +966 1121 70008

Technical Support:

+966 1121 70009

General Inquiries: info.sa@me.dlink.com

Tech Support: support.sa@me.dlink.com

Pakistan customers

Islamabad Office:

61-A, Jinnah Avenue, Blue Area,
Suite # 11, EBC, Saudi Pak Tower,
Islamabad - Pakistan

Tel.: +92-51-2800397, 2800398

Fax: +92-51-2800399

Karachi Office:

D-147/1, KDA Scheme # 1,
Opposite Mudassir Park, Karsaz Road,
Karachi – Pakistan

Phone: +92-21-34548158, 34326649

Fax: +92-21-4375727

Technical Support: +92-21-34548310, 34305069

General Inquiries: info.pk@me.dlink.com

Tech Support: support.pk@me.dlink.com

Morocco customers

M.I.T.C

Route de Nouaceur angle RS et CT 1029 Bureau N° 312 ET 337
Casablanca , Maroc

Phone : +212 663 72 73 24

Email: support.na@me.dlink.com

Lebanon RMA center customers

Dbayeh/Lebanon

PO Box:901589

Tel: +961 4 54 49 71 Ext:14

Fax: +961 4 54 49 71 Ext:12

Email: taoun@me.dlink.com

Bahrain customers

Technical Support: +973 1 3332904

Kuwait customers

Technical Support: + 965 22453939 / +965 22453949

Техническая Поддержка

Обновления программного обеспечения и документация доступны на Интернет-сайте D-Link.

D-Link предоставляет бесплатную поддержку для клиентов в течение гарантийного срока.

Клиенты могут обратиться в группу технической поддержки D-Link по телефону или через Интернет.

Техническая поддержка компании D-Link работает в круглосуточном режиме ежедневно, кроме официальных праздничных дней. Звонок бесплатный по всей России.

Техническая поддержка D-Link:

8-800-700-5465

Техническая поддержка через Интернет:

<http://www.dlink.ru>

e-mail: support@dlink.ru

Изготовитель:

Д-Линк Корпорейшн, 114, Тайвань, Тайпей, Нэйху Дистрикт, Шинху 3-Роуд, № 289

Уполномоченный представитель, импортер:

ООО "Д-Линк Трейд"

390043, г.Рязань, пр. Шабулина, д.16

Тел.: +7 (4912) 503-505

Офисы

Россия

Москва, Графский переулок, 14

Тел. : +7 (495) 744-00-99

E-mail: mail@dlink.ru

Україна

Київ, вул. Межигірська, 87-А

Тел.: +38 (044) 545-64-40

E-mail: ua@dlink.ua

Moldova

Chisinau; str.C.Negruzzi-8

Tel: +373 (22) 80-81-07

E-mail: info@dlink.md

Беларусь

Мінск, пр-т Незалежнасці, 169

Тэл.: +375 (17) 218-13-65

E-mail: support@dlink.by

Қазақстан

Алматы, Құрманғазы к-сі, 143 үй

Тел.: +7 (727) 378-55-90

E-mail: almaty@dlink.ru

Հայաստան

Երևան, Դավթաշեն 3-րդ

թաղամաս, 23/5

Հեռ.՝ +374 (10) 39-86-67

Էլ. փոստ՝ info@dlink.am

Latvija

Rīga, Lielirbes iela 27

Tel.: +371 (6) 761-87-03

E-mail: info@dlink.lv

Lietuva

Vilnius, Žirmūnu 139-303

Tel.: +370 (5) 236-36-29

E-mail: info@dlink.lt

Eesti

E-mail: info@dlink.ee

Türkiye

Uphill Towers Residence A/99

Ataşehir /ISTANBUL

Tel: +90 (216) 492-99-99

Email: info.tr@dlink.com.tr

ישראל

20 רח' המגשימים

קרית מטלון

פתח תקווה

072-2575555

support@dlink.co.il

Soporte Técnico Para Usuarios En Latino America

Por favor revise el número telefónico del Call Center de su país en <http://www.dlinkla.com/soporte/call-center>

Soporte Técnico de D-Link a través de Internet

Horario de atención Soporte Técnico en www.dlinkla.com

e-mail: soporte@dlinkla.com & consultas@dlinkla.com

Clientes de Brasil

Caso tenha dúvidas na instalação do produto, entre em contato com o Suporte Técnico D-Link.

Acesse o site: **www.dlink.com.br/suporte**

D-Link 友訊科技 台灣分公司 技術支援資訊

如果您還有任何本使用手冊無法協助您解決的產品相關問題，台灣、香港或是澳門用戶可至網站、電子郵件或電話等方式與D-Link技術支援工程師聯絡。

台灣D-Link免付費技術諮詢專線

台灣技術諮詢服務專線 0800-002-615

台灣手機付費電話 (02) 6600-0123#8715

台灣服務時間：週一至週五：9:00~21:00

週六日及國定假日(不含農曆春節) 10:00~19:00

台灣網站：<http://www.dlink.com.tw>

台灣電子郵件：dssqa_service@dlink.com.tw

產品保固期限、台灣區維修據點查詢，請參考<http://www.dlink.com.tw>網頁說明。

香港、澳門D-Link技術諮詢專線

香港技術諮詢服務專線 (852) 8100 8892

香港服務時間：週一至週五9:00AM~1:00PM及2:00PM~6:00PM

週六 9:00AM~1:00PM

香港網站：<http://www.dlink.com.hk>

香港電子郵件：service@cn.synnex-grp.com

香港、澳門維修據點查詢請參考<http://www.dlink.com.hk/contact.html> 網頁說明

如果您其他地區的用戶，請參考D-Link網站www.dlink.com 查詢全球各地分公司的聯絡資訊以取得相關支援服務。

Pelanggan Indonesia

Update perangkat lunak dan dokumentasi pengguna dapat diperoleh pada situs web D-Link.

Dukungan Teknis untuk pelanggan:

Tel: 0800-14014-97 (Layanan Bebas Pulsa)

Dukungan Teknis D-Link melalui Internet:

Pertanyaan Umum: sales@id.dlink.com

Bantuan Teknis: support@id.dlink.com

Website : <http://www.dlink.co.id>

日本のお客様

この度は弊社製品をお買い上げいただき、誠にありがとうございます。

製品に同梱されている保証書の購入元にお問い合わせください。

中国客户

技术支持中心电话：

400-629-6688(家用产品热线) 4006-828-828(企业产品热线)

技术支持中心邮箱：dlink400@cn.dlink.com

各地维修中心地址请登录官方网站查询

网址：<http://www.dlink.com.cn>

400电话工作时间：工作日9:00-19:00；节假日9:00-18:00

Registration Card

All Countries and Regions Excluding USA

Print, type or use block letters.

Your name: Mr./Ms _____

Organization: _____ Dept. _____

Your title at organization: _____

Telephone: _____ Fax: _____

Organization's full address: _____

Country: _____

Date of purchase (Month/Day/Year): _____

Product Model	Product Serial No.	* Product installed in type of computer	* Product installed in computer serial No.

(* Applies to adapters only)

Product was purchased from:

Reseller's name: _____

Telephone: _____

Answers to the following questions help us to support your product:

1. Where and how will the product primarily be used?

Home Office Travel Company Business Home Business Personal Use

2. How many employees work at installation site?

1 employee 2-9 10-49 50-99 100-499 500-999 1000 or more

3. What network protocol(s) does your organization use ?

XNS/IPX TCP/IP DECnet Others _____

4. What network operating system(s) does your organization use ?

D-Link LANsmart Novell NetWare NetWare Lite SCO Unix/Xenix PC NFS 3Com 3+Open Cisco Network
Banyan Vines DECnet Pathwork Windows NT Windows 98 Windows 2000/ME Windows XP
Others _____

5. What network management program does your organization use ?

D-View HP OpenView/Windows HP OpenView/Unix SunNet Manager Novell NMS
NetView 6000 Others _____

6. What network medium/media does your organization use ?

Fiber-optics Thick coax Ethernet Thin coax Ethernet 10BASE-T UTP/STP
100BASE-TX 1000BASE-T Wireless 802.11b and 802.11g wireless 802.11a Others _____

7. What applications are used on your network?

Desktop publishing Spreadsheet Word processing CAD/CAM
Database management Accounting Others _____

8. What category best describes your company?

Aerospace Engineering Education Finance Hospital Legal Insurance/Real Estate Manufacturing
Retail/Chain store/Wholesale Government Transportation/Utilities/Communication VAR
System house/company Other _____

9. Would you recommend your D-Link product to a friend?

Yes No Don't know yet

10. Your comments on this product?

PLEASE
PLACE STAMP
HERE

TO:

D-Link®