

User Manual

AC750 Dual-Band VDSL2/ADSL2+ Modem Router

Preface

D-Link reserves the right to revise this publication and to make changes in the content hereof without obligation to notify any person or organization of such revisions or changes.

Manual Revisions

Revision	Date	Description
1.00	August 23, 2018	Initial release

Trademarks

D-Link and the D-Link logo are trademarks or registered trademarks of D-Link Corporation or its subsidiaries in the United States or other countries. All other company or product names mentioned herein are trademarks or registered trademarks of their respective companies.

Apple®, Apple logo®, Safari®, iPhone®, iPad®, iPod touch® and Macintosh® are trademarks of Apple Inc., registered in the U.S. and other countries. App StoreSM is a service mark of Apple Inc.

Chrome™ browser, Google Play™ and Android™ are trademarks of Google Inc.

Internet Explorer®, Windows® and the Windows logo are trademarks of the Microsoft group of companies.

Copyright © 2018 by D-Link Corporation, Inc.

All rights reserved. This publication may not be reproduced, in whole or in part, without prior expressed written permission from D-Link Corporation, Inc.

ErP Power Usage

This device is an Energy Related Product (ErP) with High Network Availability (HiNA), and automatically switches to a power-saving Network Standby mode within 1 minute of no packets being transmitted. It can also be turned off through a power switch to save energy when it is not needed.

Network Standby: 4.761watts

Switched Off: 0.1878 watts

Table of Contents

Preface	i	Settings	26
Product Overview	1	Wizard	26
Package Contents.....	1	Internet.....	26
System Requirements.....	2	ADSL	27
Introduction	3	VDSL	29
Features.....	4	Ethernet.....	30
Hardware Overview	5	WAN Settings.....	31
Back Panel	5	Dynamic IP (DHCP).....	31
Side Panel	6	Static IP	32
LEDs	7	PPPoE.....	33
Installation	8	PPPoA.....	35
Before you Begin.....	8	Bridge Mode	37
Wireless Installation Considerations.....	9	Wireless	38
Manual Setup.....	10	Advanced Settings	39
Getting Started	12	Guest Zone	44
Setup Wizard	13	Network.....	45
Configuration	19	USB.....	48
Home	19	Features.....	49
Internet.....	20	Firewall	49
IPv4	21	Application.....	50
DSL	22	ACL.....	51
DSL-2878.....	23	Port Forwarding	52
Connected Clients	24	DMZ (Exposed Host)	54
USB Device	25	IP/MAC/Web Filtering.....	55
		IP Filter	55
		MAC Filter	57

Website Filter.....	58	Windows Vista®	93
Static Route.....	59	WPA/WPA2	94
Dynamic DNS	60	Troubleshooting	96
IGMP	61	Wireless Basics	100
Management.....	62	What is Wireless?.....	101
Time & Schedule	62	Tips.....	103
Time	62	Wireless Modes.....	104
Schedule	64	Networking Basics	105
Log Info	65	Check your IP address.....	105
System Log.....	66	Statically Assign an IP address	106
System Settings.....	67	Wireless Security	107
Admin.....	68	What is WPA?	107
Firmware Upgrade.....	69	Technical Specifications	108
Statistics	70	Regulatory Statements	109
Diagnostics	71		
Connect and Share a USB Device.....	72		
Connect and Share a USB Storage Device.....	72		
Connecting from a Windows-Based PC	73		
Connecting from a Mac.....	78		
Connect a Wireless Client to Your Router.....	82		
WPS Button.....	82		
Windows® 10	83		
Windows® 8.....	85		
WPA/WPA2	85		
Windows® 7.....	87		
WPA/WPA2	87		
WPS.....	89		

Package Contents



DSL-2878 AC750 Dual-Band VDSL2/ADSL2+ Modem Router



Power Adapter

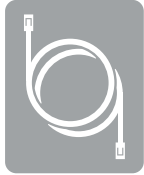

Ethernet Cable

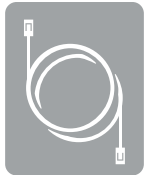

Phone Cable

If any of the above items are missing, please contact your reseller.

Note: Using a power supply other than the one included with the DSL-2878 may cause damage and void the warranty for this product.

System Requirements

Network Requirements	<ul style="list-style-type: none">• An active subscription with an Internet Service Provider using one of the following connection types:<ul style="list-style-type: none">• A VDSL/ADSL connection to a telephone line using the DSL port• An 802.11ac/n/g/b/a wireless or Ethernet port
Web-based Configuration Utility Requirements	<p>Computer with the following:</p> <ul style="list-style-type: none">• Microsoft Windows® 10/8/7/Vista/XP SP3 or Mac with OS X 10.7 or higher• An installed Ethernet adapter <p>Browser Requirements:</p> <ul style="list-style-type: none">• Internet Explorer 8 or higher• EDGE Browser 20 or higher• Firefox 20 or higher• Safari 4 or higher• Chrome 17 or higher <p>Windows® Users: Make sure you have the latest version of Java installed. Visit www.java.com to download the latest version.</p>

Introduction

The D-Link DSL-2878 AC750 Dual-Band VDSL2/ADSL2+ Modem Router shares your DSL Internet connection over blazing fast Wireless AC. It also comes equipped with a USB port, and four Gigabit Ethernet 10/100/1000 ports.

The DSL-2878's USB sharing technology lets you take advantage of file sharing. Simply plug in a USB storage drive into the USB port on the back of your DSL-2878 and you can access files, stream videos, view photos, or listen to music on your laptop or mobile devices. The intuitive interface lets anyone immediately connect to a variety of entertainment options stored on your own storage device.

The DSL-2878 provides incredible speeds, smart antenna technology, and fast ports.

Features

- **Faster Wireless Networking** - The DSL-2878 uses Wireless AC technology, which provides transfer rates of up to 750 Mbps* (433 Mbps AC + 300 Mbps N). Wireless AC increases maximum speeds for the 5 GHz band and adds more channels for higher speeds and less RF interference. It operates on both the 2.4 GHz and 5 GHz bands to allow separation of traffic so users can participate in high-bandwidth activities, such as video streaming, online gaming, and real-time audio, without affecting low-priority traffic like email and web surfing.
- **Compatible with 802.11n/g/b/a Devices** - The DSL-2878 is fully backwards compatible with the 802.11n, 802.11g, and 802.11a standards, so it can connect with existing 802.11n, 802.11g, 802.11b, and 802.11a wireless devices.
- **Advanced Features** - The web-based user interface displays a number of advanced network management features including:
 - **Filtering** - Easily apply content filtering based on IP address, MAC address, URL, and/or domain name.
 - **Scheduling** - The firewall, wireless, and port forwarding features can be scheduled to be active on a schedule you define.
- **User-friendly Setup Wizard** - Through its easy-to-use web-based user interface, the DSL-2878 lets you control what information is accessible to those on the wireless network, whether from the Internet, or from your company's server. Configure your router to your specific settings within minutes.

* Maximum wireless signal rate derived from IEEE Standard 802.11a, 802.11b, 802.11g, 802.11n, and 802.11ac specifications. Actual data throughput will vary. Network conditions and environmental factors, including volume of network traffic, building materials and construction, and network overhead, lower actual data throughput rate. Environmental conditions will adversely affect wireless signal range.

Hardware Overview

Back Panel

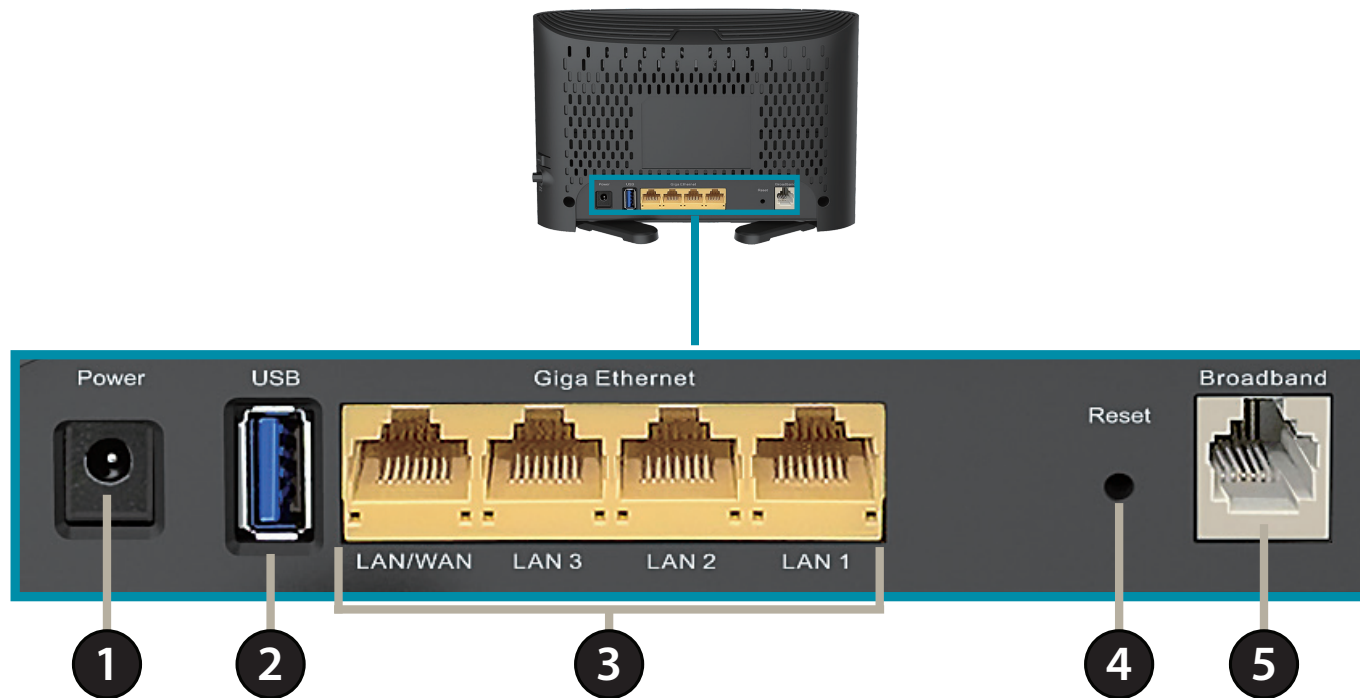

1	Power connector	Connector for the supplied power adapter.
2	USB 2.0 port	Connects to USB drives to share content.
3	Giga Ethernet ports (1-4)	Connects to network devices such as computers, switches, storage (NAS) devices and game consoles at speeds of up to 1000 Mbps.
4	Reset button	To reset the device to its factory default settings, use a paper clip to press and hold the reset button for 5 seconds.
5	DSL port	Connects to an DSL-enabled telephone line.

Side Panel



1	WPS button	Press to start the WPS process and automatically create a secure connection to a WPS client.
2	Power button	Press the power button to power the DSL-2878 on and off.

Hardware Overview

LEDs

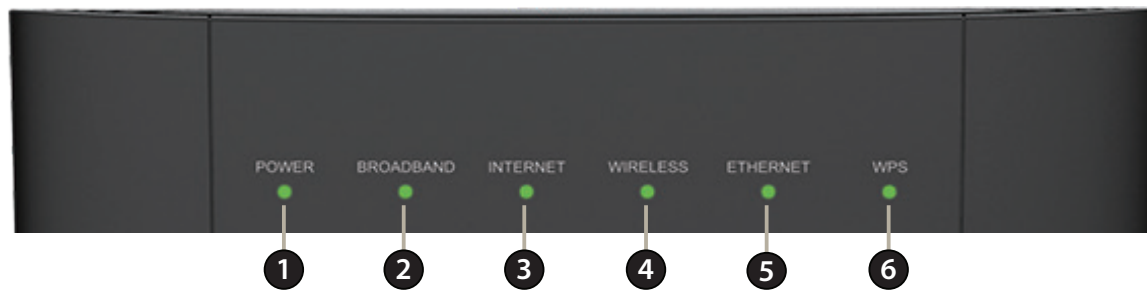

1	Power	Solid green	A solid green light indicates the device is powered on and working properly.
		Solid red	A solid red light indicates that the device is booting or an error has occurred.
2	Broadband	Solid green	A solid green light indicates a proper connection to a DSL-enabled telephone line.
		Blinking green	A blinking green light indicates the DSL port is negotiating a connection.
		Off	An unlit light indicates no connection to a DSL enabled-telephone line.
3	Internet	Solid green	A solid green light indicates an Internet connection.
		Blinking green	A blinking green light indicates Internet activity.
		Solid red	A solid red light indicates a PPP or DHCP failure. Check your username and password.
		Off	An unlit light indicates there is no broadband connection available, or the Internet connection attempt timed out.
4	Wireless	Solid green	A solid green light indicates that the 2.4/5 GHz wireless networks are enabled.
		Blinking green	A blinking green light indicates wireless activity.
		Off	An unlit light indicates that the wireless functionality is disabled.
5	Ethernet	Solid green	A solid green light indicates a device is connected to the respective LAN port.
		Blinking green	A blinking green light indicates LAN port activity.
		Off	An unlit light indicates that no Ethernet devices are connected.
6	WPS	Blinking green	A blinking green light indicates the WPS process is active.

Installation

This section will walk you through the installation process. Placement of the router is very important. Do not place the router in an enclosed area such as a closet, cabinet, attic, or garage.

Note: This installation section is written for users who are setting up their home Internet service with the DSL-2878 AC750 Dual-Band VDSL2/ADSL2+ Modem Router for the first time. If you are replacing an existing DSL modem and/or router, you may need to modify these steps.

Before you Begin

- Make sure to have your DSL service information provided by your Internet Service Provider handy. This information is likely to include your DSL account's username and password. Your ISP may also supply you with additional WAN configuration settings which are necessary to establish a connection. This information may include the connection type (DHCP IP, Static IP, PPPoE, or PPPoA) and/or ATM PVC details.
- If you are connecting a considerable amount of networking equipment, it may be a good idea to take the time to label each cable or take a picture of your existing setup before making any changes.
- We suggest setting up your DSL-2878 from a single device and verifying that it is connected to the Internet before connecting additional devices.
- If you have DSL and are connecting via PPPoE, make sure you disable or uninstall any PPPoE connection software such as WinPoET, BroadJump, or EnterNet 300 from your computer as the DSL-2878 will be providing this functionality.

Wireless Installation Considerations

The D-Link wireless router lets you access your network using a wireless connection from virtually anywhere within the operating range of your wireless network. Keep in mind that the number, thickness and location of walls, ceilings, or other objects that the wireless signals must pass through may limit the range. Typical ranges vary depending on the types of materials and background RF (radio frequency) noise in your home or business. The key to maximizing wireless range is to follow these basic guidelines:

1. Keep the number of walls and ceilings between the D-Link router and other network devices to a minimum - each wall or ceiling can reduce your adapter's range from 3 to 90 feet (1 to 30 meters.) Position your devices so that the number of walls or ceilings is minimized.
2. Be aware of the direct line between network devices. A wall that is 1.5 feet (0.5 meters) thick, at a 45-degree angle appears to be almost 3 feet (1 meter) thick. At a 2-degree angle it looks over 42 feet (14 meters) thick! Position devices so that the signal will travel straight through a wall or ceiling (instead of at an angle) for better reception.
3. Building materials make a difference. A solid metal door or aluminum studs may have a negative effect on range. Try to position access points, wireless routers, and computers so that the signal passes through drywall or open doorways. Materials and objects such as glass, steel, metal, walls with insulation, water (fish tanks), mirrors, file cabinets, brick, and concrete will degrade your wireless signal.
4. Keep your product away (at least 3 to 6 feet or 1 to 2 meters) from electrical devices or appliances that generate RF noise.
5. If you are using 2.4 GHz cordless phones or X-10 (wireless products such as ceiling fans, lights, and home security systems), your wireless connection may degrade dramatically or drop completely. Make sure your 2.4 GHz phone base is as far away from your wireless devices as possible. The base transmits a signal even if the phone is not in use.

Manual Setup

- 1 Position your DSL-2878 near your PC and a telephone wall jack which provides DSL service. Keep the modem router in an open area for better wireless coverage.



- 2 Plug one end of the supplied DSL phone cable into the DSL port on the back of the modem router, and the other end into the telephone wall jack.
Note: If a DSL microsplitter/microfilter is included in the package contents, install it in line with your telephone wall jack.

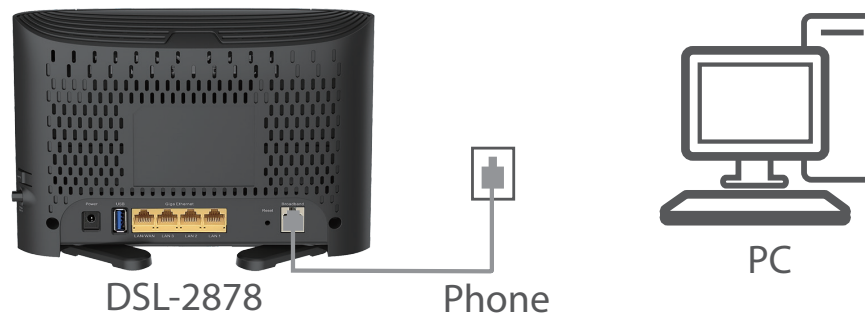

- 3 Connect the supplied power adapter to the modem router and a power outlet, and press the power button. The device LEDs will light up. Wait approximately three minutes before moving on to step 4.

Caution: Use only the included power adapter with this product.

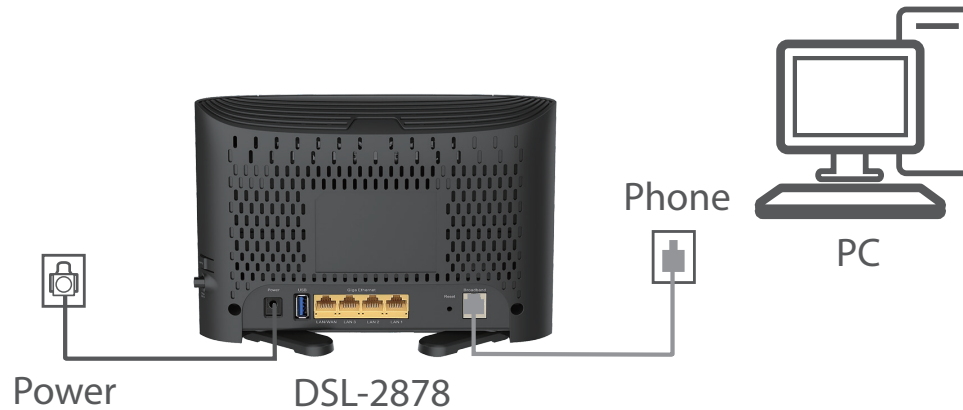

Plug one end of the supplied Ethernet cable into a yellow Ethernet port on the back of the modem router, and the other end into the Ethernet port on your computer.

- 4 If you are setting up the DSL-2878 using a laptop or mobile device, connect to it using the Wi-Fi network name and password printed on the label attached to the back of your router.

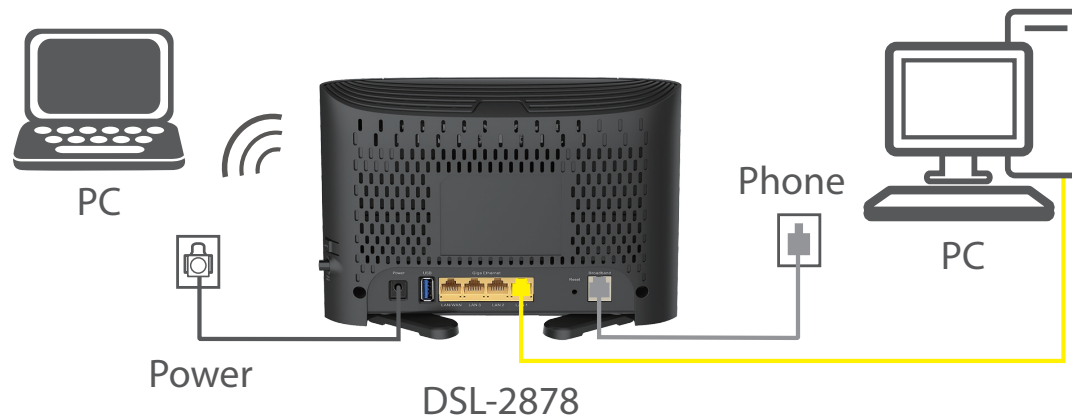

Getting Started

There are two ways you can configure your router to connect to the Internet and connect to your clients:

- **D-Link Setup Wizard** - This wizard will launch when you log into the router for the first time. Refer to **Setup Wizard** on page **13**.
- **Manual Setup** - Log into the router and manually configure your router. Refer to **Configuration** on page **19**.

Setup Wizard

If this is your first time using the router, open your web browser and enter **http://dlinkrouter.local/** in the address bar. Alternatively, enter the IP address of the router (default: **http://192.168.1.1**). The default password is printed on a label on the back of your router..

The wizard is designed to guide you through a step-by-step process to configure your new D-Link router and connect to the Internet. Ensure that your DSL phone cable is connected to both the router and the wall jack.

Click **Next** to continue.

First, you must select your **WAN Access Type**. The options are **ADSL**, **VDSL**, or **Auto**. To quickly find your ISP's settings, select your **Country** and **ISP**. The **VPI** and **VCI** values will automatically be configured.

Click **Next** to continue.

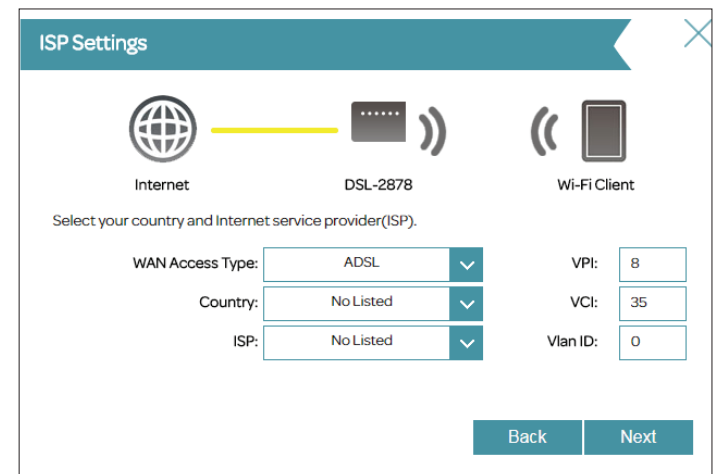
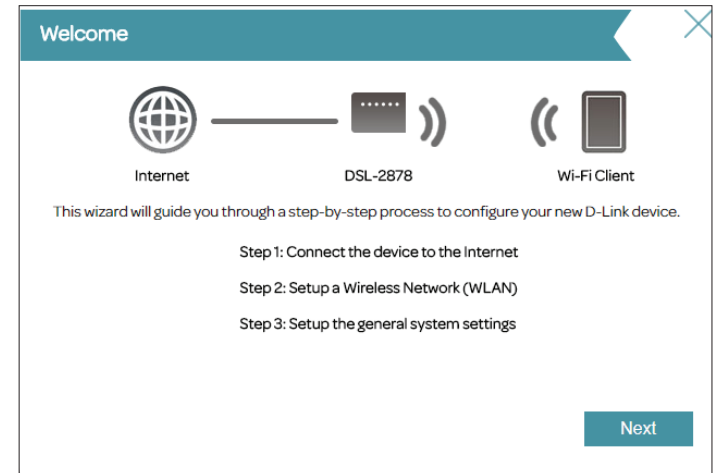

Setup Wizard (continued)

If the router cannot determine your connection type, a list of connection types to choose from will be displayed. Select your Internet connection type (this information can be obtained from your Internet Service Provider) and click **Next** to continue.

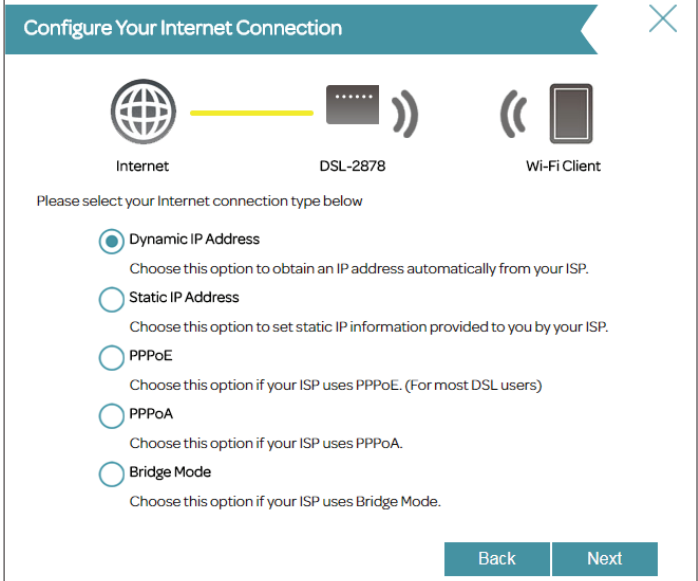

Configure Your Internet Connection

Internet DSL-2878 Wi-Fi Client

Please select your Internet connection type below

- Dynamic IP Address**
Choose this option to obtain an IP address automatically from your ISP.
- Static IP Address**
Choose this option to set static IP information provided to you by your ISP.
- PPPoE**
Choose this option if your ISP uses PPPoE. (For most DSL users)
- PPPoA**
Choose this option if your ISP uses PPPoA.
- Bridge Mode**
Choose this option if your ISP uses Bridge Mode.

Back Next

If the router detected or you selected **PPPoE**, enter your PPPoE username and password, choose the **Connection Type** if asked, and click **Next** to continue.

Note: Make sure to remove any previous PPPoE software from your computer. The software is no longer needed and will not work through a router.

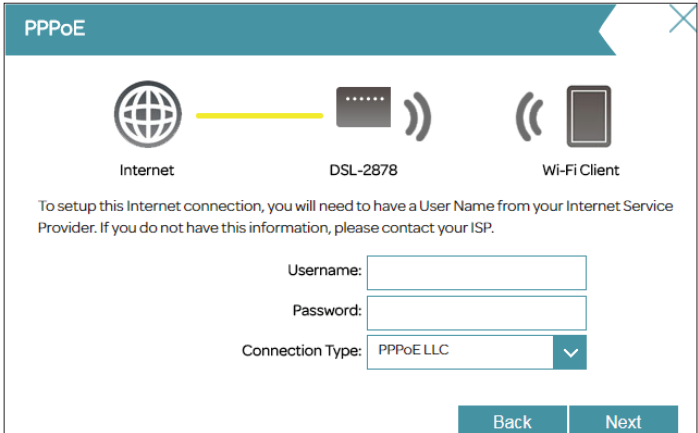

PPPoE

Internet DSL-2878 Wi-Fi Client

To setup this Internet connection, you will need to have a User Name from your Internet Service Provider. If you do not have this information, please contact your ISP.

Username:

Password:

Connection Type: PPPoE LLC

Back Next

Setup Wizard (continued)

If the router detected or you selected **PPPoA**, enter your PPPoA username and password, choose the **Connection Type** if asked, and click **Next** to continue.

Note: Make sure to remove any previous PPPoA software from your computer. The software is no longer needed and will not work through a router.

PPPoA connection type is only available for ADSL connections.

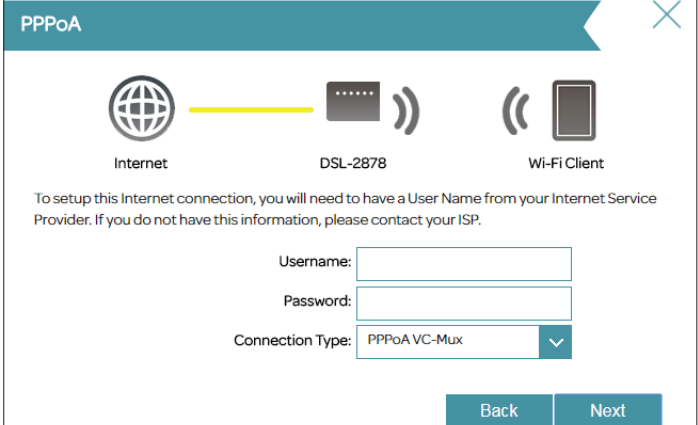

The screenshot shows the 'PPPoA' setup screen. At the top, there are three icons: 'Internet' (globe), 'DSL-2878' (DSL modem), and 'Wi-Fi Client' (Wi-Fi symbol). Below the icons, a text box explains that a username and password from the ISP are required. There are three input fields: 'Username:', 'Password:', and 'Connection Type:'. The 'Connection Type' dropdown menu is set to 'PPPoA VC-Mux'. At the bottom right, there are 'Back' and 'Next' buttons.

If you selected **Static IP**, enter the IP address, subnet mask, gateway address, and DNS servers provided by your ISP, then choose the **Connection Type** if asked. Click **Next** to continue.

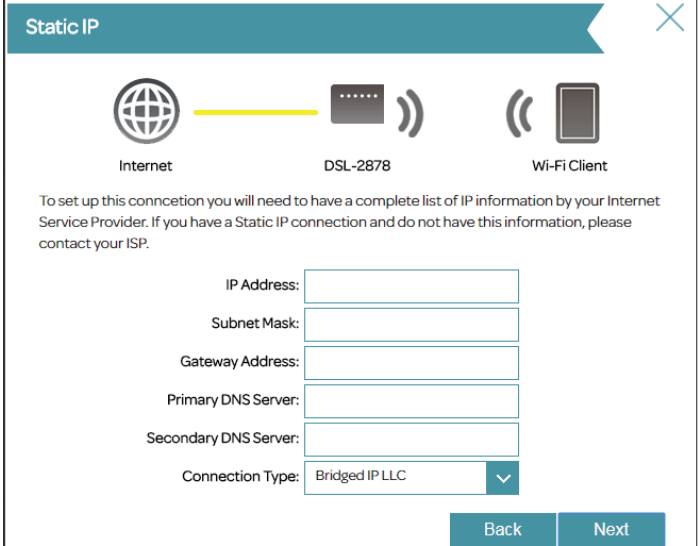

The screenshot shows the 'Static IP' setup screen. At the top, there are three icons: 'Internet' (globe), 'DSL-2878' (DSL modem), and 'Wi-Fi Client' (Wi-Fi symbol). Below the icons, a text box explains that a complete list of IP information from the ISP is required. There are five input fields: 'IP Address:', 'Subnet Mask:', 'Gateway Address:', 'Primary DNS Server:', and 'Secondary DNS Server:'. The 'Connection Type' dropdown menu is set to 'Bridged IP LLC'. At the bottom right, there are 'Back' and 'Next' buttons.

Setup Wizard (continued)

If the router detected or you selected **Dynamic IP Address (DHCP)**, choose the **Connection Type** if asked. Click **Next** to continue.

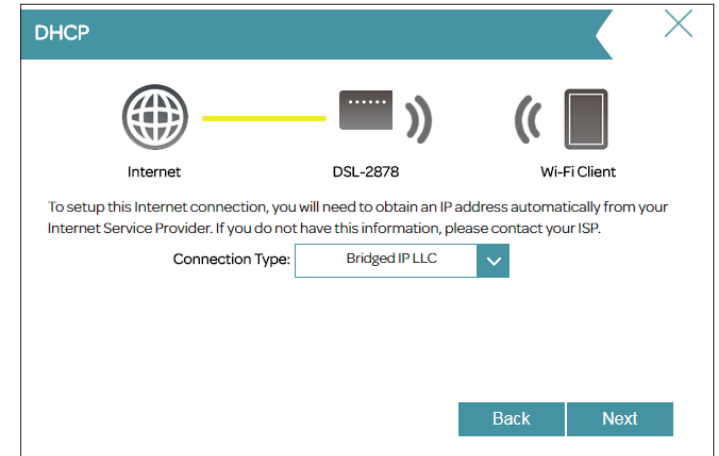

If you selected **Bridge**, choose the **Connection Type** if asked. Click **Next** to continue.

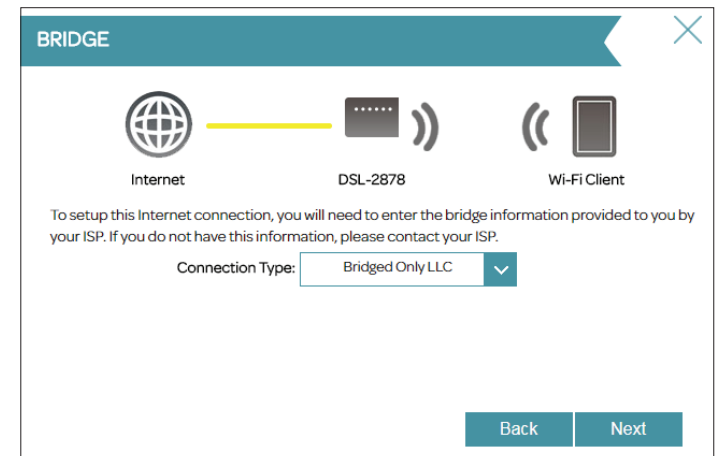

Setup Wizard (continued)

Create a Wi-Fi SSID and password for both the 2.4 GHz and 5 GHz wireless networks. The SSIDs must be between 3 and 32 alphanumeric characters in length and may include hyphens, underscores, periods, and the @ symbol. The passwords must be between 8 and 63 alphanumeric characters in length.

Your wireless clients must use these SSIDs and passwords in order to connect to your wireless networks.

Click **Next** to continue.

To help protect your router, please enter a new password. You will be prompted for this password every time you want to use the router's web configuration utility. Click **Next** to continue.

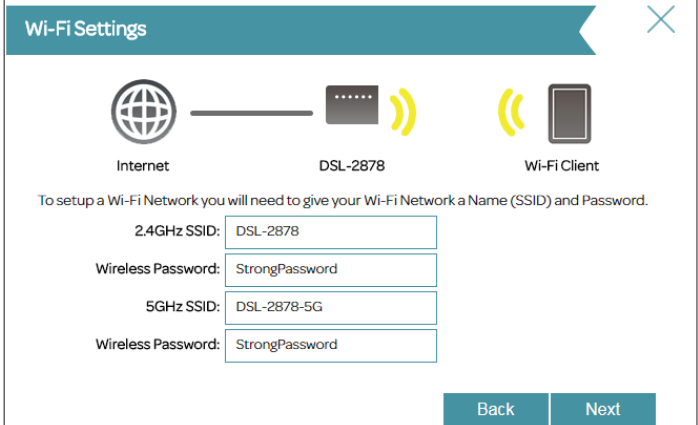

The screenshot shows the 'Wi-Fi Settings' screen. At the top, there is a teal header with the title 'Wi-Fi Settings' and a close button (X). Below the header, there is a diagram showing 'Internet' connected to 'DSL-2878', which is connected to 'Wi-Fi Client'. The 'DSL-2878' and 'Wi-Fi Client' are represented by icons with signal strength indicators. Below the diagram, there is a text prompt: 'To setup a Wi-Fi Network you will need to give your Wi-Fi Network a Name (SSID) and Password.' There are four input fields: '2.4GHz SSID:' with the value 'DSL-2878', 'Wireless Password:' with the value 'StrongPassword', '5GHz SSID:' with the value 'DSL-2878-5G', and 'Wireless Password:' with the value 'StrongPassword'. At the bottom right, there are two buttons: 'Back' and 'Next'.

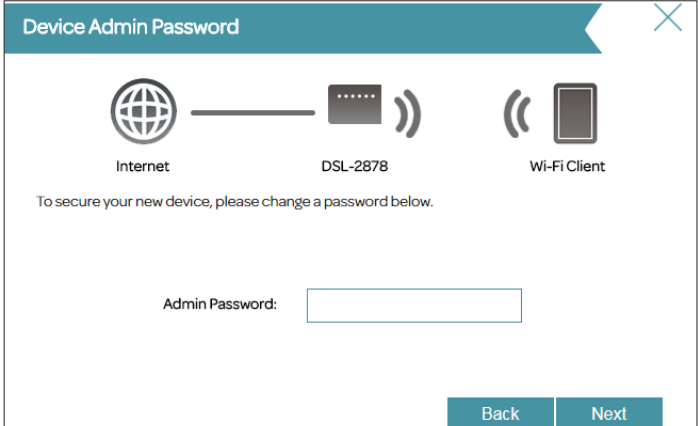

The screenshot shows the 'Device Admin Password' screen. At the top, there is a teal header with the title 'Device Admin Password' and a close button (X). Below the header, there is a diagram showing 'Internet' connected to 'DSL-2878', which is connected to 'Wi-Fi Client'. The 'DSL-2878' and 'Wi-Fi Client' are represented by icons with signal strength indicators. Below the diagram, there is a text prompt: 'To secure your new device, please change a password below.' There is one input field labeled 'Admin Password:'. At the bottom right, there are two buttons: 'Back' and 'Next'.

Setup Wizard (continued)

The **Summary** window will display your settings. Click **Finish** if you are satisfied, or click **Back** to make changes to them. The wizard will close and your settings will be saved.

Congratulations, setup is complete.

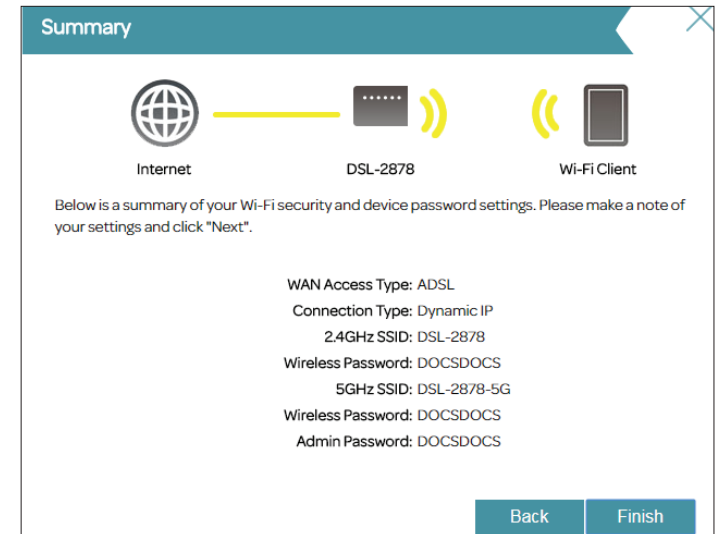

Configuration

To access the configuration utility, open a web browser such as Internet Explorer and enter **http://dlinkrouter.local/**

Windows and Mac users may also connect by typing the IP address of the router (by default this is **http://192.168.1.1**) in the address bar.

The default password printed on a label on the back of your router. If you previously followed the Setup Wizard (see page 13), please use the admin password you entered during the wizard. Click **Log In** to proceed.

Note: If you cannot remember your password and cannot log in, press the reset button (see page 5) to restore the router to its default settings.

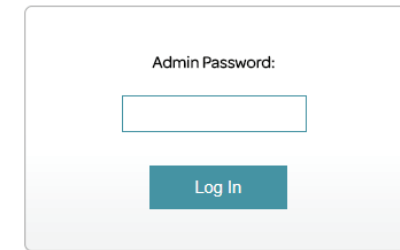

Home

The **Home** page displays the current status of the router in the form of an interactive diagram. There are four main sections: Internet, D-Link, Connected Clients, and USB Device. You can click each icon to display information about each section at the bottom of the screen. The menu bar at the top of the page will allow you to quickly navigate to the **Settings** and **Management** functions. You may quickly jump back Home at any time.

Note: The system will automatically log out after a period of inactivity.

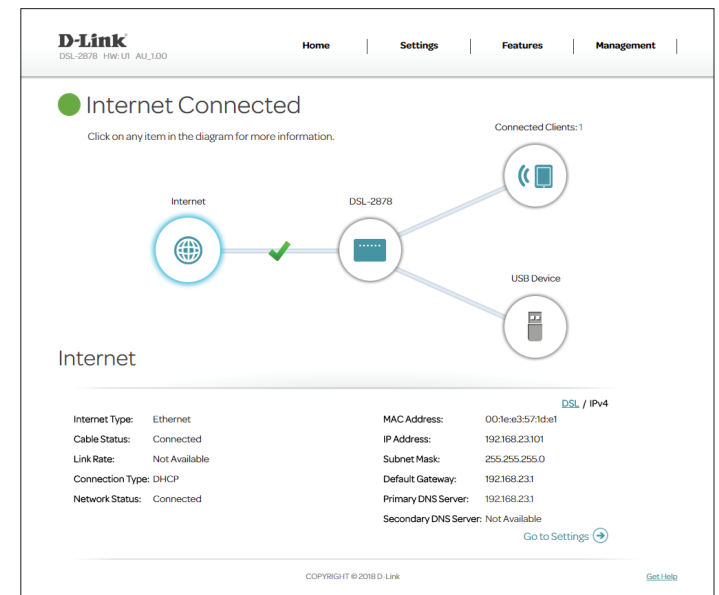

Internet

To bring up more details about your Internet connection, click on the **Internet** icon. The Internet Connection status at the top of the diagram will reflect the status of the currently selected WAN interface.

If your Internet is disconnected, indicated by a red X, you can launch the Setup Wizard to correct the issue by clicking **Wizard** from the **Settings** menu on the bar on the top of the page.

You can see the DSL connection status and IPv4 information at the bottom of the page. Clicking the DSL button will display DSL port information.

D-Link
DSL-2878 HW: UI AU_1.00

Home | Settings | Features | Management

Internet Connected
Click on any item in the diagram for more information.

Connected Clients: 1

Internet DSL-2878 USB Device

Internet

Internet Type:	Ethernet	MAC Address:	00:1e:a3:57:3d:e1
Cable Status:	Connected	IP Address:	192.168.23.101
Link Rate:	Not Available	Subnet Mask:	255.255.255.0
Connection Type:	DHCP	Default Gateway:	192.168.23.1
Network Status:	Connected	Primary DNS Server:	192.168.23.1
		Secondary DNS Server:	Not Available

DSL / IPv4

Go to Settings

COPYRIGHT © 2018 D-Link Get Help

D-Link
DSL-2878 HW: UI AU_1.00

Home | Settings | Features | Management

Internet Disconnected
Click on any item in the diagram for more information.

Connected Clients: 1

Internet DSL-2878 USB Device

Internet

Internet Type:	Not Available	MAC Address:	Not Available
Cable Status:	Disconnected	IP Address:	Not Available
Link Rate:	Not Available	Subnet Mask:	Not Available
Connection Type:	DHCP	Default Gateway:	Not Available
Network Status:	Disconnected	Primary DNS Server:	Not Available
Connection Uptime:	Not Available	Secondary DNS Server:	Not Available

DSL / IPv4

Go to Settings

COPYRIGHT © 2018 D-Link Get Help

IPv4

Click the **IPv4** button to see the IPv4 information for the DSL interface. If you have configured your ADSL/VDSL connection to use PPPoE with On-Demand or Manual settings, you can connect to or disconnect from the Internet by pressing the **Connect** or **Disconnect** buttons.

IPv4

Internet Type: Displays the current DSL type, either ADSL or VDSL.

Cable Status: Displays the current cable connection status.

Link Rate: Displays the currently negotiated connection speed.

Connection Type: Displays the network protocol used to obtain an IP address.

Network Status: Displays the current network connection status.

Connection Uptime: Displays the amount of time the connection has been connected.

MAC Address: Displays the MAC address of this interface.

IP Address: Displays the current WAN IPv4 address.

Subnet Mask: Displays the current subnet mask.

Default Gateway: Displays the current IPv4 default gateway.

Primary DNS Server: Displays the current primary DNS server.

Secondary DNS Server: Displays the current secondary DNS server.

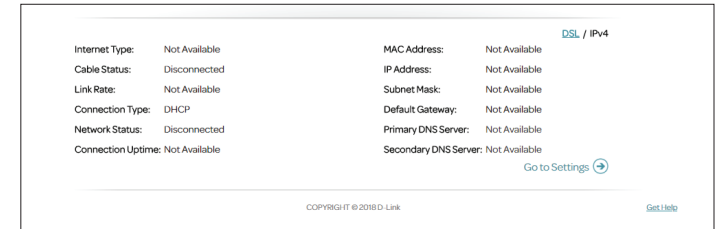

DSL

Click the **DSL** button to see the DSL port connection information. The DSL tab displays information regarding the DSL data connection.

DSL

Line State: Displays the current status of the data link connection to your ISP.

Modulation: Displays the current DSL standard in use.

Annex Mode: Displays the current Annex mode in use.

DSL (Sync) Uptime: Displays the DSL connection uptime.

SNR Margin: Displays the Signal-to-noise margin.

Line Attenuation: Displays the current signal attenuation.

Output Power: Displays the output power of the DSL modem.

ES, SES, UAS, FEC, CRC: These error correction counts are used for diagnostic purposes. If you are having trouble with your ISP, these values may provide useful information for technicians.

The screenshot shows the D-Link DSL-2878 web interface. At the top, there is a navigation bar with 'Home', 'Settings', 'Features', and 'Management'. Below the navigation bar, the status 'Internet Connected' is shown with a green dot. A network diagram illustrates the connection between 'Internet', 'DSL-2878', and 'Connected Clients: 1'. Below the diagram, there is a table of DSL parameters:

DSL / IPv4	
Line State:	Disabled
Modulation:	Not Available
Annex Mode:	Not Available
DSL (Sync) Uptime:	Not Available
SNR Margin:	Not Available
Line Attenuation:	Not Available
Output Power:	Not Available
Data Rate:	Not Available
ES:	Not Available
SES:	Not Available
UAS:	Not Available
FEC:	Not Available
CRC:	Not Available

At the bottom of the page, there is a copyright notice: 'COPYRIGHT © 2018 D-Link' and a 'Get Help' link.

DSL-2878

Click on the **DSL-2878** icon to view details about the router and its wireless settings.

Here you can see the router's current wireless networks and passwords, as well as the local area network MAC and IPv4 addresses.

To reconfigure the network settings, click the **Go to Settings** link, from the **Settings** menu at the top of the page, select **Network**. Refer to **Network** on page **45** for more information.

To reconfigure the wireless settings, click the **Go to Settings** link, from the **Settings** menu at the top of the page, select **Wireless**. Refer to **Wireless** on page **38** for more information.

The screenshot displays the D-Link DSL-2878 web interface. At the top, there is a navigation menu with 'Home', 'Settings', 'Features', and 'Management'. The main content area shows 'Internet Connected' with a green checkmark and a diagram illustrating the network topology: Internet (globe icon) connected to DSL-2878 (router icon), which is then connected to 'Connected Clients: 1' (laptop icon) and a 'USB Device' (USB icon). Below the diagram, the 'DSL-2878' section provides network details:

Network		Wi-Fi 2.4GHz	
MAC Address:	00:1e:e3:57:3d:e0	Status:	Enabled
Router IP Address:	192.168.1.1	Wi-Fi Name (SSID):	DSL-2878
Subnet Mask:	255.255.255.0	Password:	DOCSDOCS
		Channel:	12
		Wi-Fi 5GHz	
		Status:	Enabled
		Wi-Fi Name (SSID):	DSL-2878-5GHz
		Password:	DOCSDOCS
		Channel:	153

At the bottom of the settings section, there are two 'Go to Settings' links with dropdown arrows. The footer contains 'COPYRIGHT © 2018 D-Link' and a 'Get Help' link.

Connected Clients

Click on the **Connected Clients** icon to view details about the clients currently connected to the router and their IP addresses.

To edit each client's settings, click the pencil icon on the client you want to edit.

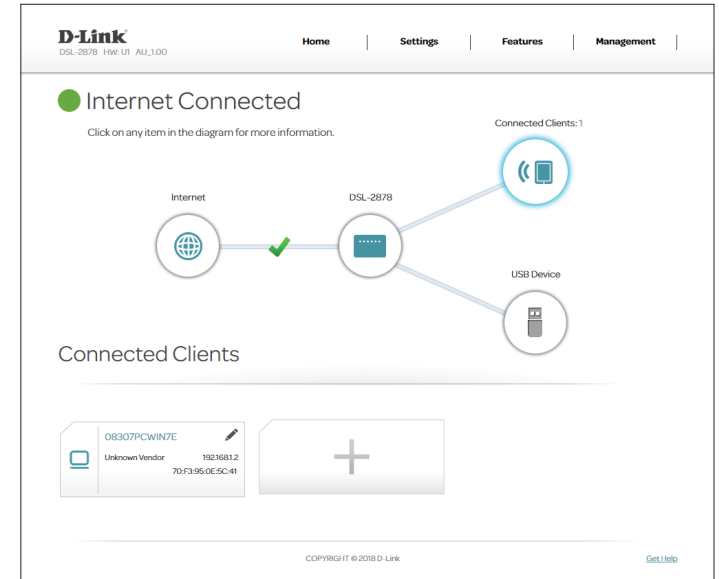

Edit Rule

Name: Enter a custom name for this client.

Vendor: Displays the vendor of the device.

MAC Address: Displays the MAC address of the device.

IP Address: Enter a specific IP address for this client if **Reserve IP** is enabled.

Reserve IP: Enable to reserve this IP address for this client.

Click **Save** when you are done.

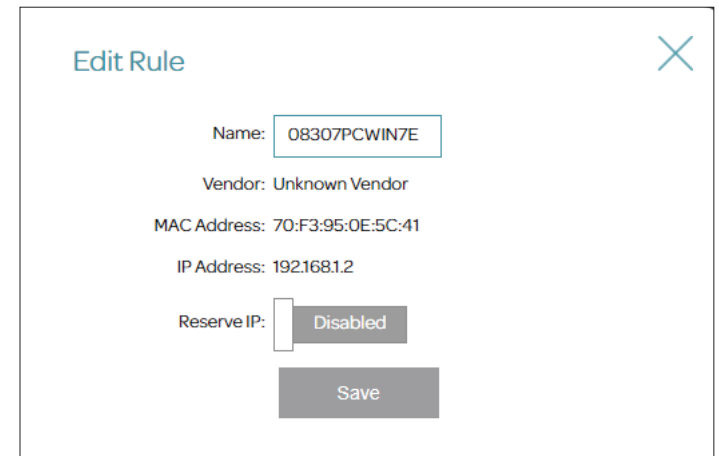

USB Device

Click on the **USB Device** icon to view details about the currently connected USB device, DLNA Media Server, and Windows File Sharing settings.

If you have a USB device connected, you can see its name and how much free space it has.

To configure your USB settings, click **Go to settings** and refer to page **USB Device** on page **25** for more information.

For information on how to access your USB drive from a Windows-based PC refer to **Connect and Share a USB Storage Device** on page **72**.

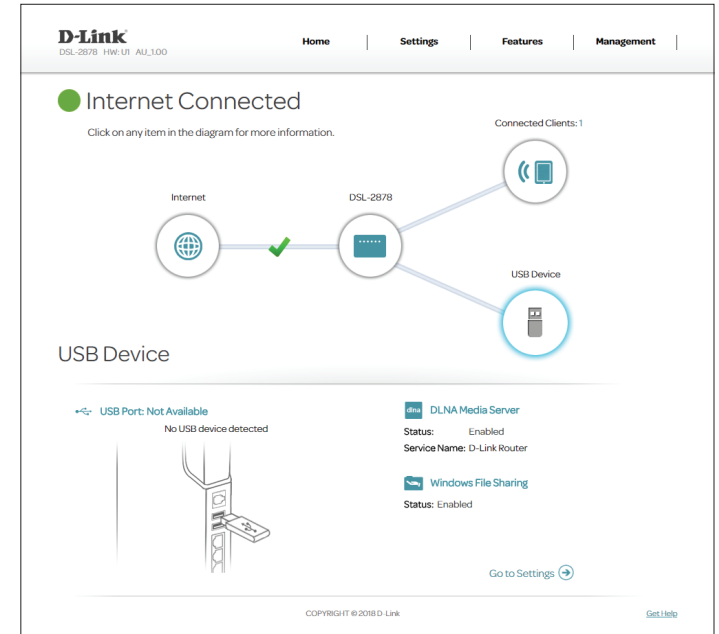

Settings Wizard

To access the Setup Wizard page, click **Wizard** from the **Settings** menu on the bar on the top of the page. This is the same wizard that appears when you start the router for the first time. Refer to **Setup Wizard** on page **13** for more information.

Internet

The following pages will describe how to manually configure how your DSL-2878 connects to the Internet. To access this page, click **Internet** from the **Settings** menu on the bar on the top of the page. The DSL-2878 supports multiple WAN connection types and WAN failover. We recommend setting up Internet WAN connections one at a time, **Save** the configuration, and confirm the connection works before returning to this section to add additional WAN connections.

The following configuration pages are divided by WAN Access Type.

WAN CONNECTION TYPE

Configure your WAN Connection: Select WAN interface to configure. The options are **Auto, ADSL, VDSL, or Ethernet**.

Select a WAN Connection and refer to its configuration page for setup information.

For ADSL, refer to **ADSL** on page **27**.

For VDSL, refer to **VDSL** on page **29**.

For Ethernet, refer to **Ethernet** on page **30**.

Auto refers to the Internet connection configured by the Setup Wizard.

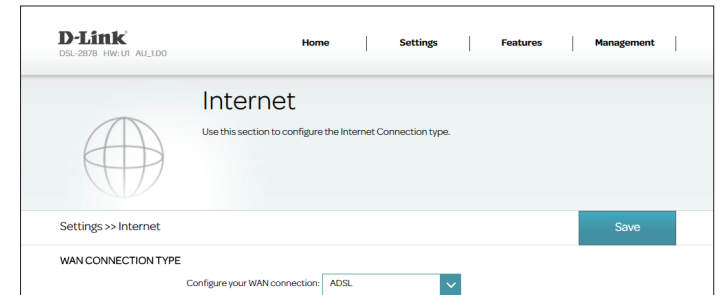

ADSL

ADSL is one of the first home broadband technologies introduced. ADSL uses the DSL port on your DSL-2878 to connect to the Internet. In order for your DSL-2878 to use ADSL, you must configure the **WAN Connection Type** and your **WAN Settings**.

WAN Connection Type

Configure your WAN connection: Select **ADSL** to configure ADSL connection settings.

WAN Settings

Service Number: Select the service number from the drop-down menu. If no service has previously been added, or you wish to add a new one, select **Add**.

Enable Virtual Circuit: Select whether to enable or disable this Virtual Circuit.

If you **Enabled** the selected interface, the following options are available:

VPI: Enter the Virtual Path Indicator (0 - 255).

VCI: Enter the Virtual Channel Indicator (32 - 65535).

Service Category: Select the type of ATM traffic contract, **UBR**, **CBR**, **NRT-VBR**, or **RT-VBR**.

If you selected **UBR**, **CBR**, **NRT-VBR**, or **RT-VBR**, the following option is available:

Vlan ID: Enter the VLAN ID. Enter a value from 10 - 4096. The default value is 835.

The screenshot shows the 'Internet' configuration page in the D-Link DSL-2878 web interface. The page has a navigation bar with 'Home', 'Settings', 'Features', and 'Management'. The main heading is 'Internet' with a sub-heading 'Use this section to configure the Internet Connection type.' Below this, there is a 'Settings >> Internet' breadcrumb and a 'Save' button. The 'WAN CONNECTION TYPE' is set to 'ADSL'. Under 'WAN SETTINGS', the 'Service Number' is set to 'Add', 'Enable Virtual Circuit' is checked, 'VPI' is 8, 'VCI' is 35, 'Service Category' is 'CBR', 'Peak Cell Rate(PCR)' is 0 cells/s, and 'Vlan ID' is 0.

ADSL (continued)

If you selected **CBR**, **NRT-VBR**, or **RT-VBR**, the additional following options are available:

Peak Cell Rate (PCR): Enter the Peak Cell Rate in cells per second.

If you selected **NRT-VBR** or **RT-VBR**, the additional following options are available:

Sustainable Cell Rate(SCR): Enter the Sustainable Cell Rate in cells per second.

Maximum Burst Size(MB/s): Enter the Maximum Burst Size in MB per second.

To set your IPv4 connection parameters of **WAN Settings**, refer to **WAN Settings** on page **31**.

Service Category:	CBR	▼
Peak Cell Rate(PCR):	0	cells/s
Vlan ID:	0	

Service Category:	NRT-VBR	▼
Peak Cell Rate(PCR):	0	cells/s
Sustainable Cell Rate(SCR):	0	cells/s
Maximum Burst Size(MBS):	0	cells/s
Vlan ID:	0	

Service Category:	RT-VBR	▼
Peak Cell Rate(PCR):	0	cells/s
Sustainable Cell Rate(SCR):	0	cells/s
Maximum Burst Size(MBS):	0	cells/s
Vlan ID:	0	

VDSL

VDSL is one of the latest and fastest home broadband technologies. VDSL uses the DSL port on your DSL-2878 to connect to the Internet. In order for your DSL-2878 to use VDSL, you must configure the ATM VC Settings and your **WAN Settings**.

Configure your WAN connection: Select **VDSL** to configure ADSL connection settings.

If you click on **Advanced Settings**, the following **WAN Settings** are available:

PTM VC Settings

Service Number: Select the service number from the drop-down menu. If no service has been previously added, or you wish to add a new one, select **Add**.

Enable Virtual Circuit: Select whether to enable or disable this Virtual Circuit.

Vlan ID: Enter the VLAN ID. Enter a value from 10 - 4096. The default value is 835.

To set your IPv4 connection parameters of **WAN Settings**, refer to **WAN Settings** on page 31.

The screenshot displays the D-Link DSL-2878 WAN Settings interface. At the top, there are navigation links for Home, Settings, Features, and Management. The main heading is 'Internet', with a sub-instruction: 'Use this section to configure the Internet Connection type.' Below this, there is a breadcrumb trail 'Settings >> Internet' and two buttons: 'Delete' and 'Save'. The 'WAN CONNECTION TYPE' section shows 'Configure your WAN connection:' with a dropdown menu currently set to 'VDSL'. The 'WAN SETTINGS' section includes: 'Service Number:' with a dropdown menu set to 'PTM_DHCP_0_2'; 'Enable Virtual Circuit:' with a checked 'Enable' checkbox; and 'Vlan ID:' with a text input field containing '0'.

Ethernet

Your DSL-2878 is equipped with a multi-purpose Gigabit Ethernet LAN/WAN port which can be used to connect to the Internet. This port may be used to connect to other Ethernet based networks. In order for your DSL-2878 to use Ethernet, you must configure the Ethernet Settings and your **WAN Settings**.

WAN Settings

Service Number: Select a service number from the drop-down menu, or to create a new service number, click **Add**.

Enable Virtual Circuit Enable or disable virtual circuit, also referred to as VLAN tagging.

If you selected **Enable Virtual Circuit**, the following options are available:

VLAN ID: Enter the VLAN ID. The value should be 0, or 0-4079.

Proceed to **IPv4 Settings** on page **31** or **IPv6 Settings** on page **82**.

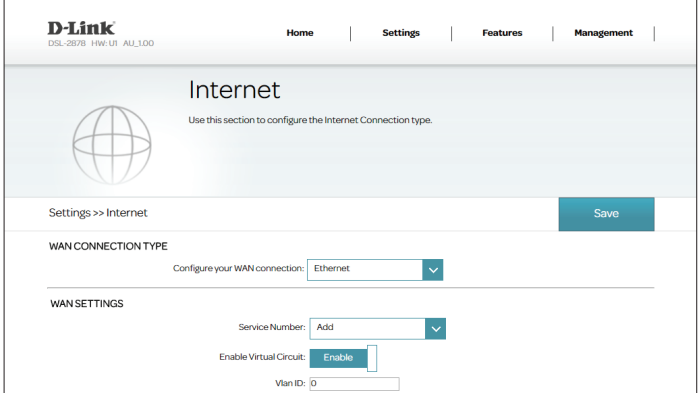

The screenshot shows the D-Link DSL-2878 WAN Settings page. The page title is "Internet" and it includes a navigation menu with "Home", "Settings", "Features", and "Management". The main heading is "Internet" with a sub-heading "Use this section to configure the Internet Connection type." Below this, there is a "Settings >> Internet" breadcrumb and a "Save" button. The "WAN CONNECTION TYPE" section has a "Configure your WAN connection:" label and a dropdown menu set to "Ethernet". The "WAN SETTINGS" section includes a "Service Number:" dropdown menu set to "Add", an "Enable Virtual Circuit:" checkbox that is checked and labeled "Enable", and a "Vlan ID:" input field with the value "0".

WAN Settings

Dynamic IP (DHCP)

Select **Dynamic IP Address (DHCP)** to obtain an IP address automatically from your ISP. Select this option if your ISP does not provide you with a specific IP address.

WAN Settings

Connection: Select **Dynamic IP Address (DHCP)**.

WAN Service Type: Select a service type from the list. As of this writing, only **Internet** is supported for manual configuration.

Connection Type: Select **Bridged IP LLC** or **Bridged IP VC-MUX**.

MTU: Maximum Transmission Unit - you may need to change the MTU for optimal performance with your ISP.

Click **Save** when you are done.

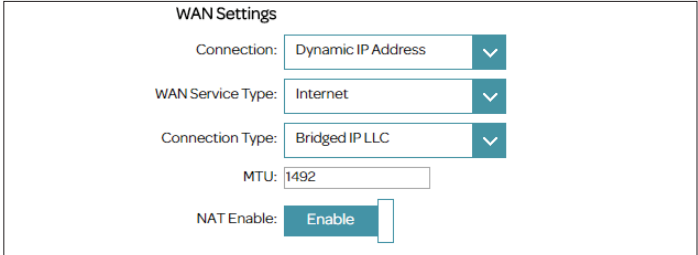

WAN Settings

Connection: Dynamic IP Address

WAN Service Type: Internet

Connection Type: Bridged IP LLC

MTU: 1492

NAT Enable: Enable

Static IP

Select **Static IP** if your ISP provides you with a specific IP address.

WAN Settings

Connection: Select **Static IP Address**.

WAN Service Type: Select a service type from the list. As of this writing, only **Internet** is supported for manual configuration.

Connection Type: Select **Bridged IP LLC**, **Bridged IP VC-MUX**, **Routed IP LLC (IPoA)**, or **Routed IP VC-Mux (IPoA)**. The IPoA options are available for ADSL connections only.

IP Address: Enter the IP address provided by your ISP.

Subnet Mask: Enter the subnet mask provided by your ISP.

Default Gateway: Enter the default gateway address provided by your ISP.

MTU: Maximum Transmission Unit - you may need to change the MTU for optimal performance with your ISP.

NAT Enable: Enable or disable Network Address Translation.

Click **Save** when you are done.

The screenshot shows the WAN Settings configuration interface. It includes the following fields and options:

- WAN Settings** (Section Header)
- Connection:** Static IP Address (dropdown menu)
- WAN Service Type:** Internet (dropdown menu)
- IP Address:** [Text input field] assigned by your ISP
- Subnet mask:** [Text input field]
- Gateway Address:** [Text input field]
- MTU:** 1492 (text input field)
- Primary DNS Server:** [Text input field]
- Secondary DNS Server:** [Text input field]
- NAT Enable:** [Enable] (checkbox)

PPPoE

Select **PPPoE** if your ISP provides and requires you to enter a PPPoE username and password in order to connect to the Internet.

WAN Settings

Connection: Select **PPPoE**.

WAN Service Type: Select a service type from the list. As of this writing, only **Internet** is supported for manual configuration.

Username: Enter the username provided by your ISP.

Password: Enter the password provided by your ISP.

Connection Type: Select **PPPoE LLC** or **PPPoE VC-Mux**.

IP Control: Select **Dynamic IP Address** or **Static IP Address**.

If you selected **Static IP Address**, the following option is available:

Static IP Address: Enter the IP address provided by your ISP.

MTU: Maximum Transmission Unit - you may need to change the MTU for optimal performance with your ISP.

NAT Enable: Enable or disable Network Address Translation.

Authentication Protocol: Select the authentication protocol your ISP uses. The options are **Auto**, **PAP**, or **CHAP**.

Connect mode select: Set the connection to be **Always-on**, **Connect-On-Demand**, or **Manual**.

The screenshot shows the WAN Settings configuration page. The 'Connection' dropdown is set to 'PPPoE'. The 'WAN Service Type' dropdown is set to 'Internet'. The 'Username' and 'Password' fields are empty. The 'Confirm Password' field is empty. The 'Connection Type' dropdown is set to 'PPPoE LLC'. The 'IP Control' dropdown is set to 'Static IP Address'. The 'Static IP Address' field is empty. The 'MTU' field is set to '1492'. The 'NAT Enable' checkbox is checked. The 'Authentication Protocol' dropdown is set to 'Auto'. The 'Connect mode select' dropdown is set to 'Always On'. The 'Maximum Idle Time' field is set to '5' minutes.

If you selected **Connect-On-Demand**, the following option is available:

Maximum Idle Time: Enter the amount of time the router will maintain the Internet connection before disconnecting if there is no activity.

Click **Save** when you are done.

The screenshot shows the WAN Settings configuration page. The fields are as follows:

- Connection: PPPoE
- WAN Service Type: Internet
- Username: [Empty]
- Password: [Empty]
- Confirm Password: [Empty]
- Connection Type: PPPoE LLC
- IP Control: Static IP Address
- Static IP Address: [Empty]
- MTU: 1492
- NAT Enable: Enable
- Authentication Protocol: Auto
- Connect mode select: Always On
- Maximum Idle Time: 5 Minutes

PPPoA

Select **PPPoA** if your ISP provides and requires you to enter a PPPoA username and password in order to connect to the Internet. For ADSL connections only.

WAN Settings

Connection: Select **PPPoA**.

WAN Service Type: Select a service type from the list. As of this writing, only **Internet** is supported for manual configuration.

Username: Enter the username provided by your ISP.

Password: Enter the password provided by your ISP.

Connection Type: Select **PPPoA LLC** or **PPPoA VC-Mux**.

IP Control: Select **Dynamic IP Address** or **Static IP Address**.

If you selected **Static IP Address**, the following option is available:

Static IP Address: Enter the IP address provided by your ISP.

MTU: Maximum Transmission Unit - you may need to change the MTU for optimal performance with your ISP.

NAT Enable: Enable or disable Network Address Translation.

Authentication Protocol: Select the authentication protocol your ISP uses. The options are **Auto**, **PAP**, or **CHAP**.

The screenshot shows the WAN Settings configuration interface. The settings are as follows:

- Connection: PPPoA
- WAN Service Type: Internet
- Username: (empty text field)
- Password: (masked text field)
- Confirm Password: (masked text field)
- Connection Type: PPPoA LLC
- IP Control: Dynamic IP Address
- Static IP Address: (empty text field)
- MTU: 1492
- NAT Enable: Enable
- Authentication Protocol: Auto
- Connect mode select: Always On
- Maximum Idle Time: 5 Minutes

Connect mode Set the connection to be **Always-on, Connect-On-Demand**, or **select: Manual**.

If you selected **Connect-On-Demand**, the following option is available:

Maximum Idle Time: Enter the amount of time the router will maintain the Internet connection before disconnecting if there is no activity.

Click **Save** when you are done.

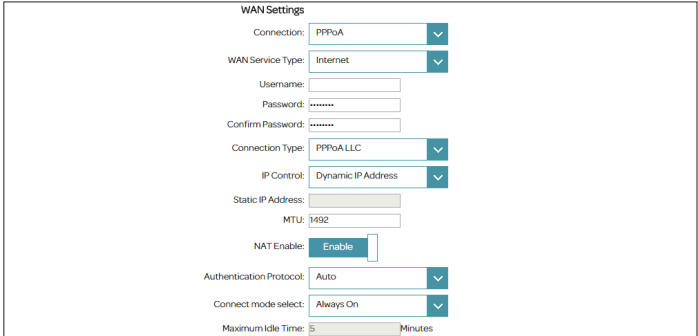

The screenshot shows the WAN Settings configuration page. The settings are as follows:

- Connection: PPPoA
- WAN Service Type: Internet
- Username: (empty)
- Password: (masked with dots)
- Confirm Password: (masked with dots)
- Connection Type: PPPoALLC
- IP Control: Dynamic IP Address
- Static IP Address: (empty)
- MTU: 1492
- NAT Enable: Enable
- Authentication Protocol: Auto
- Connect mode select: Always On
- Maximum Idle Time: 5 Minutes

Bridge Mode

Select **Bridge Mode** to use the DSL-2878 as a network bridge. This page has only one setting.

WAN Settings

Connection: Select **Bridge**.

Click **Save** when you are done. You will need to connect and configure another device to connect to your ISP.

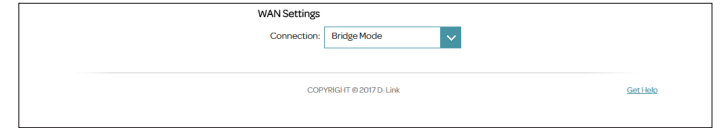

Wireless

From this page you can configure your wireless network settings. To access this page, click **Wireless** from the **Settings** menu on the bar on the top of the page.

2.4 GHz

Status: Enable or disable the 2.4 GHz wireless network.

SSID: Create a name for your wireless network using up to 32 characters.

Password: Create a password to use for wireless security.

5 GHz

Status: Enable or disable the 5 GHz wireless network.

SSID: Create a name for your wireless network using up to 32 characters.

Password: Create a password to use for wireless security.

Wi-Fi Protected Setup

PBC Start: This triggers the WPS pairing process. Refer to **WPS Button** on page **82** for more information about WPS.

Click **Save** when you are done. The following pages describe the **Advanced Settings** configuration options in detail.

The screenshot displays the D-Link Wireless configuration interface. At the top, there is a navigation bar with 'Home', 'Settings', 'Features', and 'Management'. The main heading is 'Wireless', with a sub-note: 'Use this section to configure the wireless settings for your D-Link Router. Please make sure that any changes made in this section will need to be updated on your wireless device.' Below this, there are two sections for 2.4GHz and 5GHz. Each section has a 'Status' dropdown set to 'Enable', an 'SSID' text field, and a 'Password' text field. There are 'Advanced Settings...' links for each. At the bottom, there is a 'Wi-Fi PROTECTED SETUP' section with a 'PBC Start' button. The footer contains 'COPYRIGHT © 2018 D-Link' and a 'Get Help' link.

Advanced Settings

Clicking **Advanced Settings** allows you to manually configure security, wireless radio operation, and schedule settings.

Security: Choose **None**, **WEP-64Bit**, **WEP-128Bit**, **WPA2**, or **WPA/WPA2**.

WPA2

Using WPA2 with AES encryption is recommended. Using it you can be reasonably assured that your wireless connection is secure.

Security: **WPA2**

WPA Type

If you select **802.1x** the following options are available:

Server IP Address: Enter the IP address of the RADIUS Server.

Port: Enter the port used by the RADIUS Server.

Secret: Enter the secret used by the RADIUS Server.

Cipher Type: Select either **AES** or **Both** (AES/TKIP). **AES** is recommended.

Group Key Interval: Enter the Group Key Interval. The default is **100** seconds.

If you select **Pre-shared key** the following options are available:

Cipher Type: Select either **AES** or **Both** (AES/TKIP). **AES** is recommended.

Group Key Interval: Enter the Group Key Interval. The default is **100** seconds.

D-Link DSL-3785 HW: B1 AU_1.00

Home | Settings | Features | Management

Wireless

Use this section to configure the wireless settings for your D-Link Router. Please make sure that any changes made in this section will need to be updated on your wireless device.

Settings >> Wireless Guest Zone Save

2.4GHz

Status: Enable

SSID:

Password:

[Advanced Settings...](#)

Security:

WPA Type

802.1x

Pre-shared Key

802.1x

Server IP Address:

Port:

Secret:

Cipher Type:

Group Key Interval: Seconds

Security:

WPA Type

802.1x

Pre-shared Key

Cipher Type:

Group Key Interval: Seconds

Advanced Settings (continued)

WPA/WPA2

WPA/WPA2 is a reasonably strong wireless security encryption type. Use this for wireless clients which do not support WPA2 encryption.

Security: WPA/WPA2

WPA Type

If you select **802.1x** the following options are available:

Server IP Address: Enter the IP address of the RADIUS Server.

Port: Enter the port used by the RADIUS Server.

Secret: Enter the secret used by the RADIUS Server.

Cipher Type: Select **AES** or **Both**. **AES** is recommended.

*Note: **Both** will enable TKIP legacy encryption, which will allow older devices to connect, but may reduce throughput and is less secure.*

Group Key Interval: Enter the Group Key Interval. The default is **100** seconds.

If you select **Pre-shared key** the following options are available:

Cipher Type: Select **AES**, **TKIP**, or **Both**. **AES** is recommended.

Group Key Interval: Enter the Group Key Interval. The default is **100** seconds.

D-Link DSL-2878 HW: UI: AU_1.00

Home | Settings | Features | Management

Wireless

Use this section to configure the wireless settings for your D-Link Router. Please make sure that any changes made in this section will need to be updated on your wireless device.

Settings >> Wireless Guest Zone Save

2.4GHz

Status: Enable

SSID: DSL-2878

Password:

[Advanced Settings...](#)

Security: WPA/WPA2

WPA Type

802.1x

Pre-shared Key

802.1x

Server IP Address:

Port: 1812

Secret:

Cipher Type: AES

Group Key Interval: 100 Seconds

Security: WPA/WPA2

WPA Type

802.1x

Pre-shared Key

Cipher Type: AES

Group Key Interval: 100 Seconds

Advanced Settings (continued)

WEP-64Bit or WEP-128Bit

Use of WEP encryption is not recommended. Unless your clients do not support WPA encryption, it is recommended that you select WPA2 or WPA/WPA2 Mixed instead of WEP as.

Security: **WEP-64Bit** or **WEP-128Bit**.

Auth Type: Select either **Open** or **Shared**.

None

Disabling encryption and leaving your wireless network open is not recommended. Any wireless client will be able to access your network, be able to use your Internet connection, and leaves you open to security threats.

Security: **None**. If you select **None**, no further wireless security configuration options are available.

The screenshot displays the 'Wireless' configuration page for a D-Link DSL-2878 router. The page is titled 'Wireless' and includes a navigation menu with 'Home', 'Settings', 'Features', and 'Management'. Below the title, there is a warning: 'Use this section to configure the wireless settings for your D-Link Router. Please make sure that any changes made in this section will need to be updated on your wireless device.' The page is divided into sections for '2.4GHz' and '5GHz' networks. The '2.4GHz' section is expanded, showing the following settings: Status: Enable (checked), SSID: DSL-2878, Password: (empty), Security: WEP-64Bit (selected), and Auth. Type: Open (selected). Below this, the '5GHz' section is partially visible, showing Security: WEP-128Bit (selected) and Auth. Type: Open (selected). At the bottom, the '2.4GHz' section is shown again with Security: None (selected). The page also includes a 'Save' button and a 'Guest Zone' link.

Advanced Settings (continued)

2.4 GHz / 5 GHz Advanced Settings

Hide SSID: The default setting is **Disabled**. Select **Enabled** if you do not want to broadcast the SSID of your wireless network.

Note: Hiding your SSID is not a form of security alone.

WMM: Enable or disable WMM QoS for your wireless network. This can help to improve the quality of video and voice applications for your wireless clients.

Wi-Fi Protected Enable: Enabled or disable WPS functionality of this device.

Wi-Fi Protected Status: The current WPS functionality status is displayed.

Signal-Interval: Set the rate at which your wireless network is advertised. The default is **100** milliseconds.

DTIM: Specify the Delivery Traffic Information Map (DTIM) message interval.

Transmitting Power: Select the desired wireless transmission power. The available options are **100%, 80%, 60%, 40%, or 20%**. The default is **100%**.

Threshold for fragmentation (2.4 GHz only): The fragmentation threshold, which is specified in bytes, determines whether packets will be fragmented. Packets exceeding the 2346 byte threshold will be fragmented before transmission. **2346** is the default setting.

2.4 GHz 802.11 Mode: Select the desired wireless networking standard(s) to use. The available options are **11B Only, Mixed 11G/B, or Mixed 802.11N/G/B**.

The screenshot displays the 'Wireless' configuration page for the 2.4GHz band on a D-Link DSL-2878 router. The interface includes a navigation menu at the top with 'Home', 'Settings', 'Features', and 'Management'. The main heading is 'Wireless', with a sub-heading 'Settings >> Wireless' and buttons for 'Guest Zone' and 'Save'. The configuration options are as follows:

- Status:** Enabled
- SSID:** DSL-2878
- Password:** DOCSDOCS
- Security:** WPA2
- WPA Type:** Pre-shared Key (selected over 802.1x)
- Cipher Type:** AES
- Group Key Interval:** 100 Seconds
- Hide SSID:** Disabled
- WMM:** Enabled
- Wi-Fi Protected Enable:** Enabled
- Wi-Fi Protected Status:** Enabled/Configured
- Signal-Interval:** 100 msec (Range: 20-1000, Standard: 100)
- DTIM:** 1 (Range: 1-255, Standard: 1)
- Transmitting Power:** 100%
- Threshold for fragmentation:** 2346 (Standard: 2346)
- 802.11 Mode:** Mixed 11N/G/B
- Channel Width:** 20/40MHz
- Continent/Country:** Australia
- Channel:** Auto
- AutoChannel:** Enabled
- Preamble Type:** Enabled

Advanced Settings (continued)

2.4 GHz Channel Width: Channel Width is available if you select **Mixed 11N/G/B** for **802.11 Mode**. Select **20/40** if you are using both 802.11n and non-802.11n devices, or select **20 MHz** if you want to disable 40 MHz bandwidth communication. Select **40 MHz** to use only 40 MHz only. The recommended setting is **20/40**.

*Note: Selecting **40 MHz** may increase throughput for some users, but may cause interference and limit compatibility.*

5 GHz 802.11 Mode: Select the desired wireless networking standard(s) to use. The available options are **11A Only**, **11A/N Mixed Mode**, **Mixed 11AC/N/A**, or **Mixed 11AC/N**.

5 GHz Channel Width: Select the desired channel width. The available options are **20 MHz**, **20/40 MHz**, or **20/40/80 MHz**. Depending upon the selected 5 GHz 802.11 Mode, some options may be unavailable.

Channel: Select the desired channel for your wireless network to use. This option is only available if **Auto Channel** is disabled.

Continent/Country: Select your country or region to allow the router to use the correct radio channels for your region.

Auto Channel: Enable or disable automatic wireless channel selection.

Preamble Type: Enable or disable short preamble type.

Click **Save** when you are done.

The screenshot shows the 'Wireless' configuration page for a D-Link DSL-2878 router. The page is divided into sections for 2.4GHz and 5GHz settings. The 2.4GHz section is currently active and shows the following settings:

- Status: Enable
- SSID: DSL-2878
- Password: DOCSDOCS
- Security: WPA2
- WPA Type: 802.1x, Pre-shared Key
- Cipher Type: AES
- Group Key Interval: 100 Seconds
- Hide SSID: Disable
- WMM: Enable
- Wi-Fi Protected Enable: Enable
- Wi-Fi Protected Status: Enabled/Configured
- Signal Interval: 100 msec (Range: 20-1000, Standard: 100)
- DTIM: 0 (Range: 1-255, Standard: 1)
- Transmitting Power: 100%
- Threshold for fragmentation: 2346 (Standard: 2346)
- 802.11 Mode: Mixed 11N/G/B
- Channel Width: 20MHz
- Continent/Country: Austria
- Channel: Auto
- AutoChannel: Disabled
- Preamble Type: Enable

Guest Zone

The Guest Zone feature will allow you to create wireless networks that can be used by guests to access the Internet. These zones will be separate from your main wireless network. You may configure different zones for the 2.4 GHz and 5 GHz wireless bands. To access this page, click **Wireless** from the **Settings** menu on the bar on the top of the page and click **Guest Zone**.

2.4 GHz / 5 GHz

Status: Enable or disable the selected SSID.

Wi-Fi Name (SSID): Enter a wireless network name (SSID) that is different from your main wireless network.

Password: Create a password to use for wireless security. Wireless clients will need to enter this password to successfully connect to the guest zone.

Security: Choose **None**, **WPA2**, or **WPA/WPA2**.

Click **Save** when you are done.

The screenshot displays the D-Link Guest Zone configuration interface. At the top, there is a navigation bar with 'Home', 'Settings', 'Features', and 'Management'. The main heading is 'Guest Zone', accompanied by an icon of two people and a descriptive paragraph. Below this, a breadcrumb trail shows 'Settings >> Guest Zone' and a 'Wireless' tab. The configuration is split into two sections: '2.4GHz' and '5GHz'. Each section has a 'Status' dropdown set to 'Enable', a 'Wi-Fi Name (SSID)' text input, a 'Password' text input, and a 'Security' dropdown menu set to 'WPA2'. A 'Save' button is located at the top right of the configuration area. The footer contains copyright information: 'COPYRIGHT © 2010 D-Link' and 'GSL1161a'.

Network

This section will allow you to change the local network settings of the router and to configure the DHCP settings. To access this page, click **Network** from the **Settings** menu on the bar on the top of the page.

Router Settings

Router IP Address: Enter the IP address of the router for this interface. The default IP address is **192.168.1.1**.

If you change the IP address, once you click **Save**, you will need to enter the new IP address in your browser to get back into the configuration utility.

Subnet Mask: Enter the subnet mask of this interface. The default subnet mask is **255.255.255.0**.

Enable Second IP: Enable or disable the dual LAN IP capability of this router. The default setting is **Disabled**.

Second IP Address: Enter the second IP address of the router for this interface. The default IP address is **192.168.2.1**.

Second Subnet Mask: Enter the second subnet mask of this interface. The default subnet mask is **255.255.255.0**.

UPNP Settings

UPNP: Enable or disable UPNP.

Click **Save** when you are done or click **Advanced Settings**.

The screenshot displays the D-Link Network configuration interface. At the top, there is a navigation bar with 'Home', 'Settings', 'Features', and 'Management'. The main heading is 'Network'. Below the heading, there is a brief explanation of the settings. The 'Router Settings' section contains the following fields and values:

- Router IP Address: 192.168.1.1
- Subnet Mask: 255.255.255.0
- Enable Second IP:
- Second IP Address: 192.168.2.1
- Second Subnet Mask: 255.255.255.0

The 'UPnP Settings' section has a checkbox for 'UPnP' which is checked. A 'Save' button is located in the top right corner of the configuration area. At the bottom of the page, there is a copyright notice: 'COPYRIGHT © 2018 D-Link' and a 'Get Help' link.

Network - Advanced Settings

Advanced Settings

You may select one of the following DHCP mode behaviors:

- Disable DHCP Server:** Select this option to disable the DHCP server. No further configuration is available.
- Enable DHCP Server:** Select this option to enable the DHCP server.
- DHCP Relay:** Select this option to enable DHCP Relay. Use this if you have a dedicated DHCP server on your network.

If you selected **Enable DHCP**, the following options are available:

DHCP IP Address Range: Enter the starting and ending IP addresses for the DHCP server's IP assignment.

Note: *If you statically (manually) assign IP addresses to your computers or devices, make sure the IP addresses are outside of this range or you may have an IP conflict.*

DHCP Lease Time: Select the DHCP lease time from the drop down menu.

Option60 Vendor ID: Enter Option60 information here. (Optional)

Primary DNS Server: Enter the primary DNS server IP address assigned by your ISP. This address is usually obtained automatically from your ISP.

Secondary DNS Server: Enter the secondary DNS server IP address assigned by your ISP. This address is usually obtained automatically from your ISP.

The screenshot shows the 'Network' settings page for a D-Link DSL-2878 router. The 'Router Settings' section is active, showing the following fields: Router IP Address (192.168.1.1), Subnet Mask (255.255.255.0), Enable Second IP (checked), Second IP Address (192.168.2.1), and Second Subnet Mask (255.255.255.0). A 'Save' button is visible in the top right corner.

This screenshot shows the DHCP configuration options. The 'Enable DHCP Server' radio button is selected. The DHCP IP Address Range is set to 192.168.1.2 to 192.168.1.254. The DHCP Lease Time is set to 1 Day. There are input fields for Option60 Vendor ID, Primary DNS Server, and Secondary DNS Server. The 'DHCP Relay' radio button is unselected.

This screenshot shows the DHCP configuration options with the 'Disable DHCP Server' radio button selected. The 'Enable DHCP Server' and 'DHCP Relay' radio buttons are unselected.

This screenshot shows the DHCP configuration options with the 'DHCP Relay' radio button selected. The 'Server IP' field is set to 192.168.1.200. The 'Disable DHCP Server' and 'Enable DHCP Server' radio buttons are unselected.

Network - Advanced Settings

If you selected **DHCP Relay**, the following options are available:

Server IP: Enter the DHCP server IP address.

Click **Save** when you are done.

D-Link
DSL-2878 HW-UI AU_1.0.0

Home | Settings | Features | Management

Network

These are the IP settings of the LAN interface for the Device. These settings may be referred to as Private settings. You may change the LAN IP address if needed.
The LAN IP address is private to your internal network and can not be seen on the Internet.
If you already have a DHCP server on your network or are using static IP addresses on all the devices on your network, click on Disable DHCP Server to disable this feature.

Settings >> Network Save

Router Settings

Router IP Address:

Subnet Mask:

Enable Second IP: Enable

Second IP Address:

Second Subnet Mask:

[Advanced Settings](#)

Disable DHCP Server Choose this option. The IP address must be manually assigned to each device connected to the router.

Enable DHCP Server Choose this option to setup as a DHCP server to distribute IP addresses to the LAN network.

DHCP Relay

Server IP:

UPnP Settings

UPnP: Enable

COPYRIGHT © 2018 D-Link [Get Help](#)

USB

This page will allow you to set up access to files on an external USB device plugged into the router. You can do this through the local network. To access this page, click **USB** from the **Settings** menu on the bar on the top of the page.

DLNA Settings

DLNA: Enable or disable the DLNA media server functions, allowing connected DLNA clients access to media files over the network.

Samba Setup

Samba: Enable or disable Windows File Sharing, or Samba. Computers and devices which support Samba will be able to access the files on the USB device connected to this router.

Work Group: Enter the Windows workgroup name.

Net BIOS Name: Enter the name for this device as you wish it to appear on your network.

Click **Save** when you are done.

For information on how to access your USB drive from a Windows-based PC refer to **Connect and Share a USB Storage Device** on page **72**.

D-Link
DSL-2878 HW-UI AU_1.00

Home | Settings | Features | Management

USB

The built-in UPnP media server streams music, videos, and photos stored on an attached USB drive to PCs, smartphones, tablets, smart TVs, or other media devices on your network.

Settings >> USB Save

DLNA Settings

DLNA: Enable

Samba Setup

Samba: Enable

Work Group:

Net BIOS Name:

COPYRIGHT © 2010 D-Link [Get Help](#)

Features

Firewall

The router's firewall protects your network from malicious attacks over the Internet. To access this page, click **Firewall** from the **Features** menu on the bar on the top of the page. It is recommended to leave all values at their default **Enable** setting.

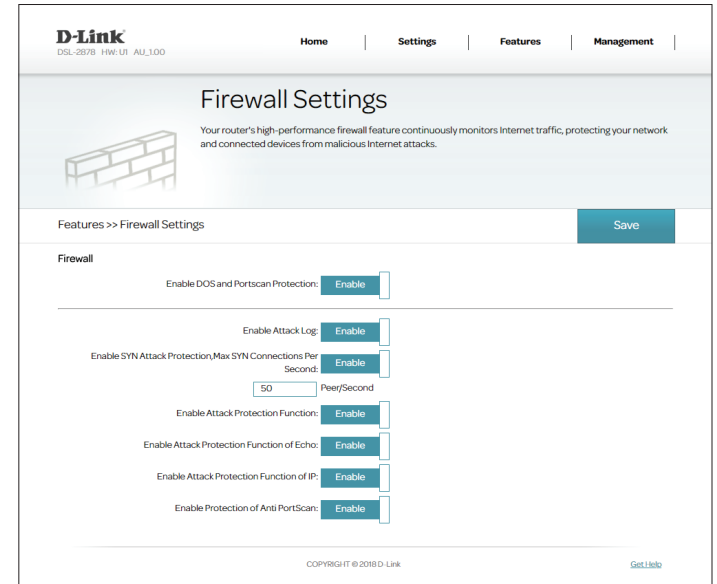

Application

Port triggering allows ports to be opened when traffic is detected on specified ports. This is used for facilitating communication between applications and servers behind a NAT firewall. To access this page, click **Application** from the **Features** menu on the bar on the top of the page.

The currently defined Application rules are displayed in the table. Some commonly used Applications are pre-configured by default. You may create up to eight application rules. If you wish to remove an application rule, click on its trash can icon in the Delete column. If you wish to edit an application rule, click on its pencil icon in the Edit column. If you wish to create a new application rule, click the **Add Rule** button.

Create New Rule

Enable Application: Enable or disable the Application rule.

Name: Enter a name for this application.

Trigger Port Start: Enter the starting port range traffic will be forwarded from.

Trigger Port End: Enter the ending port range traffic will be forwarded from.

Trigger Traffic Protocol Type: Select the protocol to trigger this rule: **TCP**, **UDP**, or **All Protocol**.

Open Port: Enter the port or port range to open once triggered.

Open Traffic Protocol Type: Select the protocol to trigger this rule: **TCP**, **UDP**, or **All Protocol**.

Click **Apply** when you are done.

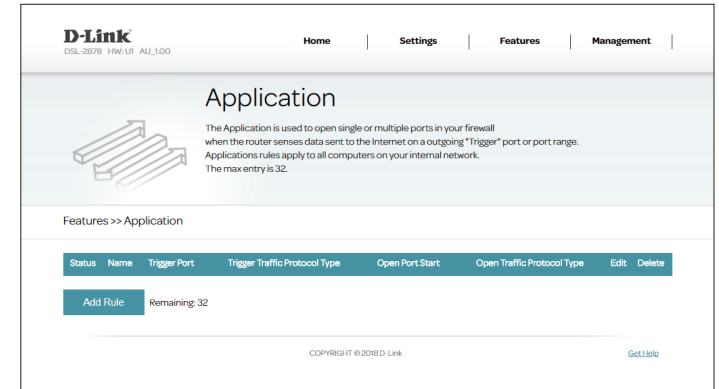

ACL

The Access Control List (ACL) page allows you to enable or disable various services from being used on the LAN or WAN side. To access this page, click **ACL** from the **Features** menu on the bar on the top of the page.

Access Control Setup

Active: Activate or deactivate the individual ACL rule.

Service IP address: Enter the IP address range to apply the rule to.

Application: Select a pre-defined service.

ACL Rule IndexInterface: Select the interface from the drop down menu to apply this access control list rule to.

Access Control Listing

A list of the currently defined Access Control List rules is displayed here. Click **Edit** (✎) to create or modify a rule or **Delete** (🗑) to remove a rule.

Click **Save** when you are done.

D-Link
DSL-3785 HW:BI AU_100

Home | Settings | Features | Management

ACL

You may use telnet or Web to remotely manage the DSL Router. You need to enable Telnet or Web and give it an IP address that you want to access the DSL Router from. The default IP 0.0.0.0 allows any client to use this service to remotely manage the DSL Router.

Features >> ACL Save

Access Control Setup

Active: Activated

Source IP Address: -
(0.0.0.0 - 0.0.0.0 means all IPs)

Application:

ACL Rule IndexInterface:

Access Control Listing

Index	Active	Source IP Address	Application	Interface	Edit	Delete
1	0	0.0.0.0-0.0.0.0	FTP	LAN	✎	🗑
2	1	0.0.0.0-0.0.0.0	HTTP(Web)	LAN	✎	🗑
3	1	0.0.0.0-0.0.0.0	ICMP	LAN	✎	🗑
4	0	0.0.0.0-0.0.0.0	SNMP	LAN	✎	🗑
5	0	0.0.0.0-0.0.0.0	SSH	LAN	✎	🗑
6	0	0.0.0.0-0.0.0.0	TELNET	LAN	✎	🗑
7	0	0.0.0.0-0.0.0.0	TFTP	LAN	✎	🗑
8	1	0.0.0.0-0.0.0.0	SAMBA1	LAN	✎	🗑
9	1	0.0.0.0-0.0.0.0	SAMBA2	LAN	✎	🗑
10	1	0.0.0.0-0.0.0.0	DNS	LAN	✎	🗑

COPYRIGHT © 2017 D-Link Get List

Port Forwarding

Port forwarding allows you to specify a port or range of ports to open for specific devices on the network. This might be necessary for certain applications to connect through the router. To access this page, click **Port Forwarding** from the **Features** menu on the bar on the top of the page.

If you wish to remove a rule, click on its trash can icon in the Delete column. If you wish to edit a rule, click on its pencil icon in the Edit column. If you wish to create a new rule, click the **Add Rule** button. Click **Save** when you are done. If you edit or create a rule, the following options will appear:

Create New Rule

Enable Rules: Enable or disable the port forwarding rules.

Name: Enter a name for the rule.

Interface: Select the WAN interface which the incoming service will transit.

Internal IP: Enter the IP address of the computer on your local network that you want to allow the incoming service to.

Internal startport: Enter the starting internal port that you want to open.

Internal endpoint: Enter the ending internal port that you want to open.

External startport: Enter the starting external port that you want to open.

External endpoint: Enter the ending external port that you want to open.

Protocol: Select **TCP**, **UDP**, or **Both**.

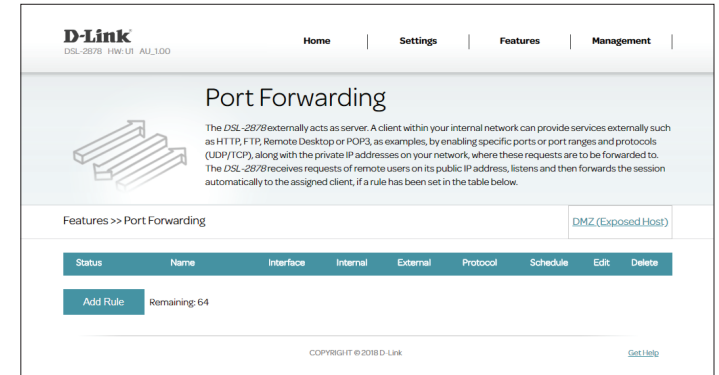

Port Forwarding (continued)

Schedule: Use the drop-down menu to select the time schedule that the rule will be enabled on. The schedule may be set to **Always**, or you can create your own schedules in the **Schedules** section. Refer to **Schedule** on page **64** for more information.

Click **Apply** when you are done.

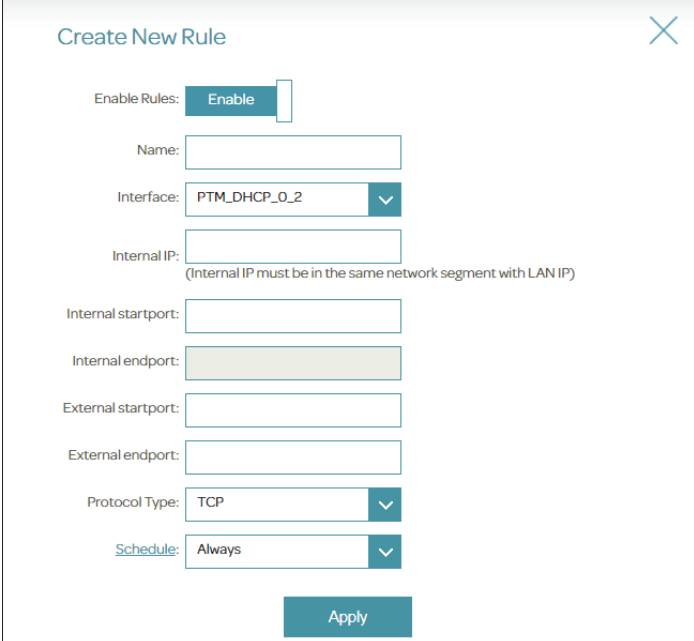

The screenshot shows a 'Create New Rule' dialog box with the following fields and options:

- Enable Rules:** A toggle switch set to 'Enable'.
- Name:** An empty text input field.
- Interface:** A dropdown menu showing 'PTM_DHCP_0_2'.
- Internal IP:** An empty text input field with a note below it: '(Internal IP must be in the same network segment with LAN IP)'. The field is highlighted with a light green background.
- Internal startport:** An empty text input field.
- Internal endpoint:** A text input field with a light green background.
- External startport:** An empty text input field.
- External endpoint:** An empty text input field.
- Protocol Type:** A dropdown menu showing 'TCP'.
- Schedule:** A dropdown menu showing 'Always'.
- Apply:** A teal button at the bottom right.

DMZ (Exposed Host)

This page allows you to manually configure the router's DMZ settings. To access this page, click **Port Forwarding** from the **Features** menu on the bar on the top of the page and click **DMZ (Exposed Host)**. Since some applications are not compatible with NAT, the device supports the use of a DMZ IP address for a single host on the LAN. This IP address is not protected by NAT and it is visible on the Internet with the correct type of software.

Note: Any client PC in the DMZ is exposed to various types of security risks. If you use DMZ, take measures (such as client-based virus protection) to protect the remaining client PCs on your LAN from possible contamination through DMZ.

The devices currently placed in the DMZ are displayed in the table. You may place up to 8 devices in the DMZ. If you wish to remove a DMZ rule, click on its trash can icon in the Delete column. If you wish to edit a DMZ rule, click on its pencil icon in the Edit column. If you wish to create a new DMZ rule, click the **Add Rule** button.

Create New Rule

Enable DMZ: Enable or disable the DMZ rule.

Interface: Select the interface to apply the rule to.

IP Address: Enter the IP address of the computer on your local network that you want to place in the DMZ.

Click **Apply** when you are done.

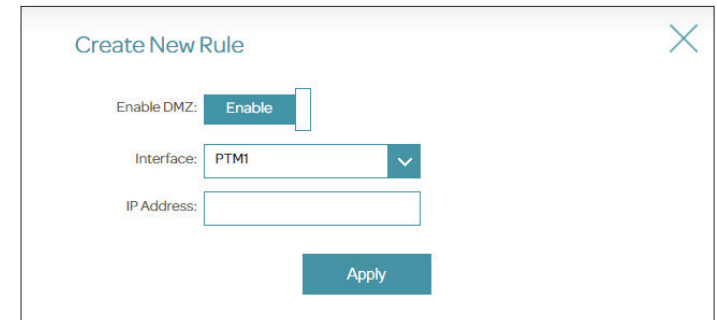
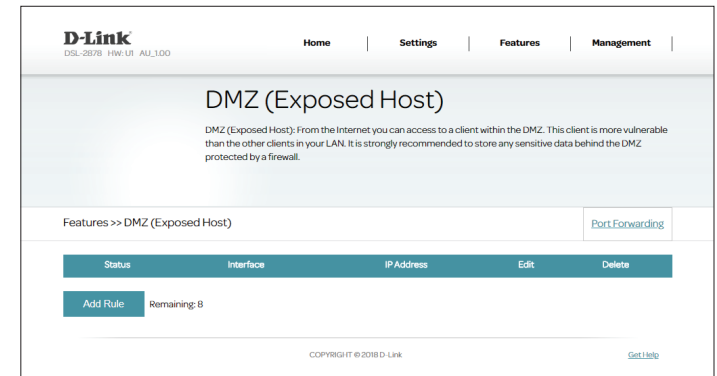

IP/MAC/Web Filtering

IP Filter

The IP Filters page manages LAN users' access to the Internet. It is possible to permit access to the Internet for specified IP addresses within your LAN or to restrict access for specified IP addresses. You can also define filters for port access. To access this page, click **IP/MAC/Web Filtering** from the **Features** menu on the bar on the top of the page.

You may choose from the following options: **Disable IP Filters**, **Only allow computers with IP addresses listed below access to the network**, or **Only deny computers with IP addresses listed below access to the network**.

The currently defined IP filters are displayed in the table. You may define up to 16 IP filtering rules. If you wish to remove a rule, click on its trash can icon (🗑) in the Delete column. If you wish to edit a rule, click on its pencil icon (✎) in the Edit column. If you wish to create a new rule, click the **Add Rule** button.

The following page contains a detailed description of rule creation.

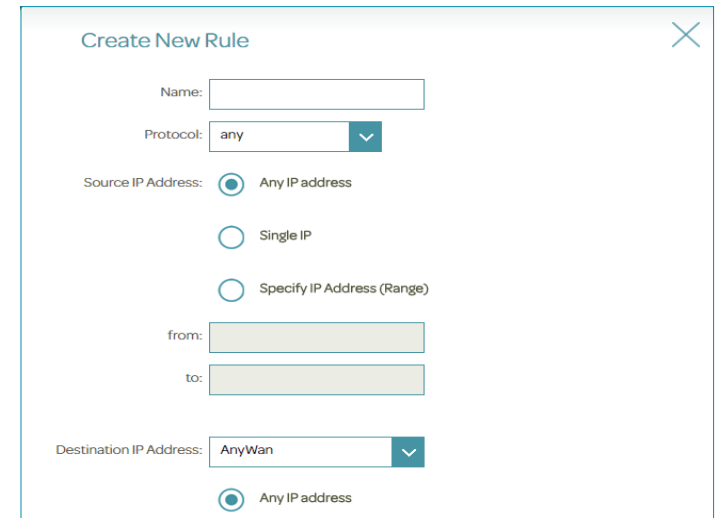
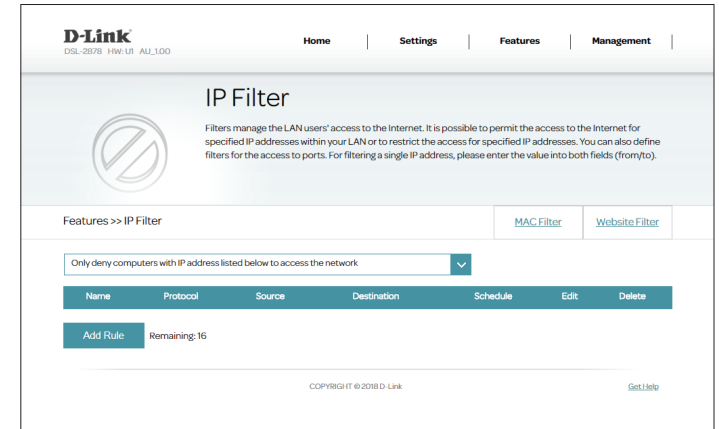

IP Filter (continued)

If you enabled IP filtering, click **Add Rule** to create a new IP filtering rule.

Create New Rule

Name: Create a name for the rule.

Protocol: Select the protocol type: **Any**, **UDP**, **TCP**, or **ICMP**.

Source IP Address: Select **Any IP address**, **Single IP**, or **Specify IP Address (Range)**. If you selected **Single IP** or **Specify IP Address (Range)**, enter the IP address into the **From** and **To** fields.

Destination IP Address: Select the destination to apply the rule to: **PVC1**, **PTM**, or **WAN**.
Address: Select **Any IP address**, **Single IP**, or **Specify IP Address (Range)**. If you selected **Single IP** or **Specify IP Address (Range)**, enter the IP address into the **From** and **To** fields.

If you selected **UDP** or **TCP** as the **Protocol** above, you may filter **Any Port**, a **Single Port**, or **Specify a Port Range**.

Schedule: Use the drop-down menu to select the time schedule that the rule will be enabled on. The schedule may be set to **Always**, or you can create your own schedules in the **Schedules** section. Refer to **Schedule** on page **64** for more information.

Click **Apply** when you are done.

Create New Rule

Name:

Protocol: **UDP**

Source IP Address: Any IP address
 Single IP
 Specify IP Address (Range)

from:
to:

Destination IP Address: **PTM_PPPoE_0_1**

Any IP address
 Single IP
 Specify IP Address (Range)

from:
to:

Any ports
 Single Ports
 Specify Ports (Range)

from:
to:

Schedule: **Always**

Apply

MAC Filter

The MAC filter is used to restrict or allow certain types of Ethernet Frames through the gateway based on their source or destination MAC address. These filters are helpful in securing or restricting traffic on your local network. To access this page, click **IP/MAC Filtering** from the **Features** menu on the bar on the top of the page and then click the **MAC Filter** link. To return to the IP Filter page, click **IP Filter**.

You may choose from the following options: **Disable MAC Filters**, **Only allow computers with MAC addresses listed below access to the network**, or **Only deny computers with addresses listed below access to the network**.

The currently defined MAC filters are displayed in the table. You may define up to 32 MAC filtering rules. If you wish to remove a rule, click on its trash can icon (🗑) in the Delete column. If you wish to edit a rule, click on its pencil icon (✎) in the Edit column. If you wish to create a new rule, click the **Add Rule** button.

If you enable MAC filtering, click **Add Rule** to create a new MAC filtering rule.

Create New Rule

Name: Create a name for the rule.

MAC Address: Enter the MAC address to apply the rule to.

Schedule: Use the drop-down menu to select the time schedule that the rule will be enabled on. The schedule may be set to **Always**, or you can create your own schedules in the **Schedules** section. Refer to **Schedule** on page **64** for more information.

Click **Apply** when you are done.

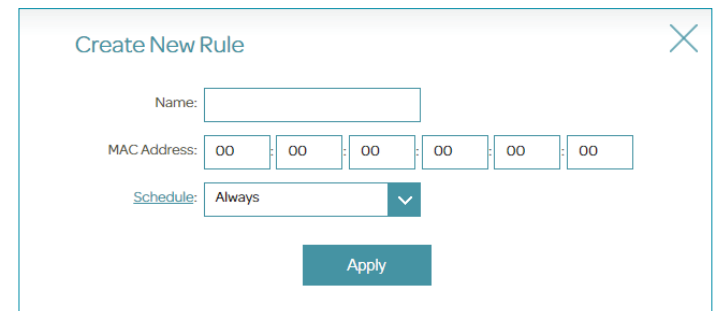
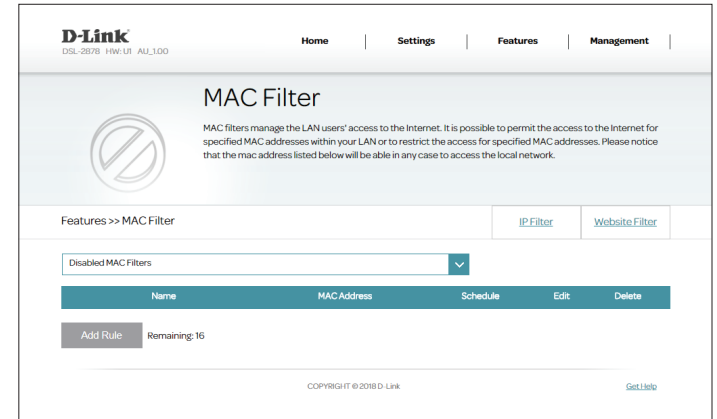

Website Filter

The website filter settings allow you to block access to certain web sites. You can either create a list of sites to block, or create a list of sites to allow (with all other sites being blocked). To access this page, click **IP/MAC/Web Filtering** from the **Features** menu on the bar on the top of the page and then click the **Website Filter** link. To return to the IP Filter page, click **IP Filter**.

If you want to create a list of sites to block, select **DENY computers access to ONLY these sites** from the drop-down menu. All other sites will be accessible. If you want to specify a list of sites to allow, select **ALLOW computers access to ONLY these sites** from the drop-down menu. All other sites will be blocked.

You may specify a maximum of 16 web sites. To add a new site to the list, click **Add New Rule**. If you wish to remove a rule, click on its trashcan icon (🗑) in the Delete column. If you wish to edit a rule, click on its pencil icon (✎) in the edit column.

If you enable Web Filtering, click **Add Rule** to create a new Web Filtering rule.

Create New Rule

Name: Create a name for the rule.

Website URL Keyword: Enter the Website URL Keyword to apply the rule to.

Schedule: Use the drop-down menu to select the time schedule that the rule will be enabled on. The schedule may be set to **Always**, or you can create your own schedules in the **Schedules** section. Refer to **Schedule** on page **64** for more information.

Click **Apply** when you are done.

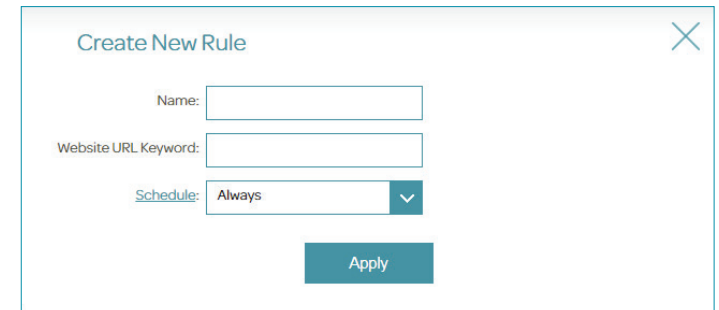
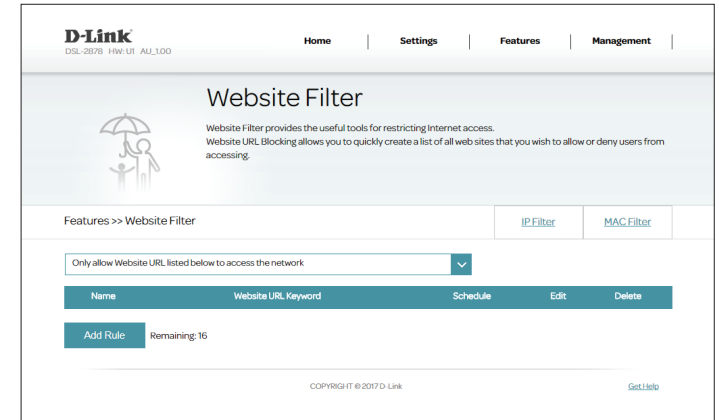

Static Route

The Static Routes section allows you to define custom routes to control how data traffic is moved around your network. To access this page, click **Static Route** from the **Features** menu on the bar on the top of the page.

If you wish to remove a rule, click on its trash can icon in the Delete column. If you wish to edit a rule, click on its pencil icon in the Edit column. If you wish to create a new rule, click the **Add Rules** button. Click **Save** when you are done.

If you edit or create a rule, the following options will appear:

Create New Rule

Destination Address: Enter the destination IP address of packets that will take this route.

Destination Subnet Mask: Enter the destination for this route.

Gateway IP Address: Enter your next hop gateway to be taken if this route is used.

Interface: Specify the interface the route will transit.

Metric: The route metric is a value from 0 to 15 that indicates the cost of using this route.

Click **Apply** when you are done.

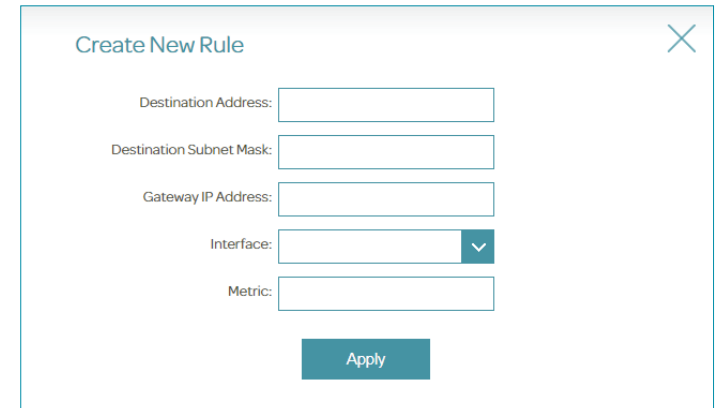
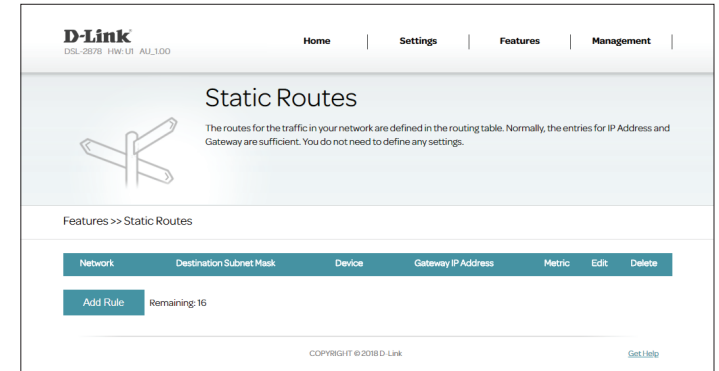

Dynamic DNS

The Dynamic DNS page is used to Most Internet Service Providers (ISPs) assign dynamic (changing) IP addresses. Using a dynamic DNS service provider, people can enter your domain name in their web browser to connect to your server, no matter what your IP address is. To access this page, click **Dynamic DNS** from the **Features** menu on the bar on the top of the page.

Enable Dynamic DNS: Enabling dynamic DNS will reveal further configuration options.

DDNS Server: Select your DDNS server from the drop-down menu.

Username: Enter your dynamic DNS username.

Password: Enter your dynamic DNS password.

Confirm Password: Enter your dynamic DNS password again.

Host Name: Enter the host name that you registered with your dynamic DNS service provider.

Click **Save** when you are done.

The screenshot shows the D-Link Dynamic DNS configuration page. At the top, there is a navigation bar with 'Home', 'Settings', 'Features', and 'Management'. The main heading is 'Dynamic DNS'. Below the heading, there is a brief explanation of Dynamic Domain Name Service and a link to the D-Link ddns service. The 'Dynamic DNS Settings' section shows a toggle switch for 'Dynamic DNS' currently set to 'Disable'. A 'Save' button is visible in the top right corner of the settings area.

This screenshot shows the 'Dynamic DNS Settings' section with the 'Dynamic DNS' toggle switch set to 'Enable'. The configuration fields are as follows:

- DDNS Server: www.dyndns.org (dropdown menu)
- User name: [text input field]
- Password: [text input field]
- Confirm Password: [text input field]
- Hostname: [text input field]
- Interface: PTM_PPPOE_0_1 (dropdown menu)

IGMP

The Internet Group Management Protocol (IGMP) Transmission allows for the transmission of identical content, such as multimedia, from a source to a number of recipients.

IGMP Snooping: Enable and disable Internet Group Management Protocol (IGMP) snooping to build multicast tables.

Wan Proxy: Check the box to enable the Wan proxy on each interface.

IGMP Version: Select the IGMP version to use either **V1/V2** or **V3**.

Click **Save** when you are done.

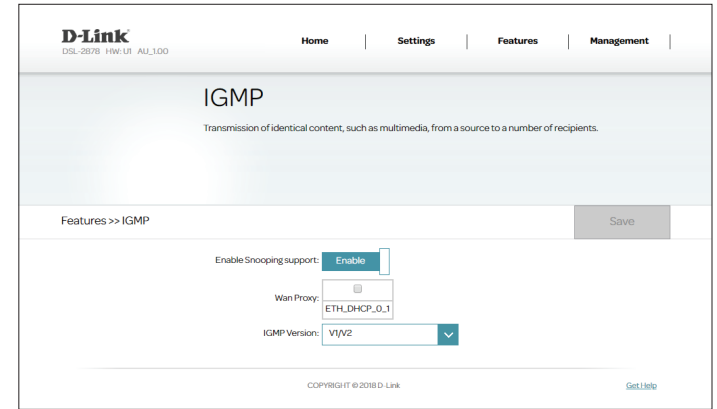

Management

Time & Schedule

Time

The Time page allows you to configure, update, and maintain the correct time for the internal system clock. From here you can set the time zone, the Network Time Protocol (NTP) server, and enable or disable daylight saving time. To access this page, click **Time & Schedule** from the **Management** menu on the bar on the top of the page.

Time: Displays the current date and time of the router.

Synchronize time with: Select either **NTP Server automatically** or uncheck to leave blank.

If you selected **NTP Server automatically**, the following options are available:

Time Zone: Select your time zone from the drop-down menu.

NTP Server Address/2: Enter the NTP server address. The default is **ntp1.dlink.com**. Adding a second server is optional.

Daylight Saving: Enable or disable daylight saving time.

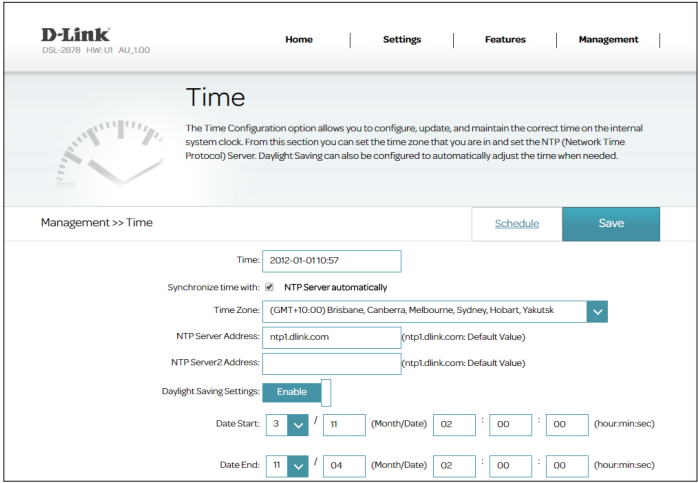

The screenshot shows the D-Link Time configuration page. The page title is "Time" and it includes a brief description: "The Time Configuration option allows you to configure, update, and maintain the correct time on the internal system clock. From this section you can set the time zone that you are in and set the NTP (Network Time Protocol) Server. Daylight Saving can also be configured to automatically adjust the time when needed." The page has a navigation bar with "Home", "Settings", "Features", and "Management". The main content area shows the current time as "2012-01-01 10:57". There are two buttons: "Schedule" and "Save". The "Synchronize time with" checkbox is checked, and the "NTP Server automatically" option is selected. The "Time Zone" is set to "(GMT+10:00) Brisbane, Canberra, Melbourne, Sydney, Hobart, Yakutsk". The "NTP Server Address" is "ntp1.dlink.com" and the "NTP Server2 Address" is blank. The "Daylight Saving Settings" are set to "Enable". The "Date Start" is 03/11 and the "Date End" is 11/04. The time format is (hour:min:sec).

If you enabled **Daylight Saving**, the following options are available:

Date Start: Enter the date and time during which daylight saving starts in your region.

Date End: Enter the date and time during which daylight saving starts in your region.

Click **Save** when you are done. To configure and manage the schedule, click **Schedule** and refer to **Schedule** on page **64**.

The screenshot shows the 'Time' configuration page in a D-Link web interface. At the top, there is a navigation bar with 'Home', 'Settings', 'Features', and 'Management'. The page title is 'Time'. Below the title, there is a brief description: 'The Time Configuration option allows you to configure, update, and maintain the correct time on the internal system clock. From this section you can set the time zone that you are in and set the NTP (Network Time Protocol) Server. Daylight Saving can also be configured to automatically adjust the time when needed.' The interface includes a breadcrumb 'Management >> Time' and two buttons: 'Schedule' and 'Save'. The main configuration area contains the following fields and controls:

- Time:** A text input field showing '2012-01-01 10:57'.
- Synchronize time with:** A checked checkbox labeled 'NTP Server automatically'.
- Time Zone:** A dropdown menu showing '(GMT+10:00) Brisbane, Canberra, Melbourne, Sydney, Hobart, Yakutsk'.
- NTP Server Address:** A text input field with 'ntp1.dlink.com' and a note '(ntp1.dlink.com: Default Value)'.
- NTP Server2 Address:** A text input field with a note '(ntp1.dlink.com: Default Value)'.
- Daylight Saving Settings:** A toggle switch set to 'Enable'.
- Date Start:** A date and time selector showing '3 / 11 (Month/Date) 02 : 00 : 00 (hour:min:sec)'.
- Date End:** A date and time selector showing '11 / 04 (Month/Date) 02 : 00 : 00 (hour:min:sec)'.

Below the main configuration area, there is a separate section for 'Daylight Saving Settings' with a toggle switch set to 'Enable' and two date and time selectors:

- Date Start:** A date and time selector showing '3 / 11 (Month/Date) 02 : 00 : 00 (hour:min:sec)'.
- Date End:** A date and time selector showing '11 / 04 (Month/Date) 02 : 00 : 00 (hour:min:sec)'.

Schedule

Some configuration rules can be set according to a pre-configured schedule. To access this page, click **Time & Schedule** from the **Management** menu on the bar on the top of the page and click the **Schedule** link. To return to the Time page, click **Time**.

If you wish to remove a rule, click on its trash can icon in the Delete column. If you wish to edit a rule, click on its pencil icon in the Edit column. If you wish to create a new rule, click the **Add Rules** button. Click **Apply** when you are done.

If you edit or create a rule, the following options will appear:

First, enter the name of your schedule in the **Name** field.

Each box represents one hour, with the time at the top of each column. To add a time period to the schedule, simply click on the start hour and drag to the end hour. You can add multiple days to the schedule, but only one period per day.

To remove a time period from the schedule, click on the cross icon.

Click **Apply** when you are done.

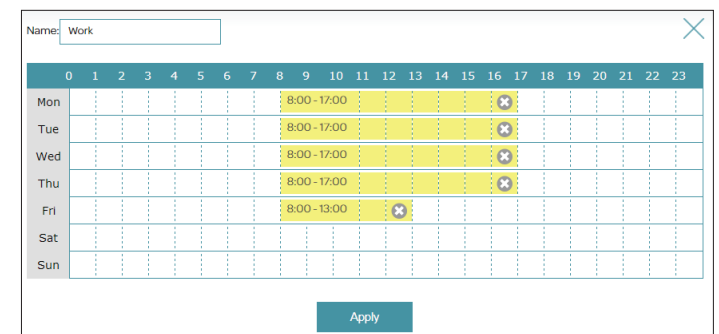
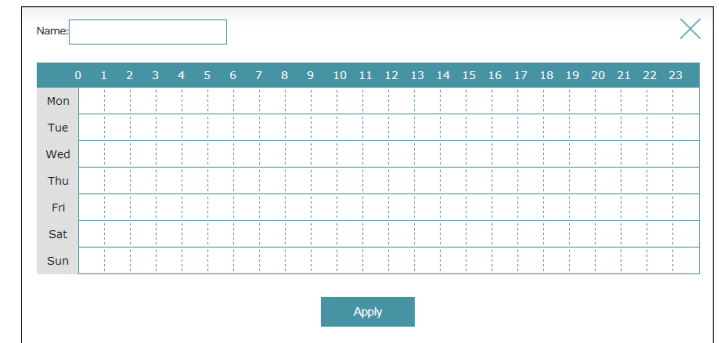
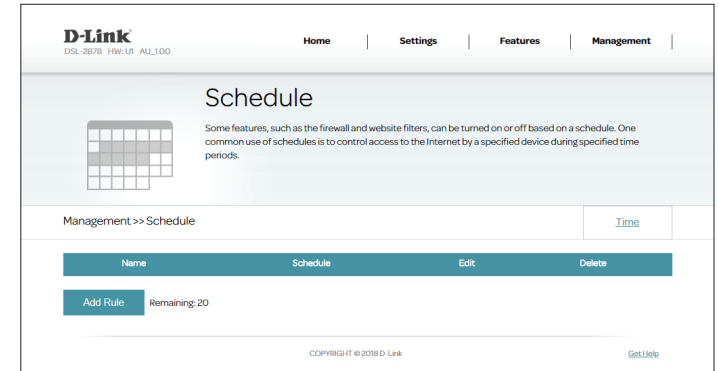

Log Info

The router keeps a running log of events. To access this page, click **Log Info** from the **Management** menu on the bar on the top of the page. System logging must be enabled in order for this feature to work.

Refer to **System Log** on page **66** for information on how to enable the system log.

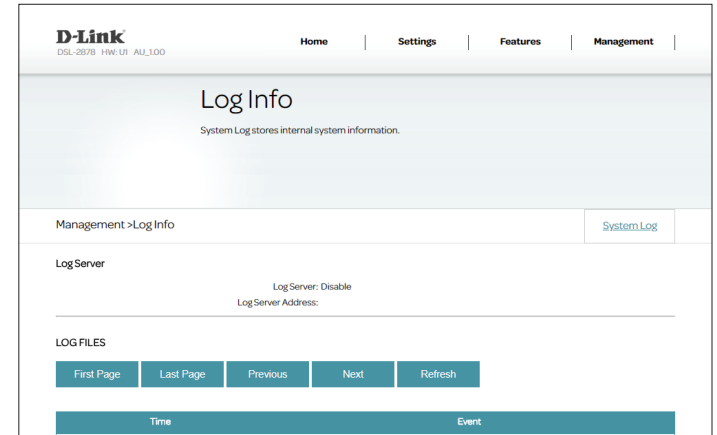

System Log

This page controls how the System Log operates. This log can be sent to a Syslog server or saved to your local hard drive. To access this page, click **Log Info** from the **Management** menu on the bar on the top of the page and then click **System Log**. To return to the Log Info page, click **Log Info**.

Save Log File

Save log file to local Hard Drive: Click this button to save the log file to your local hard drive.

Clear the Log info: Click this button to clear the system log.

Log Type

Log Enable: Activate or deactivate logging.

Log Level: Select the level of detail to be logged.

Remote Log Setting

Log Enable: Activate or deactivate remote logging.

Remote Log Server IP: Enter the IP address for the Syslog server.

Click **Save** when you are done.

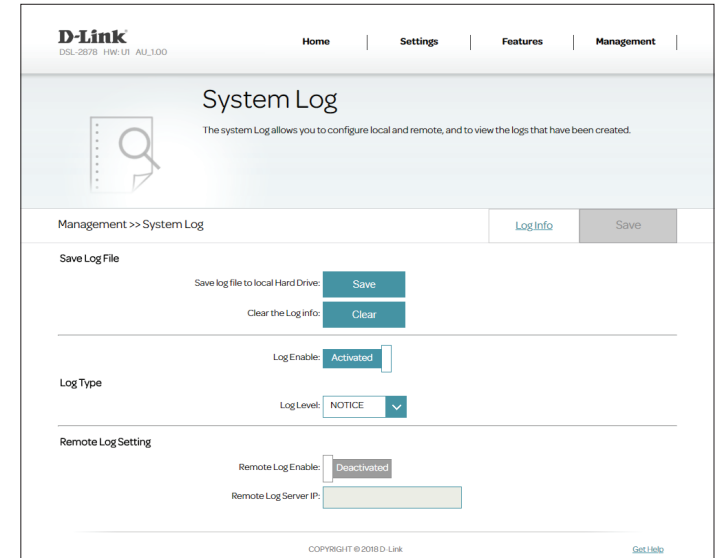

System Settings

This page allows you to save the router's current configuration, load a previously saved configuration, reset the router to its factory default settings, or reboot the router. To access this page, click **System Settings** from the **Management** menu on the bar on the top of the page.

Device Information

Hardware Version: The hardware version of the router is displayed here.

Firmware Version: The current firmware version is displayed here.

System

Save and Reboot The Device: Click to reboot the router.

Restore To Factory Default Settings: This option will restore all configuration settings back to the settings that were in effect at the time the router was shipped from the factory. Any settings that have not been saved will be lost, including any rules that you have created. If you want to save the current router configuration settings, use the **Save Settings To Local Hard Drive** button below.

Save Settings To Local Hard Drive: This option will save the current router configuration settings to a file on your computer.

Load Settings From Local Hard Drive: This option will load a previously saved router configuration file. This will overwrite the router's current configuration.

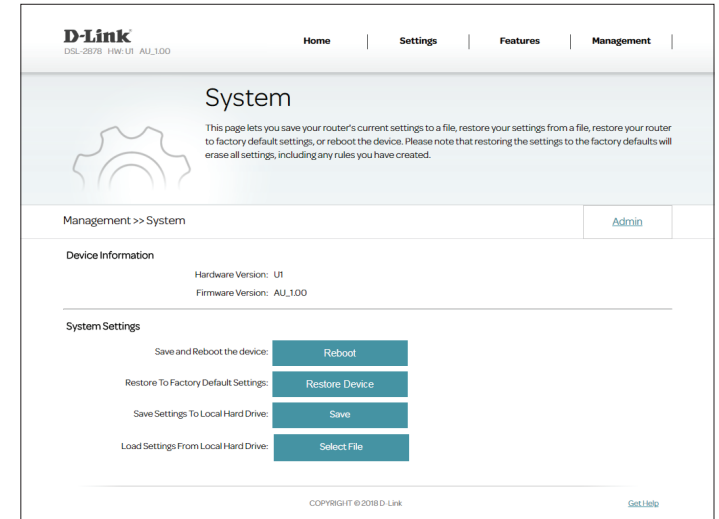

Admin

This page will allow you to change the administrator (admin) password and enable remote management. To access this page, select **System** from the **Management** menu on the bar on the top of the page, and click **Admin**. To return to the **System** page, click **System**.

Administrator Settings

Password: Enter a new password for the admin account. You will need to enter this password whenever you configure the router using a web browser.

Confirm Password: Confirm the administrator account password.

Click **Save** when you are done.

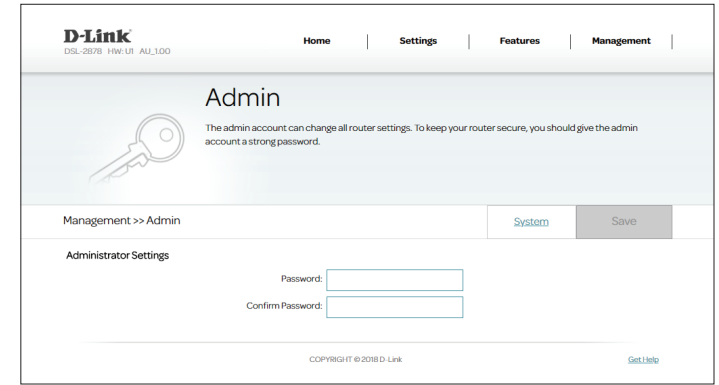

Firmware Upgrade

This page will allow you to upgrade the router's firmware. To access this page, click **Firmware Upgrade** from the **Management** menu on the bar on the top of the page.

To upgrade the firmware, you must first download the relevant file from <http://support.dlink.com>.

Firmware Information

Current Firmware Version: The current firmware's version is displayed.

Firmware Date: The current firmware's date is displayed.

Upgrade Manually

Upgrade Firmware: If you wish to upgrade manually, first download the firmware file you wish to upgrade to. Next, click the **Select File** button and browse to the file to install the new firmware. Then press **Upgrade** to begin the upgrade process. Do not power off the router while the firmware is uploading.

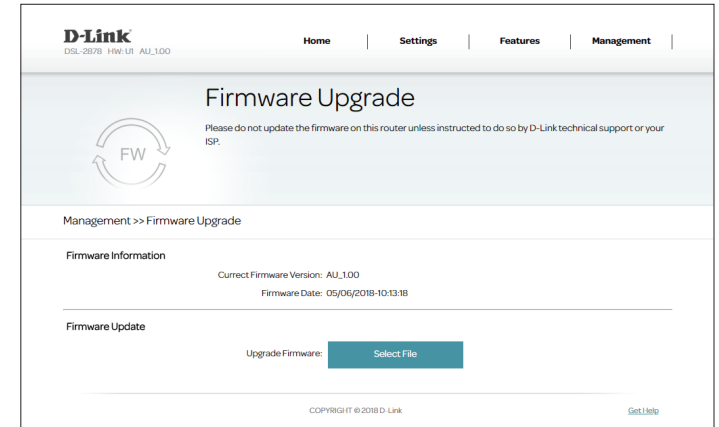

Statistics

This page gives you various statistics about data transmitted and received by your router through the Internet, on your wired network (LAN), and through your wireless networks. To access this page, click **Statistics** from the **Management** menu on the bar on the top of the page.

You can view the statistics of the **Internet, LAN, Wi-Fi 2.4 GHz, or Wi-Fi 5 GHz** interfaces by clicking on their respective tabs at the top of the graph. The graph will update every few seconds. The table at the bottom of the page displays the total number of packets and data sent and received since the DSL-2878 was booted.

The current amount of traffic being sent and received, measured in KByte/sec is displayed, along with the current number of sessions.

To clear the information on the graph, click **Clear**.

Note: The traffic counter will reset if the device is rebooted.

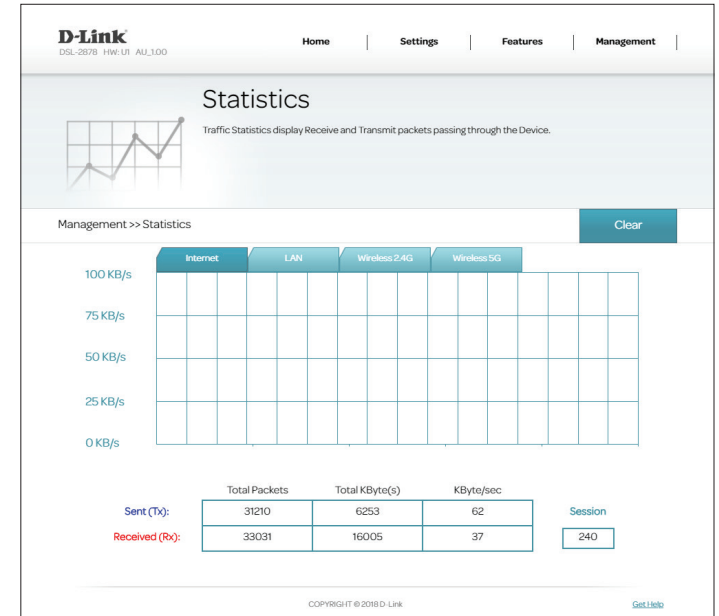

Diagnostics

This page is used to test the router's connection to the Internet. To access this page, click **Diagnostics** from the **Management** menu on the bar on the top of the page.

Enter either an **IP address** or **web address**, select either **Ping** or **Tracert** test, and click **Run Test**.

The results of the test will be displayed in the dialog box. You may copy the results by pressing the **Copy** button.

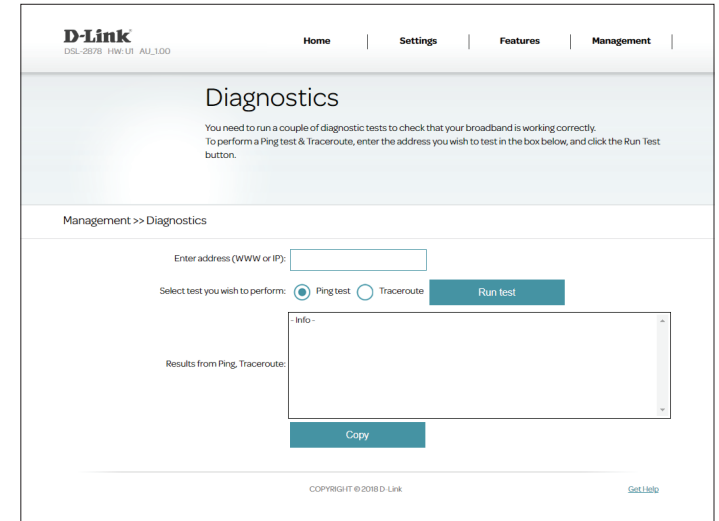

Connect and Share a USB Device

After you have successfully installed and configured your D-Link Modem Router, you are ready to enjoy the benefits of D-Link's USB sharing technology. This allows you to quickly and easily share a USB storage device with multiple computers on your network.

Connect and Share a USB Storage Device

The DSL-2878 will share a FAT32 or NTFS-formatted USB storage device using the Samba file sharing protocol. Once connected, you can copy, move, delete, and edit files over the network like you would with any ordinary drive attached to your computer.

Connect a USB storage device to the USB Port on the DSL-2878.



USB Port

Connecting from a Windows-Based PC

Step 1 - Click the Start menu and select **Computer**.

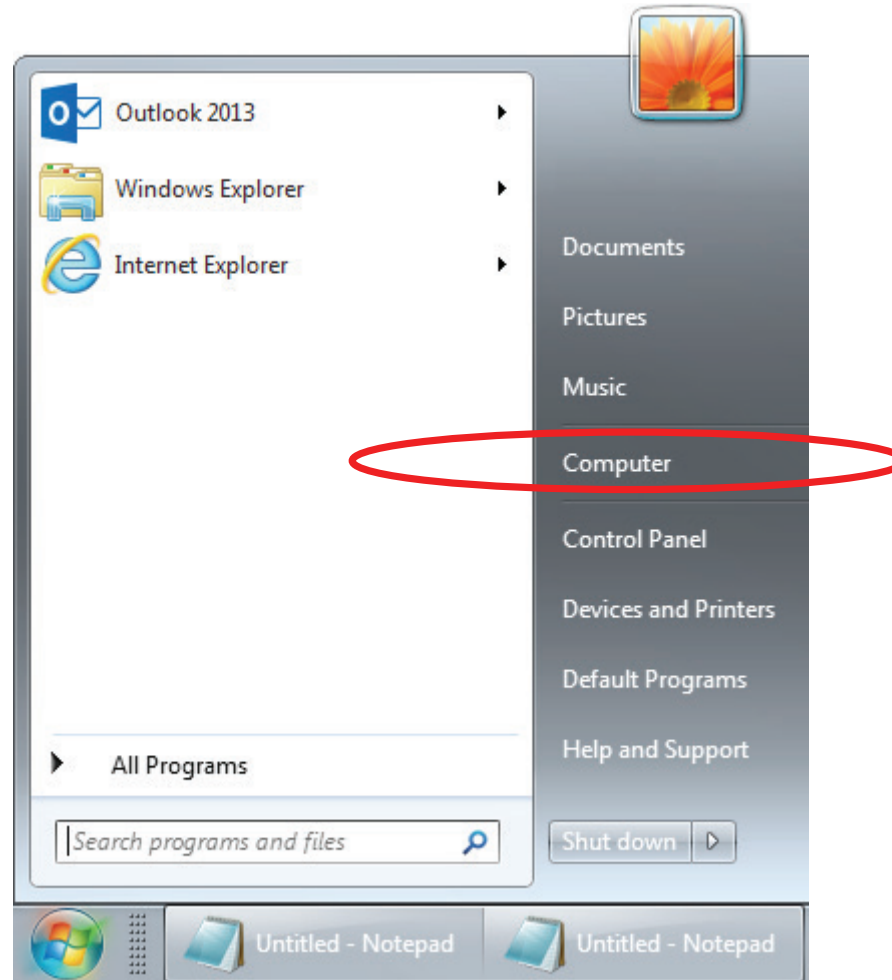

Step 2 - Click Map network drive.

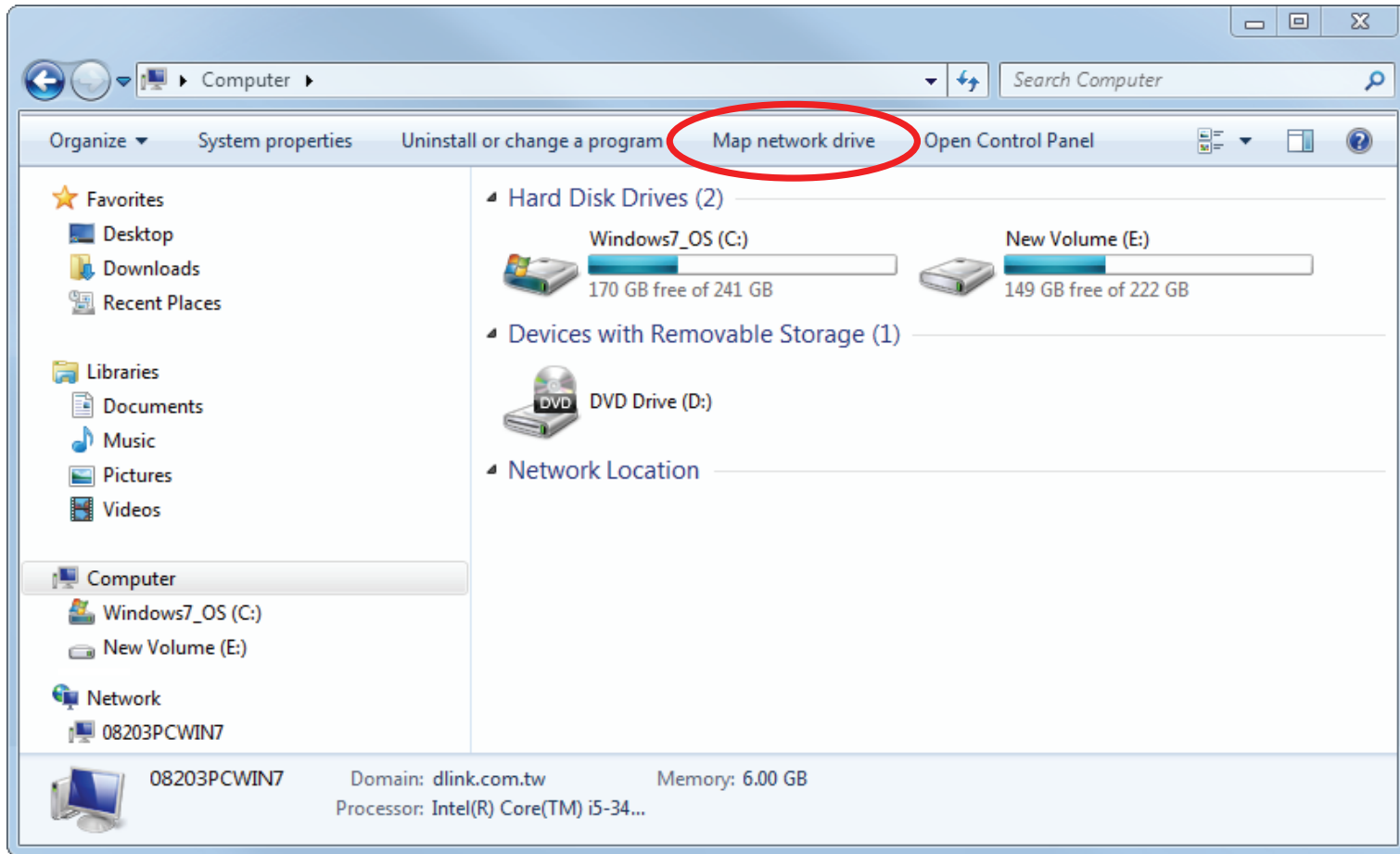

Step 3 - Select the drive letter you wish to map your network drive to. Enter the DSL-2878's IP address and the name of the USB volume you wish to share. For example `\\192.168.1.1\usb`.

Check the boxes **Reconnect at logon** and **Connect using different credentials**.

Click **Finish**.

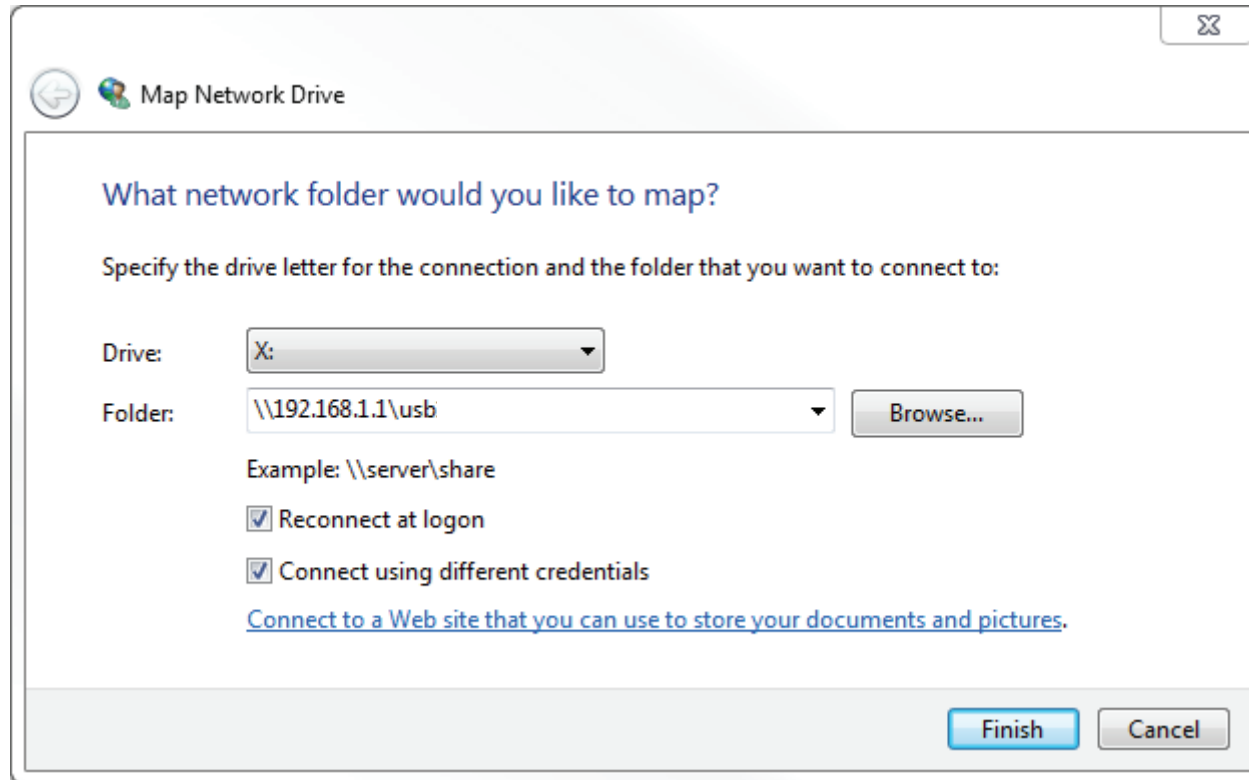

If you have multiple USB storage devices attached via a USB hub, click **USB Device** from the **Home** section of the DSL-2878's Web Configuration utility for a list of available volume names.

Step 4 - Enter **admin** and the password to your router and click **Ok**.

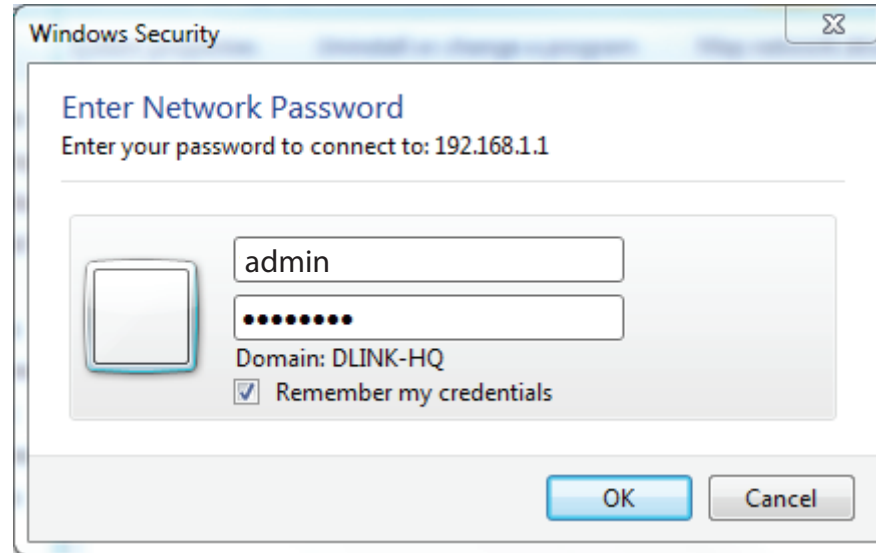

Congratulations! Your files are now shared. Repeat this process from each Windows PC you wish to share your USB drive with.

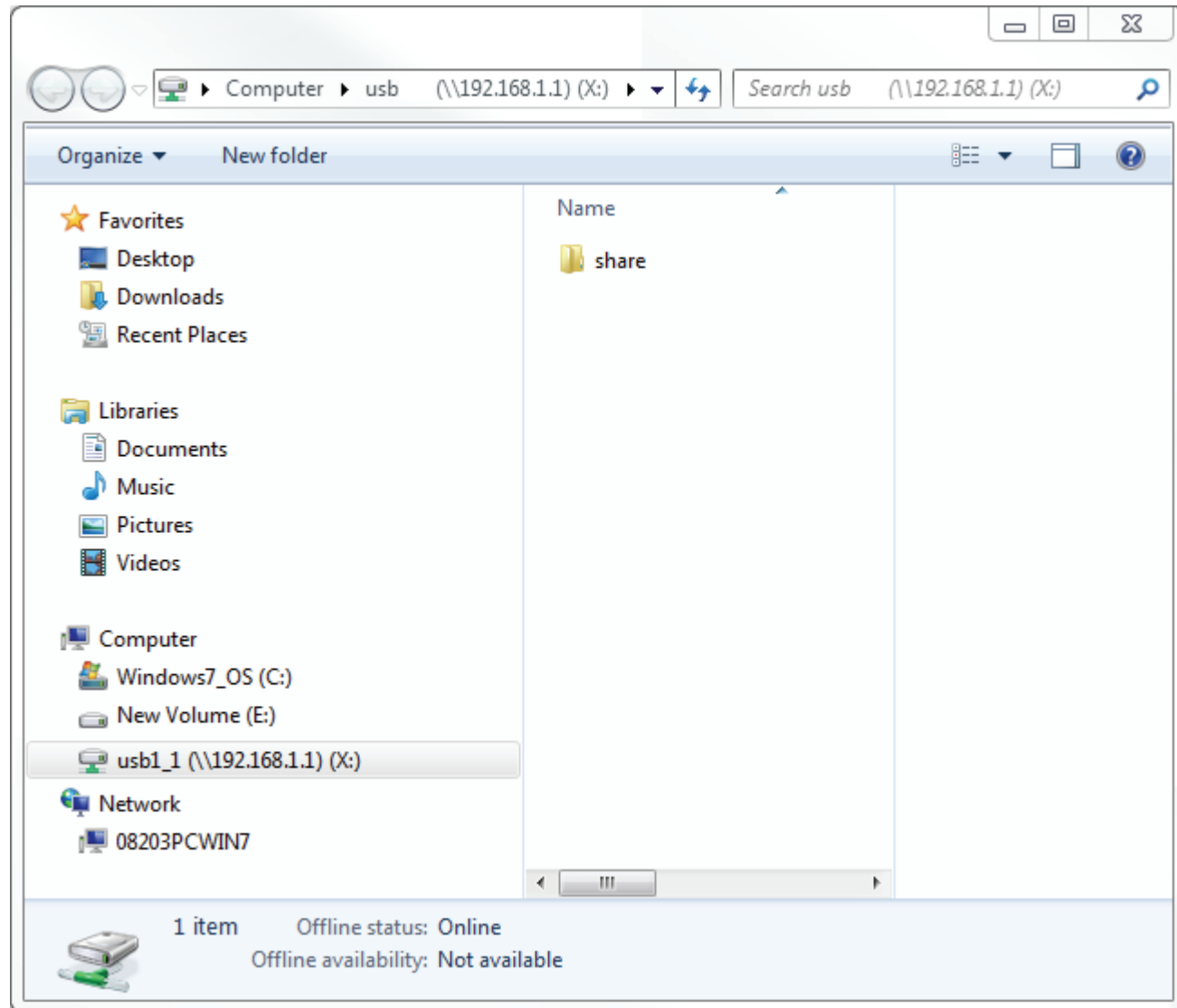

Connecting from a Mac

Step 1 - While in Finder, click **Go** menu and select **Connect to Server...**

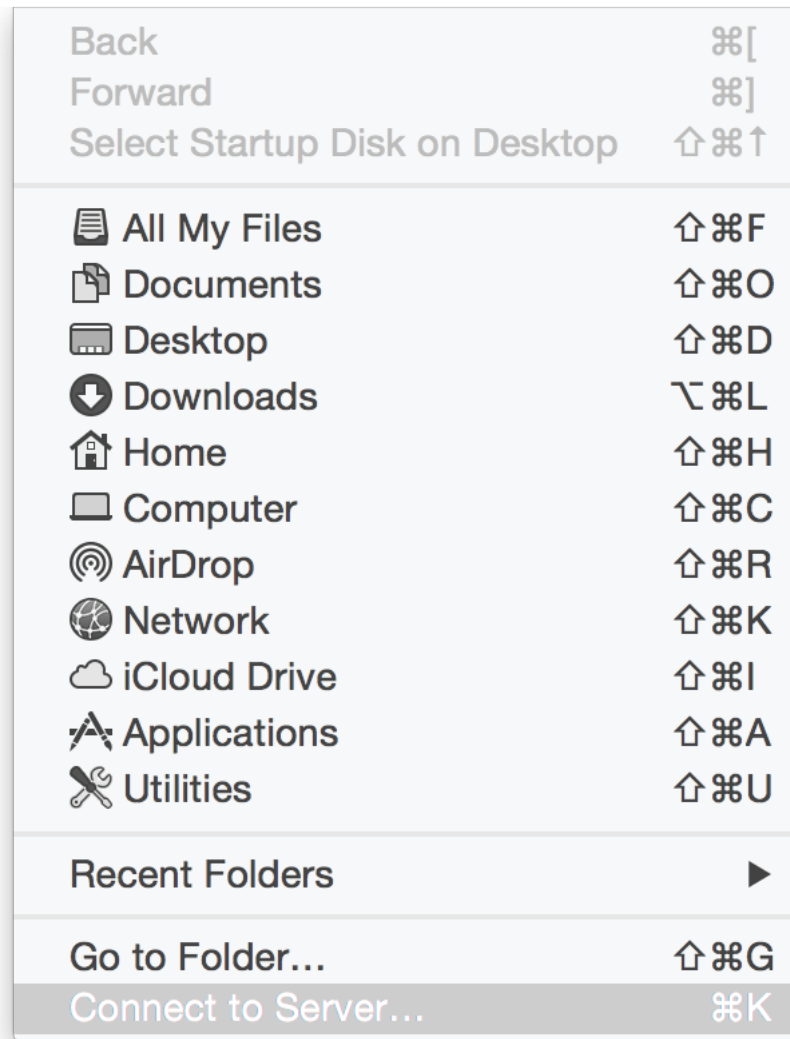

Step 2 - Enter the DSL-2878's IP address and the name of the USB volume you wish to share.
For example **smb://192.168.1.1/usb1_1**.

Click **Connect**.

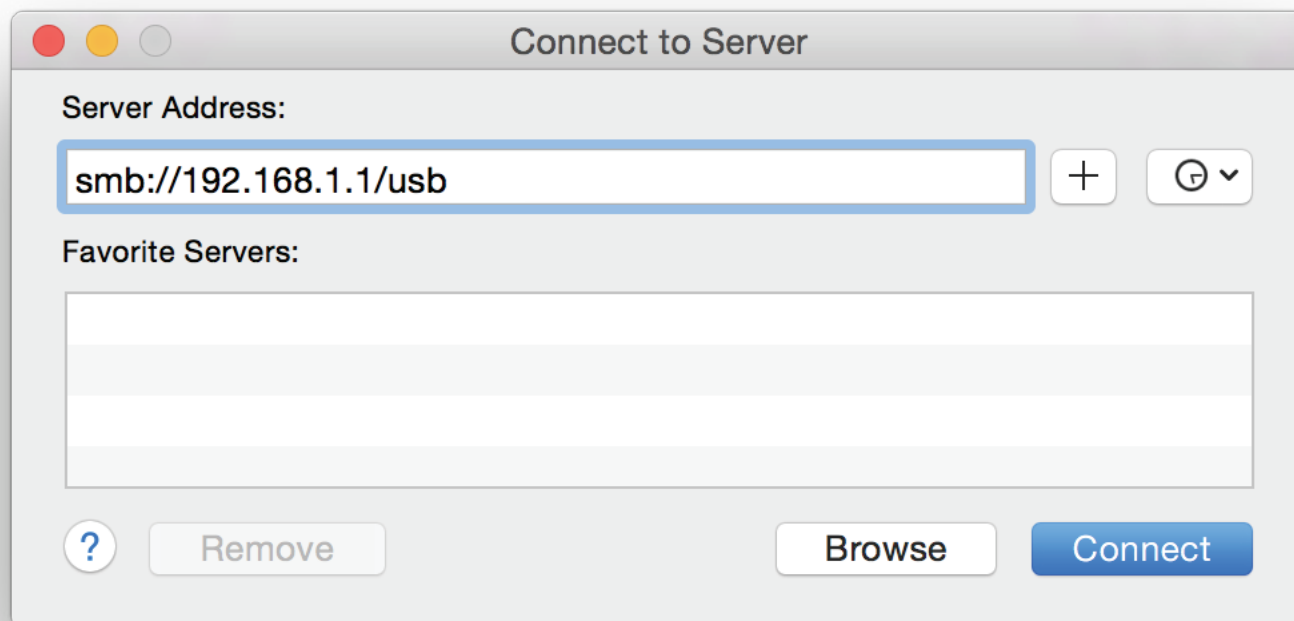

If you have multiple USB storage devices attached via a USB Hub, consult the **HOME>USB** section of the DSL-2878's Web Configuration utility for a list of available volume names.

Step 4 - Enter **admin** and the password to your router and click **Connect**. If you wish to have your computer remember your password, check the **Remember this password in my keychain** box.

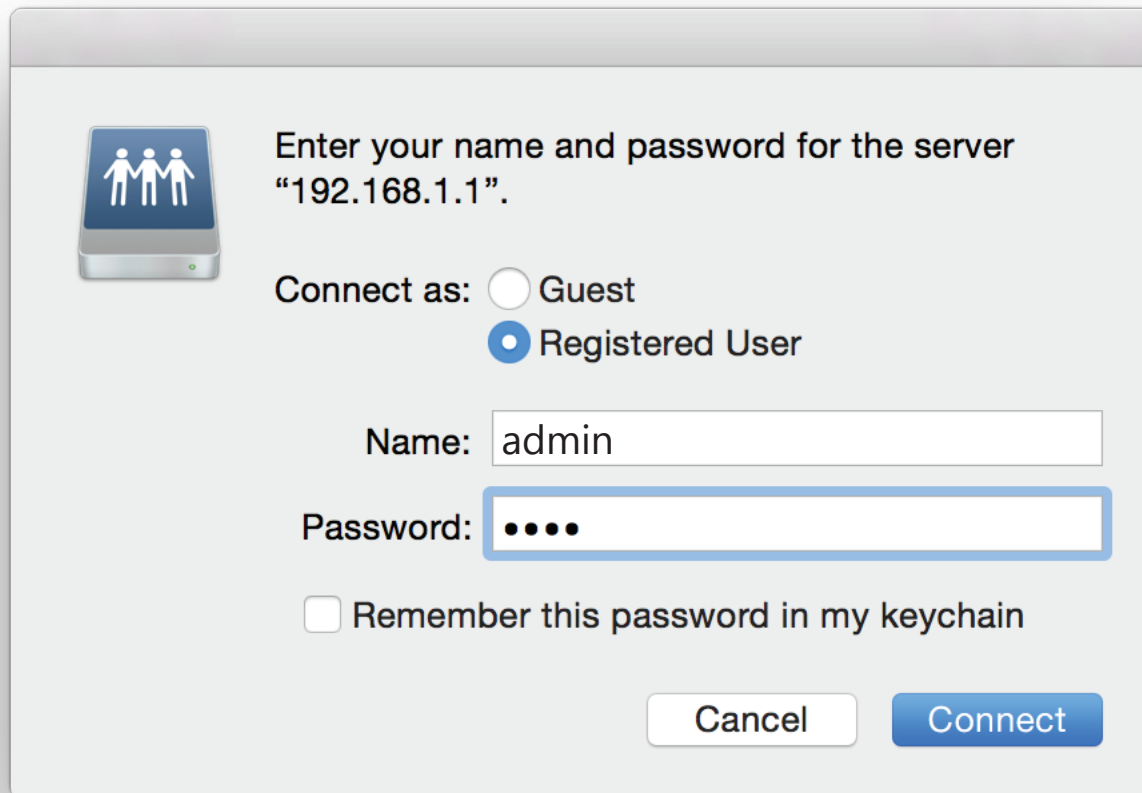

Enter your name and password for the server
"192.168.1.1".

Connect as: Guest
 Registered User

Name:

Password:

Remember this password in my keychain

Congratulations

Your files are now shared. Repeat this process from each Mac you wish to share your USB drive with.

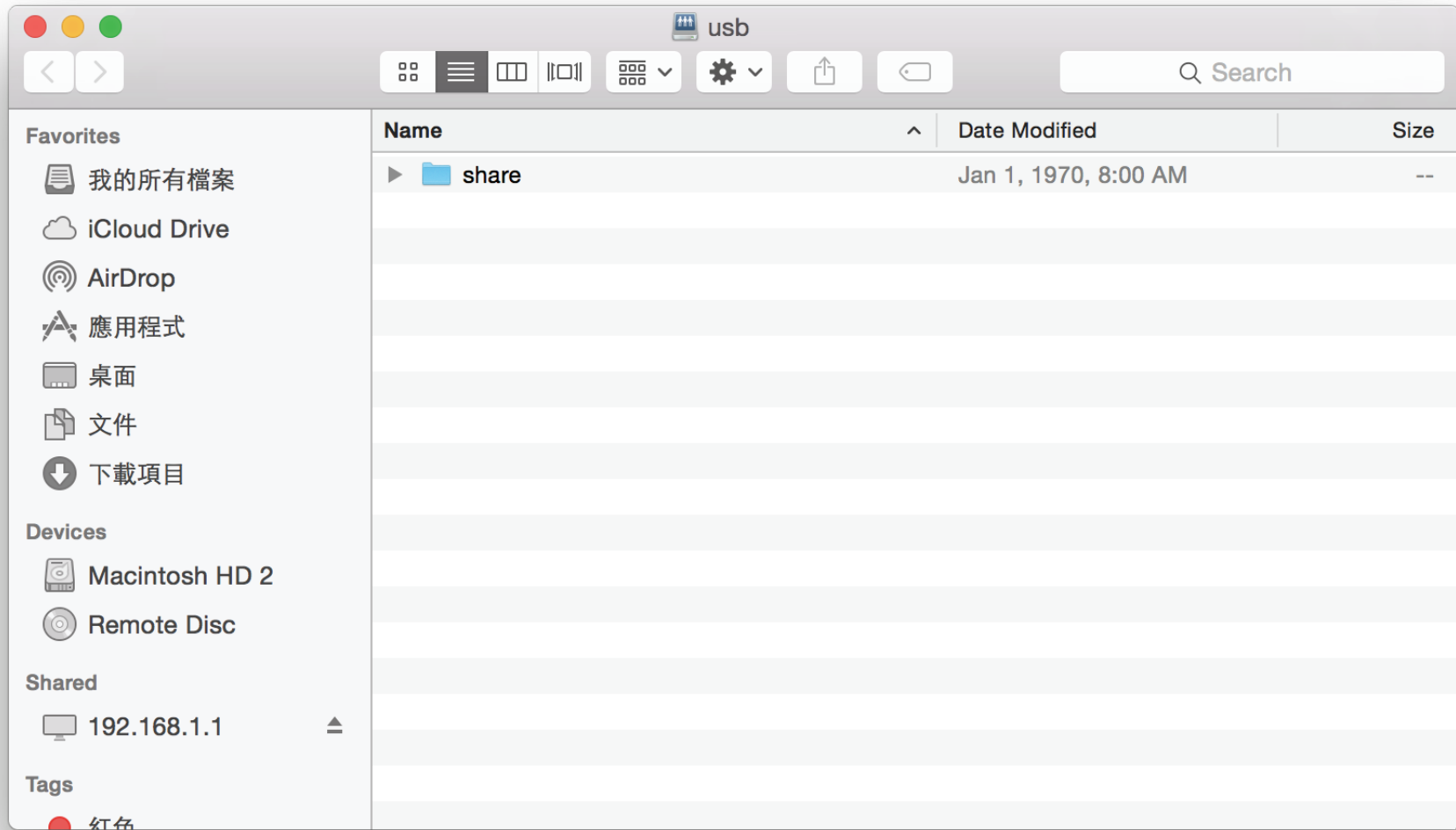

Connect a Wireless Client to Your Router

WPS Button

The easiest and most secure way to connect your wireless devices to the router is with WPS (Wi-Fi Protected Setup). Most wireless devices such as wireless adapters, media players, Blu-ray DVD players, wireless printers and cameras will have a WPS button (or a software utility with WPS) that you can press to connect to the DSL-2878 router. Please refer to your user manual for the wireless device you want to connect to make sure you understand how to enable WPS. Once you know, follow the steps below:

Step 1 - Press the WPS button on the DSL-2878 for about 5 seconds. The WPS LED on the front will start to blink.



Step 2 - Within 2 minutes, press the WPS button on your wireless device (or launch the software utility and start the WPS process).

Step 3 - Allow up to 1 minute for your connection to be configured. Once the WPS LED stops blinking, you will be connected and your wireless connection will be secure with WPA2.

Windows® 10

When connecting to the DSL-2878 wirelessly for the first time, you will need to input the wireless network name (SSID) and Wi-Fi password (security key) of the device you are connecting to. If your product has a Wi-Fi configuration card, you can find the default network name and Wi-Fi password here. Otherwise refer to the product label for the default Wi-Fi network SSID and password, or enter the Wi-Fi credentials set during the product configuration.

To join an existing network, locate the wireless network icon in the taskbar, next to the time display and click on it.

Clicking on this icon will display a list of wireless networks which are within range of your computer. Select the desired network by clicking on the SSID.



Wireless Icon

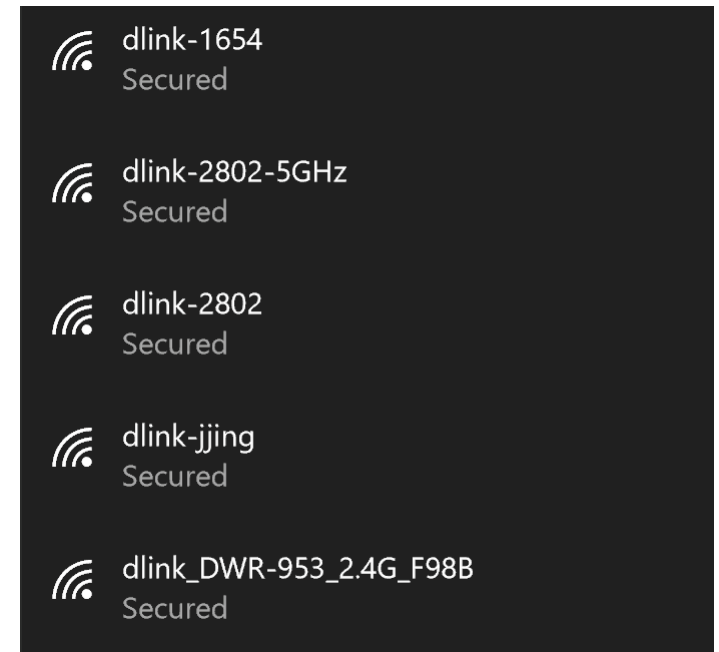

To connect to the SSID, click **Connect**.

To automatically connect with the router when your device next detects the SSID, click the **Connect Automatically** check box.

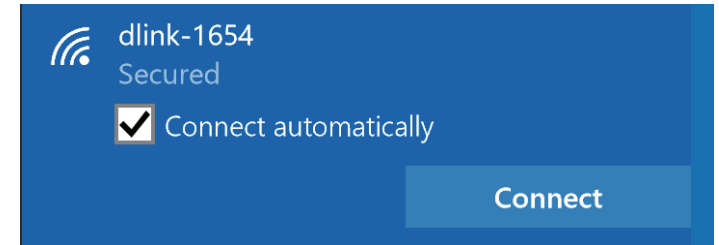

You will then be prompted to enter the Wi-Fi password (network security key) for the wireless network. Enter the password into the box and click **Next** to connect to the network. Your computer will now automatically connect to this wireless network when it is detected.

You can also use Wi-Fi Protected Setup (WPS) to connect to the router. Press the WPS button on your D-Link device and you will be automatically connected.

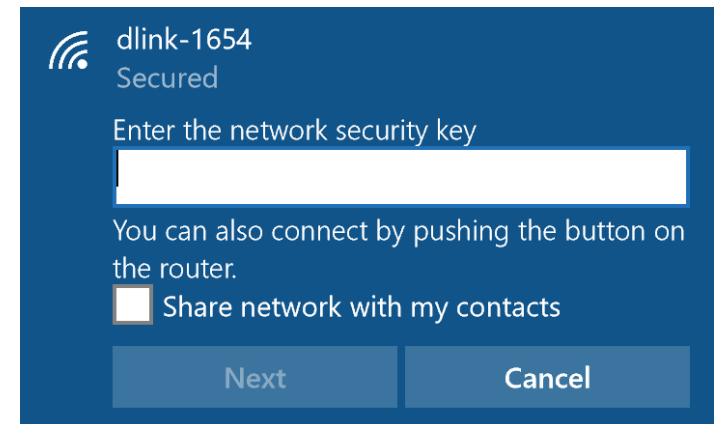

Windows® 8

WPA/WPA2

It is recommended that you enable wireless security (WPA/WPA2) on your wireless router or access point before configuring your wireless adapter. If you are joining an existing network, you will need to know the security key (Wi-Fi password) being used.

To join an existing network, locate the wireless network icon in the taskbar next to the time display.



Clicking on this icon will display a list of wireless networks that are within connecting proximity of your computer. Select the desired network by clicking on the network name.

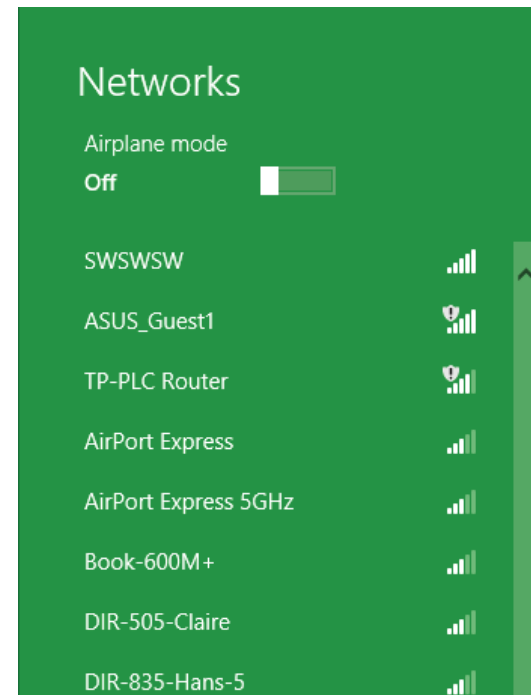

You will then be prompted to enter the network security key (Wi-Fi password) for the wireless network. Enter the password into the box and click **Next**.

If you wish to use Wi-Fi Protected Setup (WPS) to connect to the router, you can also press the WPS button on your router during this step to enable the WPS function.

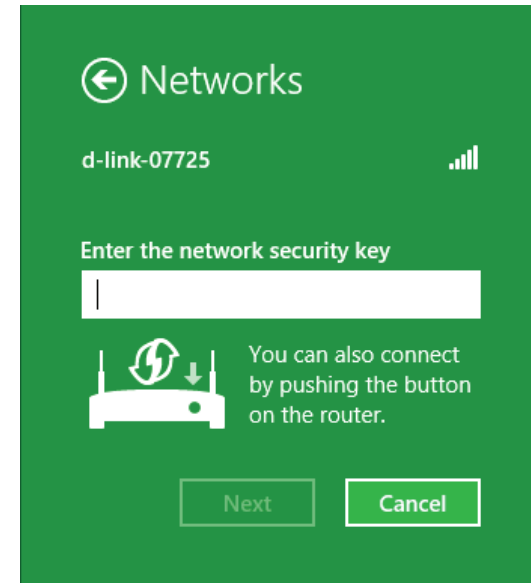

When you have established a successful connection to a wireless network, the word **Connected** will appear next to the name of the network to which you are connected to.

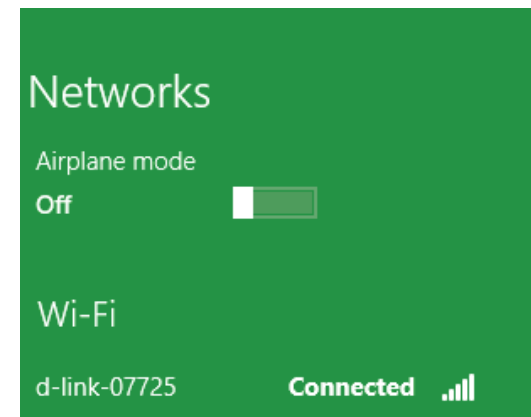

Windows® 7

WPA/WPA2

It is recommended that you enable wireless security (WPA/WPA2) on your wireless router or access point before configuring your wireless adapter. If you are joining an existing network, you will need to know the security key or passphrase being used.

1. Click on the wireless icon in your system tray (lower-right corner).

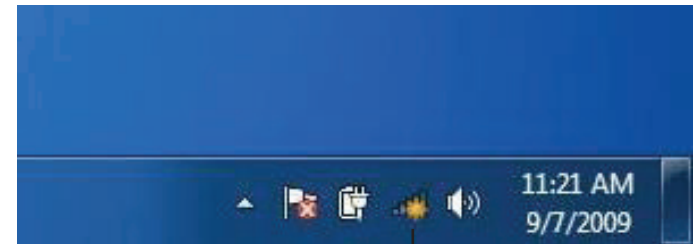

Wireless Icon

2. The utility will display any available wireless networks in your area.



3. Highlight the wireless connection with Wi-Fi name (SSID) you would like to connect to and click the **Connect** button.

If you get a good signal but cannot access the Internet, check your TCP/IP settings for your wireless adapter. Refer to the Networking Basics section in this manual for more information.



4. The following window appears while your computer tries to connect to the router.

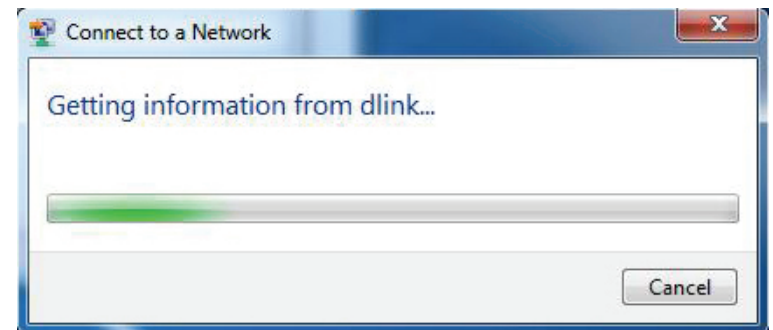

WPS

The WPS feature of the DSL-2878 can be configured using Windows® 7. Carry out the following steps to use Windows® 7 to configure the WPS feature:

1. Click the **Start** button and select **Computer** from the Start menu.

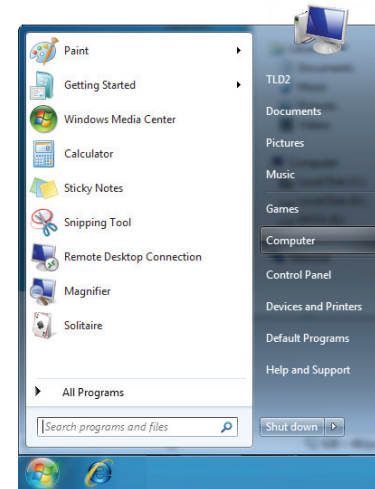

2. Click **Network** on the left side.

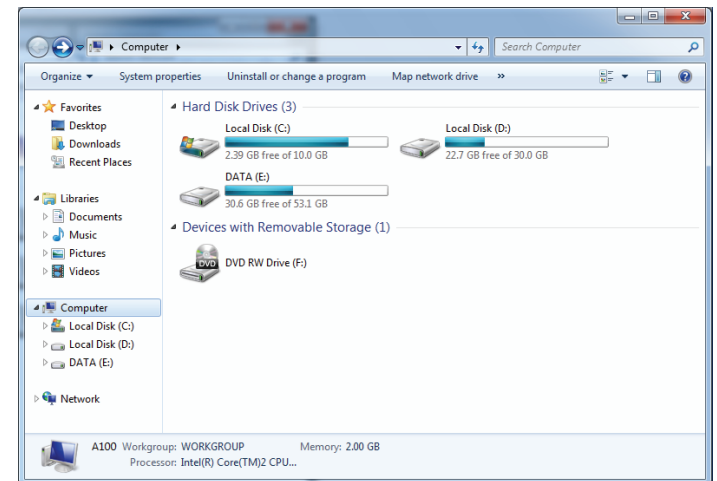

3. Double-click the DSL-2878.

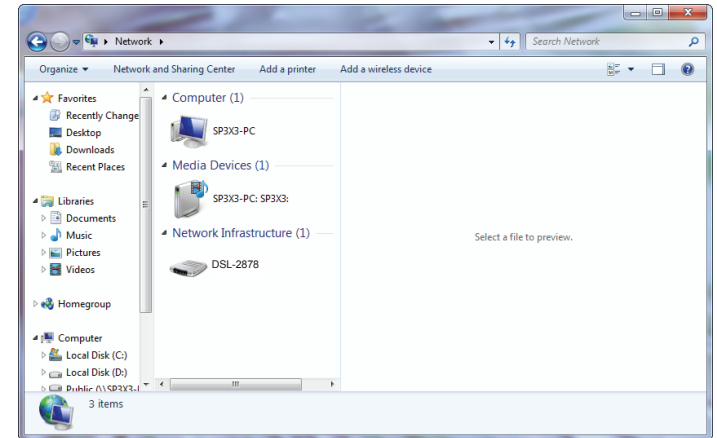

4. Input the WPS PIN number (on the router label) in the **Setup > Wireless Setup** menu in the Router's Web UI) and click **Next**.

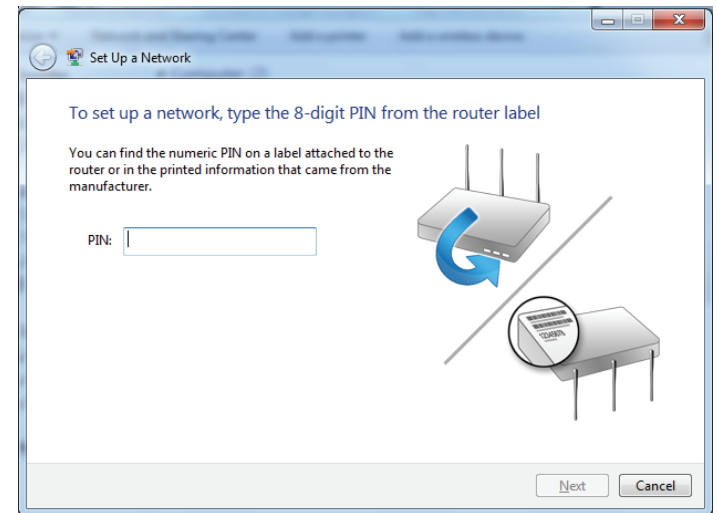

5. Type a name to identify the network.

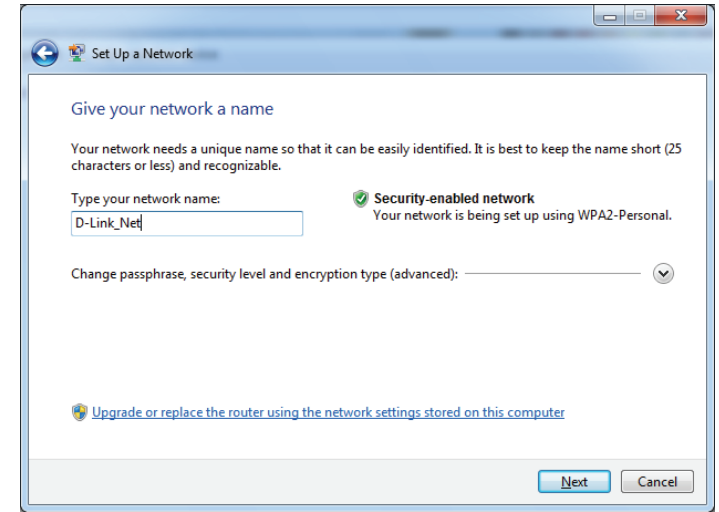

6. To configure advanced settings, click the  icon.

Click **Next** to continue.

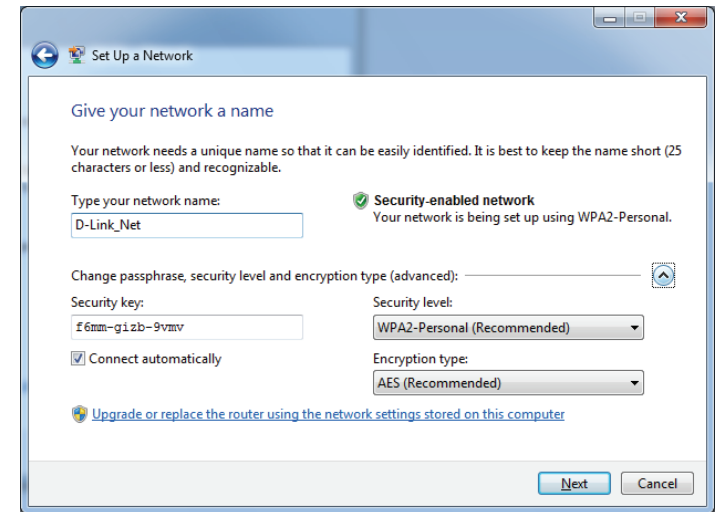

7. The following window appears while the DSL-2878 is being configured.

Wait for the configuration to complete.

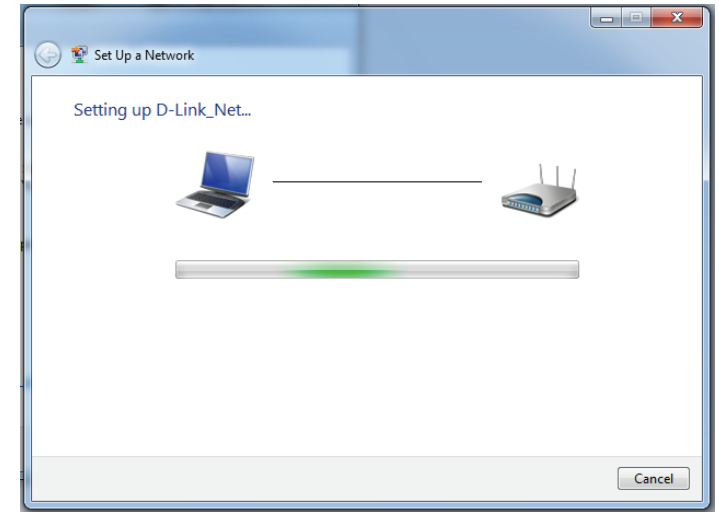

8. The following window informs you that WPS on the DSL-2878 has been set up successfully.

Make a note of the security key as you may need to provide this security key if adding an older wireless device to the network in the future.

9. Click **Close** to complete WPS setup.

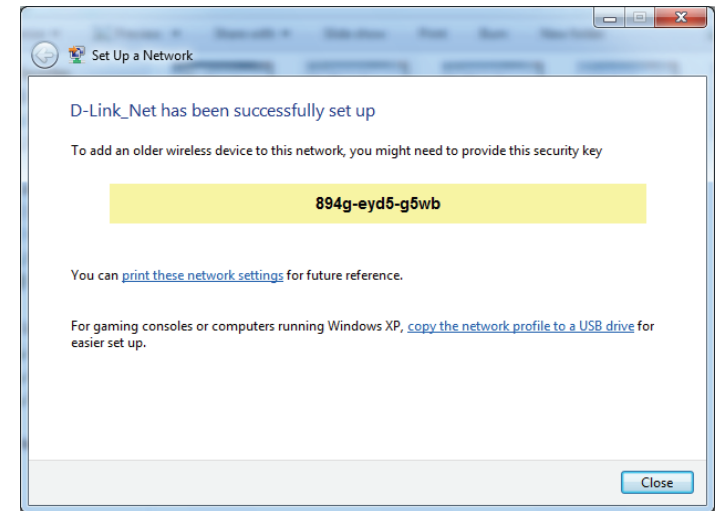

Windows Vista®

Windows Vista® users may use the built-in wireless utility. If you are using another company's wireless utility, please refer to the user manual of your wireless adapter for help connecting to a wireless network. Most wireless utilities will have a "site survey" option similar to the Windows Vista® utility as seen below.

If you receive the **Wireless Networks Detected** bubble, click on the center of the bubble to access the utility.

or

Right-click on the wireless computer icon in your system tray (lower-right corner next to the time). Select **Connect to a network**.

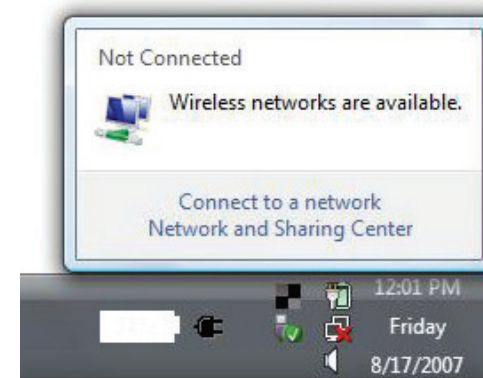

The utility will display any available wireless networks in your area. Click on a network (displayed using the SSID) and click the **Connect** button.

If you get a good signal but cannot access the Internet, check you TCP/IP settings for your wireless adapter. Refer to the **Networking Basics** section in this manual for more information.

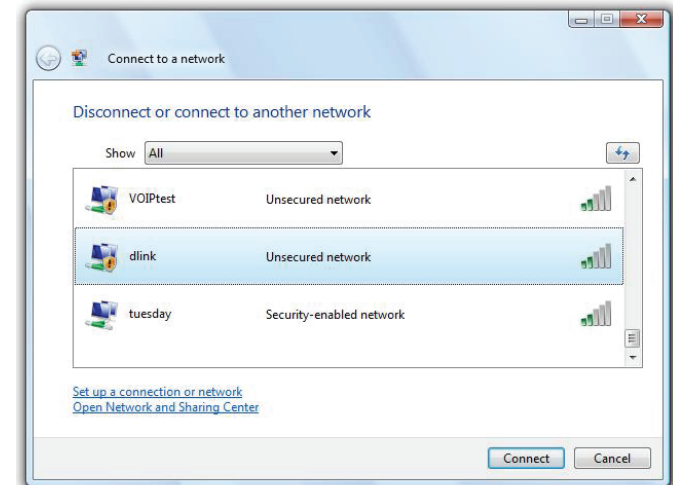

WPA/WPA2

It is recommended that you enable wireless security (WPA/WPA2) on your wireless router or access point before configuring your wireless adapter. If you are joining an existing network, you will need to know the security key or passphrase being used.

1. Open the Windows Vista® Wireless Utility by right-clicking on the wireless computer icon in your system tray (lower right corner of screen). Select **Connect to a network**.

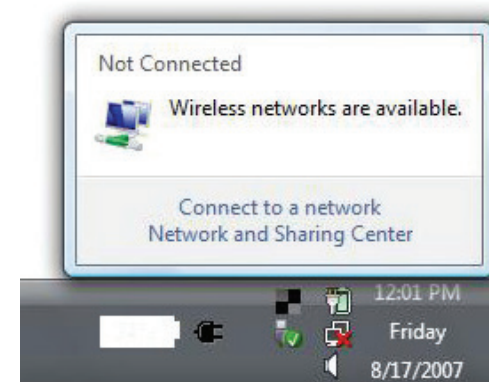

2. Highlight the Wi-Fi name (SSID) you would like to connect to and click **Connect**.

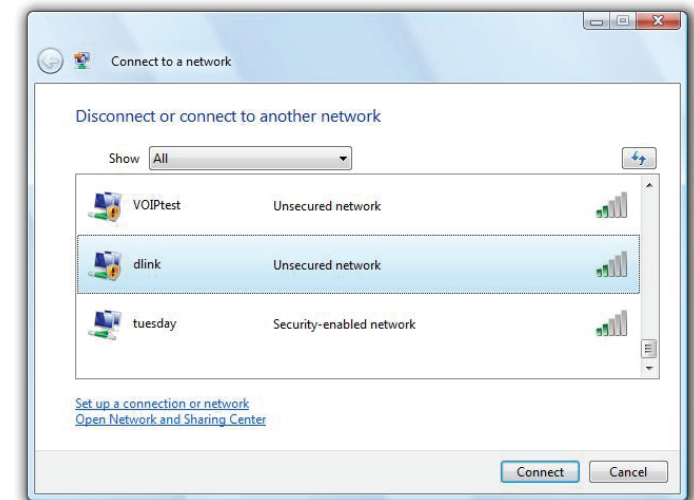

3. Enter the same security key or passphrase (Wi-Fi password) that is on your router and click **Connect**.

It may take 20-30 seconds to connect to the wireless network. If the connection fails, please verify that the security settings are correct. The key or passphrase must be exactly the same as the one on the wireless router.

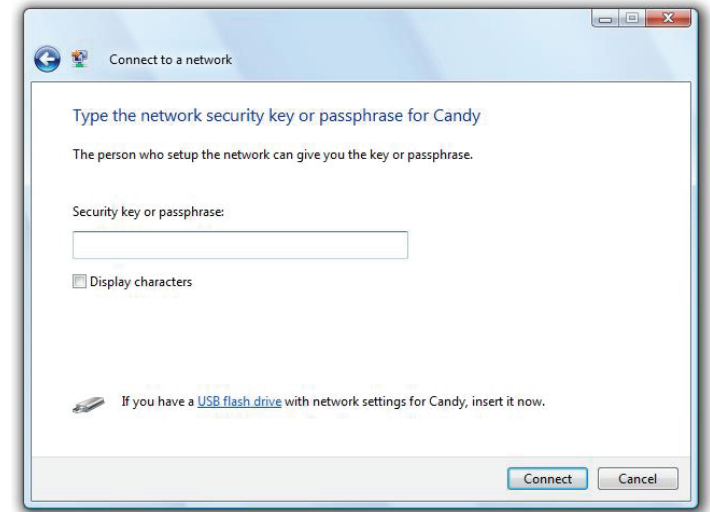

Troubleshooting

This chapter provides solutions to problems that can occur during the installation and operation of the DSL-2878. Read the following descriptions if you are having problems. The examples below are illustrated in Windows® XP. If you have a different operating system, the screenshots on your computer will look similar to these examples.

1. Why can't I access the web-based configuration utility?

When entering the IP address of the D-Link router (**192.168.1.1** for example), you are not connecting to a website, nor do you have to be connected to the Internet. The device has the utility built-in to a ROM chip in the device itself. Your computer must be on the same IP subnet to connect to the web-based utility.

- Make sure you have an updated Java-enabled web browser. We recommend the following:
 - Internet Explorer 8 or higher
 - EDGE Browser 20 or higher
 - Firefox 20 or higher
 - Safari 4 or higher
 - Chrome 17 or higher
- Verify physical connectivity by checking for solid link lights on the device. If you do not get a solid link light, try using a different cable, or connect to a different port on the device if possible. If the computer is turned off, the link light may not be on.
- Disable any Internet security software running on the computer. Software firewalls such as ZoneAlarm, BlackICE, Sygate, Norton Personal Firewall, and Windows® XP firewall may block access to the configuration pages. Check the help files included with your firewall software for more information on disabling or configuring it.

- Configure your Internet settings:
 - Go to **Start > Settings > Control Panel**. Double-click the **Internet Options** icon. From the **Security** tab, click the button to restore the settings to their defaults.
 - Click the **Connection** tab and set the dial-up option to Never Dial a Connection. Click the LAN Settings button. Make sure nothing is checked. Click **OK**.
 - Go to the **Advanced** tab and click the button to restore these settings to their defaults. Click **OK** three times.
 - Close your web browser (if open) and open it.
- Access the web management. Open your web browser and enter the IP address of your D-Link router in the address bar. This should open the login page for your web management.
- If you still cannot access the configuration, unplug the power to the router for 10 seconds and plug back in. Wait about 30 seconds and try accessing the configuration. If you have multiple computers, try connecting using a different computer.

2. What can I do if I forgot my password?

If you forgot your password, you must reset your router. This process will change all your settings back to the factory defaults.

To reset the router, locate the reset button (hole) on the rear panel of the unit. With the router powered on, use a paperclip to hold the button down for 10 seconds. Release the button and the router will go through its reboot process. Wait about 30 seconds to access the router. The default IP address is **192.168.1.1**. When logging in, enter the device password shown on device label.

3. Why can't I connect to certain sites or send and receive emails when connecting through my router?

If you are having a problem sending or receiving email, or connecting to secure sites such as eBay, banking sites, and Hotmail, we suggest lowering the MTU in increments of ten (Ex. 1492, 1482, 1472, etc).

To find the proper MTU Size, you'll have to do a special ping of the destination you're trying to go to. A destination could be another computer, or a URL.

- Click on **Start** and then click **Run**.
- Windows® 95, 98, and Me users type in **command** (Windows® NT, 2000, XP, Vista®, and 7 users type in **cmd**) and press **Enter** (or click **OK**).
- Once the window opens, you'll need to do a special ping. Use the following syntax:

ping [url] [-f] [-l] [MTU value]

Example: **ping yahoo.com -f -l 1472**

```
C:\>ping yahoo.com -f -l 1482
Pinging yahoo.com [66.94.234.13] with 1482 bytes of data:
Packet needs to be fragmented but DF set.
Packet needs to be fragmented but DF set.
Packet needs to be fragmented but DF set.
Packet needs to be fragmented but DF set.
Ping statistics for 66.94.234.13:
    Packets: Sent = 4, Received = 0, Lost = 4 (100% loss),
    Approximate round trip times in milli-seconds:
        Minimum = 0ms, Maximum = 0ms, Average = 0ms
C:\>ping yahoo.com -f -l 1472
Pinging yahoo.com [66.94.234.13] with 1472 bytes of data:
Reply from 66.94.234.13: bytes=1472 time=93ms TTL=52
Reply from 66.94.234.13: bytes=1472 time=109ms TTL=52
Reply from 66.94.234.13: bytes=1472 time=125ms TTL=52
Reply from 66.94.234.13: bytes=1472 time=203ms TTL=52
Ping statistics for 66.94.234.13:
    Packets: Sent = 4, Received = 4, Lost = 0 (0% loss),
    Approximate round trip times in milli-seconds:
        Minimum = 93ms, Maximum = 203ms, Average = 132ms
C:\>
```

You should start at 1472 and work your way down by 10 each time. Once you get a reply, go up by 2 until you get a fragmented packet. Take that value and add 28 to the value to account for the various TCP/IP headers. For example, let's say that 1452 was the proper value, the actual MTU size would be 1480, which is the optimum for the network we're working with ($1452+28=1480$).

Once you find your MTU, you can now configure your router with the proper MTU size.

To change the MTU rate on your router follow the steps below:

- Open your browser, enter the IP address of your router (192.168.1.1) and click **OK**.
- Enter your username (admin) and password (default device password is on the device label). Click **OK** to enter the web configuration page for the device.
- Click on Settings and then Internet. Choose the Advanced Settings.
- To change the MTU, enter the number in the MTU field and click **Save** to save your settings.
- Test your email. If changing the MTU does not resolve the problem, continue changing the MTU in increments of ten.

Wireless Basics

D-Link wireless products are based on industry standards to provide easy-to-use and compatible high-speed wireless connectivity within your home, business, or public access wireless networks. Strictly adhering to the IEEE standard, the D-Link wireless family of products will allow you to securely access the data you want, when, and where you want it. You will be able to enjoy the freedom that wireless networking delivers.

A wireless local area network (WLAN) is a cellular computer network that transmits and receives data with radio signals instead of wires. Wireless LANs are used increasingly in both home and office environments, and public areas such as airports, coffee shops and universities. Innovative ways to utilize WLAN technology are helping people work, and communicate more efficiently. Increased mobility and the absence of cabling and other fixed infrastructure have proven to be beneficial for many users.

Wireless users can use the same applications they use on a wired network. Wireless adapter cards used on laptop and desktop systems support the same protocols as Ethernet adapter cards.

Under many circumstances, it may be desirable for mobile network devices to link to a conventional Ethernet LAN in order to use servers, printers or an Internet connection supplied through the wired LAN. A wireless router is a device used to provide this link.

What is Wireless?

Wireless or Wi-Fi technology is another way of connecting your computer to the network without using wires. Wi-Fi uses radio frequency to connect wirelessly so you have the freedom to connect computers anywhere in your home or office network.

Why D-Link Wireless?

D-Link is the worldwide leader and award winning designer, developer, and manufacturer of networking products. D-Link delivers the performance you need at a price you can afford. D-Link has all the products you need to build your network.

How does wireless work?

Wireless works similarly to how cordless phones work, through radio signals that transmit data from one point A to point B. But wireless technology has restrictions as to how you can access the network. You must be within the wireless network range area to be able to connect your computer. There are two different types of wireless networks: Wireless Local Area Network (WLAN), and Wireless Personal Area Network (WPAN).

Wireless Local Area Network (WLAN)

In a wireless local area network, a device called an Access Point (AP) connects computers to the network. The access point has a small antenna attached to it, which allows it to transmit data back and forth over radio signals. With an indoor access point the signal can travel up to 300 feet. With an outdoor access point the signal can reach out up to 30 miles to serve places like manufacturing plants, industrial locations, university and high school campuses, airports, golf courses, and many other outdoor venues.

Wireless Personal Area Network (WPAN)

Bluetooth is the industry standard wireless technology used for WPAN. Bluetooth devices in WPAN operate in a range up to 30 feet away.

Compared to WLAN the speed and wireless operation range are both less than WLAN, but in return it doesn't use nearly as much power. This makes it ideal for personal devices, such as mobile phones, PDAs, headphones, laptops, speakers, and other devices that operate on batteries.

Who uses wireless?

Wireless technology has become so popular in recent years that almost everyone is using it, whether it's for home, office, business, D-Link has a wireless solution for it.

Home Uses/Benefits

- Gives everyone at home broadband access
- Surf the web, check email, instant message, etc.
- Gets rid of the cables around the house
- Simple and easy to use

Small Office and Home Office Uses/Benefits

- Stay on top of everything at home as you would at office
- Remotely access your office network from home
- Share Internet connection and printer with multiple computers
- No need to dedicate office space

Where is wireless used?

Wireless technology is expanding everywhere, not just at home or office. People like the freedom of mobility and it's becoming so popular that more and more public facilities now provide wireless access to attract people. The wireless connection in public places is usually called "hotspots".

Using a D-Link USB adapter with your laptop, you can access the hotspot to connect to the Internet from remote locations like: airports, hotels, coffee shops, libraries, restaurants, and convention centers.

Wireless network is easy to setup, but if you're installing it for the first time it could be quite a task not knowing where to start. That's why we've put together a few setup steps and tips to help you through the process of setting up a wireless network.

Tips

Here are a few things to keep in mind, when you install a wireless network.

Centralize your router or access point

Make sure you place the router/access point in a centralized location within your network for the best performance. Try to place the router/access point as high as possible in the room, so the signal gets dispersed throughout your home. If you have a two-story home, you may need a repeater to boost the signal to extend the range.

Eliminate Interference

Place home appliances such as cordless telephones, microwaves, and televisions as far away as possible from the router/access point. This would significantly reduce any interference that the appliances might cause since they operate on same frequency.

Security

Don't let your next-door neighbors or intruders connect to your wireless network. Secure your wireless network by turning on the WPA or WEP security feature on the router. Refer to the product manual for detail information on how to set it up.

Wireless Modes

There are basically two modes of networking:

- **Infrastructure** – All wireless clients will connect to an access point or wireless router.
- **Ad-hoc** – Directly connecting to another computer for peer-to-peer communication using wireless network adapters on each computer, such as two or more DSL-2878 wireless network USB adapters.

An Infrastructure network contains an access point or wireless router. All the wireless devices, or clients, will connect to the wireless router or access point.

An Ad-hoc network contains only clients, such as laptops with wireless USB adapters. All the adapters must be in Ad-hoc mode to communicate.

Networking Basics

Check your IP address

After you install your new D-Link adapter, by default, the TCP/IP settings should be set to obtain an IP address from a DHCP server (i.e. wireless router) automatically. To verify your IP address, please follow the steps below.

Click on **Start > Run**. In the run box type **cmd** and click **OK**. (Windows® 7/Vista® users type *cmd* in the **Start Search** box.)

At the prompt, type **ipconfig** and press **Enter**.

This will display the IP address, subnet mask, and the default gateway of your adapter.

If the address is 0.0.0.0, check your adapter installation, security settings, and the settings on your router. Some firewall software programs may block a DHCP request on newly installed adapters.

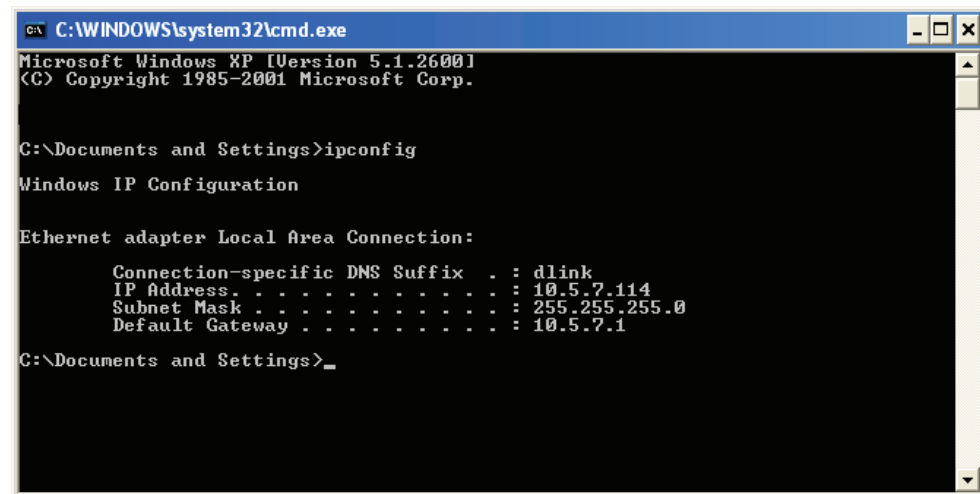

```
C:\WINDOWS\system32\cmd.exe
Microsoft Windows XP [Version 5.1.2600]
(C) Copyright 1985-2001 Microsoft Corp.

C:\Documents and Settings>ipconfig

Windows IP Configuration

Ethernet adapter Local Area Connection:

    Connection-specific DNS Suffix  . : dlink
    IP Address . . . . . : 10.5.7.114
    Subnet Mask . . . . . : 255.255.255.0
    Default Gateway . . . . . : 10.5.7.1

C:\Documents and Settings>_
```

Statically Assign an IP address

If you are not using a DHCP capable gateway/router, or you need to assign a static IP address, please follow the steps below:

Step 1

Windows® 7 - Click on **Start > Control Panel > Network and Internet > Network and Sharing Center.**

Windows Vista® - Click on **Start > Control Panel > Network and Internet > Network and Sharing Center > Manage Network Connections.**

Windows® XP - Click on **Start > Control Panel > Network Connections.**

Windows® 2000 - From the desktop, right-click **My Network Places > Properties.**

Step 2

Right-click on the **Local Area Connection** which represents your network adapter and select **Properties.**

Step 3

Highlight **Internet Protocol (TCP/IP)** and click **Properties.**

Step 4

Click **Use the following IP address** and enter an IP address that is on the same subnet as your network or the LAN IP address on your router.

Example: If the router's LAN IP address is 192.168.1.1, make your IP address 192.168.1.X where X is a number between 2 and 99. Make sure that the number you choose is not in use on the network. Set the Default Gateway the same as the LAN IP address of your router (I.E. 192.168.1.1).

Set Primary DNS the same as the LAN IP address of your router (192.168.1.1). The Secondary DNS is not needed or you may enter a DNS server from your ISP.

Step 5

Click **OK** twice to save your settings.

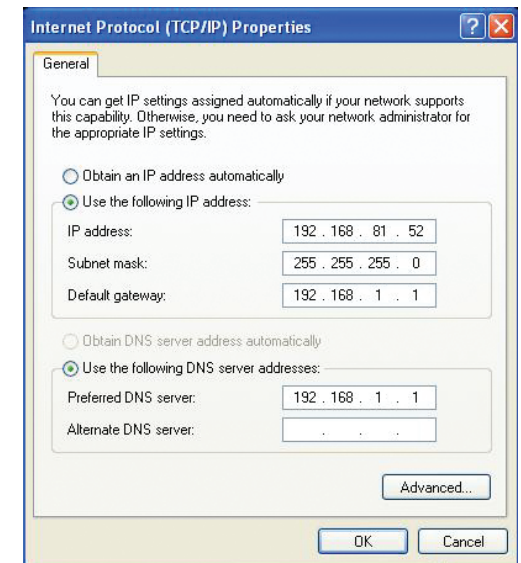

Wireless Security

This section will show you the different levels of security you can use to protect your data from intruders. The DSL-2878 offers the following types of security:

- WPA2 (Wi-Fi Protected Access 2)
- WPA (Wi-Fi Protected Access)
- WPA2-PSK (Pre-Shared Key)
- WPA-PSK (Pre-Shared Key)

What is WPA?

WPA (Wi-Fi Protected Access), is a Wi-Fi standard that was designed to improve the security features of WEP (Wired Equivalent Privacy).

The 2 major improvements over WEP:

- Improved data encryption through the Temporal Key Integrity Protocol (TKIP). TKIP scrambles the keys using a hashing algorithm and by adding an integrity-checking feature, ensures that the keys haven't been tampered with. WPA2 is based on 802.11i and uses Advanced Encryption Standard (AES) instead of TKIP.
- User authentication, which is generally missing in WEP, through the extensible authentication protocol (EAP). WEP regulates access to a wireless network based on a computer's hardware-specific MAC address, which is relatively simple to be sniffed out and stolen. EAP is built on a more secure public-key encryption system to ensure that only authorized network users can access the network.

WPA-PSK/WPA2-PSK uses a passphrase or key to authenticate your wireless connection. The key is an alpha-numeric password between 8 and 63 characters long. The password can include symbols (!?*&_) and spaces. This key must be the exact same key entered on your wireless router or access point.

WPA/WPA2 incorporates user authentication through the Extensible Authentication Protocol (EAP). EAP is built on a more secure public key encryption system to ensure that only authorized network users can access the network.

Technical Specifications

Device Interfaces

- One RJ-11 xDSL port
- 802.11 ac/n/g/a/b Wireless LAN
- One multi-purpose Gigabit LAN/WAN port
- Three 10/100/1000 Gigabit Ethernet LAN ports
- One USB 2.0 port

Standards

- IEEE 802.11ac/n/g/a/b
- IEEE 802.3/u/ab/x

ADSL/ADSL2/ADSL2+ Standards

- G.dmt/G.lite/G.hs/VBR
- ITU-T G.992.5/ G.992.3/ G.992.4

VDSL Standards

- ITU-T G.993.1/ G.993.2
- Profile 8a/8b/8c/8d/12a/12b/17a/30a

Antenna Types

- Internal dual-band antennas

Wireless Signal Rate¹

- 2.4 Ghz - 300 Mbps
- 5 Ghz - 433 Mbps

Security

- WPA™ - Personal/Enterprise
- WPA2™ - Personal/Enterprise
- Wi-Fi Protected Setup (WPS) PIN/PBC

Note:

¹Maximum wireless signal rate derived from IEEE Standard 802.11g, 802.11n, and 802.11ac specifications. Actual data throughput will vary. Network conditions and environmental factors, including volume of network traffic, building materials and construction, and network overhead, lower actual data throughput rate. Environmental factors will adversely affect wireless signal range.

- Frequency Range varies depending on country's regulation.

Power

- Input: 100 to 240 V AC, 50/60 Hz
- Output: 12 V DC, 1.5 A

Operating Temperature

- 0 to 45 °C (32 to 113 °F)

Storage Temperature

- -20 to 70 °C (-4 to 158 °F)

Operating Humidity

- 10% to 95% maximum (non-condensing)

Certifications

- CE
- Wi-Fi Certified
- LVD
- RCM

Dimensions

- 210 mm (8.27 inches)
- 150 mm (5.91 inches)
- 30.75 mm (1.21 inches)

Weight

- 277.4 grams (9.78 ounces)

Regulatory Statements



	Frequency Band(s) Frequenzband Fréquence bande(s) Bandas de Frecuencia Frequenza/e Frequentie(s)	Max. Output Power (EIRP) Max. Output Power Consommation d'énergie max. Potencia máxima de Salida Potenza max. Output Max. Output Power
5 G	5.15 – 5.25 GHz	200 mW
	5.25 – 5.35 GHz	200 mW
	5.47 – 5.725 GHz	1 W
2.4 G	2.4 – 2.4835 GHz	100 mW

European Community Declaration of Conformity:

Česky [Czech]	Tímto D-Link Corporation prohlašuje, že tento produkt, jeho příslušenství a software jsou v souladu se směrnicí 2014/53/EU. Celý text ES prohlášení o shodě vydaného EU a o firmwaru produktu lze stáhnout na stránkách k produktu www.dlink.com .
Dansk [Danish]	D-Link Corporation erklærer herved, at dette produkt, tilbehør og software er i overensstemmelse med direktiv 2014/53/EU. Den fulde tekst i EU-overensstemmelseserklæringen og produktfirmware kan wnloades fra produktsiden hos www.dlink.com .
Deutsch [German]	Hiermit erklärt die D-Link Corporation, dass dieses Produkt, das Zubehör und die Software der Richtlinie 2014/53/EU entsprechen. Der vollständige Text der Konformitätserklärung der Europäischen Gemeinschaft sowie die Firmware zum Produkt stehen Ihnen zum Herunterladen von der Produktseite im Internet auf www.dlink.com zur Verfügung.
Eesti [Estonian]	Käesolevaga kinnitab D-Link Corporation, et see toode, tarvikud ja tarkvara on kooskõlas direktiiviga 2014/53/EL. Euroopa Liidu vastavusdeklaratsiooni täistekst ja toote püsivara on allalaadimiseks saadaval tootelehel www.dlink.com .
English	Hereby, D-Link Corporation, declares that this product, accessories, and software are in compliance with directive 2014/53/EU. The full text of the EU Declaration of Conformity and product firmware are available for download from the product page at www.dlink.com
Español [Spanish]	Por la presente, D-Link Corporation declara que este producto, accesorios y software cumplen con las directivas 2014/53/UE. El texto completo de la declaración de conformidad de la UE y el firmware del producto están disponibles y se pueden descargar desde la página del producto en www.dlink.com .
Ελληνική [Greek]	Με την παρούσα, η D-Link Corporation δηλώνει ότι αυτό το προϊόν, τα αξεσουάρ και το λογισμικό συμμορφώνονται με την Οδηγία 2014/53/ΕΕ. Το πλήρες κείμενο της δήλωσης συμμόρφωσης της ΕΕ και το υλικολογισμικό του προϊόντος είναι διαθέσιμα για λήψη από τη σελίδα του προϊόντος στην τοποθεσία www.dlink.com .
Français [French]	Par les présentes, D-Link Corporation déclare que ce produit, ces accessoires et ce logiciel sont conformes aux directives 2014/53/UE. Le texte complet de la déclaration de conformité de l'UE et le microprogramme du produit sont disponibles au téléchargement sur la page des produits à www.dlink.com .
Italiano [Italian]	Con la presente, D-Link Corporation dichiara che questo prodotto, i relativi accessori e il software sono conformi alla direttiva 2014/53/UE. Il testo completo della dichiarazione di conformità UE e il firmware del prodotto sono disponibili per il download dalla pagina del prodotto su www.dlink.com .

Latviski [Latvian]	Ar šo uzņēmums D-Link Corporation apliecina, ka šis produkts, piederumi un programmatūra atbilst direktīvai 2014/53/ES. ES atbilstības deklarācijas pilno tekstu un produkta aparātprogrammatūru var lejupielādēt attiecīgā produkta lapā vietnē www.dlink.com .
Lietuvių [Lithuanian]	Šiuo dokumentu „D-Link Corporation“ pareiškia, kad šis gaminys, priedai ir programinė įranga atitinka direktyvą 2014/53/ES. Visą ES atitikties deklaracijos tekstą ir gaminio programinę aparatinę įrangą galima atsisiųsti iš gaminio puslapio adresu www.dlink.com .
Nederlands [Dutch]	Hierbij verklaart D-Link Corporation dat dit product, accessoires en software voldoen aan de richtlijnen 2014/53/EU. De volledige tekst van de EU conformiteitsverklaring en productfirmware is beschikbaar voor download van de productpagina op www.dlink.com .
Malti [Maltese]	Bil-preżenti, D-Link Corporation tiddikjara li dan il-prodott, l-aċċessorji, u s-software huma konformi mad-Direttiva 2014/53/UE. Tista' tniżżel it-test s'hih tad-dikjarazzjoni ta' konformità tal-UE u l-firmware tal-prodott mill-paġna tal-prodott fuq www.dlink.com .
Magyar [Hungarian]	Ezennel a D-Link Corporation kijelenti, hogy a jelen termék, annak tartozékai és szoftvere megfelelnek a 2014/53/EU sz. rendeletnek. Az EU Megfelelőségi nyilatkozat teljes szövege és a termék firmware a termék oldaláról tölthető le a www.dlink.com címen.
Polski [Polish]	D-Link Corporation niniejszym oświadcza, że ten produkt, akcesoria oraz oprogramowanie są zgodne z dyrektywami 2014/53/EU. Pełen tekst deklaracji zgodności UE oraz oprogramowanie sprzętowe do produktu można pobrać na stronie produktu w witrynie www.dlink.com .
Português [Portuguese]	Desta forma, a D-Link Corporation declara que este produto, os acessórios e o software estão em conformidade com a diretiva 2014/53/UE. O texto completo da declaração de conformidade da UE e do firmware
Slovensko[Slovenian]	Podjetje D-Link Corporation s tem izjavlja, da so ta izdelek, dodatna oprema in programnska oprema skladni z direktivami 2014/53/EU. Celotno besedilo izjave o skladnosti EU in vdelana programska oprema sta na voljo za prenos na strani izdelka na www.dlink.com .
Slovensky [Slovak]	Spoločnosť D-Link týmto vyhlasuje, že tento produkt, príslušenstvo a softvér sú v súlade so smernicou 2014/53/EÚ. Úplné znenie vyhlásenia EÚ o zhode a firmvéri produktu sú k dispozícii na prevzatie zo stránky produktu www.dlink.com .
Suomi [Finnish]	D-Link Corporation täten vakuuttaa, että tämä tuote, lisävarusteet ja ohjelmisto ovat direktiivin 2014/53/EU vaatimusten mukaisia. Täydellinen EU-vaatimustenmukaisuusvakuutus samoin kuin tuotteen laiteohjelmisto ovat ladattavissa osoitteesta www.dlink.com .
Svenska[Swedish]	D-Link Corporation försäkrar härmed att denna produkt, tillbehör och programvara överensstämmer med direktiv 2014/53/EU. Hela texten med EU-försäkran om överensstämmelse och produkt-firmware kan hämtas från produktsidan på www.dlink.com .

Íslenska [Icelandic]	Hér með lýsir D-Link Corporation því yfir að þessi vara, fylgihlutir og hugbúnaður eru í samræmi við tilskipun 2014/53/EB. Sækja má ESB-samræmisýfirlýsinguna í heild sinni og fastbúnað vörunnar af vefsíðu vörunnar á www.dlink.com .
Norsk [Norwegian]	Herved erklærer D-Link Corporation at dette produktet, tilbehøret og programvaren er i samsvar med direktivet 2014/53/EU. Den fullstendige teksten i EU-erklæring om samsvar og produktets fastvare er tilgjengelig for nedlasting fra produktsiden på www.dlink.com .

Warning Statement:

The power outlet should be near the device and easily accessible.

NOTICE OF WIRELESS RADIO LAN USAGE IN THE EUROPEAN COMMUNITY (FOR WIRELESS PRODUCT ONLY):

- This device is restricted to indoor use when operated in the European Community using channels in the 5.15-5.35 GHz band to reduce the potential for interference.
- This device is a 2.4 GHz wideband transmission system (transceiver), intended for use in all EU member states and EFTA countries. This equipment may be operated in AL, AD, BE, BG, DK, DE, FI, FR, GR, GW, IS, IT, HR, LI, LU, MT, MK, MD, MC, NL, NO, AT, PL, PT, RO, SM, SE, RS, SK, ES, CI, HU, and CY.

Usage Notes:

- To remain in conformance with European National spectrum usage regulations, frequency and channel limitations will be applied on the products according to the country where the equipment will be deployed.
- This device is restricted from functioning in Ad-hoc mode while operating in 5 GHz. Ad-hoc mode is direct peer-to-peer communication between two client devices without an Access Point.
- Access points will support DFS (Dynamic Frequency Selection) and TPC (Transmit Power Control) functionality as required when operating in 5 GHz band within the EU.
- Please refer to the product manual or datasheet to check whether your product uses 2.4 GHz and/or 5 GHz wireless.

HINWEIS ZUR VERWENDUNG VON DRAHTLOS-NETZWERK (WLAN) IN DER EUROPÄISCHEN GEMEINSCHAFT (NUR FÜR EIN DRAHTLOSES PRODUKT)

- Der Betrieb dieses Geräts in der Europäischen Gemeinschaft bei Nutzung von Kanälen im 5,15-5,35 GHz Frequenzband ist ausschließlich auf Innenräume beschränkt, um das Interferenzpotential zu reduzieren.
- Bei diesem Gerät handelt es sich um ein zum Einsatz in allen EU-Mitgliedsstaaten und in EFTA-Ländern - ausgenommen Frankreich. Der Betrieb dieses Geräts ist in den folgenden Ländern erlaubt: AL, AD, BE, BG, DK, DE, FI, FR, GR, GW, IS, IT, HR, LI, LU, MT, MK, MD, MC, NL, NO, AT, PL, PT, RO, SM, SE, RS, SK, ES, CI, HU, CY

Gebrauchshinweise:

- Um den in Europa geltenden nationalen Vorschriften zum Nutzen des Funkspektrums weiterhin zu entsprechen, werden Frequenz und Kanalbeschränkungen, dem jeweiligen Land, in dem das Gerät zum Einsatz kommt, entsprechend, auf die Produkte angewandt.
- Die Funktionalität im Ad-hoc-Modus bei Betrieb auf 5 GHz ist für dieses Gerät eingeschränkt. Bei dem Ad-hoc-Modus handelt es sich um eine Peer-to-Peer-Kommunikation zwischen zwei Client-Geräten ohne einen Access Point.
- Access Points unterstützen die Funktionen DFS (Dynamic Frequency Selection) und TPC (Transmit Power Control) wie erforderlich bei Betrieb auf 5 GHz innerhalb der EU.
- Bitte schlagen Sie im Handbuch oder Datenblatt nach nach, ob Ihr Gerät eine 2,4 GHz und / oder 5 GHz Verbindung nutzt.

AVIS CONCERNANT L'UTILISATION DE LA RADIO SANS FIL LAN DANS LA COMMUNAUTÉ EUROPÉENNE (UNIQUEMENT POUR LES PRODUITS SANS FIL)

- Cet appareil est limité à un usage intérieur lorsqu'il est utilisé dans la Communauté européenne sur les canaux de la bande de 5,15 à 5,35 GHz afin de réduire les risques d'interférences.
- Cet appareil est un système de transmission à large bande (émetteur-récepteur) de 2,4 GHz, destiné à être utilisé dans tous les États-membres de l'UE et les pays de l'AELE. Cet équipement peut être utilisé dans les pays suivants : AL, AD, BE, BG, DK, DE, FI, FR, GR, GW, IS, IT, HR, LI, LU, MT, MK, MD, MC, NL, NO, AT, PL, PT, RO, SM, SE, RS, SK, ES, CI, HU, CY

Notes d'utilisation:

- Pour rester en conformité avec la réglementation nationale européenne en matière d'utilisation du spectre, des limites de fréquence et de canal seront appliquées aux produits selon le pays où l'équipement sera déployé.
- Cet appareil ne peut pas utiliser le mode Ad-hoc lorsqu'il fonctionne dans la bande de 5 GHz. Le mode Adhoc fournit une communication directe pair à pair entre deux périphériques clients sans point d'accès.
- Les points d'accès prendront en charge les fonctionnalités DFS (Dynamic Frequency Selection) et TPC (Transmit Power Control) au besoin lors du fonctionnement dans la bande de 5 GHz au sein de l'UE.
- Merci de vous référer au guide d'utilisation ou de la fiche technique afin de vérifier si votre produit utilise 2.4 GHz et/ou 5 GHz sans fil.

AVISO DE USO DE LA LAN DE RADIO INALÁMBRICA EN LA COMUNIDAD EUROPEA (SOLO PARA EL PRODUCTO INALÁMBRICO)

- El uso de este dispositivo está restringido a interiores cuando funciona en la Comunidad Europea utilizando canales en la banda de 5,15-5,35 GHz, para reducir la posibilidad de interferencias.
- Este dispositivo es un sistema de transmisión (transceptor) de banda ancha de 2,4 GHz, pensado para su uso en todos los estados miembros de la UE y en los países de la AELC. Este equipo se puede utilizar en AL, AD, BE, BG, DK, DE, FI, FR, GR, GW, IS, IT, HR, LI, LU, MT, MK, MD, MC, NL, NO, AT, PL, PT, RO, SM, SE, RS, SK, ES, CI, HU, CY

Notas de uso:

- Para seguir cumpliendo las normas europeas de uso del espectro nacional, se aplicarán limitaciones de frecuencia y canal en los productos en función del país en el que se pondrá en funcionamiento el equipo.
- Este dispositivo tiene restringido el funcionamiento en modo Ad-hoc mientras funcione a 5 GHz. El modo Ad-hoc es la comunicación directa de igual a igual entre dos dispositivos cliente sin un punto de acceso.
- Los puntos de acceso admitirán la funcionalidad DFS (Selección de frecuencia dinámica) y TPC (Control de la potencia de transmisión) si es necesario cuando funcionan a 5 GHz dentro de la UE.
- Por favor compruebe el manual o la ficha de producto para comprobar si el producto utiliza las bandas inalámbricas de 2.4 GHz y/o la de 5 GHz.

AVVISO PER L'USO DI LAN RADIO WIRELESS NELLA COMUNITÀ EUROPEA (SOLO PER PRODOTTI WIRELESS)

- Nella Comunità europea, l'uso di questo dispositivo è limitato esclusivamente agli ambienti interni sui canali compresi nella banda da 5,15 a 5,35 GHz al fine di ridurre potenziali interferenze. Questo dispositivo è un sistema di trasmissione a banda larga a 2,4 GHz (ricetrasmittente), destinato all'uso in tutti gli stati membri dell'Unione europea e nei paesi EFTA.
- Questo dispositivo può essere utilizzato in AL, AD, BE, BG, DK, DE, FI, FR, GR, GW, IS, IT, HR, LI, LU, MT, MK, MD, MC, NL, NO, AT, PL, PT, RO, SM, SE, RS, SK, ES, CI, HU, CY

Note per l'uso

- Al fine di mantenere la conformità alle normative nazionali europee per l'uso dello spettro di frequenze, saranno applicate limitazioni sulle frequenze e sui canali per il prodotto in conformità alle normative del paese in cui il dispositivo viene utilizzato.
- Questo dispositivo non può essere attivato in modalità Ad-hoc durante il funzionamento a 5 GHz. La modalità Ad-hoc è una comunicazione diretta peer-to-peer fra due dispositivi client senza un punto di accesso.
- I punti di accesso supportano le funzionalità DFS (Dynamic Frequency Selection) e TPC (Transmit Power Control) richieste per operare a 5 GHz nell'Unione europea.
- Ti invitiamo a fare riferimento al manuale del prodotto o alla scheda tecnica per verificare se il tuo prodotto utilizza le frequenze 2,4 GHz e/o 5 GHz.

KENNISGEVING VAN DRAADLOOS RADIO LAN-GEbruik IN DE EUROPESE GEMEENSCHAP (ALLEEN VOOR DRAADLOOS PRODUCT)

- Dit toestel is beperkt tot gebruik binnenshuis wanneer het wordt gebruikt in de Europese Gemeenschap gebruik makend van kanalen in de 5.15-5.35 GHz band om de kans op interferentie te beperken.
- Dit toestel is een 2.4 GHz breedband transmissiesysteem (transceiver) dat bedoeld is voor gebruik in alle EU lidstaten en EFTA landen. Deze uitrusting mag gebruikt worden in AL, AD, BE, BG, DK, DE, FI, FR, GR, GW, IS, IT, HR, LI, LU, MT, MK, MD, MC, NL, NO, AT, PL, PT, RO, SM, SE, RS, SK, ES, CI, HU, CY

Gebruiksaanwijzingen:

- Om de gebruiksvoorschriften van het Europese Nationale spectrum na te leven, zullen frequentie- en kanaalbeperkingen worden toegepast op de producten volgens het land waar de uitrusting gebruikt zal worden.
- Dit toestel kan niet functioneren in Ad-hoc mode wanneer het gebruikt wordt in 5 GHz. Ad-hoc mode is directe peer-to-peer communicatie tussen twee klantenapparaten zonder een toegangspunt.
- Toegangspunten ondersteunen DFS (Dynamic Frequency Selection) en TPC (Transmit Power Control) functionaliteit zoals vereist bij gebruik in 5 GHz binnen de EU.
- Raadpleeg de handleiding of de datasheet om te controleren of uw product gebruik maakt van 2.4 GHz en/of 5 GHz.

SAFETY INSTRUCTIONS

The following general safety guidelines are provided to help ensure your own personal safety and protect your product from potential damage. Remember to consult the product user instructions for more details.

- Static electricity can be harmful to electronic components. Discharge static electricity from your body (i.e. touching grounded bare metal) before touching the product.
- Do not attempt to service the product and never disassemble the product. For some products with a user replaceable battery, please read and follow the instructions in the user manual.
- Do not spill food or liquid on your product and never push any objects into the openings of your product.
- Do not use this product near water, areas with high humidity, or condensation unless the product is specifically rated for outdoor application.
- Keep the product away from radiators and other heat sources.
- Always unplug the product from mains power before cleaning and use a dry lint free cloth only.

SICHERHEITSVORSCHRIFTEN

Die folgenden allgemeinen Sicherheitsvorschriften dienen als Hilfe zur Gewährleistung Ihrer eigenen Sicherheit und zum Schutz Ihres Produkts. Weitere Details finden Sie in den Benutzeranleitungen zum Produkt.

- Statische Elektrizität kann elektronischen Komponenten schaden. Um Schäden durch statische Aufladung zu vermeiden, leiten Sie elektrostatische Ladungen von Ihrem Körper ab, (z. B. durch Berühren eines geerdeten blanken Metallteils), bevor Sie das Produkt berühren.
- Unterlassen Sie jeden Versuch, das Produkt zu warten, und versuchen Sie nicht, es in seine Bestandteile zu zerlegen. Für einige Produkte mit austauschbaren Akkus lesen Sie bitte das Benutzerhandbuch und befolgen Sie die dort beschriebenen Anleitungen.
- Vermeiden Sie, dass Speisen oder Flüssigkeiten auf Ihr Produkt gelangen, und stecken Sie keine Gegenstände in die Gehäuseschlitze oder -öffnungen Ihres Produkts.
- Verwenden Sie dieses Produkt nicht in unmittelbarer Nähe von Wasser und nicht in Bereichen mit hoher Luftfeuchtigkeit oder Kondensation, es sei denn, es ist speziell zur Nutzung in Außenbereichen vorgesehen und eingestuft.
- Halten Sie das Produkt von Heizkörpern und anderen Quellen fern, die Wärme erzeugen.
- Trennen Sie das Produkt immer von der Stromzufuhr, bevor Sie es reinigen und verwenden Sie dazu ausschließlich ein trockenes fusselfreies Tuch.

CONSIGNES DE SÉCURITÉ

Les consignes générales de sécurité ci-après sont fournies afin d'assurer votre sécurité personnelle et de protéger le produit d'éventuels dommages. Veuillez consulter les consignes d'utilisation du produit pour plus de détails.

- L'électricité statique peut endommager les composants électroniques. Déchargez l'électricité statique de votre corps (en touchant un objet en métal relié à la terre par exemple) avant de toucher le produit.
- N'essayez pas d'intervenir sur le produit et ne le démontez jamais. Pour certains produits contenant une batterie remplaçable par l'utilisateur, veuillez lire et suivre les consignes contenues dans le manuel d'utilisation.
- Ne renversez pas d'aliments ou de liquide sur le produit et n'insérez jamais d'objets dans les orifices.
- N'utilisez pas ce produit à proximité d'un point d'eau, de zones très humides ou de condensation sauf si le produit a été spécifiquement conçu pour une application extérieure.
- Éloignez le produit des radiateurs et autres sources de chaleur.
- Débranchez toujours le produit de l'alimentation avant de le nettoyer et utilisez uniquement un chiffon sec non pelucheux.

INSTRUCCIONES DE SEGURIDAD

Las siguientes directrices de seguridad general se facilitan para ayudarle a garantizar su propia seguridad personal y para proteger el producto frente a posibles daños. No olvide consultar las instrucciones del usuario del producto para obtener más información.

- La electricidad estática puede resultar nociva para los componentes electrónicos. Descargue la electricidad estática de su cuerpo (p. ej., tocando algún metal sin revestimiento conectado a tierra) antes de tocar el producto.
- No intente realizar el mantenimiento del producto ni lo desmonte nunca. Para algunos productos con batería reemplazable por el usuario, lea y siga las instrucciones del manual de usuario.
- No derrame comida o líquidos sobre el producto y nunca deje que caigan objetos en las aberturas del mismo.
- No utilice este producto cerca del agua, en zonas con humedad o condensación elevadas a menos que el producto esté clasificado específicamente para aplicación en exteriores.
- Mantenga el producto alejado de los radiadores y de otras fuentes de calor.
- Desenchufe siempre el producto de la alimentación de red antes de limpiarlo y utilice solo un paño seco sin pelusa

ISTRUZIONI PER LA SICUREZZA

Le seguenti linee guida sulla sicurezza sono fornite per contribuire a garantire la sicurezza personale degli utenti e a proteggere il prodotto da potenziali danni. Per maggiori dettagli, consultare le istruzioni per l'utente del prodotto.

- L'elettricità statica può essere pericolosa per i componenti elettronici. Scaricare l'elettricità statica dal corpo (ad esempio toccando una parte metallica collegata a terra) prima di toccare il prodotto.
- Non cercare di riparare il prodotto e non smontarlo mai. Per alcuni prodotti dotati di batteria sostituibile dall'utente, leggere e seguire le istruzioni riportate nel manuale dell'utente.
- Non versare cibi o liquidi sul prodotto e non spingere mai alcun oggetto nelle aperture del prodotto.
- Non usare questo prodotto vicino all'acqua, in aree con elevato grado di umidità o soggette a condensa a meno che il prodotto non sia specificatamente approvato per uso in ambienti esterni.
- Tenere il prodotto lontano da caloriferi e altre fonti di calore.
- Scollegare sempre il prodotto dalla presa elettrica prima di pulirlo e usare solo un panno asciutto che non lasci filacce.

VEILIGHEIDSINFORMATIE

De volgende algemene veiligheidsinformatie werd verstrekt om uw eigen persoonlijke veiligheid te waarborgen en uw product te beschermen tegen mogelijke schade. Denk eraan om de gebruikersinstructies van het product te raadplegen voor meer informatie.

- Statische elektriciteit kan schadelijk zijn voor elektronische componenten. Ontlaad de statische elektriciteit van uw lichaam (d.w.z. het aanraken van geaard bloot metaal) voordat u het product aanraakt.
- U mag nooit proberen het product te onderhouden en u mag het product nooit demonteren. Voor sommige producten met door de gebruiker te vervangen batterij, dient u de instructies in de gebruikershandleiding te lezen en te volgen.
- Mors geen voedsel of vloeistof op uw product en u mag nooit voorwerpen in de openingen van uw product duwen.
- Gebruik dit product niet in de buurt van water, gebieden met hoge vochtigheid of condensatie, tenzij het product specifiek geclassificeerd is voor gebruik buitenshuis.
- Houd het product uit de buurt van radiators en andere warmtebronnen.
- U dient het product steeds los te koppelen van de stroom voordat u het reinigt en gebruik uitsluitend een droge pluisvrije doek

Disposing and Recycling Your Product

ENGLISH

EN



This symbol on the product or packaging means that according to local laws and regulations this product should be not be disposed of in household waste but sent for recycling. Please take it to a collection point designated by your local authorities once it has reached the end of its life, some will accept products for free. By recycling the product and its packaging in this manner you help to conserve the environment and protect human health.

D-Link and the Environment

At D-Link, we understand and are committed to reducing any impact our operations and products may have on the environment. To minimise this impact D-Link designs and builds its products to be as environmentally friendly as possible, by using recyclable, low toxic materials in both products and packaging.

D-Link recommends that you always switch off or unplug your D-Link products when they are not in use. By doing so you will help to save energy and reduce CO2 emissions.

To learn more about our environmentally responsible products and packaging please visit www.dlinkgreen.com.

DEUTSCH

DE



Dieses Symbol auf dem Produkt oder der Verpackung weist darauf hin, dass dieses Produkt gemäß bestehender örtlicher Gesetze und Vorschriften nicht über den normalen Hausmüll entsorgt werden sollte, sondern einer Wiederverwertung zuzuführen ist. Bringen Sie es bitte zu einer von Ihrer Kommunalbehörde entsprechend amtlich ausgewiesenen Sammelstelle, sobald das Produkt das Ende seiner Nutzungsdauer erreicht hat. Für die Annahme solcher Produkte erheben einige dieser Stellen keine Gebühren. Durch ein auf diese Weise durchgeführtes Recycling des Produkts und seiner Verpackung helfen Sie, die Umwelt zu schonen und die menschliche Gesundheit zu schützen.

D-Link und die Umwelt

D-Link ist sich den möglichen Auswirkungen seiner Geschäftstätigkeiten und seiner Produkte auf die Umwelt bewusst und fühlt sich verpflichtet, diese entsprechend zu mindern. Zu diesem Zweck entwickelt und stellt D-Link seine Produkte mit dem Ziel größtmöglicher Umweltfreundlichkeit her und verwendet wiederverwertbare, schadstoffarme Materialien bei Produktherstellung und Verpackung.

D-Link empfiehlt, Ihre Produkte von D-Link, wenn nicht in Gebrauch, immer auszuschalten oder vom Netz zu nehmen. Auf diese Weise helfen Sie, Energie zu sparen und CO2-Emissionen zu reduzieren.

Wenn Sie mehr über unsere umweltgerechten Produkte und Verpackungen wissen möchten, finden Sie entsprechende Informationen im Internet unter www.dlinkgreen.com.

FRANÇAIS**FR**

Ce symbole apposé sur le produit ou son emballage signifie que, conformément aux lois et réglementations locales, ce produit ne doit pas être éliminé avec les déchets domestiques mais recyclé. Veuillez le rapporter à un point de collecte prévu à cet effet par les autorités locales; certains accepteront vos produits gratuitement. En recyclant le produit et son emballage de cette manière, vous aidez à préserver l'environnement et à protéger la santé de l'homme.

D-Link et l'environnement

Chez D-Link, nous sommes conscients de l'impact de nos opérations et produits sur l'environnement et nous engageons à le réduire. Pour limiter cet impact, D-Link conçoit et fabrique ses produits de manière aussi écologique que possible, en utilisant des matériaux recyclables et faiblement toxiques, tant dans ses produits que ses emballages.

D-Link recommande de toujours éteindre ou débrancher vos produits D-Link lorsque vous ne les utilisez pas. Vous réaliserez ainsi des économies d'énergie et réduirez vos émissions de CO2.

Pour en savoir plus sur les produits et emballages respectueux de l'environnement, veuillez consulter le www.dlinkgreen.com.

ESPAÑOL**ES**

Este símbolo en el producto o el embalaje significa que, de acuerdo con la legislación y la normativa local, este producto no se debe desechar en la basura doméstica sino que se debe reciclar. Llévelo a un punto de recogida designado por las autoridades locales una vez que ha llegado al fin de su vida útil; algunos de ellos aceptan recogerlos de forma gratuita. Al reciclar el producto y su embalaje de esta forma, contribuye a preservar el medio ambiente y a proteger la salud de los seres humanos.

D-Link y el medio ambiente

En D-Link, comprendemos y estamos comprometidos con la reducción del impacto que puedan tener nuestras actividades y nuestros productos en el medio ambiente. Para reducir este impacto, D-Link diseña y fabrica sus productos para que sean lo más ecológicos posible, utilizando materiales reciclables y de baja toxicidad tanto en los productos como en el embalaje.

D-Link recomienda apagar o desenchufar los productos D-Link cuando no se estén utilizando. Al hacerlo, contribuirá a ahorrar energía y a reducir las emisiones de CO2.

Para obtener más información acerca de nuestros productos y embalajes ecológicos, visite el sitio www.dlinkgreen.com.

ITALIANO**IT**

La presenza di questo simbolo sul prodotto o sulla confezione del prodotto indica che, in conformità alle leggi e alle normative locali, questo prodotto non deve essere smaltito nei rifiuti domestici, ma avviato al riciclo. Una volta terminato il ciclo di vita utile, portare il prodotto presso un punto di raccolta indicato dalle autorità locali. Alcuni questi punti di raccolta accettano gratuitamente i prodotti da riciclare. Scegliendo di riciclare il prodotto e il relativo imballaggio, si contribuirà a preservare l'ambiente e a salvaguardare la salute umana.

D-Link e l'ambiente

D-Link cerca da sempre di ridurre l'impatto ambientale dei propri stabilimenti e dei propri prodotti. Allo scopo di ridurre al minimo tale impatto, D-Link progetta e realizza i propri prodotti in modo che rispettino il più possibile l'ambiente, utilizzando materiali riciclabili a basso tasso di tossicità sia per i prodotti che per gli imballaggi.

D-Link raccomanda di spegnere sempre i prodotti D-Link o di scollegarne la spina quando non vengono utilizzati. In questo modo si contribuirà a risparmiare energia e a ridurre le emissioni di anidride carbonica.

Per ulteriori informazioni sui prodotti e sugli imballaggi D-Link a ridotto impatto ambientale, visitate il sito all'indirizzo www.dlinkgreen.com.

NEDERLANDS**NL**

Dit symbool op het product of de verpakking betekent dat dit product volgens de plaatselijke wetgeving niet mag worden weggegooid met het huishoudelijk afval, maar voor recyclage moeten worden ingeleverd. Zodra het product het einde van de levensduur heeft bereikt, dient u het naar een inzamelpunt te brengen dat hiertoe werd aangeduid door uw plaatselijke autoriteiten, sommige autoriteiten accepteren producten zonder dat u hiervoor dient te betalen. Door het product en de verpakking op deze manier te recyclen helpt u het milieu en de gezondheid van de mens te beschermen.

D-Link en het milieu

Bij D-Link spannen we ons in om de impact van onze handelingen en producten op het milieu te beperken. Om deze impact te beperken, ontwerpt en bouwt D-Link zijn producten zo milieuvriendelijk mogelijk, door het gebruik van recycleerbare producten met lage toxiciteit in product en verpakking.

D-Link raadt aan om steeds uw D-Link producten uit te schakelen of uit de stekker te halen wanneer u ze niet gebruikt. Door dit te doen bespaart u energie en beperkt u de CO₂-emissies.

Breng een bezoek aan www.dlinkgreen.com voor meer informatie over onze milieuverantwoorde producten en verpakkingen.

POLSKI**PL**

Ten symbol umieszczony na produkcie lub opakowaniu oznacza, że zgodnie z miejscowym prawem i lokalnymi przepisami niniejszego produktu nie wolno wyrzucać jak odpady czy śmieci z gospodarstwa domowego, lecz należy go poddać procesowi recyklingu. Po zakończeniu użytkowania produktu, niektóre odpowiednie do tego celu podmioty przyjmą takie produkty nieodpłatnie, dlatego prosimy dostarczyć go do punktu zbiórki wskazanego przez lokalne władze. Poprzez proces recyklingu i dzięki takiemu postępowaniu z produktem oraz jego opakowaniem, pomogą Państwo chronić środowisko naturalne i dbać o ludzkie zdrowie.

D-Link i środowisko

D-Link podchodzimy w sposób świadomy do ochrony otoczenia oraz jesteśmy zaangażowani w zmniejszanie wpływu naszych działań i produktów na środowisko naturalne. W celu zminimalizowania takiego wpływu firma D-Link konstruuje i wytwarza swoje produkty w taki sposób, aby były one jak najbardziej przyjazne środowisku, stosując do tych celów materiały nadające się do powtórnego wykorzystania, charakteryzujące się małą toksycznością zarówno w przypadku samych produktów jak i opakowań.

Firma D-Link zaleca, aby Państwo zawsze prawidłowo wyłączali z użytku swoje produkty D-Link, gdy nie są one wykorzystywane. Postępując w ten sposób pozwalają Państwo oszczędzać energię i zmniejszać emisje CO₂.

Aby dowiedzieć się więcej na temat produktów i opakowań mających wpływ na środowisko prosimy zapoznać się ze stroną Internetową www.dlinkgreen.com.

ČESKY**CZ**

Tento symbol na výrobku nebo jeho obalu znamená, že podle místně platných předpisů se výrobek nesmí vyhazovat do komunálního odpadu, ale odeslat k recyklaci. Až výrobek doslouží, odnese jej prosím na sběrné místo určené místními úřady k tomuto účelu. Někteřá sběrná místa přijímají výrobky zdarma. Recyklací výrobku i obalu pomáháte chránit životní prostředí i lidské zdraví.

D-Link a životní prostředí

Ve společnosti D-Link jsme si vědomi vlivu našich provozů a výrobků na životní prostředí a snažíme se o minimalizaci těchto vlivů. Proto své výrobky navrhujeme a vyrábíme tak, aby byly co nejekologičtější, a ve výrobcích i obalech používáme recyklovatelné a nízkotoxické materiály.

Společnost D-Link doporučuje, abyste své výrobky značky D-Link vypnuli nebo vytáhli ze zásuvky vždy, když je nepoužíváte. Pomůžete tak šetřit energii a snížit emise CO₂.

Více informací o našich ekologických výrobcích a obalech najdete na adrese www.dlinkgreen.com.

MAGYAR**HU**

Ez a szimbólum a terméken vagy a csomagoláson azt jelenti, hogy a helyi törvényeknek és szabályoknak megfelelően ez a termék nem semmisíthető meg a háztartási hulladékkal együtt, hanem újrahasznosításra kell küldeni. Kérjük, hogy a termék élettartamának elteltét követően vigye azt a helyi hatóság által kijelölt gyűjtőhelyre. A termékek egyes helyeken ingyen elhelyezhetők. A termék és a csomagolás újrahasznosításával segíti védeni a környezetet és az emberek egészségét.

A D-Link és a környezet

A D-Linknél megértjük és elköteleztük magunkat a műveleteink és termékeink környezetre gyakorolt hatásainak csökkentésére. Az ezen hatás csökkentése érdekében a D-Link a lehető leginkább környezetbarát termékeket tervez és gyárt azáltal, hogy újrahasznosítható, alacsony károsanyag-tartalmú termékeket gyárt és csomagolásokat alkalmaz.

A D-Link azt javasolja, hogy mindig kapcsolja ki vagy húzza ki a D-Link termékeket a tápforrásból, ha nem használja azokat. Ezzel segít az energia megtakarításában és a széndioxid kibocsátásának csökkentésében.

Környezetbarát termékeinkről és csomagolásainkról további információkat a www.dlinkgreen.com weboldalon tudhat meg.

NORSK**NO**

Dette symbolet på produktet eller forpakningen betyr at dette produktet ifølge lokale lover og forskrifter ikke skal kastes sammen med husholdningsavfall, men leveres inn til gjenvinning. Vennligst ta det til et innsamlingssted anvist av lokale myndigheter når det er kommet til slutten av levetiden. Noen steder aksepteres produkter uten avgift. Ved på denne måten å gjenvinne produktet og forpakningen hjelper du å verne miljøet og beskytte folks helse.

D-Link og miljøet

Hos D-Link forstår vi oss på og er forpliktet til å minske innvirkningen som vår drift og våre produkter kan ha på miljøet. For å minimalisere denne innvirkningen designer og lager D-Link produkter som er så miljøvennlig som mulig, ved å bruke resirkulerbare, lav-toksiske materialer både i produktene og forpakningen.

D-Link anbefaler at du alltid slår av eller frakobler D-Link-produkter når de ikke er i bruk. Ved å gjøre dette hjelper du å spare energi og å redusere CO2-utslipp.

For mer informasjon angående våre miljøansvarlige produkter og forpakninger kan du gå til www.dlinkgreen.com.

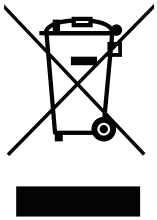
DANSK**DK**

Dette symbol på produktet eller emballagen betyder, at dette produkt i henhold til lokale love og regler ikke må bortskaffes som husholdningsaffald, mens skal sendes til genbrug. Indlever produktet til et indsamlingssted som angivet af de lokale myndigheder, når det er nået til slutningen af dets levetid. I nogle tilfælde vil produktet blive modtaget gratis. Ved at indlevere produktet og dets emballage til genbrug på denne måde bidrager du til at beskytte miljøet og den menneskelige sundhed.

D-Link og miljøet

Hos D-Link forstår vi og bestræber os på at reducere enhver indvirkning, som vores aktiviteter og produkter kan have på miljøet. For at minimere denne indvirkning designer og producerer D-Link sine produkter, så de er så miljøvenlige som muligt, ved at bruge genanvendelige materialer med lavt giftighedsniveau i både produkter og emballage.

D-Link anbefaler, at du altid slukker eller frakobler dine D-Link-produkter, når de ikke er i brug. Ved at gøre det bidrager du til at spare energi og reducere CO₂-udledningerne.

Du kan finde flere oplysninger om vores miljømæssigt ansvarlige produkter og emballage på www.dlinkgreen.com.

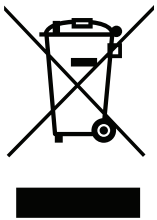
SUOMI**FI**

Tämä symboli tuotteen pakkauksessa tarkoittaa, että paikallisten lakien ja säännösten mukaisesti tätä tuotetta ei pidä hävittää yleisen kotitalousjätteen seassa vaan se tulee toimittaa kierrätettäväksi. Kun tuote on elinkaarensa päässä, toimita se lähimpään viranomaisten hyväksymään kierrätyspisteeseen. Kierrättämällä käytetyn tuotteen ja sen pakkauksen autat tukemaan sekä ympäristön että ihmisten terveyttä ja hyvinvointia.

D-Link ja ympäristö

D-Link ymmärtää ympäristönsuojelun tärkeyden ja on sitoutunut vähentämään tuotteistaan ja niiden valmistuksesta ympäristölle mahdollisesti aiheutuvia haittavaikutuksia. Nämä negatiiviset vaikutukset minimoidakseen D-Link suunnittelee ja valmistaa tuotteensa mahdollisimman ympäristöystävällisiksi käyttämällä kierrätettäviä, alhaisia pitoisuuksia haitallisia aineita sisältäviä materiaaleja sekä tuotteissaan että niiden pakkauksissa.

Suosittelomme, että irrotat D-Link-tuotteesi virtalähteestä tai sammutat ne aina, kun ne eivät ole käytössä. Toimimalla näin autat säästämään energiaa ja vähentämään hiilidioksiidipäästöjä.

Lue lisää ympäristöystävällisistä D-Link-tuotteista ja pakkauksistamme osoitteesta www.dlinkgreen.com.

SVENSKA**SE**

Den här symbolen på produkten eller förpackningen betyder att produkten enligt lokala lagar och föreskrifter inte skall kastas i hushållssoporna utan i stället återvinnas. Ta den vid slutet av dess livslängd till en av din lokala myndighet utsedd uppsamlingsplats, vissa accepterar produkter utan kostnad. Genom att på detta sätt återvinna produkten och förpackningen hjälper du till att bevara miljön och skydda människors hälsa.

D-Link och miljön

På D-Link förstår vi och är fast beslutna att minska den påverkan våra verksamheter och produkter kan ha på miljön. För att minska denna påverkan utformar och bygger D-Link sina produkter för att de ska vara så miljövänliga som möjligt, genom att använda återvinningsbara material med låg gifthalt i både produkter och förpackningar.

D-Link rekommenderar att du alltid stänger av eller kopplar ur dina D-Link produkter när du inte använder dem. Genom att göra detta hjälper du till att spara energi och minska utsläpp av koldioxid.

För mer information om våra miljöansvariga produkter och förpackningar www.dlinkgreen.com.

PORTUGUÊS**PT**

Este símbolo no produto ou embalagem significa que, de acordo com as leis e regulamentações locais, este produto não deverá ser eliminado juntamente com o lixo doméstico mas enviado para a reciclagem. Transporte-o para um ponto de recolha designado pelas suas autoridades locais quando este tiver atingido o fim da sua vida útil, alguns destes pontos aceitam produtos gratuitamente. Ao reciclar o produto e respectiva embalagem desta forma, ajuda a preservar o ambiente e protege a saúde humana.

A D-Link e o ambiente

Na D-Link compreendemos e comprometemo-nos com a redução do impacto que as nossas operações e produtos possam ter no ambiente. Para minimizar este impacto a D-Link concebe e constrói os seus produtos para que estes sejam o mais inofensivos para o ambiente possível, utilizando materiais recicláveis e não tóxicos tanto nos produtos como nas embalagens.

A D-Link recomenda que desligue os seus produtos D-Link quando estes não se encontrarem em utilização. Com esta acção ajudará a poupar energia e reduzir as emissões de CO₂.

Para saber mais sobre os nossos produtos e embalagens responsáveis a nível ambiental visite www.dlinkgreen.com.