



# Quick Start Guide

DAP-2680



**D-Link**

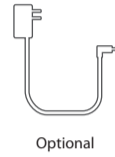
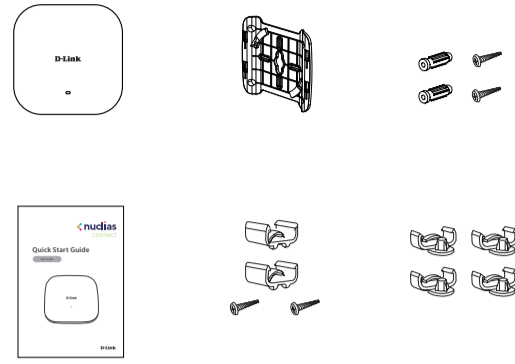

1



2



3



OR

http://dap2680.local

User Name:

Password:

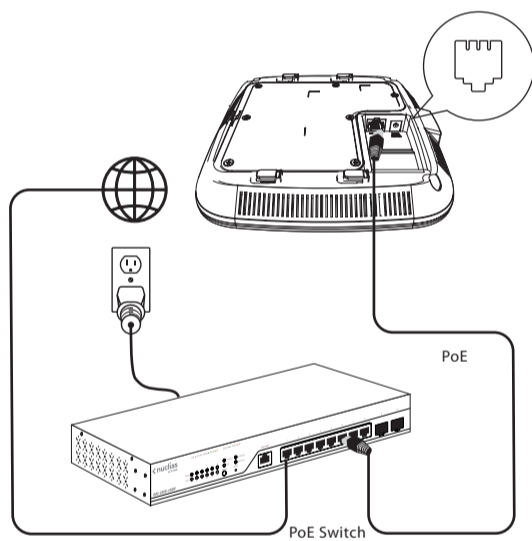

OR

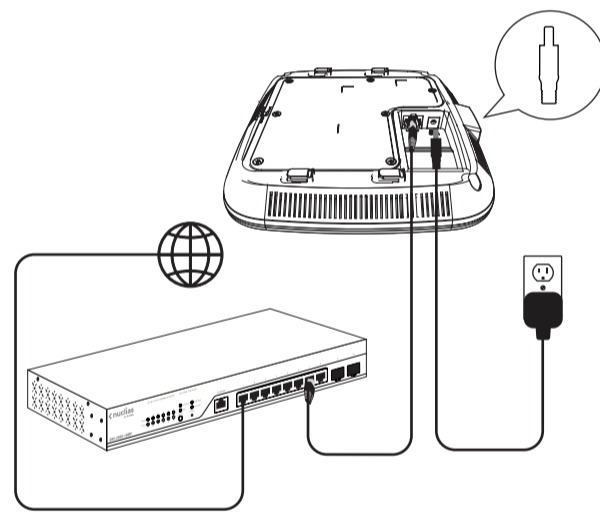

1

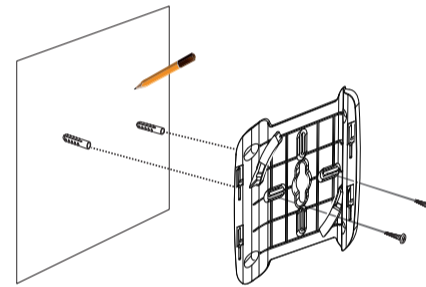

2

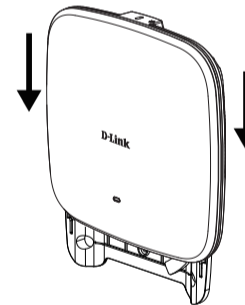

1

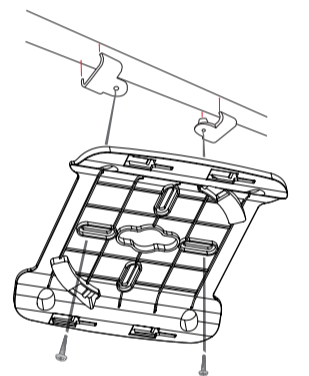

OR

2

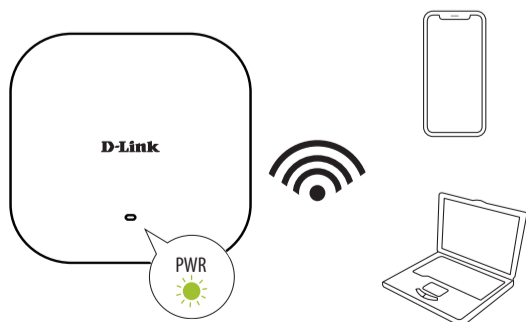
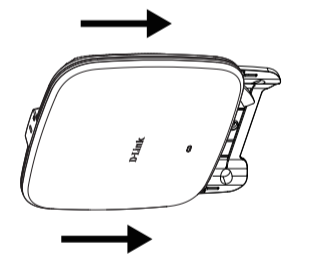

<https://www.nuclias.com>



<https://www.dlink.com/support>



<https://download.nuclias.com>



<https://www.dlink.com/warranty>