



User Manual

Cloud Camera 5000
HD Wireless N Pan/Tilt Network Camera

DCS-5222L

Manual Overview

D-Link reserves the right to revise this publication and to make changes in the content hereof without obligation to notify any person or organization of such revisions or changes. Information in this document may become obsolete as our services and websites develop and change. Please refer to the www.mydlink.com website for the most current information.

Manual Revisions

Revision	Date	Description
1.0	December 23, 2011	DCS-5222L Revision A1 with firmware version 1.00

Trademarks

D-Link and the D-Link logo are trademarks or registered trademarks of D-Link Corporation or its subsidiaries in the United States or other countries. All other company or product names mentioned herein are trademarks or registered trademarks of their respective companies.

Copyright © 2012 by D-Link Corporation.

All rights reserved. This publication may not be reproduced, in whole or in part, without prior expressed written permission from D-Link Corporation.

Safety Instructions

Use the following safety guidelines to ensure your own personal safety and to help protect your product from potential damage.

- If any of the following conditions occur, unplug the product from the electrical outlet and replace the part or contact the place of purchase:
 - The power cable, extension cable, or plug is damaged.
 - An object has fallen into the product.
 - The product has been exposed to water.
 - The product has been dropped or damaged.
 - The product does not operate correctly when you follow the operating instructions.
 - Do not spill food or liquids on product, and never operate the product in a wet environment. If the product gets wet, see the appropriate section in your troubleshooting guide.
 - Operate the product only from the type of external power source indicated on the electrical ratings label. If you are not sure of the type of power source required, consult your local power company.
 - Use only the power adapter with the product. Using another adapter, not recommended by the manufacturer, may damage the product and invalidate the warranty.
 - To help prevent an electric shock, plug the product into properly grounded electrical outlets.
 - Observe power strip ratings. Make sure that the total ampere rating of all products plugged into the power strip does not exceed 80 percent of the ampere ratings limit for the power strip.
 - To help protect your product from sudden, transient increases and decreases in electrical power, use a surge suppressor, line conditioner, or uninterruptible power supply (UPS).
 - Position product cables and power cables carefully; route cables so that they cannot be stepped on or tripped over. Be sure that nothing rests on any cables. Do not modify power cables or plugs. Consult a licensed electrician or your power company for site modifications. Always follow your local/national wiring rules.

- The product is designed for indoor use only, and must always be positioned where it is not exposed to direct sunlight or strong halogen light. Exposure to direct sunlight or halogen light may cause permanent damage to the image sensor in the product.

Warnings

- **STRANGULATION HAZARD!** – Keep cords out of the reach of children. Keep and secure all cords a minimum of 3 feet away from a crib or other child sleeping area.
- This product contains small parts that may cause choking. **Keep out of reach of children.**
- This product is not a toy. Do not allow children to play with it.
- The product is designed for **Indoor Use Only!**
- The product should not be used in a location where it could become wet!
- Ensure the product is fixed securely otherwise it may fall and cause injury!
- This product is NOT intended to replace proper supervision of children. You must check your child's activity regularly, as this product will not alert parents to activity of children.
- Do not use extension cords. Only use the power adapter provided.
- Do not use this product near a heat source.

THIS DEVICE REQUIRES THIRD-PARTY SERVICES AND PRODUCTS TO ACHIEVE FULL FUNCTIONALITY, INCLUDING BUT NOT LIMITED TO, BROADBAND INTERNET SUBSCRIPTION SERVICES AND PRODUCTS; MOBILE INTERNET SUBSCRIPTION SERVICES, COVERAGE AND PRODUCTS; CAMERA MANAGEMENT SOFTWARE, AND; A NETWORK CONNECTION. D-LINK HAS NO CONTROL OVER SUCH SERVICES AND PRODUCTS AND EXPRESSLY DISCLAIMS ANY AND ALL LIABILITY FOR THE FAILURE OF THE DEVICE OR ANY FEATURE THEREOF RESULTING FROM THE FAILURE OF ANY THIRD-PARTY SERVICE OR PRODUCT.

Table of Contents

Manual Overview.....	i	Configuration.....	14
Manual Revisions.....	i	Configuration Utility.....	14
Trademarks	i	Live Video	15
Safety Instructions	ii	Setup.....	17
Warnings.....	iii	Setup Wizard	17
Product Overview.....	1	Internet Connection Setup Wizard.....	18
Package Contents.....	1	Network.....	22
System Requirements.....	2	Wireless	24
Introduction	3	Dynamic DNS	25
Features.....	4	Image Setup	26
Hardware Overview.....	5	Audio and Video.....	27
Front.....	5	Time and Date.....	29
Back.....	6	Video Clip	30
Wireless Installation Considerations.....	7	Snapshot.....	31
Installation.....	8	SD Recording.....	32
Camera Installation Wizard	8	Digital Output.....	33
WPS - Push Button Setup.....	9	Motion Detection	34
mydlink Portal	10	Camera Control	35
Camera Status.....	11	SD Management	36
Live Video	12	Maintenance	37
Camera Info	13	Admin	37
Playback.....	13	System	39
		Firmware Upgrade.....	40

Status	41
Device Info	41
Log	42
Help	43
Configuring the DCS-5222L with a Router	44
Troubleshooting	50
Networking Basics	54
Check your IP address	54
Statically Assign an IP Address	55
Technical Specifications - Remote Control Unit	56
Technical Specifications - I/O Terminal Application	58
Technical Specifications	59
Contacting Technical Support	61
Warranty	62
Registration	68

Product Overview

Package Contents



DCS-5222L Network Camera



Antenna (optional)



Remote Control



Camera Base and Mounting Kit

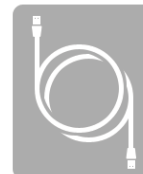

CAT5 Ethernet Cable



Power Supply



CD-ROM

Note: Using a power supply with a different voltage rating than the one included with the DCS-5222L will cause damage and void the warranty for this product. If any of the above items are missing from your package, please contact your retailer.

System Requirements

<p>Network Requirements</p>	<ul style="list-style-type: none"> • 10/100 Ethernet network or an 802.11n/g/b wireless network
<p>CD Setup Wizard Requirements</p>	<ul style="list-style-type: none"> • An Internet connection • A router connected to your broadband modem <p>Computer with the following:</p> <ul style="list-style-type: none"> • A PC with a wired connection to your router • Windows® 7 (32/64bit), XP (32/64bit), Vista® (32/64bit), Mac OS®X 10.5 or above
<p>Web-based Configuration Utility Requirements</p>	<p>Browser Requirements:</p> <ul style="list-style-type: none"> • Internet Explorer 7 or higher • Firefox 6.5 or higher • Safari 4 or higher • Chrome 8 or higher <p>Windows® Users: Make sure you have the latest version of Java installed. Visit www.java.com to download the latest version.</p>
<p>mydlink Website Requirements</p>	<ul style="list-style-type: none"> • Broadband Internet connection • Computer with: <ul style="list-style-type: none"> • Internet Explorer 7 or higher (ActiveX) • Firefox 6.5 or higher • Safari 4 or higher • Chrome 8 or higher

Introduction

Congratulations on your purchase of the DCS-5222L Cloud Camera 5000. The DCS-5222L is a versatile solution for your small office or home. The DCS-5222L is a complete system with a built-in CPU and web server that transmits high quality video images for security and surveillance. It can be accessed remotely, and controlled from any PC/Notebook over your local network or across the Internet via a web browser. The DCS-5222L features 802.11n wireless connectivity, allowing the camera to be placed anywhere within range of your wireless network. The DCS-5222L comes with remote monitoring and motion detection features for a complete and cost-effective home security solution.

Features

Simple to Use

The DCS-5222L is a stand-alone system with a built-in CPU, requiring no special hardware or software such as PC frame grabber cards. The DCS-5222L supports both ActiveX mode for Internet Explorer and Java mode for other browsers such as Firefox, Chrome, and Safari.

Supports a Variety of Platforms

The DCS-5222L supports TCP/IP networking, HTTP, and other Internet related protocols. It can also be integrated easily into other Internet/Intranet applications because of its standards-based features.

Web Configuration

Using a standard Web browser, administrators can configure and manage the Network Camera directly from its own Web page via Intranet or Internet.

Broad Range of Applications

With today's high-speed Internet services, the DCS-5222L Network Camera can provide an ideal solution for live video over the Internet and for remote monitoring. The DCS-5222L allow remote access from a Web browser for live image viewing and management of the network cameras anytime, from anywhere in the world. The network cameras have a wide range of applications, including industrial and public monitoring of homes, offices, banks, hospitals, child-care centers, and amusement parks.

802.11n Wireless or Ethernet/Fast Ethernet Support

The DCS-5222L offers wireless 802.11n and Ethernet/Fast Ethernet connectivity, making the DCS-5222L easy to integrate into your existing network environment. The DCS-5222L works with a 10Mbps Ethernet based network or 100Mbps Fast Ethernet based network for traditional wired environments, and works with 802.11n routers or access points for added flexibility. The Site Survey feature also allows you to view and connect to any available wireless networks.

Remote Monitoring Utility

The D-ViewCam application adds enhanced features and functionality for the Network Camera and allows administrators to configure and access the Network Camera from a remote site via Intranet or Internet. Other features include image monitoring, recording images to a hard drive, viewing up to 32 cameras on one screen, and taking snapshots. Note that D-ViewCam works on Windows® computers only.

IR LED for day and night functionality

The built-in infrared LEDs enables night time viewing of up to 16 feet (5 meters).

Hardware Overview

Front



Hardware Overview

Back



Audio Out

Connect headphones/speakers to provide audio out.

I/O Connector

The 4-pin I/O connector provides an interface for photo-coupled switch output and photo-coupled input. An example of what can be done with a digital input and digital output is the connecting of a motion sensor to the port, signalling the camera to take a snapshot and trigger an alarm connected to the port.

Ethernet Port

Connects to a PC or network through an Ethernet connection.

Power Receptor

Connects to the power adapter.

WPS Button

Micro SD Slot

Used for storing recorded images and video

Reset Button

Press and hold to reset to the default factory settings.

Wireless Installation Considerations

The D-Link Wireless Network Camera lets you access your network using a wireless connection from anywhere within the operating range of your wireless network. However, the number, thickness and location of walls, ceilings, or other objects that the wireless signals must pass through, may limit the range. Typical ranges vary depending on the types of materials and background RF (radio frequency) noise in your home or business. The key to maximizing wireless range is to follow these basic guidelines:

1. Minimize the number of walls and ceilings between your adapter and other network devices (such as your Network Camera) - each wall or ceiling can reduce your adapter's range from 3-90 feet (1-30 meters).
2. Be aware of the direct line between network devices. A wall that is 1.5 feet thick (.5 meters), at a 45-degree angle appears to be almost 3 feet (1 meter) thick. At a 2-degree angle, it looks over 42 feet (14 meters) thick. Position your devices so that the signal will travel straight through a wall or ceiling (instead of at an angle) for better reception.
3. Building Materials make a difference. A solid metal door or aluminum studs may weaken the wireless signal. Try to position your access points, wireless routers, and other networking devices where the signal passes through drywall or open doorways. Materials and objects such as glass, steel, metal, walls with insulation, water (fish tanks), mirrors, file cabinets, brick, and concrete will degrade your wireless signal.
4. Keep your product at least 3-6 feet or 1-2 meters away from electrical devices or appliances that generate RF noise.
5. If you are using 2.4GHz cordless phones or other radio frequency sources (such as microwave ovens), your wireless connection may degrade dramatically or drop completely. Make sure your 2.4GHz phone base is as far away from your wireless devices as possible. The base transmits a signal even if the phone is not in use.

Installation

Camera Installation Wizard

Insert the Installation CD-ROM into your computer's CD drive to start the autorun program. Do not mount your camera until you have configured it.

The CD-ROM will open the Camera Installation Wizard. Simply click **Start** to go through the Installation Wizard, which will guide you through the installation process from connecting your hardware, configuring your camera, and registering with mydlink.com.

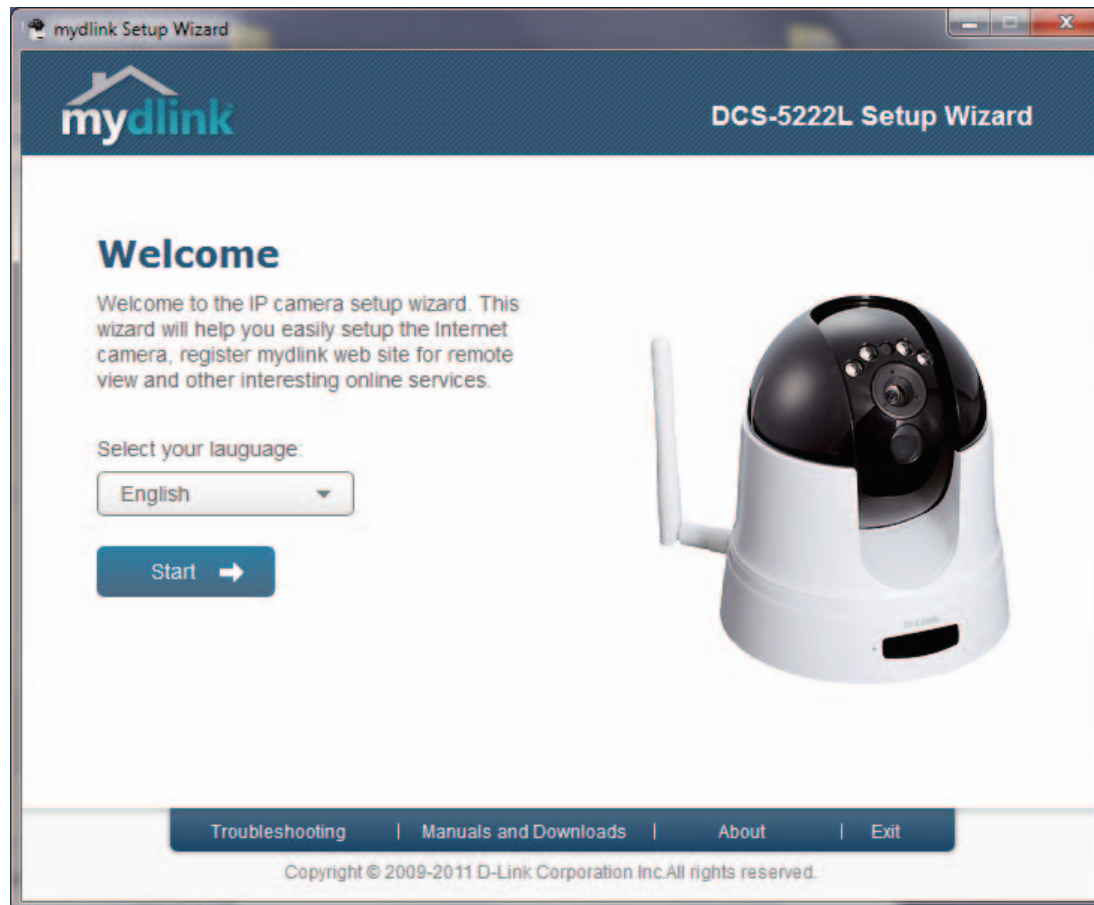

WPS - Push Button Setup

Alternatively, you may create a connection to the camera using Wi-Fi Protected Setup (WPS).

To create a WPS connection:

Step 1

Press and hold the WPS button for three seconds. The blue WPS status LED above the button will blink.

Step 2

Press the WPS button on your router or access point within 120 seconds. The WPS button is usually on the front or side of your router. On some routers and access points, you may need to log in to the web interface and click on an on-screen button to activate the WPS feature. If you are not sure where the WPS button is on your router/AP, please refer to your router or AP's User Manual.

The DCS-5222L will automatically create a wireless connection to your router or access point. While connecting, the green LED will flash and your camera will reboot.

Note: Your camera contains an internal antenna and it is not necessary to attach the external antenna unless you would like to boost your signal or install an outdoor enclosure. You must select which antenna you want to use in the **Setup > Wireless** section from the camera's web configuration utility (internal is set by default).



mydlink Portal

After registering your DCS-5222L camera with a **mydlink** account in the Camera Setup Wizard. You will be able to remotely access your camera from the www.mydlink.com website. After signing in to your **mydlink** account, you will see a screen similar to the following:

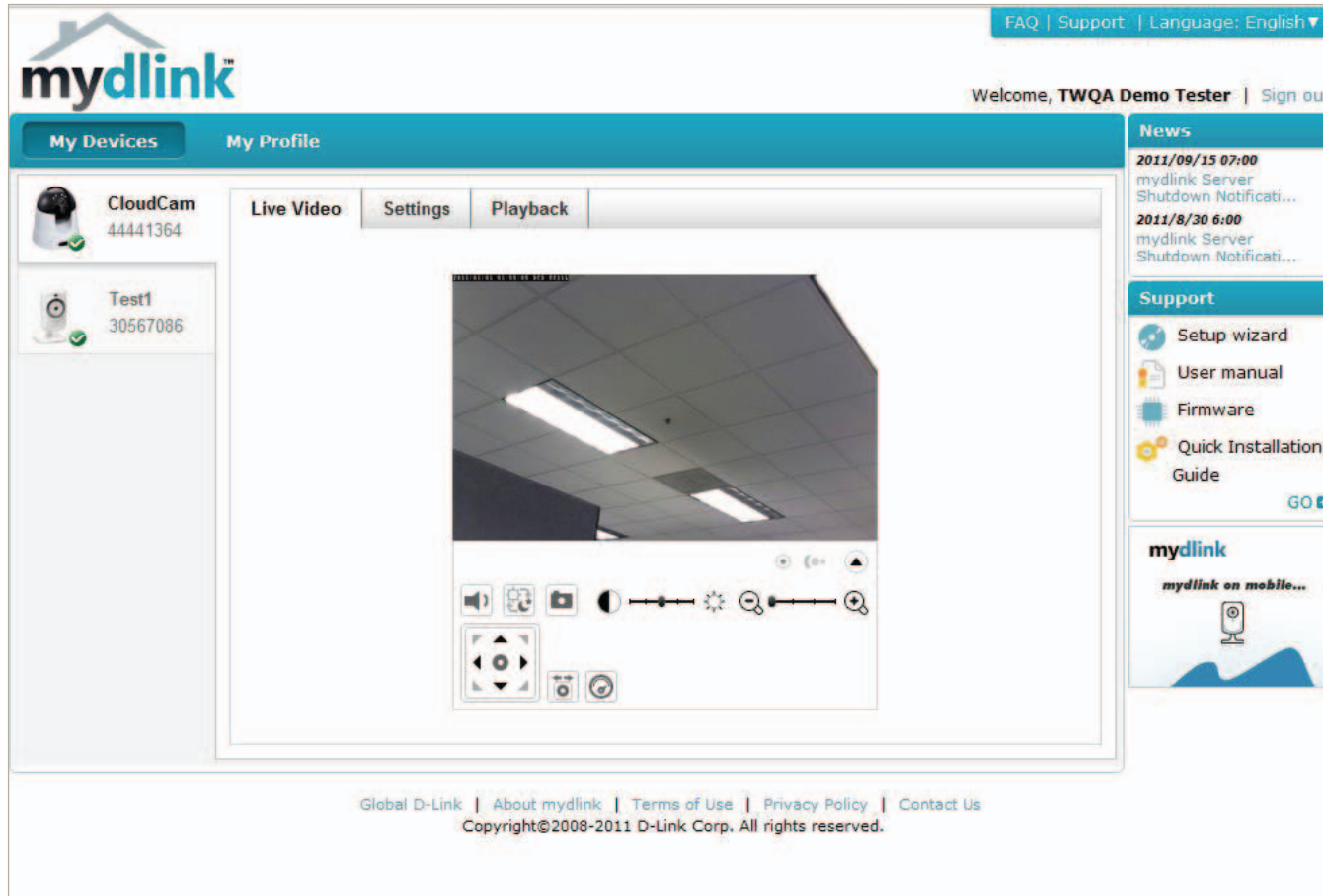

Camera Status

The online status of each camera will be displayed. Your online status may be one of the following:



A green check mark indicates that your camera is online and ready to use.



A yellow exclamation point indicates that your camera is online, but the camera password has changed. You will need to enter your new camera password to access your camera again.



A red x indicates that your camera is offline and currently cannot be accessed remotely.

If your camera is offline, try the following:

- Check to make sure that the Internet connection to your camera is working properly.
- Try restarting your broadband router.
- Check your camera's cable connections and make sure they are secure.
- Check to make sure that the power LED on your camera is lit solid red.

If you still cannot access your camera, reset your camera and run the Camera Setup Wizard again from the CD-ROM included in your package.

Live Video

If the camera is available, a Live Video feed will be displayed. Video will be shown at full resolution if viewing your camera from a PC on the same local network, or viewing your camera from a PC on a remote network.

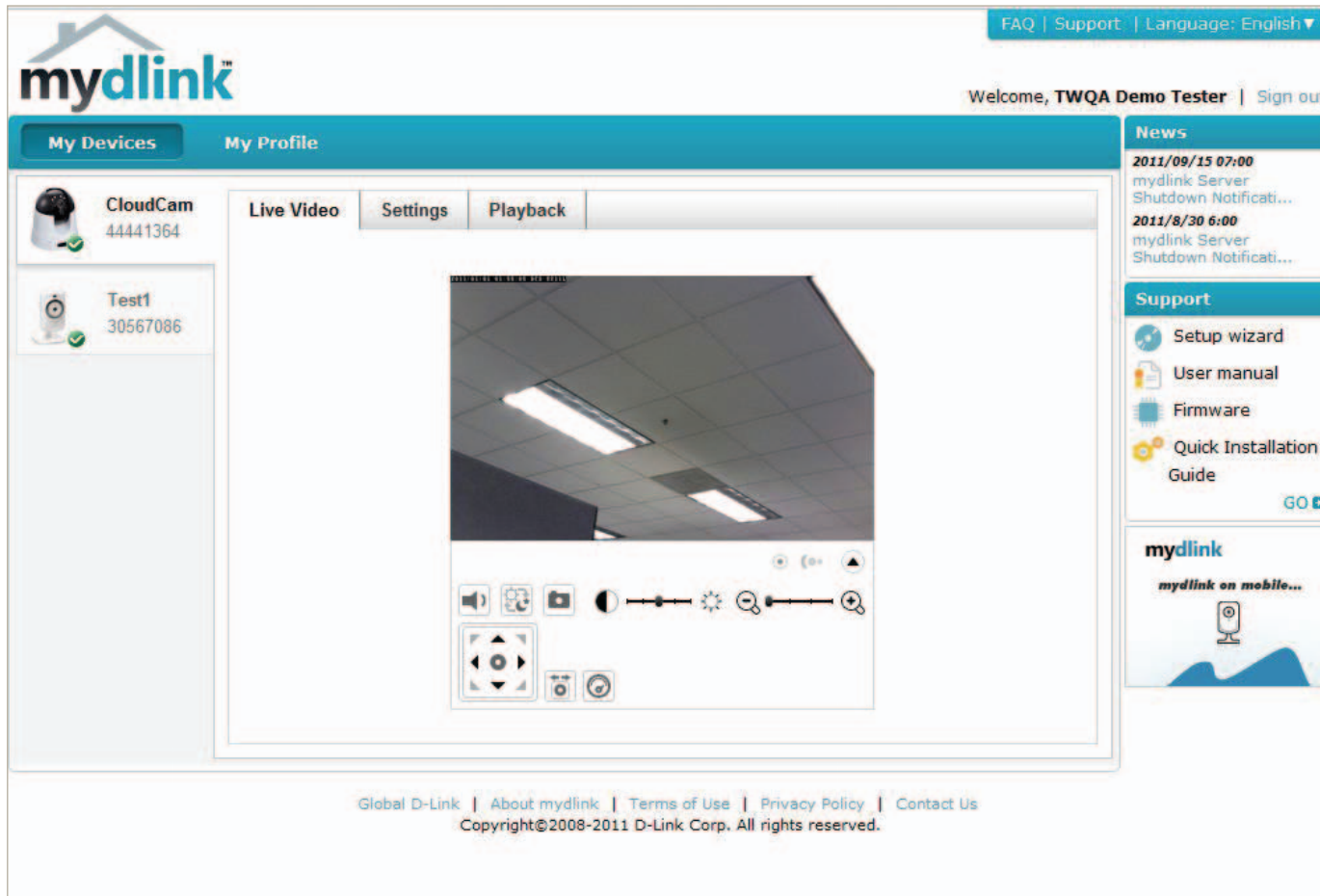

Camera Info

The Camera Info tab displays various details about your camera.

Device Name: The Device Name is a unique name that you can give to your device to help you identify it. Clicking on the Device Name will open a window for you to log in to your camera's configuration interface. Then, it will open the Maintenance > Admin page where you can change your Device Name.

mydlink No.: Displays the mydlink number of your device.

Model Name: Displays the model name of your device.

MAC: Displays the MAC address of your device.

Camera activated on: Displays the time and date that your device was added to mydlink.

Advanced Setting: Click to configure advanced features for your camera. You will need to enter the username and password of your camera (not mydlink).

Delete Camera: Click to remove the camera from mydlink. To add the camera back, you will need to run the setup wizard from the CD.

Playback

Search for clips to view: Search for a recording time after download or playback.



Configuration

Configuration Utility

After completing the Camera Installation Wizard, you are ready to use your camera. The camera's built-in Web configuration utility is designed to allow you to easily access and configure your DCS-5222L. At the end of the wizard, click **Go To Camera**, or enter the IP address of your camera into a web browser. To log in, enter your user name (**admin**) and the password you created in the Installation Wizard. If you did not create a password, the default password is blank. After entering your password, click **OK**.

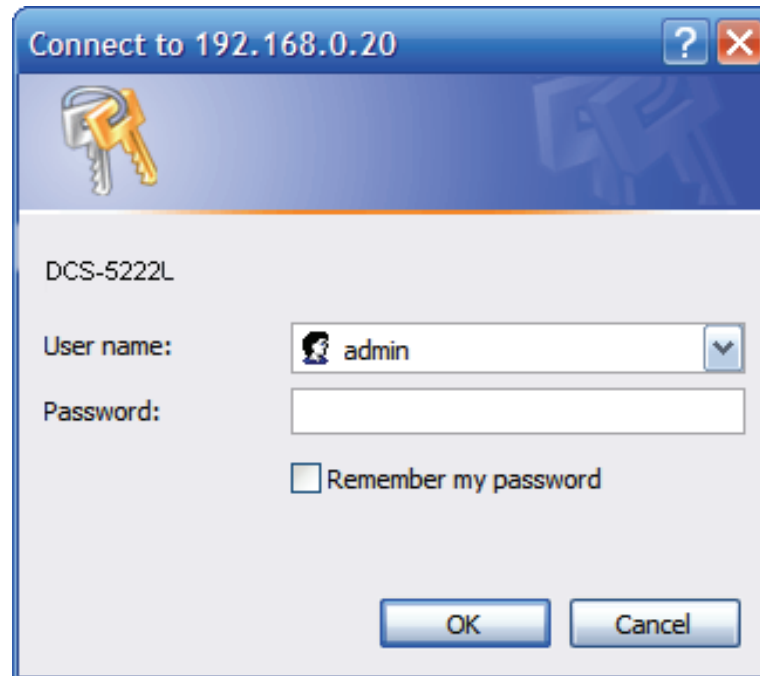

Live Video

Please make sure that you have the latest version of Java application installed on your computer to ensure proper operation when viewing the video in Java mode. The Java application can be downloaded free from Sun's web site (<http://www.java.com>).

A live feed from the camera is displayed upon logging into the camera's web interface.

P/T/Z Action Pad: Use the **Pan / Tilt / Zoom** Action Pad to control the camera's movement and zoom. The large tree icon controls the zoom-in function. The small tree icon on the right side controls the zoom-out function. The **Home** button will move the camera to the "Home" preset position.

Go To: Select from the preset drop-down list to quickly move the camera to the desired preset position. Please refer to "camera control" setup to create preset positions.

Pan/Tilt Speed: This setting can change the camera's Pan/Tilt speed.









Pan: Press this button and the camera will pan from left-most position to the right-most position and then return to its original position.

Stop: This will stop pan and patrol.

Patrol: Click this button to quickly move the camera to the desired patrol setup according to preset positions. Please refer to "camera control" setup to create preset positions.

The next page contains several icons which can be used to control the camera's main functions.



Icon	Button Name	Function
	Profile buttons	Use these buttons to switch between video profiles. Refer to page 27 for more information on setting up profiles.
	Full Screen button	Displays the video at full screen.
	Snapshot button	Takes a snapshot of the image currently displayed on the screen and will save it to a file on the hard drive in a folder specified using the Storage folder button.
	Video recording button	Triggers the camera's recording function. This will record the video displayed on the screen and will save it to a file on the hard drive in a folder specified using the Storage folder button.
	Storage folder button	Sets the location to save snapshots and video recordings.
	Listen button	Sends the audio received from the camera's microphone through to the PC's speakers. Click again to turn off.
	Talk button	Sends audio from a microphone connected to your PC through to the speakers connected to the camera.
Zoom in/out: 	Zoom buttons	Zooms in or out.

Setup

Setup Wizard

You may choose to configure your network by using the **Internet Connection Setup Wizard** that includes step-by-step instructions to connect your camera to the Internet. Alternatively, you can manually configure your connection by clicking **Manual Internet Connection Setup** and skip to page 22.

D-Link

DCS-5222L // LIVE VIDEO SETUP MAINTENANCE STATUS HELP

Setup Wizard

Network
Wireless Setup
Dynamic DNS
Image Setup
Audio and Video
Time and Date
Video Clip
Snapshot
SD Recording
Digital Output
Motion Detection
Camera Control
SD Management
Logout

INTERNET CONNECTION SETTINGS

In this section, you can setup the IP camera's network interface settings. If you are configuring this device for the first time, D-Link recommends that you select the Internet Connection Setup Wizard, and follow the instructions on screen. If you wish to modify or configure the IP camera settings manually, you may select the Manual Internet Connection Setup to input the network setting.

Internet Connection Setup Wizard Manual Internet Connection Setup

IP CAMERA MOTION DETECTION SETTINGS

In this section, you can setup the IP camera's Motion Detection settings. If you are configuring this device for the first time, D-Link recommends that you select the Motion Detection Setup Wizard, and follow the instructions on screen. If you wish to modify or configure the Motion Detection manually, select the Manual Motion Detection Setup.

Motion Detection Setup Wizard Manual Motion Detection Setup

Helpful Hints..

If you are an advanced user and have configured an Internet camera before, click 'Manual Internet Connection Setup' to input all settings manually.

If you consider yourself an advanced user and you want to manually set up motion detection settings, click 'Manual Motion Detection Setup' to input all the settings manually.

SURVEILLANCE

Internet Connection Setup Wizard

This wizard will guide you through a step-by-step process to configure your new D-Link Camera and connect the camera to the Internet. **Note that this wizard will not register your camera with mydlink.com.**

Click **Next** to continue.

Select **Automatic IP Address** if you want your DHCP server (usually enabled on your router) to assign the camera its IP settings. If you want to manually assign the IP settings, select **Static IP Address** and enter the following details:

IP Address: Enter an IP address for your camera.

Subnet Mask: Enter the subnet mask of your network.

Default Gateway: Enter the default gateway address. This is usually the IP address of your router.

Primary DNS: Enter the primary DNS server's IP address. This is usually the IP address of your router.

Secondary DNS: Enter the secondary DNS server's IP address. This is optional.

Click **Next** to continue.

WELCOME TO D-LINK SETUP WIZARD - INTERNET CONNECTION SETUP

This wizard will guide you through a step-by-step process to configure and connect your D-Link Camera to the Internet. For your camera motion detection settings, please click Back button to close this wizard and select the Motion Detection Setup Wizard.

- Step 1: LAN Settings
- Step 2: Internet Settings
- Step 3: DDNS Settings
- Step 4: Camera Name Settings
- Step 5: Time Zone
- Step 6: Setup Complete

Back Next Cancel

STEP 1: LAN SETTINGS

Please select whether your camera will connect to the Internet with an Automatic or a Static IP Address. If your camera is connected to a router, or you are unsure which settings to pick, D-Link recommends that you keep the default selection of Automatic IP Address. Otherwise, select Static IP Address to manually assign an IP address before clicking on the Next button.

- Automatic IP Address
 Static IP Address

IPv4 Address

Subnet Mask

Default Gateway (Router)

Optional Primary DNS

Optional Secondary DNS

Back Next Cancel

Section 4 - Configuration

If you are required to connect using PPPoE, select **Enabled** and enter the Username and Password for your PPPoE connection. Only select this option if your camera is directly connected to your broadband modem. If it is on a network with a router or gateway, do not select.

Click **Next** to continue.

STEP 2: INTERNET SETTINGS

If your ISP is using PPPoE, please enable this setting and enter your ISP Username and Password. Then, click on the Next button. Please contact your ISP if you do not know your Username and Password.

Enable

A Dynamic DNS account allows you to access your camera over the Internet when you have an IP address that changes each time you connect to the Internet. If you have a Dynamic DNS account, click **Enable** and enter the following details:

Enable: Click to enable the DDNS function.

DDNS: (Dynamic Domain Name Server) will hold a DNS host name and synchronize the public IP address of the modem when it has been modified. The username and password are required when using the DDNS service.

Server Address: Select your Dynamic DNS Server from the drop down menu.

Host Name: Enter the host name of the DDNS server.

User Name: Enter your username or email address used to connect to the DDNS.

Password: Enter your password used to connect to the DDNS server.

Timeout: You can setup how often the camera notifies the DDNS server of its current global IP address by entering a whole number in hours.

STEP 3: DDNS SETTINGS

If you have a Dynamic DNS account and would like the camera to update the IP address automatically, please enable DDNS and enter your host information below. Then, click on the Next button to continue.

Sign up for D-Link's Free DDNS service at <http://www.DlinkDDNS.com>

Enable

Server Address <<

Host Name

User Name

Password

Verify Password

Timeout Hour

Section 4 - Configuration

Create a unique name for your camera. Click **Next** to continue.

STEP 4: CAMERA NAME SETTINGS

D-Link recommends that you rename your camera for easy accessibility. You can then identify and connect to your camera via this name. Please assign a name of your choice before clicking on the Next button.

Camera Name

Select the time zone that the camera is in so that scheduled events occur at the correct time. If your time zone observes daylight saving, check the **Enable Daylight Saving** box and select **Auto Daylight Saving** to have DST set automatically or select **Set date and time manually** to enable drop-down menus so that you can set the start and end time of daylight saving yourself.

Click **Next** to continue.

STEP 5: TIME ZONE

Please configure the correct time to ensure that all events are triggered, captured and scheduled at the right time. Then, click on the Next button.

Time Zone

Enable Daylight Saving

Auto Daylight Saving

Set DST Manually

Section 4 - Configuration

A summary of the options you selected is displayed for confirmation. If you are happy with the selected configuration, click **Apply** otherwise click **Back** to make the required changes.

STEP 6: SETUP COMPLETE

Below is a summary of your camera settings. Click on the Back button to review or modify settings or click on the Apply button if all settings are correct. It is recommended to note down these settings in order to access your camera on the network or via your web browser.

IPv4 Address	192.168.0.20
IP Camera Name	DCS-5222L
Time Zone	(GMT-12:00) International Date Line West
DDNS	Enable
PPPoE	Enable

Network

This section allows you to configure your LAN and Internet configuration.

Automatic IP Address Select: This option is used if you would like an IP address assigned to your camera automatically by the DHCP server (router). If the DHCP server does not exist you will need to manually configure this setting should no DHCP server exist.

Static IP Address: This option is used to manually configure your Camera's IP settings.

HTTP Port: This option allocates the HTTP port of the camera.

RTSP Port: This option allocates the RTSP port of the camera, the RTSP port allows connections using QuickTime or other supported media players.

UPnP Enable: UPnP™ (Universal Plug & Play) can be used to allow discovery of a camera as a UPnP device in your network.

UPnP Port Forward: If your router supports UPnP, your camera and router can communicate allowing the router to discover which ports are used by each camera automatically without the need to open ports or port forward.

Bonjour: Enabling Bonjour will allow discovery of cameras by Mac computers.

D-Link

DCS-5222L // LIVE VIDEO SETUP MAINTENANCE STATUS HELP

Setup Wizard
Network
Wireless Setup
Dynamic DNS
Image Setup
Audio and Video
Time and Date
Video Clip
Snapshot
SD Recording
Digital Output
Motion Detection
Camera Control
SD Management
Logout

NETWORK
You can configure your LAN and Internet settings here.
Save Settings Don't Save Settings

LAN SETTINGS

LAN SETTINGS
 Automatic IP Address
 Static IP Address
 PPPoE

PORT SETTINGS
 HTTP Port
 RTSP Port

UPnP
 UPnP
 UPnP Port Forward

Apple
 Bonjour

Save Settings Don't Save Settings

Helpful Hints..
Automatic IP Address
 Select if you are running a DHCP server on your network and would like an IP address assigned to your camera automatically.
Static IP Address
 This option is used to configure your IP Camera with IP address matched your network settings.
HTTP Port
 Allocate the port of camera to allow you to connect via a standard web browser.
RTSP Port
 Allocate the port of camera to allow you to connect by using QuickTime or streaming mobile devices.
UPnP
 Enable UPnP will allow you to discover camera as an UPnP device in

Note: You *MUST* also set up your router/gateway for Port Forwarding/Mapping; this will enable remote viewing of your camera via the Internet. Please refer to your router's instruction manual on how to open up ports (port forward). For additional help on configuring your camera to work with your router, please refer to **Appendix A: Installing the DCS-5222L on a Router Without UPnP**. For installing multiple cameras, ONE port per camera must be opened on your router, the Web server (HTTP) port. Also, some browsers may restrict some ports, such as 1 or 22, for security purposes. If you have problems accessing your camera through HTTP, try using a port higher than 1024.

After making any changes, click the **Save Settings** button to save your changes, or click the **Don't Save Settings** button to discard your changes.

Wireless

To set up your Network camera's wireless network interface settings, enable **Wireless Settings** in this window first. Then continue the further configuration next.

Site Survey: Click the **Rescan** button to scan for available wireless networks. After scanning, select a wireless network from the drop-down box that you want to connect to.

SSID: The name of the wireless network.

Wireless Mode: Use the drop-down box to select the mode of the wireless network you wish to connect to. **Infrastructure** is normally used to connect to an access point or router. **Ad-Hoc** is usually used to connect directly to another computer.

Channel: If you are using Ad Hoc mode, select the channel of the wireless network you wish to connect to, or select **Auto**.

Security Mode: Select the type of authentication you are using on your wireless network (**Open**, **Shared (WEP)**, **WPA-PSK**, or **WPA-PSK2**).

Cypher Type: If you are using **WPA-PSK** or **WPA-PSK2** authentication, you will need to specify whether your wireless network uses TKIP or AES encryption. If you use **Open** or **Shared** authentication, this setting will be automatically set for you.

Key: Enter the key or passphrase to access a secure network.

Show Hidden Key: Check this box to display the key.

Antenna: Select to use the internal or external wireless antenna.

After making any changes, click the **Save Settings** button to save your changes, or click the **Don't Save Settings** button to discard your changes.

Dynamic DNS

This section allows you to configure the DDNS setting for your camera. DDNS will allow all users to access your camera using a domain name instead of an IP address.

DDNS: Click to enable the DDNS function.

Server Address: Select your Dynamic DNS Server from the drop-down menu.

Host Name: Enter the host name of the DDNS server.

User Name: Enter your username or e-mail address used to connect to the DDNS.

Password: Enter your password used to connect to the DDNS server.

Confirm Password: Enter your password again for verification.

Timeout: You can setup how often the camera notifies the DDNS server of its current global IP address by entering a whole number in hours.

Status: Displays the connection status of your DDNS account.

The screenshot shows the D-Link camera's web interface. At the top, there's a navigation bar with 'D-Link' logo and tabs for 'LIVE VIDEO', 'SETUP', 'MAINTENANCE', 'STATUS', and 'HELP'. The 'SETUP' tab is active, and a sidebar on the left lists various setup options like 'Setup Wizard', 'Network', 'Wireless Setup', 'Dynamic DNS', etc. The main content area is titled 'DYNAMIC DNS' and contains an introductory paragraph explaining the feature, followed by 'Save Settings' and 'Don't Save Settings' buttons. Below this is the 'DYNAMIC DNS SETTING' section, which has a checked 'DDNS' checkbox and several input fields: 'Server Address' (with a dropdown menu), 'Host Name', 'User Name', 'Password', 'Confirm Password', 'Timeout' (set to 576 hours), and 'Status' (set to Disabled). Another 'Save Settings' and 'Don't Save Settings' button pair is at the bottom of this section. On the right side, there's a 'Helpful Hints..' sidebar with additional information and a 'Status' section indicating the DDNS function's availability.

Image Setup

This section allows you to adjust the image and sensor settings for your camera.

Brightness: This adjusts the brightness of the camera image.

Saturation: This adjusts the color saturation. Saturation controls the strength of color in the image.

Contrast: This adjusts the contrast of the camera image, making a dull image sharper or a bright image smoother.

Hue: The Hue controls the different degree of color stimulation in the camera image.

Frequency: This option adjusts the camera sensor's setting to avoid the image flickering under certain light sources, such as florescent lights. This is set to **Auto** by default.

White Balance: You can change the white balance of the camera image by selecting a setting from the drop-down box. This is set to **auto** by default.

B/W: Click this checkbox to change the camera image into black and white.

Flip: This will flip the image vertically.

Mirror: This will flip the image horizontally.

Slow Shutter: This can be used to allow manual control of the shutter speed. Select slower shutter speeds when environment is dimly lit, faster speeds are required when in brighter lighting.

Note: *Mirror and Flip* can be used if you have mounted the DCS-5222L on the ceiling.

The screenshot shows the D-Link web interface for the DCS-5222L camera. The main content area is titled "IMAGE SETUP" and contains a live video feed showing a dark, blurry image of a person's shoulder. Below the video feed is the "IMAGE SETTINGS" section, which includes the following controls:

Brightness	50	Saturation	50
Contrast	50	Hue	50
B/W	<input type="checkbox"/>	Mirror	<input type="checkbox"/>
Flip	<input type="checkbox"/>	Auto Exposure	<input checked="" type="checkbox"/>
Frequency	Auto	White Balance	Auto
Slow Shutter	Disable		

There is a "Reset to Default" button at the bottom of the settings section. The sidebar on the right contains "Helpful Hints..." with explanations for Brightness, Saturation, Contrast, Hue, and B/W.

Audio and Video

You may configure four video profiles with different settings for your camera. You may also set up different profiles for your computer and mobile display. In addition, you may configure the audio (speakers and microphone) settings for your camera. There are three sensor output selections (VGA, XGA, and SXGA). Do not select SXGA if you want to turn on the motion detection feature.

Video Profile: This section allows you to change the **Encode Type, Resolution, FPS, and Quality.**

Encode Type: The compression format used when viewing your camera.

Resolution: Select the desired video resolution from the drop-down menu. The higher setting can obtain better quality. However, it will use more resource within your network.

FPS: Select the optimal setting depending on your network status. Please note that the higher setting can obtain better quality. However, it will use more resources within your network.

bps: Select the bitrate to assign the video. This is a constant bitrate. A higher bitrate will result in better looking video at the expense of a larger file size.

Quality: Select one of five levels of image quality: Highest, High, Medium, Low, and Lowest.

RTSP URL: The URL used to connect to the camera when viewing from QuickTime or a mobile device.

Day/Night Mode: Allows you to control the IR LEDs on the front of the camera. Note that when this option is enabled, live feed video will be in black and white, and ICR filter will be activated.

Audio Setup: Allows you to enable or disable and adjust the volume level of the speaker and microphone. If you select speaker, you must attach external speakers to the audio port on the camera.

Note: Video Profile 3 is always set to MJPEG as the Encode Type to ensure that at least one of the Video Profiles are viewable by non-IE browsers. Video Profile 4 is for mobile devices only, and always uses MPEG-4 as the Encode Type.

The screenshot shows the D-Link web interface for the DCS-5222L camera. The main navigation bar includes 'LIVE VIDEO', 'SETUP', 'MAINTENANCE', 'STATUS', and 'HELP'. The 'SETUP' menu is expanded to show 'AUDIO AND VIDEO'. The page content includes a 'Save Settings' and 'Don't Save Settings' button at the top. Below this, there are four video profiles, each with a table of settings:

Encode Type	Resolution	FPS	Encode Method	bps	Quality	RTSP URL
H.264	1280x800	30				play1.sdp
H.264		30				play2.sdp
JPEG		30				play3.sdp
H.264		30				3gpp

Below the video profiles is the 'DAY/NIGHT MODE' section with a 'Day/Night Mode' dropdown set to 'Auto'. The 'AUDIO SETUP' section has checkboxes for 'Speaker' and 'Microphone'. At the bottom, there are 'Save Settings' and 'Don't Save Settings' buttons.

Note: Higher frame size, frame rate and bit rates will give you better video quality, but they will also require more network bandwidth. For best viewing results on a mobile phone, we suggest setting the frame rate to 5 fps and the bit rate to 20 Kbps.

After making any changes, click the **Save Settings** button to save your changes, or click the **Don't Save Settings** button to discard your changes.

Time and Date

This section allows you to configure the settings of the internal system clocks for your camera.

Time Zone: Select the time zone for your region from the drop-down menu.

Enable Daylight Saving: Check this if the camera is in a region where daylight saving is observed.

Auto Daylight Saving: This option will adjust Daylight Saving Time automatically.

Synchronize NTP Server: Network Time Protocol will synchronize your camera with an Internet time server. You can enter an IP address of a server or select from the drop-down menu.

Set the Date and Time Manually: Select this to set the time manually.

Copy your Computer's Time Settings: Click to synchronize the time information from your PC.

The screenshot shows the D-Link web interface for the DCS-5222L camera. The top navigation bar includes 'LIVE VIDEO', 'SETUP', 'MAINTENANCE', 'STATUS', and 'HELP'. The left sidebar lists various setup options, with 'Time and Date' selected. The main content area is titled 'TIME AND DATE' and contains the following configuration options:

- TIME AND DATE:** Here you may configure the internal clock of your camera. Includes 'Save Settings' and 'Don't Save Settings' buttons.
- TIME CONFIGURATION:**
 - Time Zone: (GMT-08:00) Pacific Time (US & Canada)
 - Enable Daylight Saving
 - Auto Daylight Saving
 - Set DST Manually
 - AUTOMATIC TIME CONFIGURATION:**
 - Synchronize with NTP Server
 - SET DATE AND TIME MANUALLY:**
 - Setup Date and Time Manually

At the bottom of the configuration section are 'Save Settings' and 'Don't Save Settings' buttons. The 'SURVEILLANCE' logo is visible at the bottom of the page.

After making any changes, click the **Save Settings** button to save your changes, or click the **Don't Save Settings** button to discard your changes.

Video Clip

Video Clip is a feature to send video clips via FTP or E-MAIL when a trigger is activated.

Video Clip: Check this box to enable the Video Clip function.

Trigger By: Select whether the event is triggered by **Motion**, **Schedule** or if the video is **Always** recording.

Video Clip Type: Displays the profile used for the recording and allows you to specify whether to start recording up to 5 seconds before the event to ensure the event is captured and the maximum duration of the video clip.

Target: Select where you want the video clip to be sent. It may be uploaded to an FTP or emailed to an email address.

You will need to enter your FTP or email server/account settings.

After making any changes, click the **Save Settings** button to save your changes, or click the **Don't Save Settings** button to discard your changes.

D-Link

DCS-5222L // LIVE VIDEO SETUP MAINTENANCE STATUS HELP

VIDEO CLIP

Video Clip is a feature to send video clips via FTP or E-Mail when a trigger is activated.
(The target can't be select both FTP and E-mail for the video clip.)

Save Settings Don't Save Settings

VIDEO CLIP

Video Clip

Trigger by: Always

Video Clip Type

Source: Profile 2 (Configurable in Audio and Video)

Pre-event recording: 5 Seconds (Between 0 to 5 seconds)

Maximum duration: 10 Seconds (Between 5 to 10 seconds)

Target

FTP

FTP Server/Port: : 21

User Name:

Password:

Path:

Filename Prefix:

Interval: 300 Seconds (Range : 60 to 86400 seconds)

Passive Mode:

E-mail

Save Settings Don't Save Settings

Helpful Hints..

Video Clip is the ability to store or send video clips to a remote E-mail or FTP server based on motion detection, external sensor input triggered.

Trigger by Motion
Begin video clipping after a motion is detected.

Schedule
Video clipping in a specified time.

Always
Continuous video clipping.

Digital Input
Begin video clip after digital input is detected.

Video Clip Type
You can set video clip codec, Pre-event recording and Maximum duration here.

Pre-event recording
Specify how much seconds of video will be recorded, before the video clip is taken.

Maximum duration
Specify how much seconds of video clip.

Target
You can select the target as FTP or E-mail for the video clip.

SURVEILLANCE

Snapshot

Here, you can set the camera to take snapshots when motion is detected. Snapshots can be sent to an e-mail address or to an FTP server.

Trigger by: Select the trigger event from the drop-down menu. **Motion** begins a snapshot after a motion is detected; **Schedule** sends “snapshots” at a specified time; **Always** provides continuous snapshots.

Snapshot Type: Select whether to take a single snapshot or to take 6 snapshots with a 1 second interval between them.

Target: Select where you want the snapshot to be sent. It may be uploaded to an FTP or emailed to an email address.

You will need to enter your FTP or email server/account settings.

After making any changes, click the **Save Settings** button to save your changes, or click the **Don't Save Settings** button to discard your changes.

D-Link

DCS-5222L // LIVE VIDEO SETUP MAINTENANCE STATUS HELP

SNAPSHOT

In order to enable your camera to take snapshots, you must select the checkbox of 'Snapshot'. Then, you can determine the trigger event(s) and FTP and/or E-mail notification(s).

Save Settings Don't Save Settings

SNAPSHOT

Snapshot

Trigger by: Always

Snapshot Type

Source: Profile 3 (Configurable in [Audio and Video](#))

Single snapshot

6 snapshot with 1 second interval (3 frames before and 3 frames after motion frame)

Target

FTP

E-mail

Save Settings Don't Save Settings

Helpful Hints...

Snapshot is the ability to store or send pictures to a remote E-mail or FTP server based on motion detection, external sensor input triggered.

Trigger by Motion
Begin snapshot after a motion is detected.

Schedule
Snapshot in a specified time.

Always
Continuous Snapshot.

Digital Input
Begin snapshot after digital input is detected.

Snapshot Type
You can set snapshot codec from Profile 3 (JPEG), Single snapshot or 6 snapshot here.

6 snapshot
Select to take continuous 6 pictures for each snapshot.

Target
You can select the target as FTP or E-mail for the snapshot.

SURVEILLANCE

SD Recording

This option allows you to configure and scheduling the recording of your camera. You can record video to the local SD Card.

Enable Check this checkbox to enable the recording feature. After enabling **recording**: recording, you will need to select a scheduling method.

DS Card: Select this option if you have inserted an available SD card into the camera.

Trigger by: Select the type of trigger event from the drop-down menu. **Motion** begins recording video/snapshot after a motion is detected; **Schedule** records video/takes snapshots at a specified time; **Always** will record video/take snapshots continuously.

Recording Type: Select to record video or take a snapshot.

Recording Length: Select the length of time for each video file.

Keep Free Space: This sets the capacity of your local SD Card to prevent the system from becoming unstable.

Cyclic: When this option is selected, it will cause the oldest file to be deleted when the system requires storage space for new files.

The screenshot shows the D-Link web interface for the DCS-5222L camera. The main content area is titled 'SD RECORDING' and contains the following settings:

- SD Recording
- Trigger by: Always (dropdown menu)
- Recording Type:
 - Snapshot
 - Video
- Source: Profile 2 (dropdown menu) (Configurable in Audio and Video)
- Recording Length: 1 (dropdown menu) minutes per file
- SD Card:
 - Keep Free Space: 200 (input field) MB (Minimum is 200)
 - Cyclic

Buttons for 'Save Settings' and 'Don't Save Settings' are located at the bottom of the configuration area.

The 'Helpful Hints...' sidebar on the right provides additional information:

- SD Recording** is the ability to record video or snapshot (per second) to local SD Card based on motion detection or in a specified time.
- Trigger by Motion:** Begin SD recording after a motion is detected.
- Schedule:** SD recording in a specified time.
- Always:** Continuous SD recording.
- Digital Input:** Begin recording after digital input is detected.
- Recording Type:** You can set recording mode, set pre-event recording, and post-event recording here when Trigger by is Motion. You can also select recording as Snapshot or Video.
- Recording Length:** Set the time length of

After making any changes, click the **Save Settings** button to save your changes, or click the **Don't Save Settings** button to discard your changes.

Digital Output

You can enable the digital output port as well as configure a trigger event.

Motion Detection: When a motion detection is triggered.

D/I Signal: A trigger from the Digital Input port.

The screenshot shows the D-Link web interface for the DCS-5222L camera. The top navigation bar includes 'LIVE VIDEO', 'SETUP', 'MAINTENANCE', 'STATUS', and 'HELP'. The left sidebar lists various configuration options, with 'Digital Output' selected. The main content area is titled 'DIGITAL OUTPUT' and contains the following text and controls:

Here you can enable your D/O port as well as how the event will be triggered.

Buttons: Save Settings, Don't Save Settings

DIGITAL OUTPUT

D/O Signal

Trigger Event: Motion Detection

Only during

Day: Sun Mon Tue Wed Thu Fri Sat

Time: Start 0 : 0 End 0 : 0

Buttons: Save Settings, Don't Save Settings

Helpful Hints..

You may choose a trigger event like Motion detection or triggers from the D/I port. When an event is triggered, the D/O will begin sending a signal.

The bottom of the page features the 'SURUEILLANCE' logo.

Motion Detection

This option allows you to set up Motion Detection on your network camera. In order to use motion detection, first check the **Enable Video Motion** checkbox. Next, click on the video window and draw motion detection zones by clicking and dragging the mouse cursor. Red areas indicate areas that will be monitored for motion. The camera also has a PIR sensor which is used to detect motion using a special infrared sensor. PIR is good at detecting motion from live subjects such as people and animals.

Enable Video Motion: Check this box to enable the motion detection feature of your camera.

Enable PIR: When this option is selected, use PIR (passive infrared) to detect motion.

Sensitivity: This setting adjusts how sensitive the camera will be to motion, where 100% will be the most sensitive setting and 0% will be the least sensitive setting.

Drawing Mode: Select **Draw Motion Area** to select the area of the picture to monitor for movement to trigger recording or snapshot. Use your mouse to click on the blocks that you would like to monitor for motion. Select **Erase Motion Area** to remove the blocks and stop the camera from monitoring that area of the picture.

Clear: Clicking this button will clear all motion detection zones.

After making any changes, click the **Save Settings** button to save your changes, or click the **Don't Save Settings** button to discard your changes.

Note: If the camera is set to SXGA mode in Audio and Video, Motion Detection is disabled.

The red grid on the right indicates an area that has been selected for motion detection. When motion is detected, the LIVE VIDEO page will display a blinking orange motion video icon like the one below.



No Motion

Motion

The motion notification will continue to blink as long as motion is detected. If no additional motion is detected, it will return to its original state after eight seconds.

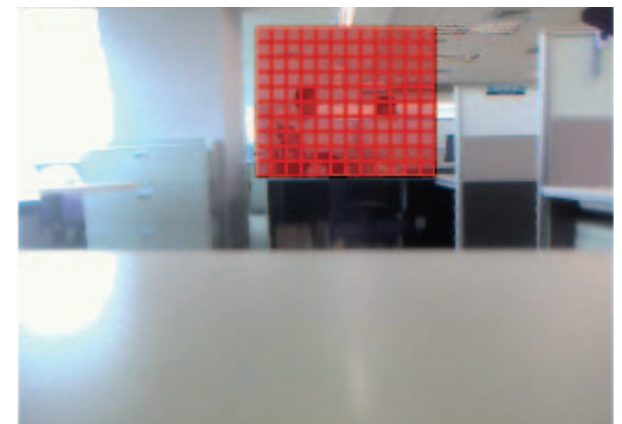

Camera Control

Select the **Preset Position** from the drop-down menu to access settings that affect how the Internet Camera can pan and move to preset locations.

Set As Home: Click to set the current position as Home.

Default Home: Click to set the Home position with the default setting.

Pan Step: Select the speed at which the camera will pan for a full cycle from the drop-down list. Select a value between 0 and 10, 0 being the slowest setting.

Tilt Step: Select the speed at which the camera will tilt for a full cycle from the drop-down menu. Select a value between 0 and 10, 0 being the slowest.

Preset Name: Enter a name for your camera location and click **Add**.

Present Position: Select created presets from the drop-down menu. If you want to delete an entry, select it and then click **Delete**.

Patrol Selection: To use the Auto Patrol feature, select the desired preset positions from the *Preset Locations* list and add them to the *Patrol Positions* list by clicking **Select**. You can then select the order in which the camera will patrol through the preset locations by selecting a location and clicking **Up** or **Down**. Click **Remove** to remove a location from the list. Click **Save** when finished.

The screenshot shows the D-Link web interface for the DCS-5222L camera. The top navigation bar includes 'LIVE VIDEO', 'SETUP', 'MAINTENANCE', 'STATUS', and 'HELP'. The left sidebar lists various setup options, with 'Camera Control' selected. The main content area is titled 'CAMERA CONTROL' and contains the following sections:

- CAMERA CONTROL:** A header section with a sub-header 'CAMERA CONTROL' and a description: 'Here you can add or delete the preset positions, select the positions for 'Patrol' as well as change the default position of your 'Home' button.'
- PRESET POSITION:** This section features a live video feed of a jacket on a chair. To the right of the video is a directional pad with four arrows. Below the pad are two buttons: 'Set As Home' and 'Default Home'. Further down are two dropdown menus: 'Pan Step : 10' and 'Tilt Step : 10'. Below these are input fields for 'Preset Name :', 'Preset Position : -- Select One --', and 'Add' and 'Delete' buttons.
- PATROL SELECTION:** This section contains two empty boxes labeled 'Preset Positions' and 'Patrol Positions'. A 'Select' button is positioned between them. Below the boxes are 'Up', 'Down', and 'Remove' buttons. At the bottom, there is a 'Dwelling Time : 1 seconds' field and a 'Save' button.

On the right side of the interface, there is a 'Helpful Hints..' section with three sub-sections: 'Home Definition', 'Patrol Selection', and 'Patrol Positions', each providing brief instructions on their respective functions.

SD Management

This page allows you to browse and manage the recorded files on an SD card which is inserted into the camera.

Format SD Card: Click to automatically format the SD Card and create folder for video. Formatting your SD Card will erase all data currently saved.

Delete: Click the checkbox in front of the Delete button to select all the files and catalogs below. The Delete button is used to delete the files or catalogs which are selected.

Name: The name of file or catalog.

Size: The file's size.

Refresh: Click to refresh the page.

Files per page: Select the number of files to be displayed on a single page. The maximum is 100 files.

Pages: Show the current and total pages.

The screenshot shows the D-Link web interface for SD Management. The top navigation bar includes 'LIVE VIDEO', 'SETUP', 'MAINTENANCE', 'STATUS', and 'HELP'. The left sidebar lists various configuration options, with 'SD Management' selected. The main content area displays the following information:

- SD Card:** DCS-5222L /
- SD Status:** Ready
- Files per Page:** 5 (with a 'Refresh' link)
- Pages:** 1 of 1
- Table:**

<input type="checkbox"/>	Name	Size
<input type="checkbox"/>	20110101	
- Buttons:** 'Delete' (disabled), 'Format SD Card'
- Summary:** Total : 4026752 KB, Used : 4864 KB, Free : 4021888 KB

A 'Helpful Hints..' sidebar on the right explains the 'Format SD Card' button: 'Click this button to automatically format the SD Card and create folder for snapshot and video.'

Maintenance Admin

This section allows you to change the administrator's password and configure the server settings for your camera. You can also manage the user account(s) that access to your camera.

Admin Password Setting: This section lets you change the admin password used to log into the camera and change settings. After installing the camera for the first time, it is highly recommended that you change the admin password for security purposes.

Enter the existing password, then enter your old new password. Click **Save** to apply your new settings.

Add User Account: You may create user accounts to allow others to log into your camera to view the live camera feed. Users cannot change any settings.

Enter the User Name you wish to use for the new user account and then create a password for that account. Click Add to save your account.

User List: Select a user from the drop-down menu and click **Delete** to remove the user account from having access to the camera images.

RTSP Authentication: Check to enable RTSP streaming.

HTTP Authentication: Check to enable HTTP streaming.

Snapshot URL Authentication: Select **Enable** to allow access to the current camera snapshot via the web address indicated.

D-Link

DCS-5222L // LIVE VIDEO SETUP MAINTENANCE STATUS HELP

ADMIN

Here you can change the administrator's password for your account as well as add and/or delete user account(s). You can also configure a unique name for your camera, and enable its OSD (On-Screen Display) feature in order to display camera name and time stamp for both live video and recordings of your camera.

ADMIN PASSWORD SETTING

Old Password 30 characters maximum
 New Password 30 characters maximum
 Confirm New Password

ADD USER ACCOUNT

User Name 30 characters maximum
 New Password 30 characters maximum
 Confirm New Password
 20 users maximum

USER LIST

User Name -- User list --

AUTHENTICATION

RTSP Authentication
 HTTP Authentication
 Snapshot URL Authentication (<http://192.168.0.101/image/jpeg.cgi>)

DEVICE SETTING

Camera Name 30 characters maximum
 OSD
 Label 30 characters maximum
 Time Stamp
 Power/Link LED Light

PRIVACY CONTROL

Privacy Control
 Privacy Off
 Privacy On

Helpful Hints...

For security purposes, it is recommended to change the password for your administrator account. Be sure to write down the new password to avoid having to reset the camera in the event that it is forgotten.

User Account
 User account is given to an user a privilege to login into Live View page and use functions in the page.

RTSP Authentication
 Enable user validation for RTSP streaming.

HTTP Authentication
 Enable user validation for HTTP streaming.

Snapshot URL Authentication
 Enable user validation for Snapshot URL.

OSD
 Enable OSD, the Label and Time Stamp will be displayed on the Live Video Image.

Power/Link LED Light
On
 Normal LED blinking depending on power and linkage status.
Off
 Always turn off LED.
Flicker
 Always flicking Link LED as video being monitored.

Privacy Control
 Allow you to configure if camera could enter Privacy mode or not.
Privacy Off
 Camera is in a normal operating mode.
Privacy On
 Camera is in a Privacy mode. Live Video/Audio will be turned off.

SURVEILLANCE

Camera Name: Enter the name of your camera. This is useful if you have multiple cameras.

Enable OSD: This will enable the information bar On Screen Display (OSD) to appear when viewing video.

Label: This is the text label that will appear on the OSD.

Time Stamp: If checked, the current time will be displayed on the OSD.

LED Light: This will turn the camera's front LED indicator on or off.

Calibrate the Device: Clicking this button will calibrate the camera so that the P/T/Z apparatus functions correctly. The camera is automatically calibrated whenever it is powered on and initialized or reset. Should the camera's pan, tilt, and zoom functions begin to behave incorrectly, or if the device has been jarred or handled improperly, you may need to recalibrate the camera manually by pressing this button.

Privacy Mode: Select on/off or schedule the privacy mode for your camera to ensure the privacy. When the privacy mode is turned on, the camera hides the lens by rolling it back into the unit.

After making any changes, click the **Save** button to save your changes.

System

This screen allows you to save and restore the camera's current configuration. You can also reset all settings to factory default or reboot the device.

Save to Local Hard Drive: Click on the **Save Configuration** button to save the current configuration to your hard drive.

Load from Local Hard Drive: To load a saved configuration, click on the **Browse Hard Drive:** button to select a configuration file from your hard drive. Then, click the **Load Configuration** button to load the new configuration.

Restore to Factory Defaults: Click this button to reset all settings to their factory defaults. If you select to reset your settings, you will need to set up your camera again.

Reboot Device: Clicking the **Reboot** button will reboot your device.

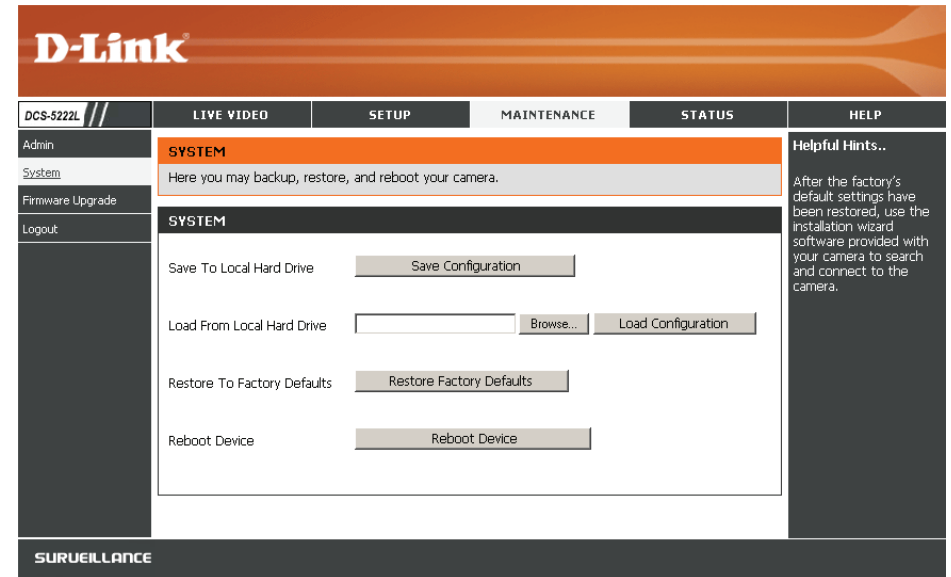

Firmware Upgrade

Your current firmware version and date will be displayed on this page. You can also upgrade your firmware with a new version.

To upgrade your firmware, go to **support.dlink.com** and download the latest firmware to your computer's hard drive. Click on **Browse**, select the firmware file, then click the **Upload** button. While the firmware is being upgraded, do not turn off your computer or camera, and do not disconnect your network connection from your computer or camera. Upgrading the firmware will not change any of your system settings, but it is recommended that you save your system configuration before doing a firmware upgrade.

Note: *It is recommended that you use a wired connection for your computer and camera when upgrading the firmware.*

The screenshot shows the D-Link web interface for a DCS-5222L camera. The top navigation bar includes 'LIVE VIDEO', 'SETUP', 'MAINTENANCE', 'STATUS', and 'HELP'. The left sidebar contains 'Admin', 'System', 'Firmware Upgrade', and 'Logout'. The main content area is titled 'FIRMWARE UPGRADE' and contains the following text:

A new firmware upgrade may be available for your IP camera. It is recommended to keep your IP camera firmware up-to-date to maintain and improve the functionality and performance of your internet camera. Click here [D-Link Support Page](#) to check for the latest firmware version availability. To upgrade the firmware on your IP camera, please download and save the latest firmware version from the D-Link Support Page to your local hard drive. Locate the file on your local hard drive by clicking the Browse button. Once you have found and opened the file using the browse button, click the "Upload" button to start the firmware upgrade.

FIRMWARE INFORMATION

Current Firmware Version:	1.00
Current Firmware Build Number:	0928

FIRMWARE UPGRADE

File Path:

Helpful Hints...

Firmware upgrade is released periodically to improve the functionality of your IP camera and also to add new features. If you run into a problem with a specific feature of the IP camera, check our support site by clicking [here](#) to check for an upgrade and see if updated firmware is available for your IP camera.

SURUEILLANCE

Status Device Info

This screen displays various information about your camera and its current settings.

The screenshot shows the D-Link web interface for the DCS-5222L camera. The top navigation bar includes 'LIVE VIDEO', 'SETUP', 'MAINTENANCE', 'STATUS', and 'HELP'. The 'STATUS' tab is active, and the 'Device Info' sub-tab is selected. The main content area is titled 'DEVICE INFO' and contains a message: 'All of your network connection details are displayed on this page. The firmware version is also displayed here.' Below this is an 'INFORMATION' section with the following details:

Camera Name	DCS-5222L
Time & Date	Sat Jan 1 00:34:56 2011
Firmware Version	1.00
Firmware Build Number	0928
MAC Address	5C:33:8E:43:B3:1B
IPv4 Address	192.168.0.101
IPv4 Subnet Mask	255.255.255.0
IPv4 Default Gateway	192.168.0.1
IPv4 Primary DNS	192.168.0.1
IPv4 Secondary DNS	
PPPoE Status	Disabled
DDNS Status	Disabled

On the right side, there is a 'Helpful Hints..' section with the text: 'This page displays all the information about the camera and network settings.' The bottom of the interface features a 'SURVEILLANCE' banner.

Log

The log shows you a list of events that have happened recently. You can download the log by clicking the **Download** button, or you can empty the log by clicking the **Clear** button.

The screenshot shows the D-Link web interface for the DCS-5222L camera. The top navigation bar includes 'LIVE VIDEO', 'SETUP', 'MAINTENANCE', 'STATUS', and 'HELP'. The 'Log' page is active, showing a 'SYSTEM LOG' section with a description: 'The system log records camera events that have occurred.' Below this is the 'CURRENT LOG' section, which contains a list of 25 events. Each event is a timestamp followed by the text 'admin is streaming video.' The 14th event is a recording event: 'Recording 20110101_072652.avi at 2011/01/01 07:26:52 to SD Card is OK.' At the bottom of the log list are two buttons: 'Clear' and 'Download'. The left sidebar contains 'Device Info', 'Log', and 'Logout'. The right sidebar contains 'Helpful Hints..' with instructions on how to save the log. The bottom of the page has a 'SURVEILLANCE' banner.

DCS-5222L //	LIVE VIDEO	SETUP	MAINTENANCE	STATUS	HELP
Device Info	SYSTEM LOG				Helpful Hints.. You can save the log to your local hard drive by clicking the Download button, and you can clear the log by clicking on the Clear button.
Log	The system log records camera events that have occurred.				
Logout	CURRENT LOG				
	2011-01-01 00:27:39 admin is streaming video. 2011-01-01 00:27:42 admin is streaming video. 2011-01-01 02:01:43 admin is streaming video. 2011-01-01 02:05:44 admin is streaming video. 2011-01-01 02:19:40 admin is streaming video. 2011-01-01 02:19:40 admin is streaming video. 2011-01-01 02:22:00 admin is streaming video. 2011-01-01 06:43:18 admin is streaming video. 2011-01-01 06:44:39 admin is streaming video. 2011-01-01 06:48:12 admin is streaming video. 2011-01-01 06:49:25 admin is streaming video. 2011-01-01 06:51:56 admin is streaming video. 2011-01-01 06:56:08 admin is streaming video. 2011-01-01 06:59:57 admin is streaming video. 2011-01-01 07:01:00 admin is streaming video. 2011-01-01 07:02:27 admin is streaming video. 2011-01-01 07:03:16 admin is streaming video. 2011-01-01 07:03:49 admin is streaming video. 2011-01-01 07:04:33 admin is streaming video. 2011-01-01 07:07:59 admin is streaming video. 2011-01-01 07:09:32 admin is streaming video. 2011-01-01 07:13:48 admin is streaming video. 2011-01-01 07:15:40 admin is streaming video. 2011-01-01 07:18:22 admin is streaming video. 2011-01-01 07:20:48 admin is streaming video. 2011-01-01 07:25:01 admin is streaming video. 2011-01-01 07:27:00 Recording 20110101_072652.avi at 2011/01/01 07:26:52 to SD Card is OK. 2011-01-01 07:27:17 admin is streaming video. 2011-01-01 07:28:16 admin is streaming video.				
	<input type="button" value="Clear"/> <input type="button" value="Download"/>				
SURVEILLANCE					

Help

The screenshot shows the D-Link web interface for the DCS-5222L camera. The top navigation bar includes 'LIVE VIDEO', 'SETUP', 'MAINTENANCE', 'STATUS', and 'HELP'. The 'HELP' menu is expanded, showing a 'HELP MENU' with links to 'LIVE VIDEO', 'SETUP', 'MAINTENANCE', and 'STATUS'. Below this, the 'LIVE VIDEO' section contains a link to 'Camera'. The 'SETUP' section lists various configuration options: 'Setup Wizard', 'Network', 'Wireless Setup', 'Dynamic DNS', 'Image Setup', 'Audio and Video', 'Time and Date', 'Video Clip', 'Snapshot', 'SD Recording', 'Digital Output', 'Motion Detection', 'Camera Control', and 'SD Management'. The 'MAINTENANCE' section includes 'Admin', 'System', and 'Firmware Upgrade'. The 'STATUS' section includes 'Device Info' and 'Log'. A 'SURVEILLANCE' bar is visible at the bottom of the interface.

DCS-5222L //	LIVE VIDEO	SETUP	MAINTENANCE	STATUS	HELP
Help Menu Acknowledgements Logout	HELP MENU LIVE VIDEO SETUP MAINTENANCE STATUS				
LIVE VIDEO Camera					
SETUP Setup Wizard Network Wireless Setup Dynamic DNS Image Setup Audio and Video Time and Date Video Clip Snapshot SD Recording Digital Output Motion Detection Camera Control SD Management					
MAINTENANCE Admin System Firmware Upgrade					
STATUS Device Info Log					
SURVEILLANCE					

Configuring the DCS-5222L with a Router

D-Link's DCS-5222L is a versatile and cost effective Network Camera offering both video and audio monitoring. It can also serve as a powerful surveillance system in security applications. The DCS-5222L can be used with any wired or 802.11n/g wireless router. This section explains how to view the camera from either the Internet or from inside your internal network.

Components Needed:

- 1 DCS-5222L Network Camera
- 1 Ethernet Cable
- A wired or wireless router such as the D-Link DIR-655 Wireless Router
- Ethernet-based PC for system configuration

Setting up the DCS-5222L for Use Behind a Router

Installing a DCS-5222L Network Camera on your network is an easy 4–step procedure:

1. Assign a local IP address to your network camera.
2. View the network camera using your Internet Explorer web browser.
3. Access the router with your web browser.
4. Open virtual server ports to enable remote image viewing.

Note: *These are manual steps; however, if you decide to use the wizard, it will perform every step automatically.*

This section is designed to walk you through the setup process for installing your camera behind a router and enable remote video viewing. For the basic setup of the DCS-5222L, follow the steps outlined in the Quick Installation Guide.

After you have completed the setup of the DCS-5222L outlined in the Quick Installation Guide you will have an operating camera that has an assigned IP Address. Because you are using a router to share the Internet with one or more PCs, the IP Address assigned to the Network Camera will be a local IP Address. This allows viewing within your Local Area Network (LAN) until the router is configured to allow remote viewing of the camera over the Internet.

1. Assign a Local IP Address to Your Camera

Run the setup wizard from the CD included with the DCS-5222L. Follow the steps in the Quick Installation Guide to configure the DCS-5222L. The camera will be assigned a local IP Address that allows it to be recognized by the router. Write down this IP Address for future reference.

2. View the Network Camera Using Your Internet Explorer Web Browser

Open a Web browser. In the address bar, type in the IP Address that was assigned to the Network Camera. The DCS-5222L Live Video Page appears with a window displaying live video from the camera.

Click on the **Setup** button on the left side. Scroll to the bottom of the Network Setup page to display the ports used by HTTP and Streaming audio and video.

The screenshot shows the D-Link web interface for the DCS-5222L camera. The top navigation bar includes links for LIVE VIDEO, SETUP, MAINTENANCE, STATUS, and HELP. The main content area is titled 'DEVICE INFO' and contains a table of network information. A sidebar on the left has links for Device Info, Log, and Logout. A sidebar on the right provides helpful hints. The bottom of the page features a 'SURVEILLANCE' banner.

INFORMATION	
Camera Name	DCS-5222L
Time & Date	Sat Jan 1 00:34:56 2011
Firmware Version	1.00
Firmware Build Number	0928
MAC Address	5C:33:8E:43:B3:1B
IPv4 Address	192.168.0.101
IPv4 Subnet Mask	255.255.255.0
IPv4 Default Gateway	192.168.0.1
IPv4 Primary DNS	192.168.0.1
IPv4 Secondary DNS	
PPPoE Status	Disabled
DDNS Status	Disabled

The **Setup > Network** page displays the port settings for your camera. If necessary, these ports can be changed if they are already in use by other devices (e.g. in a multiple camera environment).

Note: Both the HTTP port and RTSP port are required to be opened for the DCS-5222L.

LAN SETTINGS

LAN SETTINGS

Automatic IP Address

Static IP Address

IPv4 Address

Subnet Mask

Default Gateway (Router)

Optional Primary DNS

Optional Secondary DNS

PPPoE

PORT SETTINGS

HTTP Port

RTSP Port

UPnP

UPnP

UPnP Port Forward

Apple

Bonjour

Router Set-Up and Installation

The following steps generally apply to any router that you have on your network. The D-Link DIR-655 is used as an example to clarify the configuration process. Refer to the router's user manual for more information on router operation and configuration.

3. Access the Router with Your Web Browser

If you have cable or DSL Internet service, you will most likely have a dynamically assigned WAN IP Address. 'Dynamic' means that your router's WAN IP address can change from time to time depending on your ISP. A dynamic WAN IP Address identifies your router on the public network and allows it to access the Internet. To find out what your router's WAN IP Address is, go to the Status page on your router and locate the WAN information for your router (as shown on the next page). The WAN IP Address will be listed. This will be the address that you will need to type in your web browser to view your camera over the Internet.

Your WAN IP Address will be listed on the router's **Status > Device Info** page.

DCS-5222L	LIVE VIDEO	SETUP	MAINTENANCE	STATUS
Device Info	DEVICE INFO			
Log	All of your network connection details are displayed on this page. The firmware version is also displayed here.			
Logout	INFORMATION			
	Camera Name	DCS-5222L		
	Time & Date	Sat Jan 1 07:32:15 2011		
	Firmware Version	1.00		
	Firmware Build Number	0922		
	MAC Address	00:03:1B:59:03:0B		
	IPv4 Address	169.254.53.155		
	IPv4 Subnet Mask	255.255.0.0		
	IPv4 Default Gateway	169.254.0.1		
	IPv4 Primary DNS			
	IPv4 Secondary DNS			
	PPPoE Status	Disabled		
	DDNS Status	Disabled		

Note: Because a dynamic WAN IP can change from time to time depending on your ISP, you may want to obtain a Static IP address from your ISP. A Static IP address is a fixed IP address that will not change over time and will be more convenient for you to use to access your camera from a remote location. The Static IP Address will also allow you to access your camera attached to your router over the Internet.

4. Open Ports to Enable Remote Image Viewing (Port Forwarding)

The firewall security features built into the DIR-655 router prevent users from accessing the video from the DCS-5222L over the Internet. The router connects to the Internet over a series of numbered ports. The ports normally used by the DCS-5222L are blocked from access over the Internet. Therefore, these ports need to be made accessible over the Internet. This is accomplished using the Virtual Server function on the DIR-655 router. The Virtual Server ports used by the camera must be opened through the router for remote access to your camera. Virtual Server is accessed by clicking on the **Advanced** tab of the router screen.

Follow these steps to configure your router's Virtual Server settings:

1. Click **Enabled**.
2. Enter a different name for each entry.
3. Enter your camera's local IP Address (e.g., 192.168.0.120) in the Private IP field.
4. Select TCP for HTTP port, both (TCP and UDP) for RTSP and both (TCP and UDP) for 5556 - 5559 ports.
5. If you are using the default camera port settings, enter 80 into the Public and Private Port section, click **Apply**.
6. Scheduling should be set to Always so that the camera images can be accessed at any time.

Repeat the previous steps adding the port 554 to both the Public and Private Port sections. A check mark appearing before the entry name will indicate that the ports are enabled.

Important: Some ISPs block access to port 80 and other commonly used Internet ports to conserve bandwidth. Check with your ISP so that you can open the appropriate ports accordingly. If your ISP does not pass traffic on port 80, you will need to change the port the camera uses from 80 to something else, such as 800. Not all routers are the same, so refer to your user manual for specific instructions on how to open ports.

Enter valid ports in the Virtual Server section of your router. Please make sure to check the box next to the camera name on the Virtual Server List to enable your settings.

D-Link

DCS-5222L // LIVE VIDEO SETUP MAINTENANCE STATUS HELP

Setup Wizard
Network
Wireless Setup
Dynamic DNS
Image Setup
Audio and Video
Time and Date
Video Clip
Snapshot
SD Recording
Digital Output
Motion Detection
Camera Control
SD Management
Logout

AUDIO AND VIDEO
You may configure audio and video settings (4 video profiles) here. Profile 3 has been set for snapshot, and profile 4 is set for your mobile phone or PDA device.
Save Settings Don't Save Settings

VIDEO PROFILE 1

Encode Type	Resolution	FPS	Encode Method	bps	RTSP URL
H.264	1280x800	30	CBR	4 Mbps	play1.sdp

VIDEO PROFILE 2

Encode Type	Resolution	FPS	Encode Method	bps	RTSP URL
H.264	640X400	10	CBR	1 Mbps	play2.sdp

VIDEO PROFILE 3

Encode Type	Resolution	FPS	Encode Method	Quality	RTSP URL
JPEG	640X400	10	Quality	Good	play3.sdp

VIDEO PROFILE 4 (FOR MOBILE DEVICE ONLY)

Encode Type	Resolution	FPS	Encode Method	bps	RTSP URL
MPEG4	320X192	5	CBR	384 Kbps	3gpp

DAY/NIGHT MODE
Day/Night Mode: Auto

AUDIO SETUP

Speaker
Volume: 50

Microphone
Volume: 50

Save Settings Don't Save Settings

Helpful Hints..
Higher Resolution, FPS and bps gives better video quality. At the same time, it requires more network bandwidth.
Encode Type
Select the video codec 'JPEG', 'MPEG4', or 'H.264'.
Resolution
The options depend on display system used.
FPS
The amount of image frames rendered by the camera per second.
bps
Select a fixed bandwidth for your camera operation. Higher value means a higher quality image but consumes more network bandwidth.
Quality
Set the quality for image.
RTSP URL
The URL used to connect to the camera when viewing from QuickTime or a mobile device.
Day/Night Mode
Select night mode to use camera's IR LED in a dim light area.

Troubleshooting

This chapter provides solutions to problems that can occur during the installation and operation of the DCS-5222L.

1. What is Remote Access? How do I enable it?

Remote Access allows you to access your camera from any PC connected to the Internet through a web browser. This lets you view your camera feed and manage your camera's settings when you're away from home.

To enable Remote Access, simply go through the Camera Installation Wizard included on the Installation CD that came in your package. You can also download the wizard from <http://www.mydlink.com/support>.

After going through the wizard, you should see Remote Status: Enabled on the summary page. If you see Remote Status: Disabled, make sure that:

- ...the front LED on your camera is lit solid green
- ...your Internet connection is working
- ...your router's LAN & WAN connections are working properly
- ...your router has UPnP enabled (if your router does not support UPnP, please refer to Appendix A)
- ...your router can get a public IP
- ...your router is upgraded to the latest firmware
- ...you have tried rebooting your router by unplugging it, then plugging it back in

After checking the above items, you can click the Retry button to refresh the summary screen to see if Remote Access has been enabled.

2. What can I do if I forget my password?

If you forget your password, you will need to perform a hard reset of your camera. This process will change all your settings back to the factory defaults. To reset your camera, please use an unfolded paperclip to press and hold the RESET button for at least 8 seconds while your camera is plugged in.

3. In addition to using mydlink.com, is there another way to access my camera remotely over the Internet?

Yes, you can access your camera over the Internet through the following URL after successfully installing your camera through the Camera Installation Wizard:

`http://[mydlink No.].mydlink.com`

For example, if your camera's mydlink No. was 12345678, you would be able to access your camera remotely by opening your web browser and going to `http://12345678.mydlink.com`.

This URL will open a webpage where you will be asked to log in by entering your camera's password. After entering your password, your camera's Live View window will open, and you will be able to configure your camera as well.

4. Why does the LED not light up?

The power supply might be faulty. Confirm that you are using the provided DC 5V power supply for this network camera. Verify that the power supply is correctly connected. If the camera is functioning normally, the LED may have been disabled. See page 36 for information about how to enable the LED.

5. Why is the camera's network connection unreliable?

There might be a problem with the network cable. To confirm that the cables are working, PING the address of a known device on the network. If the cabling is OK and your network is reachable, you should receive a reply similar to the following (...bytes = 32 time = 2 ms).

Another possible problem may be that the network device such as a hub or switch utilized by the Network Camera is not functioning properly. Please confirm the power for the devices are well connected and functioning properly.

6. Why does the Network Camera work locally but not remotely?

This might be caused by the firewall protection. Check the Internet firewall with your system administrator. The firewall may need to have some settings changed in order for the Network Camera to be accessible outside your local LAN. For more information, please refer to the section about installing your camera behind a router.

Make sure that the Network Camera isn't conflicting with any Web server you may have running on your network. The default router setting might be a possible reason. Check that the configuration of the router settings allow the Network Camera to be accessed outside your local LAN.

7. Why does a series of broad vertical white lines appear through out the image?

It could be that the CMOS sensor (a square panel situated behind the lens that measures the light signals and changes it into a digital format so your computer can present it into an image that you are familiar with) has become overloaded when it has been exposed to bright lights such as direct exposure to sunlight or halogen lights. Reposition the Network Camera into a more shaded area immediately as prolonged exposure to bright lights will damage the CMOS sensor.

8. The camera is producing noisy images. How can I solve the problem?

The video images might be noisy if the Network Camera is used in a very low light environment.

9. The images are poor quality, how can I improve the image quality?

Make sure that your computer's display properties are set to at least 6-bit color. Using 16 or 256 colors on your computer will produce dithering artifacts in the image, making the image look as if it is of poor quality.

The configuration on the Network Camera image display is incorrect. The Web Configuration Video section of the Web management allows you to adjust the related-parameters for improved images such as: brightness, contrast, hue and light frequency. Please refer to the Web Configuration section for detailed information.

10. Why are no images available through the Web browser?

ActiveX might be disabled. If you are viewing the images from Internet Explorer make sure ActiveX has been enabled in the Internet Options menu. You may also need to change the security settings on your browser to allow the ActiveX plug-in to be installed.

If you are using Internet Explorer with a version number lower than 6, then you will need to upgrade your Web browser software in order to view the streaming video transmitted by the Network Camera.

11. The PIR is no operation well, how can I improve the PIR quality?

- For the Passive Infrared Sensor (PIR) to function properly it is required to have direct line of site to the object. When the room has many obstacles or the line of site is obstructed by glass, the PIR will not function properly.
- When the environment temperature is too high, the PIR detection will slow down and should not be mistaken for a faulty PIR.
- This Network Camera can only be installed indoors. Do not install this camera in a place where IR interference can be a problem. IR interference can be found close to glass doors or windows, where direct sunlight can cause interference or in the path of car headlights.

- Do not install this camera next to or in front of an air conditioner outlet or vent.
- Do not install this camera close to wireless devices with high frequencies as the PIR is easily affected by RF radiation.
- The PIR functions at best when detecting lateral movements. Radial movements cannot be detected as well as lateral movements.
- Do not install this camera directly under an extreme bright light. The PIR cannot fully suppress a bright white light.
- Any movements from an object with a normal body temperature, like humans or animals, can be detected. To avoid any malfunctions, install this camera at the proper height.
- To avoid any malfunctions, install this camera in an environment with an average temperature of 25°C. Only within a distance of 2.5 meters can smaller movements of an object, with the average adult human's height, be detected. Between a distance of 2.5 and 5 meters, a larger movement of an object is required for detection.
- Install this camera on a firm, static, anti-shock surface.

Networking Basics

Check your IP address

After you install your new D-Link adapter, by default, the TCP/IP settings should be set to obtain an IP address from a DHCP server (i.e. wireless router) automatically. To verify your IP address, please follow the steps below.

Click on **Start > Run**. In the run box type **cmd** and click **OK**. (Windows® 7/Vista® users type cmd in the Start Search box)

At the prompt, type **ipconfig** and press **Enter**.

This will display the IP address, subnet mask, and the default gateway of your adapter.

If the address is 0.0.0.0, check your adapter installation, security settings, and the settings on your router. Some firewall software programs may block a DHCP request on newly installed adapters.

If you are connecting to a wireless network at a hotspot (e.g. hotel, coffee shop, airport), please contact an employee or administrator to verify their wireless network settings.

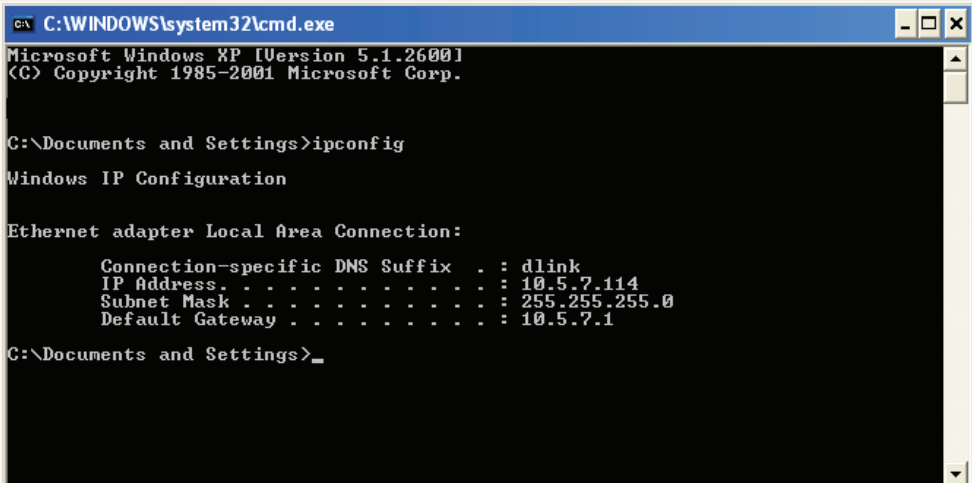

```
C:\WINDOWS\system32\cmd.exe
Microsoft Windows XP [Version 5.1.2600]
(C) Copyright 1985-2001 Microsoft Corp.

C:\Documents and Settings>ipconfig

Windows IP Configuration

Ethernet adapter Local Area Connection:

    Connection-specific DNS Suffix . : dlink
    IP Address. . . . . : 10.5.7.114
    Subnet Mask . . . . . : 255.255.255.0
    Default Gateway . . . . . : 10.5.7.1

C:\Documents and Settings>
```

Statically Assign an IP Address

If you are not using a DHCP capable gateway/router, or you need to assign a static IP address, please follow the steps below:

Step 1

Windows® 7- Click on **Start > Control Panel > Network and Internet > Network and Sharing Center**.

Windows® Vista - Click on **Start > Control Panel > Network and Internet > Network and Sharing Center > Manage Network Connections**.

Windows XP - Click on **Start > Control Panel > Network Connections**.

Step 2

Right-click on the **Local Area Connection** which represents your D-Link network adapter and select **Properties**.

Step 3

Highlight **Internet Protocol (TCP/IP)** and click **Properties**.

Step 4

Click **Use the following IP address** and enter an IP address that is on the same subnet as your network or the LAN IP address on your router.

Example: If the router's LAN IP address is 192.168.0.1, make your IP address **192.168.0.X** where X is a number between 2 and 99. Make sure that the number you choose is not in use on the network. Set Default Gateway the same as the LAN IP address of your router (192.168.0.1).

Set Primary DNS the same as the LAN IP address of your router (**192.168.0.1**). The Secondary DNS is not needed or you may enter a DNS server from your ISP.

Step 5

Click **OK** twice to save your settings.

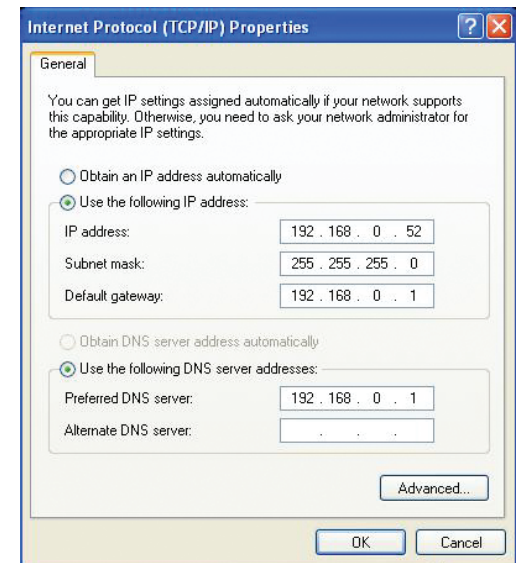

Technical Specifications - Remote Control Unit

Features

- Remote Controller
- Code system: NEC
- IR transmitter frequency: 38KHz

Pan/ tilt direction key

Pressing the pan/tilt direction keys (up, down, left, right) will move the camera

Home key

Pressing the Home key will move the camera to the home position.

Calibration key

Pressing the Calibration key will calibrate both the pan and tilt positions by moving from end to end and will go to the corrected home position.

Privacy key

Pressing the privacy key will tilt to the privacy position (privacy mode). Pressing it again privacy key will tilt the camera back to the previous position.

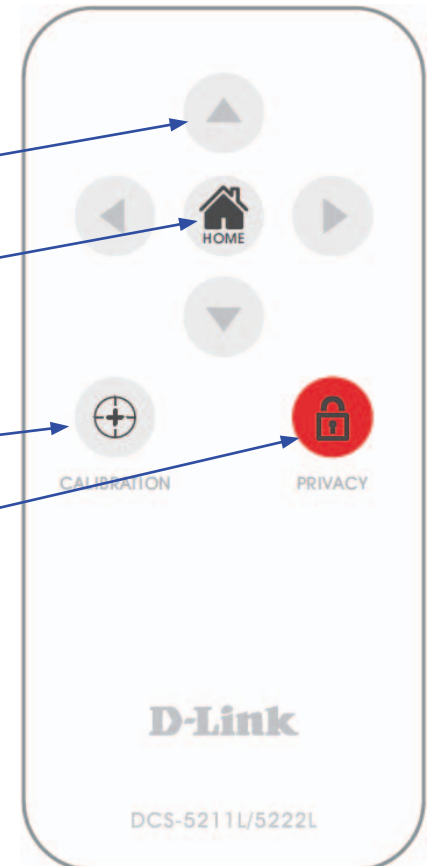

Matrix Index	Key Name	Key Code	Function
(1,2).....	Up	44	Tilt up
(2,1).....	Left	4C	Pan to the left
(2,2).....	Home	06	Return to home position
(2,3).....	Right	40	Pan to the right
(3,1).....	Calibration	07	Calibrate home position
(3,2).....	Down	48	Tilt down
(3,3).....	Privacy	0E	Tilt to privacy position.

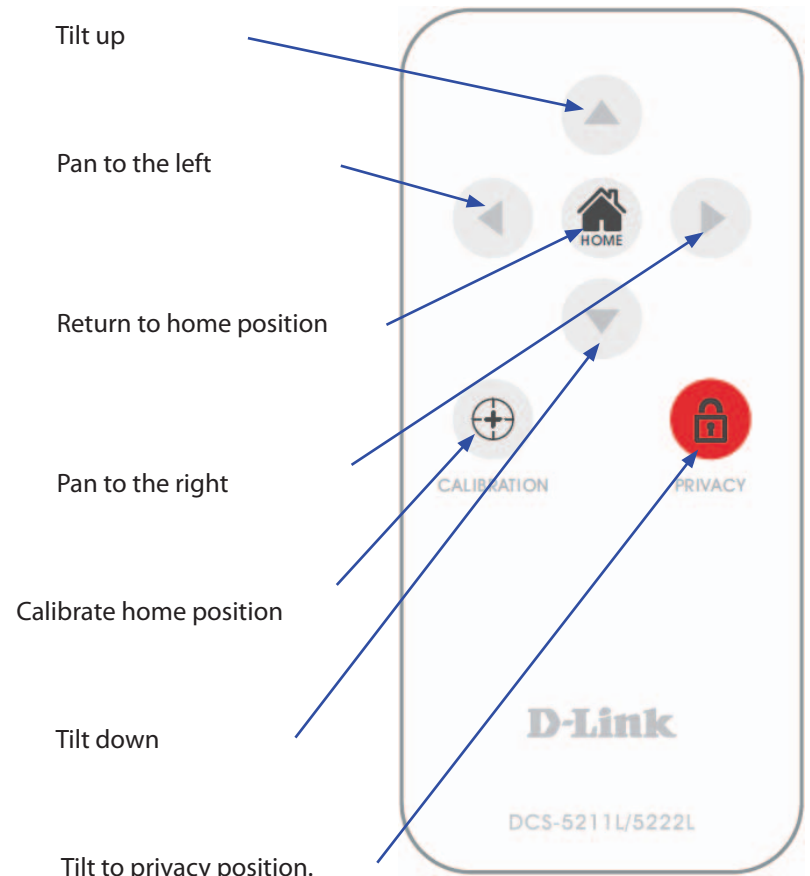

Technical Specifications - I/O Terminal Application

Typically used in association with programming scripts for developing applications for motion detection, event triggering, alarm notification via e-mail, and a variety of external control functions. The 4-pin I/O Terminal Block is located on the rear panel and provides the interface of a photo-coupled switch output and a photo-coupled input.

Connector Pin Assignment

Sign	FUNCTION	SPECIFICATION
DO-	Photo-Relay OUTPUT (Normal Open)	Close circuit current max. 70 mA AC, or 100 mA DC. On-Resistance max. 30 Ohm. Open circuit blocking voltage max. 240VAC or 340VDC
DO+	Photo-Relay OUTPUT(Common)	
DI-	Photo-Relay INPUT (-)	Active High voltage 2.5~25VDC Inactive Dropout voltage 0~1.5 VDC Internal on-current has limit at 7mA to protect the photo-relay.
DI+	Photo-Relay INPUT (+)	

Monitoring and Controlling

By entering http requests in your browser's URL field, it is possible to:

- Monitor the status of digital input.
- Drive the output switch on or off.

Interface Schematic

Output device (load) is driven by an external AC or DC power supply.

Input device (active control device) has an independent power supply.

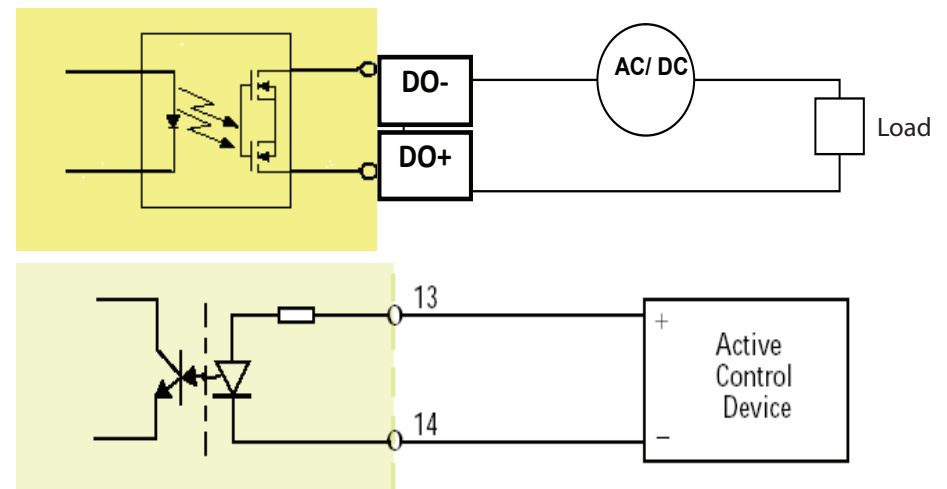

Technical Specifications

Networking Protocol

- IPv4, ARP, TCP, UDP, ICMP
- DHCP Client
- NTP Client (D-Link)
- DNS Client
- DDNS Client (D-Link)
- SMTP Client
- FTP Client
- HTTP Server
- UPNP Port Forwarding
- LLTD
- PPPoE
- RTP (Real Time Protocol)
- RTCP (Real Time Control Protocol)
- RTSP (Real Time Streaming Protocol)
- 3GPP(Video only)

LAN

- 10/100BASE-TX port
- IEEE 802.3 compliant
- IEEE 802.3u compliant
- Supports Full-Duplex operation
- MDI/MDIX auto-negotiation
- 802.3x Flow Control support for Full-Duplex mode

Wireless Connectivity

- 802.11g/n wireless with WEP/WPA/WPA2 Security
- WPS Support

Sensor

- 1/4 inch WXGA (1280x800)

Lens

- Focal length: 4.57mm, F1.9

Microphone

- Signal/noise ratio: 40dB +/- 3dB, Omni-directional

Reset Button

- Reset to factory default

Video Codec

- H.264/MPEG4/MJPEG triple format compression simultaneously
- JPEG for still image

Video Features

- Adjustable image size and quality
- Time stamp and text overlay
- Flip and Mirror
- Fully configurable motion detection window

Maximum Resolution

- 1280x720

Audio Codec

- PCM/ADPCM

Light Sensitivity

- 1 lux@F1.0

Digital Zoom

- Up to 4X

3A Control

- AGC (Auto Gain Control)
- AWB (Auto White Balance)
- AES (Auto Electronic Shutter)

Power

- Input: 100-240VAC, 50/60Hz
- Output: 12VDC, 1.25A
- Powered by an external power adapter
- Maximum power consumption
DCS-5222L: 10.5W @motor on ; 8.2W @motor off

Dimensions (WxDxH)

- 114.0mm x 114.0mm x 125.0mm (without bracket and stand)

Weight

- 540g (without bracket and stand)

Operation Temperature

- 0° to 40°C (32° to 104°F)

Storage Temperature

- -20° to 70°C (-4° to 158°F)

Humidity

- 20-80% RH non-condensing

Emission (EMI), Safety & Other Certifications

- FCC Class B
- IC
- C-Tick
- CE

Contacting Technical Support

U.S. and Canadian customers can contact D-Link technical support through our web site or by phone.

Before you contact technical support, please have the following ready:

- Model number of the product (e.g. DCS-5222L)
- Hardware Revision (located on the label on the bottom of the Network Camera (e.g. rev A1))
- Serial Number (s/n number located on the label on the bottom of the Network Camera).

You can find software updates and user documentation on the D-Link website as well as frequently asked questions and answers to technical issues.

For customers within the United States:

Phone Support:
(877) 453-5465

Internet Support:
<http://support.dlink.com>

For customers within Canada:

Phone Support:
(800) 361-5265

Internet Support:
<http://support.dlink.ca>

Warranty

Subject to the terms and conditions set forth herein, D-Link Systems, Inc. (“D-Link”) provides this Limited Warranty:

- Only to the person or entity that originally purchased the product from D-Link or its authorized reseller or distributor, and
- Only for products purchased and delivered within the fifty states of the United States, the District of Columbia, U.S. Possessions or Protectorates, U.S. Military Installations, or addresses with an APO or FPO.

Limited Warranty:

D-Link warrants that the hardware portion of the D-Link product described below (“Hardware”) will be free from material defects in workmanship and materials under normal use from the date of original retail purchase of the product, for the period set forth below (“Warranty Period”), except as otherwise stated herein.

- Hardware (excluding power supplies and fans): One (1) year
- Power supplies and fans: One (1) year
- Spare parts and spare kits: Ninety (90) days

The customer’s sole and exclusive remedy and the entire liability of D-Link and its suppliers under this Limited Warranty will be, at D-Link’s option, to repair or replace the defective Hardware during the Warranty Period at no charge to the original owner or to refund the actual purchase price paid. Any repair or replacement will be rendered by D-Link at an Authorized D-Link Service Office. The replacement hardware need not be new or have an identical make, model or part. D-Link may, at its option, replace the defective Hardware or any part thereof with any reconditioned product that D-Link reasonably determines is substantially equivalent (or superior) in all material respects to the defective Hardware. Repaired or replacement hardware will be warranted for the remainder of the original Warranty Period or ninety (90) days, whichever is longer, and is subject to the same limitations and exclusions. If a material defect is incapable of correction, or if D-Link determines that it is not practical to repair or replace the defective Hardware, the actual price paid by the original purchaser for the defective Hardware will be refunded by D-Link upon return to D-Link of the defective Hardware. All Hardware or part thereof that is replaced by D-Link, or for which the purchase price is refunded, shall become the property of D-Link upon replacement or refund.

Limited Software Warranty:

D-Link warrants that the software portion of the product (“Software”) will substantially conform to D-Link’s then current functional specifications for the Software, as set forth in the applicable documentation, from the date of original retail purchase of the Software for a period of ninety (90) days (“Software Warranty Period”), provided that the Software is properly installed on approved hardware and operated as contemplated in its documentation. D-Link further warrants that, during the Software Warranty Period, the magnetic media on which D-Link delivers the Software will be free of physical defects. The customer’s sole and exclusive remedy and the entire liability of D-Link and its suppliers under this Limited Warranty will be, at D-Link’s option, to replace the non-conforming Software (or defective media) with software that substantially conforms to D-Link’s functional specifications for the Software or to refund the portion of the actual purchase price paid that is attributable to the Software. Except as otherwise agreed by DLink in writing, the replacement Software is provided only to the original licensee, and is subject to the terms and conditions of the license granted by D-Link for the Software. Replacement Software will be warranted for the remainder of the original Warranty Period and is subject to the same limitations and exclusions. If a material non-conformance is incapable of correction, or if D-Link determines in its sole discretion that it is not practical to replace the non-conforming Software, the price paid by the original licensee for the non-conforming Software will be refunded by D-Link; provided that the non-conforming Software (and all copies thereof) is first returned to D-Link. The license granted respecting any Software for which a refund is given automatically terminates.

Non-Applicability of Warranty:

The Limited Warranty provided hereunder for Hardware and Software portions of D-Link’s products will not be applied to and does not cover any refurbished product and any product purchased through the inventory clearance or liquidation sale or other sales in which D-Link, the sellers, or the liquidators expressly disclaim their warranty obligation pertaining to the product and in that case, the product is being sold “As-Is” without any warranty whatsoever including, without limitation, the Limited Warranty as described herein, notwithstanding anything stated herein to the contrary.

Submitting A Claim:

The customer shall return the product to the original purchase point based on its return policy. In case the return policy period has expired and the product is within warranty, the customer shall submit a claim to D-Link as outlined below:

- The customer must submit with the product as part of the claim a written description of the Hardware defect or Software nonconformance in sufficient detail to allow D-Link to confirm the same, along with proof of purchase of the product (such as a copy of the dated purchase invoice for the product) if the product is not registered.
- The customer must obtain a Case ID Number from D-Link Technical Support (USA 1-877-453-5465 or Canada 1-800-361-5265), who will attempt to assist the customer in resolving any suspected defects with the product. If the product is considered defective, the customer must obtain a Return Material Authorization (“RMA”) number by completing the RMA form. Enter the assigned Case ID Number at <https://rma.dlink.com/> (USA only) or <https://rma.dlink.ca> (Canada only).

- After an RMA number is issued, the defective product must be packaged securely in the original or other suitable shipping package to ensure that it will not be damaged in transit, and the RMA number must be prominently marked on the outside of the package. Do not include any manuals or accessories in the shipping package. D-Link will only replace the defective portion of the product and will not ship back any accessories.
- The customer is responsible for all in-bound shipping charges to D-Link. No Cash on Delivery (“COD”) is allowed. Products sent COD will either be rejected by D-Link or become the property of D-Link. Products shall be fully insured by the customer and shipped to D-Link Systems, Inc.
- **USA residents** send to 17595 Mt. Herrmann, Fountain Valley, CA 92708. D-Link will not be held responsible for any packages that are lost in transit to D-Link. The repaired or replaced packages will be shipped to the customer via UPS Ground or any common carrier selected by D-Link. Return shipping charges shall be prepaid by D-Link if you use an address in the United States, otherwise we will ship the product to you freight collect. Expedited shipping is available upon request and provided shipping charges are prepaid by the customer. D-Link may reject or return any product that is not packaged and shipped in strict compliance with the foregoing requirements, or for which an RMA number is not visible from the outside of the package. The product owner agrees to pay D-Link’s reasonable handling and return shipping charges for any product that is not packaged and shipped in accordance with the foregoing requirements, or that is determined by D-Link not to be defective or non-conforming.
- **Canadian residents** send to D-Link Networks, Inc., 2525 Meadowvale Boulevard Mississauga, Ontario, L5N 5S2 Canada. D-Link will not be held responsible for any packages that are lost in transit to D-Link. The repaired or replaced packages will be shipped to the customer via Purolator Canada or any common carrier selected by D-Link. Return shipping charges shall be prepaid by D-Link if you use an address in Canada, otherwise we will ship the product to you freight collect. Expedited shipping is available upon request and provided shipping charges are prepaid by the customer. D-Link may reject or return any product that is not packaged and shipped in strict compliance with the foregoing requirements, or for which an RMA number is not visible from the outside of the package. The product owner agrees to pay D-Link’s reasonable handling and return shipping charges for any product that is not packaged and shipped in accordance with the foregoing requirements, or that is determined by D-Link not to be defective or non-conforming. RMA phone number: 1-800-361-5265 Hours of Operation: Monday-Friday, 9:00AM – 9:00PM EST

What Is Not Covered:

The Limited Warranty provided herein by D-Link does not cover:

Products that, in D-Link’s judgment, have been subjected to abuse, accident, alteration, modification, tampering, negligence, misuse, faulty installation, lack of reasonable care, repair or service in any way that is not contemplated in the documentation for the product, or if the model or serial number has been altered, tampered with, defaced or removed; Initial installation, installation and removal of the product for repair, and shipping costs; Operational adjustments covered in the operating manual for the product, and normal maintenance; Damage that occurs in shipment, due to act of God, failures due to power surge, and cosmetic damage; Any hardware, software, firmware or other products or services provided by anyone other than D-Link; and Products that have been purchased from inventory clearance or liquidation sales or other sales in which D-Link, the sellers, or the liquidators expressly disclaim their warranty obligation pertaining to the product.

While necessary maintenance or repairs on your Product can be performed by any company, we recommend that you use only an Authorized D-Link Service Office. Improper or incorrectly performed maintenance or repair voids this Limited Warranty.

Disclaimer of Other Warranties:

EXCEPT FOR THE LIMITED WARRANTY SPECIFIED HEREIN, THE PRODUCT IS PROVIDED "AS-IS" WITHOUT ANY WARRANTY OF ANY KIND WHATSOEVER INCLUDING, WITHOUT LIMITATION, ANY WARRANTY OF MERCHANTABILITY, FITNESS FOR A PARTICULAR PURPOSE AND NON-INFRINGEMENT.

IF ANY IMPLIED WARRANTY CANNOT BE DISCLAIMED IN ANY TERRITORY WHERE A PRODUCT IS SOLD, THE DURATION OF SUCH IMPLIED WARRANTY SHALL BE LIMITED TO THE DURATION OF THE APPLICABLE WARRANTY PERIOD SET FORTH ABOVE. EXCEPT AS EXPRESSLY COVERED UNDER THE LIMITED WARRANTY PROVIDED HEREIN, THE ENTIRE RISK AS TO THE QUALITY, SELECTION AND PERFORMANCE OF THE PRODUCT IS WITH THE PURCHASER OF THE PRODUCT.

Limitation of Liability:

TO THE MAXIMUM EXTENT PERMITTED BY LAW, D-LINK IS NOT LIABLE UNDER ANY CONTRACT, NEGLIGENCE, STRICT LIABILITY OR OTHER LEGAL OR EQUITABLE THEORY FOR ANY LOSS OF USE OF THE PRODUCT, INCONVENIENCE OR DAMAGES OF ANY CHARACTER, WHETHER DIRECT, SPECIAL, INCIDENTAL OR CONSEQUENTIAL (INCLUDING, BUT NOT LIMITED TO, DAMAGES FOR LOSS OF GOODWILL, LOSS OF REVENUE OR PROFIT, WORK STOPPAGE, COMPUTER FAILURE OR MALFUNCTION, FAILURE OF OTHER EQUIPMENT OR COMPUTER PROGRAMS TO WHICH D-LINK'S PRODUCT IS CONNECTED WITH, LOSS OF INFORMATION OR DATA CONTAINED IN, STORED ON, OR INTEGRATED WITH ANY PRODUCT RETURNED TO D-LINK FOR WARRANTY SERVICE) RESULTING FROM THE USE OF THE PRODUCT, RELATING TO WARRANTY SERVICE, OR ARISING OUT OF ANY BREACH OF THIS LIMITED WARRANTY, EVEN IF D-LINK HAS BEEN ADVISED OF THE POSSIBILITY OF SUCH DAMAGES. THE SOLE REMEDY FOR A BREACH OF THE FOREGOING LIMITED WARRANTY IS REPAIR, REPLACEMENT OR REFUND OF THE DEFECTIVE OR NONCONFORMING PRODUCT. THE MAXIMUM LIABILITY OF D-LINK UNDER THIS WARRANTY IS LIMITED TO THE PURCHASE PRICE OF THE PRODUCT COVERED BY THE WARRANTY. THE FOREGOING EXPRESS WRITTEN WARRANTIES AND REMEDIES ARE EXCLUSIVE AND ARE IN LIEU OF ANY OTHER WARRANTIES OR REMEDIES, EXPRESS, IMPLIED OR STATUTORY.

Governing Law:

This Limited Warranty shall be governed by the laws of the State of California. Some states do not allow exclusion or limitation of incidental or consequential damages, or limitations on how long an implied warranty lasts, so the foregoing limitations and exclusions may not apply. This Limited Warranty provides specific legal rights and you may also have other rights which vary from state to state.

Trademarks:

D-Link is a registered trademark of D-Link Corporation/D-Link Systems, Inc. Other trademarks or registered trademarks are the property of their respective owners.

Copyright Statement:

No part of this publication or documentation accompanying this product may be reproduced in any form or by any means or used to make any derivative such as translation, transformation, or adaptation without permission from D-Link Corporation/D-Link Systems, Inc., as stipulated by the United States Copyright Act of 1976 and any amendments thereto. Contents are subject to change without prior notice.

Copyright ©2012 by D-Link Corporation/D-Link Systems, Inc. All rights reserved.

CE Mark Warning:

This is a Class B product. In a domestic environment, this product may cause radio interference, in which case the user may be required to take adequate measures.

FCC Statement:

This equipment has been tested and found to comply with the limits for a Class B digital device, pursuant to part 15 of the FCC Rules. These limits are designed to provide reasonable protection against harmful interference in a residential installation. This equipment generates, uses, and can radiate radio frequency energy and, if not installed and used in accordance with the instructions, may cause harmful interference to radio communication. However, there is no guarantee that interference will not occur in a particular installation. If this equipment does cause harmful interference to radio or television reception, which can be determined by turning the equipment off and on, the user is encouraged to try to correct the interference by one or more of the following measures:

- Reorient or relocate the receiving antenna.
- Increase the separation between the equipment and receiver.
- Connect the equipment into an outlet on a circuit different from that to which the receiver is connected.
- Consult the dealer or an experienced radio/TV technician for help.

FCC Caution:

Any changes or modifications not expressly approved by the party responsible for compliance could void the user's authority to operate this equipment.

This device complies with Part 15 of the FCC Rules. Operation is subject to the following two conditions:

- (1) This device may not cause harmful interference, and
- (2) this device must accept any interference received, including interference that may cause undesired operation.

If this device is going to be operated in 5.15 ~ 5.25GHz frequency range, then it is restricted in indoor environment only.

IMPORTANT NOTICE:

FCC Radiation Exposure Statement:

This equipment complies with FCC radiation exposure limits set forth for an uncontrolled environment. This equipment should be installed and operated with minimum distance 20cm between the radiator & your body. This transmitter must not be co-located or operating in conjunction with any other antenna or transmitter.

The availability of some specific channels and/or operational frequency bands are country dependent and are firmware programmed at the factory to match the intended destination. The firmware setting is not accessible by the end user.

For detailed warranty information applicable to products purchased outside the United States, please contact the corresponding local D-Link office.

Industry Canada Statement:

This device complies with RSS-210 of the Industry Canada Rules. Operation is subject to the following two conditions:

- (1) This device may not cause harmful interference, and
- (2) this device must accept any interference received, including interference that may cause undesired operation.

IMPORTANT NOTE:

Radiation Exposure Statement:

This equipment complies with Canada radiation exposure limits set forth for an uncontrolled environment. This equipment should be installed and operated with minimum distance 20cm between the radiator and your body.

This device has been designed to operate with an antenna having a maximum gain of 2 dB. Antenna having a higher gain is strictly prohibited per regulations of Industry Canada. The required antenna impedance is 50 ohms.

Registration

Register your product online at registration.dlink.com



Product registration is entirely voluntary and failure to complete or return this form will not diminish your warranty rights.

Version 1.0
December 23, 2011