



# User Manual

## Full HD Mini Pan & Tilt Dome Network Camera

DCS-5615

---

# Preface

D-Link reserves the right to revise this publication and to make changes in the content hereof without obligation to notify any person or organization of such revisions or changes.

## Manual Revisions

| Revision | Date              | Description                                     |
|----------|-------------------|---|
| 1.0      | December 31, 2013 | DCS-5615 Revision A1 with firmware version 1.00 |
| 1.01     | April 22, 2014    | DCS-5615 Revision A1 with firmware version 1.01 |
| 1.02     | March 12, 2015    | Minor Changes                                   |

## Trademarks

D-Link and the D-Link logo are trademarks or registered trademarks of D-Link Corporation or its subsidiaries in the United States or other countries. All other company or product names mentioned herein are trademarks or registered trademarks of their respective companies.

Copyright © 2015 by D-Link Corporation.

All rights reserved. This publication may not be reproduced, in whole or in part, without prior expressed written permission from D-Link Corporation.

---

# Table of Contents

|                                       |           |  |           |
|---------------------------------------|-----------|--|-----------|
| <b>Product Overview</b> .....         | 4         | Dynamic DNS .....                                  | 39        |
| Package Contents .....                | 4         | HTTPS .....  | 40        |
| System Requirements .....             | 4         | Access List.....                                   | 42        |
| Introduction.....                     | 5         | Advanced Settings.....                             | 44        |
| Features .....                        | 6         | Event Management.....                              | 48        |
| Hardware Overview .....               | 7         | Motion Detection.....                              | 48        |
| Hardware Installation.....            | 9         | Tamper Detection .....                             | 49        |
| Hardware Installation.....            | 10        | DI .....   | 50        |
|                                       |           | Event Settings.....                                | 51        |
| <b>Installation</b> .....             | <b>11</b> | Recording .....                                    | 58        |
| Hardware Installation.....            | 11        | Recording Settings.....                            | 58        |
| Configuration with Wizard.....        | 12        | Local Storage.....                                 | 60        |
| Web-based Configuration Utility ..... | 17        | PTZ Control .....                                  | 61        |
|                                       |           | Mechanical Pan Tilt.....                           | 61        |
| <b>Configuration</b> .....            | <b>19</b> | User Customization .....                           | 62        |
| Live Video.....                       | 19        | Live Video Page Configuration .....                | 62        |
| Client Setup .....                    | 23        | HTML Code Examples.....                            | 63        |
| Setup .....                           | 24        | System.....  | 64        |
| Basic Setup.....                      | 24        | User Settings .....                                | 64        |
| Advanced Setup .....                  | 25        | Device Settings.....                               | 65        |
| System Overview.....                  | 26        | Time and Date .....                                | 66        |
| Video.....                            | 27        | Maintenance .....                                  | 67        |
| Video Settings.....                   | 27        | Parameter List.....                                | 69        |
| Image Settings.....                   | 30        | Logs .....   | 70        |
| Audio Settings.....                   | 32        |  |           |
| Network.....                          | 33        | <b>Appendix A - Technical Specifications</b> ..... | <b>71</b> |
| IP Settings.....                      | 33        | Technical Specifications .....                     | 71        |
| Port and Access Name Settings .....   | 36        |  |           |

# Package Contents



DCS-5615 Network Camera



Mount Bracket



Ethernet Extension Adapter (RJ-45 Coupler)



CD-ROM with User Manual and Software



Power Adapter



Mounting Screws



Quick Install Guide



Alignment Sticker

If any of the above items are missing, please contact your reseller.

# System Requirements

- Operating System: Windows® 8, 7, or Vista®
- Memory: At least 256MB of memory (512MB recommended)
- Web Browser: Internet Explorer 7 or higher
- VGA card resolution: SVGA or XGA (1024x768 or above)
- CPU: 1.7GHz or above (2.8GHz plus processor with 512MB memory and a 32MB video card is required for multiple camera viewing and recording in IP surveillance program)
- An available Ethernet connection

# Introduction

D-Link DCS-5615 is a dome camera equipped with industry-leading high definition (Full HD) megapixel resolution and H.264 compression that enables high-quality video to be viewed or recorded. The DCS-5615 connects to a network to provide high-quality live video over the Internet. The motorized pan/tilt controls and 16x digital zoom allow you to monitor a large area and zoom to view fine detail.

The built-in microSD card slot can be used as a local backup by storing important events on an easily retrievable microSD card.

The included D-Link D-ViewCam™ is sophisticated software which allows users to manage up to 32 network cameras, set e-mail alert notifications, create recording schedules, and use motion detection to record directly to a hard drive. D-ViewCam™ also allows users to upload a floor plan to create a realistic layout of the premises where cameras are located, further simplifying the management process.

# Features

## **Full HD Surveillance**

The DCS-5615 delivers Full HD 16:9 widescreen IP video surveillance which provides vivid high-quality video, making it easier to view and monitor video. With the included D-ViewCam 32-channel recording software, the DCS-5615 provides a complete solution for high-quality live viewing and reliable recording. The camera also has a built-in microSD card slot which can be used for local backup by storing important events on an easily retrievable microSD card.

## **Multiple Video Streams**

The DCS-5615 supports simultaneous streaming of H.264, MPEG-4, and MJPEG video to provide both high-quality and bandwidth-efficient compression formats. H.264 produces a small file size, making it useful for extended recording with high detail or for use in low bandwidth networks. MJPEG delivers excellent file integrity, ideal for situations which require extensive image detail. Additionally, the DCS-5615 supports multicast H.264 streaming, allowing users to view the camera feed by subscribing to a multicast IP address on the network.

## **Sharp Image Monitoring from Different Angles**

With accurate, responsive pan/tilt movement and digital zoom, the DCS-5615 gives you full control, so you can quickly scan a wide area from a variety of angles, and 16x digital zoom lets you zoom in on specific areas for more detail. The DCS-5615 can also be set to automatically move to specific preset positions, allowing the camera to patrol particular areas of interest within a surveillance area.

# Hardware Overview

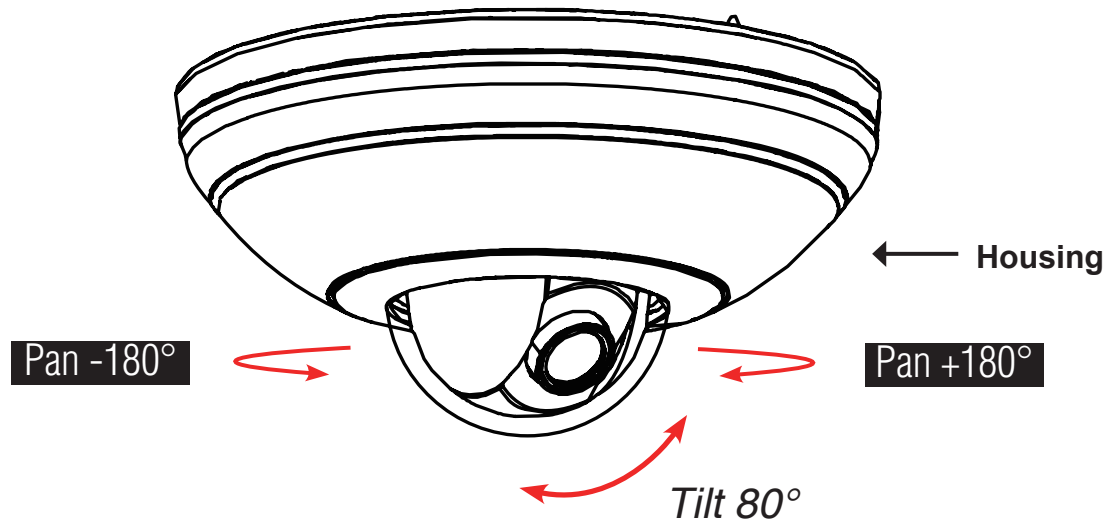

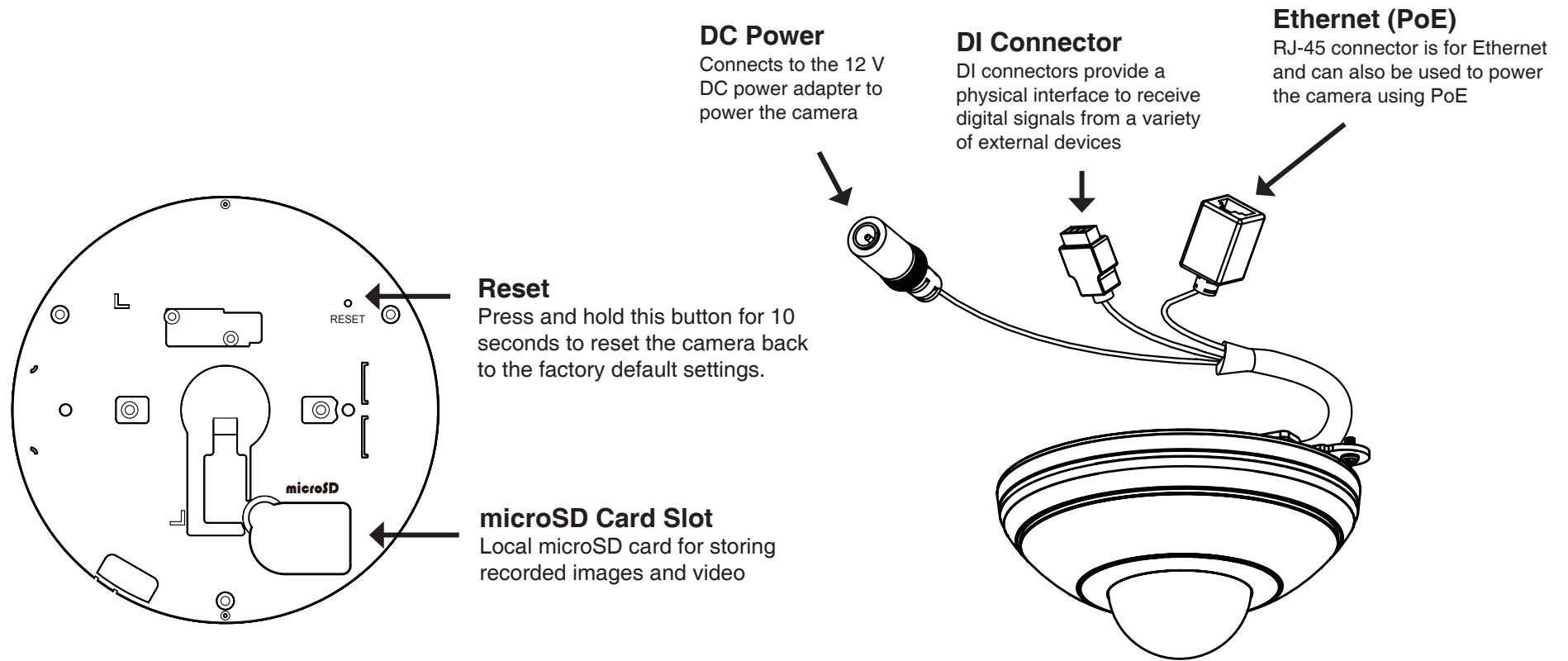



# Hardware Installation

Remove the microSD card plastic cover on the bottom.

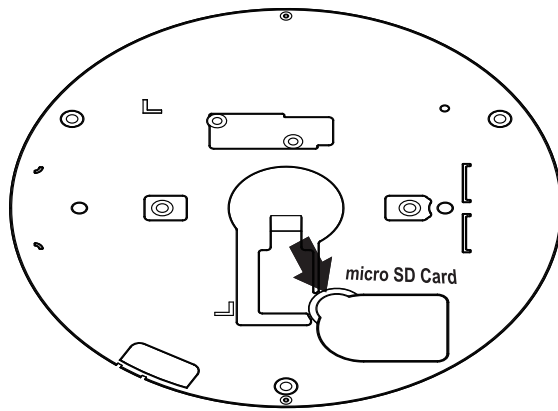

Slide the card socket forward and then flip up.

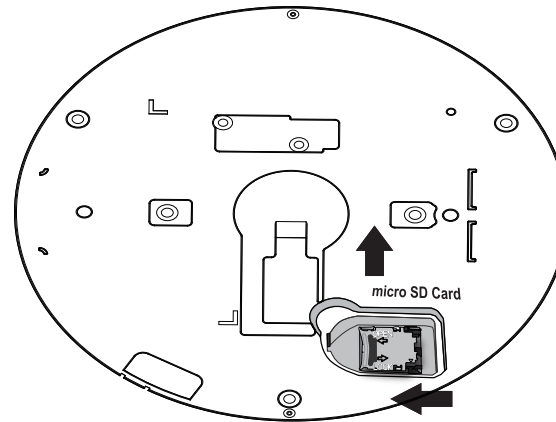

Insert a microSD card into the card socket. Press the card socket down and slide back to lock into place. Attach the plastic cover by pressing it back to its original position.

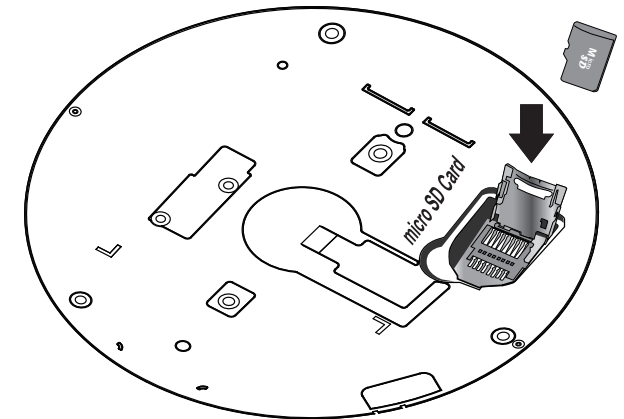

# Hardware Installation

1. Locate an area on the ceiling or wall which is capable of supporting the weight of the camera.
2. Attach the alignment sticker to the ceiling or wall.
3. Drill three pilot holes where the holes of the alignment sticker are located.
4. Insert the supplied plastic anchors into the drilled holes and install "Plate A" with the three large screws.
5. Attach "Plate B" to the bottom of the camera and secure it with two smaller screws.
6. Slide the Camera into "Plate A"
7. Secure the camera to the "Plate A" with a small screw.

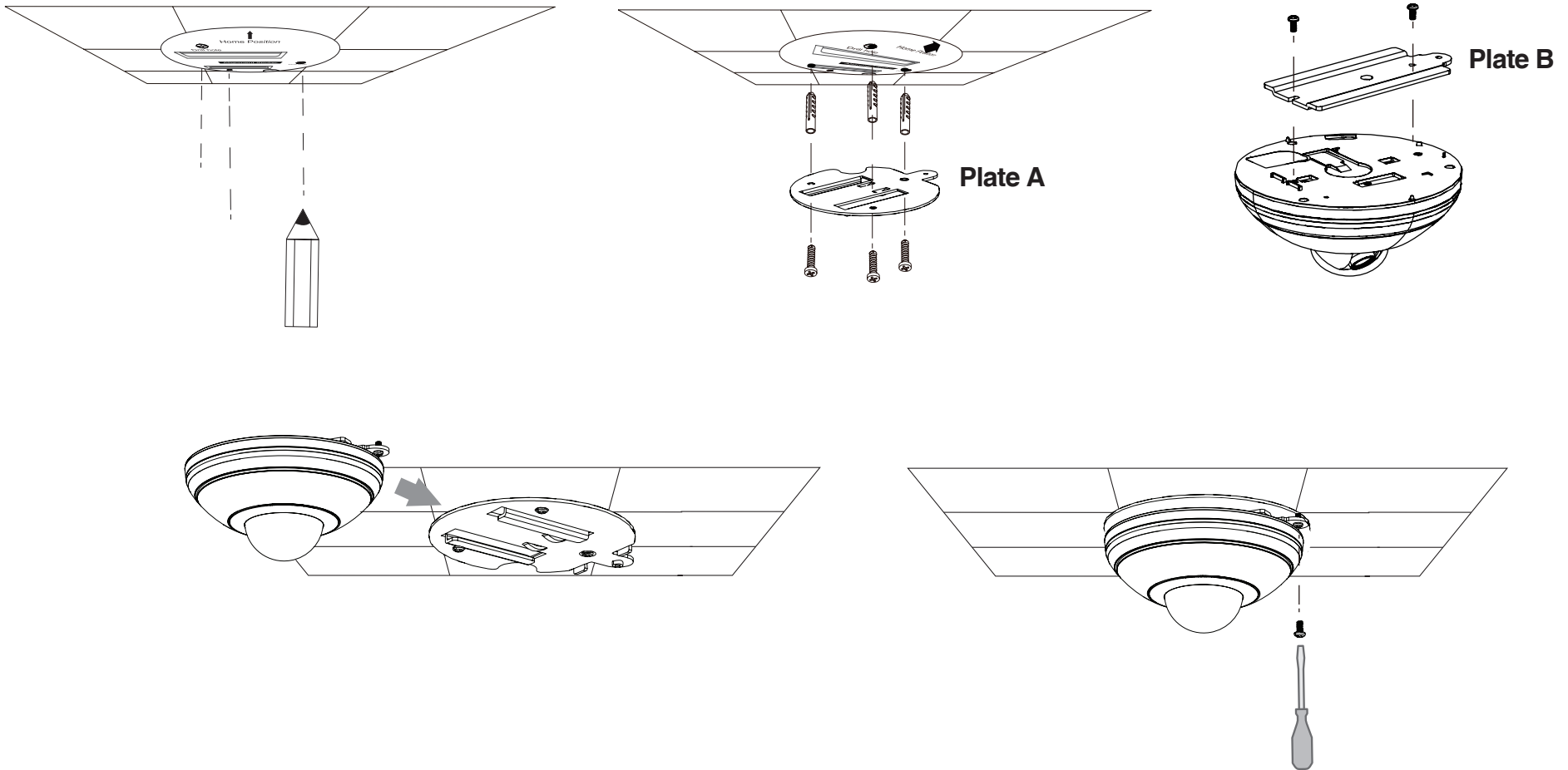

# Hardware Installation

## General Connection (without PoE)

Connect the network camera to a switch or router via an Ethernet cable and then connect the supplied power cable from the camera to a power outlet.

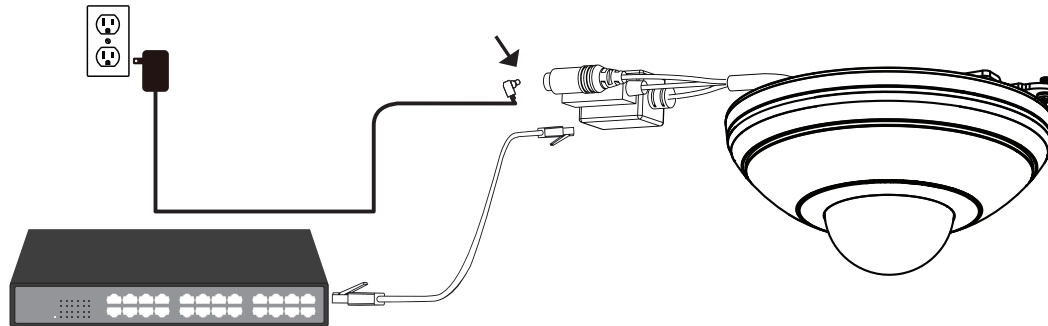

## Connection with a PoE Switch

Connect the network camera to a PoE switch via an Ethernet cable, which will provide both power and data transmission over a single cable.

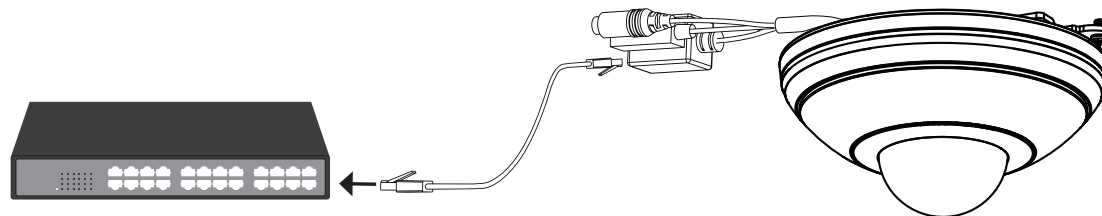

# Configuration with Wizard

Insert the DCS-5615 CD into your computer's CD-ROM drive to begin the installation. If the Autorun function on your computer is disabled, or if the D-Link Launcher fails to start automatically, click **Start > Run**. Type **D:\autorun.exe**, where D: represents the drive letter of your CD-ROM drive.

Click **Setup Wizard** to begin the installation.



After clicking Setup Wizard, the following window will open.

Click **Next** to continue.

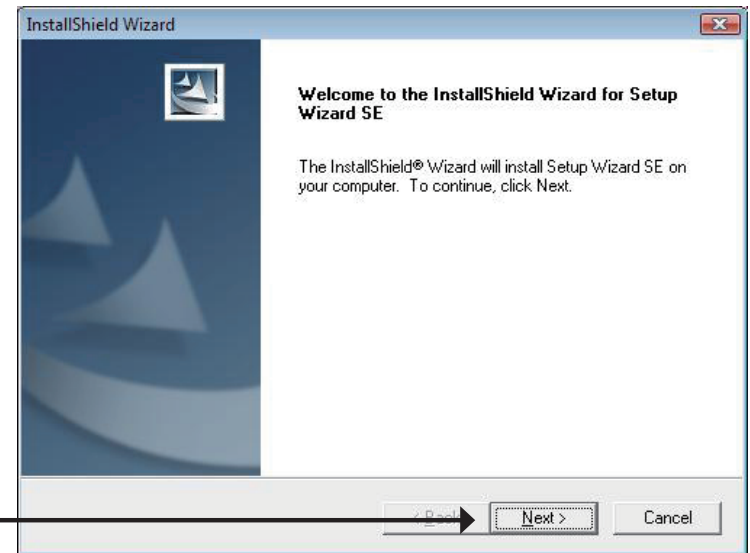

Click **Yes** to accept the License Agreement.

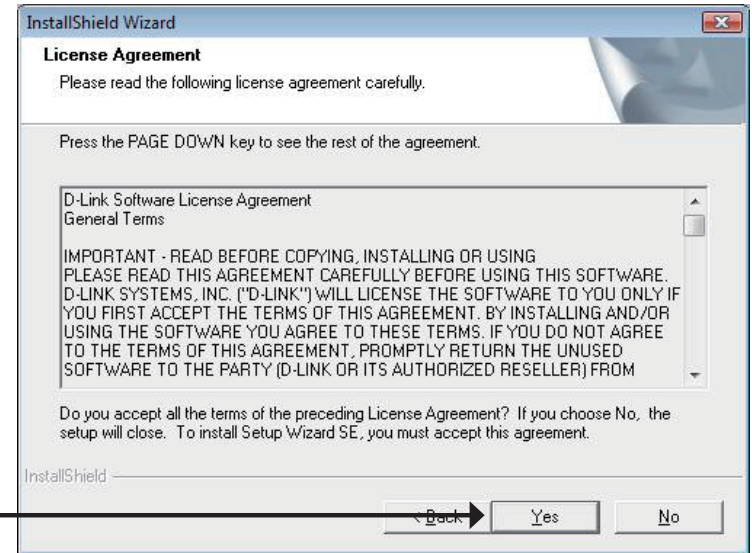

To start the installation process, click **Next**.

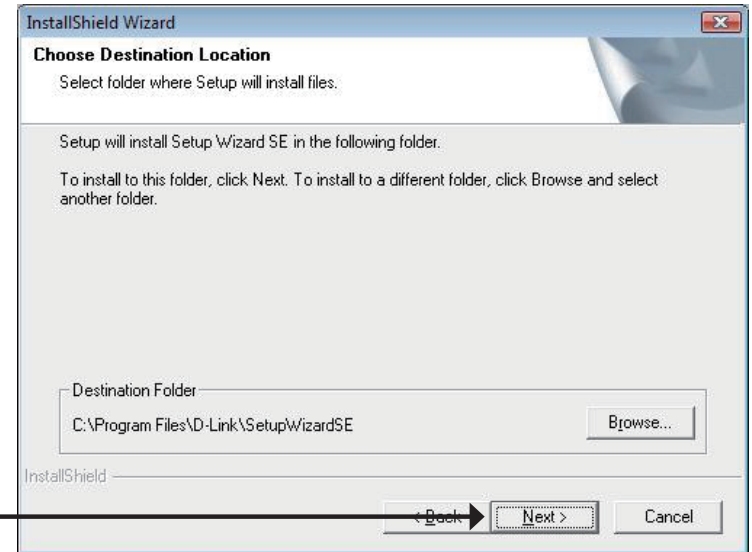

**Note:** The installation may take several minutes to finish.

Click **Finish** to complete the installation.

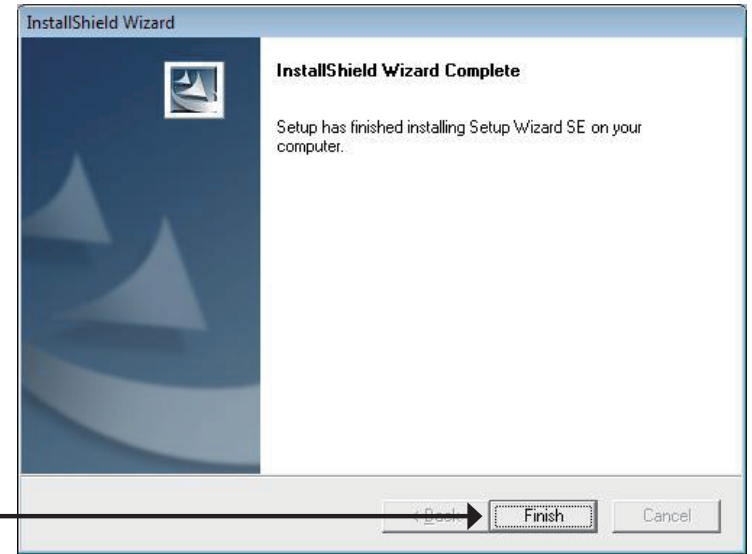

Click on the **D-Link Setup Wizard SE** icon that was created in your Windows Start menu.

**Start > D-Link > Setup Wizard SE**

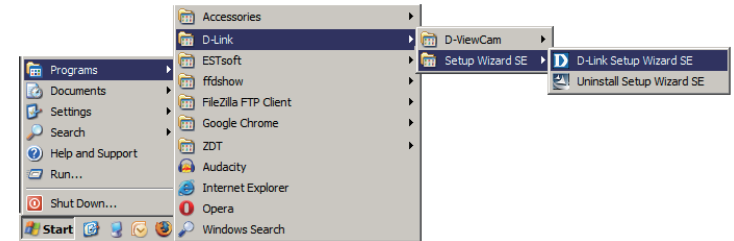

## Installation

The Wizard screen will appear which will display the MAC address and IP address of your camera(s). If you have a DHCP server on your network, a valid IP address will be displayed. If your network does not use a DHCP server, the network camera's default static IP **192.168.0.20** will be displayed.

Select the camera you want to configure and click the **Wizard** button to continue.

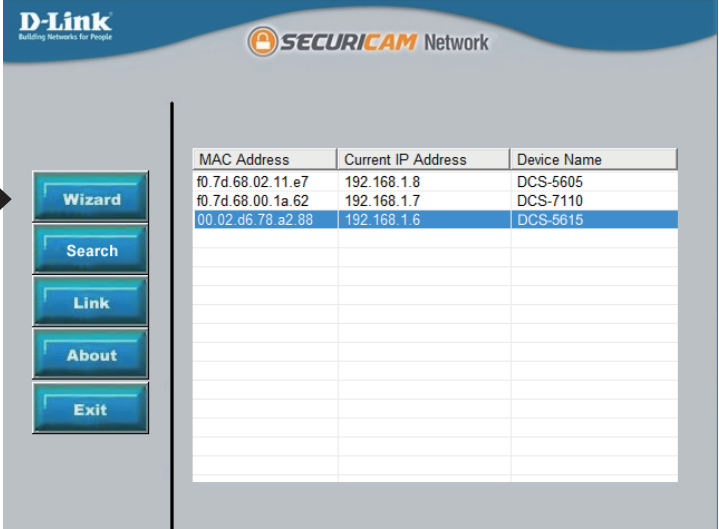

| MAC Address       | Current IP Address | Device Name |
|-------------------|--------------------|-------------|
| f0.7d.68.02.11.e7 | 192.168.1.8        | DCS-5605    |
| f0.7d.68.00.1a.62 | 192.168.1.7        | DCS-7110    |
| 00.02.d6.78.a2.88 | 192.168.1.6        | DCS-5615    |
|                   |                    |             |
|                   |                    |             |
|                   |                    |             |
|                   |                    |             |
|                   |                    |             |
|                   |                    |             |
|                   |                    |             |
|                   |                    |             |
|                   |                    |             |
|                   |                    |             |
|                   |                    |             |
|                   |                    |             |
|                   |                    |             |
|                   |                    |             |
|                   |                    |             |

Enter the Admin ID and password. When logging in for the first time, the default Admin ID is **admin** with the password left blank.

Click **Next** to proceed to the next page.



Set up an Admin ID and Password to secure your camera.  
Click Next to continue.

Admin ID  Password

Change

New ID  New Password

Reconfirm  Reconfirm

Select **DHCP** if your camera obtains an IP address automatically from a DHCP server (e.g., router). Select **Static IP** if you want to manually enter the IP settings for the camera.

Click **Next** to proceed to the next page.

D-Link Building Networks for People

SECURICAM Network

### Set IP Address

DHCP

Static IP

IP Address

Subnet Mask

Default Gateway

Primary DNS

Secondary DNS

Take a moment to confirm your settings and click **Restart**.

D-Link Building Networks for People

SECURICAM Network

Admin ID

Password

IP Address

Subnet Mask

Primary DNS

Secondary DNS

The Setup Wizard has completed. Click on 'Back' to modify your settings. Click 'Restart' to save your current settings and reboot the Internet Camera.



# Web-based Configuration Utility

This section explains how to configure your new D-Link Network Camera using the Web-based Configuration Utility.

Click on the **D-Link Setup Wizard SE** icon that was created in your Windows Start menu.

**Start > D-Link > Setup Wizard SE**

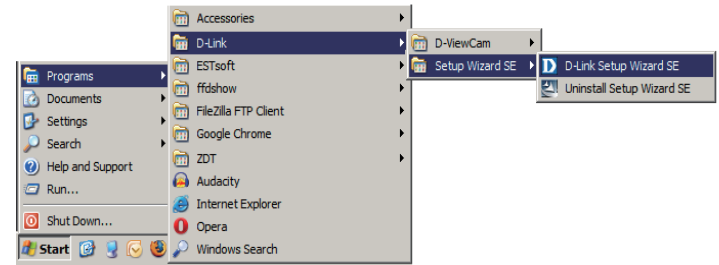

Select a camera and click the **Link** button to access the web configuration.

The Setup Wizard will automatically open your web browser to the IP address of the camera.



Alternatively, you may manually open a browser and enter the IP address of the camera: **192.168.0.20**

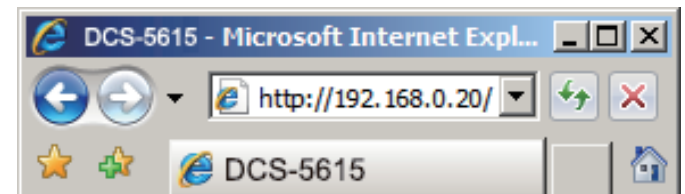

Enter **admin** as the default username and leave the password blank.

Click **OK** to continue.

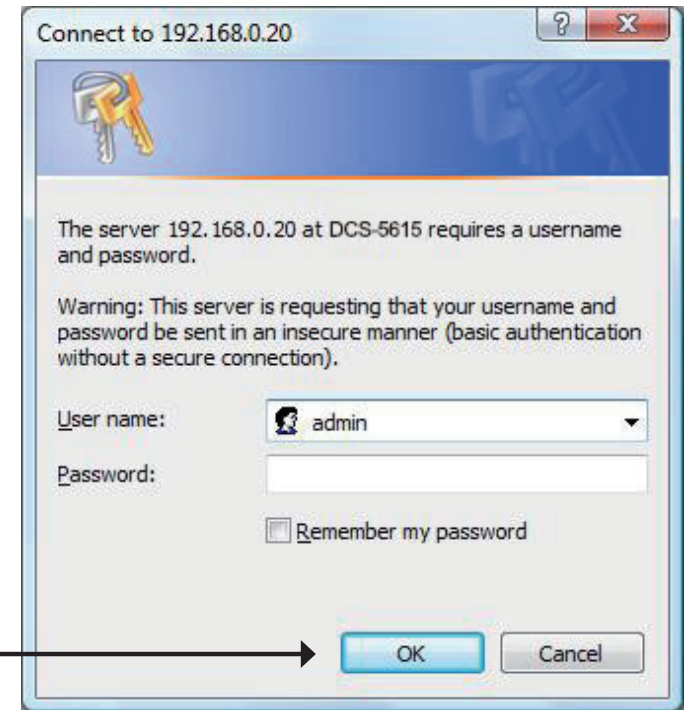



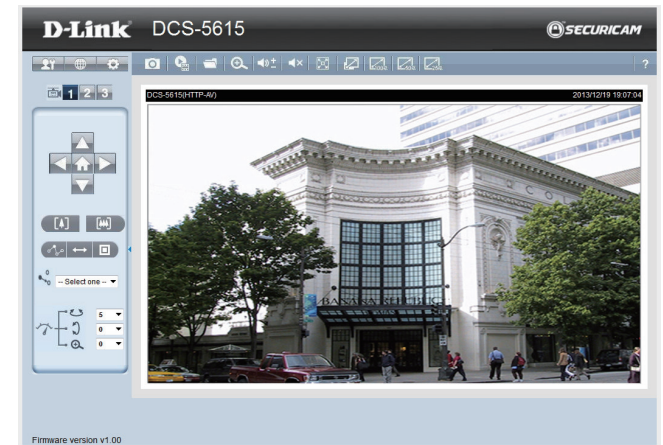



This section displays your camera's live video. You can select your video profile and view or operate the camera.

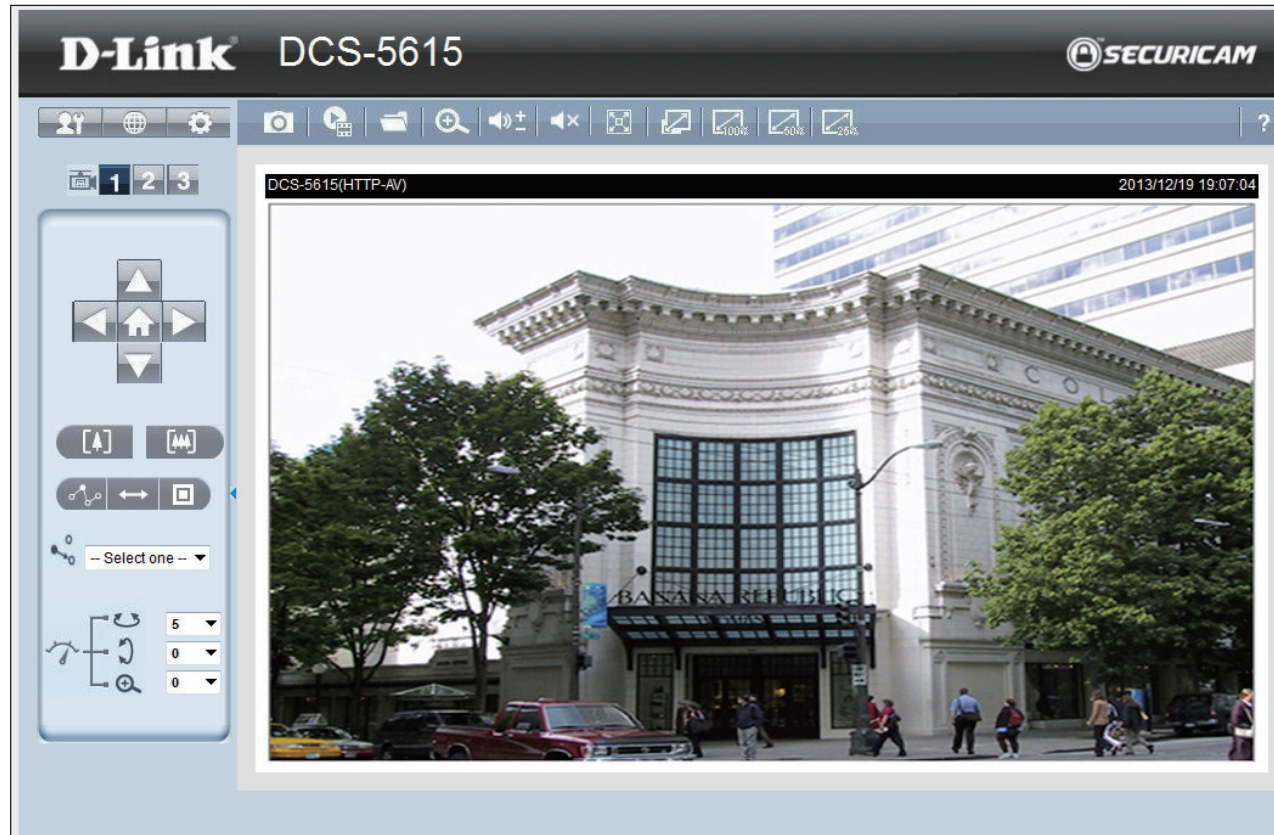











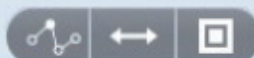

# Live Video

When you connect to the camera's web interface you will see the following page. This is the Live Video page which will allow you to view the camera's video feed and control basic camera functions using the icons on the screen. Please refer to the tables on the following pages for detailed information about the icons on this screen.



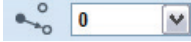
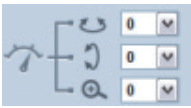







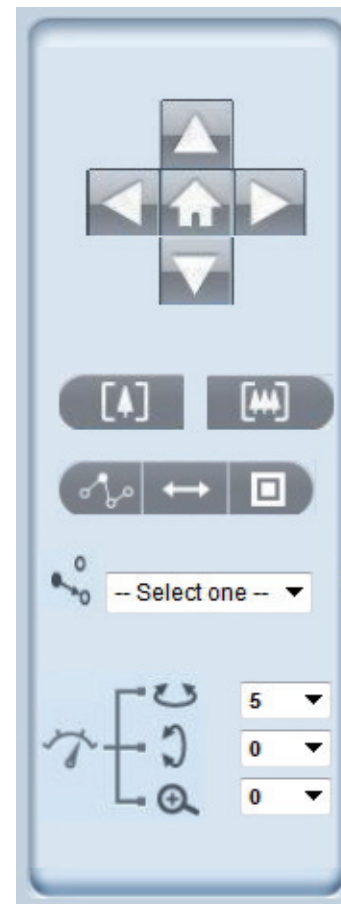

|  |   |
|--|---|
|  <p><b>D-Link Logo</b></p>  <p><b>Securicam Logo</b></p> | <p>Click this logo to visit the D-Link website. The logos and website can be customized to fit your needs. For more information, please refer to User Customization on page 62.</p>   |
|  <p><b>Client Settings</b></p>  | <p>Setup the stream transmission mode and save options on your local computer.</p>  |
|  <p><b>Language</b></p>   | <p>Select this option to adjust the language settings.</p>  |
|  <p><b>Setup</b></p>  | <p>Click on the setup icon from the main page to enter the camera settings page. Note that only Administrators can access the setup page. To simplify the setting procedure, two types of user interfaces are available: <b>Advanced Setup</b> for professional users and <b>Basic Setup</b> for entry-level users.</p> |
|  <p><b>Video Stream</b></p>   | <p>This camera supports multiple streams (stream 1 ~ 3) simultaneously. You may select one for live viewing.</p>  |



|  |  |
|--|--|
|  <p><b>Pan Tilt Direction</b></p> | <p><b>Home:</b> Move the camera to the preset home position.</p> <p><b>Direction:</b> Control the camera's pan and tilt directions (up/down/left/right).</p>   |
|  <p><b>Zoom</b></p>               | <p>Zoom in/out to magnify or shrink the digital image.</p> <p> <b>Zoom in:</b> Magnify image</p> <p> <b>Zoom out:</b> Diminish image</p>   |
|  <p><b>Patrol Auto Pan</b></p>    | <p> <b>Patrol:</b> Patrol executes a pre-defined sequence of pan, tilt, zoom, and focus positions. Before selecting this, you must define at least two preset points.</p> <p> <b>Auto Pan:</b> Auto Pan automatically scans an area horizontally.</p> <p> <b>Stop:</b> Select to stop the Patrol or Auto Pan feature.</p> |
|  <p><b>Go Preset</b></p>          | <p>Select from the preset drop-down list to quickly move the camera to the desired preset position.</p>  |
|  <p><b>Speed Control</b></p>      | <p>Control Pan/Tilt/Zoom speed</p> <p> <b>Pan Speed Control</b></p> <p> <b>Tilt Speed Control</b></p> <p> <b>Zoom Speed Control</b></p>   |

**Pan Tilt Control Panel**



| <h1>Camera Control</h1>    |   |
|--|---|
| <br><b>Snapshot</b>         | <p>Click this button to capture and save still images. The captured images will be displayed in a pop-up window. Right-click the image and choose Save Picture As to save it in JPEG (*.jpg) or BMP (*.bmp) format.</p>   |
| <br><b>Recording</b>        | <p>Click this button to record video clips to your computer. When you exit the web browser, video recording stops automatically.</p>  |
| <br><b>Recording Folder</b> | <p>Click to specify a storage destination for the recorded video files.</p>   |
| <br><b>Digital Zoom</b>     | <p>Click and uncheck "Disable digital zoom" to enable the zoom operation. The navigation screen indicates the part of the image being magnified. To control the zoom level, drag the slider bar. To move to a different area you want to magnify, drag the navigation screen.</p> |
| <br><b>Speaker Volume</b>   | <p>Speaker Volume - When the mute function is not active, move the slider bar to adjust the volume of the speakers that are connected to your network camera.</p>   |
| <br><b>Speaker Mute</b>     | <p>Speaker Mute/Un-mute: Click to mute the external speaker that is connected to the network camera. Press again to un-mute the speaker.</p>  |
| <br><b>Full Screen</b>      | <p>Click this button to switch to full screen mode. Press the "Esc" key to switch back to normal mode.</p>  |
| <br><b>Zoom ratio</b>       | <p><b>Auto:</b> The video zoom ratio will be changed automatically according to viewing window size.<br/> <b>100%:</b> Keep the video zoom ratio at 100%<br/> <b>50%:</b> Keep the video zoom ratio at 50%<br/> <b>25%:</b> Keep the video zoom ratio at 25%</p>                  |
| <br><b>Help</b>           | <p>Click the Help button to learn the detailed information regarding camera setup and solve any problems you encounter.</p>   |

# Client Setup

Click the Client Settings button  to bring you to the following screen which allows you to configure the basic protocol options for your camera.

## H.264/MPEG4 Media Options

Video and Audio can be viewed at the same time or separately.

## H.264/MPEG4 Protocol Options

For additional information about streaming options please refer to page 41.

**UDP Unicast:** Stream to a single computer.

**UDP Multicast:** Stream to multiple computers using multicast streaming.

**TCP:** Provides higher quality video streaming than UDP and provides error correction. However, transmission speed will be reduced.

**HTTP:** Offers the highest image and video quality. However, packet loss will diminish image quality when bandwidth becomes restricted. If the network is protected by a firewall and it opens only HTTP port (80), HTTP protocol must be selected. In this mode, audio is disabled and only video can be viewed. UDP connections will not be available to remote users if all four ports have not been forwarded (as shown on page 46). Only the HTTP port must be forwarded for remote users to make an HTTP connection (video only).

## MP4 Saving Options

**Folder:** Select the folder where you would like the MP4 file saved on your computer.

**File name prefix:** Enter a file name prefix for the MP4 files.

**Add date and time suffix to file name:** Select this checkbox if you would like the date and time to be added to the end of each filename.

## Local Streaming Buffer Time

Enter the buffer time in milliseconds. The buffer will cause a slight delay between live activity and the video of the live stream but may increase the quality of video.

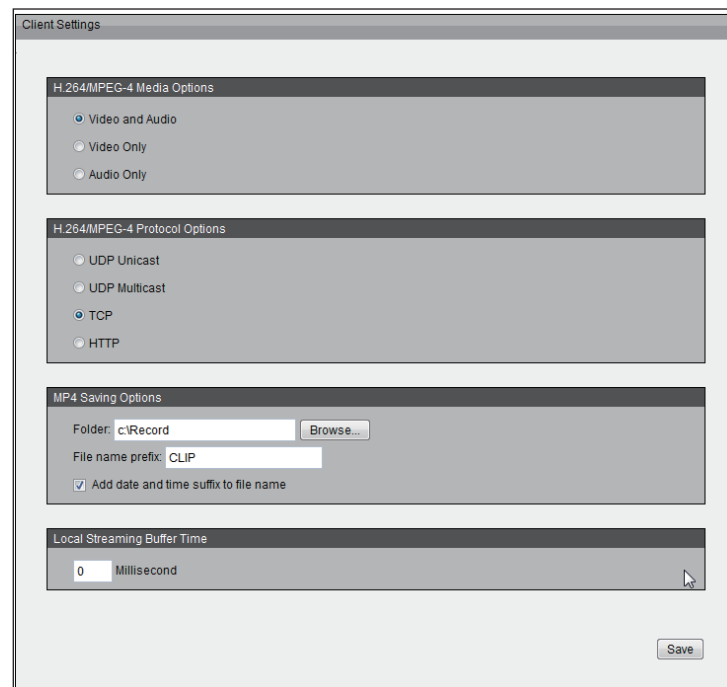

The screenshot shows the 'Client Settings' window with the following sections:

- H.264/MPEG-4 Media Options:** Radio buttons for 'Video and Audio' (selected), 'Video Only', and 'Audio Only'.
- H.264/MPEG-4 Protocol Options:** Radio buttons for 'UDP Unicast', 'UDP Multicast', 'TCP' (selected), and 'HTTP'.
- MP4 Saving Options:** A 'Folder' field with 'c:\Record' and a 'Browse...' button; a 'File name prefix' field with 'CLIP'; and a checked checkbox for 'Add date and time suffix to file name'.
- Local Streaming Buffer Time:** A numeric input field with '0' and a 'Millisecond' label.

A 'Save' button is located at the bottom right of the window.

# Setup

The DCS-5615 includes basic and advanced setup screens. Both screens include a tree view with multiple setup options. This manual includes detailed explanations for all advanced setup screens.

## Basic Setup

Click the **Setup** button to enter the setup screen. 

Click on the **Basic** button to enter the setup screen. 

Please click the [+] next to each folder to view the options.

Basic setup includes the following options:

### **System Overview**

### **Audio and Video**

- Video Settings, Audio Settings

### **Network**

- IP Settings

### **Event Management**

- Motion Detection, Tamper Detection

### **PTZ Control**

- Mechanical PT, Calibrate

### **System**

- User Settings, Device Settings, Time and Date, Maintenance

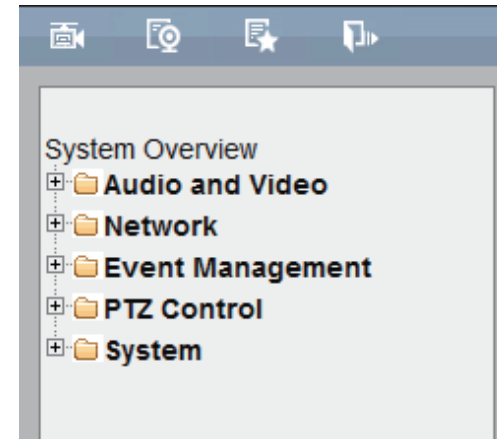



# Advanced Setup

Click the **Setup** button to enter the setup screen. 

Click on the **Advanced** button to enter the setup screen. 

Please click the [+] next to each folder to expand the options.

Advanced setup includes the following options:

## **System Overview**

### **Audio and Video**

- Video Settings, Image Settings, Audio Settings

### **Network**

- IP Settings, Port & Access Name Settings, Dynamic DNS, HTTPS, Access List, Advanced Settings

### **Event Management**

- Motion Detection, Tamper Detection, DI, Event Settings

### **Recording**

- Recording Settings, Local Storage

### **PTZ Control**

- Mechanical PT, Calibrate

### **User Customization**

- Live Video Page Config, HTML Code Examples

### **System**

- User Settings, Device Settings, Time and Date, Maintenance, Parameter List, Logs

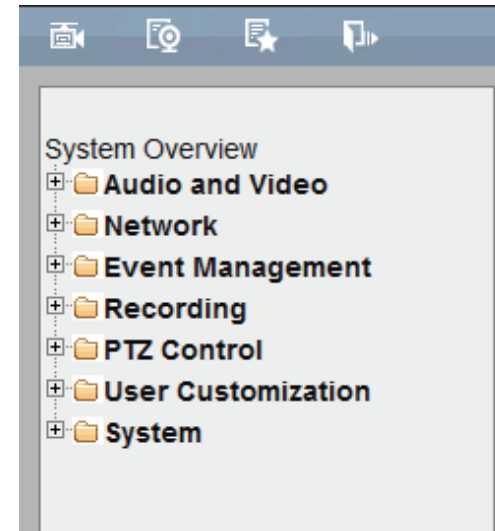

# System Overview

The system overview page displays a summary of the camera's current settings. For more information about adjusting these settings, please consult the subsequent instructions found in this manual.

**D-Link DCS-5615** SECURICAM

192.168.1.77

### System Overview

- System Overview
- Audio and Video
- Network
- Event Management
- Recording
- PTZ Control
- User Customization
- System

#### Device Information

|                          |                  |
|--------------------------|------------------|
| IP address               | 192.168.1.77     |
| Link-local address       | 169.254.15.96    |
| Current firmware version | v1.00.05         |
| Current firmware date    | 20 Dec 2013      |
| MAC address              | F97D 68 0F 0F 60 |
| Connect client           | 0                |

#### Time and Date

|                     |                             |
|---------------------|-----------------------------|
| Current system time | 30 Dec 2013 17:13:22        |
| System up time      | 0 Days, 0 Hours, 53 Minutes |
| Time mode           | NTP                         |

#### Service Status

| Service              | Enabled / Disabled | Protocol | Server port |
|----------------------|--------------------|----------|-------------|
| HTTP                 | Enable             | TCP      | 80          |
| Secondary HTTP       | Enable             | TCP      | 8080        |
| HTTPS                | Disable            | TCP      | 443         |
| FTP                  | Enable             | TCP      | 21          |
| RTSP                 | Enable             | TCP      | 554         |
| UPnP presentation    | Enable             | -        | -           |
| UPnP port forwarding | Disable            | -        | -           |
| 802.1x               | Enable             | -        | -           |
| CoS                  | Disable            | -        | -           |
| QoS / DSCP           | Disable            | -        | -           |
| SNMP                 | Disable            | -        | -           |
| DDNS                 | Disable            | -        | -           |
| Access list          | Disable            | -        | -           |

#### Stream Status

| Stream number | Codec type | Resolution | Max Frame Rate | Bitrate / Quality |
|---------------|------------|------------|----------------|-------------------|
| Stream 1      | H.264      | 1920x1080  | 30             | 3 Mbps            |
| Stream 2      | H.264      | 1280x720   | 30             | 3 Mbps            |
| Stream 3      | H.264      | 1920x1080  | 30             | 3 Mbps            |

#### Recent Logs

```

Dec 30 16:20:22 syslogd 1.5.0: restart.
Dec 30 16:20:22 [EVENT MGR]: Starting eventMgr with support for Ectun
Dec 30 16:20:23 [EVENT MGR]: Task conf file: there is no valid event in recording_task.xml, stop it
Dec 30 16:20:23 [EVENT MGR]: Task conf file: there is no valid event in event_task.xml, stop it
Dec 30 16:20:30 [swatcdlog]: Ready to watch vencslave1
Dec 30 16:20:30 [swatcdlog]: Ready to watch vencslave2
Dec 30 16:20:32 [swatcdlog]: Ready to watch configer
Dec 30 16:20:32 [ectun]: receiver value of s-path: "camctrl_c0_isptz" from configer failed!
Dec 30 16:20:32 [ectun]: GetNotify parameter "camctrl_c0_isptz" value failed
Dec 30 16:20:40 udhcpc: deconfig
Dec 30 16:20:40 udhcpc: IP: 192.168.0.20
Dec 30 16:20:52 [swatcdlog]: Ready to watch hmpd
Dec 30 16:20:54 [swatcdlog]: Ready to watch recorder
Dec 30 16:20:56 [swatcdlog]: Ready to watch rtsp.
Dec 30 16:20:56 [RTSP SERVER]: Removing clients for stream 1 due to codec change!
Dec 30 16:20:56 [RTSP SERVER]: Removing clients for stream 2 due to codec change!
Dec 30 16:20:56 [RTSP SERVER]: Removing clients for stream 3 due to codec change!
Dec 30 16:20:57 [DRM Service]: Starting DRM service
Dec 30 16:20:57 automount[1594]: @/usr/lib/autofs/!mount_vfat.so
Dec 30 16:20:57 automount[1594]: 1
unavailable
Dec 30 16:22:38 [Chronos]: Sync with NTP server failed!
Dec 30 16:22:43 [RTSP SERVER]: RTSP socket 44 error, code: 1041
Dec 30 16:22:50 [RTSP SERVER]: RTSP socket 45 error, code: 1041
Dec 30 16:22:50 [RTSP SERVER]: RTSP socket 44 error, code: 1041
Dec 30 16:22:53 [RTSP SERVER]: RTSP socket 46 error, code: 1041
    
```

# Video

## Video Settings

This page allows you to set up three video streams to be displayed on a computer, mobile device, or storage system. Each stream has independent options for proper compression type, frame size, frame rate to optimize the bandwidth utilization, and video quality.

### Video Options

**Viewing Window:** The camera supports multiple streams with frame size ranging from 384 x 216 to 1920 x 1080. Click **Viewing Window** to open the viewing region setting page. On this page, you can set the Region of Interest (ROI) and the Output Frame Size for stream 1~3. Please follow the steps below to set up a stream:

1. Select a stream whose viewing region you would like to set.
2. Select a Region of Interest from the drop-down list, the floating frame will resize accordingly. If you want to set up a customized viewing region, you can also resize and drag the floating frame to a desired position with your mouse.
3. Choose a proper Output Frame Size from the drop-down list according to the size of your monitoring device.

**Note:** All the values in the “Output Frame Size” should not be greater than the “Region of Interest “(current maximum resolution).

The definition of multiple streams:

**Stream 1-3:** Users can define the "Region of Interest" (viewing region) and the "Output Frame Rate" (size of the live view window).

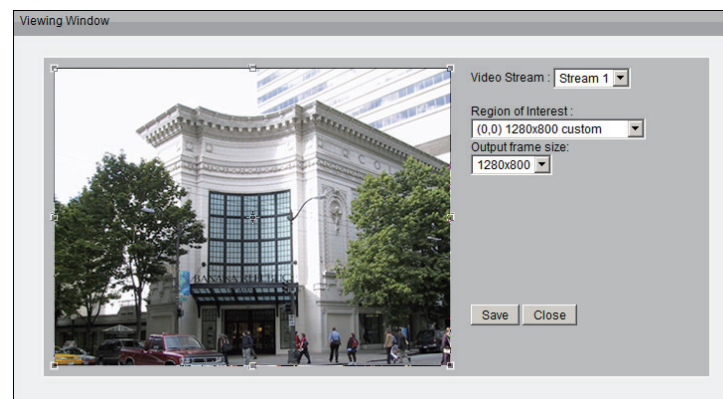
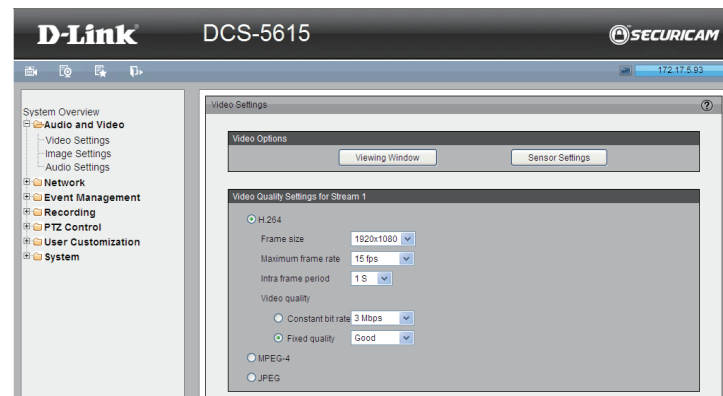

Once finished, click **Save** to enable the settings and click **Close** to exit the window. The selected Output Frame Size will immediately be applied to the Frame size of video stream. You can then go back to the Live Video to test the new settings.

**Sensor Setting:** Click **Sensor Setting** to open the Sensor Setting page. On this page, you can set the maximum exposure time, exposure level, and AGC (Auto Gain Control) setting. You can configure two sets of sensor setting: one for normal situations (Profile 1), the other for special situations, such as day/night/schedule mode (\*Profile 2).

### Exposure

- **Maximum Exposure Time:** Select a proper maximum exposure time according to the light source of the surroundings. Shorter exposure times result in less light reaching the sensor. The exposure times are selectable for the following durations: 1/5, 1/15, 1/30, 1/60, 1/120, 1/240, 1/480 second.
- **Exposure level:** You can manually set the Exposure level which ranges from 1 to 8 (dark to bright).
- **Max. Gain (Auto Gain Control):** You can manually set the AGC level (2X, 4X, or 8X). The higher the value, the brighter the image will be.
- **Enable BLC (Back Light Compensation):** Enable this option when the object is too dark or too bright to recognize. It allows the camera to adjust to the best light conditions in any environment and automatically give the necessary light compensation.

You may click **Preview** to fine-tune the image, or click **Restore** to recall the original setting without incorporating the changes. When completed with the setting on this page, click **Save** to enable the setting and click **Close** to exit the page. If you want to configure another sensor setting for day/night/schedule mode, please click **Profile 2** and follow the steps below to setup:

1. Click **Enable this profile**.
2. Select the applied mode: Day mode, Night mode, or Schedule mode. Please manually enter a range of time if you choose Schedule mode.
3. Configure Exposure setting in the second column.
4. Click **Save** to enable the setting and click **Close** to exit the page.

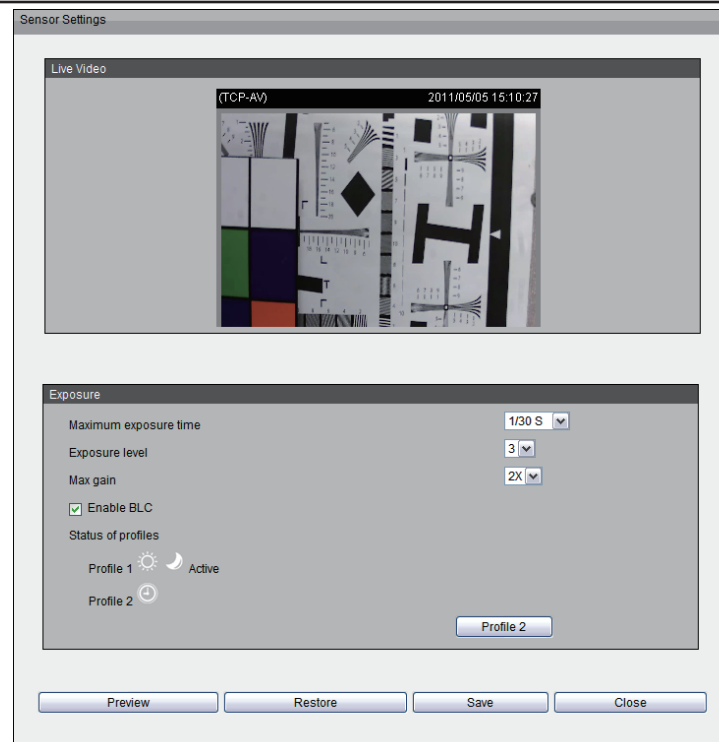

## Video Quality Setting for Stream 1~3

**Compression Type:** The compression level affects the amount of bandwidth and storage required. Lower compression uses more bandwidth and storage but delivers better image quality. Of the three options, H.264 consumes much less network bandwidth compared to MPEG4 and JPEG.

**Frame Size:** Select proper frame size for different viewing devices, bigger frame size requires more bandwidth and storage usage. For smaller viewers, such as mobile phones, a smaller frame size and lower frame rate is recommended. There are 7 options you can select: 384x216, 640x360, 1280x720, 1360x768, 1600x904 and 1920x1080, if there is no viewing window applied.

**Frame Rate:** This option affects the smoothness of the video. Select higher frame rate for smoother video quality but it requires more storage usage. 10 options for selection: customize: 1, 2, 3, 5, 8, 10, 15, 20, 25, 30 fps (30 fps is recommended real-time video on a computer monitor; 5 fps is ideal for mobile viewers.)

**Intra Frame Period:** Determines the frequency and I frame is planted. The shorter the duration, the more likely you will get better video quality, but at the cost of higher network bandwidth consumption. Select the intra frame period from the following durations: 1/4 second, 1/2 second, 1 second, 2 seconds, 3 seconds and 4 seconds.

**Video Quality:** This setting limits the maximum refresh frame rate.

- **Constant bit rate:** To set a fixed bandwidth regardless of the video quality, select Constant bit rate and the desired bandwidth from 40 Kbps to 6 Mbps. You can also select **Customize** and manually enter a value.
- **Fixed quality:** To optimize the bandwidth utilization and video quality. The video quality can be adjusted to the following setting: Medium, Standard, Good, Detailed and Excellent. You can also select **Customize** and manually enter a value.

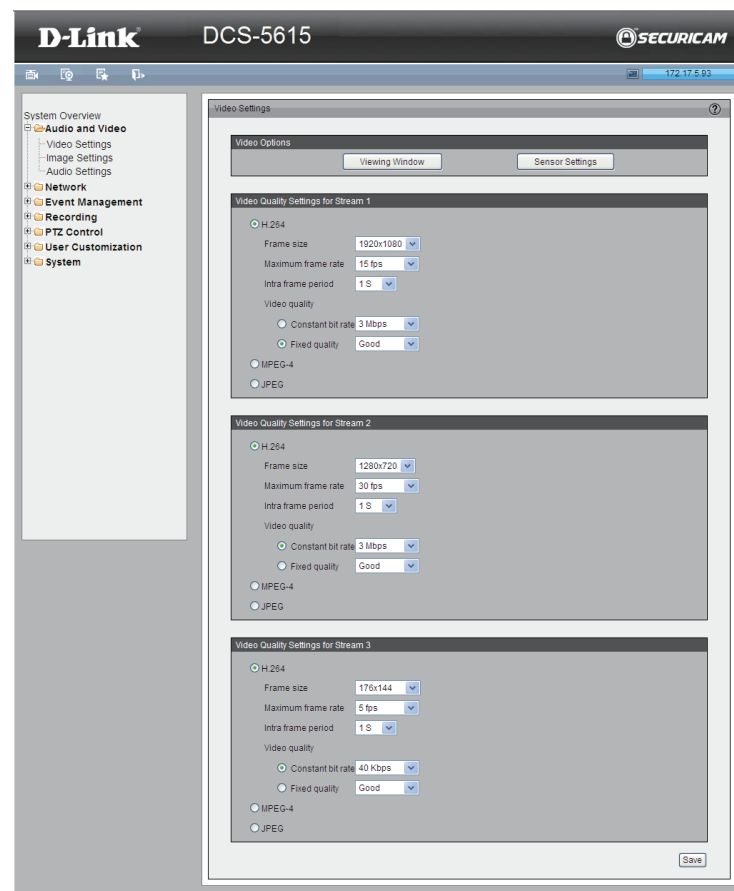

# Image Settings

This page allows you to tune the white balance, brightness, saturation, contrast, and sharpness settings for the video.

**Color:** Select either a Color or B/W (black and white, monochrome) video display.

**Power Line Frequency:** Select either 50 or 60 Hz depending on your region.

**Video Orientation:** Flip will vertically rotate the video. Mirror will horizontally rotate the video. You may select both options if camera is being installed upside down.

**White Balance:** This adjusts the relative amount of red, green and blue primary colors in the image so that the neutral colors are reproduced correctly.

- **Auto:** The camera automatically adjusts the color temperature of the light in response to different light sources. The white balance setting defaults to Auto and works well in most situations.
- **Fixed:** Follow the steps below to manually set the white balance to compensate for the ambient lighting conditions

1. Set the White balance to Auto and click **Save**.
2. Place a sheet of white paper in front of the lens, then allow the camera to adjust the color temperature automatically.
3. Select **Fixed** to confirm the setting while the white balance is being measured.
4. Click **Save** to enable the new setting.

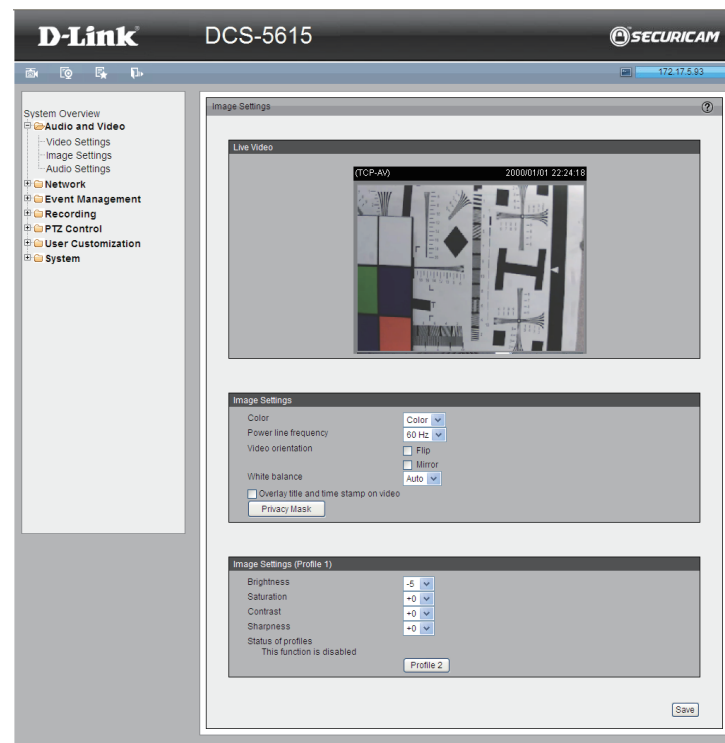

**Brightness:** Adjust the image brightness level, which ranges from -5 to +5

**Saturation:** Adjust the image saturation level, which ranges from -5 to +5

**Contrast:** Adjust the image contrast level, which ranges from -5 to +5

**Sharpness:** Adjust the image sharpness level, which ranges from -3 to +3

**Overlay Title and Time Stamp on Video:** Select this option to place the video title and time on the video streams.

**Note:**

- The "Sensor Settings" and "Image Settings" share the same \*Profile 2 settings.

**Privacy Mask:** In this page, you can block out certain sensitive zones for privacy concerns. To set up a Privacy Mask Window, follow the steps given below:

1. Click **New** to add a window.
2. The height and width of the window can be resized and drag-dropped the window.
3. Enter a descriptive Window Name and click **Save** to apply changes.
4. Select Enable privacy mask to facilitate this function.

**None:**

- Up to 5 privacy mask windows can be set up on the same screen.
- If you want to delete the privacy mask window, please click the 'x' at the upper right corner of the window.

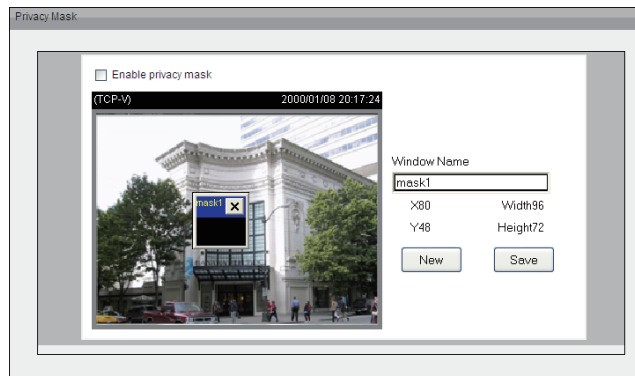
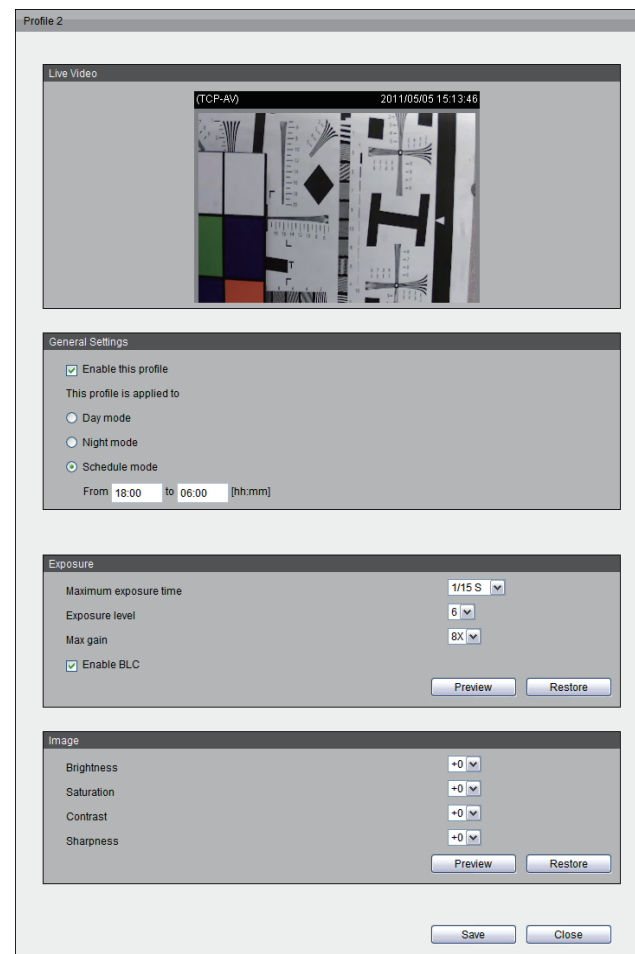

# Audio Settings

**Mute:** Select to mute audio.

**Note:**

- If the switch on the Control board is switched off (disabled audio) then this option will be disabled.

Select and set an internal microphone input gain from the drop-down list.

**Internal microphone input:** Set the microphone input gain at either 0dB or 20dB.

**Note:** The higher the decibel number, the louder the sound.

**Audio type:** Advanced Audio Coding (AAC) is a wide band audio coding algorithm that exploits two primary coding strategies to dramatically reduce the amount of data needed to convey high-quality digital audio. Select a higher bit rate number for better audio quality.

**AAC bit rate:** Select an AAC bit rate from the drop-down list. Higher bit rate means higher audio quality but it takes more network bandwidth to transmit.

**G.711:** Select between uLAW (G.711) and ALAW (G.711) compression formats. A higher audio quality will require more bandwidth.

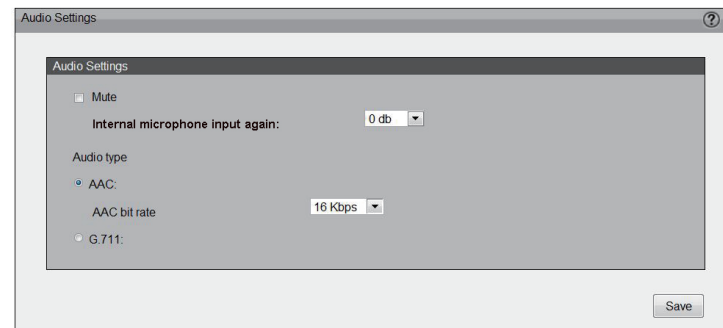



# Network

## IP Settings

### IPv4

**LAN:** Select this option when the camera is deployed on a local area network (LAN) and is intended to be accessed by local computers. The default setting for the Network Type is LAN. Remember to click **Save** when you complete the Network setting.

- **Get IP address automatically (DHCP):** Select this connection if you have a DHCP server running on your network and would like a dynamic IP address to be assigned to the camera automatically.
- **Use fixed IP address:** You may enter a static or fixed IP address for your camera.

**IP Address:** Enter an IP address.

**Subnet Mask:** The default value is “255.255.255.0.” This helps to determine if the designated IP address is on the same subnet.

**Default Router:** This is the gateway used to forward frames to destinations in a different subnet. (Invalid router settings will cause the transmission to fail if its destination is in a different subnet).

**Primary DNS:** The Primary Domain Name Server (DNS) that translates hostname into IP address.

**Secondary DNS:** Secondary Domain Name Server (DNS) that backups the Primary DNS.

**Primary WINS Server:** The primary WINS server that maintains the database of computer name and IP address.

IP Settings

IPv4

LAN:

- Get IP address automatically
- Use fixed IP address:
  - Enable UPnP presentation
  - Enable UPnP port forwarding
- PPPoE:

IPv6

Enable IPv6

Save

IP Settings

IPv4

LAN:

- Get IP address automatically
- Use fixed IP address:
  - IP address: 59.124.118.4
  - Subnet mask: 255.255.255.248
  - Default router: 59.124.118.1
  - Primary DNS: 168.95.1.1
  - Secondary DNS: 139.175.55.244
  - Primary WINS server:
  - Secondary WINS server:
- PPPoE:

Enable UPnP presentation

Enable UPnP port forwarding

IPv6

Enable IPv6

Save

**Secondary WINS Server:** The secondary WINS server that maintains the database of computer name and IP address.

- **Enable UPnP Presentation:** Select this option to enable UPnP presentation for the camera so that whenever a camera is presented to the LAN, shortcuts of connected cameras will be listed in My Network Places. You can click the shortcut to link to the web browser. Currently, UPnP is supported by Windows XP or later. Note that to utilize this feature, please make sure the UPnP component is installed on your computer.
- **Enable UPnP Port Forwarding:** To access the camera from the Internet, select this option to allow the camera to open ports on the router automatically so that video streams can be sent out from a LAN. To utilize this feature, make sure that your router supports UPnP and it is activated.

## How does UPnP work?

UPnP networking technology provides automatic IP configuration and dynamic discovery of devices added to a network. Services and capabilities offered by networked devices, such as printing and file sharing, are available among each other without bothersome network configuration. In the case of Network Cameras, you will see Network Camera shortcuts at My Network Places.

**PPPoE:** Select this option to configure the camera to make it accessible from anywhere with an Internet connection. Note that to utilize this feature, it requires an account provided by your ISP.

Follow the steps below to acquire the camera's public IP address.

1. Set up the camera on the LAN
2. Go to **Live View > Setup > Event management > Event settings > Server Settings** (please refer to Server Settings to add a new e-mail or FTP server)
3. Go to **Setup > Event management > Event settings > Media Settings** (please refer to Media Settings). Select System log so that you will receive the system log in TXT file format which contains the camera's public IP address in your e-mail or on the FTP server.

The screenshot shows the 'IP Settings' window with the 'IPv4' section selected. Under 'LAN', the 'Use fixed IP address' option is chosen. The fields are filled with: IP address: 59.124.118.4, Subnet mask: 255.255.255.248, Default router: 59.124.118.1, Primary DNS: 168.95.1.1, and Secondary DNS: 139.175.55.244. There are empty fields for Primary and Secondary WINS servers. The 'Enable UPnP presentation' and 'Enable UPnP port forwarding' checkboxes are unchecked. The 'PPPoE' option is not selected. A 'Save' button is visible at the bottom right.

The screenshot shows the 'IPv4' configuration window with the 'PPPoE' option selected. The 'User name' field contains '123456@hinet.net'. The 'Password' and 'Confirm password' fields are masked with dots.

4. Go to **Setup > Network > IP settings**. Select PPPoE and enter the user name and password provided by your ISP. Click **Save** to enable the setting.
5. The camera will reboot.
6. Disconnect the power to the camera. Remove it from the LAN environment.

### IPv6

**Enable IPv6:** Select this option and click **Save** to enable IPv6 setting. Please note that this only works if your network environment and hardware equipment support IPv6. The browser should be Internet Explorer 6.5, Mozilla Firefox 3.0 or above.

When IPv6 is enabled, by default, the camera will listen to router advertisements and be assigned a link-local IPv6 address accordingly.

**IPv6 Information:** Click this button to obtain the IPv6 information. If your IPv6 setting are successful, the IPv6 address list will be listed in the pop-up window.

Please follow the steps below to link to an IPv6 address:

1. Open your web browser.
2. Enter the link-global or link-local IPv6 address in the address bar of your web browser.
3. Press **Enter** on the keyboard or click **Refresh** button to refresh the webpage.

**Manually Setup the IP Address:** Select this option to manually configure IPv6 setting if your network environment does not have DHCPv6 server and advertisements-enabled routers.

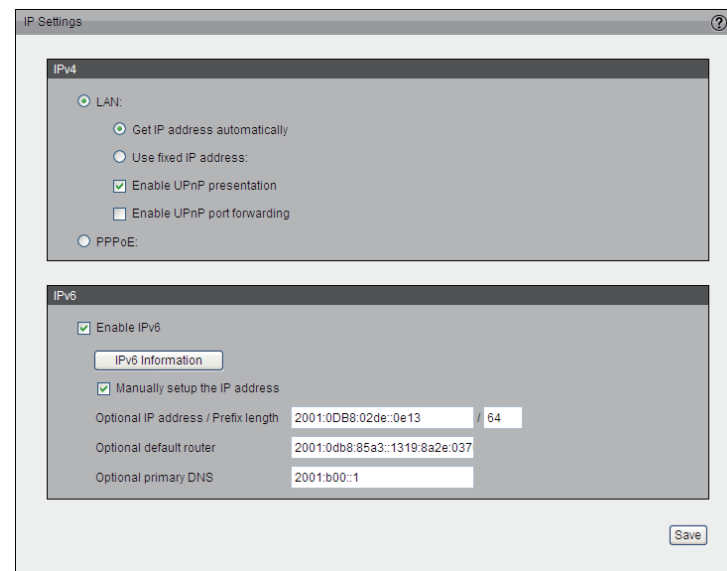

The screenshot shows the 'IP Settings' window. It is divided into two main sections: IPv4 and IPv6. The IPv4 section is currently active, showing radio buttons for 'LAN' and 'PPPoE'. Under 'LAN', there are options for 'Get IP address automatically', 'Use fixed IP address', 'Enable UPnP presentation', and 'Enable UPnP port forwarding'. The IPv6 section is below it, with 'Enable IPv6' checked. A button labeled 'IPv6 Information' is visible. Underneath, there are three rows of input fields: 'Optional IP address / Prefix length' with the value '2001:0DB8:02de:0e13 / 64', 'Optional default router' with '2001:0db8:85a3::1319:8a2e:037', and 'Optional primary DNS' with '2001:b00:1'. A 'Save' button is located at the bottom right of the IPv6 section.

# Port and Access Name Settings

## HTTPS

By default, the HTTPS port is set to 443. It can also be assigned to another port number between 1025 and 65535.

**Note:** JPEG only transmits a series of JPEG images to the client. In order to utilize this audio feature, make sure the video mode is set to H.264 or MPEG-4 and the media option in "Client Settings" is set to Video and Audio.

## FTP

The FTP server allows the user to save recorded video clips. By default, the FTP port is set to 21. It also can be assigned to another port number between 1025 and 65535.

## HTTP port/Secondary HTTP port

They can also be assigned to another port number between 1025 and 65535. To access the Network Camera on the LAN, both the HTTP port and secondary HTTP port can be used to access the Network Camera. For example, when the HTTP port is set to 80 and the secondary HTTP port is set to 8080. You can login camera as example link as below:

Http://192.168.0.20 or  
Http://192.168.0.20:8080

**Authentication:** Depending on your network security requirements, the Network Camera provides three types of security settings for streaming via HTTP protocol: disable, basic, and digest. If basic authentication is selected, the password is sent in plain text format, but there can be potential risks of it being intercepted. If digest authentication is selected, user credentials are encrypted using MD5 algorithm, thus providing better protection against unauthorized access.

The screenshot displays the 'Port & Access Name Settings' page for a D-Link DCS-5615 camera. The interface is organized into several sections:

- HTTPS:** The HTTPS port is set to 443.
- FTP:** The FTP port is set to 21.
- HTTP:**
  - Authentication is set to 'Basic'.
  - HTTP port is 80.
  - Secondary HTTP port is 8080.
  - Access names for streams 1 through 5 are: video.mjpg, video2.mjpg, video3.mjpg, video4.mjpg, and videoany.mjpg.
- RTSP Streaming:**
  - Authentication is set to 'Disable'.
  - Access names for streams 1 through 5 are: live.sdp, live2.sdp, live3.sdp, live4.sdp, and liveany.sdp.
  - RTSP port is 554.
  - RTP port for video is 5556.
  - RTCP port for video is 5557.
  - RTP port for audio is 5558.
  - RTCP port for audio is 5559.
- Multicast:**
  - Enable multicast for stream 1 is checked.
  - Multicast group address is 239.128.199.
  - Multicast video port is 5560.
  - Multicast RTCP video port is 5561.
  - Multicast audio port is 5562.
  - Multicast RTCP audio port is 5563.
  - Multicast TTL [1-255] is 15.
  - Enable multicast for stream 2, 3, and 4 are unchecked.

A 'Save' button is located at the bottom right of the settings area.

**Access name for stream 1 ~ 3:** This Network Camera supports multiple streams simultaneously. The access name is used to differentiate the streaming source. When using Firefox to access the Network Camera and the video mode is set to JPEG, users will receive video comprised of continuous JPEG images. This technology, known as “server push”, allows the Network Camera to feed live pictures to Firefox. And use the following HTTP URL command to request transmission of the streaming data.

For example: `http://<ip address>:<http port>/<access name for stream 1 ~ 3>`

When the Access name for stream 3 is set to `video3.mjpg`:

1. Launch Firefox.
2. Type the above URL command in the address bar. Press **Enter**.
3. The JPEG images will be displayed in your web browser.

### NOTE:

Internet Explorer does not support server push technology; therefore, using `http://<ip address>:<http port>/<access name for stream 1 ~ 3>` will fail to access the Network Camera.

## RTSP

**Authentication:** Depending on your network security requirements, the Network Camera provides three types of security settings for streaming via RTSP protocol: disable, basic, and digest. If basic authentication is selected, the password is sent in plain text format, but there can be potential risks of it being intercepted. If digest authentication is selected, user credentials are encrypted using MD5 algorithm, thus providing better protection against unauthorized access.

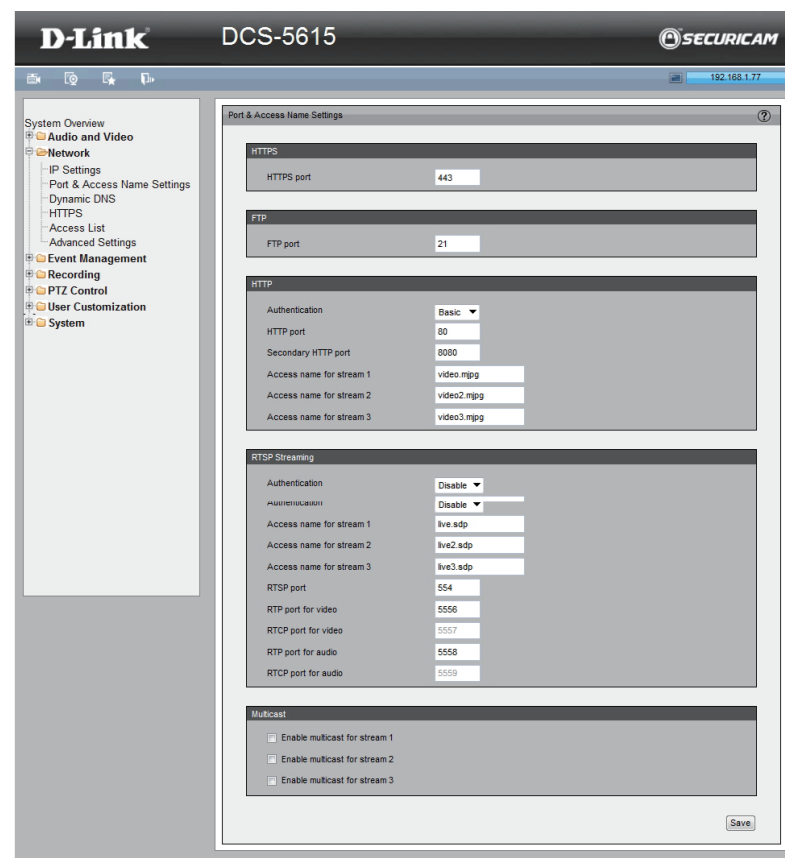

**Access name for stream 1 ~ 3:** This Network Camera supports multiple streams simultaneously. The access name is used to differentiate the streaming source. If you want to use an RTSP player to access the Network Camera, you have to set the video mode to H.264 / MPEG-4 and use the following RTSP URL command to request transmission of the streaming data.

### **RTSP port / RTP port for video, audio / RTCP port for video, audio**

- RTSP (Real-Time Streaming Protocol) controls the delivery of streaming media. By default, the port number is set to 554.
- The RTP (Real-time Transport Protocol) is used to deliver video and audio data to the clients. By default, the RTP port for video is set to 5556 and the RTP port for audio is set to 5558.
- The RTCP (Real-time Transport Control Protocol) allows the Network Camera to transmit the data by monitoring the Internet traffic volume. By default, the RTCP port for video is set to 5557 and the RTCP port for audio is set to 5559.

The ports can be changed to values between 1025 and 65535. The RTP port must be an even number and the RTCP port is the RTP port number plus one, and thus is always an odd number. When the RTP port changes, the RTCP port will change accordingly.

**Multicast:** Click the items to display the detailed configuration information. Select the Always multicast option to enable multicast for stream 1 ~ 3.

Unicast video transmission delivers a stream through point-to-point transmission; multicast, on the other hand, sends a stream to the multicast group address and allows multiple clients to acquire the stream at the same time by requesting a copy from the multicast group address. Therefore, enabling multicast can effectively save network bandwidth.

### **Multicast RTP video, audio port/Multicast RTCP video, audio port**

The ports can be changed to values between 1025 and 65535. The multicast RTP port must be an even number and the multicast RTCP port number is the multicast RTP port number plus one, and thus is always odd. When the multicast RTP port changes, the multicast RTCP port will change accordingly.

**Multicast TTL [1~255]:** The multicast TTL (Time To Live) is the value that tells the router the range a packet can be forwarded.

# Dynamic DNS

This section explains how to configure the dynamic domain name service (DDNS) for your camera. DDNS is a service that allows your camera, especially when assigned with a dynamic IP address, to have a fixed host and domain name. You can access the camera from the Internet using a simple URL.

**Enable DDNS:** Select this option to enable the DDNS setting.

**Server Name:** Select a DDNS server name from the provider drop-down list. With a Dynamic DNS account, the camera automatically updates your IP address. To enable DDNS, enter your host information.

**Host Name:** Enter the host name of the DDNS server.

**Username:** Enter your username or e-mail used to connect to the DDNS

**Password:** Enter your password used to connect to the DDNS server.

**Status:** Indicate the connection status, automatically determined by the system.

**Save:** Click the **Save** button to apply your settings.

The screenshot shows a web interface window titled "Dynamic DNS". Inside, there is a "DDNS Settings" section with the following fields:

- Enable DDNS
- Server name: www.dlinkddns.com(Free) (dropdown menu)
- Host name: DCS-5615.sells-it.net (text input)
- User name: admin (text input)
- Password: [masked with dots] (password input)
- Confirm password: [masked with dots] (password input)
- Status: none (text input)

A "Save" button is located at the bottom right of the settings area.

# HTTPS

This section explains how to enable authentication and encrypted communication over SSL (Secure Socket Layer). It helps protect streaming data transmission over the Internet on higher security level.

## Enable HTTPS

Select this item to enable HTTPS communication, then select a connection option: "HTTP & HTTPS" or "HTTPS only". Note that you have to create and install a certificate first in the second column before clicking the **Save** button.

## Create and Install Certificate Method

Before using HTTPS for communication with the camera, a certificate must be created first.

There are three ways to create and install a certificate:

### Create Self-signed Certificate Automatically

1. Select this option.
2. In the first column, select **Enable HTTPS secure connection**, then select a connection option: "HTTP & HTTPS" or "HTTPS only".
3. Click **Save** to generate a certificate.
4. The **Certificate Information** will automatically be displayed in the third column. You can click **Property** to view detailed information about the certificate.
5. Click **Live Video** to return to the main page. Change the address from "http://" to "https://" in the address bar and press Enter. Some Security Alert dialogs will pop up. Click **OK** or **Yes** to enable HTTPS.

### Create Self-signed Certificate Manually

1. Click **Create** to open the Create Certificate page, then click **Save** to generate the certificate.
2. The Certificate Information will automatically be displayed in the third column as shown below. You can click **Property** to see detailed information about the certificate.

The screenshot shows a web interface titled "HTTPS" with a help icon in the top right. It is divided into three main sections:

- Enable HTTPS:** Contains a checked checkbox for "Enable HTTPS secure connection" and two radio buttons: "HTTP & HTTPS" (selected) and "HTTPS only". A "Save" button is located to the right.
- Create and install certificate method:** Contains three radio buttons: "Create self-signed certificate automatically", "Create self-signed certificate manually" (selected), and "Create certificate request and install". Below the selected option is a "Self-signed certificate:" label and a "Create" button.
- Certificate Information:** A table-like view showing certificate details:

|                    |                      |
|--------------------|----------------------|
| Status:            | Active               |
| Country:           | US                   |
| State or province: | California           |
| Locality:          | Fountain Valley      |
| Organization:      | D-Link Corporation   |
| Organization Unit: | Marketing Department |
| Common Name:       | www.dlink.com        |

At the bottom of this section are "Property" and "Remove" buttons.



## Create Certificate Request and Install

Select this option to create a certificate from a certificate authority.

1. Click **Create** to open the **Create Certificate** page, then click **Save** to generate the certificate.
2. If you see the information bar, click **OK** and click on the Information bar at the top of the page to allow pop-up.
3. The pop-up window shows an example of a certificate request.
4. Look for a trusted certificate authority that issues digital certificates. Enroll the camera.

Wait for the certificate authority to issue a SSL certificate. Click **Browse...** to search for the issued certificate, then click **Upload** in the second column.

## How do I cancel the HTTPS setting?

1. Deselect **Enable HTTPS secure connection** in the first column and click **Save**. A warning dialog will pop up.
2. Click **OK** to disable HTTPS.
3. The webpage will redirect to a non-HTTPS page automatically.

If you want to create and install other certificates, please remove the existing one. To remove the signed certificate, deselect **Enable HTTPS secure connection** in the first column and click **Save**. Click **Remove** to erase the certificate.

The screenshot shows a web interface for configuring HTTPS. It is titled "HTTPS" and contains three main sections:

- Enable HTTPS:** A checkbox for "Enable HTTPS secure connection" is checked. Below it are radio buttons for "HTTP & HTTPS" (selected) and "HTTPS only". A "Save" button is located to the right.
- Create and install certificate method:** Three radio button options are present: "Create self-signed certificate automatically", "Create self-signed certificate manually" (selected), and "Create certificate request and install". A "Create" button is next to the "Self-signed certificate:" label.
- Certificate Information:** A table-like display showing details for a certificate:

|                    |                      |
|--------------------|----------------------|
| Status:            | Active               |
| Country:           | US                   |
| State or province: | California           |
| Locality:          | Fountain Valley      |
| Organization:      | D-Link Corporation   |
| Organization Unit: | Marketing Department |
| Common Name:       | www.dlink.com        |

At the bottom of this section are "Property" and "Remove" buttons.

# Access List

This section explains how to control access permissions by verifying the connecting client PC's IP address.

## General Settings

Maximum number of concurrent streaming connection(s) limited to:  
 Simultaneous live viewing for 1~10 clients (including stream 1 ~ stream 3).  
 The default value is 10. If you modify the value and click **Save**, all current connections will be disconnected and automatically attempt to re-link (I.E. Explorer or Quick Time Player).

**View Information:** Click this button to display the connection status window showing a list of the current connections.

- **IP address:** Current connections to the camera.
- **Elapsed time:** How much time the client has been at the webpage.
- **User ID:** If the administrator has set a password for the webpage, the clients have to enter a user name and password to access the live video. The user name will be displayed in the User ID column. If the administrator allows client to link to the webpage without a user name and password, the User ID column will be empty.

There are some situations which allow clients access to the live video without a user name and password:

1. The administrator did not set up a user password. For more information about how to set up a user password and manage user accounts, please refer to User settings.
2. The administrator has set up a user password, but set RTSP Authentication to "disable". For more information about RTSP Authentication, please refer to RTSP Streaming.

| IP address | Elapsed time     | User ID    |
|------------|------------------|------------|
| Refresh    | Add to deny list | Disconnect |

- **Refresh:** Click this button to refresh all current connections.
- **Add to deny list:** You can select entries from the Connection Status list and add them to the Deny List to deny access. Please note that the selected connections will only be disconnected temporarily and will automatically try to re-link again (i.e., Explorer or Quick Time Player). If you want to enable the denied list, please select **Enable access list filtering** and click **Save** in the first column.

**Disconnect:** If you want to break off the current connections, please select them and click this button. Please note that those selected connections will only be disconnected temporarily and will automatically try to re-link again (i.e., Explorer or Quick Time Player).

**Enable Access List Filtering:** Select this item and click **Save** if you want to enable the access list filtering function.

### Filter Type

Select **Allow** or **Deny** as the filter type. If you choose Allow Type, only those clients whose IP addresses are on the Access List below can access the camera, and the others cannot access. On the contrary, if you choose Deny Type, those clients whose IP addresses are on the Access List below will not be allowed to access the camera, and the others can access.

### Filter

You can then add a rule to the following Access List. Please note that the IPv6 access list column will not be displayed unless you enable IPv6 on the Network page. For more information about IPv6 Setting, please refer to Enable IPv6 for detailed information.

There are three types of rules:

**Single:** This rule allows the user to add an IP address to the Allowed/Denied list.

**Network:** This rule allows the user to assign a network address and corresponding subnet mask to the Allow/Deny List.

**Range:** This rule allows the user to assign a range of IP addresses to the Allow/Deny List (This rule is only applied to IPv4).

### Administrator IP address

Always allow the IP address to access this device: You can select this item and add the Administrator's IP address in this field to make sure the Administrator can always connect to the device.

# Advanced Settings

## SNMP configuration

This section explains how to use the SNMP on the network camera. The Simple Network Management Protocol is an application layer protocol that facilitates the exchange of management information between network devices. It helps network administrators to remotely manage network devices and find, solve network problems with ease.

The SNMP consists of the following three key components:

1. **Manager:** Network-Management Station (NMS), a server which executes applications that monitor and control managed devices.
2. **Agent:** A network-management software module on a managed device which transfers the status of managed devices to the NMS.
3. **Managed device:** A network node on a managed network. For example: routers, switches, bridges, hubs, computer hosts, printers, IP telephones, network cameras, web server, and database.

Before configuring SNMP setting on this page, please enable your NMS first. Enable SNMPv1, SNMPv2c: Select this option and enter the names of Read/Write community and Read Only community according to your NMS setting.

**Enable SNMPv3:** This option contains cryptographic security, a higher security level which allows you to set the Authentication password and the Encryption password.

- **Security name:** According to your NMS setting, choose Read/Write or Read Only and enter the community name.
- **Authentication type:** Select **MD5** or **SHA** as the authentication method.
- **Authentication password:** Enter the password for authentication (at least 8 characters).
- **Encryption password:** Enter a password for encryption (at least 8 characters).

The screenshot displays the 'Advanced Settings' web interface with the following sections:

- SNMP Configuration:**
  - Enable SNMPv1, SNMPv2c
    - Read/Write community: Private
    - Read only community: Public
  - Enable SNMPv3
    - Read/Write Security name: Private
    - Authentication Type: MD5
    - Authentication Password: [text input]
    - Encryption Password: [text input]
    - Read only Security name: Public
    - Authentication Type: MD5
    - Authentication Password: [text input]
    - Encryption Password: [text input]
- IEEE 802.1x:**
  - Enable IEEE 802.1x
    - EAP method: EAP-PEAP
    - Identity: [text input]
    - Password: [text input]
    - CA certificate: [text input] Browse... Upload
    - Status: no file Remove
- CoS:**
  - Enable CoS
    - VLAN ID: 1
    - Live Video: 0
    - Event/Alarm: 0
    - Management: 0
- QoS/DSCP:**
  - Enable QoS/DSCP
    - Live Video: 0
    - Event/Alarm: 0
    - Management: 0

Save buttons are present at the bottom right of each section.

## IEEE 802.1x

Enable this function if your network environment uses IEEE 802.1x which is a port-based network access control. The network devices, intermediary switch/access point/hub, and RADIUS server must support and enable 802.1x setting.

The 802.1x standard is designed to enhance the security of local area networks, which provides authentication to network devices (clients) attached to a network port (wired or wireless). If all certificates between client and server are verified, a point-to-point connection will be enabled. If authentication fails, access on that port will be prohibited. 802.1x utilizes an existing protocol, the Extensible Authentication Protocol (EAP), to facilitate communication.

Please follow the steps below to enable 802.1x setting:

1. Before connecting the camera to the protected network with 802.1x, please apply a digital certificate from a Certificate Authority (i.e., MIS of your company) which can be validated by a RADIUS server.
2. Connect the camera to a PC or notebook outside of the protected LAN. Open the configuration page of the camera as shown below. Select EAP-PEAP or EAP-TLS as the EAP method. In the following blanks, enter your ID and password issued by the CA, then upload related certificate(s).
3. When all setting are complete, move the camera to the protected LAN by connecting it to an 802.1x enabled switch. The devices will then start the authentication automatically.

## QoS (Quality of Service)

Quality of Service refers to a resource reservation control mechanism, which guarantees a certain quality to different services on the network. Quality of service guarantees are important if the network capacity is insufficient, especially for real-time streaming multimedia applications. Quality can be defined as, for instance, a maintained level of bit rate, low latency, no packet dropping, etc.

The screenshot displays the 'Advanced Settings' window of a camera configuration interface. It is divided into four main sections:

- SNMP Configuration:** Contains two sub-sections. The first is for SNMPv1 and SNMPv2c, with 'Enable SNMPv1, SNMPv2c' checked, 'Read/Write community' set to 'Private', and 'Read only community' set to 'Public'. The second is for SNMPv3, with 'Enable SNMPv3' checked, 'Read/Write Security name' set to 'Private', 'Authentication Type' set to 'MD5', and 'Read only Security name' set to 'Public'. Both sections have fields for 'Authentication Password' and 'Encryption Password'.
- IEEE 802.1x:** 'Enable IEEE 802.1x' is checked. 'EAP method' is set to 'EAP-PEAP'. There are input fields for 'Identity' and 'Password'. A 'CA certificate' field has 'Browse...' and 'Upload' buttons. The status is 'no file' with a 'Remove' button.
- CoS:** 'Enable CoS' is checked. 'VLAN ID' is set to '1'. 'Live Video', 'Event/Alarm', and 'Management' are each set to '0' via dropdown menus.
- QoS/DSCP:** 'Enable QoS/DSCP' is checked. 'Live Video', 'Event/Alarm', and 'Management' are each set to '0' via input fields.

'Save' buttons are located at the bottom right of each section and at the bottom right of the entire window.

## The following are the main benefits of a QoS-aware network:

The ability to prioritize traffic and guarantee a certain level of performance to the data flow.

The ability to control the amount of bandwidth each application may use, and thus provide higher reliability and stability on the network.

## Requirements for QoS:

To utilize QoS in a network environment, the following requirements must be met:

- All network switches and routers in the network must include support for QoS.
- The network video devices used in the network must be QoS-enabled.

## CoS

IEEE802.1p defines a QoS model at OSI Layer 2 (Data Link Layer), which is called CoS, Class of Service. It adds a 3-bit value to the VLAN MAC header, which indicates prioritization from 0~7 (Eight different classes of service are available). The priority is set up on the network switches, which then use different queuing disciplines to forward the packets.

Please follow the steps below to enable CoS settings:

1. Click **Enable CoS**.
2. Enter the VLAN ID of your switch (0~4095).
3. Choose the priority for each application (0~7).

## Note:

- The VLAN Switch (802.1p) is required. The web browsing may fail if the CoS setting is incorrect.
- Class of Service technologies do not guarantee a level of service in terms of bandwidth and delivery time. They only offer a "best-effort." Users can think of CoS as "coarsely-grained" traffic control and QoS as "finely-grained" traffic control.
- Though CoS is simple to manage, it lacks scalability and does not offer end-to-end guarantees since it is based on L2 protocol.

The screenshot displays the 'Advanced Settings' web interface, which is divided into several configuration sections:

- SNMP Configuration:** This section is divided into two parts. The first part has 'Enable SNMPv1, SNMPv2c' checked, with 'Read / Write community' set to 'Private' and 'Read only community' set to 'Public'. The second part has 'Enable SNMPv3' checked, with 'Read / Write Security name' set to 'Private', 'Authentication type' set to 'MD5', and 'Read only security name' set to 'Public'. Both parts have fields for 'Authentication password' and 'Encryption password'.
- IEEE 802.1x:** This section has 'Enable IEEE 802.1x' checked. The 'EAP method' is set to 'EAP-TLS'. The 'Identity' is 'jerry' and the 'Private key password' is masked with asterisks. There are three rows for certificates: 'CA certificate', 'Client certificate', and 'Client private key'. Each row has a 'Remove' button and an 'Upload' button. The status for each row is '2013/12/4 15:37' followed by the size in bytes (1265, 3251, and 963 respectively).
- CoS:** This section has 'Enable CoS' checked. The 'VLAN ID' is set to '1'. There are four rows for application priorities: 'Live Video', 'Live audio', 'Event / Alarm', and 'Management', all of which are currently set to '0'.
- QoS / DSCP:** This section has 'Enable QoS / DSCP' checked. There are four rows for application priorities: 'Live Video', 'Live audio', 'Event / Alarm', and 'Management', all of which are currently set to '0'.

'Save' buttons are located at the bottom right of each configuration section.

### **QoS/DSCP**

DSCP-ECN defines QoS at Layer 3 (Network Layer). The Differentiated Services (DiffServ) model is based on packet marking and router queuing disciplines. The marking is done by adding a field to the IP header, called the DSCP (Differentiated Services Code Point). This is a 6-bit field that provides 64 different class IDs. It gives an indication of how a given packet is to be forwarded, known as the Per Hop Behavior (PHB). The PHB describes a particular service level in terms of bandwidth, queuing theory, and dropping (discarding the packet) decisions. Routers at each network node classify packets according to their DSCP value and give them a particular forwarding treatment. For example, how much bandwidth should be reserved.

Quality of Service refers to a resource reservation control mechanism, which guarantees a certain quality to different services on the network. Quality of service guarantees are important if the network capacity is insufficient, especially for real-time streaming multimedia applications. Quality can be defined as, for instance, a maintained level of bit rate, low latency, no packet dropping, etc.

# Event Management

## Motion Detection

Motion can be detected by measuring change in speed or vector of an object or objects in the field of view.

**Enable Motion Detection:** Select this option to turn on the motion detection feature.

**Window Name:** Create your own name for the monitored area/ window. It will show at the top of the motion window.

**Sensitivity:** Set the measurable difference between two sequential images that would indicate motion.

**Percentage:** Set the amount of motion in the window being monitored that is required to trigger a motion detected alert. If this is set to 100%, this means that motion must be detected within the whole window to trigger a snapshot.

**Note:** Setting a higher sensitivity and a lower percentage will make motion easier to be detected.

**New:** Click to add a new window. A maximum of three motion windows can be opened simultaneously. Use your mouse to drag the window frame to resize or the title bar to move. Clicking on the 'x' at the upper right corner of the window will close the window.

**Save:** Save the configured settings.

To enable motion detection, follow the steps below:

1. Click **New** to add a new motion detection window.
2. Enter a name in the Window Name field.
3. Define the sensitivity to moving objects and the space ratio of all alerted pixels by moving the Sensitivity and Percentage slide bar.
4. Click **Save** to apply the changes.
5. Select Enable motion detection to activate motion detection.

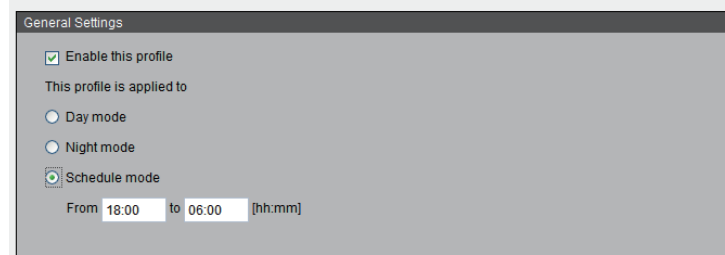
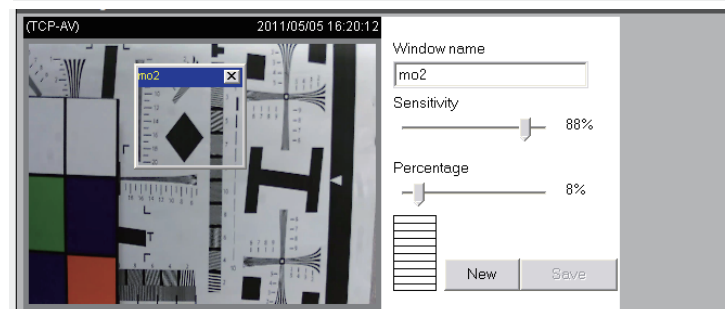
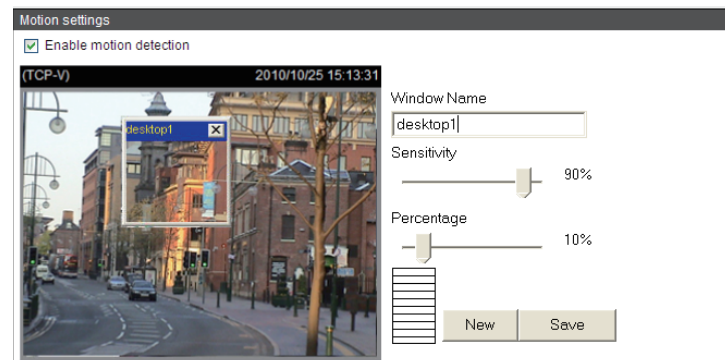

### Profile:

You can configure two sets of sensor setting: one for normal situations(Profile1), the other for special situations(Profile2), such as day/night/schedule mode.



# Tamper Detection

With tamper detection, the camera is capable of detecting incidents such as redirection, blocking or de-focusing, or even spray paint.

**To enable tamper detection, follow the steps given below:**

1. Select **Enable camera tampering detection**.
2. Enter the tamper trigger duration (10 sec. ~ 10 min.). The tamper alarm will be triggered only when the tampering factor (the difference between current frame and pre-saved background) exceeds the trigger threshold.

Set up the event source as Camera Tampering Detection on Event Settings > Server Settings (how to send alarm message) / Media Settings (send what type of alarm message)/Event Settings/. Please refer to Event settings for detailed information.

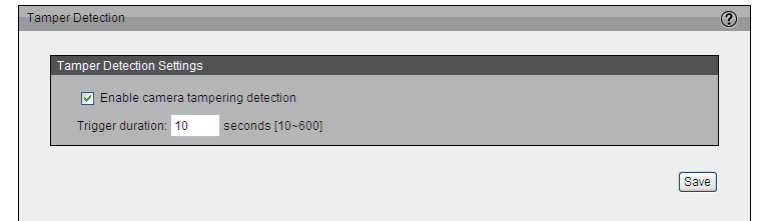

# DI

Network camera provides a general I/O terminal block with one digital input for device control. The I/O connector provides the physical interface for digital input (DI+, GND) that is used for connecting a diversity of external alarm devices to the camera such as IR-Sensors. Once triggered images will be taken and e-mailed.

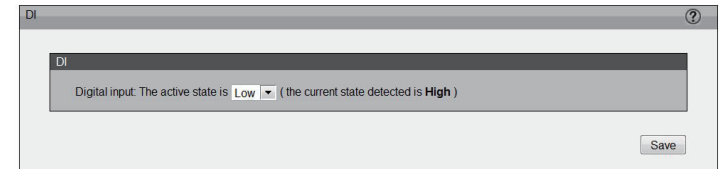

## DI Schematics

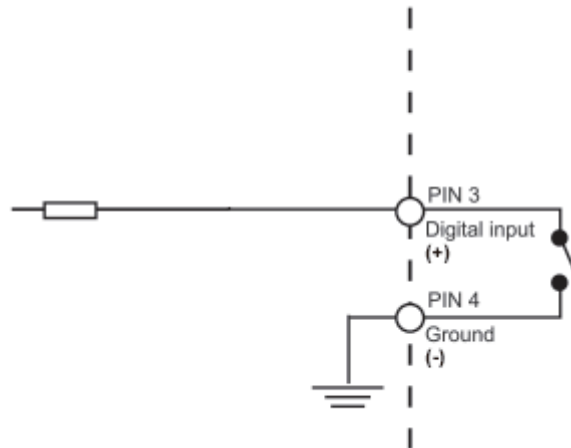

# Event Settings

This section explains how to configure the camera to respond to particular situations (event). A typical application is that when a motion is detected, the camera sends buffered images to an FTP server or e-mail address as notifications.

## Server Settings

Click **Add Server** on Event Settings page to open the Server Setting page. On this page, you can specify where the notification messages are sent when a trigger is activated. A total of 5 server settings can be configured.

**Server name:** Enter a name for the server setting.

- **Server Type:** There are four choices of server types available: E-mail, FTP, HTTP, and Network storage. Select the item to display the detailed configuration options. You can configure either one or all of them.

**E-mail:** Select to send the media files via e-mail when a trigger is activated.

- **Sender e-mail address:** Enter the e-mail address of the sender.
- **Recipient e-mail address:** Enter the e-mail address of the recipient.
- **Server address:** Enter the domain name or IP address of the e-mail server.
- **User name:** Enter the user name of the e-mail account if necessary.
- **Password:** Enter the password of the e-mail account if necessary.
- **Server port:** The default mail server port is set to 25. You can also manually set another port.

If your SMTP server requires a secure connection (SSL), select **This server requires a secure connection (SSL)**.

To verify if the e-mail settings are correctly configured, click **Test**. The result will be shown in a pop-up window. If successful, you will also receive an e-mail indicating the result.

Click **Save** to enable the settings, then click **Close** to exit the page.

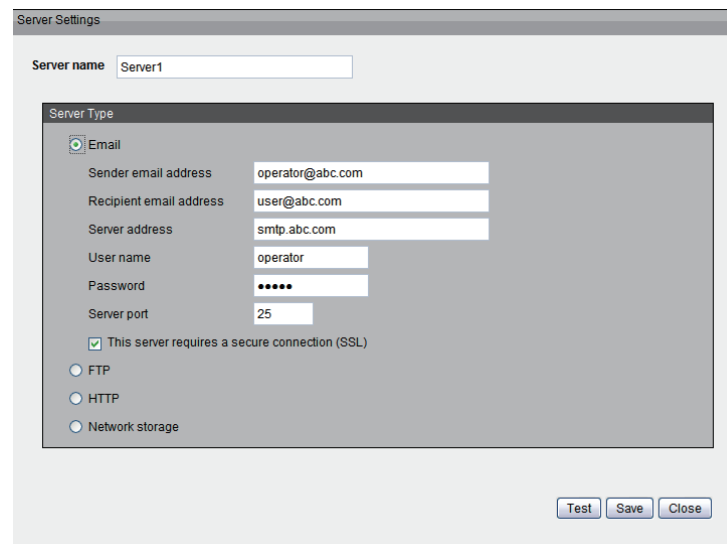
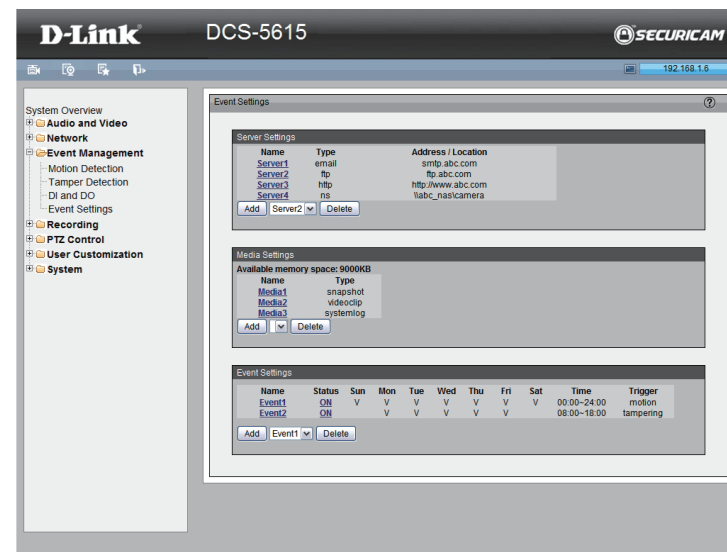

**FTP:** Select to send the media files to an FTP server when a trigger is activated.

- **Server address:** Enter the domain name or IP address of the FTP server.
- **Server port:** By default, the FTP server port is set to 21. It can also be assigned to another port number between 1025 and 65535.
- **User name:** Enter the login name of the FTP account.
- **Password:** Enter the password of the FTP account.
- **FTP folder name:** Enter the folder where the media file will be placed. If the folder name does not exist, the camera will create one on the FTP server.
- **Passive mode:** Most firewalls do not accept new connections initiated from external requests. If the FTP server supports passive mode, select this option to enable passive mode FTP and allow data transmission to pass through the firewall.

To verify if the FTP settings are correctly configured, click **Test**. The result will be shown in a pop-up window as shown below. If successful, you will also receive a test.txt file on the FTP server.

Click **Save** to enable the settings, then click **Close** to exit the page.

**HTTP:** Select to send the media files to an HTTP server when a trigger is activated.

- **URL:** Enter the URL of the HTTP server.
- **User name:** Enter the user name if necessary.
- **Password:** Enter the password if necessary.

To verify if the HTTP settings are correctly configured, click **Test**. The result will be shown in a pop-up window as below. If successful, you will receive a test.txt file on the HTTP server. Click **Save** to enable the settings then click **Close** to exit the page.

**Network storage:** Select to send the media files to a network storage location when a trigger is activated. Click **Save** to enable the setting, then click **Close** to exit the page. When completed, the new server settings will automatically be displayed on the Event Settings page.

The screenshot shows the configuration window for 'Server2'. The 'Server name' field contains 'Server2'. Under the 'Server Type' section, 'FTP' is selected with a radio button. The 'Server address' field contains 'ftp.abc.com', 'Server port' is '21', 'User name' is 'operator', and 'Password' is masked with dots. The 'FTP folder name' field is empty. The 'Passive mode' checkbox is checked. Other options like 'Email', 'HTTP', and 'Network storage' are unselected. At the bottom right, there are 'Test', 'Save', and 'Close' buttons.

The screenshot shows the configuration window for 'Server3'. The 'Server name' field contains 'Server3'. Under the 'Server Type' section, 'HTTP' is selected with a radio button. The 'URL' field contains 'http://www.abc.com', 'User name' is 'operator', and 'Password' is masked with dots. The 'Network storage' option is unselected. At the bottom right, there are 'Test', 'Save', and 'Close' buttons.

The screenshot shows the configuration window for 'Server4'. The 'Server name' field contains 'Server4'. Under the 'Server Type' section, 'Network storage' is selected with a radio button. The 'Network storage location' field contains '\\abc\_nas\camera'. Below it, a note says '(For example: \\my\_nas\disk\folder)'. The 'Workgroup' field contains 'ipcam', 'User name' is 'operator', and 'Password' is masked with dots. At the bottom right, there are 'Test', 'Save', and 'Close' buttons.

## Media Settings

Click **Add Media** to open the Media Settings page. On this page, you can specify the type of media that will be sent when a trigger is activated. A total of five media settings can be configured.

**Media name:** Enter a name for the media setting.

**Media Type:** There are three choices of media types available: Snapshot, Video Clip, and System log. Select the item to display the detailed configuration options. You can configure either one or all of them.

**Snapshot:** Select to send snapshots when a trigger is activated.

**Source:** Select to take snapshots from stream 1 ~ 3.

**Send pre-event images:** The camera has a buffer area. It temporarily holds data up to a certain limit. Enter a number to decide how many images to capture before a trigger is activated. Up to 7 images can be generated.

**Send post-event images:** Enter a number to decide how many images to capture after a trigger is activated. Up to 7 images can be generated.

**File name prefix:** Enter the text that will be appended to the front of the file name.

**Add date and time suffix to the file name:** Select this option to add a date/time suffix to the file name.

Click **Save** to enable the settings, then click **Close** to exit the page.

The screenshot shows a 'Media Settings' window with a title bar. Inside, there is a 'Media name' field containing 'Media1'. Below it is a 'Media Type' section with three radio buttons: 'Snapshot' (selected), 'Video clip', and 'System log'. Under 'Snapshot', there is a 'Source' dropdown menu set to 'Stream 1'. Below that are two 'Send' fields: the first is set to '1' and labeled 'pre-event image(s) [0~7]', and the second is set to '7' and labeled 'post-event image(s) [0~7]'. There is a 'File name prefix' field containing 'screenshot'. A checkbox labeled 'Add date and time suffix to file name' is checked. At the bottom right, there are 'Save' and 'Close' buttons.

**Video clip:** Select to send video clips when a trigger is activated.

**Source:** Select a source of video clip.

**Pre-event recording:** The camera has a buffer area. It temporarily holds data up to a certain limit. Enter a number to decide the duration of recording before a trigger is activated. Up to 9 seconds can be set.

**Maximum duration:** Specify the maximum recording duration in seconds. Up to 20 seconds can be set. For example, if pre-event recording is set to 5 seconds and the maximum duration is set to 10 seconds, the camera continues to record for another 4 seconds after a trigger is activated.

**Maximum file size:** Specify the maximum file size allowed.

**File name prefix:** Enter the text that will be appended to the front of the file name.

Click **Save** to enable the settings, then click **Close** to exit the page.

**System log:** Select to send a system log when a trigger is activated.

Click **Save** to enable the settings, then click **Close** to exit the page. When completed, click **Save** to enable the settings and click **Close** to exit this page. The new media settings will appear on the Event Settings page.

The screenshot shows the 'Media Settings' dialog box for 'Media2'. The 'Media name' field contains 'Media2'. The 'Media Type' section has three radio buttons: 'Snapshot' (unselected), 'Video clip' (selected), and 'System log' (unselected). Below the radio buttons, there are four input fields: 'Source' is a dropdown menu showing 'Stream 3'; 'Pre-event recording' is a text box with '5' and 'seconds [0-9]'; 'Maximum duration' is a text box with '5' and 'seconds [1-20]'; 'Maximum file size' is a text box with '1500' and 'Kbytes [50-4096]'. The 'File name prefix' field contains 'videos'. At the bottom right, there are 'Save' and 'Close' buttons.

The screenshot shows the 'Media Settings' dialog box for 'Media3'. The 'Media name' field contains 'Media3'. The 'Media Type' section has three radio buttons: 'Snapshot' (unselected), 'Video clip' (unselected), and 'System log' (selected). At the bottom right, there are 'Save' and 'Close' buttons.

## Event Settings

In the Event Settings column, click **Add** to open the Event Settings page. On this page, you can arrange three elements -- Trigger, Schedule, and Action to set an event. A total of 3 event settings can be configured.

**Event name:** Enter a name for the event.

**Enable this event:** Select to activate this event.

**Priority:** Set the priority for this event (High, Normal, or Low). The event with higher priority will be executed first

**Detect next event after \* seconds:** Select the delay time before selecting the next event. It is being used for both events of motion detection and digital input trigger.

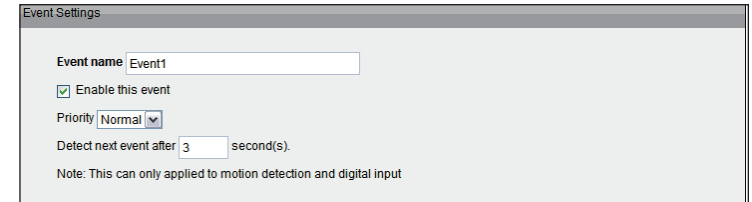

The screenshot shows a window titled "Event Settings" with the following fields and options:

- Event name:** A text input field containing "Event1".
- Enable this event:** A checked checkbox.
- Priority:** A dropdown menu set to "Normal".
- Detect next event after:** A text input field containing "3" followed by the text "second(s)".
- Note:** A small text note at the bottom stating "Note: This can only applied to motion detection and digital input".

## Trigger

This is the cause or stimulus which defines when to trigger the camera. The trigger source can be configured to use the camera's built-in motion detection mechanism or external digital input devices. There are several choices of trigger sources as shown below. Select the item to display the detailed configuration options. The input type that triggers the event.

**Video motion detection:** This option makes use of the built-in motion detection mechanism as a trigger source. To enable this function, you need to configure a Motion Detection Window first. For more information, please refer to Motion Detection for details.

**Periodically:** This option allows the camera to trigger periodically for every other defined minute. Up to 999 minutes are allowed.

**Digital input:** This option allows the camera to use an external digital input device or sensor as a trigger source. Depending on your application, there are many choices of digital input devices on the market which helps to detect changes in temperature, vibration, sound, and light, etc.

**System boot:** This option triggers the camera when the power to the camera is disconnected.

**Recording notify:** This option allows the camera to trigger when the recording disk is full or when recording starts to rewrite older data.

**Camera tampering detection:** This option allows the camera to trigger when the camera detects that it is being tampered with. To enable this function, you need to configure the Tamper detection option first. Please refer to Tamper detection for detailed information.

The screenshot shows the 'Event Settings' configuration window. At the top, the 'Event name' is 'Event2'. The 'Enable this event' checkbox is checked. The 'Priority' is set to 'Normal'. The 'Detect next event after' is set to 5 seconds. A note states: 'Note: This can only applied to motion detection and digital input'. The 'Trigger' section has radio buttons for 'Video motion detection', 'Periodically', 'Digital input', 'System boot', 'Recording notify', and 'Camera Tampering Detection', with the last one selected. A note below says: 'Note: Please configure Camera Tampering Detection first'. The 'Event Schedule' section has checkboxes for days of the week (Sun, Mon, Tue, Wed, Thu, Fri, Sat), with Sun, Mon, Tue, Wed, Thu, and Fri checked. The 'Time' section has radio buttons for 'Always' and 'From 08:00 to 18:00 [hh:mm]', with the latter selected. The 'Action' section has a checkbox for 'Trigger digital output for 1 seconds'. Below this are 'Add Server' and 'Add Media' buttons. A table lists servers and media: Server1 (Media1), Server2 (None), Server3 (None), and Server4 (Media2). The 'Server4' row has a checked checkbox for 'Create folders by date time and hour automatically'. There are 'SD Test' and 'View' buttons for the SD row, and a 'View' button for the Server4 row. At the bottom right are 'Save' and 'Close' buttons.



### **Event Schedule**

Specify the period for the event

1. Select the days of the week.
2. Select the recording schedule in 24-hr time format.

### **Action**

Define the actions to be performed by the camera when a trigger is activated.

To set an event with recorded video or snapshots, it is necessary to configure the server and media setting so that the camera will know what action to take (i.e. the server to send the media files to) when a trigger is activated.

- **Add Server:** same as Server Settings
- **Add Media:** same as Media Settings

# Recording

## Recording Settings

Click **Add** to open the recording setting page. In this page, you can define the recording source, recording schedule, and recording capacity. A total of 2 recording setting can be configured.

**Recording name:** Enter a name for the recording setting.

**Enable this recording:** Select this option to enable video recording.

**Priority:** Select the relative importance of this recording setting (High, Normal, and Low).

**Source:** Select the recording source (stream 1 ~ 3).

**Trigger:** Select a trigger source.

**Schedule:** The server will start to record files on the network storage (NAS).

**Recording Schedule:** Specify the recording duration.

1. Select the days of the week.
2. Select the recording start and end times in 24-hr time format.

**Destination:** You can select the network storage or local SD card that was set up for the recorded video files.

**Capacity:** You can choose either the entire free space available or limit the reserved space. The recording size limit must be larger than the reserved amount for cyclic recording.

**File name prefix:** Enter the text that will be appended to the front of the file name.

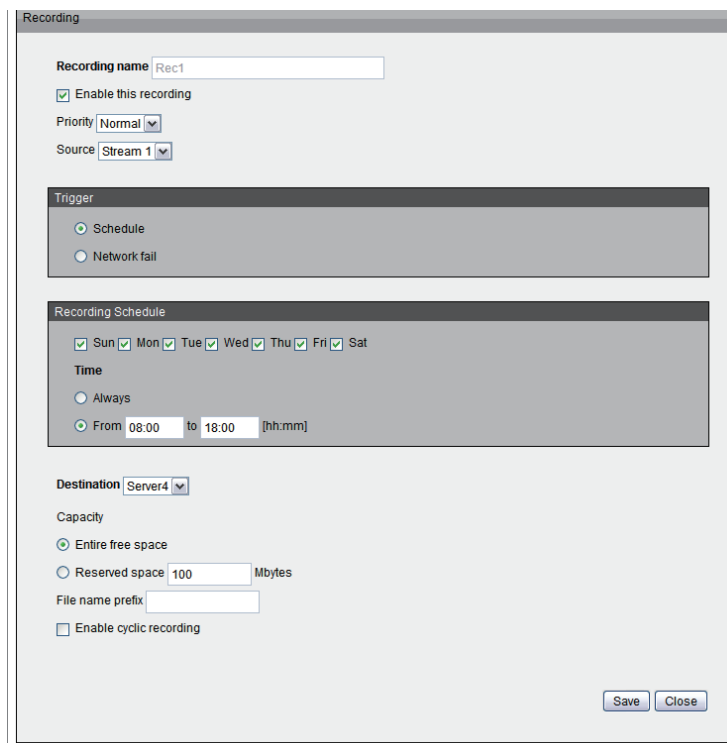
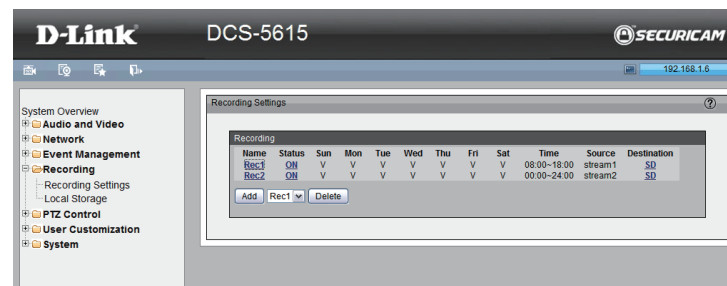

**Enable cyclic recording:** If you select this item, when the maximum capacity is reached, the oldest file will be overwritten by the latest one. The reserved amount is reserved for cyclic recording to prevent malfunction. This value must be larger than 15 Mbytes.

If you want to enable recording notification, please click **Application** to set up. Please refer to Trigger > Recording notify for detailed information.

When completed, select Enable this recording. Click **Save** to enable the setting and click **Close** to exit this page. When the system begins recording, it will send the recorded files to the Network Storage.

The new recording name will appear in the drop-down list on the recording page.

To remove a recording setting from the list, select a recording name from the drop-down list and click **Delete**.

# Local Storage

This section explains how to manage the local storage on the Network Camera. Here you can view SD card status, search for recorded files to playback, download, etc.

## SD Card Management

**SD card status:** This column shows the status and reserved space of your SD card. Please remember to format the SD card when using for the first time.

**SD card control:** Enable cyclic storage: Check this item if you want to enable cyclic recording. When the maximum capacity is reached, the oldest file will be overwritten by the latest one.

**Enable automatic disk cleanup:** Check this item and enter the number of days you wish to retain a file. For example, if you enter “7 days”, the recorded files will be stored on the SD card for 7 days. Click **Save** to enable your settings.

## Searching and Viewing the Records

This column allows the user to set up search criteria for recorded data. If you do not select any criteria and click the Search button, all recorded data will be listed in the Search Results column.

**File attributes:** Select one or more items as your search criteria.

**Trigger time:** Manually enter the time range you want to search. Click **Search** and the recorded data corresponding to the search criteria will be listed in Search Results Window.

## Search Results

This area will show the search results. There are four columns: Trigger time, Media type, Trigger type, and Locked. Click up and down arrow to sort the search results in either direction.

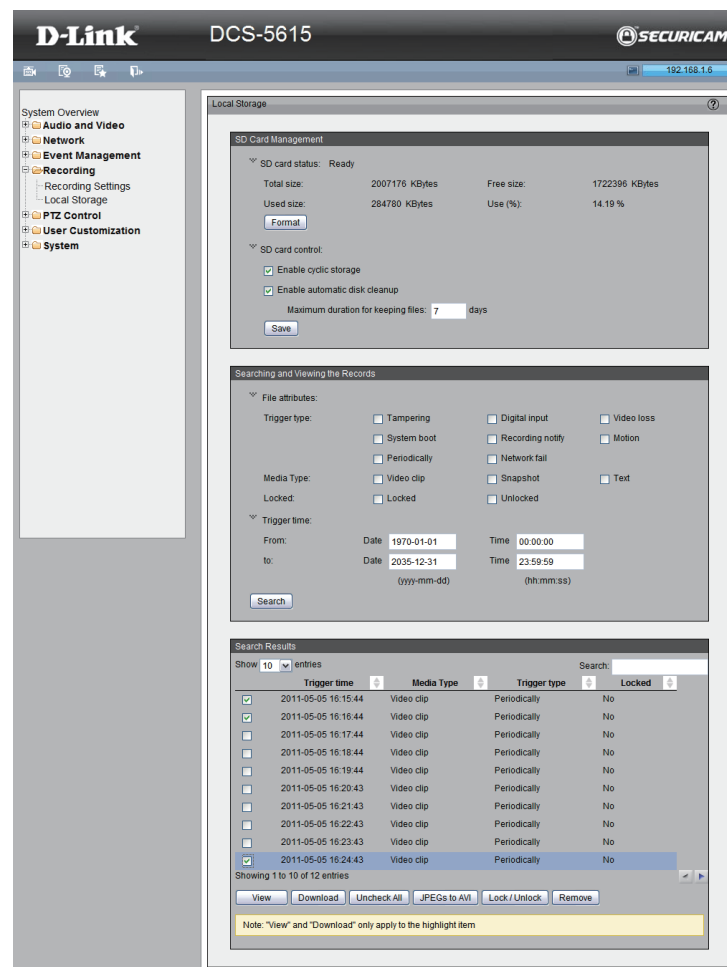

# PTZ Control

## Mechanical Pan Tilt

You can set a total of 20 preset positions and select preset positions for the camera to patrol.

Please follow the steps below to preset a position:

1. Adjust the shooting area to the desired position using the buttons on the right side of the window.
2. Enter a name for the preset position, which allows for up to 40 characters. Click **Add** to enable the Setting. The preset positions will be displayed under the Preset Location list on the left-hand side.
3. To add additional preset positions, please repeat steps 1~2.
4. To remove a preset position from the list, select it from the drop-down list and click **Delete**.
5. The preset positions will also be displayed on the main page. Please refer to the illustration on the next page.
6. Click **Save** to enable the setting. The Preset Positions will also be displayed on the Live Video. Select one from the drop-down list and the camera will move to the selected preset position.

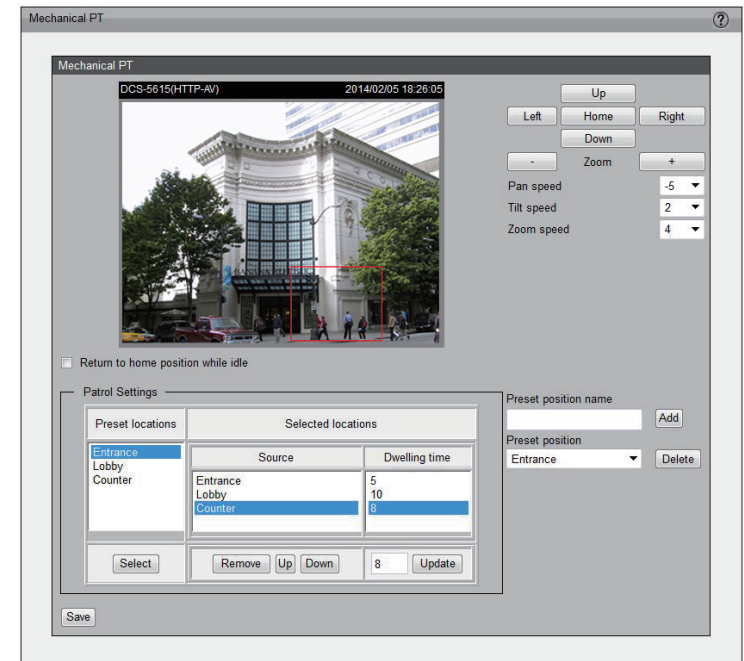

### Patrol Setting

You can select some preset positions for the camera to patrol.

Please follow the steps below to set up a patrol schedule:

1. Click a preset location on the list and click **Select**.
2. The selected preset location will be displayed on the Source list.
3. Set the Dwelling time for the preset location during auto patrol. You can also manually enter a value in the blank and click **Update**.
4. Repeat step 1 and 3 to select additional preset locations.
5. If you want to delete a selected location, select it from the Source list and click **Remove**.
6. Select a location and click **Up** or **Down** to rearrange the patrol order.
7. Click **Save** to enable the setting.

# User Customization

## Live Video Page Configuration

**Preview:** It shows the new layout of Logo/Background/Title based on user setting.

**Logo Graphic:** You can change the logo at the top of your Live Video page.

Follow the steps below to upload a new logo:

1. Click **Custom** and the Browse field will appear.
2. Select a logo from your files.
3. Click **Upload** to replace the existing logo with a new one.
4. Enter a website link if necessary.
5. Click **Save** to enable the setting.

**Background:** You can change the color of your Live Video page background.

Follow the steps below to set up the customized Live Video page.

1. Click **Custom** on the left column.
2. Click the field where you want to change the color on the right column.
3. The palette window will pop up as shown below.
4. Drag the slider bar and click on the left square to select a desired color.
5. The selected color will be displayed in the corresponding fields and in the Preview column.

Click **Save** to enable the setting.

**Title:** You can also change the title at the top of your Live Video page.

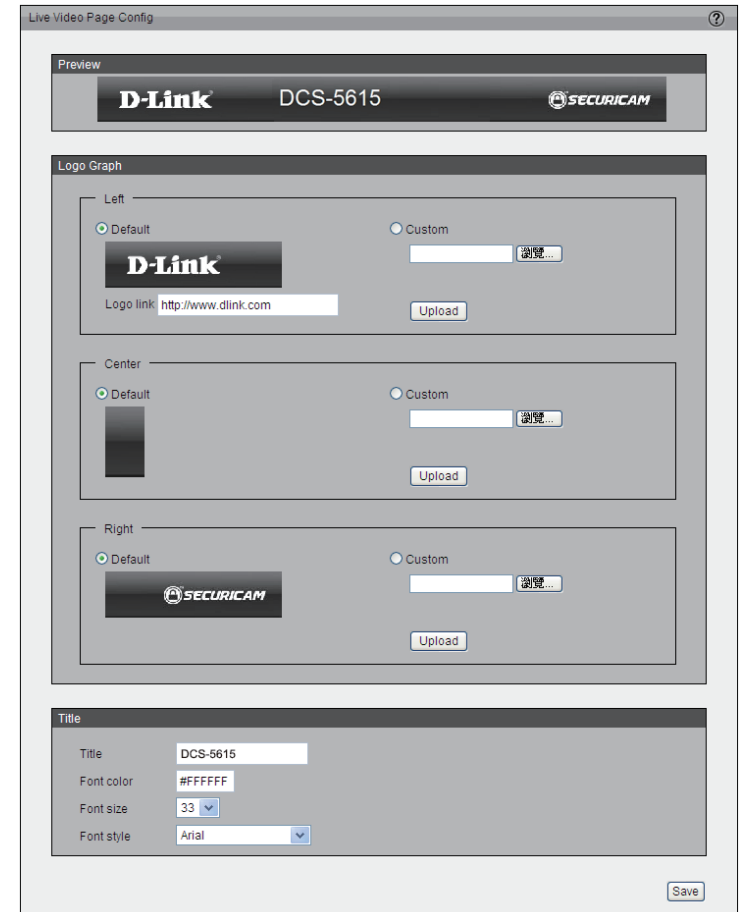

# HTML Code Examples

This page can generate example HTML code for you, thus you can paste the code into your own web page and get the embedded live video feed.

## Stream:

Select from stream 1 to 3, it will base on the profile of selected stream to generate the code accordingly. Up to 10 clients are supported for live view.

## Live Stream:

- H.264/MPEG4/MJPEG using ActiveX for IE:**  
 If target remote user client use Internet Explorer(IE), then the example code can support H.264, MPEG4 and MJPEG stream.
- H.264/MPEG4 using QuickTime plug-in for FireFox**  
 If target remote user client use QuickTime plug-in for the FireFox, then the example code can only support H.264 and MPEG4 stream.
- MJPEG using Server Push for FireFox**  
 If target remote user client use FireFox, then the example code can only support MJPEG stream.

## Still Image Format:

- Refresh interval second:**  
 If user only need to embedded still image in the browser, please use this option and setup the refresh interval of the still image.

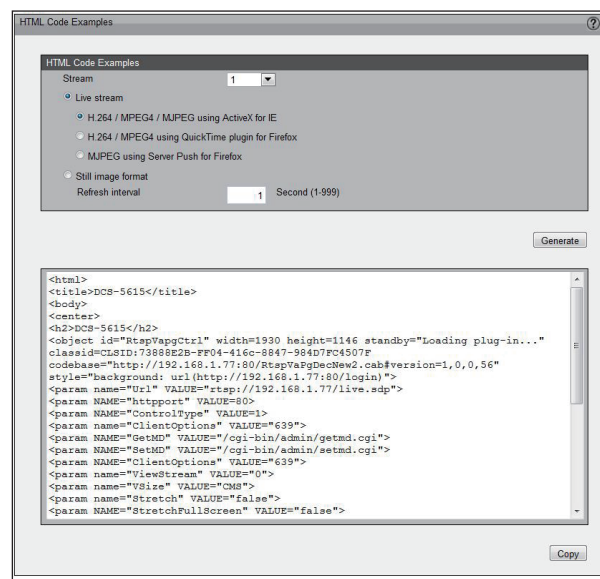

# System User Settings

This section explains how to enable password protection and create multiple accounts.

## Admin Password Setup:

The administrator account name is “admin”, which is permanent and cannot be deleted. The default of password is empty.

**Add user account:** Add a new user account.

**Username:** Enter a username for the new account.

**Password:** Enter a password for the new account.

**Privilege:** Select the access rights for the new user.

**Manage user:** Manage the accounts for existing users.

**Authentication:** The access rights for existing users.

The screenshot displays the 'User Settings' web interface, which is organized into three main sections:

- Admin Password Setup:** This section contains two password input fields labeled 'Password:' and 'Retype password:', both filled with dots. A 'Save' button is located below these fields.
- Add User Account:** This section includes a 'User name:' field with the value 'Carrie', a 'Password:' field with dots, and a 'Confirm password:' field with dots. Below these are three radio button options for 'Privilege': 'Administrator', 'Normal user' (which is selected), and 'Guest'. An 'Add' button is positioned at the bottom of this section.
- Manage User:** This section features a 'User name:' dropdown menu currently showing 'User1', a 'User password:' field with dots, and three radio button options for 'Authentication': 'Administrator', 'Normal user' (which is selected), and 'Guest'. 'Modify' and 'Delete' buttons are located at the bottom of this section.



# Device Settings

**Turn off the LED indicator:** Select this option to turn off the LED next to the lens. This will prevent anyone from observing the operation of the network camera.

**Camera Name:** Create a unique name for your camera.

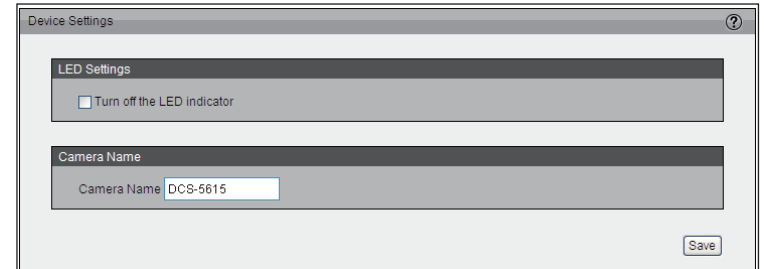

# Time and Date

Automatically or manually configure, update, and maintain the internal system clock for your camera.

**Time Zone:** Select your time zone from the drop-down menu.

**Automatic Time Configuration:** Enable this feature to obtain time configuration automatically from NTP server.

**NTP Server:** Network Time Protocol (NTP) synchronizes the network camera with an Internet time server. Choose the one that is closest to your location.

**Update Interval:** The time interval for updating the time information from NTP server.

**Set the date and time manually:** This option allows you to set the time and date manually.

**Copy Your Computer's Time Setting:** This will synchronize the time information from your PC.

The screenshot shows the 'Time Configuration' web interface. It is divided into three main sections:

- Time Configuration:** Features a 'Time zone' dropdown menu currently set to 'GMT+08:00 Beijing, Chongqing, Hong Kong, Kuala Lumpur, Singapore, Taipei'. Below this is a yellow note box stating: 'Note: You can upload your Daylight Saving Time rules on [Maintenance](#) page or use the camera default value.'
- Automatic Time Configuration:** Includes a checked checkbox for 'Enable Automatic Time Configuration'. Below it is an 'NTP server' dropdown menu with a '<< Select NTP server' button, and an 'Updating interval' dropdown menu set to 'One hour'.
- Set the Date and Time Manually:** Contains six dropdown menus for 'Year' (2011), 'Month' (05), 'Day' (05), 'Hour' (17), 'Minute' (19), and 'Second' (25). A 'Copy Your Computer's Time Settings' button is located at the bottom of this section.

# Maintenance

This section explains how to restore the camera to factory default, upgrade firmware version, etc.

**Reboot:** This feature allows you to reboot the camera, which takes about one minute to complete.

If the connection fails after rebooting, manually enter the IP address of the camera in the address field to resume the connection.

**Restore to default:** This feature allows you to restore the camera to factory default setting. If "Network" is enable, the network setting will be kept after reboot.

**Export / Upload Files:** This feature allows you to Export / Upload daylight saving time rules, custom language files, and setting backup files.

Export daylight saving time configuration file: Click to set the start and end time of DST.

Follow the steps below to export:

1. In the Export files column, click **Export** to export the daylight saving time configuration file from the camera.
2. A file download dialog will pop up as shown below. Click **Open** to review the XML file or click **Save** to store the file for editing.
3. Open the file with Microsoft® Notepad and locate your time zone. Set the start and end time of DST.
4. When completed, save the file

**Upload daylight saving time rule:** Click **Browse...** and specify the XML file to upload.

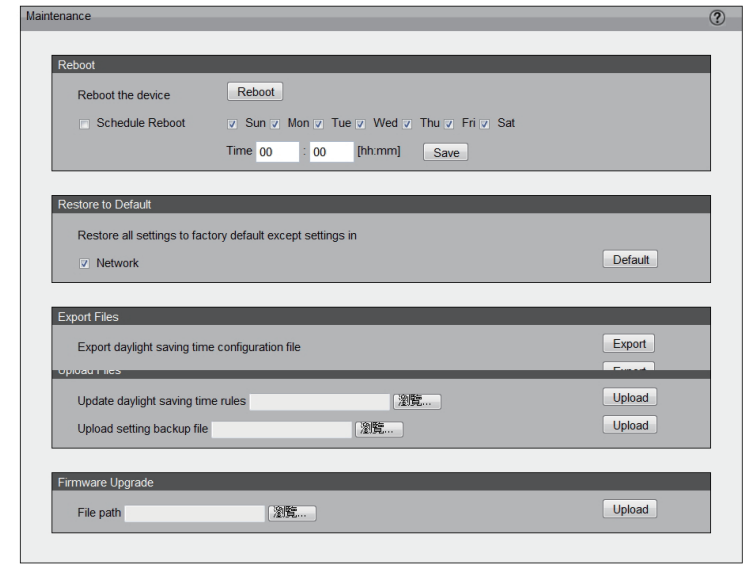

**Export language file:** Click to export language strings.  
Provides 5 languages: English, Deutsch, Español, Français, Italiano.

Upload custom language file: Click **Browse...** and specify your own custom language file to upload.

**Export setting backup file:** Click to export all parameters for the device and user-defined scripts.

Upload setting backup file: Click **Browse...** to upload a setting backup file. Please note that the model and firmware version of the device should be the same as the setting backup file. If you have set up a fixed IP or other special settings for your device, it is not suggested to upload a settings backup file.

**Firmware upgrade:** This feature allows you to upgrade the firmware of your camera. It takes a few minutes to complete the process.

**Note: Do not power off the camera during the upgrade!**

Follow the steps below to upgrade the firmware:

1. Download the latest firmware file from the D-Link website. The file is in .pkg file format.
2. Click **Browse...** and specify the firmware file.
3. Click **Upgrade**. The camera starts to upgrade and will reboot automatically when the upgrade completes.

If the upgrade is successful, you will see “Reboot system now!! This connection will close”. After that, re-access the camera.

# Parameter List

The Parameters List page lists the entire system's parameters in alphabetical order. If you need technical assistance, please provide the information listed on this page.

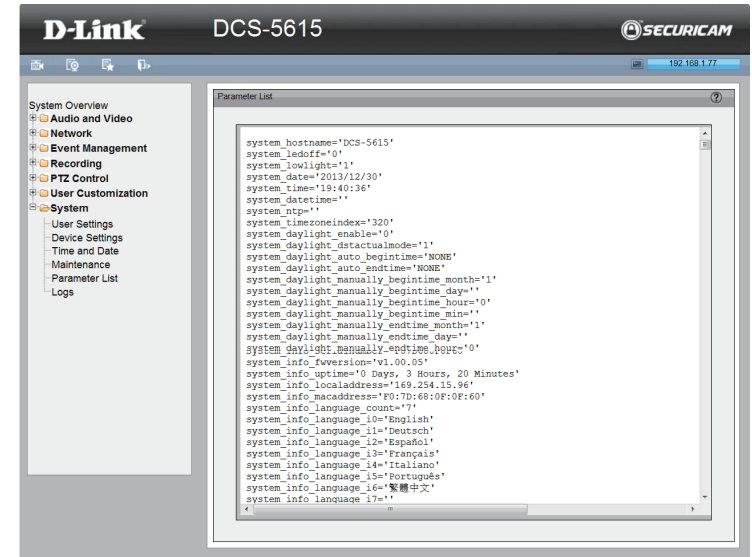

# Logs

This section explains how to configure the camera to send the system log to the remote server as backup.

**Remote Log:** You can configure the camera to send the system log file to a remote server as a log backup. Before utilizing this feature, it is suggested that the a log-recording tool be first installed on the remote server to receive system log messages from the camera. Be sure to note the IP address of the remote server.

Follow the steps below to set up the remote log:

1. In the IP address text box, enter the IP address of the remote server.
2. In the port text box, enter the port number of the remote server.
3. When completed, check **Enable remote log** and click **Save** to enable the setting.

**Current Log:** This column displays the system log in chronological order. The system log is stored in the camera's buffer area and will be overwritten when reaching a certain limit.

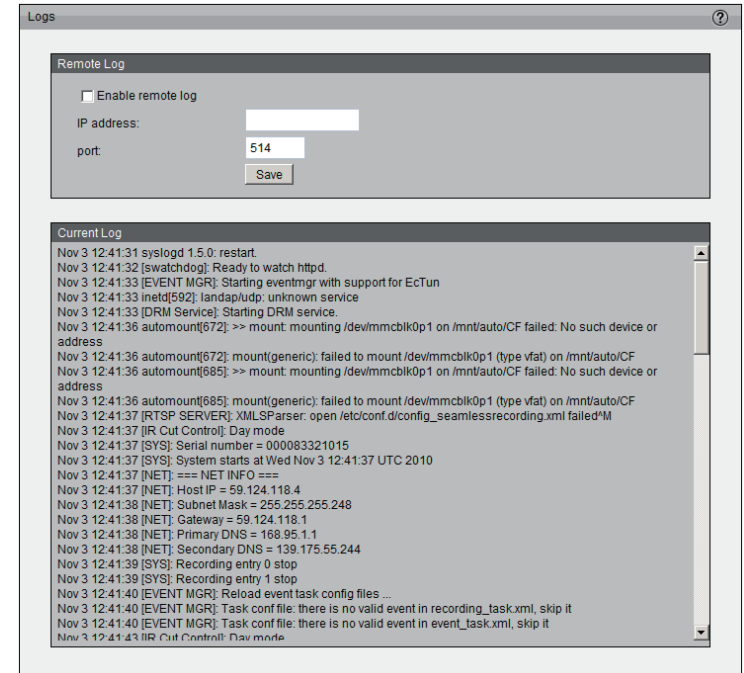

# Technical Specifications

|                    |   |  |   |
|--------------------|---|--|---|
| Camera             | <b>Hardware Profile</b>                                 | <ul style="list-style-type: none"> <li>• 1/2.7" Full HD progressive megapixel CMOS sensor</li> <li>• Fixed lens 4mm</li> <li>• Aperture F1.5</li> <li>• 16 x Digital Zoom</li> <li>• Minimum illumination 0.88 lux</li> <li>• Shutter Speed: 1/5~1/32,000s</li> </ul>              | <ul style="list-style-type: none"> <li>• Minimum Object Distance 40 cm</li> <li>• Angle of view:<br/>(H) 77.4°<br/>(V) 45.1°<br/>(D) 88°</li> </ul>   |
|                    | <b>Pan &amp; Tilt</b>                                   | <ul style="list-style-type: none"> <li>• Pan/Tilt range<br/>Pan range: 360° (-180 to 180)°<br/>Tilt range: 80° (10 to 90°)</li> </ul>  | <ul style="list-style-type: none"> <li>• Pan/Tilt speed:<br/>Pan speed: 101°/second<br/>Tilt speed: 101°/second</li> </ul>  |
|                    | <b>Image Features</b>                                   | <ul style="list-style-type: none"> <li>• Configurable image size, quality, and bit rate</li> <li>• Time stamp and text overlays</li> <li>• 3 configurable motion detection windows</li> </ul>  | <ul style="list-style-type: none"> <li>• Flip &amp; mirror</li> <li>• Configurable white balance, shutter speed, brightness, saturation, contrast, sharpness</li> </ul>   |
|                    | <b>Video Compression</b>                                | <ul style="list-style-type: none"> <li>• H.264/MPEG4/MJPEG simultaneous format compression</li> <li>• JPEG for still image</li> </ul>  | <ul style="list-style-type: none"> <li>• H.264/MPEG-4 multicast streaming</li> </ul>  |
|                    | <b>Video Resolution</b>                                 | <ul style="list-style-type: none"> <li>• 1920 x 1080 at 15 fps</li> <li>• 1600 x 904 at 20 fps</li> <li>• 1360 x 768 at 25 fps</li> <li>• 1280 x 720 at 30 fps</li> </ul>  | <ul style="list-style-type: none"> <li>• 640 x 480 at 30 fps</li> <li>• 384 x 216 at 30 fps</li> </ul>  |
|                    | <b>Audio Features</b>                                   | <ul style="list-style-type: none"> <li>• G.711</li> </ul>  | <ul style="list-style-type: none"> <li>• MPEG-4 AAC</li> </ul>  |
|                    | <b>External Device Interface</b>                        | <ul style="list-style-type: none"> <li>• DI for external sensor and alarm</li> <li>• microSD card slot</li> </ul>  | <ul style="list-style-type: none"> <li>• 10/100 BASE-TX Ethernet port with PoE</li> <li>• 12V DC jack</li> </ul>  |
| Network            | <b>Network Protocols</b>                                | <ul style="list-style-type: none"> <li>• IPv4</li> <li>• IPv6</li> <li>• TCP/IP</li> <li>• UDP</li> <li>• ICMP</li> <li>• DHCP Client</li> <li>• NTP Client (D-Link)</li> <li>• DNS Client</li> <li>• DDNS Client (D-Link)</li> <li>• SMTP Client</li> <li>• FTP Client</li> </ul> | <ul style="list-style-type: none"> <li>• HTTP/HTTPS</li> <li>• Samba Client</li> <li>• PPPoE</li> <li>• UPnP Port Forwarding</li> <li>• RTP/RTSP/RTCP</li> <li>• IP filtering</li> <li>• CoS/QoS</li> <li>• SNMP</li> <li>• IGMP</li> <li>• 802.1x</li> </ul> |
|                    | <b>Security</b>   | <ul style="list-style-type: none"> <li>• Administrator and user group protection</li> <li>• Password authentication</li> </ul>   | <ul style="list-style-type: none"> <li>• HTTPS streaming</li> <li>• Remote client access control</li> </ul>   |
| System Integration | <b>System Requirements</b>                              | <ul style="list-style-type: none"> <li>• Operating system: Microsoft Windows 8, 7, Vista</li> </ul>  | <ul style="list-style-type: none"> <li>• Browser: Internet Explorer 7 or higher</li> </ul>  |
|                    | <b>D-ViewCam™ System Requirements for Web Interface</b> | <ul style="list-style-type: none"> <li>• Operating System: Microsoft Windows 8, 7, Vista</li> <li>• Web Browser: Internet Explorer 7 or higher</li> </ul>  | <ul style="list-style-type: none"> <li>• Protocol: Standard TCP/IP</li> </ul>   |

# Appendix A - Technical Specifications

|            |   |   |   |  |
|------------|---|---|---|--|
|            | <b>Event Management</b>   | <ul style="list-style-type: none"> <li>• Motion detection</li> <li>• Tamper detection</li> <li>• Event notification and upload snapshots/video clips via HTTP, SMTP or FTP</li> </ul> | <ul style="list-style-type: none"> <li>• Multiple event notification</li> <li>• Multiple recording methods for easy backup</li> <li>• Supports multiple HTTP, SMTP and FTP servers</li> </ul> |  |
|            | <b>Remote Management</b>  | <ul style="list-style-type: none"> <li>• Take snapshots/video clips and save to local hard drive via web browser</li> </ul>   | <ul style="list-style-type: none"> <li>• Configuration accessible via web browser</li> </ul>  |  |
|            | <b>Surveillance Software Function</b>   | <ul style="list-style-type: none"> <li>• Supports all management functions provided in web interface</li> <li>• Scheduled motion triggered, or manual recording options</li> </ul>    | <ul style="list-style-type: none"> <li>• Remote management/control of up to 32 cameras</li> <li>• Viewing of up to 32 cameras on one screen</li> </ul>  |  |
| General    | <b>Power Input</b>  | • 12 V DC 1.5 A, 50/60 Hz, IEEE 802.3af PoE   |   |  |
|            | <b>Max. Power Consumption</b>   | • 5.8 W   |   |  |
|            | <b>Operating Temperature</b>  | • 0 to 40 °C (32 to 104 °F)   |   |  |
|            | <b>Storage Temperature</b>  | • -20 to 70 °C (-4 to 158 °F)   |   |  |
|            | <b>Humidity</b>   | • 90% non-condensing  | • Storage: 5% to 95% non-condensing   |  |
|            | <b>Weight</b>   | • 210 g (0.46 lbs)  |   |  |
|            | <b>Certifications</b>   | <ul style="list-style-type: none"> <li>• CE (Class A)</li> <li>• CE LVD (EN60965-1)</li> <li>• FCC (Class A)</li> </ul>   | <ul style="list-style-type: none"> <li>• ICES-003</li> <li>• C-Tick</li> </ul>  |  |
| Dimensions | <p>The image contains two technical drawings of the DCS-5615 camera. On the left is a top-down view showing a circular camera with a lens in the center and a mounting bracket on the left side. A diagonal dimension line indicates a diameter of 116.34 mm. On the right is a side view showing the camera's profile, which is dome-shaped with a flat base. A vertical dimension line indicates a height of 56.7 mm.</p> |   |   |  |