

User Manual

AC1900 Wi-Fi Router

DIR-879

Preface

D-Link reserves the right to revise this publication and to make changes in the content hereof without obligation to notify any person or organization of such revisions or changes.

Manual Revisions

Revision	Date	Description
1.00	February 4, 2016	Initial release
1.01	May 31, 2016	Added Wireless Extender Mode

Trademarks

D-Link and the D-Link logo are trademarks or registered trademarks of D-Link Corporation or its subsidiaries in the United States or other countries. All other company or product names mentioned herein are trademarks or registered trademarks of their respective companies.

Apple®, Apple logo®, Safari®, iPhone®, iPad®, iPod touch® and Macintosh® are trademarks of Apple Inc., registered in the U.S. and other countries. App StoreSM is a service mark of Apple Inc.

Chrome™ browser, Google Play™ and Android™ are trademarks of Google Inc.

Internet Explorer®, Windows® and the Windows logo are trademarks of the Microsoft group of companies.

Copyright © 2016 by D-Link Corporation, Inc.

All rights reserved. This publication may not be reproduced, in whole or in part, without prior expressed written permission from D-Link Corporation, Inc.

Power Usage

This device is an Energy Related Product (ErP) with High Network Availability (HiNA), and automatically switches to a power-saving Network Standby mode within 1 minute of no packets being transmitted. It can also be turned off through a power switch to save energy when it is not needed.

Network Standby: 5.82 watts

Switched Off: 0.08 watts

Table of Contents

Product Overview.....	1	Wizard	31
Package Contents.....	1	Installation - Access Point	37
System Requirements	2	Before you Begin.....	37
Introduction	3	Wireless Installation Considerations.....	38
Features.....	5	Hardware Setup	39
Hardware Overview	6	Configuration - Router Mode.....	41
LED Indicator	6	Home	42
Back Panel	7	Internet.....	42
Choosing an Operation Mode	8	DIR-879	43
Router Mode	9	Connected Clients	44
Extender Mode	10	Settings	45
Wireless Extender	11	Wizard	45
Access Point	12	Internet.....	45
Installation - Router.....	13	IPv6	55
Before you Begin.....	13	Wireless	72
Wireless Installation Considerations.....	14	Guest Zone	75
Hardware Setup	15	Network.....	76
Completing Setup	18	Features.....	78
QRS Mobile App	19	QoS Engine.....	78
Setup Wizard	24	Firewall Settings	79
Installation - Wireless Extender.....	28	IPv4/IPv6 Rules	81
Before you Begin.....	28	Port Forwarding	82
Wireless Installation Considerations.....	29	Virtual Server	83
Hardware Setup	30	Website Filter.....	84
Connect to an Uplink Network using the Setup		Static Routes.....	85
		IPv6	86

Dynamic DNS	87	Connect a Wireless Client to your Router	112
IPv6 Host	88	WPS Button.....	112
Management.....	89	Windows® 10	113
Time & Schedule	89	Windows® 8.....	115
Time	89	WPA/WPA2	115
Schedule	90	Windows® 7.....	117
System Log.....	91	WPA/WPA2	117
Admin	93	WPS.....	120
System	94	Windows Vista®	124
Upgrade	95	WPA/WPA2	125
Statistics	96	Troubleshooting	127
Configuration - Extender Mode.....	97	Wireless Basics	131
Settings	97	What is Wireless?.....	132
Home	98	Tips.....	134
DIR-879	99	Wireless Modes.....	135
Connected Clients	100	Networking Basics	136
Extender.....	101	Check your IP address.....	136
Network.....	104	Statically Assign an IP address	137
Management.....	105	Wireless Security	138
Time & Schedule	105	What is WPA?	138
Time	105	Technical Specifications	139
Schedule	106	Regulatory Statements	140
System Log.....	107		
Admin	109		
System	110		
Upgrade	111		

Package Contents



DIR-879 AC1900 Wi-Fi Router



Ethernet Cable



Power Adapter



Wi-Fi Configuration Card



Wall-Mount Hardware

If any of the above items are missing, please contact your reseller.

Note: Using a power supply with a different voltage rating than the one included with the DIR-879 will cause damage and void the warranty for this product.

System Requirements

Network Requirements	<ul style="list-style-type: none">• An Ethernet-based cable or DSL modem• IEEE 802.11 ac/n/g/b/a wireless clients• 10/100 Ethernet
Web-based Configuration Utility Requirements	<p>Computer with the following:</p> <ul style="list-style-type: none">• Windows®, Macintosh, or Linux-based operating system• An installed Ethernet adapter <p>Browser Requirements:</p> <ul style="list-style-type: none">• Internet Explorer 10 or higher• Firefox 28 or higher• Safari 6 or higher• Chrome 28 or higher <p>Windows® Users: Make sure you have the latest version of Java installed. Visit www.java.com to download the latest version.</p>
QRS Mobile Requirements	<ul style="list-style-type: none">• iPhone®/iPad®/iPod Touch® (iOS 7.0 or higher)• Android™ device (2.3.3 or higher)

Introduction

The D-Link DIR-879 AC1900 Wi-Fi Router shares your Internet connection over a blazing-fast Gigabit Wireless AC connection of up to 1900 Mbps (Up to 1300 Mbps 5 GHz Wireless AC and up to 600 Mbps 2.4 GHz Wireless N)¹, using advanced AC technology to maximize the speed and range of your wireless signal. Equipped with one Gigabit WAN/Internet port and four Gigabit LAN ports to provide speeds up to 10 times faster than standard 10/100 ports, the DIR-879 creates the best networking experience to date. With the addition of advanced Quality of Service (QoS), data streams are separated, which helps organize and prioritize your network traffic so your computers, game consoles, 3D/4K video streaming, gaming, and VoIP calls run smoother over both your wired and wireless network.

The DIR-879 features the strongest and most sensitive wireless radio we've ever built, offering four times the power of a typical wireless router², letting you blanket large areas or multi-story buildings with Wi-Fi. The DIR-879's superior design allows you to enjoy full motion, high definition video calls on your mobile device while moving. Featuring a 3 x 4 Multiple In Multiple Out (MIMO) antenna, the DIR-879 offers better data rates, fewer dead-spots, more coverage, and higher reliability. Operating exclusively in the 5 GHz band, the DIR-879's 802.11ac wireless connections avoid crowded the 2.4 GHz band traffic, allowing you faster speeds while still maintaining backwards compatibility with older 802.11n/g/b devices. The DIR-879 prepares your home to become a Connected Home by bringing Wi-Fi to places your old signal can't reach. A stronger Wi-Fi signal means you can install more wireless surveillance cameras, baby monitors, sensors, and alarms in the places where you need them.

The versatile DIR-879 can assist you in solving your unique networking challenges thanks to its mode switch. In router mode, the DIR-879 operates as a traditional router, sharing your Internet connection. In extender mode, the DIR-879 connects and works with your existing networking equipment to extend the range and enhance the capabilities of your home or office network. This means you can bring Wi-Fi to places where your current signal doesn't reach, letting you go from room to room, office to office, floor to floor, or yard to yard without losing signal.

The DIR-879's Smart Connect Technology makes connecting to wireless networks easy by eliminating the confusion of multiple networks. Ever since the introduction of 5 GHz multi-band wireless technology, users have had to guess whether the 5 GHz or 2.4 GHz band network would provide them with better range and speed. Smart Connect simplifies this by only presenting a single wireless network for the user to connect to. Behind the scenes, when a connection is initiated, the DIR-879's advanced algorithms determine the best band for your device to connect to, automatically distributing devices to the optimal speed and band, thereby ensuring a faster, more reliable, and hassle-free experience for all of your users and devices.

Introduction (continued)

The DIR-879 supports the latest wireless security features to help prevent unauthorized access, be it from over a wireless network or the Internet. Support for WPA™ and WPA2™ standards ensure that you will be able to use the best possible encryption regardless of your client devices. In addition, this router is equipped with a dual-active firewall (SPI and NAT) to prevent potential attacks over the Internet.

D-Link Intelligent QoS Technology helps to increase network efficiency by analyzing network traffic and prioritizing it in order of importance. This way, two-way video, voice chat, and online gaming take priority over background network traffic such as a file downloads, ensuring you have optimal network performance.

The DIR-879 supports the latest wireless security features to help prevent unauthorized access, be it from over a wireless network or the Internet. Support for WPA™ and WPA2™ standards ensure that you will be able to use the best possible encryption regardless of your client devices. In addition, this router is equipped with a dual-active firewall (SPI and NAT) to prevent potential attacks over the Internet.

- 1 Maximum wireless signal rate derived from IEEE Standard 802.11a, 802.11g, 802.11n and 802.11ac specifications. Actual data throughput will vary. Network conditions and environmental factors, including volume of network traffic, building materials and construction, and network overhead, lower actual data throughput rate.
- 2 Determined by FCC regulation. Maximum wireless transmission power output is subject to regional radio frequency guidelines.

Features

- **Superior Wireless Networking** - The DIR-879 provides Gigabit wireless speeds of up to a combined 1900 Mbps (1300 Mbps 802.11ac 5 GHz, plus 600 Mbps 802.11n 2.4 GHz)¹. This capability rivals wired connections, allowing users to participate in real-time activities online, such as HD video communication, online gaming, and use mobile devices from anywhere in your home while still offering full 802.11n/g/b backward compatibility.
- **Extreme Wired LAN and WAN Networking** - With four 10/100/1000 Gigabit Ethernet LAN ports, and a 10/100/1000 Gigabit Ethernet WAN port, the DIR-879 has an enormous amount of bandwidth to take full advantage of the highest speed broadband connections available. Powered by a 1.0 GHz Dual Core CPU, the DIR-879 has the brains and the power to simultaneously stream multiple HD videos to set top boxes and mobile devices, participate in online gaming with consoles or PCs, run a cloud-enabled home surveillance system, and copy massive files without slowdowns, lag, or stuttering.
- **Smart Connect** - Creates a 'single' wireless network for your devices to connect to. Behind the scenes, the DIR-879 automatically determines whether to connect a device to the 2.4 or 5 GHz band, thereby providing the best speed and range for each device and optimally distributing devices to each network.
- **Advanced Firewall Features** - The web-based user interface displays a number of advanced network management features. Easily apply content filtering based on MAC address, URL, and/or domain name. Schedule these filters to be active on certain days or for a duration of hours or minutes.
- **Secure Multiple/Concurrent Sessions** - The DIR-879 can pass through VPN sessions. It supports multiple and concurrent IPSec and PPTP sessions, so users behind the DIR-879 can securely access corporate networks.
- **User-friendly Setup Wizard** - Through its easy-to-use web-based user interface or QRS Mobile (Quick Router Setup) App, the DIR-879 lets you quickly configure and secure your router to your specific settings in minutes.
- **Router or Extender Mode** - With the flick of a switch, you can easily set up your DIR-879 to operate as the core device of your network in Router Mode, or add your DIR-879 to an existing network using Extender Mode using Ethernet.

¹ Maximum wireless signal rate derived from IEEE Standard 802.11a, 802.11g, 802.11n and 802.11ac specifications. Actual data throughput will vary. Network conditions and environmental factors, including volume of network traffic, building materials and construction, and network overhead, lower actual data throughput rate. Environmental conditions will adversely affect wireless signal range.

Hardware Overview

LED Indicator

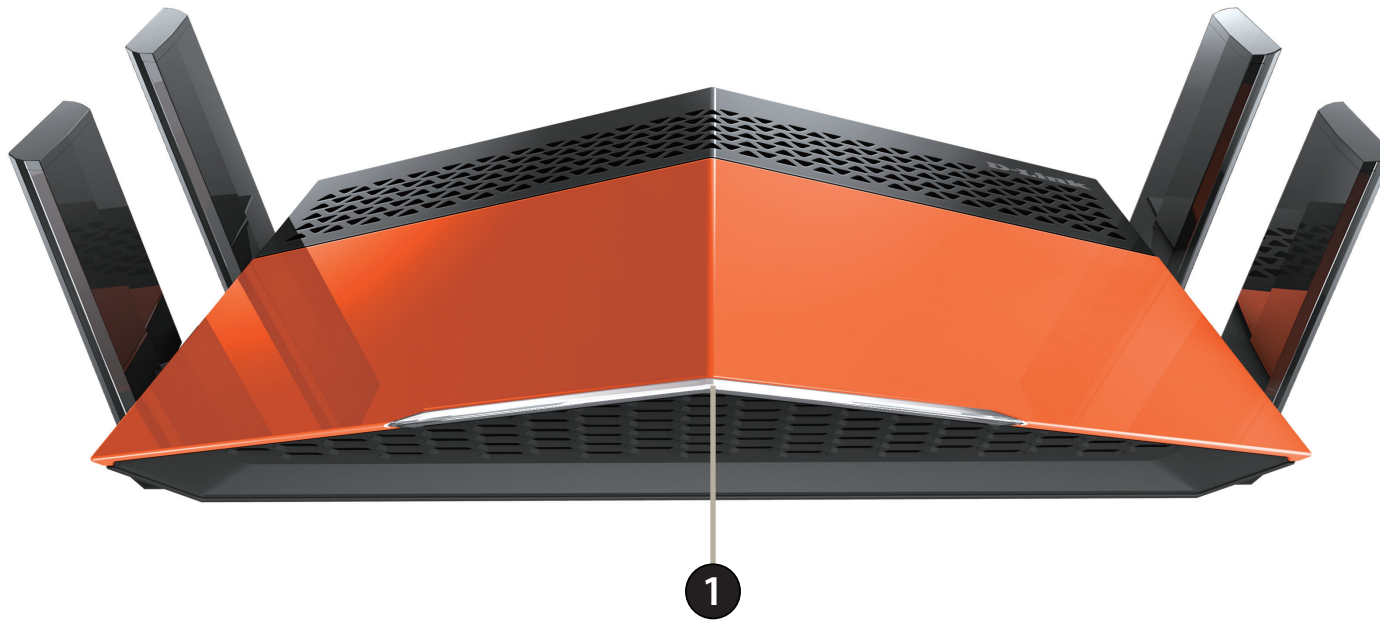

1	Power LED	Solid White	A solid white light indicates that the device is powered on, healthy, and connected to the Internet (Router Mode) or Uplink Router (Extender Mode).
		Solid Orange	A solid orange light indicates that the device is booting, undergoing a factory reset, or not connected to the Internet (Router Mode) or Uplink Router (Extender Mode).
		Blinking Orange	A blinking orange light indicates that the device is in recovery mode.
		Blinking White	A blinking white light indicates that the WPS search mode is active.

Hardware Overview

Back Panel

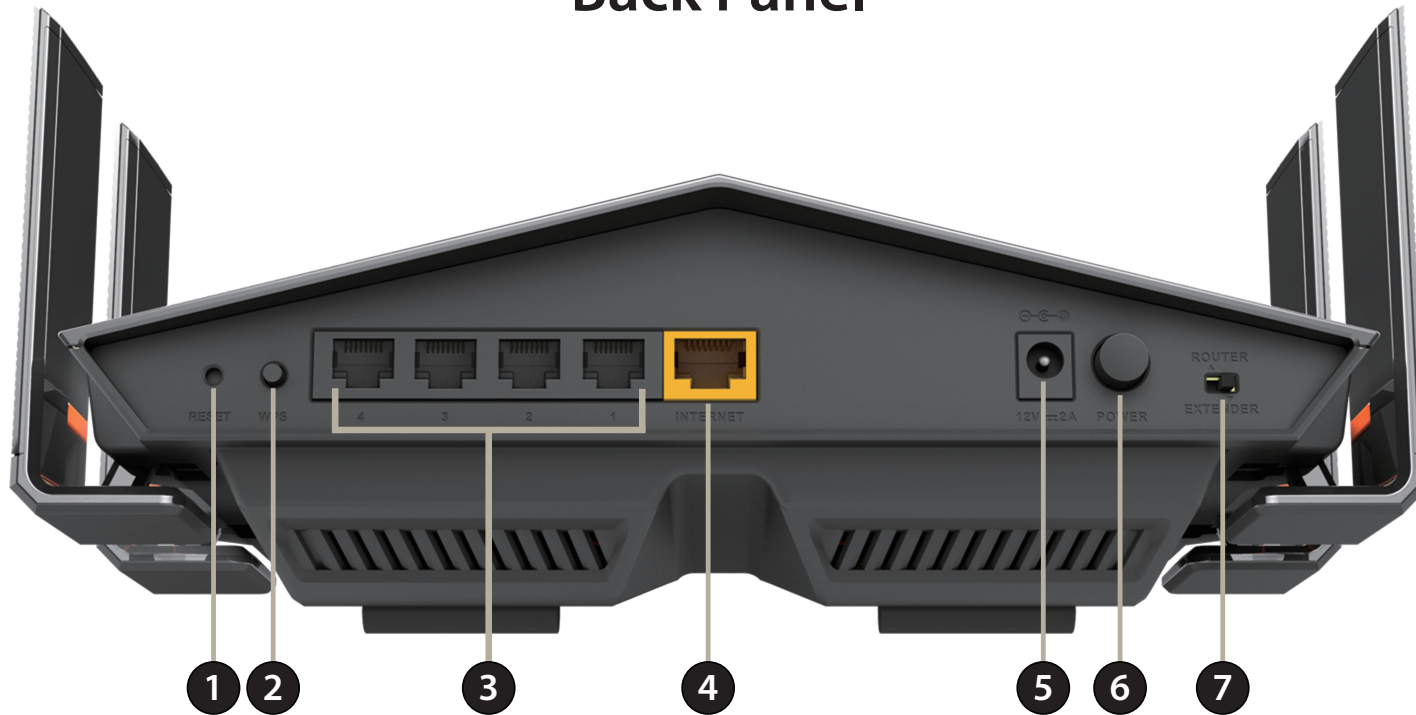

1	Reset Button	To reset the device to its factory default settings, use a paper clip press and hold the reset button for 3 seconds.
2	WPS	Press to start the WPS process and automatically create a secure connection to a WPS client.
3	LAN Ports (1-4)	Connect 10/100/1000 Ethernet devices such as computers, switches, storage (NAS) devices, and game consoles.
4	Internet Port	Using an Ethernet cable, connect your broadband modem to this port.
5	Power Connector	Connector for the supplied power adapter.
6	Power Button	Press the power button to power the DIR-879 on and off.
7	Mode Switch	Select between Router and Extender modes. To change modes, move the switch to the desired position and after 5 seconds the router will reboot into the desired mode. Router is the default mode.

Choosing an Operation Mode

The DIR-879 is equipped with a mode switch to give you more flexibility in how to configure your network. You may select either **Router Mode** or **Extender Mode**.

- **Router Mode** shares your Internet connection. This is the factory default setting suitable for most users.
- **Extender Mode** extends your existing network.

Determine your desired type of operation and adjust the mode switch before you begin your installation.

The following pages contain information about the DIR-879's operation modes to help you determine how you wish to use it. This information includes usage scenarios, cable diagrams, and network configuration information.



Note: If the mode switch is adjusted while powered on, the DIR-879 will reboot into the new mode after five seconds.

Router Mode

In **Router Mode**, the DIR-879 AC1900 Wi-Fi Router operates as the central device of your network. This is the most common type of installation and is the factory default mode switch setting suitable for most users. The DIR-879 connects to your cable modem, DSL modem, or other Internet source and shares your Internet connection with your wired and wireless devices.

Create a Home Network (Router Mode)

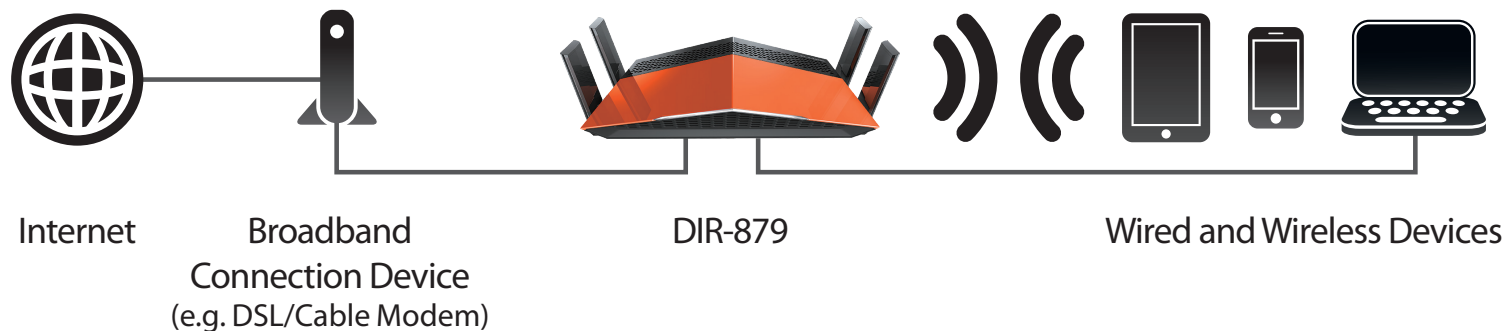

Use this mode for:

- Setting up a network for the first time.
- Replacing an existing router or network equipment.
- Adding a router to share a broadband connection which was previously connected to a single computer.

Place your DIR-879 near your Broadband Internet Connection Device (e.g. DSL/Cable Modem) and connect to it via Ethernet cable.

To use your DIR-879 as a **Router**, refer **Installation - Router** on page **13**.

Extender Mode

What is an Wireless Extender?

In Extender mode, the DIR-879 works with your existing networking equipment to provide Wi-Fi for parts of your home or office that may have poor or no reception. It works as a **Wireless Extender** by connecting to your existing wireless network and creates a new wireless network for your devices to connect to. This extended wireless network can use the same wireless network password as the existing wireless network, or you can specify a different password, giving you the flexibility to control network access. You may also use the DIR-879 as a wireless **Access Point** by connecting it to an uplink network via an Ethernet cable. This can be useful if you already have an existing router without built-in wireless capabilities or if your existing wireless signal can't bridge the distance. Devices connected to the DIR-879 obtain IP addresses from the existing uplink network.

Place the DIR-879 in an area where you wish to get Wi-Fi, but is reachable by wireless signals or an Ethernet cable from your uplink network.

Existing Wi-Fi Range

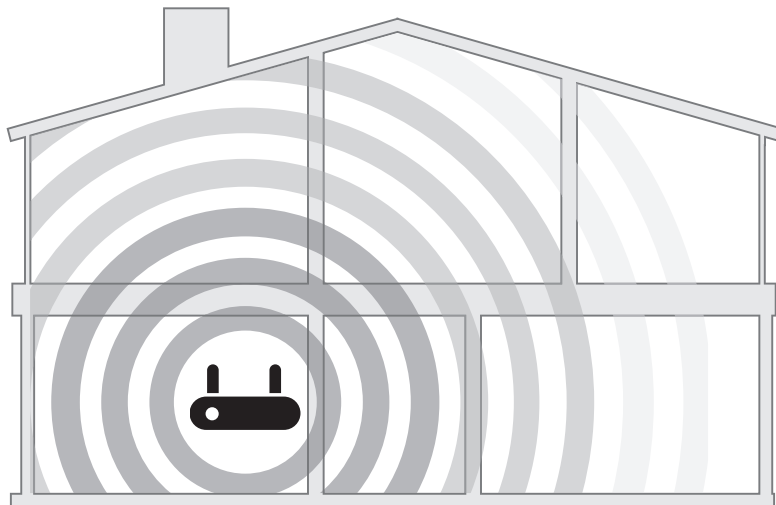

Wi-Fi Range with DIR-879

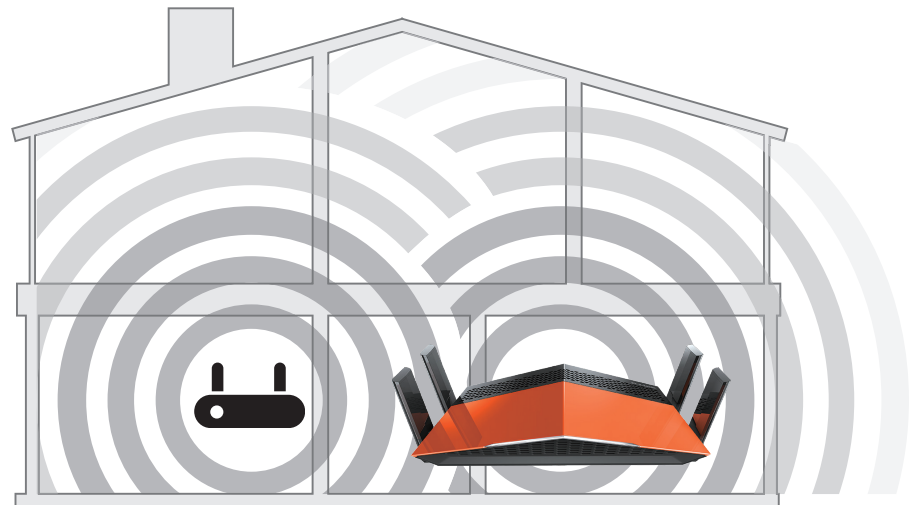

Wireless Extender

Extend Your Wireless Network using Wi-Fi

The DIR-879 operates as a **Wireless Extender** when the mode switch is in the **Extender** position and it is connected wirelessly to an uplink network.



Use this mode for:

- Extending your current network.
- Bringing Wi-Fi to an area it doesn't currently reach.
- Providing better signal for parts of your home or office that may have poor reception.
- Connecting wired Ethernet devices which do not have a built-in wireless, such as smart TVs, game consoles, or DVRs.
- Networking areas where cables are impractical.

Note: Extending by Wi-Fi reduces the total available amount of wireless bandwidth available.

Use the DIR-879's Wireless Extender Mode's built in web UI Setup Wizard to connect to an uplink network

To use your DIR-879 as a **Wireless Extender**, refer to **Installation - Wireless Extender** on page **28**.

Access Point

Create a Wireless Network using Ethernet

The DIR-879 operates as an **Access Point** when the mode switch is in the **Extender** position and an Ethernet cable is connected from an Ethernet Port to an uplink network.

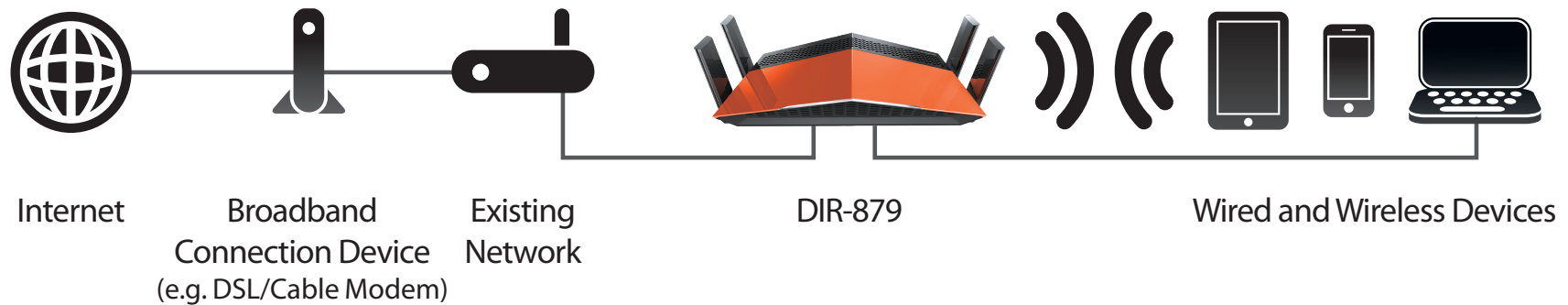

Use this mode for:

- Extending your current network.
- Providing better signal for parts of your home or office that may have poor reception.
- Bringing Wi-Fi to an area it doesn't currently reach.
- Adding Wi-Fi to a wired network.
- Maximizing bandwidth.
- Creating a Wi-Fi pocket away from your existing network.

Note: Extending a network to a desired location via Ethernet may require additional cable. The maximum length of Category 5/5E cables is limited to 100 meters (330 feet). Use a Gigabit-capable Ethernet connection where possible to ensure the best networking experience.

To use your DIR-879 as an **Access Point**, refer to **Installation - Access Point** on page **37**.

Installation - Router

This section will walk you through the installation of the DIR-879 as a router using **Router Mode**.

Before you Begin

- Placement of the router is very important. Do not place the router in an enclosed area such as a closet, cabinet, attic, or garage.
- Configure the router with the computer that was last connected directly to your Internet connection. Verify that it is connected to the Internet before connecting additional devices.
- If your ISP provided you with a modem/router combo, you will need to set it to “bridge” mode so the router can work properly. Please contact your ISP or refer to the user manual for your modem/router device.
- You can only use the Ethernet port on your modem. If you were using the USB connection before using the router, then you must turn off your modem, disconnect the USB cable and connect an Ethernet cable to the Internet port on the router, and then turn the modem back on. In some cases, you may need to call your Internet Service Provider (ISP) to change connection types (USB to Ethernet).
- If connecting to a DSL modem, make sure to have your DSL service information provided by your Internet Service Provider handy. This information is likely to include your DSL account's Username and Password. Your ISP may also supply you with additional WAN configuration settings which might be necessary to establish a connection.
- If you are connecting a considerable amount of networking equipment, it may be a good idea to take the time to label each cable or take a picture of your existing setup before making any changes.
- If you have DSL and are connecting via PPPoE, make sure you disable or uninstall any PPPoE software such as WinPoET, BroadJump, or EnterNet 300 from your computer or you will not be able to connect to the Internet.

Wireless Installation Considerations

The D-Link wireless router lets you access your network using a wireless connection from virtually anywhere within the operating range of your wireless network. Keep in mind that the number, thickness and location of walls, ceilings, or other objects that the wireless signals must pass through may limit the range. Typical ranges vary depending on the types of materials and background RF (radio frequency) noise in your home or business. The key to maximizing wireless range is to follow these basic guidelines:

1. Keep the number of walls and ceilings between the D-Link router and other network devices to a minimum - each wall or ceiling can reduce your adapter's range from 3-90 feet (1-30 meters.) Position your devices so that the number of walls or ceilings is minimized.
2. Be aware of the direct line between network devices. A wall that is 1.5 feet thick (0.5 meters), at a 45-degree angle appears to be almost 3 feet (1 meter) thick. At a 2-degree angle it looks over 42 feet (14 meters) thick! Position devices so that the signal will travel straight through a wall or ceiling (instead of at an angle) for better reception.
3. Building materials make a difference. A solid metal door or aluminum studs may have a negative effect on range. Try to position access points, wireless routers, and computers so that the signal passes through drywall or open doorways. Materials and objects such as glass, steel, metal, walls with insulation, water (fish tanks), mirrors, file cabinets, brick, and concrete will degrade your wireless signal.
4. Keep your product away (at least 3-6 feet or 1-2 meters) from electrical devices or appliances that generate RF noise.
5. If you are using 2.4 GHz cordless phones or X-10 (wireless products such as ceiling fans, lights, and home security systems), your wireless connection may degrade dramatically or drop completely. Make sure your 2.4 GHz phone base is as far away from your wireless devices as possible. The base transmits a signal even if the phone is not in use.

Hardware Setup

1. The DIR-879 is designed to give you the fastest, most stable network connection possible. In order to maximize performance, fully extend the antennas to provide optimal wireless coverage. Keep the router in an open area for better wireless coverage.

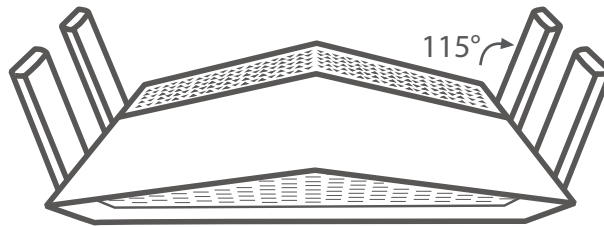

2. Inspect the mode switch to ensure that it is in the factory default **ROUTER** position. Adjust the switch if necessary.

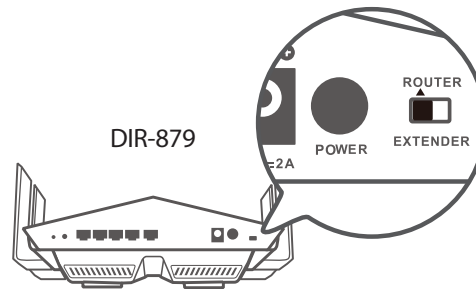

3. Position your DIR-879 near your Internet-connected modem. Place it in an open area for better wireless coverage.

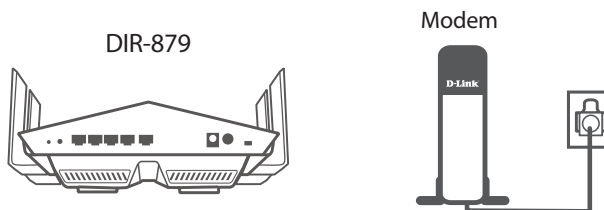

4. Turn off and unplug the power and Ethernet cable to your cable or DSL broadband modem. This is required. In some cases, you may need to turn it off for up to five minutes.



5. Use the included Ethernet cable to connect your modem to the yellow port labeled **INTERNET** on the router.

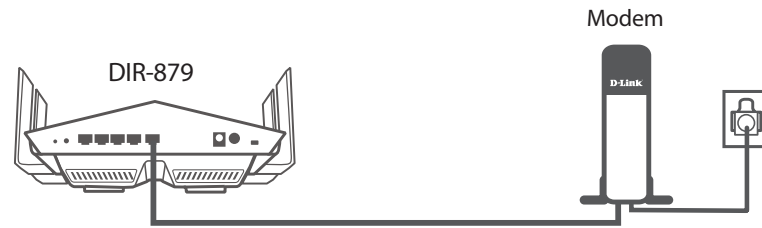

6. Turn on or plug your modem back in and wait approximately one minute before proceeding onward.



7. Connect the supplied power adapter to the router and a power outlet, press the power button, and wait approximately one minute until the LED indicator on the front of the device changes from orange to solid white.

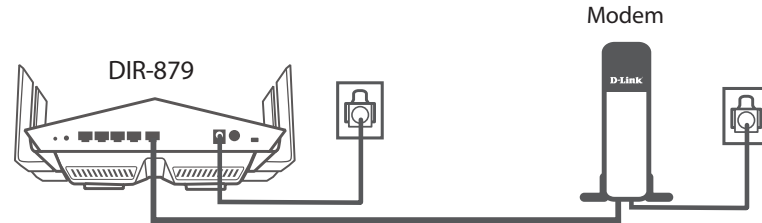

Note: This unit is to be used with power supply model DA-60N12.

8. **If you are configuring the DIR-879 wirelessly from a PC,** connect to a Wi-Fi network printed on the included Wi-Fi Configuration Card. You can also find the Wi-Fi network names and passwords printed on the label attached to the bottom your router.

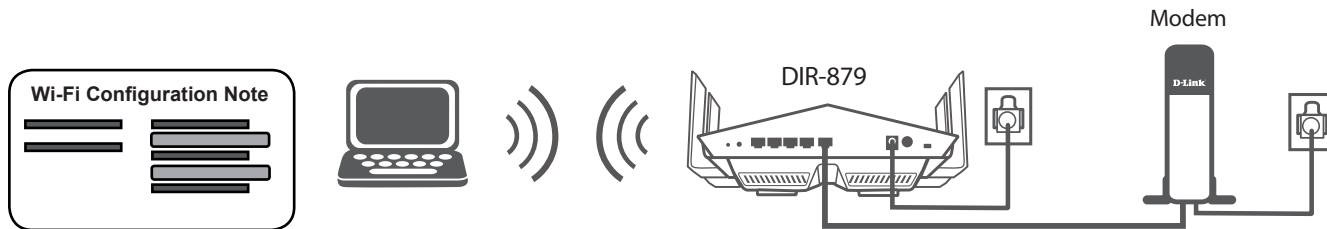

If you are configuring the DIR-879 from a PC with a wired Ethernet connection, plug one end of an Ethernet cable into the port labeled 1 on the back of the router, and the other end into the Ethernet port on your computer.

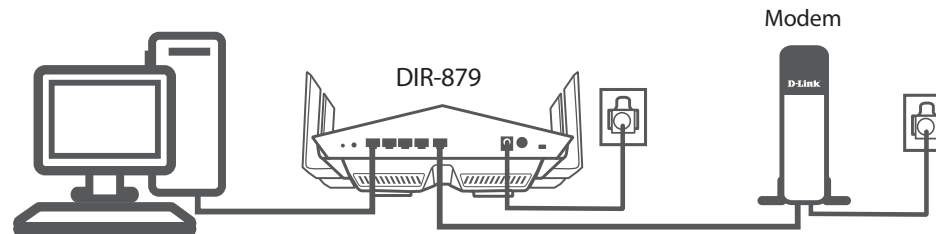

9. If you are connecting to a broadband service that uses a dynamic connection (not PPPoE), you may be online already. Try opening a web browser and connecting to a website. If the website does not load, proceed to **Completing Setup** on page **18**.

Completing Setup

There are several different ways you can configure your router to connect to the Internet and connect to your clients:

- **QRS Mobile App** - Use your Android device, iPhone, iPad, or iPod touch to configure your router.
Refer to **QRS Mobile App** on page **18**.
- **D-Link Setup Wizard** - This wizard will launch when you log into the router for the first time.
Refer to **Setup Wizard** on page **23**.
- **Manual Setup** - Log in to the router and manually configure your router.
Refer to **Configuration - Router Mode** on page **40**.

QRS Mobile App

QRS Mobile app allows you to install and configure your router from your mobile device.

Note: The screenshots may be different depending on your mobile device's OS version.

Step 1

Search for the free **QRS Mobile App** on the App Store or Google Play.



Step 2

Once your app is installed, you may now configure your router. Connect to the router wirelessly by going to your wireless utility on your device. Scan for the Wi-Fi name (SSID) as listed on the supplied info card. Select and then enter your Wi-Fi password.

D-Link Wi-Fi Configuration Card	
Default Configuration	Wi-Fi Name (SSID) 2.4GHz:
Wi-Fi Name (SSID): dlink-a8fa	Wi-Fi Password:
Wi-Fi Password: akbdj19368	Wi-Fi Name (SSID) 5GHz *:
	Wi-Fi Password *:
To configure your router, go to: http://dlinkrouter.local. Or http://192.168.0.1 Username: "Admin" Password: * (leave the field blank)	Your configuration Username: "Admin" Password:
	*For applicable models

Step 3

Once you connect to the router, launch the QRS Mobile app from the Home screen of your device.

Note: The following steps show the Android interface of the QRS Mobile app. If you are using an iPhone, iPad, or iPod touch, the appearance may be different to that of the screenshots, but the process is the same.



QRS Mobile

QRS Mobile App (continued)

Step 4

You will see the welcome screen. Tap **Start** to proceed, then enter your device password and tap **Log In**. Tap **Next** once the Operation Mode screen appears.

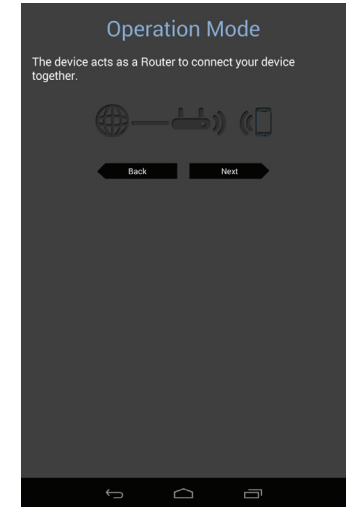
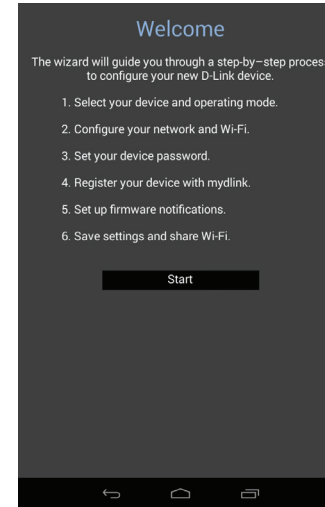

Step 5

At this point, please ensure that your router is connected to a modem. Plug one end of the provided Ethernet cable into your DSL or cable modem, and plug the other end into the port marked INTERNET on the DIR-879. Tap **Next** to automatically detect your Internet connection and proceed to the next step.

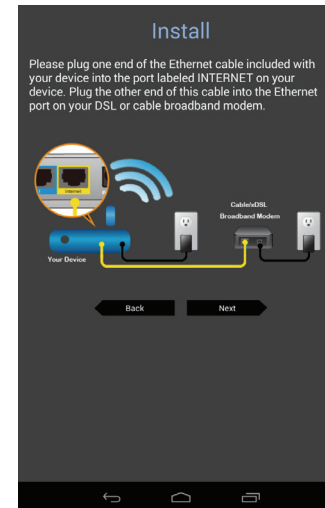

QRS Mobile App (continued)

Step 6

You will be asked to configure your 2.4 GHz wireless network. Enter a network name (SSID) of your choice, or leave it unchanged to accept the default SSID.

Next, choose a Wi-Fi password of at least 8 characters. Any device trying to connect to the router wirelessly will need to enter this password the first time it connects.

Tap **Next** to configure your 5 GHz wireless network. When satisfied, tap **Next** to proceed.

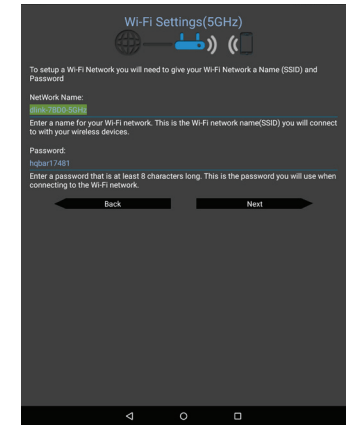
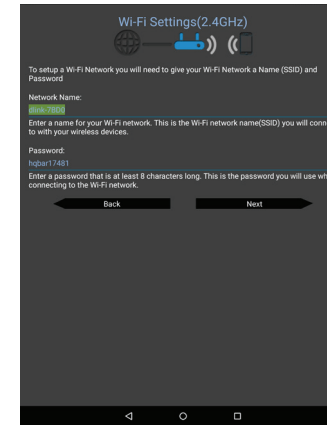

Step 7

Enter the administrator password of your choice. Unlike the Wi-Fi password, this password is only required when you need to configure the router. See **Configuration - Router Mode** on page 41 for details of when this password is used. Tap **Next** to proceed.

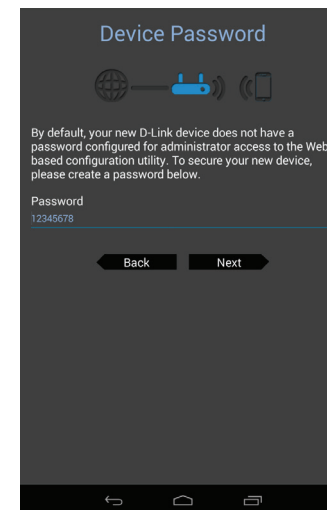

QRS Mobile App (continued)

Step 8

If you wish to receive push notifications whenever a new firmware update is available, check the **Notify me when new firmware is available** box and tap **Next**.

Otherwise, just tap **Next** to proceed.

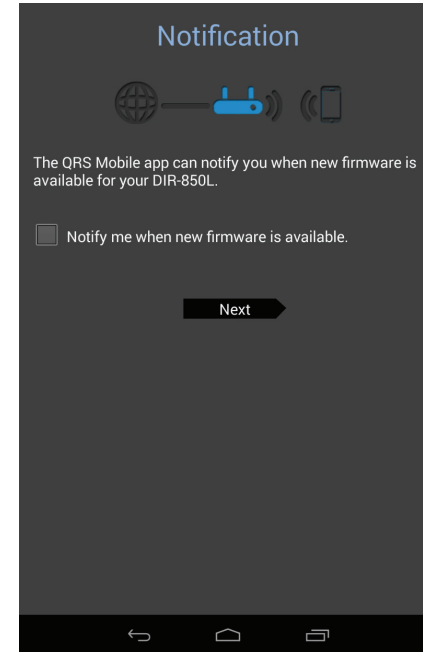

Step 9

You will be presented with a summary of your chosen settings. Tap **Save** to complete the setup.

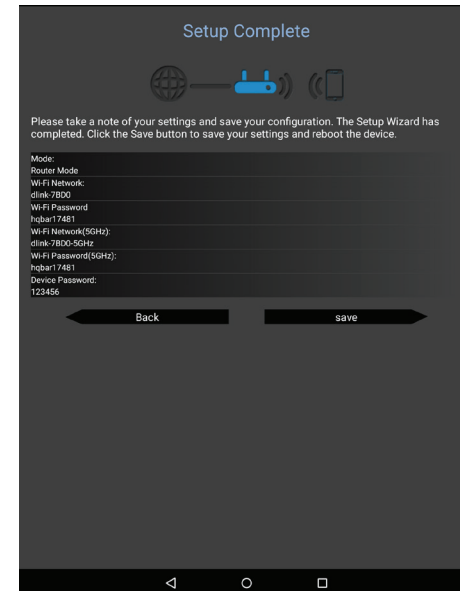

QRS Mobile App (continued)

Congratulations, your device has been successfully configured! You can share this information by tapping **Share By E-mail**, or tap **Finish** to exit the app.

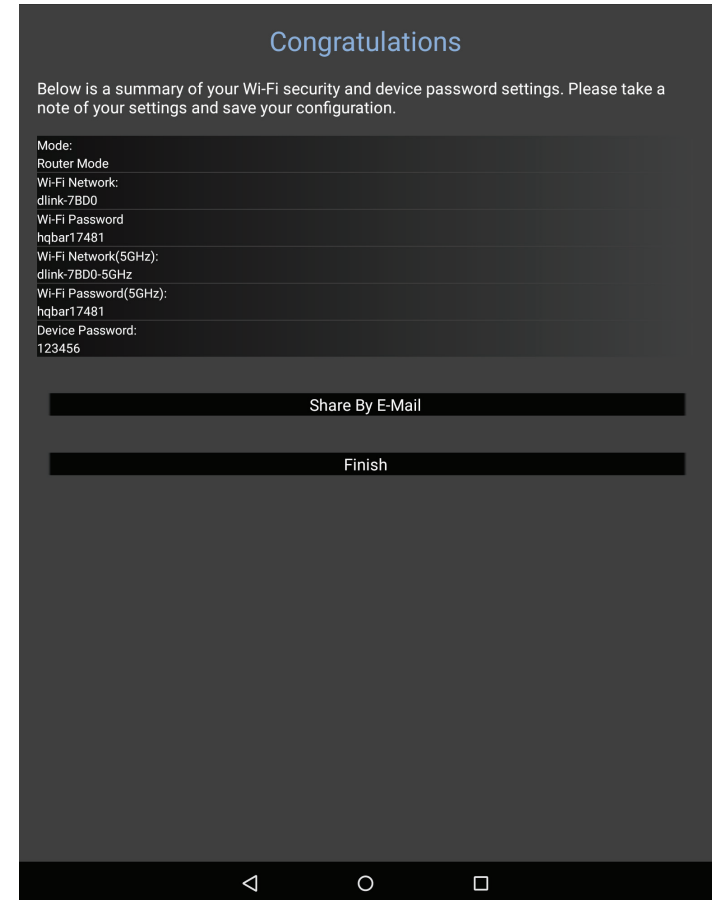

Setup Wizard

If this is your first time installing the router, open your web browser and enter **http://dlinkrouter.local/** in the address bar. Alternatively, enter the IP address of the router (default: **http://192.168.0.1**).

The wizard is designed to guide you through a step-by-step process to configure your new D-Link router and connect to the Internet.

Click **Next** to continue.

Please wait while your router detects your Internet connection type. If the router detects your Internet connection, you may need to enter your ISP information such as username and password.

If the router does not detect a valid Internet connection, a list of connection types to choose from will be displayed.

Select your Internet connection type (this information can be obtained from your Internet Service Provider) and click **Next** to continue.

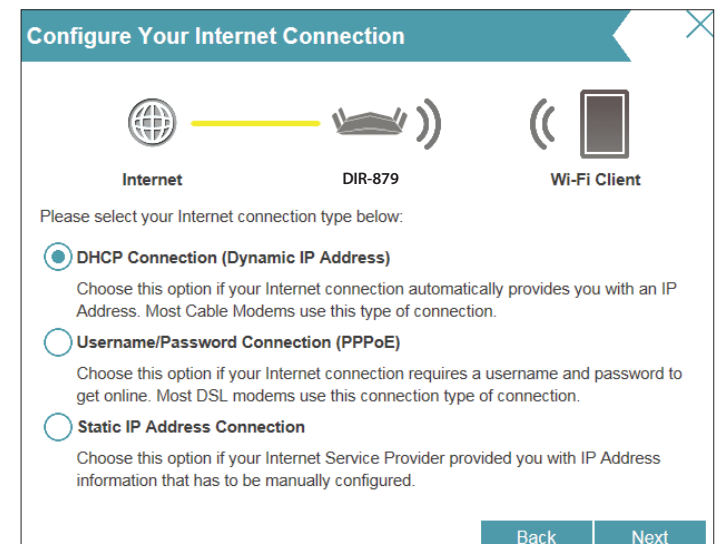
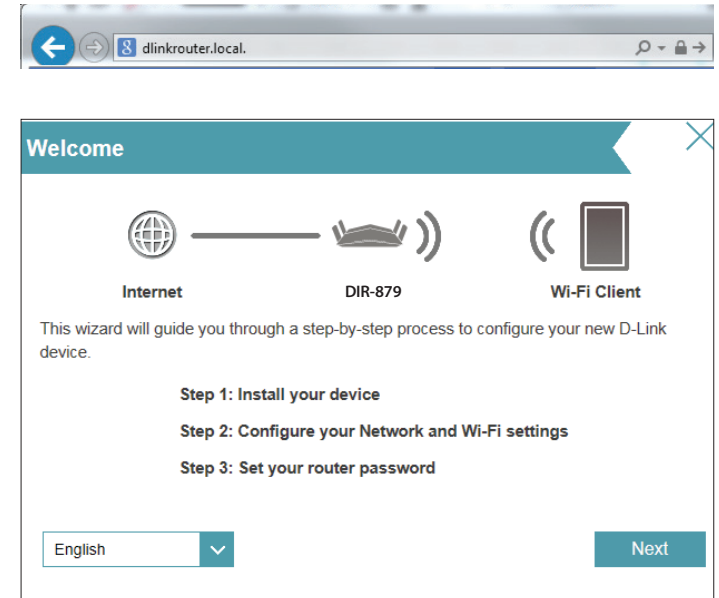

Setup Wizard (continued)

If the router detected or you selected **PPPoE**, enter your PPPoE username and password and click **Next** to continue.

Note: Make sure to remove your PPPoE software from your computer. The software is no longer needed and will not work through a router.

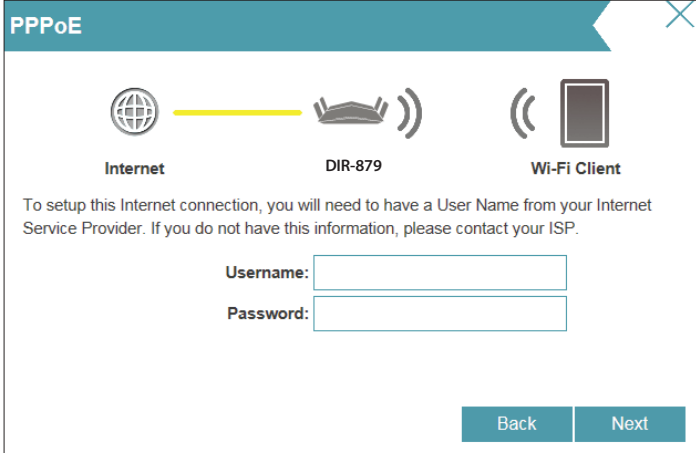

The screenshot shows the 'PPPoE' configuration screen. At the top, there are three icons: a globe for 'Internet', a router for 'DIR-879', and a smartphone for 'Wi-Fi Client'. Below these icons, a text box explains that a username and password from the ISP are required. There are two input fields: 'Username:' and 'Password:'. At the bottom right, there are 'Back' and 'Next' buttons.

If the router detected or you selected **Static**, enter the IP and DNS settings supplied by your ISP. Click **Next** to continue.



The screenshot shows the 'Static IP' configuration screen. At the top, there are three icons: a globe for 'Internet', a router for 'DIR-879', and a smartphone for 'Wi-Fi Client'. Below these icons, a text box explains that a complete list of IP information from the ISP is required. There are five input fields: 'IP Address:', 'Subnet Mask:', 'Gateway Address:', 'Primary DNS Address', and 'Secondary DNS Address'. At the bottom right, there are 'Back' and 'Next' buttons.

Setup Wizard (continued)

Create a Wi-Fi password (between 8-63 characters). Your wireless clients will need to have this passphrase or key entered to be able to connect to your wireless network.

Click **Next** to continue.

Note: The DIR-879's Smart Connect feature presents a single wireless network. When connecting clients to an extension network, they will be automatically added to the best band, either 2.4 GHz or 5 GHz. To disable the Smart Connect feature and individually configure 2.4 GHz and 5 GHz networks, refer to **Wireless** on page **72**.

In order to secure the router, please enter a new password. You will be prompted for this password every time you want to use the router's web configuration utility. Click **Next** to continue.

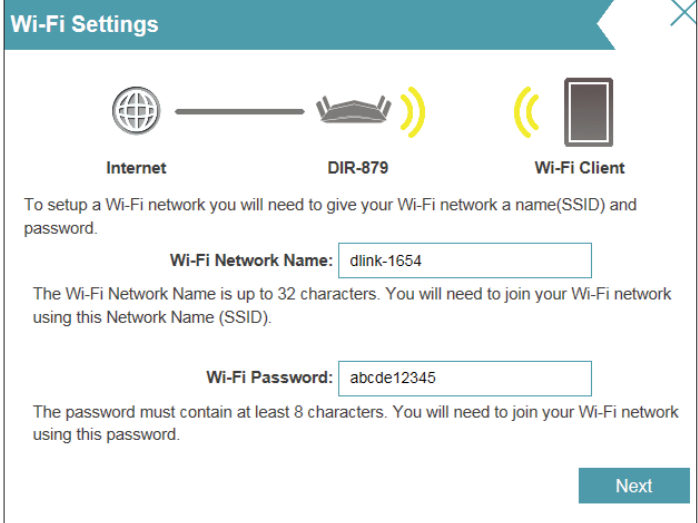

The screenshot shows the 'Wi-Fi Settings' screen. At the top, there is a teal header with the title 'Wi-Fi Settings' and a close button. Below the header, there are three icons: a globe for 'Internet', a router for 'DIR-879', and a smartphone for 'Wi-Fi Client'. The 'Wi-Fi Client' icon is highlighted with a yellow glow. Below the icons, there is a text prompt: 'To setup a Wi-Fi network you will need to give your Wi-Fi network a name(SSID) and password.' There are two input fields: 'Wi-Fi Network Name:' with the value 'dlink-1654' and 'Wi-Fi Password:' with the value 'abcde12345'. Below the password field, there is a note: 'The password must contain at least 8 characters. You will need to join your Wi-Fi network using this password.' At the bottom right, there is a teal 'Next' button.

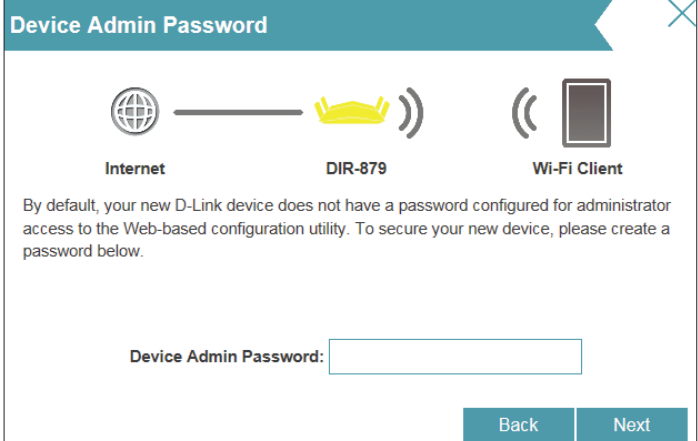

The screenshot shows the 'Device Admin Password' screen. At the top, there is a teal header with the title 'Device Admin Password' and a close button. Below the header, there are three icons: a globe for 'Internet', a router for 'DIR-879', and a smartphone for 'Wi-Fi Client'. The 'DIR-879' icon is highlighted with a yellow glow. Below the icons, there is a text prompt: 'By default, your new D-Link device does not have a password configured for administrator access to the Web-based configuration utility. To secure your new device, please create a password below.' There is one input field: 'Device Admin Password:'. At the bottom right, there are two buttons: 'Back' and 'Next'.

Setup Wizard (continued)

You will be presented with a summary of your settings. Click **Next** to finalize the settings or **Back** to make changes.

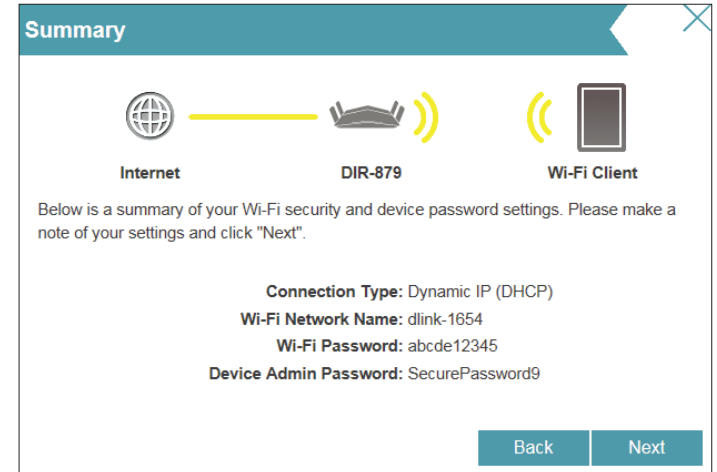

At the end of the wizard, you will be presented with a final summary of your settings. Click **Finish** to close the wizard.

Congratulations, your device has been successfully configured!



Installation - Wireless Extender

This section will walk you through the installation of the DIR-879 as a wireless extender in **Extender Mode**.

Before you Begin

- Configure the extender with the computer that was last connected directly to your Internet connection. Verify that it is connected to the Internet before connecting additional devices.
- If you are connecting a considerable amount of networking equipment, it may be a good idea to take the time to label each cable or take a picture of your existing setup before making any changes.
- If you are using this device to extend the range of your existing wireless network, you may need to use trial and error to determine an acceptable placement location.

Wireless Installation Considerations

The D-Link wireless device lets you access your network using a wireless connection from virtually anywhere within the operating range of your wireless network. Keep in mind that the number, thickness and location of walls, ceilings, or other objects that the wireless signals must pass through may limit the range. Typical ranges vary depending on the types of materials and background RF (radio frequency) noise in your home or business. The key to maximizing wireless range is to follow these basic guidelines:

1. Keep the number of walls and ceilings between the D-Link device and other network devices to a minimum - each wall or ceiling can reduce your adapter's range from 3-90 feet (1-30 meters.) Position your devices so that the number of walls or ceilings is minimized.
2. Be aware of the direct line between network devices. A wall that is 1.5 feet thick (0.5 meters), at a 45-degree angle appears to be almost 3 feet (1 meter) thick. At a 2-degree angle it looks over 42 feet (14 meters) thick! Position devices so that the signal will travel straight through a wall or ceiling (instead of at an angle) for better reception.
3. Building materials make a difference. A solid metal door or aluminum studs may have a negative effect on range. Try to position access points, wireless routers, and computers so that the signal passes through drywall or open doorways. Materials and objects such as glass, steel, metal, walls with insulation, water (fish tanks), mirrors, file cabinets, brick, and concrete will degrade your wireless signal.
4. Keep your product away (at least 3-6 feet or 1-2 meters) from electrical devices or appliances that generate RF noise.
5. If you are using 2.4 GHz cordless phones or X-10 (wireless products such as ceiling fans, lights, and home security systems), your wireless connection may degrade dramatically or drop completely. Make sure your 2.4 GHz phone base is as far away from your wireless devices as possible. The base transmits a signal even if the phone is not in use.

Hardware Setup

1. The DIR-879 is designed to give you the fastest, most stable network connection possible. In order to maximize performance, fully extend the antennas to provide optimal wireless coverage. Position your DIR-879 near where you wish to extend Wi-Fi to. Place it in an open area for better wireless coverage, but is still within range of your existing wireless network. We recommend using a smartphone or tablet to help gauge wireless strength.

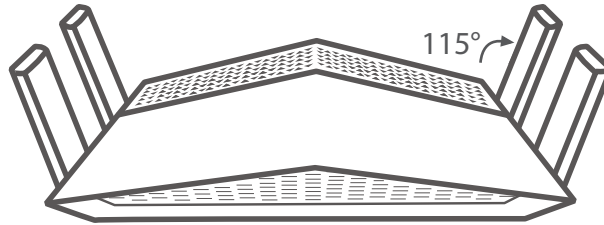

2. Inspect the mode switch to ensure that it is in **EXTENDER** position. Adjust the switch if necessary.

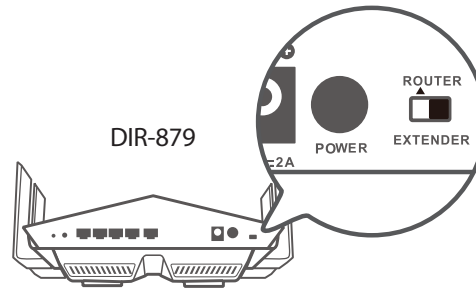

3. Connect the supplied power adapter to the DIR-879 and a power outlet.

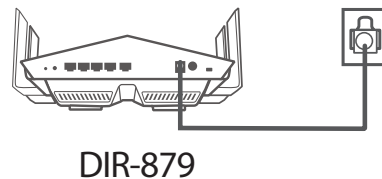

Note: This unit is to be used with power supply model DA-60N12.

Connect to an Uplink Network using the Setup Wizard

4. Press the power button, and wait approximately one minute.



5. **If you are configuring the DIR-879 wirelessly from a PC**, connect to a Wi-Fi network printed on the included Wi-Fi Configuration Card. You can also find the Wi-Fi network names and passwords printed on the label attached to the bottom your router.

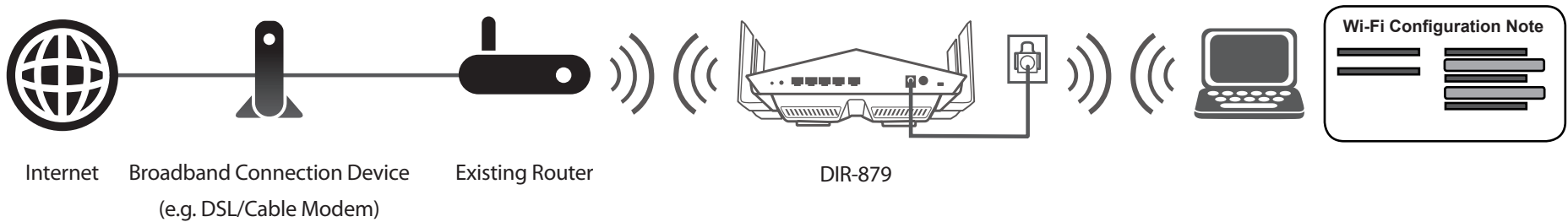

If you are configuring the DIR-879 from a PC with a wired Ethernet connection, plug one end of an Ethernet cable into the port labeled 1 on the back of the router, and the other end into the Ethernet port on your computer.

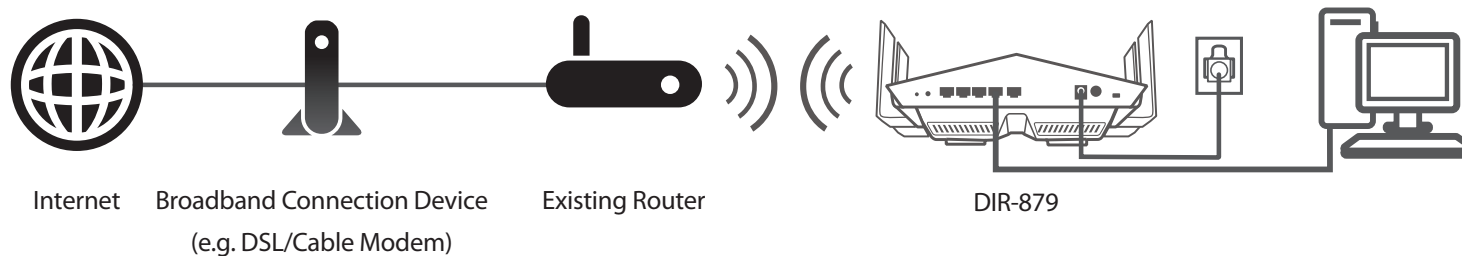

Setup Wizard (continued)

Once connected, open a web browser and enter **http://dlinkrouter.local/** or **192.168.0.50** in your browser's URL field.

The wizard is designed to guide you through a step-by-step process to configure your DIR-879 as a wireless extender.

Click **Next** to continue.

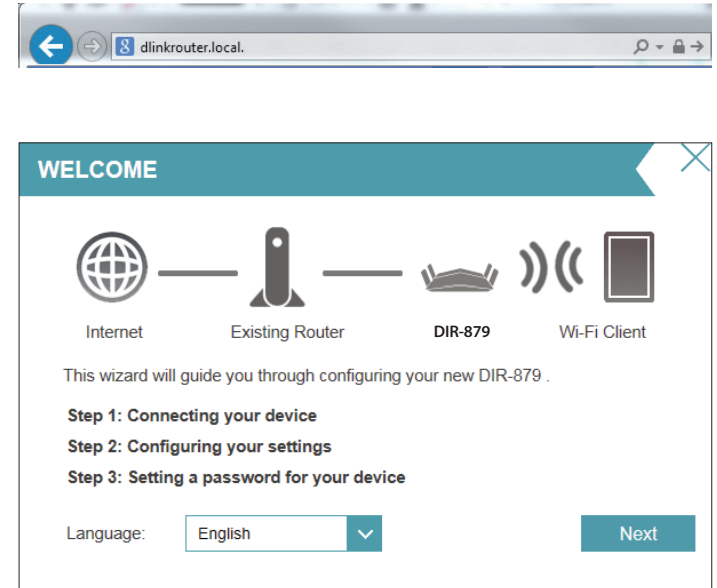

Choose **Extend an existing wireless network**.

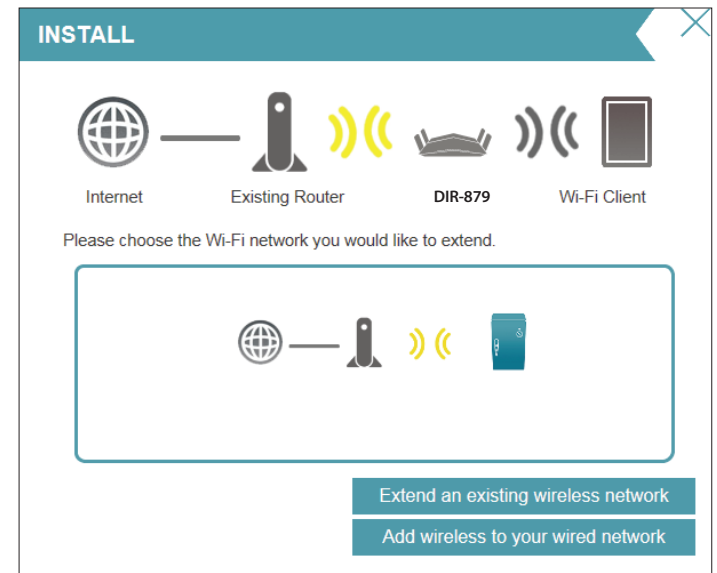

Setup Wizard (continued)

The DIR-879 will scan for wireless networks in range.

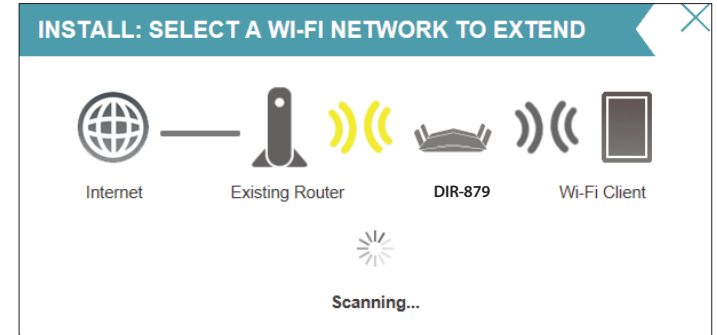

You will be presented with a list of networks in range once the scan is complete. Select the network you wish to extend from the list or if you don't see the network you want to connect to, click **Manual**.

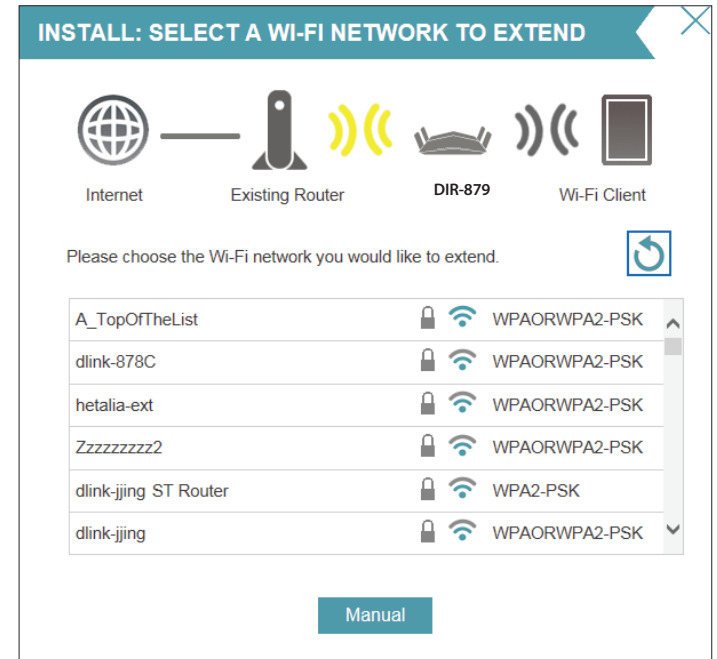

Setup Wizard (continued)

If you selected a wireless network from the list, enter its Wi-Fi password.

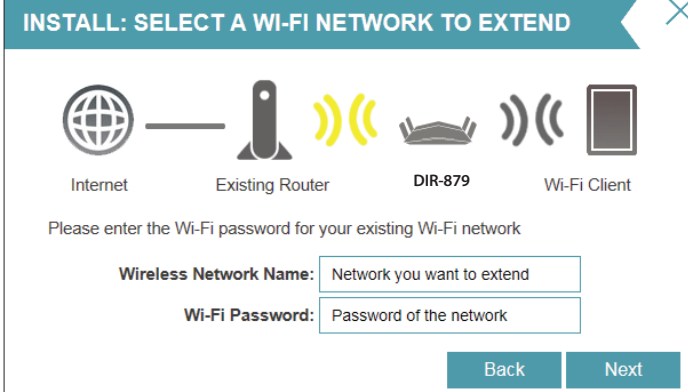

INSTALL: SELECT A WI-FI NETWORK TO EXTEND

Internet — Existing Router — **DIR-879** — Wi-Fi Client

Please enter the Wi-Fi password for your existing Wi-Fi network

Wireless Network Name:

Wi-Fi Password:

[Back](#) [Next](#)

If you selected **Manual**, enter the name, security, and password of the wireless network you wish to extend.

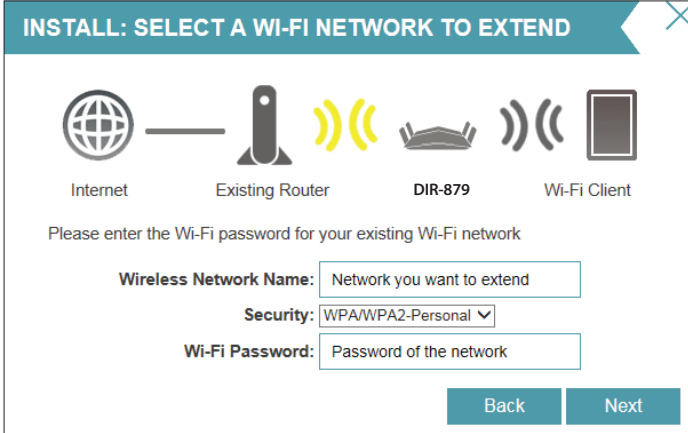

INSTALL: SELECT A WI-FI NETWORK TO EXTEND

Internet — Existing Router — **DIR-879** — Wi-Fi Client

Please enter the Wi-Fi password for your existing Wi-Fi network

Wireless Network Name:

Security:

Wi-Fi Password:

[Back](#) [Next](#)

Click **Next** to continue.

Setup Wizard (continued)

Create a Wi-Fi password (between 8-63 characters). Your wireless clients will need to have this passphrase or key entered to be able to connect to your wireless network.

Click **Next** to continue.

Note: The DIR-879's Smart Connect feature presents a single wireless network. When connecting clients to an extension network, they will be automatically added to the best band, either 2.4 GHz or 5 GHz. To disable the Smart Connect feature and individually configure 2.4 GHz and 5 GHz networks, refer to **Extender** on page **101**.

In order to secure the router, please enter a new password. You will be prompted for this password every time you want to use the router's web configuration utility. Click **Next** to continue.

CONFIGURATION - EXTENDED NETWORK
✕



Internet
Existing Router
DIR-879
Wi-Fi Client

You need to give your extended Wi-Fi network a name (SSID) and a password. You can then connect to this extended Wi-Fi network using the password you have chosen.

Wi-Fi Network Name:

Wi-Fi Password:
(Between 8 and 63 characters)

Back
Next

CONFIGURATION - ADMINISTRATOR PASSWORD
✕



Internet
Existing Router
DIR-879
Wi-Fi Client

By default, your new DIR-879 does not have a password in order to access its web-based configuration. To secure your device, please choose and enter an Admin password below.

Device Admin Password:

Back
Next

Setup Wizard (continued)

At the end of the wizard, you will be presented with a final summary of your settings. Click **Finish** to close the wizard. The device will reboot using these settings.

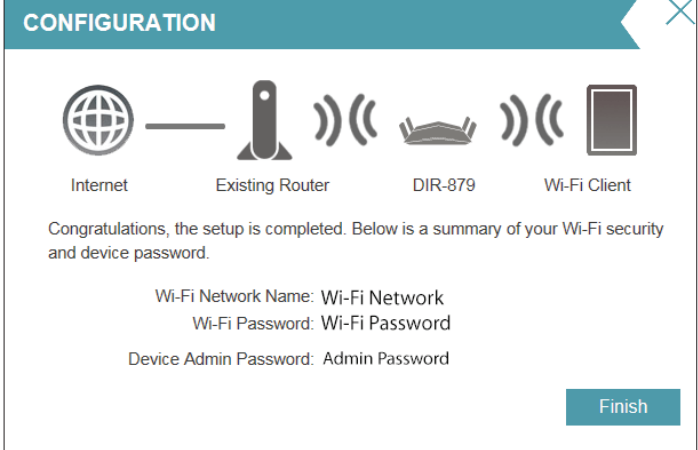

CONFIGURATION

Internet — Existing Router — DIR-879 — Wi-Fi Client

Congratulations, the setup is completed. Below is a summary of your Wi-Fi security and device password.

Wi-Fi Network Name: Wi-Fi Network
Wi-Fi Password: Wi-Fi Password
Device Admin Password: Admin Password

Finish

Congratulations, your device has been successfully configured!

If you wish to make changes to any settings, refer to **Configuration - Extender Mode** on page **97**.



10 Sec

Your changes are being saved. When reconnecting to this device, please use the new Wi-Fi name and password you created.

Installation - Access Point

This section will walk you through the installation of the DIR-879 as an access point in **Extender Mode**.

Before you Begin

- Configure the extender with the computer that was last connected directly to your Internet connection. Verify that it is connected to the Internet before connecting additional devices.
- If you are connecting a considerable amount of networking equipment, it may be a good idea to take the time to label each cable or take a picture of your existing setup before making any changes.
- If you are using this device to extend the range of your existing wireless network, you may need to use trial and error to determine an acceptable placement location.

Wireless Installation Considerations

The D-Link wireless device lets you access your network using a wireless connection from virtually anywhere within the operating range of your wireless network. Keep in mind that the number, thickness and location of walls, ceilings, or other objects that the wireless signals must pass through may limit the range. Typical ranges vary depending on the types of materials and background RF (radio frequency) noise in your home or business. The key to maximizing wireless range is to follow these basic guidelines:

1. Keep the number of walls and ceilings between the D-Link device and other network devices to a minimum - each wall or ceiling can reduce your adapter's range from 3-90 feet (1-30 meters.) Position your devices so that the number of walls or ceilings is minimized.
2. Be aware of the direct line between network devices. A wall that is 1.5 feet thick (0.5 meters), at a 45-degree angle appears to be almost 3 feet (1 meter) thick. At a 2-degree angle it looks over 42 feet (14 meters) thick! Position devices so that the signal will travel straight through a wall or ceiling (instead of at an angle) for better reception.
3. Building materials make a difference. A solid metal door or aluminum studs may have a negative effect on range. Try to position access points, wireless routers, and computers so that the signal passes through drywall or open doorways. Materials and objects such as glass, steel, metal, walls with insulation, water (fish tanks), mirrors, file cabinets, brick, and concrete will degrade your wireless signal.
4. Keep your product away (at least 3-6 feet or 1-2 meters) from electrical devices or appliances that generate RF noise.
5. If you are using 2.4 GHz cordless phones or X-10 (wireless products such as ceiling fans, lights, and home security systems), your wireless connection may degrade dramatically or drop completely. Make sure your 2.4 GHz phone base is as far away from your wireless devices as possible. The base transmits a signal even if the phone is not in use.

Hardware Setup

1. The DIR-879 is designed to give you the fastest, most stable network connection possible. In order to maximize performance, fully extend the antennas to provide optimal wireless coverage. Position your DIR-879 near where you wish to extend Wi-Fi to. Place it in an open area for better wireless coverage, but is still within range of your existing wired network using an Ethernet cable.

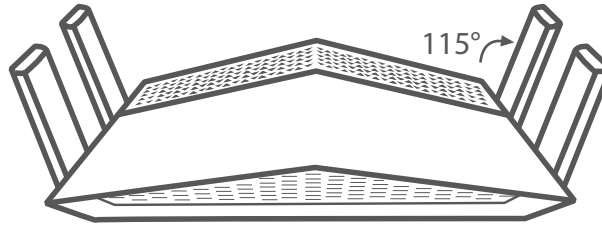

2. Inspect the mode switch to ensure that it is in **EXTENDER** position. Adjust the switch if necessary.

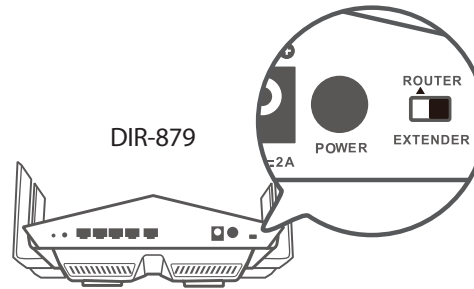

3. Connect the supplied power adapter to the DIR-879 and a power outlet.

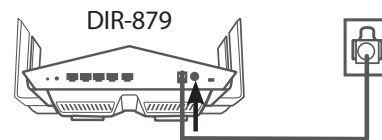

Note: Extending network to desired your location via Ethernet may require the purchase of additional cable. Maximum CAT5e cable length is limited to 100 meters. Use a Gigabit-capable Ethernet connection where possible to ensure the best networking experience.

This unit is to be used with power supply model DA-60N12.

4. Connect an Ethernet cable from your uplink network to the **INTERNET** port on the back of the DIR-879, press the power button, and wait approximately one minute until the LED indicator on the front of the device changes from orange to solid white.

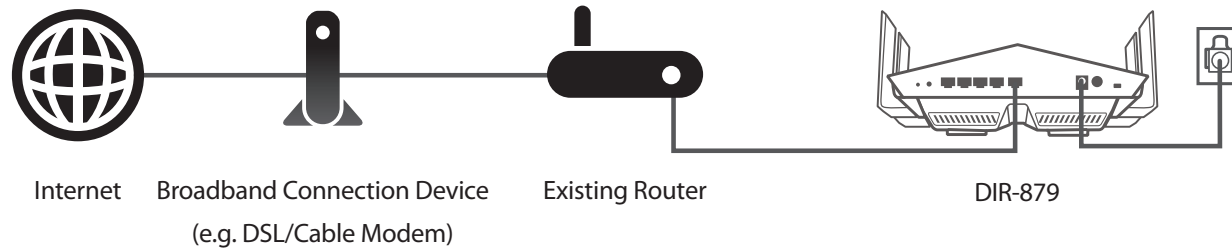

5. Connect wired devices to the LAN ports on your DIR-879. Connect wireless devices to the Wi-Fi network printed on the included Wi-Fi Configuration Card. You can also find the Wi-Fi network names and passwords printed on the label attached to the bottom your DIR-879.

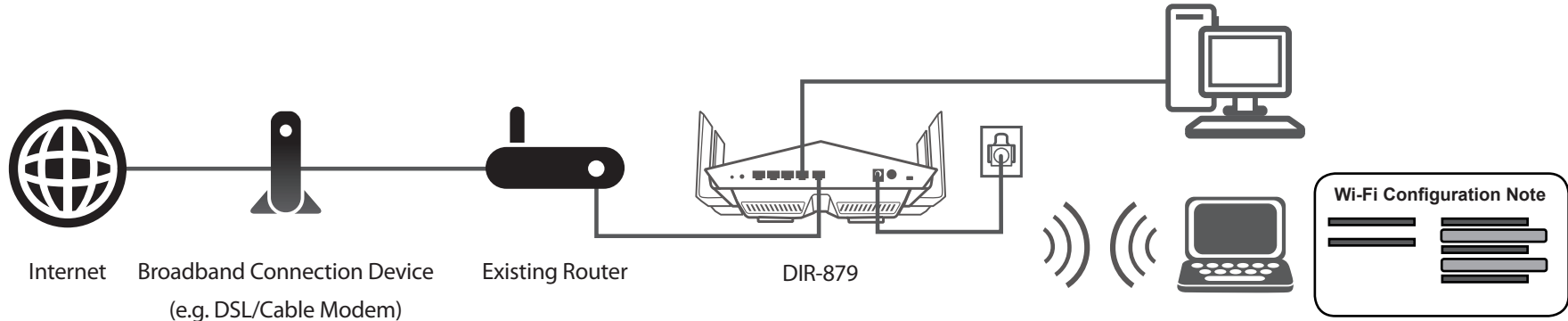

Congratulations, your device has been successfully configured!

Refer to **Configuration - Extender Mode** on page **97** for information on changing the default wireless network names or passwords.

Configuration - Router Mode

To access the configuration utility, open a web-browser such as Internet Explorer and enter **http://dlinkrouter.local/** or you may also connect by typing the IP address of the router (by default this is **http://192.168.0.1**) in the address bar.

Enter your password. If you previously followed the setup wizard, please use the admin password you entered during the wizard. Otherwise, leave the password blank. Click **Log In** to proceed.

Note: If you cannot remember your password and cannot log in, press the reset/wps button on the back of the device for longer than 10 seconds to restore the router to its default settings.

The router's home page will open displaying its current connection status.

The bar at the top of the page has quick access to Settings and Management functions. You may quickly jump back Home at any time.

Note: The system will automatically log out after a period of inactivity.

If the mode switch is set to **Router** these are the pages you will see.

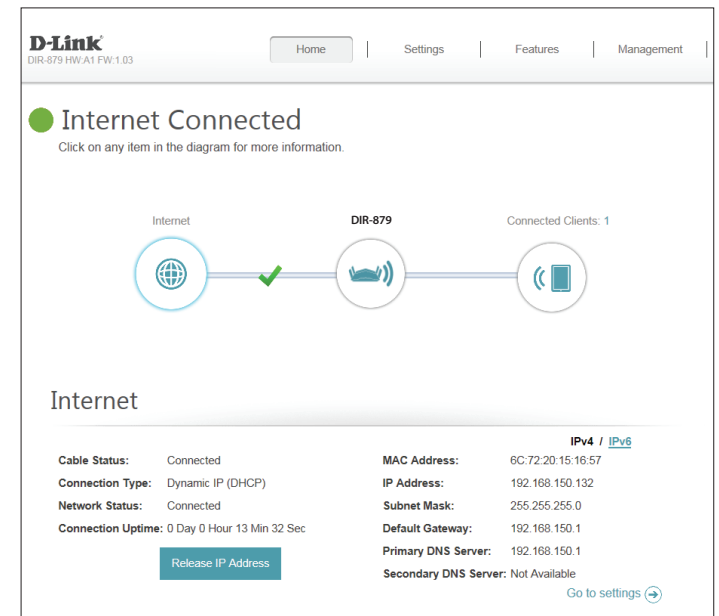
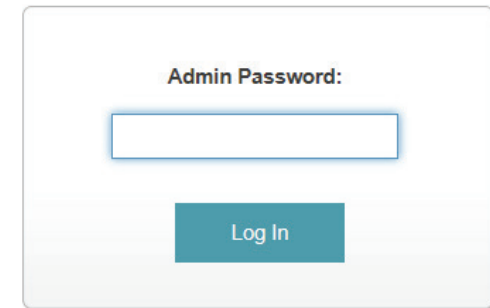

Home

The Home page displays the current status of the router in the form of an interactive diagram. You can click each icon to display information about each part of the network at the bottom of the screen. The menu bar at the top of the page will allow you to quickly navigate to other pages.

Internet

The Home page displays whether or not the router is currently connected to the Internet. If it is disconnected, click **Click to repair** to bring up the setup wizard, refer to **Setup Wizard** on page 24 for more information.

To bring up more details about your Internet connection, click on the **Internet** icon. Click **IPv4** or **IPv6** to see details of the IPv4 connection and IPv6 connection respectively.

Click **Release** to disconnect from the Internet. If you do this and wish to reconnect, click **Renew**.

To reconfigure the Internet settings, refer to **Internet** on page 45.

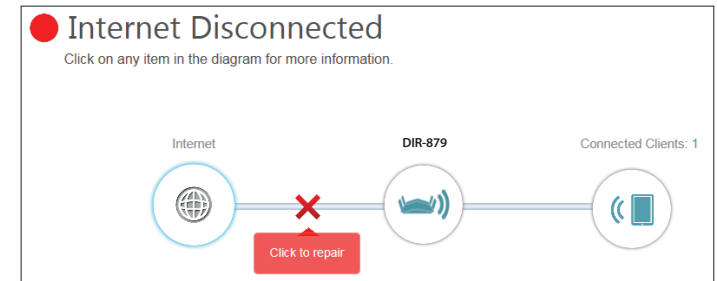

D-Link
DIR-879 HW:A1 FW:1.03

Home | Settings | Features | Management

Internet Connected
Click on any item in the diagram for more information.

Internet DIR-879 Connected Clients: 1

Internet

[IPv4](#) / [IPv6](#)

Cable Status:	Connected	MAC Address:	6C:72:20:15:16:57
Connection Type:	Dynamic IP (DHCP)	IP Address:	192.168.150.132
Network Status:	Connected	Subnet Mask:	255.255.255.0
Connection Uptime:	0 Day 0 Hour 13 Min 32 Sec	Default Gateway:	192.168.150.1
		Primary DNS Server:	192.168.150.1
		Secondary DNS Server:	Not Available

[Release IP Address](#) [Go to settings](#)

DIR-879

Click on the **DIR-879** icon to view details about the router and its wireless settings.

Here you can see the router's current Wi-Fi network name and password, as well as the router's MAC address, IPv4 address, and IPv6 address.

To reconfigure the network settings, either click **Go to settings** on the lower left, or click **Settings** (at the top of the page) and then **Network** on the menu that appears. Refer to **Network** on page **76** for more information.

To reconfigure the wireless settings, either click **Go to settings**, on the lower right, or click **Settings** (at the top of the page) and then **Wireless** on the menu that appears. Refer to **Wireless** on page **72** for more information.

The screenshot displays the D-Link DIR-879 web interface. At the top, there is a navigation bar with 'Home', 'Settings', 'Features', and 'Management' tabs. Below the navigation bar, a green circle indicates 'Internet Connected'. A network diagram shows 'Internet' connected to 'DIR-879', which is connected to 'Connected Clients: 1'. Below the diagram, the 'DIR-879' section is divided into two columns. The left column shows 'IPv4 Network' details: MAC Address: 6C:72:20:15:16:54, Router IP Address: 192.168.0.1, and Subnet Mask: 255.255.255.0. The right column shows 'Wi-Fi' settings: Status: Enabled, Wi-Fi Name (SSID): dlink-1654, and Password: abcde12345. Below these, the 'IPv6 Network' section shows Link-Local Address: FE80::6E72:20FF:FE15:1654, Router IPv6 Address: /, DHCP-PD: Enabled, and Assigned Prefix: Not Available. 'Go to settings' links are provided at the bottom of each section.

Connected Clients

Click on the **Connected Clients** icon to view details about the router and its wireless settings.

On this page you can see all the clients currently connected to the router, and their IP addresses.

To edit each client's settings, click the pencil icon on the client you want to edit.

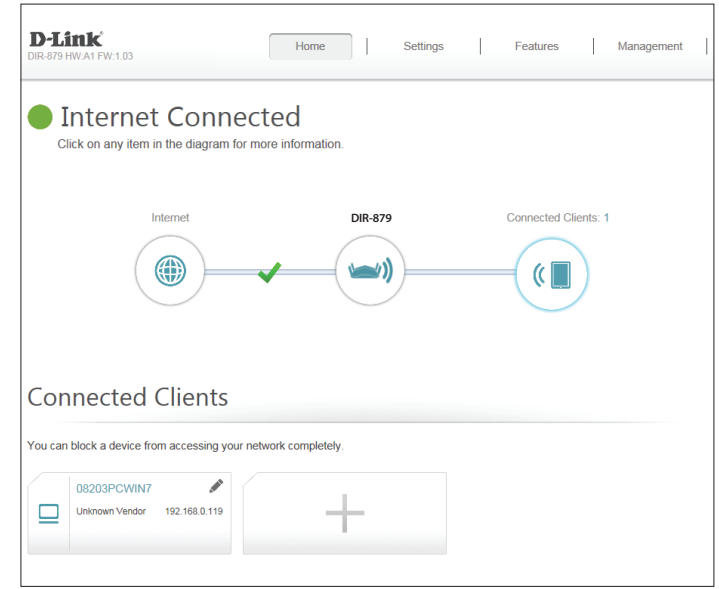

Name: Enter a custom name for this client.

Vendor: Displays the vendor of the device.

MAC Address: Displays the MAC address of the device.

IP Address: Displays the current IP address of this client.

Reserve IP: Enable to reserve this IP address for this client.

IP Address (Reserved): Specify an IP address for the DIR-879's DHCP server to assign.

Parental Control: Allow or Block access to the router.

Click **Save** when you are done.

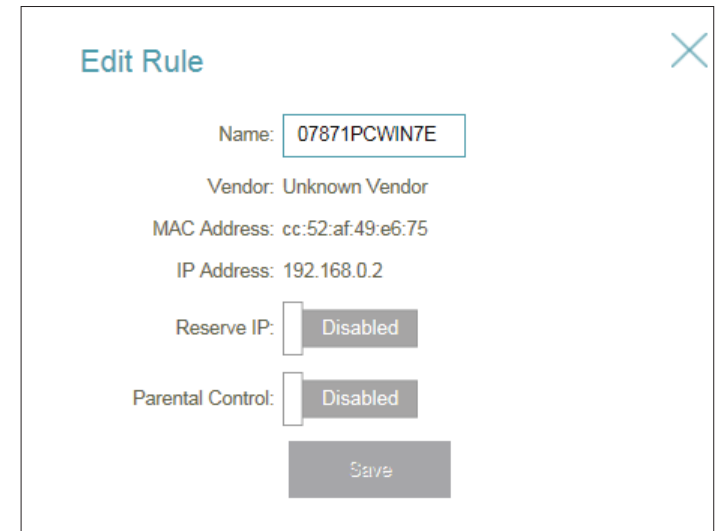

Settings Wizard

In the Settings menu on the bar on the top of the page, click **Wizard** to open the setup wizard. This is the same wizard that appears when you start the router for the first time. Refer to **Setup Wizard** on page **24** for details.

Internet

In the Settings menu on the bar on the top of the page, click **Internet** to see the Internet configuration options.

My Internet Connection Is: Choose your Internet connection type from the drop-down menu. You will be presented with the appropriate options for your connection type. Click **Advanced Settings...** to expand the list and see all of the options.

For **Dynamic IP (DHCP)** refer to page **46**.

For **Static IP** refer to page **47**.

For **PPPoE** refer to page **48**.

For **PPTP** refer to page **50**.

For **L2TP** refer to page **52**.

For **DS-Lite** refer to page **54**.

To configure an IPv6 connection, click the **IPv6** link. Refer to page **55**.

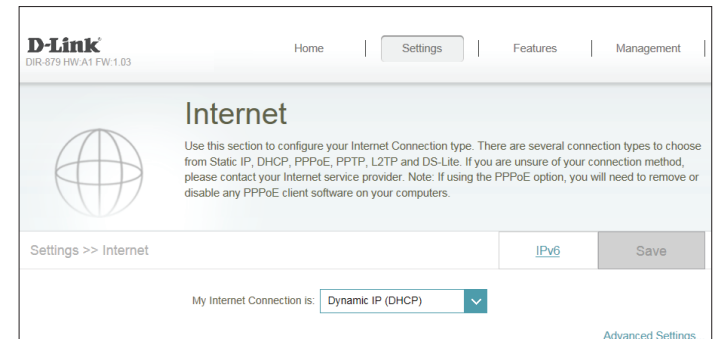

Dynamic IP (DHCP)

Select **Dynamic IP (DHCP)** to obtain IP address information automatically from your Internet Service Provider (ISP). Select this option if your ISP does not specify an IP address to use.

Advanced Settings

Host Name: The host name is optional but may be required by some ISPs. Leave it blank if you are not sure.

Primary DNS Server: Enter the primary DNS server IP address assigned by your ISP. This address is usually obtained automatically from your ISP.

Secondary DNS Server: Enter the secondary DNS server IP address assigned by your ISP. This address is usually obtained automatically from your ISP.

MTU: Maximum Transmission Unit - you may need to change the MTU for optimal performance with your ISP.

MAC Address Clone: The default MAC address is set to the Internet port's physical interface MAC address on the router. You can use the drop-down menu to replace the Internet port's MAC address with the MAC address of a connected client.

Click **Save** when you are done.

D-Link
DIR-879 HW:V1 FW:1.03

Home | Settings | Features | Management

Internet

Use this section to configure your Internet Connection type. There are several connection types to choose from Static IP, DHCP, PPPoE, PPTP, L2TP and DS-Lite. If you are unsure of your connection method, please contact your Internet service provider. Note: If using the PPPoE option, you will need to remove or disable any PPPoE client software on your computers.

Settings >> Internet IPv6 Save

My Internet Connection is: **Dynamic IP (DHCP)** ▼

[Advanced Settings...](#)

Host Name:

Primary DNS Server:

Secondary DNS Server:

MTU: **Auto** ▼

Mac Address Clone: << MAC Address ▼

Static IP

Select **Static IP** if your IP information is provided by your Internet Service Provider (ISP).

IP Address: Enter the IP address provided by your ISP.

Subnet Mask: Enter the subnet mask provided by your ISP.

Default Gateway: Enter the default gateway address provided by your ISP.

Primary DNS Server: Enter the primary DNS server IP address assigned by your ISP.

Advanced Settings

Secondary DNS Server: Enter the secondary DNS server IP address assigned by your ISP.

MTU: Maximum Transmission Unit - you may need to change the MTU for optimal performance with your ISP.

MAC Address Clone: The default MAC address is set to the Internet port's physical interface MAC address on the router. You can use the drop-down menu to replace the Internet port's MAC address with the MAC address of a connected client.

Click **Save** when you are done.

The screenshot shows the D-Link router's web interface for configuring the Internet connection. The 'Internet' section is active, and the connection type is set to 'Static IP'. The following fields are present:

- My Internet Connection is:** Static IP (dropdown menu)
- IP Address:** [Text input field]
- Subnet Mask:** [Text input field]
- Default Gateway:** [Text input field]
- Primary DNS Server:** [Text input field]
- Advanced Settings...** (link)
- Secondary DNS Server:** [Text input field]
- MTU:** Auto (dropdown menu)
- Mac Address Clone:** << MAC Address (dropdown menu)

PPPoE

Select **PPPoE** if your ISP provides and requires you to enter a PPPoE username and password in order to connect to the Internet.

Username: Enter the username provided by your ISP.

Password: Enter the password provided by your ISP.

Reconnect Mode: Select either **Always-on**, **On-Demand**, or **Manual**.

Maximum Idle Time: Enter a maximum idle time during which the Internet connection is maintained during inactivity. To disable this feature, enable Auto-reconnect.

Advanced Settings

Address Mode: Select **Static IP** if your ISP assigned you the IP address, subnet mask, gateway, and DNS server addresses. In most cases, select **Dynamic IP**.

Dynamic IP

IP Address: Enter the IP address provided by your ISP (Static IP only).

Service Name: Enter the ISP service name (optional).

Primary DNS Server: Enter the primary DNS server IP address assigned by your ISP.

Secondary DNS Server: Enter the secondary DNS server IP address assigned by your ISP.

MTU: Maximum Transmission Unit - you may need to change the MTU for optimal performance with your ISP. The recommended setting is **Auto**.

The screenshot shows the 'Internet' configuration page in the D-Link web interface. The 'My Internet Connection is:' dropdown is set to 'PPPoE'. Below it are input fields for 'Username:' and 'Password:'. The 'Reconnect Mode:' dropdown is set to 'On demand', and the 'Maximum Idle Time:' is set to '5 minutes'. There are 'IPv6' and 'Save' buttons. A note at the top explains that PPPoE requires client software on computers.

The screenshot shows the 'Advanced Settings' section for Dynamic IP. The 'Address Mode:' dropdown is set to 'Dynamic IP'. There are input fields for 'Service Name:', 'Primary DNS Server:', and 'Secondary DNS Server:'. The 'MTU:' dropdown is set to 'Auto'. There is a 'Mac Address Clone:' field with a dropdown menu set to '<< MAC Address'.

PPPoE (continued)

MAC Address Clone: The default MAC address is set to the Internet port's physical interface MAC address on the router. You can use the drop-down menu to replace the Internet port's MAC address with the MAC address of a connected client.

Static IP

IP Address: Enter the IP address provided by your ISP (Static IP only).

Service Name: Enter the ISP service name (optional).

Primary DNS Server: Enter the primary DNS server IP address assigned by your ISP.

Secondary DNS Server: Enter the secondary DNS server IP address assigned by your ISP.

MTU: Maximum Transmission Unit - you may need to change the MTU for optimal performance with your ISP.

MAC Address Clone: The default MAC address is set to the Internet port's physical interface MAC address on the router. You can use the drop-down menu to replace the Internet port's MAC address with the MAC address of a connected client.

Click **Save** when you are done.

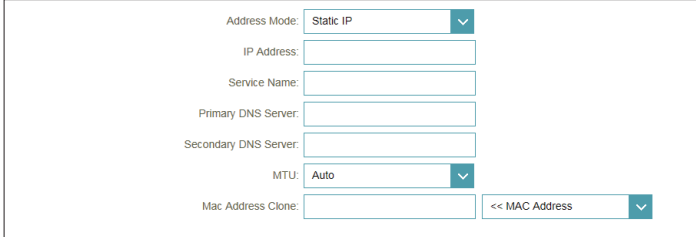

The screenshot shows a configuration form for PPPoE. It includes the following fields and options:

- Address Mode:** A dropdown menu currently set to "Static IP".
- IP Address:** An empty text input field.
- Service Name:** An empty text input field.
- Primary DNS Server:** An empty text input field.
- Secondary DNS Server:** An empty text input field.
- MTU:** A dropdown menu currently set to "Auto".
- Mac Address Clone:** A text input field with a dropdown menu to its right, currently set to "<< MAC Address".

PPTP

Choose PPTP (Point-to-Point-Tunneling Protocol) if your Internet Service Provider (ISP) uses a PPTP connection. Your ISP will provide you with a username and password.

PPTP Server IP Address: Enter the PPTP server IP address provided by your ISP.

Username: Enter the username provided by your ISP.

Password: Enter the password provided by your ISP.

Reconnect Mode: Select either **Always-on**, **On-Demand**, or **Manual**.

Maximum Idle Time: Enter a maximum idle time during which the Internet connection is maintained during inactivity. To disable this feature, enable Auto-reconnect.

Advanced Settings

Address Mode: Select **Static IP** if your ISP assigned you the IP address, subnet mask, gateway, and DNS server addresses. In most cases, select **Dynamic IP**.

Dynamic IP

Primary DNS Server: Enter the primary DNS server IP address assigned by your ISP.

Secondary DNS Server: Enter the secondary DNS server IP address assigned by your ISP.

MTU: Maximum Transmission Unit - you may need to change the MTU for optimal performance with your ISP. The recommended setting is **Auto**.

The screenshot displays the D-Link router's web interface for configuring the Internet connection. The main heading is 'Internet'. A note explains that this section is for configuring the connection type, listing options like Static IP, DHCP, PPPoE, PPTP, L2TP, and DS-Lite. The 'My Internet Connection is:' dropdown is set to 'PPTP'. Below it are input fields for 'PPTP Server IP Address', 'Username', and 'Password'. The 'Reconnect Mode:' dropdown is set to 'On demand', and the 'Maximum Idle Time:' is set to '5 minutes'. An 'Advanced Settings...' link is at the bottom right of this section. The second section shows 'Address Mode:' set to 'Dynamic IP', with input fields for 'Primary DNS Server', 'Secondary DNS Server', and 'MTU' set to 'Auto'.

PPTP (continued)

Static IP

PPTP IP Address: Enter the IP address provided by your ISP (Static IP only).

PPTP Subnet Mask: Enter the subnet mask provided by your ISP (Static IP only).

PPTP Gateway IP Address: Enter the gateway IP address provided by your ISP (Static IP only).

Primary DNS Server: Enter the primary DNS server IP address assigned by your ISP.

Secondary DNS Server: Enter the secondary DNS server IP address assigned by your ISP.

MTU: Maximum Transmission Unit - you may need to change the MTU for optimal performance with your ISP.

Click **Save** when you are done.

The screenshot shows a configuration form for PPTP. It includes the following fields and controls:

- Address Mode:** A dropdown menu currently set to "Static IP".
- PPTP IP Address:** A text input field.
- PPTP Subnet Mask:** A text input field.
- PPTP Gateway IP Address:** A text input field.
- Primary DNS Server:** A text input field.
- Secondary DNS Server:** A text input field.
- MTU:** A dropdown menu currently set to "Auto".

L2TP

Choose L2TP (Layer 2 Tunneling Protocol) if your Internet Service Provider (ISP) uses a L2TP connection. Your ISP will provide you with a username and password.

L2TP Server IP Address: Enter the L2TP server IP address provided by your ISP.

Username: Enter the username provided by your ISP.

Password: Enter the password provided by your ISP.

Reconnect Mode: Select either **Always-on**, **On-Demand**, or **Manual**.

Maximum Idle Time: Enter a maximum idle time during which the Internet connection is maintained during inactivity. To disable this feature, enable Auto-reconnect.

Advanced Settings

Address Mode: Select **Static IP** if your ISP assigned you the IP address, subnet mask, gateway, and DNS server addresses. In most cases, select **Dynamic IP**.

Dynamic IP

Primary DNS Server: Enter the primary DNS server IP address assigned by your ISP.

Secondary DNS Server: Enter the secondary DNS server IP address assigned by your ISP.

MTU: Maximum Transmission Unit - you may need to change the MTU for optimal performance with your ISP. The recommended setting is **Auto**.

The screenshot displays the D-Link router's web interface for configuring the Internet connection. The main heading is 'Internet'. A note explains that users can choose from Static IP, DHCP, PPPoE, PPTP, L2TP, and DS-Lite. The 'My Internet Connection is' dropdown menu is currently set to 'L2TP'. Below this, there are input fields for 'L2TP Server IP Address', 'Username', and 'Password'. The 'Reconnect Mode' is set to 'On demand' and the 'Maximum Idle Time' is set to 5 minutes. An 'Advanced Settings' link is located at the bottom right of this section. A separate section below contains 'Address Mode' (set to 'Dynamic IP'), 'Primary DNS Server', 'Secondary DNS Server', and 'MTU' (set to 'Auto').

L2TP (continued)

Static IP

L2TP IP Address: Enter the IP address provided by your ISP (Static IP only).

L2TP Subnet Mask: Enter the subnet mask provided by your ISP (Static IP only).

L2TP Gateway IP Address: Enter the gateway IP address provided by your ISP (Static IP only).

Primary DNS Server: Enter the primary DNS server IP address assigned by your ISP.

Secondary DNS Server: Enter the secondary DNS server IP address assigned by your ISP.

MTU: Maximum Transmission Unit - you may need to change the MTU for optimal performance with your ISP.

Click **Save** when you are done.

The screenshot shows a configuration form with the following fields and values:

- Address Mode: Static IP (dropdown menu)
- L2TP IP Address: (empty text input field)
- L2TP Subnet Mask: (empty text input field)
- L2TP Gateway IP Address: (empty text input field)
- Primary DNS Server: (empty text input field)
- Secondary DNS Server: (empty text input field)
- MTU: Auto (dropdown menu)

DS-Lite

DS-Lite is an IPv6 connection type. After selecting DS-Lite, the following parameters will be available for configuration:

Advanced Settings

DS-Lite Configuration: Select **DS-Lite DHCPv6** to let the router allocate the AFTR IPv6 address automatically. Select **Manual Configuration** to enter the AFTR IPv6 address manually.

DS-Lite DHCPv6

B4 IPv6 Address: Enter the B4 IPv4 address value used here.

WAN IPv6 Address: Once connected, the WAN IPv6 address will be displayed here.

IPv6 WAN Default Gateway: Once connected, the IPv6 WAN default gateway address will be displayed here.

Manual

AFTR IPv6 Address: Enter the AFTR IPv6 address used here.

B4 IPv6 Address: Enter the B4 IPv4 address value used here.

WAN IPv6 Address: Once connected, the WAN IPv6 address will be displayed here.

IPv6 WAN Default Gateway: Once connected, the IPv6 WAN default gateway address will be displayed here.

Click **Save** when you are done.

IPv6

To configure an IPv6 connection, click the **IPv6** link. To return to the IPv4 settings, click **IPv4**.

My Internet Connection Is: Choose your IPv6 connection type from the drop-down menu. You will be presented with the appropriate options for your connection type. Click **Advanced Settings...** to expand the list and see all of the options.

For **Auto Detection** refer to page **56**.

For **Static IPv6** refer to page **58**.

For **Auto Configuration (SLAAC/DHCPv6)** refer to page **60**.

For **PPPoE** refer to page **62**.

For **IPv6 in IPv4 Tunnel** refer to page **65**.

For **6 to 4** refer to page **67**.

For **6rd** refer to page **69**.

For **Local Connectivity Only** refer to page **71**.

The screenshot displays the IPv6 configuration interface for a D-Link DIR-879 router. The page title is "IPv6" and it includes a navigation menu with "Home", "Settings", "Features", and "Management". The main content area is titled "IPv6" and contains the following sections:

- My Internet Connection is:** A dropdown menu set to "Auto Detection".
- IPv6 DNS SETTINGS:** A dropdown menu for "DNS Type" set to "Obtain a DNS server address automatically".
- LAN IPv6 ADDRESS SETTINGS:** Displays the "LAN IPv6 Address" as "fe80::6e72:20ff:fe15:1654" and includes a link for "Advanced Settings".
- ADDRESS AUTOCONFIGURATION SETTINGS:**
 - "Enable Automatic IPv6 Address Assignment": Enabled (checkbox)
 - "Enable Automatic DHCP-PD in LAN": Enabled (checkbox)
 - "Autoconfiguration Type": SLAAC+Stateless DHCP (dropdown menu)
 - "Router Advertisement Lifetime": [] minutes (input field)

The footer of the page indicates "COPYRIGHT © 2015 D-LINK".

Auto Detection

Select **Auto Detection** to automatically detect the IPv6 connection method used by your Internet Service Provider (ISP). If Auto Detection fails, you manually select another IPv6 connection type.

IPv6 DNS Settings

DNS Type: Select either **Obtain DNS server address automatically** or **Use the following DNS address**.

If **Use the following DNS address** is selected:

Primary DNS Server: If you selected **Use the following DNS address** above, enter the primary DNS server address.

Secondary DNS Server: If you selected **Use the following DNS address** above, enter the secondary DNS server address.

LAN IPv6 Address Settings

LAN IPv6 Address: Displays the router's LAN IPv6 Address link-local address.

LAN IPv6 Link-Local Address: Displays the router's LAN link-local address.

The screenshot displays the D-Link router's IPv6 configuration interface. At the top, the D-Link logo and model number (DIR-879 HW:AT FW:1.03) are visible, along with navigation links for Home, Settings, Features, and Management. The main heading is 'IPv6', with a sub-note stating that all IPv6 Internet and network connection details are displayed on this page. Below the heading, there is a breadcrumb trail: Settings >> Internet >> IPv6. A 'Save' button is located to the right of the breadcrumb. The 'My Internet Connection is:' dropdown menu is set to 'Auto Detection'. Below this, there are three distinct sections for configuration: 1. 'IPv6 DNS SETTINGS' with a 'DNS Type' dropdown set to 'Obtain a DNS server address automatically'. 2. Another 'IPv6 DNS SETTINGS' section with 'DNS Type' set to 'Use the following DNS address', and two input fields for 'Primary DNS Server' and 'Secondary DNS Server'. 3. 'LAN IPv6 ADDRESS SETTINGS' showing the 'LAN IPv6 Address' and 'LAN IPv6 Link-Local Address' as 'fe80::6e72:20ff:fe15:1654', with a link for 'Advanced Settings'.

Auto Detection (continued)

Advanced Settings - Address Autoconfiguration Settings

Enable Automatic IPv6 Address Assignment: Enable or disable the Automatic IPv6 Address Assignment feature.

Enable Automatic DHCP-PD in LAN: Enable or disable DHCP-PD for other IPv6 routers connected to the LAN interface.
Note: This feature requires a smaller subnet prefix than /64 (i.e. allowing for a larger address allocation), such as /63. Contact your ISP for more information.

Autoconfiguration Type: Select **SLAAC+RDNSS**, **SLAAC+Stateless DHCP**, or **Stateful DHCPv6**.

If you selected **Stateful DHCPv6** as the Autoconfiguration Type:

IPv6 Address Range (Start): Enter the starting IPv6 address for the DHCP server's IPv6 assignment.

IPv6 Address Range (End): Enter the ending IPv6 address for the DHCP server's IPv6 assignment.

IPv6 Advertisement Lifetime: Enter the IPv6 address lifetime (in minutes).

Click **Save** when you are done.

ADDRESS AUTOCONFIGURATION SETTINGS

Enable Automatic IPv6 Address Assignment: Enabled

Enable Automatic DHCP-PD in LAN: Enabled

Autoconfiguration Type: SLAAC+RDNSS

Router Advertisement Lifetime: minutes

ADDRESS AUTOCONFIGURATION SETTINGS

Enable Automatic IPv6 Address Assignment: Enabled

Enable Automatic DHCP-PD in LAN: Enabled

Autoconfiguration Type: SLAAC+Stateless DHCP

Router Advertisement Lifetime: minutes

ADDRESS AUTOCONFIGURATION SETTINGS

Enable Automatic IPv6 Address Assignment: Enabled

Enable Automatic DHCP-PD in LAN: Enabled

Autoconfiguration Type: Stateful DHCPv6

IPv6 Address Range (Start): :00

IPv6 Address Range (End): :00

IPv6 Address Lifetime: minutes

Static IPv6

Select **Static IP** if your IPv6 information is provided by your Internet Service Provider (ISP).

Use Link-Local Address: Enable or disable link-local address use.

Default Gateway: Enter the default gateway for your IPv6 connection.

Primary DNS Server: Enter the primary DNS server address.

Secondary DNS Server: Enter the secondary DNS server address.

If **Use Link-Local Address** is disabled these additional parameters are available for configuration:

IPv6 Address: Enter the address supplied by your ISP.

Subnet Prefix Length: Enter the subnet prefix length supplied by your ISP.

LAN IPv6 Address Settings

LAN IPv6 Address: Enter the LAN (local) IPv6 address for the router.

LAN IPv6 Link-Local Address: Displays the router's LAN link-local address.

The screenshot shows the D-Link IPv6 configuration interface. At the top, there are navigation links for Home, Settings, Features, and Management. The main heading is 'IPv6' with a sub-heading: 'All of your IPv6 Internet and network connection details are displayed on this page.' Below this, there is a breadcrumb trail: 'Settings >> Internet >> IPv6'. A 'Save' button is visible in the top right corner. The 'My Internet Connection is:' dropdown is set to 'Static IPv6'. The 'Use Link-Local Address:' toggle is set to 'Enabled'. Below this, there are input fields for 'Default Gateway:', 'Primary DNS Server:', and 'Secondary DNS Server:'.

This screenshot shows the same IPv6 configuration page but with the 'Use Link-Local Address:' toggle set to 'Disabled'. In addition to the 'Default Gateway:', 'Primary DNS Server:', and 'Secondary DNS Server:' fields, there are now input fields for 'IPv6 Address:', 'Subnet Prefix Length:', and 'Default Gateway:' (repeated).

This screenshot shows the 'LAN IPv6 ADDRESS SETTINGS' section. It contains an input field for 'LAN IPv6 Address:' followed by '/64'. Below it, it says 'LAN IPv6 Link-Local Address: Not Available'. There is a link for 'Advanced Settings' in the bottom right corner.

Static IPv6 (continued)

Advanced Settings - Address Autoconfiguration Settings

Enable Automatic IPv6 Address Assignment: Enable or disable the Automatic IPv6 Address Assignment feature.

Autoconfiguration Type: Select **SLAAC+RDNSS**, **SLAAC+Stateless DHCP**, or **Stateful DHCPv6**.

If you selected **Stateful DHCPv6** as the Autoconfiguration Type:

IPv6 Address Range (Start): Enter the starting IPv6 address for the DHCP server's IPv6 assignment.

IPv6 Address Range (End): Enter the ending IPv6 address for the DHCP server's IPv6 assignment.

IPv6 Advertisement Lifetime: Enter the IPv6 address lifetime (in minutes).

Click **Save** when you are done.

ADDRESS AUTOCONFIGURATION SETTINGS

Enable Automatic IPv6 Address Assignment: Enabled

Autoconfiguration Type: SLAAC+RDNSS

Router Advertisement Lifetime: 60 minutes

ADDRESS AUTOCONFIGURATION SETTINGS

Enable Automatic IPv6 Address Assignment: Enabled

Autoconfiguration Type: SLAAC+Stateless DHCP

Router Advertisement Lifetime: 60 minutes

ADDRESS AUTOCONFIGURATION SETTINGS

Enable Automatic IPv6 Address Assignment: Enabled

Autoconfiguration Type: Stateful DHCPv6

IPv6 Address Range (Start): xxxx::00 3

IPv6 Address Range (End): xxxx::00 16

IPv6 Address Lifetime: 60 minutes

Auto Configuration (SLAAC/DHCPv6)

Select **Auto Configuration** if your ISP assigns your IPv6 address when your router requests one from the ISP's server. Some ISPs require you to adjust settings on your side before your router can connect to the IPv6 Internet.

IPv6 DNS Settings

DNS Type: Select either **Obtain DNS server address automatically** or **Use the following DNS address**.

If **Use the following DNS address** is selected:

Primary DNS Server: Enter the primary DNS server address.

Secondary DNS Server: Enter the secondary DNS server address.

LAN IPv6 Address Settings

Enable DHCP-PD: Enable or disable prefix delegation services.

LAN IPv6 Address: If you disabled DHCP-PD, enter the LAN (local) IPv6 address for the router.

LAN IPv6 Link-Local Address: Displays the router's LAN link-local address.

Auto Configuration (SLAAC/DHCPv6) (continued)

Advanced Settings - Address Autoconfiguration Settings

Enable Automatic IPv6 Address Assignment: Enable or disable the Automatic IPv6 Address Assignment feature.

If DHCP-PD is enabled in LAN IPv6 Address Settings:

Enable Automatic DHCP-PD in LAN: Enable or disable DHCP-PD for other IPv6 routers connected to the LAN interface. **Note:** *This feature requires a smaller subnet prefix than /64 (i.e. allowing for a larger address allocation), such as /63. Contact your ISP for more information.*

Autoconfiguration Type: Select **SLAAC+RDNSS**, **SLAAC+Stateless DHCP**, or **Stateful DHCPv6**.

If you selected **Stateful DHCPv6** as the Autoconfiguration Type:

IPv6 Address Range (Start): Enter the starting IPv6 address for the DHCP server's IPv6 assignment.

IPv6 Address Range (End): Enter the ending IPv6 address for the DHCP server's IPv6 assignment.

IPv6 Advertisement Lifetime: Enter the IPv6 address lifetime (in minutes).

Click **Save** when you are done.

ADDRESS AUTOCONFIGURATION SETTINGS

Enable Automatic IPv6 Address Assignment: Enabled

Enable Automatic DHCP-PD in LAN: Enabled

Autoconfiguration Type: SLAAC+Stateless DHCP

Router Advertisement Lifetime: minutes

ADDRESS AUTOCONFIGURATION SETTINGS

Enable Automatic IPv6 Address Assignment: Enabled

Enable Automatic DHCP-PD in LAN: Enabled

Autoconfiguration Type: SLAAC+RDNSS

Router Advertisement Lifetime: minutes

ADDRESS AUTOCONFIGURATION SETTINGS

Enable Automatic IPv6 Address Assignment: Enabled

Enable Automatic DHCP-PD in LAN: Enabled

Autoconfiguration Type: Stateful DHCPv6

IPv6 Address Range (Start): xxxx::00

IPv6 Address Range (End): xxxx::00

IPv6 Address Lifetime: minutes

PPPoE

Select **PPPoE** if your ISP provides and requires you to enter a PPPoE username and password in order to connect to the Internet.

PPPoE Session: Choose **Share with IPv4** to re-use your IPv4 PPPoE username and password, or **Create a new session**.

Username: Enter the username provided by your ISP. (Create a new session only)

Password: Enter the password provided by your ISP. (Create a new session only)

Address Mode: Select **Static IP** if your ISP assigned you an IP address. In most cases, select **Dynamic IP**.

IP Address: Enter the IP address provided by your ISP. (Static IP only)

Service Name: Enter the ISP service name (optional).

Reconnect Mode: Select either **Always-on** or **Manual**.

MTU: Maximum Transmission Unit - you may need to change the MTU for optimal performance with your ISP.

The screenshot shows the IPv6 configuration page in the D-Link router's web interface. The page title is "IPv6" and it includes a breadcrumb trail: "Settings >> Internet >> IPv6". There are tabs for "IPv4" and "Save". The configuration is divided into two sections: "Dynamic IP" and "Static IP".

Dynamic IP Section:

- My Internet Connection is: **PPPoE** (dropdown)
- PPPoE Session: **Share with IPv4** (dropdown)
- Address Mode: **Dynamic IP** (dropdown)

Static IP Section:

- Address Mode: **Static IP** (dropdown)
- IP Address:

PPPoE Session Configuration Section:

- PPPoE Session: **Create a new session** (dropdown)
- Username:
- Password:

Reconnect Mode Section:

- Address Mode: **Dynamic IP** (dropdown)
- Service Name:
- Reconnect Mode: **Always on** (dropdown)
- MTU: bytes

Static IP Configuration Section (Bottom):

- Address Mode: **Static IP** (dropdown)
- IP Address:
- Service Name:
- Reconnect Mode: **Always on** (dropdown)
- MTU: bytes

PPPoE(continued)

IPv6 DNS Settings

DNS Type: Select either **Obtain DNS server address automatically** or **Use the following DNS address**.

If **Use the following DNS address** is selected:

Primary DNS Server: Enter the primary DNS server address.

Secondary DNS Server: Enter the secondary DNS server address.

LAN IPv6 Address Settings

Enable DHCP-PD: Enable or disable prefix delegation services. This option is only available if you selected **Dynamic IP** for address mode.

LAN IPv6 Address: If DHCP-PD disabled or static address mode is selected, enter the LAN (local) IPv6 address for the router.

LAN IPv6 Link-Local Address: Displays the router's LAN link-local address.

IPv6 DNS SETTINGS

DNS Type: Obtain a DNS server address automatically

IPv6 DNS SETTINGS

DNS Type: Use the following DNS address

Primary DNS Server:

Secondary DNS Server:

LAN IPv6 ADDRESS SETTINGS

Enable DHCP-PD: Enabled

LAN IPv6 Link-Local Address: Not Available

[Advanced Settings...](#)

LAN IPv6 ADDRESS SETTINGS

Enable DHCP-PD: Disabled

LAN IPv6 Address: /64

LAN IPv6 Link-Local Address: Not Available

[Advanced Settings...](#)

PPPoE(continued)

Advanced Settings - Address Autoconfiguration Settings

Enable Automatic IPv6 Address Assignment: Enable or disable the Automatic IPv6 Address Assignment feature.

If **DHCP-PD** is available and enabled in LAN IPv6 Address Settings:

Enable Automatic DHCP-PD in LAN: Enable or disable DHCP-PD for other IPv6 routers connected to the LAN interface. **Note:** This feature requires a smaller subnet prefix than /64 (i.e. allowing for a larger address allocation), such as /63. Contact your ISP for more information.

Autoconfiguration Type: Select **SLAAC+RDNSS**, **SLAAC+Stateless DHCP**, or **Stateful DHCPv6**.

If you selected **Stateful DHCPv6** as the Autoconfiguration Type:

IPv6 Address Range (Start): Enter the starting IPv6 address for the DHCP server's IPv6 assignment.

IPv6 Address Range (End): Enter the ending IPv6 address for the DHCP server's IPv6 assignment.

IPv6 Advertisement Lifetime: Enter the IPv6 address lifetime (in minutes).

Click **Save** when you are done.

ADDRESS AUTOCONFIGURATION SETTINGS

Enable Automatic IPv6 Address Assignment: Enabled

Enable Automatic DHCP-PD in LAN: Enabled

Autoconfiguration Type: SLAAC+Stateless DHCP

Router Advertisement Lifetime: minutes

ADDRESS AUTOCONFIGURATION SETTINGS

Enable Automatic IPv6 Address Assignment: Enabled

Enable Automatic DHCP-PD in LAN: Enabled

Autoconfiguration Type: SLAAC+RDNSS

Router Advertisement Lifetime: minutes

ADDRESS AUTOCONFIGURATION SETTINGS

Enable Automatic IPv6 Address Assignment: Enabled

Enable Automatic DHCP-PD in LAN: Enabled

Autoconfiguration Type: Stateful DHCPv6

IPv6 Address Range (Start): xxxx::00

IPv6 Address Range (End): xxxx::00

IPv6 Address Lifetime: minutes

IPv6 in IPv4 Tunnel

The user can configure the IPv6 connection to run in IPv4 Tunnel mode. IPv6 over IPv4 tunnelling encapsulates IPv6 packets in IPv4 packets so that IPv6 packets can be sent over an IPv4 infrastructure.

Remote IPv4 Address: Enter the IPv4 remote address you will use.

Remote IPv6 Address: Enter the IPv6 remote address you will use.

Local IPv4 Address: Displays the current local IPv4 address.

Local IPv6 Address: Enter the IPv6 local address you will use.

Subnet Prefix Length: Enter the subnet prefix length supplied by your ISP.

IPv6 DNS Settings

DNS Type: Select either **Obtain DNS server address automatically** or **Use the following DNS address**.

If **Use the following DNS address** is selected:

Primary DNS Server: Enter the primary DNS server address.

Secondary DNS Server: Enter the secondary DNS server address.

The screenshot shows the D-Link IPv6 configuration interface. At the top, there are navigation links for Home, Settings, Features, and Management. The main heading is 'IPv6' with a sub-heading: 'All of your IPv6 Internet and network connection details are displayed on this page.' Below this, there is a breadcrumb trail: 'Settings >> Internet >> IPv6'. A dropdown menu is set to 'IPv4' and a 'Save' button is visible. The main configuration area is titled 'My Internet Connection is:' and is set to 'IPv6 in IPv4 tunnel'. Below this, there are input fields for 'Remote IPv4 Address', 'Remote IPv6 Address', 'Local IPv4 Address' (pre-filled with '192.168.150.132'), 'Local IPv6 Address', and 'Subnet Prefix Length'.

This screenshot shows the 'IPv6 DNS SETTINGS' section. The 'DNS Type' dropdown menu is set to 'Obtain a DNS server address automatically'.

This screenshot shows the 'IPv6 DNS SETTINGS' section with the 'DNS Type' dropdown menu set to 'Use the following DNS address'. Below this, there are input fields for 'Primary DNS Server' and 'Secondary DNS Server'.

IPv6 in IPv4 Tunnel (continued)

LAN IPv6 Address Settings

Enable DHCP-PD: Enable or disable prefix delegation services.

LAN IPv6 Address: If you disabled DHCP-PD, enter the LAN (local) IPv6 address for the router.

LAN IPv6 Link-Local Address: Displays the router's LAN link-local address.

Advanced Settings - Address Autoconfiguration Settings

Enable Automatic IPv6 Address Assignment: Enable or disable the Automatic IPv6 Address Assignment feature.

Autoconfiguration Type: Select **SLAAC+RDNSS**, **SLAAC+Stateless DHCP**, or **Stateful DHCPv6**.

If you selected **Stateful DHCPv6** as the Autoconfiguration Type:

IPv6 Address Range (Start): Enter the starting IPv6 address for the DHCP server's IPv6 assignment.

IPv6 Address Range (End): Enter the ending IPv6 address for the DHCP server's IPv6 assignment.

IPv6 Advertisement Lifetime: Enter the IPv6 address lifetime (in minutes).

Click **Save** when you are done.

LAN IPv6 ADDRESS SETTINGS

Enable DHCP-PD: Enabled

LAN IPv6 Link-Local Address: Not Available

[Advanced Settings](#)

LAN IPv6 ADDRESS SETTINGS

Enable DHCP-PD: Disabled

LAN IPv6 Address: /64

LAN IPv6 Link-Local Address: Not Available

[Advanced Settings](#)

ADDRESS AUTOCONFIGURATION SETTINGS

Enable Automatic IPv6 Address Assignment: Enabled

Enable Automatic DHCP-PD in LAN: Enabled

Autoconfiguration Type: ▼

Router Advertisement Lifetime: minutes

ADDRESS AUTOCONFIGURATION SETTINGS

Enable Automatic IPv6 Address Assignment: Enabled

Enable Automatic DHCP-PD in LAN: Enabled

Autoconfiguration Type: ▼

Router Advertisement Lifetime: minutes

ADDRESS AUTOCONFIGURATION SETTINGS

Enable Automatic IPv6 Address Assignment: Enabled

Enable Automatic DHCP-PD in LAN: Enabled

Autoconfiguration Type: ▼

IPv6 Address Range (Start): xxxx :00

IPv6 Address Range (End): xxxx :00

IPv6 Address Lifetime: minutes

6to4

In this section the user can configure the IPv6 6 to 4 connection settings. 6to4 is an IPv6 address assignment and automatic tunneling technology that is used to provide unicast IPv6 connectivity between IPv6 sites and hosts across the IPv4 Internet.

6to4 Address: Displays the 6 to 4 address.

6to4 Relay: Enter the 6 to 4 relay supplied by your ISP.

Primary DNS Server: Enter the primary DNS server address.

Secondary DNS Server: Enter the secondary DNS server address.

LAN IPv6 Address Settings

LAN IPv6 Address: Enter the LAN (local) IPv6 address for the router.

LAN IPv6 Link-Local Address: Displays the router's LAN link-local address.

The screenshot shows the D-Link IPv6 configuration interface. At the top, there is a navigation bar with 'Home', 'Settings', 'Features', and 'Management'. Below this is the 'IPv6' section header with a sub-header: 'All of your IPv6 Internet and network connection details are displayed on this page.' The main configuration area is titled 'Settings >> Internet >> IPv6' and includes a 'Save' button. The 'My Internet Connection is' dropdown is set to '6to4'. Below this, the '6to4 Address' is displayed as '192.168.150.132'. The '6to4 Relay' field contains '192.88.99.1'. There are empty input fields for 'Primary DNS Server' and 'Secondary DNS Server'. A section titled 'LAN IPv6 ADDRESS SETTINGS' shows 'LAN IPv6 Address' as 'FFFF:FFFF:FFFF: [] ::1 /64' and 'LAN IPv6 Link-Local Address' as 'Not Available'. An 'Advanced Settings' link is located at the bottom right.

6to4 (continued)

Advanced Settings - Address Autoconfiguration Settings

Enable Automatic IPv6 Address Assignment: Enable or disable the Automatic IPv6 Address Assignment feature.

Autoconfiguration Type: Select **SLAAC+RDNSS**, **SLAAC+Stateless DHCP**, or **Stateful DHCPv6**.

If you selected **Stateful DHCPv6** as the Autoconfiguration Type:

IPv6 Address Range (Start): Enter the starting IPv6 address for the DHCP server's IPv6 assignment.

IPv6 Address Range (End): Enter the ending IPv6 address for the DHCP server's IPv6 assignment.

IPv6 Advertisement Lifetime: Enter the IPv6 address lifetime (in minutes).

Click **Save** when you are done.

ADDRESS AUTOCONFIGURATION SETTINGS

Enable Automatic IPv6 Address Assignment: Enabled

Enable Automatic DHCP-PD in LAN: Enabled

Autoconfiguration Type: SLAAC+Stateless DHCP

Router Advertisement Lifetime: minutes

ADDRESS AUTOCONFIGURATION SETTINGS

Enable Automatic IPv6 Address Assignment: Enabled

Enable Automatic DHCP-PD in LAN: Enabled

Autoconfiguration Type: SLAAC+RDNSS

Router Advertisement Lifetime: minutes

ADDRESS AUTOCONFIGURATION SETTINGS

Enable Automatic IPv6 Address Assignment: Enabled

Enable Automatic DHCP-PD in LAN: Enabled

Autoconfiguration Type: Stateful DHCPv6

IPv6 Address Range (Start): xxxx::00 3

IPv6 Address Range (End): xxxx::00 16

IPv6 Address Lifetime: minutes

6rd

In this section the user can configure the IPv6 6rd connection settings.

Assign IPv6 Prefix: Currently unsupported.

Primary DNS Server: Enter the primary DNS server address.

Secondary DNS Server: Enter the secondary DNS server address.

6rd Manual Configuration

Enable Hub and Spoke Mode: Enable if you want to minimize the number of routes to the destination by using a hub and spoke method of networking.

6rd Configuration: Choose the **6rd DHCPv4 Option** to automatically discover and populate the data values, or **Manual Configuration** to enter the settings yourself.

If you selected **Manual configuration**

6rd IPv6 Prefix: Enter the 6rd IPv6 prefix and mask length supplied by your ISP.

WAN IPv4 Address Displays the router's IPv4 address.

6rd Border Relay IPv4 Address: Enter the 6rd border relay IPv4 address settings supplied by your ISP.

LAN IPv6 Address Settings

LAN IPv6 Address: Displays the router's LAN IPv6 Address link-local address.

LAN IPv6 Link-Local Address: Displays the router's LAN link-local address.

The screenshot shows the D-Link IPv6 configuration interface. At the top, there are navigation links for Home, Settings, Features, and Management. The main heading is 'IPv6' with a sub-heading: 'All of your IPv6 Internet and network connection details are displayed on this page.' Below this, there's a breadcrumb trail: 'Settings >> Internet >> IPv6'. A 'Save' button is visible. The 'My Internet Connection is:' dropdown is set to '6rd'. Below it are input fields for 'Assign IPv6 Prefix', 'Primary DNS Server', and 'Secondary DNS Server'. The '6RD MANUAL CONFIGURATION' section is expanded, showing 'Enable Hub and Spoke Mode' as 'Enabled' and '6rd Configuration' as '6rd DHCPv4 Option'.

This screenshot is identical to the one above, showing the '6RD MANUAL CONFIGURATION' section with '6rd Configuration' set to '6rd DHCPv4 Option'.

This screenshot shows the '6RD MANUAL CONFIGURATION' section with '6rd Configuration' set to 'Manual Configuration'. The '6rd IPv6 Prefix' field is empty, and the mask length is set to '32'. The 'WAN IPv4 Address' field is populated with '192.168.150.155'. The '6rd Border Relay IPv4 Address' field is empty.

The screenshot shows the 'LAN IPv6 ADDRESS SETTINGS' section. It displays 'LAN IPv6 Address: Not Available' and 'LAN IPv6 Link-Local Address: Not Available'. There is a link for 'Advanced Settings' at the bottom right.

6rd (continued)

Advanced Settings - Address Autoconfiguration Settings

Enable Automatic IPv6 Address Assignment: Enable or disable the Automatic IPv6 Address Assignment feature.

Autoconfiguration Type: Select **SLAAC+RDNSS**, **SLAAC+Stateless DHCP**, or **Stateful DHCPv6**.

If you selected **Stateful DHCPv6** as the Autoconfiguration Type:

IPv6 Address Range (Start): Enter the starting IPv6 address for the DHCP server's IPv6 assignment.

IPv6 Address Range (End): Enter the ending IPv6 address for the DHCP server's IPv6 assignment.

IPv6 Advertisement Lifetime: Enter the IPv6 address lifetime (in minutes).

Click **Save** when you are done.

ADDRESS AUTOCONFIGURATION SETTINGS

Enable Automatic IPv6 Address Assignment: Enabled

Autoconfiguration Type: SLAAC+RDNSS

Router Advertisement Lifetime: 60 minutes

ADDRESS AUTOCONFIGURATION SETTINGS

Enable Automatic IPv6 Address Assignment: Enabled

Autoconfiguration Type: SLAAC+Stateless DHCP

Router Advertisement Lifetime: 60 minutes

ADDRESS AUTOCONFIGURATION SETTINGS

Enable Automatic IPv6 Address Assignment: Enabled

Autoconfiguration Type: Stateful DHCPv6

IPv6 Address Range (Start): xxxx::00 3

IPv6 Address Range (End): xxxx::00 16

IPv6 Address Lifetime: 60 minutes

Local Connectivity Only

Local Connectivity Only allows you to set up an IPv6 connection that will not connect to the Internet.

Advanced Settings

IPv6 ULA Settings

Enable ULA: Click here to enable Unique Local IPv6 Unicast Addresses settings.

If you selected **Enable ULA** and **Disabled Default ULA Prefix:**

ULA Prefix: Enter your own ULA prefix.

Current IPv6 ULA Settings

Current ULA Prefix: Displays the current ULA prefix.

LAN IPv6 ULA: Displays the LAN's IPv6 ULA.

Click **Save** when you are done.

The screenshot shows the D-Link DIR-879 HW v1 FW 1.03 web interface. The main heading is "IPv6" with a sub-heading "All of your IPv6 Internet and network connection details are displayed on this page." Below this, there is a breadcrumb trail "Settings >> Internet >> IPv6" and a "Save" button. A dropdown menu shows "My Internet Connection is: Local Connectivity Only".

There are three sections for IPv6 ULA settings:

- IPv6 ULA SETTINGS:** Contains two toggle switches: "Enable ULA:" (set to Enabled) and "Use Default ULA Prefix:" (set to Enabled).
- IPv6 ULA SETTINGS:** Contains two toggle switches: "Enable ULA:" (set to Enabled) and "Use Default ULA Prefix:" (set to Disabled). Below these is a text input field for "ULA Prefix:" followed by "/64".
- CURRENT IPv6 ULA SETTINGS:** Displays "Current ULA Prefix: Not Available" and "LAN IPv6 ULA: Not Available".

Wireless

From this page you can configure your wireless network settings.

Smart Connect

Smart Connect: Enable or disable the Smart Connect Feature. When enabled only a few configuration options are available to simplify configuration.

Wi-Fi Name (SSID): Create a name for your wireless network using up to 32 characters.

Password: Create a password to use for wireless security. Wireless clients will need to enter this password to successfully connect to the network.

Advanced Settings

Security Mode: Choose **None** or **WPA/WPA2-(Personal)** (recommended).

Transmission Power: Select the desired wireless transmission power.

Schedule: Use the drop-down menu to select the time schedule that the rule will be enabled on. The schedule may be set to **Always Enable**, or you can create your own schedules in the **Schedules** section. Refer to **Schedule** on page **90** for more information.

Refer to the next page if you wish to disable Smart Connect or click **Save** when you are done.

The screenshot displays the D-Link router's configuration interface for wireless settings. At the top, there are navigation links for Home, Settings, Features, and Management. The main heading is 'Wireless', with a sub-instruction: 'Use this section to configure the wireless settings for your D-Link Router. Please make sure that any changes made in this section will need to be updated on your wireless device.' Below this, there are two main sections: 'Smart Connect' and 'Advanced Settings'. In the 'Smart Connect' section, the 'Smart Connect' toggle is set to 'Enabled'. The 'Wi-Fi Name (SSID)' field contains 'dlink-EC1C' and the 'Password' field contains 'dgtjc24628'. In the 'Advanced Settings' section, the 'Security Mode' is set to 'WPA/WPA2-Personal', 'Transmission Power' is set to 'High', and the 'Schedule' is set to 'Always Enable'. A 'Save' button is visible at the bottom right of the 'Smart Connect' section.

Wireless - Smart Connect Disabled

If Smart Connect is **Disabled** the following options are available:

2.4GHz / 5GHz

Status: Enable or disable the 2.4 GHz / 5 GHz wireless network.

Wi-Fi Name (SSID): Create a name for your wireless network using up to 32 characters.

Password: Create a password to use for wireless security.

Advanced Settings

Security Mode: Choose **None** or **WPA/WPA2-(Personal)** (recommended).

802.11 Mode (2.4 GHz): Select the desired wireless networking standards to use. The available options for the 2.4 GHz wireless network are **Mixed 802.11b/g/n, Mixed 802.11g/n, 802.11n only**.

802.11 Mode (5 GHz): Select the desired wireless networking standards to use. The available options for the 5 GHz wireless network are **Mixed 802.11a/n/ac, Mixed 802.11n/ac, 802.11ac only, Mixed 802.11a/n, Mixed 802.11n only, or 802.11a only**.

Wi-Fi Channel: Select the desired channel. The default is **Auto** (recommended).

Transmission Power: Select the desired wireless transmission power.

Channel Width (2.4 GHz): Select **Auto 20/40** if you are using both 802.11n and non-802.11n devices, or select **20 MHz** if you are not using any 802.11n devices.

Channel Width (5 GHz): Select **Auto 20/40/80** if you are using 802.11ac, 802.11n, and 802.11a devices, select **Auto 20/40** if you are using 802.11n and 802.11a devices, or select **20 MHz** if you are only using 802.11a devices.

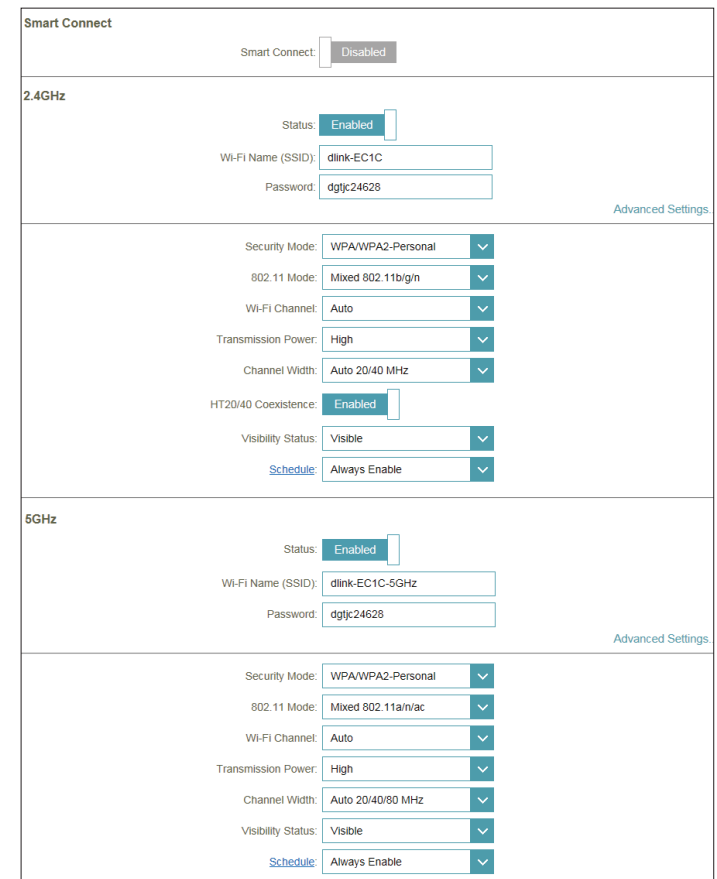
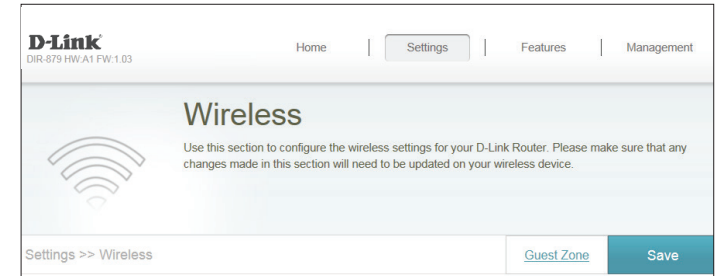

HT20/40 Coexistence: (2.4 GHz): Enable or disable HT20/40 Coexistence.

Visibility Status: The default setting is **Visible**. Select **Invisible** if you do not want to broadcast the SSID of your wireless network.

Schedule: Use the drop-down menu to select the time schedule that the rule will be enabled on. The schedule may be set to **Always Enable**, or you can create your own schedules in the **Schedules** section. Refer to **Schedule** on page **90** for more information.

Smart Connect

Smart Connect: Disabled

2.4GHz

Status: Enabled

Wi-Fi Name (SSID):

Password:

[Advanced Settings](#)

Security Mode:

802.11 Mode:

Wi-Fi Channel:

Transmission Power:

Channel Width:

HT20/40 Coexistence: Enabled

Visibility Status:

[Schedule](#):

5GHz

Status: Enabled

Wi-Fi Name (SSID):

Password:

[Advanced Settings](#)

Security Mode:

802.11 Mode:

Wi-Fi Channel:

Transmission Power:

Channel Width:

Visibility Status:

[Schedule](#):

Guest Zone

The guest zone feature will allow you to create temporary zones that can be used by guests to access the Internet. These zones will be separate from your main wireless network. You may configure different zones for the 2.4 GHz and 5 GHz wireless bands.

Note: If Smart Connect is enabled, Guest Zone is unavailable.

In the Settings menu on the bar on the top of the page, click **Wireless**, then click the **Guest Zone** link. Click **Advanced Settings...** to expand the list and see all of the options.

2.4 GHz / 5 GHz

Status: Enable or disable the 2.4 GHz / 5 GHz wireless network.

Wi-Fi Name (SSID): Create a name for your wireless network using up to 32 characters.

Password: Create a password to use for wireless security.

Home Network Access

Internet Access Only: Enabling this option will confine connectivity to the Internet, disallowing guests from accessing other local network devices.

Click **Save** when you are done.

D-Link
DIR-879 HW: A1 FW: 1.03

Home | Settings | Features | Management

Guest Zone

This page lets you enable and configure a Wi-Fi Guest Zone. Users connected to a Guest Zone cannot communicate or detect devices on your home network unless Internet Access Only is disabled under Home Network Access.

Settings >> Wireless >> Guest Zone [Wi-Fi](#) [Save](#)

2.4GHz

Status:

Wi-Fi Name (SSID):

Password:

5GHz

Status:

Wi-Fi Name (SSID):

Password:

Home Network Access

Internet Access Only: Enabled

Network

This section will allow you to change the local network settings of the router and to configure the DHCP settings. In the Settings menu on the bar on the top of the page, click **Network**. Click **Advanced Settings...** to expand the list and see all of the options.

Network Settings

LAN IP Address: Enter the IP address of the router. The default IP address is **192.168.0.1**. If you change the IP address, once you click **Save**, you will need to enter the new IP address in your browser to get back into the configuration utility

Subnet Mask: Enter the subnet mask of the router. The default subnet mask is **255.255.255.0**.

Management Link: The default address to access the router's configuration is **http://dlinkrouter.local/**. Here, you can replace **dlinkrouter** with a name of your choice.

Local Domain Name: Enter the domain name (optional).

Enable DNS Relay: Disable to transfer the DNS server information from your ISP to your computers. If enabled, your computers will use the router for a DNS server.

The screenshot shows the D-Link web interface for the Network Settings page. At the top, there is a navigation bar with 'Home', 'Settings', 'Features', and 'Management'. Below this is a 'Network' section with a sub-header and a brief instruction: 'Use this section to configure the network settings for your device. You can enter a name for your device in the management link field, and use the link to access web UI in a web browser. Recommend to change the management link if there are more than one D-Link devices within the network.' Below the instruction is a 'Save' button. The main content area is titled 'Network Settings' and contains the following fields: 'LAN IP Address' (192.168.0.1), 'Subnet Mask' (255.255.255.0), 'Management Link' (http://dlinkrouter.local/), 'Local Domain Name' (empty), and 'Enable DNS Relay' (Enabled). A link for 'Advanced Settings' is located at the bottom right of the form.

Network (continued)

Advanced Settings - DHCP Server

Status: Enable or disable the DHCP server.

DHCP IP Address Range: Enter the starting and ending IP addresses for the DHCP server's IP assignment.

Note: *If you statically (manually) assign IP addresses to your computers or devices, make sure the IP addresses are outside of this range or you may have an IP conflict.*

DHCP Lease Time: Enter the length of time for the IP address lease in minutes.

Always Broadcast: Enable this feature to broadcast your networks DHCP server to LAN/WLAN clients.

Advanced Settings

WAN Port Speed: You may set the port speed of the Internet port to 10 Mbps, 100 Mbps, 1000 Mbps, or Auto (recommended).

UPnP: Enable or disable Universal Plug and Play (UPnP). UPnP provides compatibility with networking equipment, software and peripherals.

IPv4 Multicast Stream: Enable to allow IPv4 multicast traffic to pass through the router from the Internet.

IPv6 Multicast Stream: Enable to allow IPv6 multicast traffic to pass through the router from the Internet.

Click **Save** when you are done.

DHCP Server

Status: Enabled

DHCP IP Address Range: 192.168.0. to 192.168.0.

DHCP Lease Time: minutes

Always Broadcast: Disabled
(compatibility for some DHCP Clients)

Advanced Settings

WAN Port Speed: ▼

UPnP: Enabled

IPv4 Multicast Streams: Disabled

IPv6 Multicast Streams: Enabled

Features

QoS Engine

This section will allow you to prioritize particular clients over others, so that those clients receive higher bandwidth. For example, if one client is streaming a movie and another is downloading a non-urgent file, you might wish to assign the former device a higher priority than the latter so that the movie streaming is not disrupted by the traffic of the other devices on the network.

In the Features menu on the bar on the top of the page, click **QoS Engine**.

Under All Devices, you will see device cards representing each connected client. If some are off-screen, you can use the < and > buttons to scroll through the cards.

A maximum of **one** device can be assigned **Highest** priority.

A maximum of **two** devices can be assigned **High** priority.

A maximum of **eight** devices can be assigned **Medium** priority.

If no devices are explicitly assigned a priority, they will all be treated with equal priority. If some devices are not assigned a priority and others are, the unassigned devices will be treated with the lowest priority.

To assign a priority level to a device, drag the device card from the All Devices list over an empty slot and release the mouse button. The card will remain in the slot. If you want to remove a priority assignment from a device and return it to the All Devices list, click the cross icon in the top right of the device card.

Click **Save** when you are done.

Firewall Settings

The router's firewall protects your network from malicious attacks over the Internet. In the Features menu on the bar on the top of the page, click **Firewall Settings**. Click **Advanced Settings...** to expand the list and see all of the options.

Enable DMZ: Enable or disable Demilitarized Zone (DMZ). This completely exposes the client to threats over the Internet, and is not recommended in ordinary situations.

DMZ IP Address: If you enabled DMZ, enter the IP address of the client you wish to expose, or use the drop-down menu to quickly select it.

Enable SPI IPv4: Enabling Stateful Packet Inspection (SPI) helps to prevent cyber attacks by validating that the traffic passing through the session conforms to the protocol.

Enable Anti-Spoof Checking: Enable this feature to protect your network from certain kinds of "spoofing" attacks.

IPv6 Simple Security: Enable or disable IPv6 simple security.

IPv6 Ingress Filtering: Enable or disable IPv6 ingress filtering.

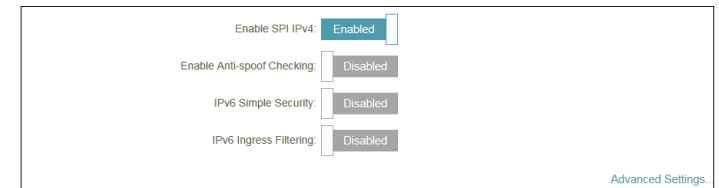
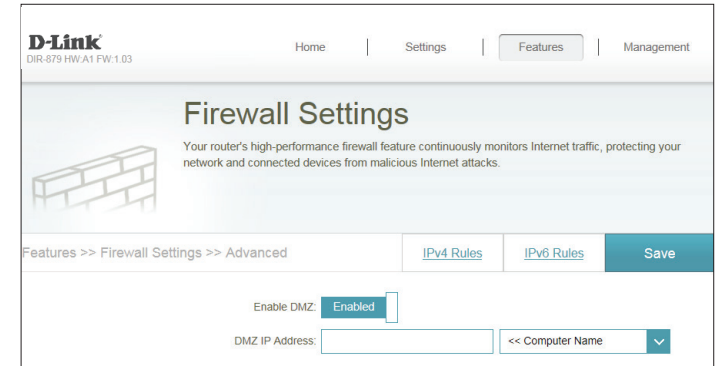

Firewall Settings (continued)

Advanced Settings - Application Level Gateway (ALG) Configuration

PPTP: Allows multiple machines on the LAN to connect to their corporate network using the PPTP protocol.

IPSec (VPN): Allows multiple VPN clients to connect to their corporate network using IPSec. Some VPN clients support traversal of IPSec through NAT. This Application Level Gateway (ALG) may interfere with the operation of such VPN clients. If you are having trouble connecting with your corporate network, try turning this ALG off. Please check with the system administrator of your corporate network whether your VPN client supports NAT traversal.

RTSP: Allows applications that uses Real Time Streaming Protocol (RTSP) to receive streaming media from the Internet.

SIP: Allows devices and applications using VoIP (Voice over IP) to communicate across NAT. Some VoIP applications and devices have the ability to discover NAT devices and work around them. This ALG may interfere with the operation of such devices. If you are having trouble making VoIP calls, try turning this ALG off.

Click **Save** when you are done.

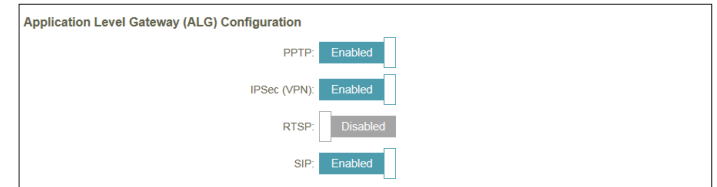

IPv4/IPv6 Rules

The IPv4/IPv6 Rules section is an advanced option that lets you configure what kind of traffic is allowed to pass through the network. To configure the IPv4 rules, from the Firewall Settings page click **IPv4 Rules**. To configure IPv6 rules, from the Firewall Settings page click **IPv6 Rules**. To return to the main Firewall Settings page, click **Security Check**.

To begin, use the drop-down menu to select whether you want to **ALLOW** or **DENY** the rules you create. You can also choose to turn filtering **OFF**.

If you wish to remove a rule, click on its trash can icon in the Delete column. If you wish to edit a rule, click on its pencil icon in the Edit column. If you wish to create a new rule, click the **Add Rules** button. Click **Save** when you are done. If you edit or create a rule, the following options will appear:

Name: Enter a name for the rule.

Source IP Address Range: Enter the source IP address range that the rule will apply to, and using the drop-down menu, specify whether it is a **WAN** or **LAN** IP address.

Destination IP Address Range: Enter the destination IP address range that the rule will apply to, and using the drop-down menu, specify whether it is a **WAN** or **LAN** IP address.

Port Range: Select the protocol of the traffic to allow or deny (**Any**, **TCP**, or **UDP**) and then enter the range of ports that the rule will apply to.

Schedule: Use the drop-down menu to select the time schedule that the rule will be enabled on. The schedule may be set to **Always Enable**, or you can create your own schedules in the **Schedules** section. Refer to **Wireless on page 72** for more information.

Click **Save** when you are done.

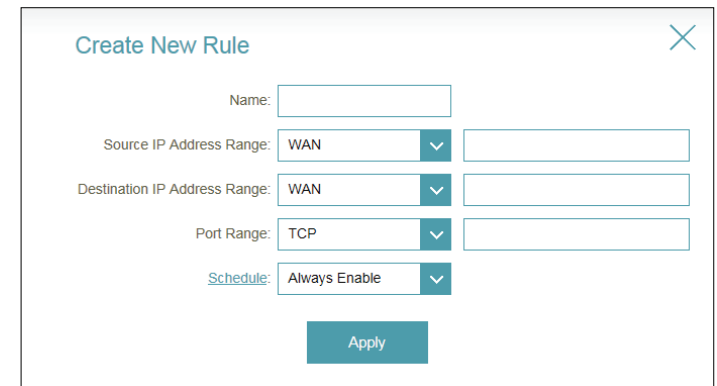
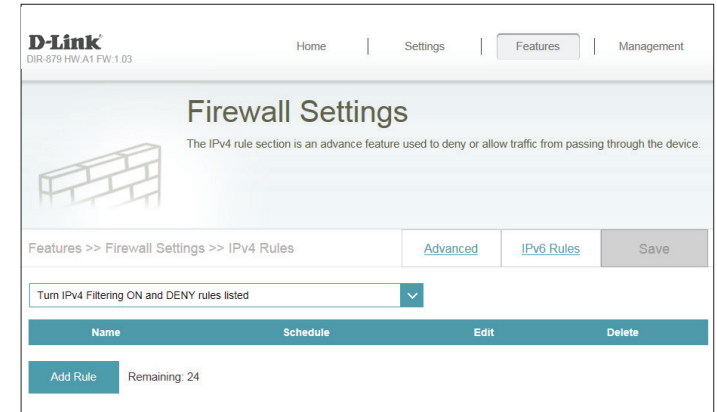

Port Forwarding

Port forwarding allows you to specify a port or range of ports to open for specific devices on the network. This might be necessary for certain applications to connect through the router. In the Features menu on the bar on the top of the page, click **Port Forwarding**.

If you wish to remove a rule, click on its trash can icon in the Delete column. If you wish to edit a rule, click on its pencil icon in the Edit column. If you wish to create a new rule, click the **Add Rules** button. Click **Save** when you are done. If you edit or create a rule, the following options will appear:

Name: Enter a name for the rule.

Local IP: Enter the IP address of the computer on your local network that you want to allow the incoming service to. Alternatively, select the device from the drop-down menu.

TCP Port: Enter the TCP ports that you want to open. You can enter a single port or a range of ports. Separate ports with a comma (for example: 24,1009,3000-4000).

UDP Port: Enter the UDP ports that you want to open. You can enter a single port or a range of ports. Separate ports with a comma (for example: 24,1009,3000-4000).

Schedule: Use the drop-down menu to select the time schedule that the rule will be enabled on. The schedule may be set to **Always Enable**, or you can create your own schedules in the **Schedules** section. Refer to **Schedule** on page **90** for more information.

Click **Save** when you are done.

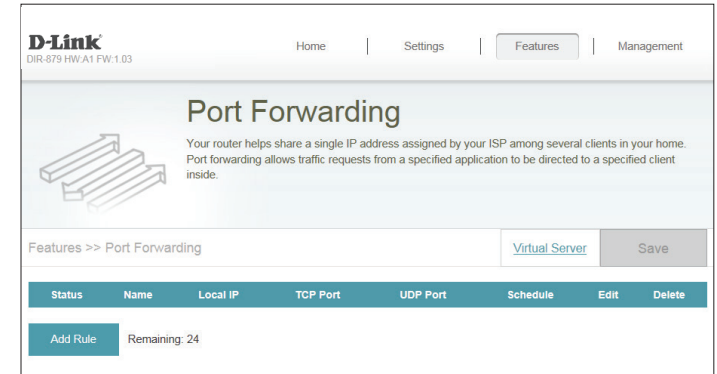

Virtual Server

The virtual server allows you to specify a single public port on your router for redirection to an internal LAN IP Address and Private LAN port. To configure the virtual server, from the Port Forwarding page click **Virtual Server**. To return to the main Port Forwarding page, click **Port Forwarding**.

If you wish to remove a rule, click on its trashcan icon in the Delete column. If you wish to edit a rule, click on its pencil icon in the Edit column. If you wish to create a new rule, click the **Add Rules** button. Click **Save** when you are done. If you edit or create a rule, the following options will appear:

Name: Enter a name for the rule. Alternatively, select the protocol/Application from the drop-down menu.

Local IP: Enter the IP address of the computer on your local network that you want to allow the incoming service to. Alternatively, select the device from the drop-down menu.

Protocol: Select the protocol of the traffic to allow or deny (**TCP**, **UDP**, **Both**, or **Other**).

Protocol Number: If you entered **Other** above, enter the protocol number.

External Port: Enter the public port you want to open.

Internal Port: Enter the private port you want to open.

Schedule: Use the drop-down menu to select the time schedule that the rule will be enabled on. The schedule may be set to **Always Enable**, or you can create your own schedules in the **Schedules** section. Refer to **Schedule** on page **90** for more information.

Click **Save** when you are done.

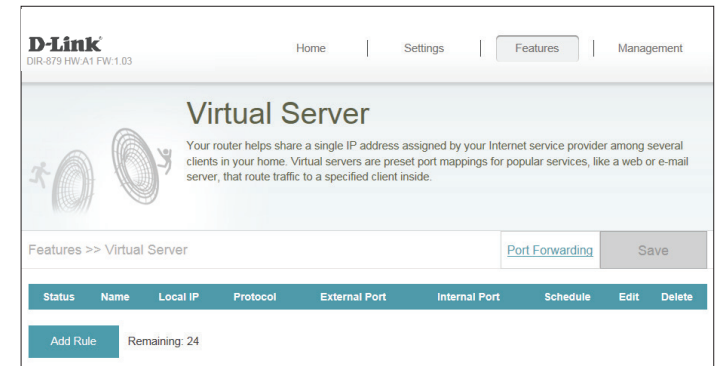

Website Filter

The website filter settings allow you to block access to certain web sites. You can either create a list of sites to block, or create a list of sites to allow (with all other sites being blocked).

In the Features menu on the bar on the top of the page, click **Website Filter**.

If you want to create a list of sites to block, select **DENY computers access to ONLY these sites** from the drop-down menu. All other sites will be accessible. If you want to specify a list of sites to allow, select **ALLOW computers access to ONLY these sites** from the drop-down menu. All other sites will be blocked.

You may specify a maximum of fifteen web sites. To add a new site to the list, click **Create New Rule**. Next, under Website URL/Domain enter the URL or domain. If you wish to remove a rule, click on its trashcan icon in the Delete column. If you wish to edit a rule, simply replace the URL or domain.

Click **Save** when you are done.

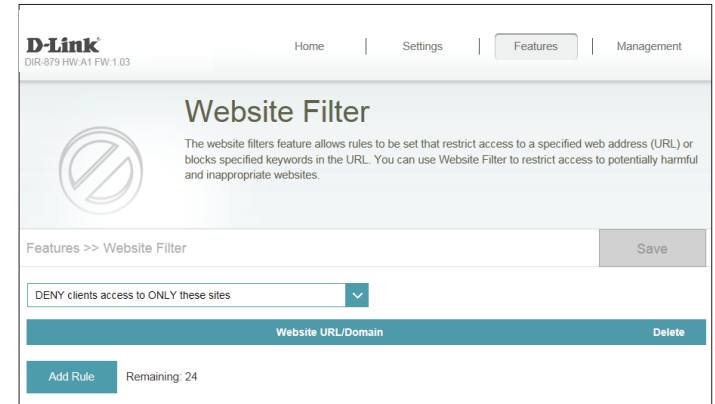

Static Routes

The Static Routes section allows you to define custom routes to control how data traffic is moved around your network.

In the Features menu on the bar on the top of the page, click **Static Routes**. To configure IPv6 rules, click **IPv6** and refer to **IPv6** on page **86**. To return to the main IPv4 static routes page, click **IPv4**.

If you wish to remove a rule, click on its trash can icon in the Delete column. If you wish to edit a rule, click on its pencil icon in the Edit column. If you wish to create a new rule, click the **Add Rules** button. Click **Save** when you are done. If you edit or create a rule, the following options will appear:

Name: Enter a name for the rule.

Destination Network: Enter the IP address of packets that will take this route.

Mask: Enter the netmask of the route.

Gateway: Enter your next hop gateway to be taken if this route is used.

Metric: The route metric is a value from 1 to 16 that indicates the cost of using this route. A value 1 is the lowest cost and 15 is the highest cost.

Interface: Select the interface that the IP packet must use to transit out of the router when this route is used.

Click **Save** when you are done.

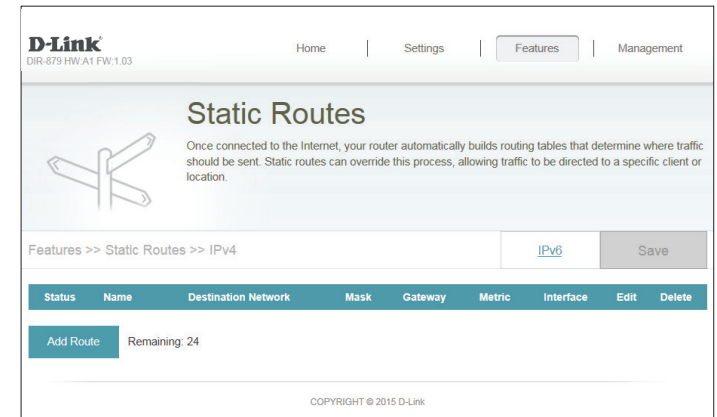

IPv6

To configure IPv6 rules, on the Static Routes page click **IPv6**. To return to the main IPv4 static routes page, click **IPv4**.

If you wish to remove a rule, click on its trash can icon in the Delete column. If you wish to edit a rule, click on its pencil icon in the Edit column. If you wish to create a new rule, click the **Add Rules** button. Click **Save** when you are done. If you edit or create a rule, the following options will appear:

Name: Enter a name for the rule.

DestNetwork: This is the IP address of the router used to reach the specified destination.

PrefixLen: Enter the IPv6 address prefix length of the packets that will take this route.

Gateway: Enter your next hop gateway to be taken if this route is used.

Metric: Enter the metric value for this rule here.

Interface: Select the interface that the IP packet must use to transit out of the router when this route is used.

Click **Save** when you are done.

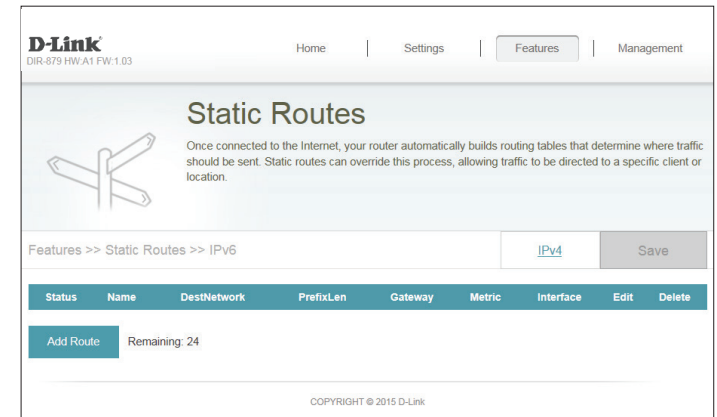

Create New Route ✕

Name:

DestNetwork:

PrefixLen:

Gateway:

Metric:

Interface: WAN ▼

Dynamic DNS

Most Internet Service Providers (ISPs) assign dynamic (changing) IP addresses. Using a dynamic DNS service provider, people can enter your domain name in their web browser to connect to your server no matter what your IP address is.

In the Features menu on the bar on the top of the page, click **Dynamic DNS**.

Enable Dynamic DNS: Enabling dynamic DNS will reveal further configuration options.

Status: Displays the current dynamic DNS connection status.

Server Address: Enter the address of your dynamic DNS server, or select one from the drop-down menu.

Host Name: Enter the host name that you registered with your dynamic DNS service provider.

User Name: Enter your dynamic DNS username.

Password: Enter your dynamic DNS password.

Time Out: Enter a timeout time (in hours).

Click **Save** when you are done.

At the bottom of the page are the IPv6 host settings. To configure an IPv6 dynamic DNS host, refer to **IPv6 Host** on page **88**.

D-Link
DIR-879 HW v1 FW:1.03

Home | Settings | Features | Management

Dynamic DNS

Dynamic Domain Name Service allows your router to associate an easy-to-remember domain name such as [YourDomainName].com with the regularly changing IP address assigned by your Internet Service provider. This feature is helpful when running a virtual server.

Features >> Dynamic DNS Save

Enable Dynamic DNS: Enabled

Status: Disconnected

Server Address: dyndns.com

Host Name:

User Name:

Password:

Time Out: hours

Status	Host Name	IPv6 Address	Edit	Delete
Add Record	Remaining: 10			

COPYRIGHT © 2015 D-Link

IPv6 Host

The IPv6 host settings are found at the bottom of the Dynamic DNS page.

If you wish to remove a rule, click on its trash can icon in the Delete column. If you wish to edit a rule, click on its pencil icon in the Edit column. If you wish to create a new rule, click the **Add Rules** button. Click **Save** when you are done. If you edit or create a rule, the following options will appear:

Host Name: Enter the host name that you registered with your dynamic DNS service provider.

IPv6 Address: Enter the IPv6 address of the dynamic DNS server. Alternatively, select the server device in the drop-down menu.

Click **Save** when you are done.

D-Link
DIR-879 HW: A1 FW: 1.03

Home | Settings | Features | Management

Dynamic DNS

Dynamic Domain Name Service allows your router to associate an easy-to-remember domain name such as [YourDomainName].com with the regularly changing IP address assigned by your Internet Service provider. This feature is helpful when running a virtual server.

Features >> Dynamic DNS Save

Enable Dynamic DNS: Enabled

Status: Disconnected

Server Address:

Host Name:

User Name:

Password:

Time Out: hours

Status	Host Name	IPv6 Address	Edit	Delete
Add Record Remaining: 10				

COPYRIGHT © 2015 D-Link

Create New Record

Host Name:

IPv6 Address:

Management Time & Schedule Time

The Time page allows you to configure, update, and maintain the correct time on the internal system clock. From here you can set the time zone, the Network Time Protocol (NTP) server, and enable or disable daylight saving time.

In the Management menu on the bar on the top of the page, click **Time & Schedule**.

Time Configuration

Time Zone: Select your time zone from the drop-down menu.

Time: Displays the current date and time of the router.

Daylight Saving: Enable or disable daylight saving time.

Automatic Time Configuration

Update Time Using an NTP Server: Enable or disable to allow an NTP server on the Internet to synchronize the time and date with your router. If you enable this option, select an NTP server from the drop-down menu. To configure the router's time and date manually, disable this option and use the drop-down menus that appear to input the time and date.

Click **Save** when you are done.

To configure and manage your schedules, click **Schedule** and refer to **Schedule** on page **90**.

D-Link
DIR-879 HW A1 FW:1.03

Home | Settings | Features | Management

Time

Your router's internal clock is used for data logging and schedules for features. The date and time can be synchronized with a public time server on the Internet, or set manually.

Management >> System Time Schedule Save

Time Configuration

Time Zone: (GMT-05:00) Eastern Time (US & Canada) ▼

Time: 2015/12/21 01:48:22 AM

Enable Daylight Saving: Disabled

Automatic Time Configuration

Update Time Using an NTP Server: Enabled

NTP Server: D-Link NTP Server ▼

Automatic Time Configuration

Update Time Using an NTP Server: Disabled

Manual Time Configuration

Date: 2016 ▼ 02 ▼ 03 ▼ (Year/ Month/ Day)

Time: 11 ▼ 44 ▼ (Hour/ Minute)

Schedule

Some configuration rules can be set according to a pre-configured schedule. To create, edit, or delete schedules, from the Time page click **Schedule**. To return to the Time page, click **Time**.

If you wish to remove a rule, click on its trash can icon in the Delete column. If you wish to edit a rule, click on its pencil icon in the Edit column. If you wish to create a new rule, click the **Add Rules** button. Click **Save** when you are done. If you edit or create a rule, the following screen will appear:

First, enter the name of your schedule in the **Name** field.

Each box represents one hour, with the time at the top of each column. To add a time period to the schedule, simply click on the start hour and drag to the end hour. You can add multiple days to the schedule, but only one period per day.

To remove a time period from the schedule, click on the cross icon.

Click **Save** when you are done.

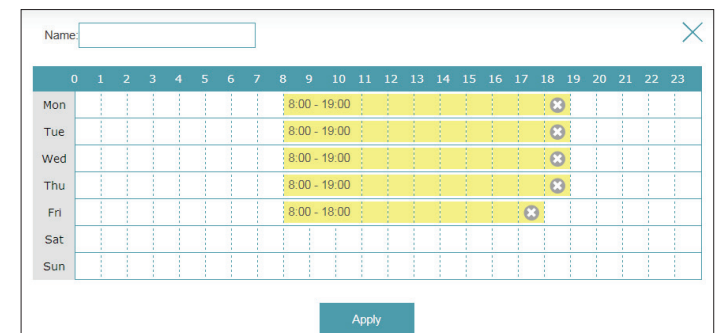
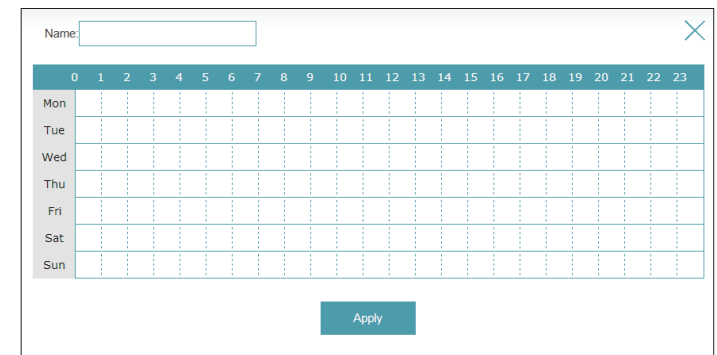
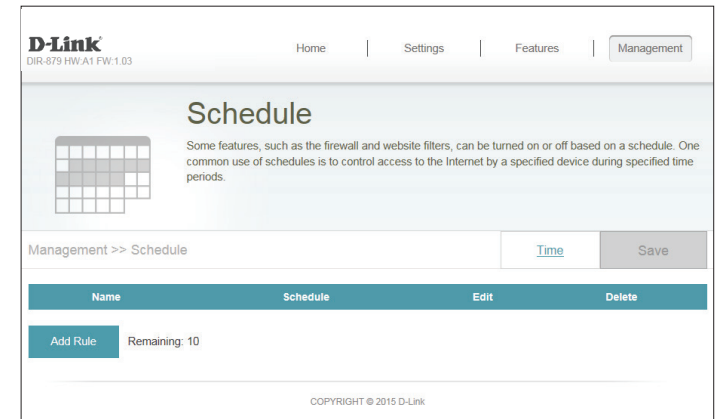

System Log

The router keeps a running log of events. This log can be sent to a Syslog server, and sent to your email address. In the Management menu on the bar on the top of the page, click **System Log**.

SysLog Settings

Enable Logging to Syslog Server: Check this box to send the router logs to a SysLog Server.

If Logging to the Syslog Server is **Enabled**:

Syslog Server IP Address: Enter the IP address for the Syslog server. If the Syslog server is connected to the extender, select it from the drop-down menu to automatically populate the field.

Email Settings

Enable Email Notification: If you want the logs to be automatically sent to an email address, enable this option.

If Email notification is **Enabled**:

From E-mail Address: Enter the email address your SysLog messages will be sent from.

To E-mail Address: Enter the email address your SysLog messages will be sent to.

SMTP Server Address: Enter your SMTP server address.

SMTP Server Port: Enter your SMTP server port.

Enable Authentication: Check this box if your SMTP server requires authentication.

D-Link
DIR-879 HW: A1 FW: 1.03

Home | Settings | Features | Management

System Log

On-board diagnostics run continually in the background to monitor the health of your router. The results are recorded in the system log if it is enabled. This info can be used to diagnose common problems or help Customer Support resolve issues more quickly.

Management >> System Log Save

SysLog Settings

Enable Logging to Syslog Server: Disabled

SysLog Settings

Enable Logging to Syslog Server: Enabled

SysLog Server IP Address: << Computer Name

E-mail Settings

Enable E-mail Notification: Disabled

E-mail Settings

Enable E-mail Notification: Enabled

From E-mail Address:

To E-mail Address:

SMTP Server Address:

SMTP Server Port: 25

Enable Authentication: Enabled

Account Name:

Password:

E-mail Log When Full or On Schedule

Send When Log Full: Enabled

Send on Schedule: Enabled

Schedule: Always Enable

System Log (continued)

Account Name: Enter your SMTP account name.

Password: Enter your SMTP account name's password.

E-mail Log When Full or On Schedule

Send On Schedule: If email notification is enabled, this option will set the router to send the log by email when the log is full.

Schedule: This option can be enabled to send an email according to a preconfigured schedule. See below.

If you enable **On Schedule** is enabled, use the drop-down menu to select the time schedule that the rule will be enabled on. The schedule may be set to **Always Enable**, or you can create your own schedules in the **Schedules** section. Refer to **Schedule** on page **90** for more information.

Click **Save** when you are done.

The screenshot shows two sections of a configuration page. The top section, titled "E-mail Settings", contains the following fields and controls: "Enable E-mail Notification" (checkbox, checked), "From E-mail Address:" (text input), "To E-mail Address:" (text input), "SMTP Server Address:" (text input), "SMTP Server Port:" (text input, value: 25), "Enable Authentication:" (checkbox, checked), "Account Name:" (text input), and "Password:" (text input). The bottom section, titled "E-mail Log When Full or On Schedule", contains: "Send When Log Full:" (checkbox, checked), "Send on Schedule:" (checkbox, checked), and "Schedule:" (dropdown menu, value: Always Enable).

Admin

This page will allow you to change the administrator (Admin) password and enable remote management. In the Management menu on the bar on the top of the page, click **Admin**. To load, save, reset settings, or reboot the router, click **System** and refer to **Schedule** on page **90**.

Admin Password

Password: Enter a new password for the administrator account. You will need to enter this password whenever you configure the router using a web browser.

Enable Graphical Authentication (CAPTCHA): Enables a challenge-response test to require users to type letters or numbers from a distorted image displayed on the screen to prevent online hackers and unauthorized users from gaining access to your router's network settings.

Advanced Settings - Administration

Enable HTTPS Server: Check to enable HTTPS to connect to the router securely. Instead of using **http://dlinkrouter.local./**, you must use **https://dlinkrouter.local./** in order to connect to the router.

Enable Remote Management: Remote management allows the DIR-879 to be configured from the Internet by a web browser. A password is still required to access the web management interface.

Remote Admin Port: The port number used to access the DIR-879 is used in the URL. Example: **http://x.x.x.x:8080** where x.x.x.x is the Internet IP address of the DIR-879 and 8080 is the port used for the web management interface.
Note: If you enabled **HTTPS Server** and wish to access the router remotely and securely, you must enter **https://** at the beginning of the address.

Click **Save** when you are done.

The screenshot shows the D-Link DIR-879 Admin web interface. At the top, there is a navigation bar with 'Home', 'Settings', 'Features', and 'Management' tabs. The 'Management' tab is active, and the 'Admin' page is displayed. The page title is 'Admin' and it includes a key icon and a warning: 'The admin account can change all router settings. To keep your router secure, you should give the admin account a strong password.' Below this, there are two main sections: 'Admin Password' and 'Administration'. In the 'Admin Password' section, there is a 'Password' input field with masked characters, an 'Enable Graphical Authentication (CAPTCHA)' checkbox that is checked, and an 'Advanced Settings...' link. In the 'Administration' section, there are three checkboxes: 'Enable HTTPS Server' (checked), 'Enable Remote Management' (checked), and 'Use HTTPS' (checked). There is also a 'Remote Admin Port' input field with the value '8081'. At the bottom of the page, there is a 'COPYRIGHT © 2015 D-Link' notice.

System

This page allows you to save the router's current configuration, load a previously saved configuration, reset the router to its factory default settings, or reboot the router.

From the Admin page, click **System**. To return to the Admin page, click **Admin**.

System

Save Settings To Local Hard Drive: This option will save the current router configuration settings to a file on your computer.

Load Settings From Local Hard Drive: This option will load a previously saved router configuration file. This will overwrite the router's current configuration.

Restore To Factory Default Settings: This option will restore all configuration settings back to the settings that were in effect at the time the router was shipped from the factory. Any settings that have not been saved will be lost, including any rules that you have created. If you want to save the current router configuration settings, use the **Save Settings To Local Hard Drive** button above.

Auto Reboot Configuration

Reboot The Device: Click to reboot the router immediately.

Auto Reboot: You may set the DIR-879 to automatically reboot at a set time. The options are **Never**, **Daily**, **Weekly**. You may set the hour using a 24 hour format, the minute, and the day you wish to have the DIR-879 automatically reboot.

Click **Save** when you are done.

The screenshot shows the D-Link System configuration page. At the top, there is a navigation bar with 'Home', 'Settings', 'Features', and 'Management'. The main heading is 'System'. Below the heading, there is a gear icon and a paragraph of text: 'This page lets you save your router's current settings to a file, restore your settings from a file, restore your router to factory default settings, or reboot the device. Please note that restoring the settings to the factory defaults will erase all settings, including any rules you have created.' Below this, there is a breadcrumb 'Management >> System' and an 'Admin' link. The main content area is titled 'System' and contains four buttons: 'Save' (Save Settings To Local Hard Drive), 'Select File' (Load Settings From Local Hard Drive), 'Restore' (Restore To Factory Default Settings), and 'Reboot' (Reboot The Device).

The screenshot shows the 'Auto Reboot Configuration' section. It has a 'Reboot The Device:' button labeled 'Reboot'. Below it, the 'Auto Reboot:' dropdown menu is set to 'Never'.

The screenshot shows the 'Auto Reboot Configuration' section. It has a 'Reboot The Device:' button labeled 'Reboot'. Below it, the 'Auto Reboot:' dropdown menu is set to 'Daily'. The 'Time:' field is set to '00' for both hours and minutes, with '(Hour/ Minute)' text to the right.

The screenshot shows the 'Auto Reboot Configuration' section. It has a 'Reboot The Device:' button labeled 'Reboot'. Below it, the 'Auto Reboot:' dropdown menu is set to 'Weekly', the 'Day of Week:' dropdown menu is set to 'Mon', and the 'Time:' field is set to '00' for both hours and minutes, with '(Hour/ Minute)' text to the right.

Upgrade

This page will allow you to upgrade the router's firmware or language pack, either automatically or manually. To manually upgrade the firmware or language pack, you must first download the relevant file from <http://support.dlink.com>.

In the Management menu on the bar on the top of the page, click **Upgrade**.

Firmware

Firmware Information: The current firmware's version and date will be displayed.

Check for New Firmware: Click this button to prompt the router to automatically check for a new firmware version. If a newer version is found, it will prompt you to install it.

Upgrade Manually

Upgrade Firmware: If you wish to upgrade manually, first download the firmware file you wish to upgrade to. Next, click the **Upgrade Firmware** button and browse to the file to install the new firmware. You can also browse to a language pack file to install a new language pack.

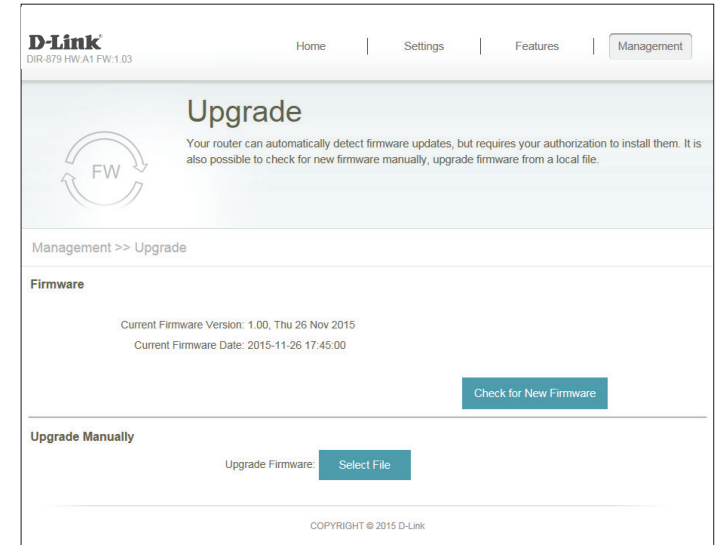

Statistics

On the Statistics page you can view the amount of packets that pass through the router on the WAN, LAN, and wireless segments.

In the Management menu on the bar on the top of the page, click **Statistics**.

You can view the **Internet**, **LAN**, **Wi-Fi 2.4 GHz**, or **Wi-Fi 5 GHz** by clicking on the respective tabs at the top. The graph will update in real time. To clear the information on the graph, click **Clear**.

The traffic counter will reset if the device is rebooted.

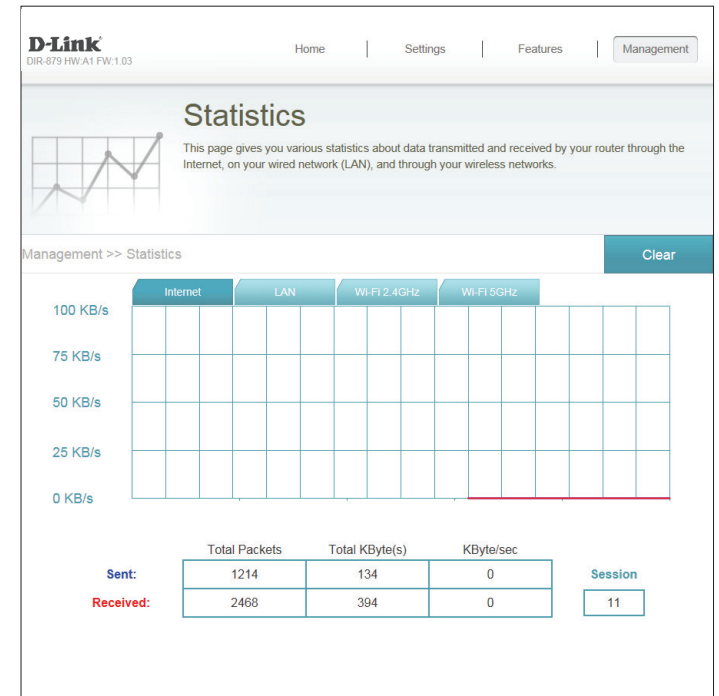

Configuration - Extender Mode Settings

To access the configuration utility, open a web-browser such as Internet Explorer and enter **http://dlinkrouter.local/** or you may also connect by typing the IP address* of the DIR-879 in the address bar.

* By default the DIR-879 in extender mode will use DHCP to obtain an IP address from your uplink network. If you are using multiple DIR-879s or D-Link devices, go to **http://dlinkrouterxxxx.local/** as shown on the included Wi-Fi Configuration Card, with "xxxx" being the last four digits of the DIR-879's MAC address. The MAC address is also printed on the label on the bottom of the device.

Enter your password. If you previously followed the setup wizard, please use the admin password you entered during the wizard. Otherwise, leave the password blank. Click **Log In** to proceed.

Note: *If you cannot remember your password and cannot log in, press the reset/wps button on the back of the device for longer than 10 seconds to restore the router to its default settings.*

If the mode switch is set to **Extender** these are the pages you will see.

The Extender's Home Page will open, giving you quick access to the DIR-879's current status. The bar at the top of the page has quick access to the Home, Settings, and Management functions.

Note: *The system will automatically log out after a period of inactivity.*

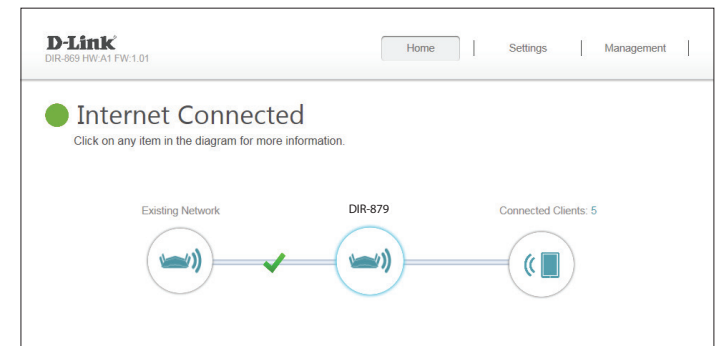
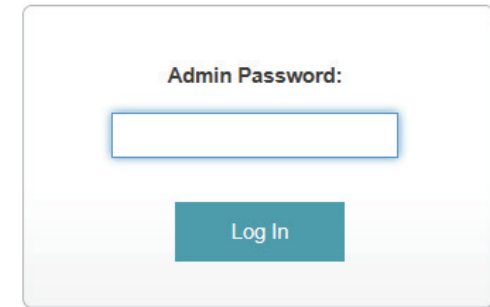

Home

The Home page displays the current status of the extender in the form of an interactive diagram. You can click each icon to display information about each part of the network at the bottom of the screen. The menu bar at the top of the page will allow you to quickly navigate to other pages.

The Home page displays whether or not the extender is currently connected to the Internet. If it is disconnected, click the red X between the existing network and the DIR-879 to bring up the setup wizard, refer to **Setup Wizard** on page **24** for more information.

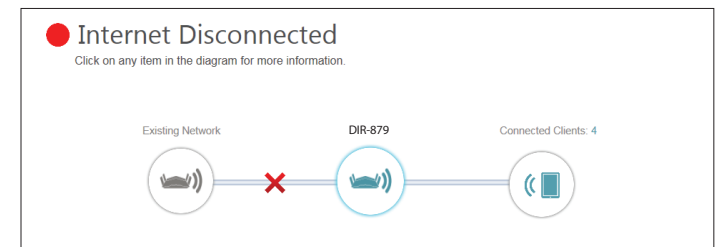
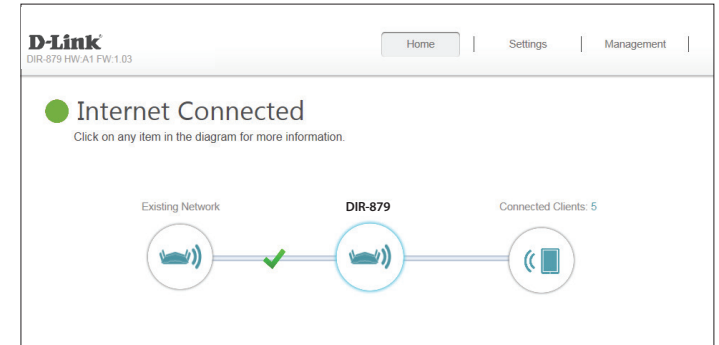

DIR-879

To bring up more details about the connection to your existing network, click on the **DIR-879** icon. Your **Network** and **Wireless Network** settings are displayed at the bottom of the page.

Your Extender's MAC address, IPv4 address, and subnet mask are displayed. To reconfigure the Network settings, refer to **Network** on page **104**.

Your wireless network statuses, names, and passwords for both the 2.4 GHz and 5 GHz networks are shown. To reconfigure the Extender network settings click **Go to settings** and refer to **Extender** on page **101**.

The screenshot displays the D-Link DIR-879 web interface. At the top, there is a navigation bar with 'Home', 'Settings', and 'Management' tabs. Below the navigation bar, a green circle indicates 'Internet Connected' with a subtext 'Click on any item in the diagram for more information.' A diagram shows the network topology: 'Existing Network' (represented by a Wi-Fi icon) is connected to 'DIR-879' (represented by a Wi-Fi icon with a green checkmark), which is then connected to 'Connected Clients: 5' (represented by a smartphone icon). Below the diagram, the 'DIR-879' section is divided into two columns. The left column, titled 'IPv4 Network', lists: 'MAC Address: EC:15:21:36:41:4F', 'Router IP Address: 192.168.150.23', and 'Subnet Mask: 255.255.255.0'. A 'Go to settings' link with a right-pointing arrow is located below these details. The right column, titled 'Wi-Fi 2.4GHz', lists: 'Status: Enabled', 'Wi-Fi Name (SSID): dlink-445C', and 'Password: jpwcz95721'. Below this, the 'Wi-Fi 5GHz' section lists: 'Status: Enabled', 'Wi-Fi Name (SSID): dlink-445C-5GHz', and 'Password: jpwcz95721'. A 'Go to settings' link with a right-pointing arrow is located at the bottom right of this section.

Connected Clients

Click on the **Connected Clients** icon to view details about the extender and its wireless settings.

On this page you can see all the clients currently connected to the extender, and their IP addresses.

To edit each client's settings, click the pencil icon on the client you want to edit.

D-Link
DIR-879 HW: A1 FW: 1.03

Home | Settings | Management

Internet Connected
Click on any item in the diagram for more information.

Existing Network — **DIR-879** — Connected Clients: 5

Connected Clients

You can block a device from accessing your network completely.

08203PCWIN7 Universal Global Sc. 192.168.150.50	Unknown Unknown Vendor 192.168.150.1	Unknown Unknown Vendor 192.168.150.155
Unknown D-Link 192.168.150.29	08203PCWIN7 Unknown Vendor 192.168.150.115	

Name: Enter a custom name for this client.

Vendor: Displays the vendor of the device.

MAC Address: Displays the MAC address of the device.

IP Address: Displays the IP address of the device.

Click **Save** when you are done.

Edit Rule ✕

Name:

Vendor: Unknown Vendor

MAC Address: 3c:1e:04:f3:b6:49

IP Address: 192.168.150.115

Save

Extender

From this page you may view and modify the current Extender Mode settings. **Existing Network** displays either the current settings, which were configured using WPS or Setup Wizard, or the factory defaults. You may also configure the Extended Wireless Network settings from this page.

Existing Network

Existing Network: You may select whether to connect to an uplink network using **Wi-Fi** (Wireless Extender) or **Ethernet** (Access Point).

If **Wi-Fi** is selected, the following options are available:

Wi-Fi Name (SSID): The name of the wireless network currently being extended.

Security: The type of security used by the uplink wireless network.

Password: The currently configured password for the uplink network.

To select a different Wi-Fi network to extend use the **Scan** button or configure manually:

Scan: Press this button to perform a survey of wireless networks in range. Choose a network you wish to extend from the list and then press the **Select** button. Press the **X** to cancel.

Wi-Fi Name (SSID): The name of the selected from the scan. You may also manually input the name of the network you wish to extend.

Security: The type of security of the selected network. If you are manually configuring the connection, select the type of network security, either **None** or **WPA/WPA2-(Personal)**.

Password: Enter the wireless password of the uplink network.

The screenshot shows the D-Link Extender configuration page. At the top, there are navigation links for Home, Settings, and Management. The main heading is 'Extender' with a sub-heading: 'Use this section to configure the wireless settings for your D-Link Router. Please ensure you press Save after any changes made in this section it to take effect.' Below this, there is a 'Settings >> Extender' breadcrumb and a 'Save' button. The 'Existing Network' section has a dropdown menu set to 'Ethernet', with input fields for 'Wi-Fi Name (SSID)', 'Security', and 'Password'.

This screenshot shows the 'Existing Network' section with 'Wi-Fi' selected in the dropdown menu. The 'Wi-Fi Name (SSID)' field contains 'A_TopOfTheList', and there is a 'Scan' button next to it. The 'Security' dropdown is set to 'WPA/WPA2-Personal', and the 'Password' field contains 'password'.

The 'Available hotspot networks' dialog box displays a list of detected networks. Each entry includes the network name, a lock icon, a Wi-Fi signal icon, and the security type. The networks listed are: A_TopOfTheList (WPAORWPA2-PSK), Zzzzzzzzz2 (WPAORWPA2-PSK), dlink-878C (WPAORWPA2-PSK), hetalia-ext (WPAORWPA2-PSK), and hetalia (WPAORWPA2-PSK). A 'Select' button is at the bottom.

Network Name	Security
A_TopOfTheList	WPAORWPA2-PSK
Zzzzzzzzz2	WPAORWPA2-PSK
dlink-878C	WPAORWPA2-PSK
hetalia-ext	WPAORWPA2-PSK
hetalia	WPAORWPA2-PSK

Extender (continued)

Smart Connect

Smart Connect: Enable or disable the Smart Connect Feature. When enabled only a few configuration options are available to simplify configuration.

Wi-Fi Name (SSID): Create a name for your wireless network using up to 32 characters.

Security Mode: Choose **None** or **WPA/WPA2-(Personal)** (recommended).

Password: Create a password to use for wireless security. Wireless clients will need to enter this password to successfully connect to the network.

If Existing Network Type is **Wi-Fi** and Smart Connect is **Disabled** the following options are available:

2.4GHz / 5GHz Extended Wi-Fi

Status: Enable or disable the 2.4 GHz / 5 GHz wireless network.

Wi-Fi Name (SSID): Create a name for your wireless network using up to 32 characters.

Security Mode: Choose **None** or **WPA/WPA2-(Personal)** (recommended).

Password: Create a password to use for wireless security.

Smart Connect

Status: Enabled

Wi-Fi Name (SSID):

Security:

Password:

Smart Connect

Smart Connect: Disabled

Existing Network

Existing Network:

Wi-Fi Name (SSID):

Security:

Password:

2.4GHz Extended Wi-Fi

Status: Enabled

Wi-Fi Name (SSID):

Security:

Password:

5GHz Extended Wi-Fi

Status: Enabled

Wi-Fi Name (SSID):

Security:

Password:

Extender (continued)

If Existing Network Type is **Ethernet** and Smart Connect is **Disabled** the following additional options are available. For **Wi-Fi** these parameters are set by the uplink wireless network.

802.11 Mode (2.4 GHz): Select the desired wireless networking standards to use. The available options for the 2.4 GHz wireless network are **Mixed 802.11b/g/n, Mixed 802.11g/n, 802.11n only**.

802.11 Mode (5 GHz): Select the desired wireless networking standards to use. The available options for the 5 GHz wireless network are **Mixed 802.11a/n/ac, Mixed 802.11n/ac, 802.11ac only, Mixed 802.11a/n, Mixed 802.11n only, or 802.11a only**.

Wi-Fi Channel: Select the desired channel. The default is **Auto** (recommended).

Channel Width (2.4 GHz): Select **Auto 20/40** if you are using both 802.11n and non-802.11n devices, or select **20 MHz** if you are not using any 802.11n devices.

Channel Width (5 GHz): Select **Auto 20/40/80** if you are using 802.11ac, 802.11n, and 802.11a devices, select **Auto 20/40** if you are using 802.11n and 802.11a devices, or select **20 MHz** if you are only using 802.11a devices.

HT20/40 Coexistence: Enable or disable HT20/40 Coexistence. (2.4 GHz):

Click **Save** when you are done.

Smart Connect

Smart Connect: Disabled

Existing Network

Existing Network:

Wi-Fi Name (SSID):

Security:

Password:

2.4GHz Extended Wi-Fi

Status: Enabled

Wi-Fi Name (SSID):

Security:

Password:

802.11 Mode:

Wi-Fi Channel:

Channel Width:

HT20/40 coexistence: Enabled

5GHz Extended Wi-Fi

Status: Enabled

Wi-Fi Name (SSID):

Security:

Password:

802.11 Mode:

Wi-Fi Channel:

Channel Width:

Network

This section will allow you to change the local network settings of the extender and to configure the device's connection to the uplink network. In the Settings menu on the bar on the top of the page, click **Network**. Click **Advanced Settings...** to expand the list and see all of the options.

Network Settings

Management Link: The default address to access the extender's configuration is **http://dlinkrouter.local/**. Here, you can replace **dlinkrouter** with a name of your choice.

Advanced Settings - IPv4 Device Management Interface

My LAN Connection Is: Choose the IPv4 provisioning mechanism used by the extender. Select either **Dynamic IP (DHCP)** or **Static IP**. The Default is Dynamic IP.

If you change the connection type to **Static IP**, configure the following options:

IP Address: Enter the IP address of the extender. If you change the IP address, once you click **Save**, you will need to enter the new IP address in your browser to get back into the configuration utility

Subnet Mask: Enter the subnet mask of the extender. The default subnet mask is **255.255.255.0**.

Gateway Address: Enter the IP address of the device the Extender connects to.

Primary DNS Server: Enter the primary DNS server IP address assigned by your ISP. If you do not know it, enter the Gateway Address.

Secondary DNS Server: Enter the secondary DNS server IP address assigned by your ISP. If you do not know it, enter the Gateway Address.

Click **Save** when you are done.

D-Link
DIR-879 HW: A1 FW: 1.03

Home | Settings | Management

Network

Use this section to configure the network settings for your device. You can enter a name for your device in the management link field, and use the link to access web UI in a web browser. Recommend to change the management link if there are more than one D-Link devices within the network.

Settings >> Network Save

Network Settings

Management Link: http:// .local Advanced Settings.

IPv4 Device Management Interface
Choose a IPv4 provisioning mechanism to be used by the device.

My LAN Connection is: ▼

IP Address:

Subnet Mask:

Gateway Address:

Primary DNS Server:

Secondary DNS Server:

IPv4 Device Management Interface
Choose a IPv4 provisioning mechanism to be used by the device.

My LAN Connection is: ▼

IP Address:

Subnet Mask:

Gateway Address:

Primary DNS Server:

Secondary DNS Server:

Management Time & Schedule Time

The Time page allows you to configure, update, and maintain the correct time on the internal system clock. From here you can set the time zone, the Network Time Protocol (NTP) server, and enable or disable daylight saving time.

In the Management menu on the bar on the top of the page, click **Time & Schedule**.

Time Configuration

Time Zone: Select your time zone from the drop-down menu.

Time: Displays the current date and time of the router.

Daylight Saving: Enable or disable daylight saving time.

Automatic Time Configuration

Update Time Using an NTP Server: Enable or disable to allow an NTP server on the Internet to synchronize the time and date with your router. If you enable this option, select an NTP server from the drop-down menu. To configure the router's time and date manually, disable this option and use the drop-down menus that appear to input the time and date.

Click **Save** when you are done.

To configure and manage your schedules, click **Schedule** and refer to **Schedule** on page 106.

Schedule

Some configuration rules can be set according to a pre-configured schedule. To create, edit, or delete schedules, from the Time page click **Schedule**. To return to the Time page, click **Time**.

If you wish to remove a rule, click on its trash can icon in the Delete column. If you wish to edit a rule, click on its pencil icon in the Edit column. If you wish to create a new rule, click the **Add Rules** button. Click **Save** when you are done. If you edit or create a rule, the following screen will appear:

First, enter the name of your schedule in the **Name** field.

Each box represents one hour, with the time at the top of each column. To add a time period to the schedule, simply click on the start hour and drag to the end hour. You can add multiple days to the schedule, but only one period per day.

To remove a time period from the schedule, click on the cross icon.

Click **Save** when you are done.

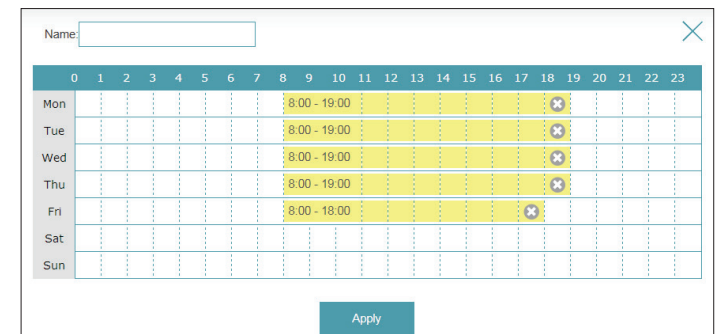
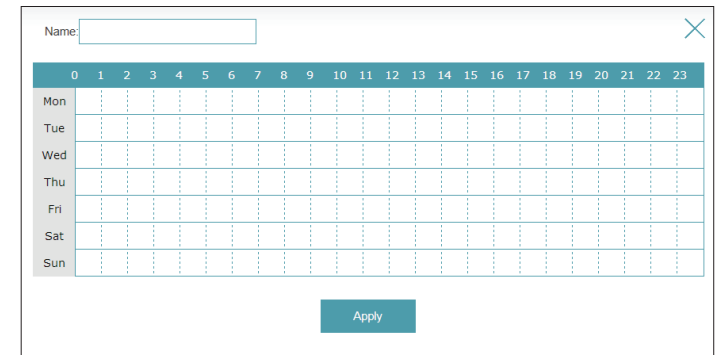
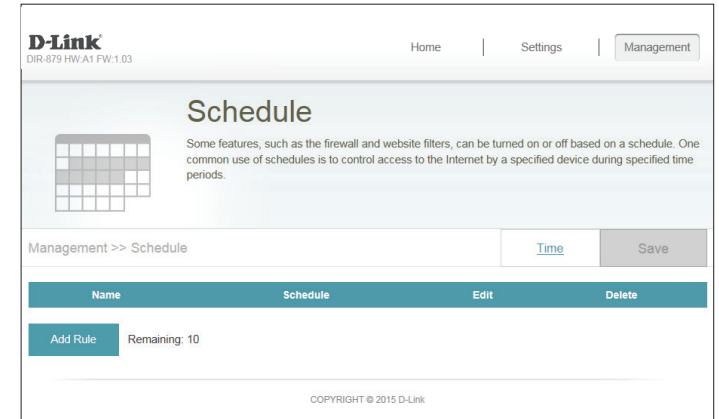

System Log

The router keeps a running log of events. This log can be sent to a Syslog server, and sent to your email address. In the Management menu on the bar on the top of the page, click **System Log**.

SysLog Settings

Enable Logging to Syslog Server: Check this box to send the router logs to a SysLog Server.

If Logging to the Syslog Server is **Enabled**:

Syslog Server IP Address: Enter the IP address for the Syslog server. If the Syslog server is connected to the extender, select it from the drop-down menu to automatically populate the field.

Email Settings

Enable Email Notification: If you want the logs to be automatically sent to an email address, enable this option.

If Email notification is **Enabled**:

From E-mail Address: Enter the email address your SysLog messages will be sent from.

To E-mail Address: Enter the email address your SysLog messages will be sent to.

SMTP Server Address: Enter your SMTP server address.

SMTP Server Port: Enter your SMTP server port.

Enable Authentication: Check this box if your SMTP server requires authentication.

System Log (continued)

Account Name: Enter your SMTP account name.

Password: Enter your SMTP account name's password.

E-mail Log When Full or On Schedule

Send On Schedule: If email notification is enabled, this option will set the router to send the log by email when the log is full.

Schedule: This option can be enabled to send an email according to a preconfigured schedule. See below.

If you enable **On Schedule** is enabled, use the drop-down menu to select the time schedule that the rule will be enabled on. The schedule may be set to **Always Enable**, or you can create your own schedules in the **Schedules** section. Refer to **Schedule** on page **106** for more information.

Click **Save** when you are done.

The screenshot shows two sections of a configuration page. The top section, titled "E-mail Settings", contains the following fields: "Enable E-mail Notification" (checkbox checked, labeled "Enabled"), "From E-mail Address:" (text input), "To E-mail Address:" (text input), "SMTP Server Address:" (text input), "SMTP Server Port:" (text input with "25" entered), "Enable Authentication:" (checkbox checked, labeled "Enabled"), "Account Name:" (text input), and "Password:" (text input). The bottom section, titled "E-mail Log When Full or On Schedule", contains: "Send When Log Full:" (checkbox checked, labeled "Enabled"), "Send on Schedule:" (checkbox checked, labeled "Enabled"), and "Schedule:" (dropdown menu with "Always Enable" selected).

Admin

This page will allow you to change the administrator (Admin) password and enable remote management. In the Management menu on the bar on the top of the page, click **Admin**. To load, save, reset settings, or reboot the router, click **System** and refer to **System** on page **110**.

Admin Password

Password: Enter a new password for the administrator account. You will need to enter this password whenever you configure the router using a web browser.

Enable Graphical Authentication (CAPTCHA): Enables a challenge-response test to require users to type letters or numbers from a distorted image displayed on the screen to prevent online hackers and unauthorized users from gaining access to your router's network settings.

Advanced Settings - Administration

Enable HTTPS Server: Check to enable HTTPS to connect to the router securely. Instead of using **http://dlinkrouter.local./**, you must use **https://dlinkrouter.local./** in order to connect to the router.

Click **Save** when you are done.

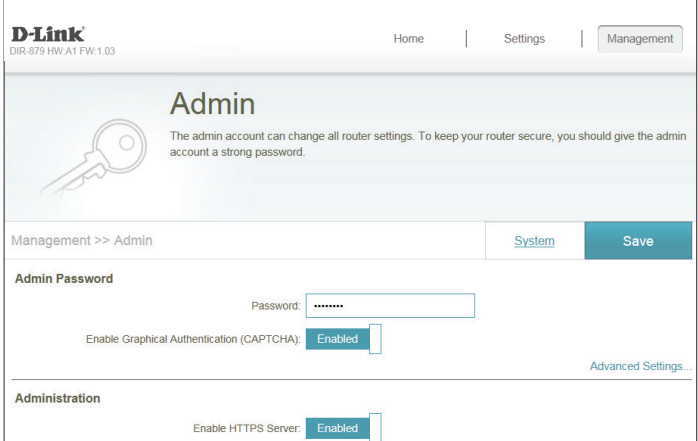

The screenshot shows the D-Link Admin interface. At the top, there is a navigation bar with 'Home', 'Settings', and 'Management' (selected). Below the navigation bar, the page title is 'Admin'. A key icon is displayed next to the title, and a message states: 'The admin account can change all router settings. To keep your router secure, you should give the admin account a strong password.' Below this, there is a breadcrumb trail 'Management >> Admin' and two buttons: 'System' and 'Save'. The main content area is divided into sections. The 'Admin Password' section contains a 'Password:' field with a masked password '.....', an 'Enable Graphical Authentication (CAPTCHA)' checkbox that is checked and labeled 'Enabled', and a link for 'Advanced Settings...'. The 'Administration' section contains an 'Enable HTTPS Server' checkbox that is checked and labeled 'Enabled'.

System

This page allows you to save the router's current configuration, load a previously saved configuration, reset the router to its factory default settings, or reboot the router.

From the Admin page, click **System**. To return to the Admin page, click **Admin**.

System

Save Settings To Local Hard Drive: This option will save the current router configuration settings to a file on your computer.

Load Settings From Local Hard Drive: This option will load a previously saved router configuration file. This will overwrite the router's current configuration.

Restore To Factory Default Settings: This option will restore all configuration settings back to the settings that were in effect at the time the router was shipped from the factory. Any settings that have not been saved will be lost, including any rules that you have created. If you want to save the current router configuration settings, use the **Save Settings To Local Hard Drive** button above.

Auto Reboot Configuration

Reboot The Device: Click to reboot the router immediately.

Auto Reboot: You may set the DIR-879 to automatically reboot at a set time. The options are **Never**, **Daily**, **Weekly**. You may set the hour using a 24 hour format, the minute, and the day you wish to have the DIR-879 automatically reboot.

Click **Save** when you are done.

Upgrade

This page will allow you to upgrade the router's firmware or language pack, either automatically or manually. To manually upgrade the firmware or language pack, you must first download the relevant file from <http://support.dlink.com>.

In the Management menu on the bar on the top of the page, click **Upgrade**.

Firmware

Firmware Information: The current firmware's version and date will be displayed.

Check for New Firmware: Click this button to prompt the router to automatically check for a new firmware version. If a newer version is found, it will prompt you to install it.

Upgrade Manually

Upgrade Firmware: If you wish to upgrade manually, first download the firmware file you wish to upgrade to. Next, click the **Upgrade Firmware** button and browse to the file to install the new firmware. You can also browse to a language pack file to install a new language pack.

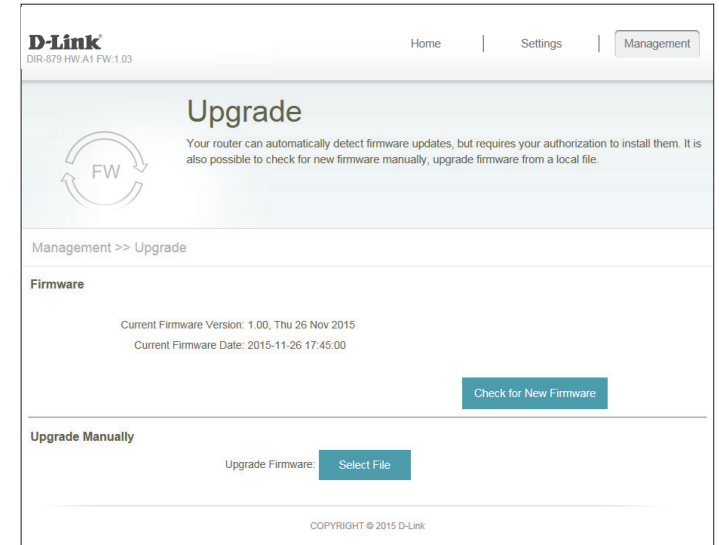

Connect a Wireless Client to your Router

WPS Button

The easiest and most secure way to connect your wireless devices to the router is with WPS (Wi-Fi Protected Setup). Most wireless devices such as wireless adapters, media players, Blu-ray DVD players, wireless printers and cameras will have a WPS button (or a software utility with WPS) that you can press to connect to the DIR-879 router. Please refer to your user manual for the wireless device you want to connect to make sure you understand how to enable WPS. Once you know, follow the steps below:

Step 1 - Press the WPS button on the DIR-879 for about 1 second. The LED on the front will start to blink.



Step 2 - Within 2 minutes, press the WPS button on your wireless device (or launch the software utility and start the WPS process).

Step 3 - Allow up to 1 minute for your connection to be configured. Once the Internet light stops blinking, you will be connected and your wireless connection will be secure with WPA2.

Windows® 10

When connecting to the DIR-879 wirelessly for the first time, you will need to input the wireless network name (SSID) and Wi-Fi password (security key) of the device you are connecting to. If your product has a Wi-Fi configuration card, you can find the default network name and Wi-Fi password here. Otherwise refer to the product label for the default Wi-Fi network SSID and password, or enter the Wi-Fi credentials set during the product configuration.

To join an existing network, locate the wireless network icon in the taskbar, next to the time display and click on it.

Clicking on this icon will display a list of wireless networks which are within range of your computer. Select the desired network by clicking on the SSID.



Wireless Icon

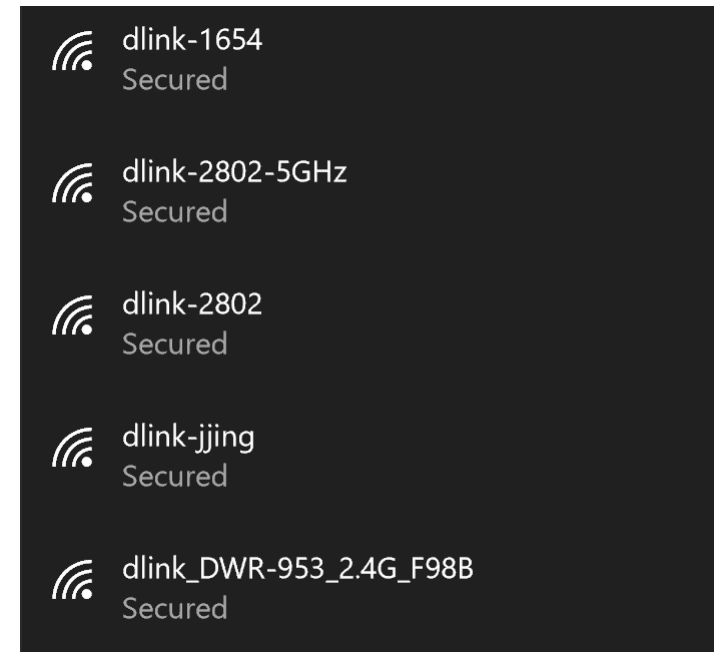

To connect to the SSID, click **Connect**.

To automatically connect with the router when your device next detects the SSID, click the **Connect Automatically** check box.

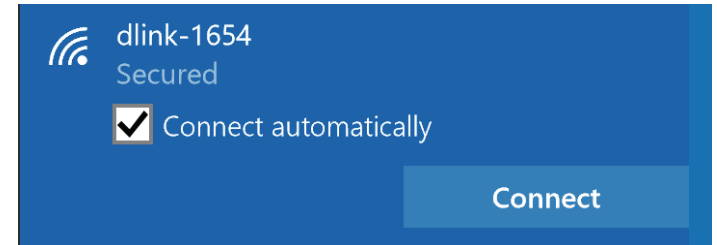

You will then be prompted to enter the Wi-Fi password (network security key) for the wireless network. Enter the password into the box and click **Next** to connect to the network. Your computer will now automatically connect to this wireless network when it is detected.

You can also use Wi-Fi Protected Setup (WPS) to connect to the router. Press the WPS button on your D-Link device and you will be automatically connected.

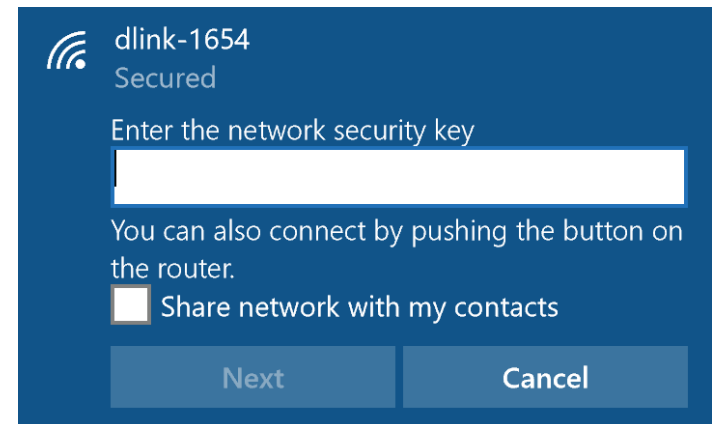

Windows® 8

WPA/WPA2

It is recommended that you enable wireless security (WPA/WPA2) on your wireless router or access point before configuring your wireless adapter. If you are joining an existing network, you will need to know the security key (Wi-Fi password) being used.

To join an existing network, locate the wireless network icon in the taskbar next to the time display.



Clicking on this icon will display a list of wireless networks that are within connecting proximity of your computer. Select the desired network by clicking on the network name.

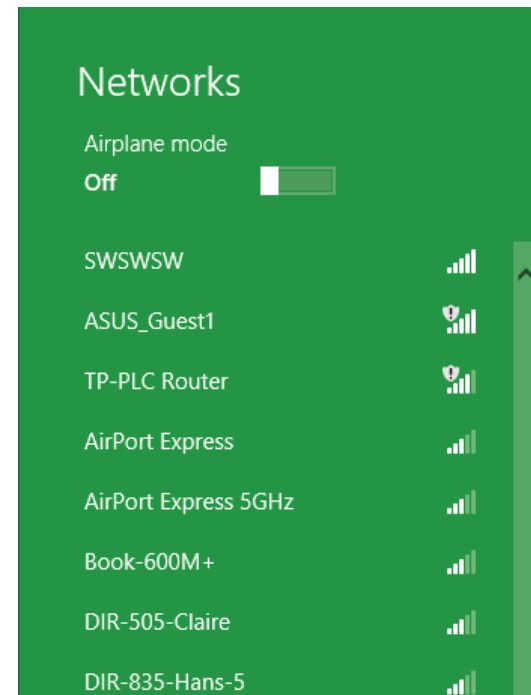

You will then be prompted to enter the network security key (Wi-Fi password) for the wireless network. Enter the password into the box and click **Next**.

If you wish to use Wi-Fi Protected Setup (WPS) to connect to the router, you can also press the WPS button on your router during this step to enable the WPS function.

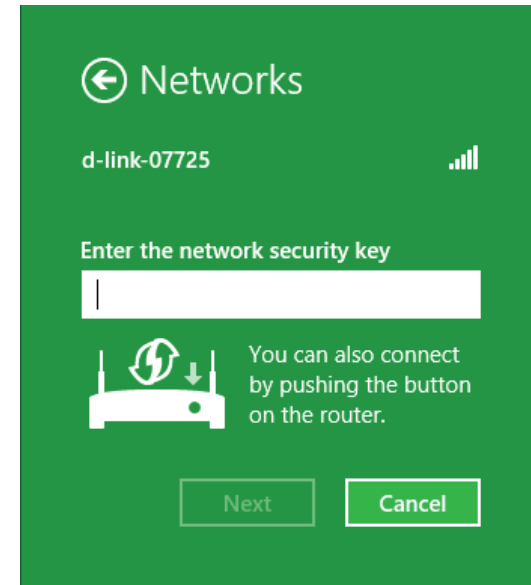

When you have established a successful connection to a wireless network, the word **Connected** will appear next to the name of the network to which you are connected to.

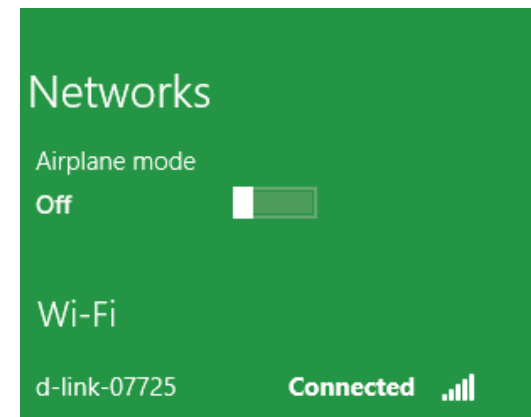

Windows® 7

WPA/WPA2

It is recommended that you enable wireless security (WPA/WPA2) on your wireless router or access point before configuring your wireless adapter. If you are joining an existing network, you will need to know the security key or passphrase being used.

1. Click on the wireless icon in your system tray (lower-right corner).

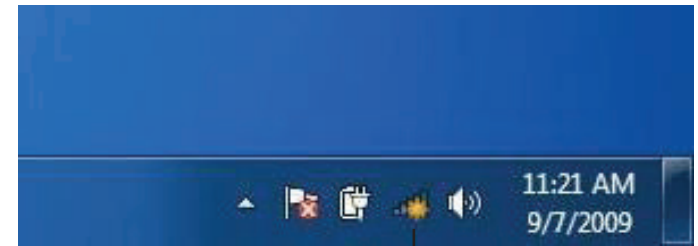

Wireless Icon

2. The utility will display any available wireless networks in your area.



3. Highlight the wireless connection with Wi-Fi name (SSID) you would like to connect to and click the **Connect** button.

If you get a good signal but cannot access the Internet, check your TCP/IP settings for your wireless adapter. Refer to the Networking Basics section in this manual for more information.



4. The following window appears while your computer tries to connect to the router.

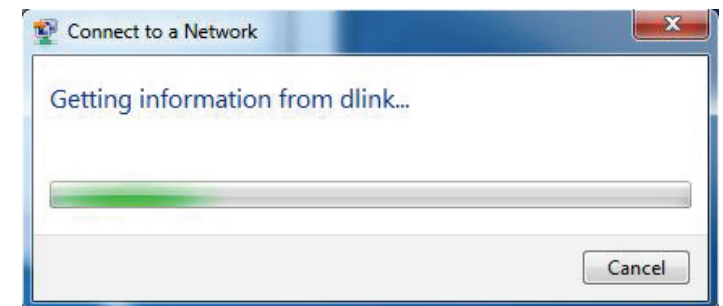

5. Enter the same security key or passphrase (Wi-Fi password) that is on your router and click **Connect**. You can also connect by pushing the WPS button on the router.

It may take 20-30 seconds to connect to the wireless network. If the connection fails, please verify that the security settings are correct. The key or passphrase must be exactly the same as the one on the wireless router.

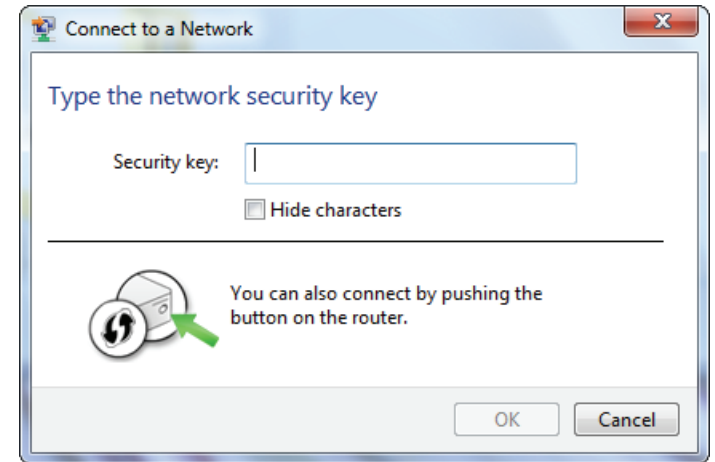

WPS

The WPS feature of the DIR-879 can be configured using Windows® 7. Carry out the following steps to use Windows® 7 to configure the WPS feature:

1. Click the **Start** button and select **Computer** from the Start menu.

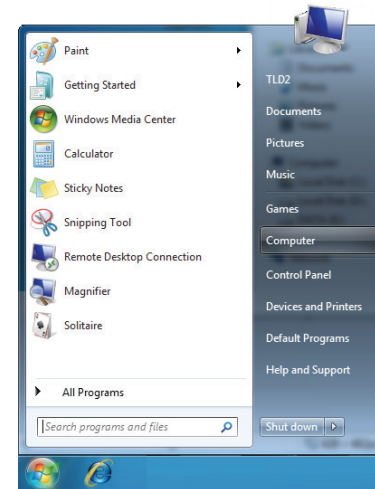

2. Click **Network** on the left side.

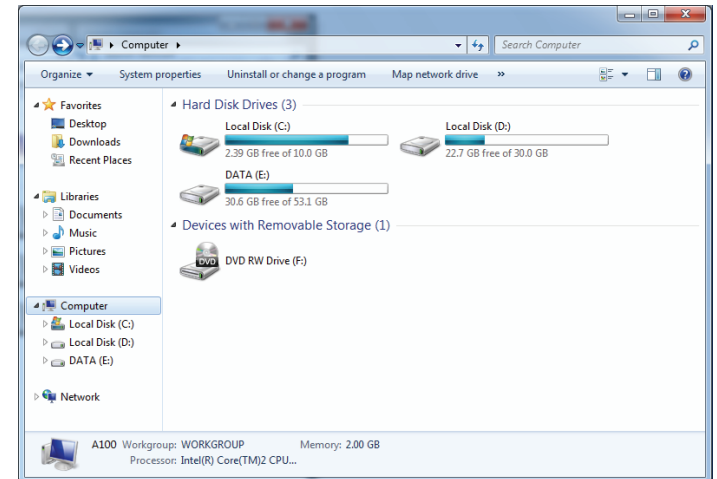

3. Double-click the DIR-879.

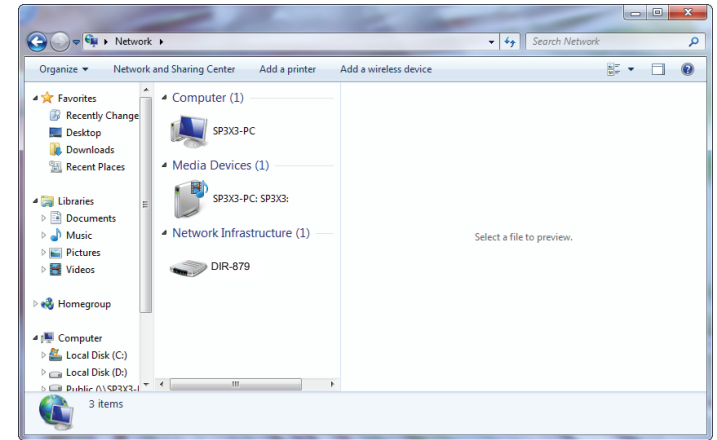

4. Input the WPS PIN number (on the router label) in the **Setup > Wireless Setup** menu in the Router's Web UI) and click **Next**.

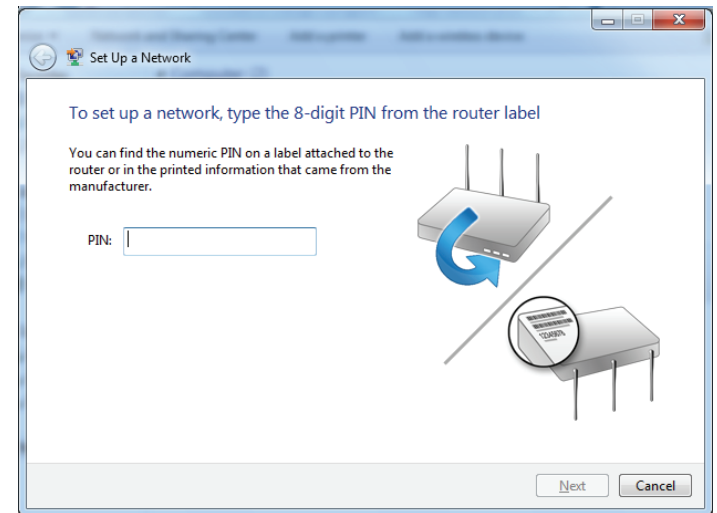

5. Type a name to identify the network.

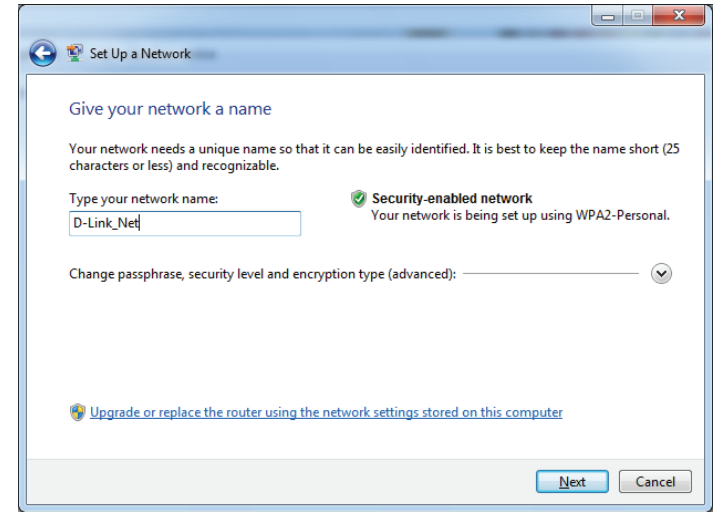

6. To configure advanced settings, click the  icon.

Click **Next** to continue.

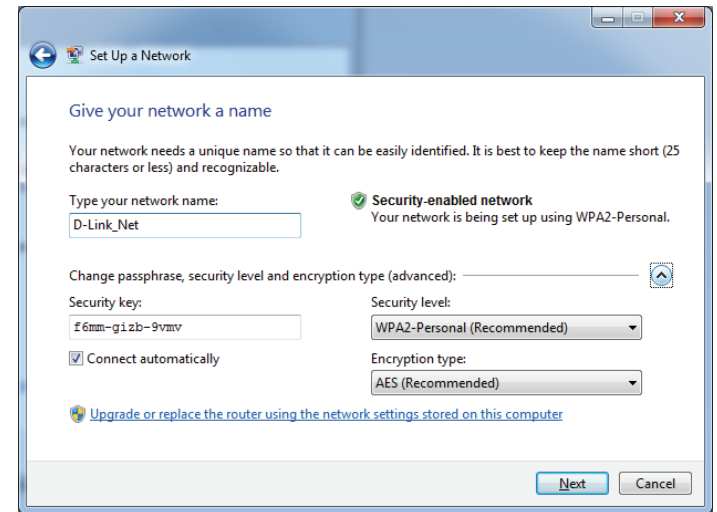

7. The following window appears while the DIR-879 is being configured.

Wait for the configuration to complete.

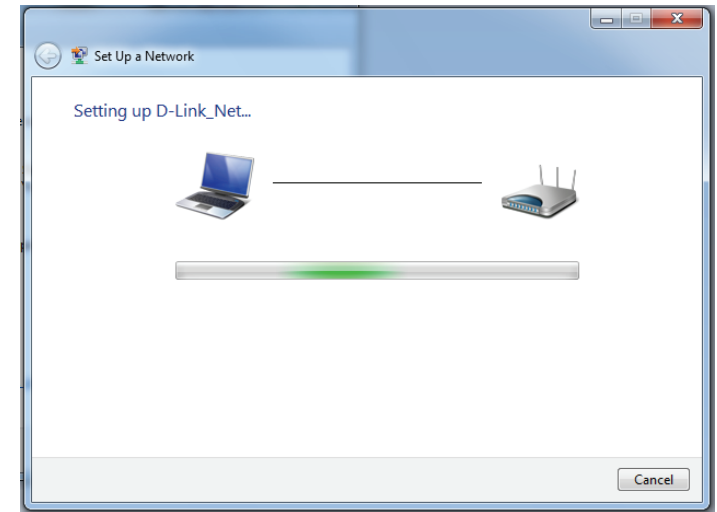

8. The following window informs you that WPS on the DIR-879 has been set up successfully.

Make a note of the security key as you may need to provide this security key if adding an older wireless device to the network in the future.

9. Click **Close** to complete WPS setup.

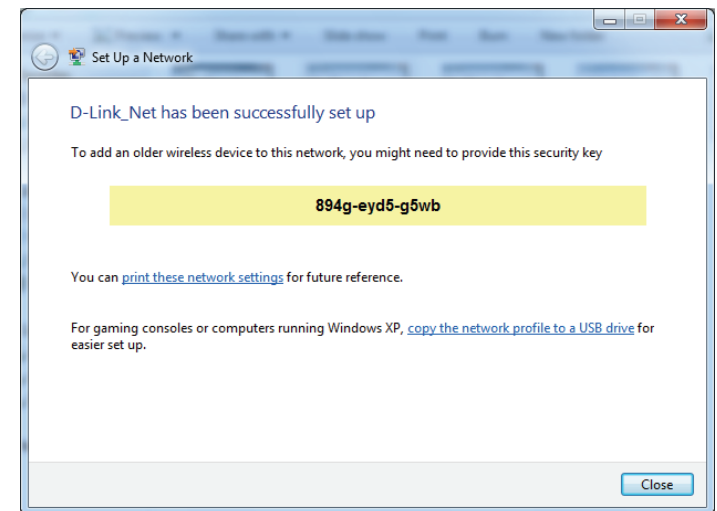

Windows Vista®

Windows Vista® users may use the built-in wireless utility. If you are using another company's wireless utility, please refer to the user manual of your wireless adapter for help connecting to a wireless network. Most wireless utilities will have a "site survey" option similar to the Windows Vista® utility as seen below.

If you receive the **Wireless Networks Detected** bubble, click on the center of the bubble to access the utility.

or

Right-click on the wireless computer icon in your system tray (lower-right corner next to the time). Select **Connect to a network**.

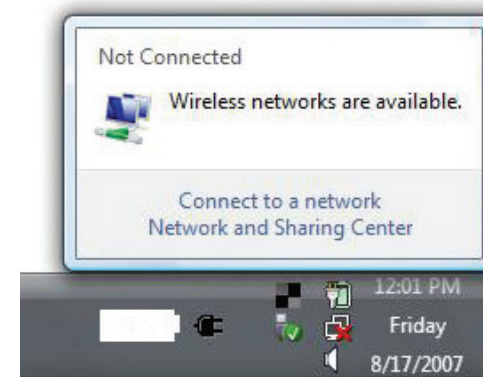

The utility will display any available wireless networks in your area. Click on a network (displayed using the SSID) and click the **Connect** button.

If you get a good signal but cannot access the Internet, check you TCP/IP settings for your wireless adapter. Refer to the **Networking Basics** section in this manual for more information.

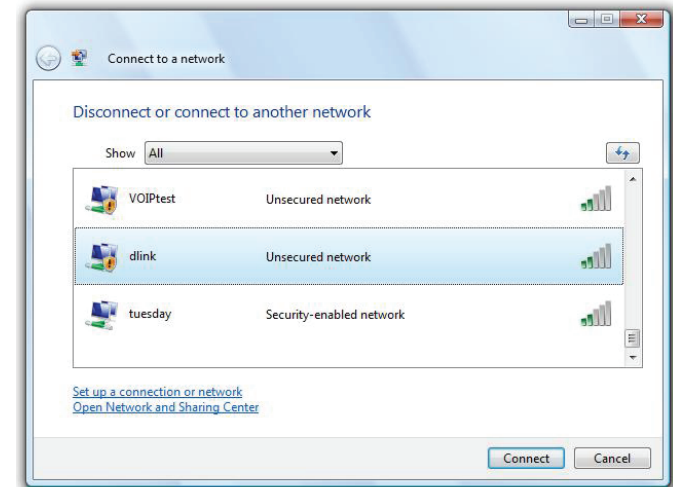

WPA/WPA2

It is recommended that you enable wireless security (WPA/WPA2) on your wireless router or access point before configuring your wireless adapter. If you are joining an existing network, you will need to know the security key or passphrase being used.

1. Open the Windows Vista® Wireless Utility by right-clicking on the wireless computer icon in your system tray (lower right corner of screen). Select **Connect to a network**.

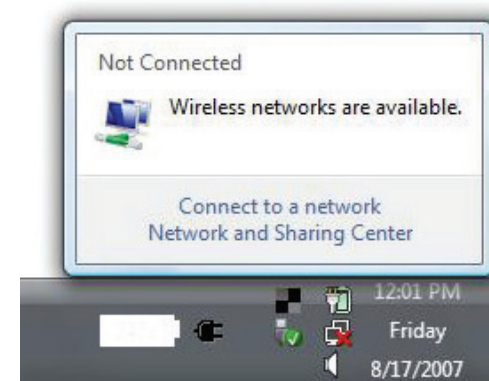

2. Highlight the Wi-Fi name (SSID) you would like to connect to and click **Connect**.

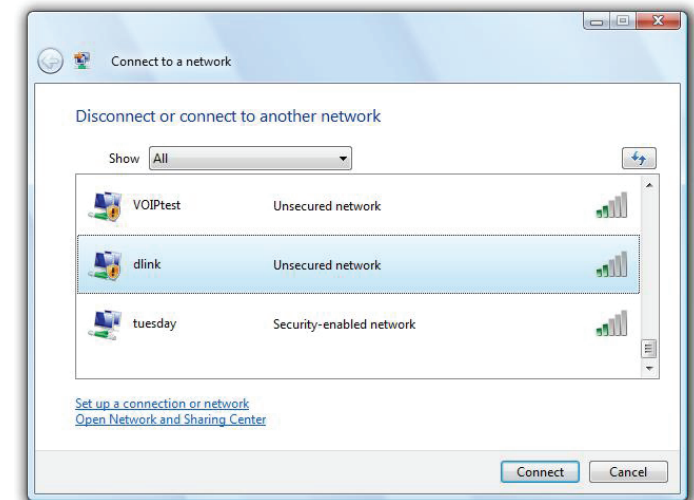

3. Enter the same security key or passphrase (Wi-Fi password) that is on your router and click **Connect**.

It may take 20-30 seconds to connect to the wireless network. If the connection fails, please verify that the security settings are correct. The key or passphrase must be exactly the same as the one on the wireless router.

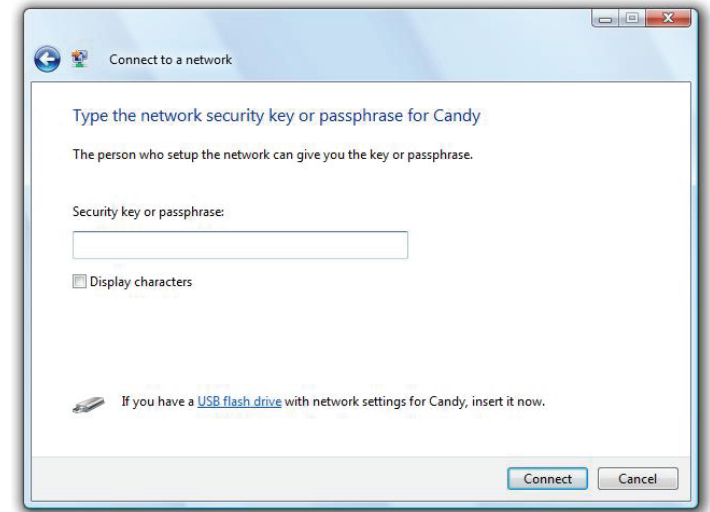

Troubleshooting

This chapter provides solutions to problems that can occur during the installation and operation of the DIR-879. Read the following descriptions if you are having problems. The examples below are illustrated in Windows® XP. If you have a different operating system, the screenshots on your computer will look similar to these examples.

1. Why can't I access the web-based configuration utility?

When entering the IP address of the D-Link router (**192.168.0.1** for example), you are not connecting to a website, nor do you have to be connected to the Internet. The device has the utility built-in to a ROM chip in the device itself. Your computer must be on the same IP subnet to connect to the web-based utility.

- Make sure you have an updated Java-enabled web browser. We recommend the following:
 - Microsoft Internet Explorer® 10 or higher
 - Mozilla Firefox 28 or higher
 - Google™ Chrome 28 or higher
 - Apple Safari 6 or higher
- Verify physical connectivity by checking for solid link lights on the device. If you do not get a solid link light, try using a different cable, or connect to a different port on the device if possible. If the computer is turned off, the link light may not be on.
- Disable any Internet security software running on the computer. Software firewalls such as ZoneAlarm, BlackICE, Sygate, Norton Personal Firewall, and Windows® XP firewall may block access to the configuration pages. Check the help files included with your firewall software for more information on disabling or configuring it.

- Configure your Internet settings:
 - Go to **Start > Settings > Control Panel**. Double-click the **Internet Options** icon. From the **Security** tab, click the button to restore the settings to their defaults.
 - Click the **Connection** tab and set the dial-up option to Never Dial a Connection. Click the LAN Settings button. Make sure nothing is checked. Click **OK**.
 - Go to the **Advanced** tab and click the button to restore these settings to their defaults. Click **OK** three times.
 - Close your web browser (if open) and open it.
- Access the web management. Open your web browser and enter the IP address of your D-Link router in the address bar. This should open the login page for your web management.
- If you still cannot access the configuration, unplug the power to the router for 10 seconds and plug back in. Wait about 30 seconds and try accessing the configuration. If you have multiple computers, try connecting using a different computer.

2. What can I do if I forgot my password?

If you forgot your password, you must reset your router. This process will change all your settings back to the factory defaults.

To reset the router, locate the reset button (hole) on the rear panel of the unit. With the router powered on, use a paperclip to hold the button down for 10 seconds. Release the button and the router will go through its reboot process. Wait about 30 seconds to access the router. The default IP address is **192.168.0.1**. When logging in, leave the password box empty.

3. Why can't I connect to certain sites or send and receive emails when connecting through my router?

If you are having a problem sending or receiving email, or connecting to secure sites such as eBay, banking sites, and Hotmail, we suggest lowering the MTU in increments of ten (Ex. 1492, 1482, 1472, etc).

To find the proper MTU Size, you'll have to do a special ping of the destination you're trying to go to. A destination could be another computer, or a URL.

- Click on **Start** and then click **Run**.
- Windows® 95, 98, and Me users type in **command** (Windows® NT, 2000, XP, Vista®, and 7 users type in **cmd**) and press **Enter** (or click **OK**).
- Once the window opens, you'll need to do a special ping. Use the following syntax:

ping [url] [-f] [-l] [MTU value]

Example: **ping yahoo.com -f -l 1472**

```
C:\>ping yahoo.com -f -l 1482
Pinging yahoo.com [66.94.234.13] with 1482 bytes of data:
Packet needs to be fragmented but DF set.
Packet needs to be fragmented but DF set.
Packet needs to be fragmented but DF set.
Packet needs to be fragmented but DF set.
Ping statistics for 66.94.234.13:
    Packets: Sent = 4, Received = 0, Lost = 4 (100% loss),
    Approximate round trip times in milli-seconds:
        Minimum = 0ms, Maximum = 0ms, Average = 0ms
C:\>ping yahoo.com -f -l 1472
Pinging yahoo.com [66.94.234.13] with 1472 bytes of data:
Reply from 66.94.234.13: bytes=1472 time=93ms TTL=52
Reply from 66.94.234.13: bytes=1472 time=109ms TTL=52
Reply from 66.94.234.13: bytes=1472 time=125ms TTL=52
Reply from 66.94.234.13: bytes=1472 time=203ms TTL=52
Ping statistics for 66.94.234.13:
    Packets: Sent = 4, Received = 4, Lost = 0 (0% loss),
    Approximate round trip times in milli-seconds:
        Minimum = 93ms, Maximum = 203ms, Average = 132ms
C:\>
```

You should start at 1472 and work your way down by 10 each time. Once you get a reply, go up by 2 until you get a fragmented packet. Take that value and add 28 to the value to account for the various TCP/IP headers. For example, let's say that 1452 was the proper value, the actual MTU size would be 1480, which is the optimum for the network we're working with ($1452+28=1480$).

Once you find your MTU, you can now configure your router with the proper MTU size.

To change the MTU rate on your router follow the steps below:

- Open your browser, enter the IP address of your router (192.168.0.1) and click **OK**.
- Enter your username (admin) and password (blank by default). Click **OK** to enter the web configuration page for the device.
- Click on **Setup** and then click **Manual Configure**.
- To change the MTU, enter the number in the MTU field and click **Save Settings** to save your settings.
- Test your email. If changing the MTU does not resolve the problem, continue changing the MTU in increments of ten.

Wireless Basics

D-Link wireless products are based on industry standards to provide easy-to-use and compatible high-speed wireless connectivity within your home, business, or public access wireless networks. Strictly adhering to the IEEE standard, the D-Link wireless family of products will allow you to securely access the data you want, when, and where you want it. You will be able to enjoy the freedom that wireless networking delivers.

A wireless local area network (WLAN) is a cellular computer network that transmits and receives data with radio signals instead of wires. Wireless LANs are used increasingly in both home and office environments, and public areas such as airports, coffee shops and universities. Innovative ways to utilize WLAN technology are helping people work, and communicate more efficiently. Increased mobility and the absence of cabling and other fixed infrastructure have proven to be beneficial for many users.

Wireless users can use the same applications they use on a wired network. Wireless adapter cards used on laptop and desktop systems support the same protocols as Ethernet adapter cards.

Under many circumstances, it may be desirable for mobile network devices to link to a conventional Ethernet LAN in order to use servers, printers or an Internet connection supplied through the wired LAN. A wireless router is a device used to provide this link.

What is Wireless?

Wireless or Wi-Fi technology is another way of connecting your computer to the network without using wires. Wi-Fi uses radio frequency to connect wirelessly so you have the freedom to connect computers anywhere in your home or office network.

Why D-Link Wireless?

D-Link is the worldwide leader and award winning designer, developer, and manufacturer of networking products. D-Link delivers the performance you need at a price you can afford. D-Link has all the products you need to build your network.

How does wireless work?

Wireless works similarly to how cordless phones work, through radio signals that transmit data from one point A to point B. But wireless technology has restrictions as to how you can access the network. You must be within the wireless network range area to be able to connect your computer. There are two different types of wireless networks: Wireless Local Area Network (WLAN), and Wireless Personal Area Network (WPAN).

Wireless Local Area Network (WLAN)

In a wireless local area network, a device called an Access Point (AP) connects computers to the network. The access point has a small antenna attached to it, which allows it to transmit data back and forth over radio signals. With an indoor access point the signal can travel up to 300 feet. With an outdoor access point the signal can reach out up to 30 miles to serve places like manufacturing plants, industrial locations, university and high school campuses, airports, golf courses, and many other outdoor venues.

Wireless Personal Area Network (WPAN)

Bluetooth is the industry standard wireless technology used for WPAN. Bluetooth devices in WPAN operate in a range up to 30 feet away.

Compared to WLAN the speed and wireless operation range are both less than WLAN, but in return it doesn't use nearly as much power. This makes it ideal for personal devices, such as mobile phones, PDAs, headphones, laptops, speakers, and other devices that operate on batteries.

Who uses wireless?

Wireless technology has become so popular in recent years that almost everyone is using it, whether it's for home, office, business, D-Link has a wireless solution for it.

Home Uses/Benefits

- Gives everyone at home broadband access
- Surf the web, check email, instant message, etc.
- Gets rid of the cables around the house
- Simple and easy to use

Small Office and Home Office Uses/Benefits

- Stay on top of everything at home as you would at office
- Remotely access your office network from home
- Share Internet connection and printer with multiple computers
- No need to dedicate office space

Where is wireless used?

Wireless technology is expanding everywhere, not just at home or office. People like the freedom of mobility and it's becoming so popular that more and more public facilities now provide wireless access to attract people. The wireless connection in public places is usually called "hotspots".

Using a D-Link USB adapter with your laptop, you can access the hotspot to connect to the Internet from remote locations like: airports, hotels, coffee shops, libraries, restaurants, and convention centers.

Wireless network is easy to setup, but if you're installing it for the first time it could be quite a task not knowing where to start. That's why we've put together a few setup steps and tips to help you through the process of setting up a wireless network.

Tips

Here are a few things to keep in mind, when you install a wireless network.

Centralize your router or access point

Make sure you place the router/access point in a centralized location within your network for the best performance. Try to place the router/access point as high as possible in the room, so the signal gets dispersed throughout your home. If you have a two-story home, you may need a repeater to boost the signal to extend the range.

Eliminate Interference

Place home appliances such as cordless telephones, microwaves, and televisions as far away as possible from the router/access point. This would significantly reduce any interference that the appliances might cause since they operate on same frequency.

Security

Don't let your next-door neighbors or intruders connect to your wireless network. Secure your wireless network by turning on the WPA or WEP security feature on the router. Refer to the product manual for detail information on how to set it up.

Wireless Modes

There are basically two modes of networking:

- **Infrastructure** – All wireless clients will connect to an access point or wireless router.
- **Ad-hoc** – Directly connecting to another computer for peer-to-peer communication using wireless network adapters on each computer, such as two or more DIR-879 wireless network USB adapters.

An Infrastructure network contains an access point or wireless router. All the wireless devices, or clients, will connect to the wireless router or access point.

An Ad-hoc network contains only clients, such as laptops with wireless USB adapters. All the adapters must be in Ad-hoc mode to communicate.

Networking Basics

Check your IP address

After you install your new D-Link adapter, by default, the TCP/IP settings should be set to obtain an IP address from a DHCP server (i.e. wireless router) automatically. To verify your IP address, please follow the steps below.

Click on **Start** > **Run**. In the run box type **cmd** and click **OK**. (Windows® 7/Vista® users type **cmd** in the **Start Search** box.)

At the prompt, type **ipconfig** and press **Enter**.

This will display the IP address, subnet mask, and the default gateway of your adapter.

If the address is 0.0.0.0, check your adapter installation, security settings, and the settings on your router. Some firewall software programs may block a DHCP request on newly installed adapters.

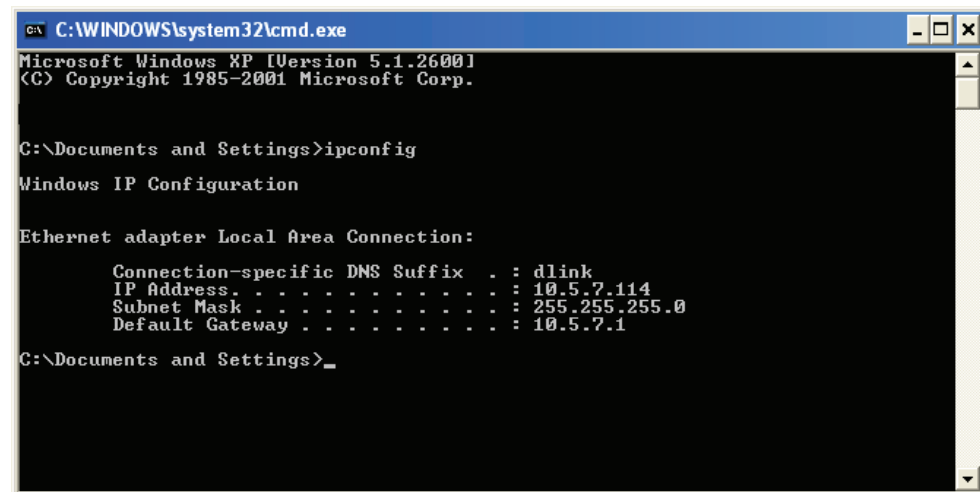

```
C:\WINDOWS\system32\cmd.exe
Microsoft Windows XP [Version 5.1.2600]
(C) Copyright 1985-2001 Microsoft Corp.

C:\Documents and Settings>ipconfig

Windows IP Configuration

Ethernet adapter Local Area Connection:

    Connection-specific DNS Suffix  . : dlink
    IP Address . . . . . : 10.5.7.114
    Subnet Mask . . . . . : 255.255.255.0
    Default Gateway . . . . . : 10.5.7.1

C:\Documents and Settings>_
```

Statically Assign an IP address

If you are not using a DHCP capable gateway/router, or you need to assign a static IP address, please follow the steps below:

Step 1

Windows® 7 - Click on **Start > Control Panel > Network and Internet > Network and Sharing Center.**

Windows Vista® - Click on **Start > Control Panel > Network and Internet > Network and Sharing Center > Manage Network**

Connections.

Windows® XP - Click on **Start > Control Panel > Network Connections.**

Windows® 2000 - From the desktop, right-click **My Network Places > Properties.**

Step 2

Right-click on the **Local Area Connection** which represents your network adapter and select **Properties.**

Step 3

Highlight **Internet Protocol (TCP/IP)** and click **Properties.**

Step 4

Click **Use the following IP address** and enter an IP address that is on the same subnet as your network or the LAN IP address on your router.

Example: If the router's LAN IP address is 192.168.0.1, make your IP address 192.168.0.X where X is a number between 2 and 99. Make sure that the number you choose is not in use on the network. Set the Default Gateway the same as the LAN IP address of your router (I.E. 192.168.0.1).

Set Primary DNS the same as the LAN IP address of your router (192.168.0.1). The Secondary DNS is not needed or you may enter a DNS server from your ISP.

Step 5

Click **OK** twice to save your settings.

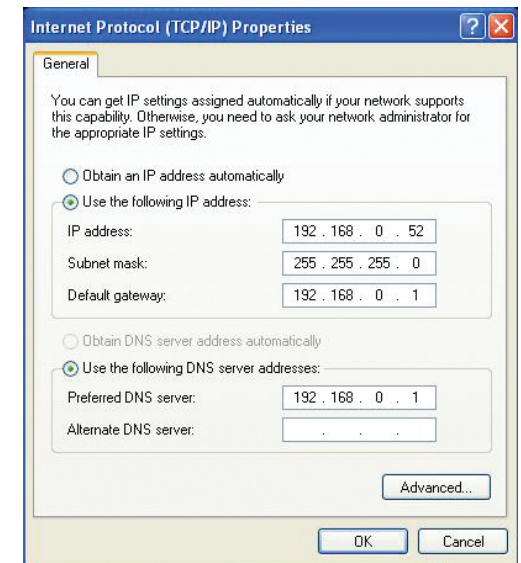

Wireless Security

This section will show you the different levels of security you can use to protect your data from intruders. The DIR-879 offers the following types of security:

- WPA2 (Wi-Fi Protected Access 2)
- WPA (Wi-Fi Protected Access)
- WPA2-PSK (Pre-Shared Key)
- WPA-PSK (Pre-Shared Key)

What is WPA?

WPA (Wi-Fi Protected Access), is a Wi-Fi standard that was designed to improve the security features of WEP (Wired Equivalent Privacy).

The 2 major improvements over WEP:

- Improved data encryption through the Temporal Key Integrity Protocol (TKIP). TKIP scrambles the keys using a hashing algorithm and by adding an integrity-checking feature, ensures that the keys haven't been tampered with. WPA2 is based on 802.11i and uses Advanced Encryption Standard (AES) instead of TKIP.
- User authentication, which is generally missing in WEP, through the extensible authentication protocol (EAP). WEP regulates access to a wireless network based on a computer's hardware-specific MAC address, which is relatively simple to be sniffed out and stolen. EAP is built on a more secure public-key encryption system to ensure that only authorized network users can access the network.

WPA-PSK/WPA2-PSK uses a passphrase or key to authenticate your wireless connection. The key is an alpha-numeric password between 8 and 63 characters long. The password can include symbols (!?*&_) and spaces. This key must be the exact same key entered on your wireless router or access point.

WPA/WPA2 incorporates user authentication through the Extensible Authentication Protocol (EAP). EAP is built on a more secure public key encryption system to ensure that only authorized network users can access the network.

Technical Specifications

Hardware Specifications

- LAN Interface: Four 10/100/1000 Mbps LAN ports
- WAN Interface: One 10/100/1000 Mbps Internet port
- Wireless Interface (2.4 GHz): IEEE 802.11n/g/b
- Wireless Interface (5 GHz): IEEE 802.11 ac/n/a

Operating Voltage

- Input: 100~240 V AC, 50~60 Hz
- Output: 12 V DC, 2 A

Temperature

- Operating: 0 ~ 40 °C (32 ~ 104 °F)
- Non-Operating: -20 ~ 65 °C (-20 ~ 149 °F)

Humidity

- Operating: 10% - 90% non-condensing
- Non-Operating: 5% - 95% non-condensing

Wireless Frequency Range

- IEEE 802.11a: 5150 MHz~5250 MHz, 5725 MHz~5850 MHz
- IEEE 802.11b: 2400 MHz~2483.5 MHz
- IEEE 802.11g: 2400 MHz~2483.5 MHz
- IEEE 802.11n: 2400 MHz~2483.5 MHz, 5150 MHz~5250 MHz, 5725 MHz~5850 MHz
- IEEE 802.11ac: 5150 MHz~5250 MHz, 5725 MHz~5850 MHz

Wireless Bandwidth Rate

- IEEE 802.11a: 54, 48, 36, 24, 18, 12, 9, and 6 Mbps
- IEEE 802.11b: 11, 5.5, 2, and 1 Mbps
- IEEE 802.11g: 54, 48, 36, 24, 18, 12, 9, and 6 Mbps
- IEEE 802.11n: 6.5 to 600 Mbps
- IEEE 802.11ac: 6.5 to 1300 Mbps

Antenna Type

- Four external antennas

Wireless Security

- 64/128bit WEP, WPA/WPA2-Personal, WPS-PBC

EMI/EMC Certification

- CE
- FCC
- IC
- BSMI
- CCC

RF Certification

- CE
- FCC
- IC
- NCC

Safety Certification

- CSA
- CCC
- BSMI

Dimensions & Weight

- 219.67 x 199.45 x 73.55 mm (8.65 x 7.85 x 2.90 inches)
- 750 g (26.5 oz)

Regulatory Statements

Federal Communication Commission Interference Statement

This equipment has been tested and found to comply with the limits for a Class B digital device, pursuant to Part 15 of the FCC Rules. These limits are designed to provide reasonable protection against harmful interference in a residential installation. This equipment generates, uses and can radiate radio frequency energy and, if not installed and used in accordance with the instructions, may cause harmful interference to radio communications. However, there is no guarantee that interference will not occur in a particular installation. If this equipment does cause harmful interference to radio or television reception, which can be determined by turning the equipment off and on, the user is encouraged to try to correct the interference by one of the following measures:

- Reorient or relocate the receiving antenna.
- Increase the separation between the equipment and receiver.
- Connect the equipment into an outlet on a circuit different from that to which the receiver is connected.
- Consult the dealer or an experienced radio/TV technician for help.

Non-modifications Statement:

Any changes or modifications not expressly approved by the party responsible for compliance could void the user's authority to operate this equipment.

Caution:

This device complies with Part 15 of the FCC Rules. Operation is subject to the following two conditions:

- (1) This device may not cause harmful interference, and
- (2) this device must accept any interference received, including interference that may cause undesired operation.

This device and its antenna(s) must not be co-located or operating in conjunction with any other antenna or transmitter except in accordance with FCC multi-transmitter product procedures. For product available in the USA/Canada market, only channel 1~11 can be operated. Selection of other channels is not possible.

Note

The country code selection is for non-USA models only and is not available to all USA models. Per FCC regulations, all WiFi product marketed in the USA must be fixed to USA operational channels only.

RF Frequency Requirements

This device is for indoor use only when using all channels in the 5.150 to 5.250 GHz frequency range. High power radars are allocated as primary users of the 5.150 to 5.250 GHz bands. These radar stations can cause interference with and/or damage this device.

It is restricted to indoor environments only.

IMPORTANT NOTICE:

FCC Radiation Exposure Statement

This equipment complies with FCC radiation exposure limits set forth for an uncontrolled environment. This equipment should be installed and operated with minimum distance 26 cm between the radiator and your body.

Innovation, Science and Economic Development Canada (ISED) Statement:

This Class B digital apparatus complies with Canadian ICES-003.

Cet appareil numérique de la classe B est conforme à la norme NMB-003 du Canada.

Innovation, Science and Economic Development Canada (ISED) Statement:

This device complies with ISED licence-exempt RSS standard(s). Operation is subject to the following two conditions:

- (1) this device may not cause interference, and
- (2) this device must accept any interference, including interference that may cause undesired operation of the device.

Le présent appareil est conforme aux CNR d'ISED applicables aux appareils radio exempts de licence. L'exploitation est autorisée aux deux conditions suivantes :

- (1) l'appareil ne doit pas produire de brouillage, et
- (2) l'utilisateur de l'appareil doit accepter tout brouillage radioélectrique subi, même si le brouillage est susceptible d'en compromettre le fonctionnement.

(i) the device for operation in the band 5150-5250 MHz is only for indoor use to reduce the potential for harmful interference to co-channel mobile satellite systems;

(i) les dispositifs fonctionnant dans la bande 5150-5250 MHz sont réservés uniquement pour une utilisation à l'intérieur afin de réduire les risques de brouillage préjudiciable aux systèmes de satellites mobiles utilisant les mêmes canaux;

This radio transmitter DIR-879A1 has been approved by Industry Canada to operate with the antenna types listed below with the maximum permissible gain and required antenna impedance for each antenna type indicated. Antenna types not included in this list, having a gain greater than the maximum gain indicated for that type, are strictly prohibited for use with this device.

Le présent émetteur radio DIR-879A1 a été approuvé par Industrie Canada pour fonctionner avec les types d'antenne énumérés ci-dessous et ayant un gain admissible maximal et l'impédance requise pour chaque type d'antenne. Les types d'antenne non inclus dans cette liste, ou dont le gain est supérieur au gain maximal indiqué, sont strictement interdits pour l'exploitation de l'émetteur.

Table for Filed Antenna

Ant.	Brand	P/N	Antenna Type	Connector	2.4 G Gain (dBi)	5 G Gain (dBi)
1	Nienyi	NYS1751	PCB Antenna	MHF-I Plug	3 dBi	3 dBi
2	Nienyi	NYS1752	PCB Antenna	MHF-I Plug	3 dBi	3 dBi
3	Nienyi	NYS1753	PCB Antenna	MHF-I Plug	3 dBi	3 dBi
4	Nienyi	NYS1754	PCB Antenna	MHF-I Plug	3 dBi	3 dBi

Radiation Exposure Statement

This equipment complies with ISED radiation exposure limits set forth for an uncontrolled environment. This equipment should be installed and operated with minimum distance 26 cm between the radiator and your body.

Déclaration d'exposition aux radiations

Cet équipement est conforme aux limites d'exposition aux rayonnements ISED établies pour un environnement non contrôlé. Cet équipement doit être installé et utilisé avec un minimum de 26 cm de distance entre la source de rayonnement et votre corps.

Warning

This unit is to be used with a power supply DA-60N12.

Avertissement

Cet appareil doit être utilisé avec une source de courant, modèle DA-60N12.

NCC 警語：

以下警語適用台灣地區

依據 低功率電波輻射性電機管理辦法

第十二條: 經型式認證合格之低功率射頻電機，非經許可，公司、商號或使用者均不得擅自變更頻率、加大功率或變更原設計之特性及功能。

第十四條: 低功率射頻電機之使用不得影響飛航安全及干擾合法通信；經發現有干擾現象時，應立即停用，並改善至無干擾時方得繼續使用。前項合法通信，指依電信法規定作業之無線電通信。低功率射頻電機須忍受合法通信或工業、科學及醫療用電波輻射性電機設備之干擾。

本模組於取得認證後將依規定於模組本體標示審驗合格標籤系統廠商應於平台上標示「本產品內含射頻模組:  CCAF16LP0260T0」字樣

無線傳輸設備 (UNII)

在 5.25-5.35 赫赫頻帶內操作之無線資訊傳輸設備，限於室內使用。無線資訊傳輸設備忍受合法通信之干擾且不得干擾合法通信；如造成干擾，應立即停用，俟無干擾之虞，始得繼續使用。無線資訊傳設備的製造廠商應確保頻率穩定性，如依製造廠商使用手冊上所述正常操作，發射的信號應維持於操作頻帶中。

電磁波曝露量MPE標準值(MPE) 1 mW/cm²，送測產品實值為 1 mW/cm²



	Frequency Band(s) Frequenzband Fréquence bande(s) Bandas de Frecuencia Frequenza/e Frequentie(s)	Max. Output Power (EIRP) Max. Output Power Consommation d'énergie max. Potencia máxima de Salida Potenza max. Output Max. Output Power
5 G	5.15 – 5.25 GHz	200 mW
	5.25 – 5.35 GHz	200 mW
	5.47 – 5.725 GHz	1 W
2.4 G	2.4 – 2.4835 GHz	100 mW

European Community Declaration of Conformity:

Česky [Czech]	Tímto D-Link Corporation prohlašuje, že tento produkt, jeho příslušenství a software jsou v souladu se směrnicí 2014/53/EU. Celý text ES prohlášení o shodě vydaného EU a o firmwaru produktu lze stáhnout na stránkách k produktu www.dlink.com .
Dansk [Danish]	D-Link Corporation erklærer herved, at dette produkt, tilbehør og software er i overensstemmelse med direktiv 2014/53/EU. Den fulde tekst i EU-overensstemmelseserklæringen og produktfirmware kan wnloades fra produktsiden hos www.dlink.com .
Deutsch [German]	Hiermit erklärt die D-Link Corporation, dass dieses Produkt, das Zubehör und die Software der Richtlinie 2014/53/EU entsprechen. Der vollständige Text der Konformitätserklärung der Europäischen Gemeinschaft sowie die Firmware zum Produkt stehen Ihnen zum Herunterladen von der Produktseite im Internet auf www.dlink.com zur Verfügung.
Eesti [Estonian]	Käesolevaga kinnitab D-Link Corporation, et see toode, tarvikud ja tarkvara on kooskõlas direktiiviga 2014/53/EL. Euroopa Liidu vastavusdeklaratsiooni täistekst ja toote püsivara on allalaadimiseks saadaval tootelehel www.dlink.com .
English	Hereby, D-Link Corporation, declares that this product, accessories, and software are in compliance with directive 2014/53/EU. The full text of the EU Declaration of Conformity and product firmware are available for download from the product page at www.dlink.com
Español [Spanish]	Por la presente, D-Link Corporation declara que este producto, accesorios y software cumplen con las directivas 2014/53/UE. El texto completo de la declaración de conformidad de la UE y el firmware del producto están disponibles y se pueden descargar desde la página del producto en www.dlink.com .
Ελληνική [Greek]	Με την παρούσα, η D-Link Corporation δηλώνει ότι αυτό το προϊόν, τα αξεσουάρ και το λογισμικό συμμορφώνονται με την Οδηγία 2014/53/ΕΕ. Το πλήρες κείμενο της δήλωσης συμμόρφωσης της ΕΕ και το υλικολογισμικό του προϊόντος είναι διαθέσιμα για λήψη από τη σελίδα του προϊόντος στην τοποθεσία www.dlink.com .
Français [French]	Par les présentes, D-Link Corporation déclare que ce produit, ces accessoires et ce logiciel sont conformes aux directives 2014/53/UE. Le texte complet de la déclaration de conformité de l'UE et le microprogramme du produit sont disponibles au téléchargement sur la page des produits à www.dlink.com .
Italiano [Italian]	Con la presente, D-Link Corporation dichiara che questo prodotto, i relativi accessori e il software sono conformi alla direttiva 2014/53/UE. Il testo completo della dichiarazione di conformità UE e il firmware del prodotto sono disponibili per il download dalla pagina del prodotto su www.dlink.com .

Latviski [Latvian]	Ar šo uzņēmums D-Link Corporation apliecina, ka šis produkts, piederumi un programmatūra atbilst direktīvai 2014/53/ES. ES atbilstības deklarācijas pilno tekstu un produkta aparātprogrammatūru var lejupielādēt attiecīgā produkta lapā vietnē www.dlink.com .
Lietuvių [Lithuanian]	Šiuo dokumentu „D-Link Corporation“ pareiškia, kad šis gaminys, priedai ir programinė įranga atitinka direktyvą 2014/53/ES. Visą ES atitikties deklaracijos tekstą ir gaminio programinę aparatinę įrangą galima atsisiųsti iš gaminio puslapio adresu www.dlink.com .
Nederlands [Dutch]	Hierbij verklaart D-Link Corporation dat dit product, accessoires en software voldoen aan de richtlijnen 2014/53/EU. De volledige tekst van de EU conformiteitsverklaring en productfirmware is beschikbaar voor download van de productpagina op www.dlink.com .
Malti [Maltese]	Bil-preżenti, D-Link Corporation tiddikjara li dan il-prodott, l-aċċessorji, u s-software huma konformi mad-Direttiva 2014/53/UE. Tista' tniżżel it-test sħiħ tad-dikjarazzjoni ta' konformità tal-UE u l-firmware tal-prodott mill-paġna tal-prodott fuq www.dlink.com .
Magyar [Hungarian]	Ezennel a D-Link Corporation kijelenti, hogy a jelen termék, annak tartozékai és szoftvere megfelelnek a 2014/53/EU sz. rendeletnek. Az EU Megfelelőségi nyilatkozat teljes szövege és a termék firmware a termék oldaláról tölthető le a www.dlink.com címen.
Polski [Polish]	D-Link Corporation niniejszym oświadcza, że ten produkt, akcesoria oraz oprogramowanie są zgodne z dyrektywami 2014/53/EU. Pełen tekst deklaracji zgodności UE oraz oprogramowanie sprzętowe do produktu można pobrać na stronie produktu w witrynie www.dlink.com .
Português [Portuguese]	Desta forma, a D-Link Corporation declara que este produto, os acessórios e o software estão em conformidade com a diretiva 2014/53/UE. O texto completo da declaração de conformidade da UE e do firmware
Slovensko[Slovenian]	Podjetje D-Link Corporation s tem izjavlja, da so ta izdelek, dodatna oprema in programnska oprema skladni z direktivami 2014/53/EU. Celotno besedilo izjave o skladnosti EU in vdelana programska oprema sta na voljo za prenos na strani izdelka na www.dlink.com .
Slovensky [Slovak]	Spoločnosť D-Link týmto vyhlasuje, že tento produkt, príslušenstvo a softvér sú v súlade so smernicou 214/53/EÚ. Úplné znenie vyhlásenia EÚ o zhode a firmvéri produktu sú k dispozícii na prevzatie zo stránky produktu www.dlink.com .
Suomi [Finnish]	D-Link Corporation täten vakuuttaa, että tämä tuote, lisävarusteet ja ohjelmisto ovat direktiivin 2014/53/EU vaatimusten mukaisia. Täydellinen EU-vaatimustenmukaisuusvakuutus samoin kuin tuotteen laiteohjelmisto ovat ladattavissa osoitteesta www.dlink.com .
Svenska[Swedish]	D-Link Corporation försäkrar härmed att denna produkt, tillbehör och programvara överensstämmer med direktiv 2014/53/EU. Hela texten med EU-försäkran om överensstämmelse och produkt-firmware kan hämtas från produktsidan på www.dlink.com .

Íslenska [Icelandic]	Hér með lýsir D-Link Corporation því yfir að þessi vara, fylgihlutir og hugbúnaður eru í samræmi við tilskipun 2014/53/EB. Sækja má ESB-samræmisýfirlýsinguna í heild sinni og fastbúnað vörunnar af vefsíðu vörunnar á www.dlink.com .
Norsk [Norwegian]	Herved erklærer D-Link Corporation at dette produktet, tilbehøret og programvaren er i samsvar med direktivet 2014/53/EU. Den fullstendige teksten i EU-erklæring om samsvar og produktets fastvare er tilgjengelig for nedlasting fra produktsiden på www.dlink.com .

Warning Statement:

The power outlet should be near the device and easily accessible.

NOTICE OF WIRELESS RADIO LAN USAGE IN THE EUROPEAN COMMUNITY (FOR WIRELESS PRODUCT ONLY):

- This device is restricted to indoor use when operated in the European Community using channels in the 5.15-5.35 GHz band to reduce the potential for interference.
- This device is a 2.4 GHz wideband transmission system (transceiver), intended for use in all EU member states and EFTA countries. This equipment may be operated in AL, AD, BE, BG, DK, DE, FI, FR, GR, GW, IS, IT, HR, LI, LU, MT, MK, MD, MC, NL, NO, AT, PL, PT, RO, SM, SE, RS, SK, ES, CI, HU, and CY.

Usage Notes:

- To remain in conformance with European National spectrum usage regulations, frequency and channel limitations will be applied on the products according to the country where the equipment will be deployed.
- This device is restricted from functioning in Ad-hoc mode while operating in 5 GHz. Ad-hoc mode is direct peer-to-peer communication between two client devices without an Access Point.
- Access points will support DFS (Dynamic Frequency Selection) and TPC (Transmit Power Control) functionality as required when operating in 5 GHz band within the EU.
- Please refer to the product manual or datasheet to check whether your product uses 2.4 GHz and/or 5 GHz wireless.

HINWEIS ZUR VERWENDUNG VON DRAHTLOS-NETZWERK (WLAN) IN DER EUROPÄISCHEN GEMEINSCHAFT (NUR FÜR EIN DRAHTLOSES PRODUKT)

- Der Betrieb dieses Geräts in der Europäischen Gemeinschaft bei Nutzung von Kanälen im 5,15-5,35 GHz Frequenzband ist ausschließlich auf Innenräume beschränkt, um das Interferenzpotential zu reduzieren.
- Bei diesem Gerät handelt es sich um ein zum Einsatz in allen EU-Mitgliedsstaaten und in EFTA-Ländern - ausgenommen Frankreich. Der Betrieb dieses Geräts ist in den folgenden Ländern erlaubt: AL, AD, BE, BG, DK, DE, FI, FR, GR, GW, IS, IT, HR, LI, LU, MT, MK, MD, MC, NL, NO, AT, PL, PT, RO, SM, SE, RS, SK, ES, CI, HU, CY

Gebrauchshinweise:

- Um den in Europa geltenden nationalen Vorschriften zum Nutzen des Funkspektrums weiterhin zu entsprechen, werden Frequenz und Kanalbeschränkungen, dem jeweiligen Land, in dem das Gerät zum Einsatz kommt, entsprechend, auf die Produkte angewandt.
- Die Funktionalität im Ad-hoc-Modus bei Betrieb auf 5 GHz ist für dieses Gerät eingeschränkt. Bei dem Ad-hoc-Modus handelt es sich um eine Peer-to-Peer-Kommunikation zwischen zwei Client-Geräten ohne einen Access Point.
- Access Points unterstützen die Funktionen DFS (Dynamic Frequency Selection) und TPC (Transmit Power Control) wie erforderlich bei Betrieb auf 5 GHz innerhalb der EU.
- Bitte schlagen Sie im Handbuch oder Datenblatt nach nach, ob Ihr Gerät eine 2,4 GHz und / oder 5 GHz Verbindung nutzt.

AVIS CONCERNANT L'UTILISATION DE LA RADIO SANS FIL LAN DANS LA COMMUNAUTÉ EUROPÉENNE (UNIQUEMENT POUR LES PRODUITS SANS FIL)

- Cet appareil est limité à un usage intérieur lorsqu'il est utilisé dans la Communauté européenne sur les canaux de la bande de 5,15 à 5,35 GHz afin de réduire les risques d'interférences.
- Cet appareil est un système de transmission à large bande (émetteur-récepteur) de 2,4 GHz, destiné à être utilisé dans tous les États-membres de l'UE et les pays de l'AELE. Cet équipement peut être utilisé dans les pays suivants : AL, AD, BE, BG, DK, DE, FI, FR, GR, GW, IS, IT, HR, LI, LU, MT, MK, MD, MC, NL, NO, AT, PL, PT, RO, SM, SE, RS, SK, ES, CI, HU, CY

Notes d'utilisation:

- Pour rester en conformité avec la réglementation nationale européenne en matière d'utilisation du spectre, des limites de fréquence et de canal seront appliquées aux produits selon le pays où l'équipement sera déployé.
- Cet appareil ne peut pas utiliser le mode Ad-hoc lorsqu'il fonctionne dans la bande de 5 GHz. Le mode Adhoc fournit une communication directe pair à pair entre deux périphériques clients sans point d'accès.
- Les points d'accès prendront en charge les fonctionnalités DFS (Dynamic Frequency Selection) et TPC (Transmit Power Control) au besoin lors du fonctionnement dans la bande de 5 GHz au sein de l'UE.
- Merci de vous référer au guide d'utilisation ou de la fiche technique afin de vérifier si votre produit utilise 2.4 GHz et/ou 5 GHz sans fil.

AVISO DE USO DE LA LAN DE RADIO INALÁMBRICA EN LA COMUNIDAD EUROPEA (SOLO PARA EL PRODUCTO INALÁMBRICO)

- El uso de este dispositivo está restringido a interiores cuando funciona en la Comunidad Europea utilizando canales en la banda de 5,15-5,35 GHz, para reducir la posibilidad de interferencias.
- Este dispositivo es un sistema de transmisión (transceptor) de banda ancha de 2,4 GHz, pensado para su uso en todos los estados miembros de la UE y en los países de la AELC. Este equipo se puede utilizar en AL, AD, BE, BG, DK, DE, FI, FR, GR, GW, IS, IT, HR, LI, LU, MT, MK, MD, MC, NL, NO, AT, PL, PT, RO, SM, SE, RS, SK, ES, CI, HU, CY

Notas de uso:

- Para seguir cumpliendo las normas europeas de uso del espectro nacional, se aplicarán limitaciones de frecuencia y canal en los productos en función del país en el que se pondrá en funcionamiento el equipo.
- Este dispositivo tiene restringido el funcionamiento en modo Ad-hoc mientras funcione a 5 Ghz. El modo Ad-hoc es la comunicación directa de igual a igual entre dos dispositivos cliente sin un punto de acceso.
- Los puntos de acceso admitirán la funcionalidad DFS (Selección de frecuencia dinámica) y TPC (Control de la potencia de transmisión) si es necesario cuando funcionan a 5 Ghz dentro de la UE.
- Por favor compruebe el manual o la ficha de producto para comprobar si el producto utiliza las bandas inalámbricas de 2.4 GHz y/o la de 5 GHz.

AVVISO PER L'USO DI LAN RADIO WIRELESS NELLA COMUNITÀ EUROPEA (SOLO PER PRODOTTI WIRELESS)

- Nella Comunità europea, l'uso di questo dispositivo è limitato esclusivamente agli ambienti interni sui canali compresi nella banda da 5,15 a 5,35 GHz al fine di ridurre potenziali interferenze. Questo dispositivo è un sistema di trasmissione a banda larga a 2,4 GHz (ricetrasmittente), destinato all'uso in tutti gli stati membri dell'Unione europea e nei paesi EFTA.
- Questo dispositivo può essere utilizzato in AL, AD, BE, BG, DK, DE, FI, FR, GR, GW, IS, IT, HR, LI, LU, MT, MK, MD, MC, NL, NO, AT, PL, PT, RO, SM, SE, RS, SK, ES, CI, HU, CY

Note per l'uso

- Al fine di mantenere la conformità alle normative nazionali europee per l'uso dello spettro di frequenze, saranno applicate limitazioni sulle frequenze e sui canali per il prodotto in conformità alle normative del paese in cui il dispositivo viene utilizzato.
- Questo dispositivo non può essere attivato in modalità Ad-hoc durante il funzionamento a 5 GHz. La modalità Ad-hoc è una comunicazione diretta peer-to-peer fra due dispositivi client senza un punto di accesso.
- I punti di accesso supportano le funzionalità DFS (Dynamic Frequency Selection) e TPC (Transmit Power Control) richieste per operare a 5 GHz nell'Unione europea.
- Ti invitiamo a fare riferimento al manuale del prodotto o alla scheda tecnica per verificare se il tuo prodotto utilizza le frequenze 2,4 GHz e/o 5 GHz.

KENNISGEVING VAN DRAADLOOS RADIO LAN-GEbruik IN DE EUROPESE GEMEENSCHAP (ALLEEN VOOR DRAADLOOS PRODUCT)

- Dit toestel is beperkt tot gebruik binnenshuis wanneer het wordt gebruikt in de Europese Gemeenschap gebruik makend van kanalen in de 5.15-5.35 GHz band om de kans op interferentie te beperken.
- Dit toestel is een 2.4 GHz breedband transmissiesysteem (transceiver) dat bedoeld is voor gebruik in alle EU lidstaten en EFTA landen. Deze uitrusting mag gebruikt worden in AL, AD, BE, BG, DK, DE, FI, FR, GR, GW, IS, IT, HR, LI, LU, MT, MK, MD, MC, NL, NO, AT, PL, PT, RO, SM, SE, RS, SK, ES, CI, HU, CY

Gebruiksaanwijzingen:

- Om de gebruiksvoorschriften van het Europese Nationale spectrum na te leven, zullen frequentie- en kanaalbeperkingen worden toegepast op de producten volgens het land waar de uitrusting gebruikt zal worden.
- Dit toestel kan niet functioneren in Ad-hoc mode wanneer het gebruikt wordt in 5 GHz. Ad-hoc mode is directe peer-to-peer communicatie tussen twee klantenapparaten zonder een toegangspunt.
- Toegangspunten ondersteunen DFS (Dynamic Frequency Selection) en TPC (Transmit Power Control) functionaliteit zoals vereist bij gebruik in 5 GHz binnen de EU.
- Raadpleeg de handleiding of de datasheet om te controleren of uw product gebruik maakt van 2.4 GHz en/of 5 GHz.

SAFETY INSTRUCTIONS

The following general safety guidelines are provided to help ensure your own personal safety and protect your product from potential damage. Remember to consult the product user instructions for more details.

- Static electricity can be harmful to electronic components. Discharge static electricity from your body (i.e. touching grounded bare metal) before touching the product.
- Do not attempt to service the product and never disassemble the product. For some products with a user replaceable battery, please read and follow the instructions in the user manual.
- Do not spill food or liquid on your product and never push any objects into the openings of your product.
- Do not use this product near water, areas with high humidity, or condensation unless the product is specifically rated for outdoor application.
- Keep the product away from radiators and other heat sources.
- Always unplug the product from mains power before cleaning and use a dry lint free cloth only.

SICHERHEITSVORSCHRIFTEN

Die folgenden allgemeinen Sicherheitsvorschriften dienen als Hilfe zur Gewährleistung Ihrer eigenen Sicherheit und zum Schutz Ihres Produkts. Weitere Details finden Sie in den Benutzeranleitungen zum Produkt.

- Statische Elektrizität kann elektronischen Komponenten schaden. Um Schäden durch statische Aufladung zu vermeiden, leiten Sie elektrostatische Ladungen von Ihrem Körper ab, (z. B. durch Berühren eines geerdeten blanken Metallteils), bevor Sie das Produkt berühren.
- Unterlassen Sie jeden Versuch, das Produkt zu warten, und versuchen Sie nicht, es in seine Bestandteile zu zerlegen. Für einige Produkte mit austauschbaren Akkus lesen Sie bitte das Benutzerhandbuch und befolgen Sie die dort beschriebenen Anleitungen.
- Vermeiden Sie, dass Speisen oder Flüssigkeiten auf Ihr Produkt gelangen, und stecken Sie keine Gegenstände in die Gehäuseschlitze oder -öffnungen Ihres Produkts.
- Verwenden Sie dieses Produkt nicht in unmittelbarer Nähe von Wasser und nicht in Bereichen mit hoher Luftfeuchtigkeit oder Kondensation, es sei denn, es ist speziell zur Nutzung in Außenbereichen vorgesehen und eingestuft.
- Halten Sie das Produkt von Heizkörpern und anderen Quellen fern, die Wärme erzeugen.
- Trennen Sie das Produkt immer von der Stromzufuhr, bevor Sie es reinigen und verwenden Sie dazu ausschließlich ein trockenes fusselfreies Tuch.

CONSIGNES DE SÉCURITÉ

Les consignes générales de sécurité ci-après sont fournies afin d'assurer votre sécurité personnelle et de protéger le produit d'éventuels dommages. Veuillez consulter les consignes d'utilisation du produit pour plus de détails.

- L'électricité statique peut endommager les composants électroniques. Déchargez l'électricité statique de votre corps (en touchant un objet en métal relié à la terre par exemple) avant de toucher le produit.
- N'essayez pas d'intervenir sur le produit et ne le démontez jamais. Pour certains produits contenant une batterie remplaçable par l'utilisateur, veuillez lire et suivre les consignes contenues dans le manuel d'utilisation.
- Ne renversez pas d'aliments ou de liquide sur le produit et n'insérez jamais d'objets dans les orifices.
- N'utilisez pas ce produit à proximité d'un point d'eau, de zones très humides ou de condensation sauf si le produit a été spécifiquement conçu pour une application extérieure.
- Éloignez le produit des radiateurs et autres sources de chaleur.
- Débranchez toujours le produit de l'alimentation avant de le nettoyer et utilisez uniquement un chiffon sec non pelucheux.

INSTRUCCIONES DE SEGURIDAD

Las siguientes directrices de seguridad general se facilitan para ayudarle a garantizar su propia seguridad personal y para proteger el producto frente a posibles daños. No olvide consultar las instrucciones del usuario del producto para obtener más información.

- La electricidad estática puede resultar nociva para los componentes electrónicos. Descargue la electricidad estática de su cuerpo (p. ej., tocando algún metal sin revestimiento conectado a tierra) antes de tocar el producto.
- No intente realizar el mantenimiento del producto ni lo desmonte nunca. Para algunos productos con batería reemplazable por el usuario, lea y siga las instrucciones del manual de usuario.
- No derrame comida o líquidos sobre el producto y nunca deje que caigan objetos en las aberturas del mismo.
- No utilice este producto cerca del agua, en zonas con humedad o condensación elevadas a menos que el producto esté clasificado específicamente para aplicación en exteriores.
- Mantenga el producto alejado de los radiadores y de otras fuentes de calor.
- Desenchufe siempre el producto de la alimentación de red antes de limpiarlo y utilice solo un paño seco sin pelusa.

ISTRUZIONI PER LA SICUREZZA

Le seguenti linee guida sulla sicurezza sono fornite per contribuire a garantire la sicurezza personale degli utenti e a proteggere il prodotto da potenziali danni. Per maggiori dettagli, consultare le istruzioni per l'utente del prodotto.

- L'elettricità statica può essere pericolosa per i componenti elettronici. Scaricare l'elettricità statica dal corpo (ad esempio toccando una parte metallica collegata a terra) prima di toccare il prodotto.
- Non cercare di riparare il prodotto e non smontarlo mai. Per alcuni prodotti dotati di batteria sostituibile dall'utente, leggere e seguire le istruzioni riportate nel manuale dell'utente.
- Non versare cibi o liquidi sul prodotto e non spingere mai alcun oggetto nelle aperture del prodotto.
- Non usare questo prodotto vicino all'acqua, in aree con elevato grado di umidità o soggette a condensa a meno che il prodotto non sia specificatamente approvato per uso in ambienti esterni.
- Tenere il prodotto lontano da caloriferi e altre fonti di calore.
- Scollegare sempre il prodotto dalla presa elettrica prima di pulirlo e usare solo un panno asciutto che non lasci filacce.

VEILIGHEIDSINFORMATIE

De volgende algemene veiligheidsinformatie werd verstrekt om uw eigen persoonlijke veiligheid te waarborgen en uw product te beschermen tegen mogelijke schade. Denk eraan om de gebruikersinstructies van het product te raadplegen voor meer informatie.

- Statische elektriciteit kan schadelijk zijn voor elektronische componenten. Ontlaad de statische elektriciteit van uw lichaam (d.w.z. het aanraken van geaard bloot metaal) voordat u het product aanraakt.
- U mag nooit proberen het product te onderhouden en u mag het product nooit demonteren. Voor sommige producten met door de gebruiker te vervangen batterij, dient u de instructies in de gebruikershandleiding te lezen en te volgen.
- Mors geen voedsel of vloeistof op uw product en u mag nooit voorwerpen in de openingen van uw product duwen.
- Gebruik dit product niet in de buurt van water, gebieden met hoge vochtigheid of condensatie, tenzij het product specifiek geclassificeerd is voor gebruik buitenshuis.
- Houd het product uit de buurt van radiators en andere warmtebronnen.
- U dient het product steeds los te koppelen van de stroom voordat u het reinigt en gebruik uitsluitend een droge pluisvrije doek.

Disposing of and Recycling Your Product

ENGLISH

EN



This symbol on the product or packaging means that according to local laws and regulations this product should be not be disposed of in household waste but sent for recycling. Please take it to a collection point designated by your local authorities once it has reached the end of its life, some will accept products for free. By recycling the product and its packaging in this manner you help to conserve the environment and protect human health.

D-Link and the Environment

At D-Link, we understand and are committed to reducing any impact our operations and products may have on the environment. To minimise this impact D-Link designs and builds its products to be as environmentally friendly as possible, by using recyclable, low toxic materials in both products and packaging.

D-Link recommends that you always switch off or unplug your D-Link products when they are not in use. By doing so you will help to save energy and reduce CO2 emissions.

To learn more about our environmentally responsible products and packaging please visit www.dlinkgreen.com.

DEUTSCH

DE



Dieses Symbol auf dem Produkt oder der Verpackung weist darauf hin, dass dieses Produkt gemäß bestehender örtlicher Gesetze und Vorschriften nicht über den normalen Hausmüll entsorgt werden sollte, sondern einer Wiederverwertung zuzuführen ist. Bringen Sie es bitte zu einer von Ihrer Kommunalbehörde entsprechend amtlich ausgewiesenen Sammelstelle, sobald das Produkt das Ende seiner Nutzungsdauer erreicht hat. Für die Annahme solcher Produkte erheben einige dieser Stellen keine Gebühren. Durch ein auf diese Weise durchgeführtes Recycling des Produkts und seiner Verpackung helfen Sie, die Umwelt zu schonen und die menschliche Gesundheit zu schützen.

D-Link und die Umwelt

D-Link ist sich den möglichen Auswirkungen seiner Geschäftstätigkeiten und seiner Produkte auf die Umwelt bewusst und fühlt sich verpflichtet, diese entsprechend zu mindern. Zu diesem Zweck entwickelt und stellt D-Link seine Produkte mit dem Ziel größtmöglicher Umweltfreundlichkeit her und verwendet wiederverwertbare, schadstoffarme Materialien bei Produktherstellung und Verpackung.

D-Link empfiehlt, Ihre Produkte von D-Link, wenn nicht in Gebrauch, immer auszuschalten oder vom Netz zu nehmen. Auf diese Weise helfen Sie, Energie zu sparen und CO2-Emissionen zu reduzieren.

Wenn Sie mehr über unsere umweltgerechten Produkte und Verpackungen wissen möchten, finden Sie entsprechende Informationen im Internet unter www.dlinkgreen.com.

FRANÇAIS**FR**

Ce symbole apposé sur le produit ou son emballage signifie que, conformément aux lois et réglementations locales, ce produit ne doit pas être éliminé avec les déchets domestiques mais recyclé. Veuillez le rapporter à un point de collecte prévu à cet effet par les autorités locales; certains accepteront vos produits gratuitement. En recyclant le produit et son emballage de cette manière, vous aidez à préserver l'environnement et à protéger la santé de l'homme.

D-Link et l'environnement

Chez D-Link, nous sommes conscients de l'impact de nos opérations et produits sur l'environnement et nous engageons à le réduire. Pour limiter cet impact, D-Link conçoit et fabrique ses produits de manière aussi écologique que possible, en utilisant des matériaux recyclables et faiblement toxiques, tant dans ses produits que ses emballages.

D-Link recommande de toujours éteindre ou débrancher vos produits D-Link lorsque vous ne les utilisez pas. Vous réaliserez ainsi des économies d'énergie et réduirez vos émissions de CO2.

Pour en savoir plus sur les produits et emballages respectueux de l'environnement, veuillez consulter le www.dlinkgreen.com.

ESPAÑOL**ES**

Este símbolo en el producto o el embalaje significa que, de acuerdo con la legislación y la normativa local, este producto no se debe desechar en la basura doméstica sino que se debe reciclar. Llévelo a un punto de recogida designado por las autoridades locales una vez que ha llegado al fin de su vida útil; algunos de ellos aceptan recogerlos de forma gratuita. Al reciclar el producto y su embalaje de esta forma, contribuye a preservar el medio ambiente y a proteger la salud de los seres humanos.

D-Link y el medio ambiente

En D-Link, comprendemos y estamos comprometidos con la reducción del impacto que puedan tener nuestras actividades y nuestros productos en el medio ambiente. Para reducir este impacto, D-Link diseña y fabrica sus productos para que sean lo más ecológicos posible, utilizando materiales reciclables y de baja toxicidad tanto en los productos como en el embalaje.

D-Link recomienda apagar o desenchufar los productos D-Link cuando no se estén utilizando. Al hacerlo, contribuirá a ahorrar energía y a reducir las emisiones de CO2.

Para obtener más información acerca de nuestros productos y embalajes ecológicos, visite el sitio www.dlinkgreen.com.

ITALIANO**IT**

La presenza di questo simbolo sul prodotto o sulla confezione del prodotto indica che, in conformità alle leggi e alle normative locali, questo prodotto non deve essere smaltito nei rifiuti domestici, ma avviato al riciclo. Una volta terminato il ciclo di vita utile, portare il prodotto presso un punto di raccolta indicato dalle autorità locali. Alcuni questi punti di raccolta accettano gratuitamente i prodotti da riciclare. Scegliendo di riciclare il prodotto e il relativo imballaggio, si contribuirà a preservare l'ambiente e a salvaguardare la salute umana.

D-Link e l'ambiente

D-Link cerca da sempre di ridurre l'impatto ambientale dei propri stabilimenti e dei propri prodotti. Allo scopo di ridurre al minimo tale impatto, D-Link progetta e realizza i propri prodotti in modo che rispettino il più possibile l'ambiente, utilizzando materiali riciclabili a basso tasso di tossicità sia per i prodotti che per gli imballaggi.

D-Link raccomanda di spegnere sempre i prodotti D-Link o di scollegarne la spina quando non vengono utilizzati. In questo modo si contribuirà a risparmiare energia e a ridurre le emissioni di anidride carbonica.

Per ulteriori informazioni sui prodotti e sugli imballaggi D-Link a ridotto impatto ambientale, visitate il sito all'indirizzo www.dlinkgreen.com.

NEDERLANDS**NL**

Dit symbool op het product of de verpakking betekent dat dit product volgens de plaatselijke wetgeving niet mag worden weggegooid met het huishoudelijk afval, maar voor recyclage moeten worden ingeleverd. Zodra het product het einde van de levensduur heeft bereikt, dient u het naar een inzamelpunt te brengen dat hiertoe werd aangeduid door uw plaatselijke autoriteiten, sommige autoriteiten accepteren producten zonder dat u hiervoor dient te betalen. Door het product en de verpakking op deze manier te recyclen helpt u het milieu en de gezondheid van de mens te beschermen.

D-Link en het milieu

Bij D-Link spannen we ons in om de impact van onze handelingen en producten op het milieu te beperken. Om deze impact te beperken, ontwerpt en bouwt D-Link zijn producten zo milieuvriendelijk mogelijk, door het gebruik van recycleerbare producten met lage toxiciteit in product en verpakking.

D-Link raadt aan om steeds uw D-Link producten uit te schakelen of uit de stekker te halen wanneer u ze niet gebruikt. Door dit te doen bespaart u energie en beperkt u de CO₂-emissies.

Breng een bezoek aan www.dlinkgreen.com voor meer informatie over onze milieuverantwoorde producten en verpakkingen.

POLSKI**PL**

Ten symbol umieszczony na produkcie lub opakowaniu oznacza, że zgodnie z miejscowym prawem i lokalnymi przepisami niniejszego produktu nie wolno wyrzucać jak odpady czy śmieci z gospodarstwa domowego, lecz należy go poddać procesowi recyklingu. Po zakończeniu użytkowania produktu, niektóre odpowiednie do tego celu podmioty przyjmą takie produkty nieodpłatnie, dlatego prosimy dostarczyć go do punktu zbiórki wskazanego przez lokalne władze. Poprzez proces recyklingu i dzięki takiemu postępowaniu z produktem oraz jego opakowaniem, pomogą Państwo chronić środowisko naturalne i dbać o ludzkie zdrowie.

D-Link i środowisko

D-Link podchodzimy w sposób świadomy do ochrony otoczenia oraz jesteśmy zaangażowani w zmniejszanie wpływu naszych działań i produktów na środowisko naturalne. W celu zminimalizowania takiego wpływu firma D-Link konstruuje i wytwarza swoje produkty w taki sposób, aby były one jak najbardziej przyjazne środowisku, stosując do tych celów materiały nadające się do powtórnego wykorzystania, charakteryzujące się małą toksycznością zarówno w przypadku samych produktów jak i opakowań.

Firma D-Link zaleca, aby Państwo zawsze prawidłowo wyłączali z użytku swoje produkty D-Link, gdy nie są one wykorzystywane. Postępując w ten sposób pozwalają Państwo oszczędzać energię i zmniejszać emisje CO₂.

Aby dowiedzieć się więcej na temat produktów i opakowań mających wpływ na środowisko prosimy zapoznać się ze stroną Internetową www.dlinkgreen.com.

ČESKY**CZ**

Tento symbol na výrobku nebo jeho obalu znamená, že podle místně platných předpisů se výrobek nesmí vyhazovat do komunálního odpadu, ale odeslat k recyklaci. Až výrobek doslouží, odnese jej prosím na sběrné místo určené místními úřady k tomuto účelu. Někteřá sběrná místa přijímají výrobky zdarma. Recyklací výrobku i obalu pomáháte chránit životní prostředí i lidské zdraví.

D-Link a životní prostředí

Ve společnosti D-Link jsme si vědomi vlivu našich provozů a výrobků na životní prostředí a snažíme se o minimalizaci těchto vlivů. Proto své výrobky navrhujeme a vyrábíme tak, aby byly co nejekologičtější, a ve výrobcích i obalech používáme recyklovatelné a nízkotoxické materiály.

Společnost D-Link doporučuje, abyste své výrobky značky D-Link vypnuli nebo vytáhli ze zásuvky vždy, když je nepoužíváte. Pomůžete tak šetřit energii a snížit emise CO₂.

Více informací o našich ekologických výrobcích a obalech najdete na adrese www.dlinkgreen.com.

MAGYAR**HU**

Ez a szimbólum a terméken vagy a csomagoláson azt jelenti, hogy a helyi törvényeknek és szabályoknak megfelelően ez a termék nem semmisíthető meg a háztartási hulladékkal együtt, hanem újrahasznosításra kell küldeni. Kérjük, hogy a termék élettartamának elteltét követően vigye azt a helyi hatóság által kijelölt gyűjtőhelyre. A termékek egyes helyeken ingyen elhelyezhetők. A termék és a csomagolás újrahasznosításával segíti védeni a környezetet és az emberek egészségét.

A D-Link és a környezet

A D-Linknél megértjük és elkötelezettek vagyunk a műveleteink és termékeink környezetre gyakorolt hatásainak csökkentésére. Az ezen hatás csökkentése érdekében a D-Link a lehető leginkább környezetbarát termékeket tervez és gyárt azáltal, hogy újrahasznosítható, alacsony károsanyag-tartalmú termékeket gyárt és csomagolásokat alkalmaz.

A D-Link azt javasolja, hogy mindig kapcsolja ki vagy húzza ki a D-Link termékeket a tápforrásból, ha nem használja azokat. Ezzel segít az energia megtakarításában és a széndioxid kibocsátásának csökkentésében.

Környezetbarát termékeinkről és csomagolásainkról további információkat a www.dlinkgreen.com weboldalon tudhat meg.

NORSK**NO**

Dette symbolet på produktet eller forpakningen betyr at dette produktet ifølge lokale lover og forskrifter ikke skal kastes sammen med husholdningsavfall, men leveres inn til gjenvinning. Vennligst ta det til et innsamlingssted anvist av lokale myndigheter når det er kommet til slutten av levetiden. Noen steder aksepteres produkter uten avgift. Ved på denne måten å gjenvinne produktet og forpakningen hjelper du å verne miljøet og beskytte folks helse.

D-Link og miljøet

Hos D-Link forstår vi oss på og er forpliktet til å minske innvirkningen som vår drift og våre produkter kan ha på miljøet. For å minimalisere denne innvirkningen designer og lager D-Link produkter som er så miljøvennlig som mulig, ved å bruke resirkulerbare, lav-toksiske materialer både i produktene og forpakningen.

D-Link anbefaler at du alltid slår av eller frakobler D-Link-produkter når de ikke er i bruk. Ved å gjøre dette hjelper du å spare energi og å redusere CO2-utslipp.

For mer informasjon angående våre miljøansvarlige produkter og forpakninger kan du gå til www.dlinkgreen.com.

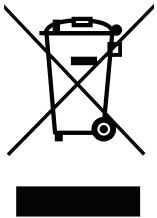
DANSK**DK**

Dette symbol på produktet eller emballagen betyder, at dette produkt i henhold til lokale love og regler ikke må bortskaffes som husholdningsaffald, mens skal sendes til genbrug. Indlever produktet til et indsamlingssted som angivet af de lokale myndigheder, når det er nået til slutningen af dets levetid. I nogle tilfælde vil produktet blive modtaget gratis. Ved at indlevere produktet og dets emballage til genbrug på denne måde bidrager du til at beskytte miljøet og den menneskelige sundhed.

D-Link og miljøet

Hos D-Link forstår vi og bestræber os på at reducere enhver indvirkning, som vores aktiviteter og produkter kan have på miljøet. For at minimere denne indvirkning designer og producerer D-Link sine produkter, så de er så miljøvenlige som muligt, ved at bruge genanvendelige materialer med lavt giftighedsniveau i både produkter og emballage.

D-Link anbefaler, at du altid slukker eller frakobler dine D-Link-produkter, når de ikke er i brug. Ved at gøre det bidrager du til at spare energi og reducere CO₂-udledningerne.

Du kan finde flere oplysninger om vores miljømæssigt ansvarlige produkter og emballage på www.dlinkgreen.com.

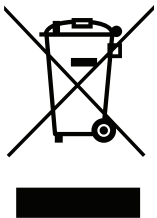
SUOMI**FI**

Tämä symboli tuotteen pakkauksessa tarkoittaa, että paikallisten lakien ja säännösten mukaisesti tätä tuotetta ei pidä hävittää yleisen kotitalousjätteen seassa vaan se tulee toimittaa kierrätettäväksi. Kun tuote on elinkaarensa päässä, toimita se lähimpään viranomaisten hyväksymään kierrätyspisteeseen. Kierrättämällä käytetyn tuotteen ja sen pakkauksen autat tukemaan sekä ympäristön että ihmisten terveyttä ja hyvinvointia.

D-Link ja ympäristö

D-Link ymmärtää ympäristönsuojelun tärkeyden ja on sitoutunut vähentämään tuotteistaan ja niiden valmistuksesta ympäristölle mahdollisesti aiheutuvia haittavaikutuksia. Nämä negatiiviset vaikutukset minimoidakseen D-Link suunnittelee ja valmistaa tuotteensa mahdollisimman ympäristöystävällisiksi käyttämällä kierrätettäviä, alhaisia pitoisuuksia haitallisia aineita sisältäviä materiaaleja sekä tuotteissaan että niiden pakkauksissa.

Suosittelomme, että irrotat D-Link-tuotteesi virtalähteestä tai sammutat ne aina, kun ne eivät ole käytössä. Toimimalla näin autat säästämään energiaa ja vähentämään hiilidioksiidipäästöjä.

Lue lisää ympäristöystävällisistä D-Link-tuotteista ja pakkauksistamme osoitteesta www.dlinkgreen.com.

SVENSKA**SE**

Den här symbolen på produkten eller förpackningen betyder att produkten enligt lokala lagar och föreskrifter inte skall kastas i hushållssoporna utan i stället återvinnas. Ta den vid slutet av dess livslängd till en av din lokala myndighet utsedd uppsamlingsplats, vissa accepterar produkter utan kostnad. Genom att på detta sätt återvinna produkten och förpackningen hjälper du till att bevara miljön och skydda människors hälsa.

D-Link och miljön

På D-Link förstår vi och är fast beslutna att minska den påverkan våra verksamheter och produkter kan ha på miljön. För att minska denna påverkan utformar och bygger D-Link sina produkter för att de ska vara så miljövänliga som möjligt, genom att använda återvinningsbara material med låg gifthalt i både produkter och förpackningar.

D-Link rekommenderar att du alltid stänger av eller kopplar ur dina D-Link produkter när du inte använder dem. Genom att göra detta hjälper du till att spara energi och minska utsläpp av koldioxid.

För mer information om våra miljöansvariga produkter och förpackningar www.dlinkgreen.com.

PORTUGUÊS**PT**

Este símbolo no produto ou embalagem significa que, de acordo com as leis e regulamentações locais, este produto não deverá ser eliminado juntamente com o lixo doméstico mas enviado para a reciclagem. Transporte-o para um ponto de recolha designado pelas suas autoridades locais quando este tiver atingido o fim da sua vida útil, alguns destes pontos aceitam produtos gratuitamente. Ao reciclar o produto e respectiva embalagem desta forma, ajuda a preservar o ambiente e protege a saúde humana.

A D-Link e o ambiente

Na D-Link compreendemos e comprometemo-nos com a redução do impacto que as nossas operações e produtos possam ter no ambiente. Para minimizar este impacto a D-Link concebe e constrói os seus produtos para que estes sejam o mais inofensivos para o ambiente possível, utilizando materiais recicláveis e não tóxicos tanto nos produtos como nas embalagens.

A D-Link recomenda que desligue os seus produtos D-Link quando estes não se encontrarem em utilização. Com esta acção ajudará a poupar energia e reduzir as emissões de CO₂.

Para saber mais sobre os nossos produtos e embalagens responsáveis a nível ambiental visite www.dlinkgreen.com.