

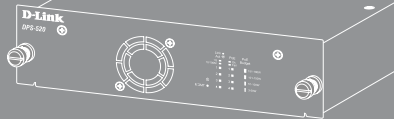

Quick Installation Guide for Redundant Power System

DPS-520



Information in this document is subject to change without notice. Reproduction in any manner whatsoever, without the written permission of D-Link Corporation, is strictly forbidden.
Trademarks used in this text: D-Link and the D-LINK logo are trademarks of D-Link Corporation; Microsoft and Windows are registered trademarks of Microsoft Corporation.
Other trademarks and trade names may be used in this document to refer to either the entities claiming the marks and names or their products. D-Link Corporation disclaims any proprietary interest in trademarks and trade names other than its own.

© 2020 D-Link Corporation. All rights reserved.

FCC Compliance Statement

This device complies with Part 15 of the FCC Rules. Operation is subject to the following two conditions: (1) This device may not cause harmful interference, and (2) this device must accept any interference received, including interference that may cause undesired operation.

D-Link Corporate
17595 Mt. Hermann Street
Fountain Valley, CA 92708
(800) 326-1688

CE Mark Warning

This equipment is compliant with Class A of CISPR 32. In a residential environment, this equipment may cause radio interference.

Avertissement Concernant la Marque CE

Cet équipement est conforme à la classe A de la norme CISPR 32. Dans un environnement résidentiel, cet équipement peut provoquer des interférences radio.

VCCI Warning

この装置は、クラスA機器です。この装置を住宅環境で使用すると電波妨害を引き起こすことがあります。この場合には使用者が適切な対策を講ずるよう要求されることがあります。 VCCI-A

BSMI Notice

此為甲類資訊技術設備，於居住環境中使用時，可能會造成射頻擾動，在此種情況下，使用者會被要求採取某些適當的對策。

About This Guide

The D-Link DPS-520 is a Redundant Power System (RPS) provides an affordable, 90 Watt, Power over HDBaseT (PoH), rack-mountable, RPS solution. This guide provides step-by-step instructions to setup the RPS and install it to a switch that supports incoming PoH.

Please note that the model you have purchased may appear slightly different from those shown in the illustrations. For more detailed information about your product, its components, making connections, and technical specifications, please refer to the User's Guide included with your product.

Introduction

The DPS-520 provides an effective solution when the internal power supply of a switch in the network fails, which can result in the shutdown of a single switching device or an entire network.

With an RPS connected, an integrated detection circuit continuously monitors the switch's internal power supply. In the event of a power interruption, the RPS is immediately triggered so that the switch and connected devices can continue providing services. This results in a more reliable network infrastructure and protects the network from a single failure of a network device power supply.

Description

The DPS-520 is an RPS unit features four Gigabit Ethernet 90W PoH ports and one Gigabit Ethernet Management port (MGMT). It is designed to conform to the power requirements of the switches being supported.

Using PoH, it connects to a PoH-enabled switch using a standard Ethernet UTP/STP cable. A standard, three-pronged AC power cable connects the RPS to the main power source.

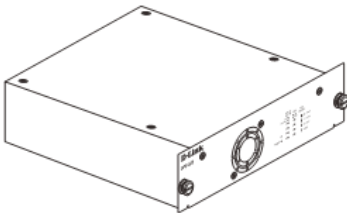

Figure 1 - Front View of the DPS-520

Rack Installation

The DPS-520 can be installed on a desktop or into a standard switch rack by inserting it into an additional DPS-800.

The DPS-800 is a standard-size rack mount (1.25U height) designed to hold up to two RPS units.

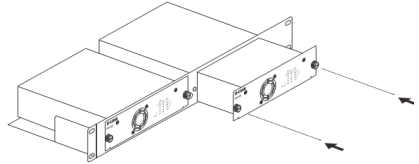

Figure 2 - Installing the DPS-520 into the DPS-800

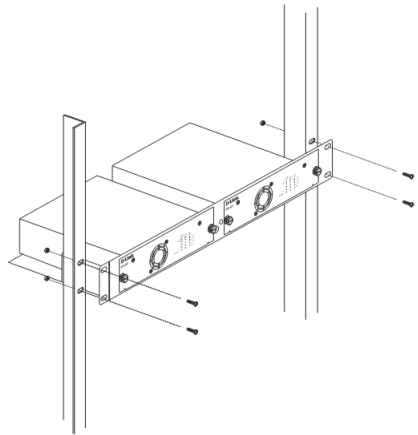

Figure 3 - Installing the DPS-800 in a standard switch rack

Switch Connection

Only the LAN ports 1 to 4 can supply power to switches. Insert one end of the DC-powered, PoH, Ethernet cable into one of the LAN ports on the DPS-520 and insert the other end into the PoH-capable input port on the switch (usually the MGMT port).

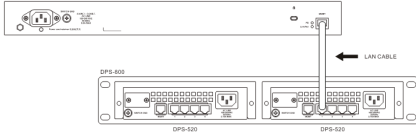

Figure 4 - Connecting the DPS-520 to a PoH-enabled switch

The MGMT port on the DPS-520 cannot supply power to a switch and is usually used for the connection to the management PC.

Power Connection

Connecting AC Power to the RPS Using a standard AC power cable, connect the RPS to the main AC power source. A green LED on the front of the RPS will glow to indicate a successful connection.

Product Specification

Specification	DPS-520
AC Input Voltage	100 ~ 240 VAC
AC Input Frequency	50 ~ 60 Hz
Operating Temperature	0 ~ 50 °C

Table 1 - Product Specifications

RPS Cable Pin Assignment

Any standard Category 5e or higher Ethernet cable can be used to connect the RPS to the switch where the RPS supplies PoH power to the switch. The following illustrates the RJ45 PoH receptacle/connector and pin assignments.

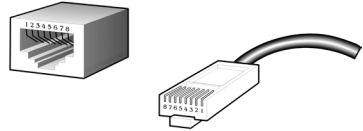

Figure 5 - RJ45 PoH Pin Assignment

Pin	Description	
1	Rx A+	Receive data
	DC-	Feeding power (-) 48 V
2	Rx A-	Receive data
	DC-	Feeding power (-) 48 V
3	Tx B+	Transmit data
	DC+	Feeding power (+) 0 V
4	BI C+	Bidirectional data
	DC+	Feeding power (+) 0 V
5	BI C-	Bidirectional data
	DC+	Feeding power (+) 0 V
6	Tx B-	Transmit data
	DC+	Feeding power (+) 0 V
7	BI D+	Bidirectional data
	DC-	Feeding power (-) 48 V
8	BI D-	Bidirectional data
	DC-	Feeding power (-) 48 V

Table 2 - RJ45 PoH Pin Assignment

Web User Interface

The Web User Interface (Web UI) provides access to the software features available on the RPS. These features can be accessed on the LAN ports or the MGMT port using any standard web browser, like Microsoft's Internet Explorer, Mozilla Firefox, Google Chrome, or Safari.

Connecting to the Web UI

To access the Web UI, open a standard web browser, enter the IP address of the RPS into the address bar of the browser, and press the Enter key.



Figure 6 - IP address in Internet Explorer

NOTE: The default IP address of the DPS-520 is 10.90.90.90 (subnet mask 255.0.0.0).

After successfully connecting to the Web UI, the following is displayed:

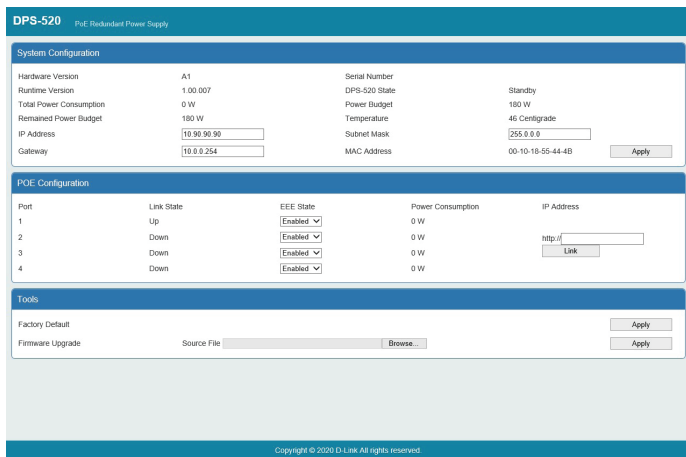
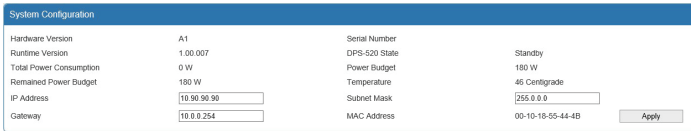

Figure 7 - Web User Interface (Web UI)

System Configuration

The IP Address, Subnet Mask, and Gateway IP address can be configured here. Click the Apply button to apply the changes.



System Configuration			
Hardware Version	A1	Serial Number	
Runtime Version	1.00.007	DPS-520 State	Standby
Total Power Consumption	0 W	Power Budget	180 W
Remained Power Budget	180 W	Temperature	46 Centigrade
IP Address	<input type="text" value="10.90.90.90"/>	Subnet Mask	<input type="text" value="255.0.0.0"/>
Gateway	<input type="text" value="10.0.0.254"/>	MAC Address	00-10-18-55-44-4B
			<input type="button" value="Apply"/>

Figure 8 - System Configuration

Additional system information is displayed in this section like Hardware Version, Serial Number, Runtime Version, DPS-520 State, Total Power Consumption, Power Budget, Remaining Power Budget, Temperature and the MAC Address of the RPS.

PoE Information

The EEE State and the Link IP address can be configured here. Enter the IP Address of a device, connected to the RPS, and click the Link button to open a new tab in the web browser to initiate an HTTP connection to the specified IP address.



PoE Configuration				
Port	Link State	EEE State	Power Consumption	IP Address
1	Up	<input type="button" value="Enabled"/>	0 W	
2	Down	<input type="button" value="Enabled"/>	0 W	<input type="text" value="http://"/>
3	Down	<input type="button" value="Enabled"/>	0 W	<input type="button" value="Link"/>
4	Down	<input type="button" value="Enabled"/>	0 W	

Figure 9 - PoE Information

Additional PoE information is displayed in this section like Port number, Link Status, and Power Consumption.

Tools

Click the Apply button, next Factory Default, to reset the software on the RPS back to the factory default configuration.

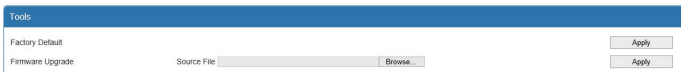

Tools	
Factory Default	<input type="button" value="Apply"/>
Firmware Upgrade	Source File <input type="text"/> <input type="button" value="Browse"/> <input type="button" value="Apply"/>

Figure 10 - Tools

Firmware Upgrade: To upgrade the firmware, click the Browse button, navigate to the new firmware file, and click the Apply button to upgrade the firmware on the RPS.

Important: The DPS-520 needs to be restarted for the software changes to take effect. To restart the DPS-520, the AC power cord needs to be removed and then re-inserted into the AC power port on the back panel.

Additional Information

Additional help is available through our offices listed at the back of the user manual or online. To find out more about D-Link products or marketing information, please visit the website: <http://www.dlink.com>

Warranty Information

The D-Link Limited Lifetime Warranty information is available at <http://warranty.dlink.com/>

Safety Instructions

The following general safety guidelines are provided to help ensure your own personal safety and protect your product from potential damage. Remember to consult the product user instructions for more details.

- Static electricity can be harmful to electronic components. Discharge static electricity from your body (i.e. touching grounded bare metal) before touching the product.
- Do not attempt to service the product and never disassemble the product. For some products with a user replaceable battery, please read and follow the instructions in the user manual.
- Do not spill food or liquid on your product and never push any objects into the openings of your product.
- Do not use this product near water, areas with high humidity, or condensation unless the product is specifically rated for outdoor application.
- Keep the product away from radiators and other heat sources.
- Always unplug the product from mains power before cleaning and use a dry lint free cloth only.

European Community Declaration of Conformity

D-Link hereby declares that this product, accessories, and software are in compliance with directive 2014/53/EU. More information about EU Declaration of Conformity please visit www.dlink.com/cedoc

