



User Manual

20 km Long Range 802.11ac Wireless Bridge

DAP-3712

Table of Contents

Product Overview	3	System	37
Package Contents.....	3	Status	39
System Requirements	4	Info	39
Introduction	5	Statistics	41
Features.....	6	Network.....	42
Hardware Overview	7	Syslog Info	43
Connection	7	Tools	44
LED Indicators	8	Ping IP	44
Installation	9	Traceroute	45
Assembling the Access Point.....	9	Link Test.....	46
Preparation before Installation.....	11	Antenna Alignment	47
Powering the Access Point	12	Spectrum Analyzer.....	48
Configuring the First DAP-3712 in Access Point		Technical Specifications	49
Mode	12		
Configuring the Second DAP-3712 in Client Mode	14		
Mounting the Device	15		
Mounting on a Pole	15		
Configuration	17		
Factory Default Setting	17		
Web-based Configuration	18		
Wizard	20		
Basic Settings	23		
Wireless	23		
Network.....	29		
QoS.....	31		
Service	34		

Package Contents



DAP-3712 20 km Long Range 802.11ac Wireless Bridge



Power Injector

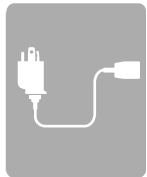

Power cord

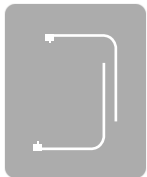

Mounting tie



Quick Start Guide

System Requirements

**Web-based Configuration
Requirements**

Computer with the following:

- Microsoft Windows®, Apple Mac OS, or a Linux-based operating system

Browser Requirements:

- Microsoft Edge, Firefox 60.0, Safari ,or Chrome 68.0.3440.106

Introduction

The DAP-3712 is a high-performance 802.11ac 2T2R outdoor-deployable wireless bridge that provides wireless connectivity to multiple network locations. The DAP-3712 has a built-in 23 dBi dish antenna that can deliver connectivity at a distance of up to 20 km.

Note: Actual data throughput will vary. Network conditions and environmental factors, including volume of network traffic, building materials and construction, and network overhead, lower actual data throughput rate.

Features

- High-performance 802.11ac 2×2 chip
- Max. transmission range: 20 km
- Max. transmission throughput: up to 867 Mbps
- Integrated TDMA, intelligent rate control, and Auto ACK timeout
- TDMA solves the hidden-node problem in 802.11 networks
- Supports 4 operation modes: Access Point, Client, WDS Access Point, WDS Client
- Supports point-to-point and point-to-multipoint connections
- Unique RF and antenna design enable long-range transmission
- Wireless multimedia optimization technology guarantees video/audio transmission QoS
- User-friendly web-based UI makes the installation and setup processes much easier
- Reliable PoE+ 802.3at standard power input
- Waterproof housing and protection from weather

Hardware Overview

Connection

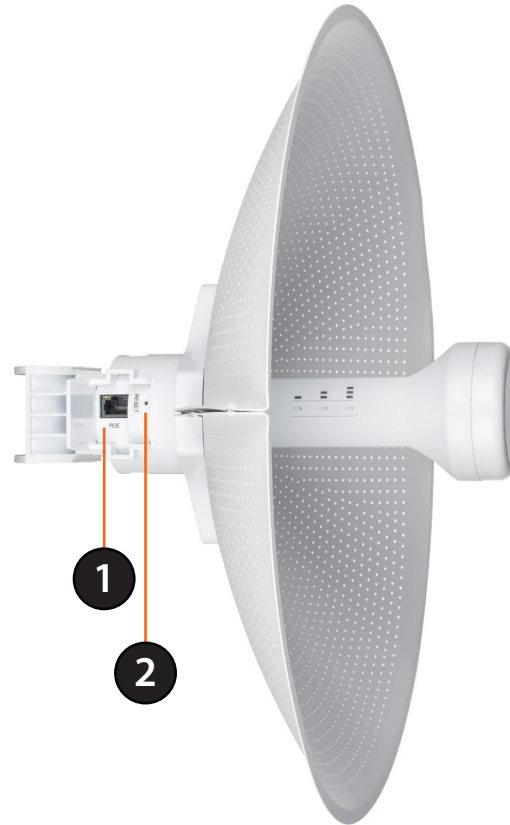

1	PoE Port	Uses a standard Ethernet cable to connect the device to a PoE power source such as a PoE switch or PoE injector.
2	Reset Button	Resets the device to its factory settings.

Hardware Overview

LED Indicators

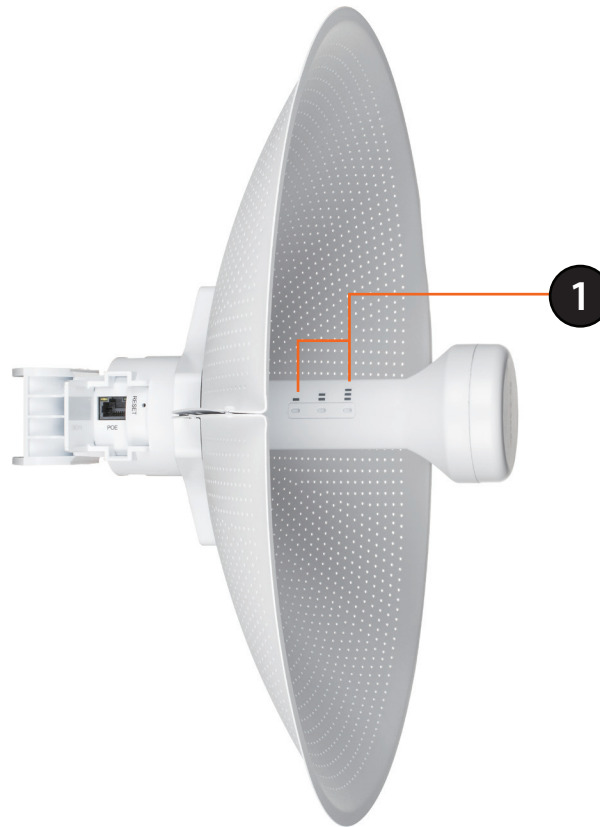

1	Signal Strength	Signal strength indicators. One light indicates a weak signal. Two lights indicate a medium signal. Three lights indicate a strong signal.
---	------------------------	--

Installation

Assembling the Access Point

1. Assemble the dish of the DAP-3712 by sliding the two halves together until they lock in place.

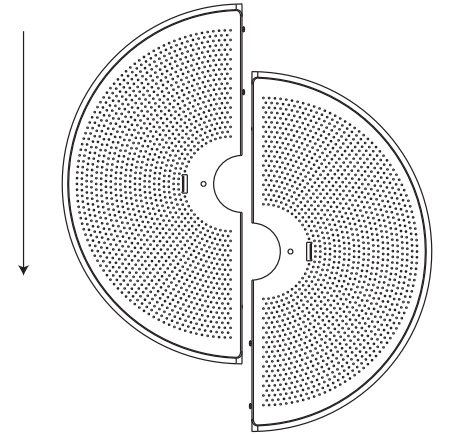

2. Connect the antenna and base through the hole in the center of the dish.

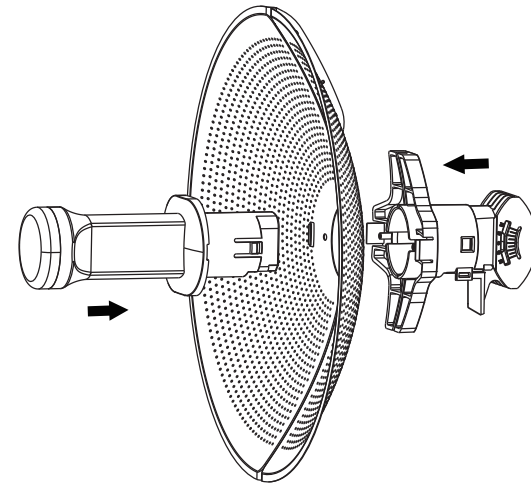

3. Thread a standard RJ-45 Ethernet cable through the cover for the PoE port on the underside of the DAP-3712. Insert the cable into the PoE port, then attach the cover to the device.

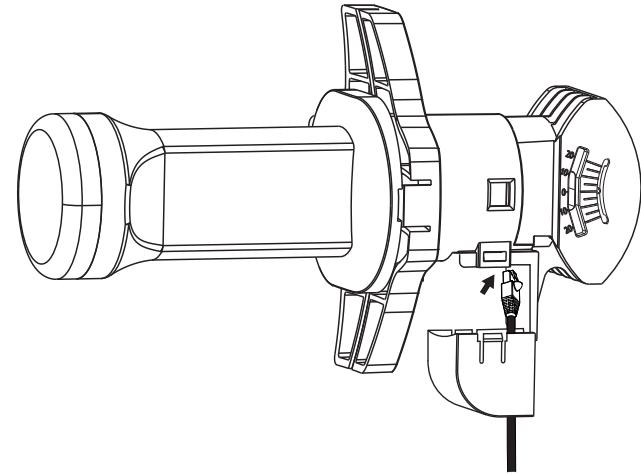

4. Connect the adjustment kit to the base of the DAP-3712 by pressing it in until it clicks and locks in place. Use the adjustment kit to position the antenna at the desired.

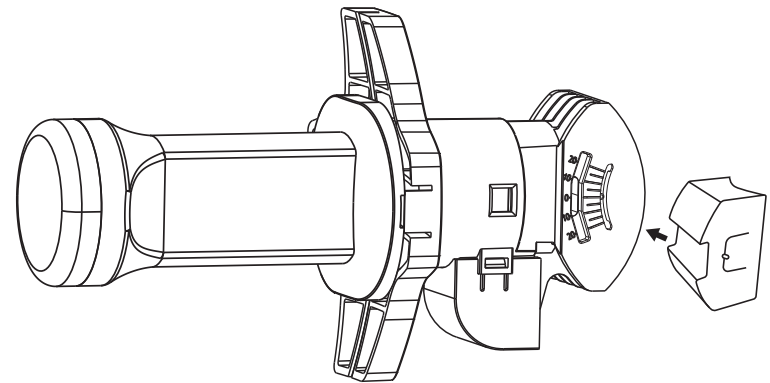

Preparation before Installation

Before installing the DAP-3712, check the distance between the two sides and ensure that they are within wireless signal range of each other. It may be helpful to use a Graphic Information System (GIS) program such as Google Earth to check for obstructions between the two sites. If there is an obstruction, it may help to install the DAP-3712 as high as possible to prevent the signal from being blocked.

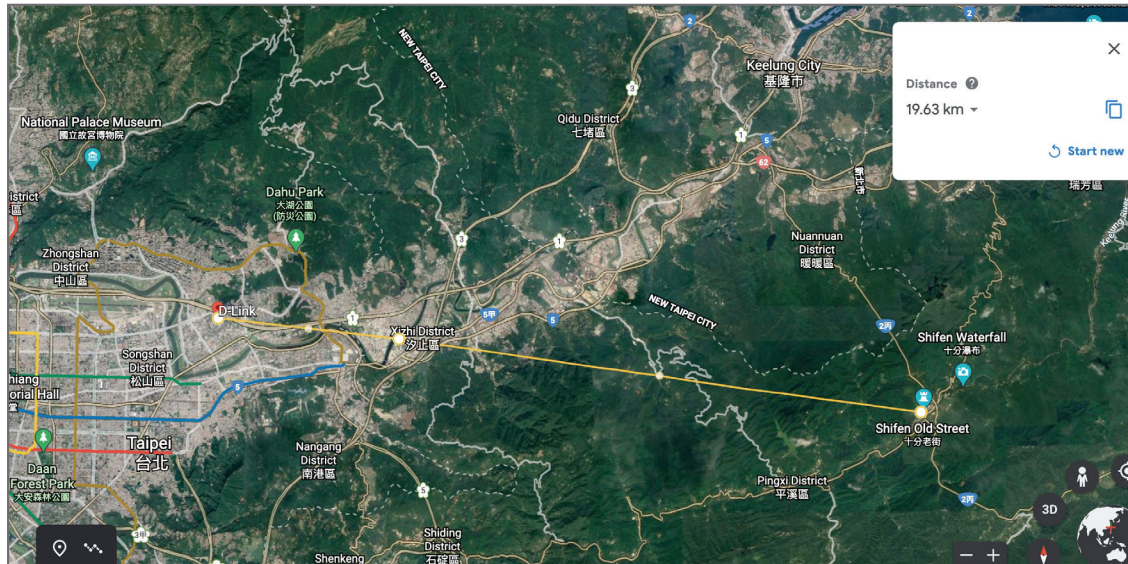

Note: Ensure that both devices have the same model number and are running the same firmware version. The radiation pattern and wireless protocol of the DAP-3712 is designed for high-performance bridge connectivity. Using different models or models with mismatched firmware versions may cause problems, such as performance degradation or a reduction in coverage area.

Powering the Access Point

To power the DAP-3712, use a standard Ethernet cable to connect the PoE port on the DAP-3712 to a 48 V PoE injector.

Cable Requirements

Use a CAT 5 cable with an even sheath. The Ethernet ports on the DAP-3712 access point cannot accept a CAT 5 cable that has an uneven sheath; the RJ-45 connector on the cable will not fit properly into the receptacle on the access point.

Configuring the First DAP-3712 in Access Point Mode

1. Use an Ethernet cable to connect the LAN port on the DAP-3712 to the PoE Out port on the PoE injector. Using another cable, attach the PoE injector to your switch or management computer.
2. Ensure the computer is configured with the static IP address **192.168.0.2** and a subnet mask of **255.255.255.0**.
3. Launch a web browser. Enter **192.168.0.50** in the address field of your browser.

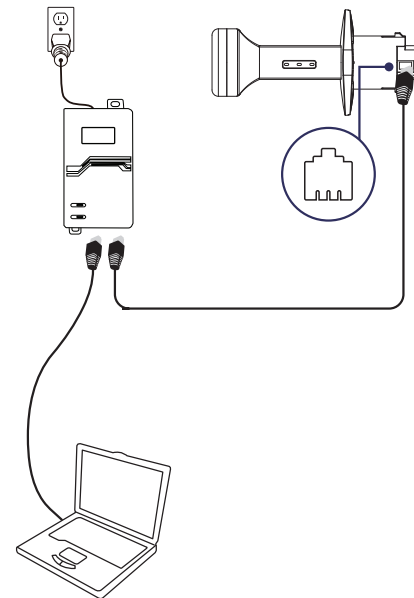

4. Log in to the administration user interface. The default login information is:

Username: **admin**

Password: **admin**

5. Follow the Setup Wizard's instructions to configure the device in Access Point Mode.

The screenshot shows the 'Wireless(5Gwifi)' configuration page. The 'Mode' dropdown menu is open, showing 'Access Point' as the selected option. The 'SSID' field is also highlighted. Other visible fields include 'Channel Width', 'Channel', 'Transmit Power', 'Encryption', and 'Key'.

Field	Value
Mode	Access Point
SSID	Access Point
Channel Width	Client
Channel	Access Point(WDS)
Transmit Power	Client(WDS)
Encryption	WPA2-PSK
Key

Configuring the Second DAP-3712 in Client Mode

1. Follow steps 1-4 of the instructions above to power on the device. Launch the Setup Wizard to configure the device in Client Mode.
2. To avoid an IP address conflict, change the IPv4 address so that it is different from the first DAP-3712's IP address (for instance, by changing it to **192.168.0.51**, as in the following screenshot).
3. On step four of the Setup Wizard (Wireless), select **Client** from the drop-down list. Enter the same SSID and key that you entered when configuring the first device.
4. To confirm that wireless connectivity between the two devices is configured correctly, navigate to the **Status** page and check the information under **Associated Stations** (shown below).

IPv4 Protocol: Static IP

IPv4 Address: 192.168.0.51

IPv4 Netmask: 255.255.255.0

Default Gateway:

Wireless(5Gwifi)

1 Mode: Client

2 SSID: dlink

Channel Width: Auto

Channel: Auto

Transmit Power: 8

Encryption: WPA2-PSK

3 Key:

Wireless

WiFi1

SSID: SunnyTest Distance: 0.15 km

Mode: Client CQI / Noise Floor: 100% / -100 dBm

BSSID: SC8793F3CA72 Signal Noise Ratio: -52 / -100 dBm

Country: United Kingdom Transmit Power: 8 dBm

Channel Width: 80 MHz

Channel: 5503.0MHz (100)

802.11 Mode: 802.11ac

Encryption: WPA2-PSK

Associated Stations

SSID	RSSI/Noise	IPv4 Address	Encryption	MAC	TX/RX Rate	CQI	802.11 Mode	Association Time
SunnyTest	-52/-100	0.194.134	WPA2-PSK	SC8793F3CA72	866.7 Mbps / 866.7 Mbps	undefined dB	802.11ac	00:00:34

©2020 Dlink Digital Technology Co., Ltd. All Rights Reserved.

Mounting the Device

If you plan to install the DAP-3712 on a pole, orient the front of the device (the dish and antenna) toward the intended coverage area.

The antenna only transmits data in the direction it is pointed. Be sure to install the device at a height that ensures that the alignment between the devices is visible and there are no obstructions in the middle.

Note: The DAP-3712 is designed to receive PoE power from an 802.3at-compliant source. Connecting the DAP-3712 to a PoE device that is not approved by D-Link can damage the equipment.

Mounting on a Pole

1. Hold the DAP-3712 against the pole in the desired position.

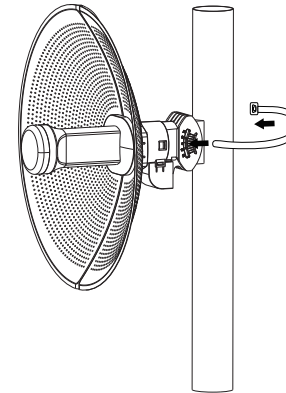

2. Thread the metal mounting tie through the hole on the base of the DAP-3712 and wrap it around the pole. Fasten the tie to secure the device against the pole.

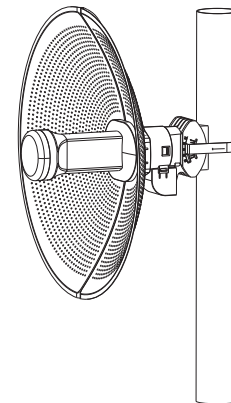

Section 2 - Installation

Once completed, your network will resemble the following diagram.

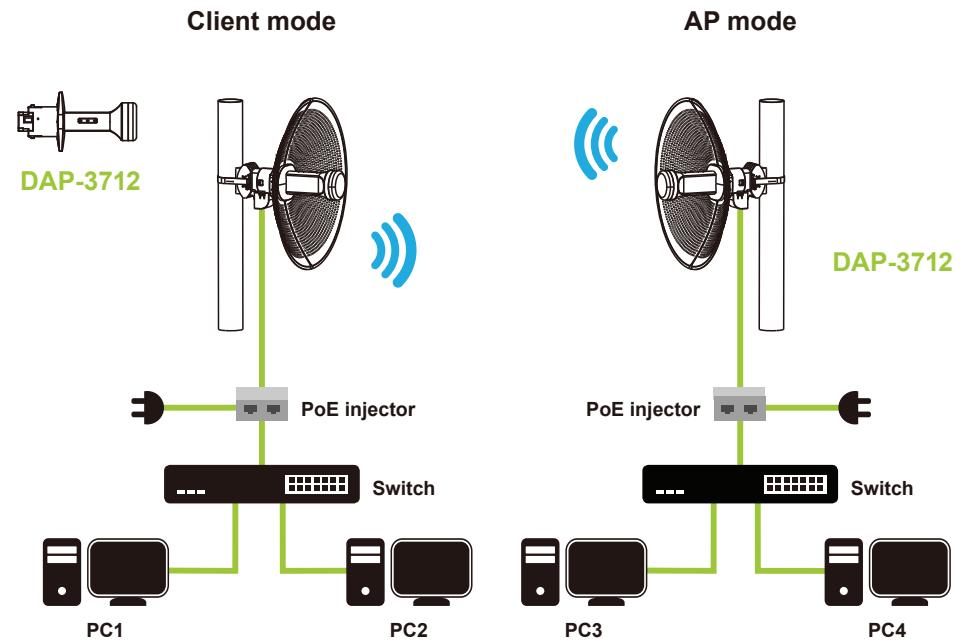

Configuration

This section will show you how to configure your New D-Link DAP-3712 using the web-based configuration utility.

Factory Default Setting

The following table shows the DAP-3712's default settings.

Features	Factory Default Setting
Username	admin
Password	admin
Operation Mode	Bridge
Wi-Fi Mode	Access Point
SSID	dlink
Encryption	WPA2-PSK
Key	1234567890abc
LAN	IP: 192.168.0.50 Subnet: 255.255.255.0 Gateway: 192.168.0.1
DHCP Server	disable
802.11 mode	802.11 ac
Channel	auto
Bandwidth	80 MHz
TDMA	disable

Web-based Configuration

To log in the DAP-3712 web interface, you will need to configure your computer's TCP/IP settings:

1. Right-click the **Local Area Connection** icon on your computer and click **Properties**, then click **Continue**. The **Local Area Connection Properties** dialog box will appear, as seen below.

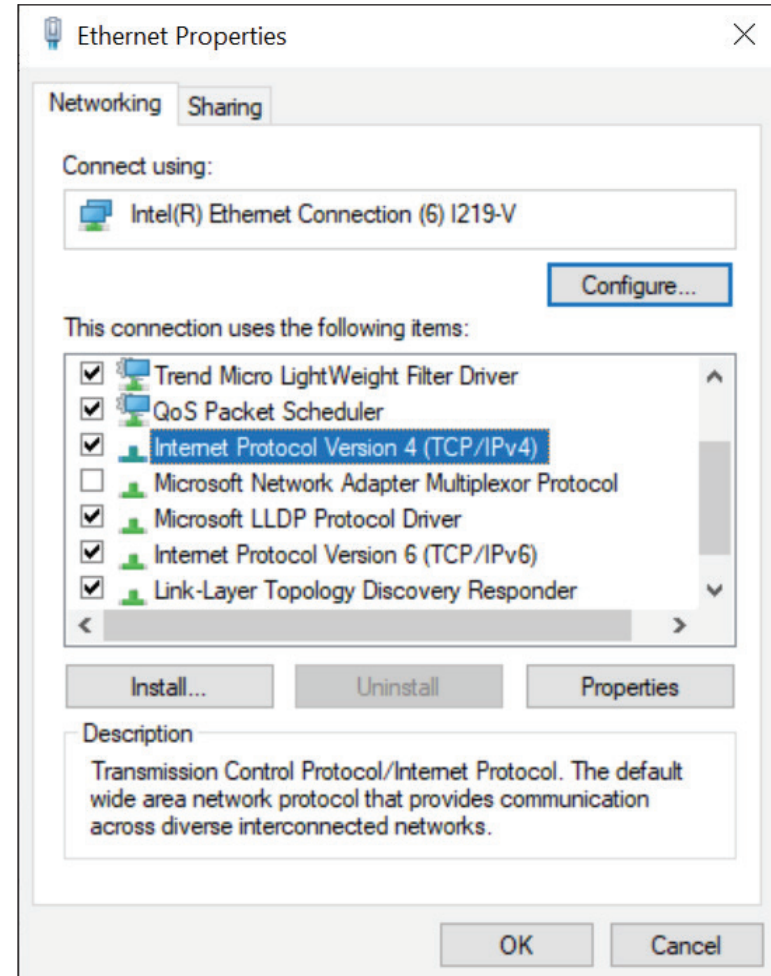

2. Select **Internet Protocol (TCP/IP)** and click the **Properties** button, and the following dialog box will appear:

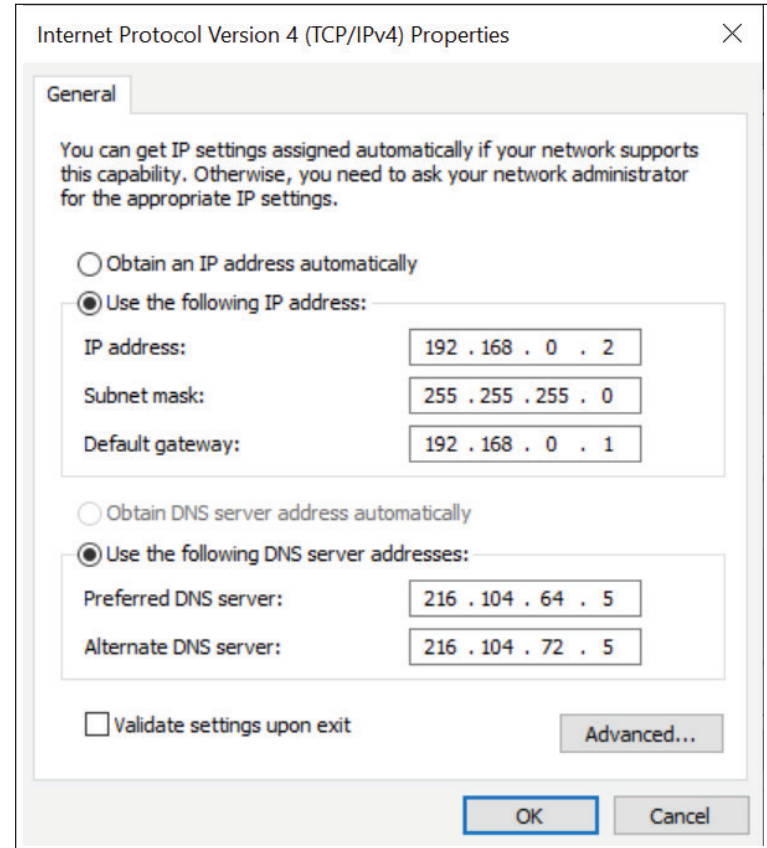

3. In the above figure, the **IP address** should be set to **192.168.0.***. Here, * can be any number between 1-255 (but not 50, since the DAP-3712's default IP address is 192.168.0.50).

- When you are done configuring the IP settings above, enter the default IP address (**192.168.0.50**) into the address bar of your web browser, and the following login interface will appear.

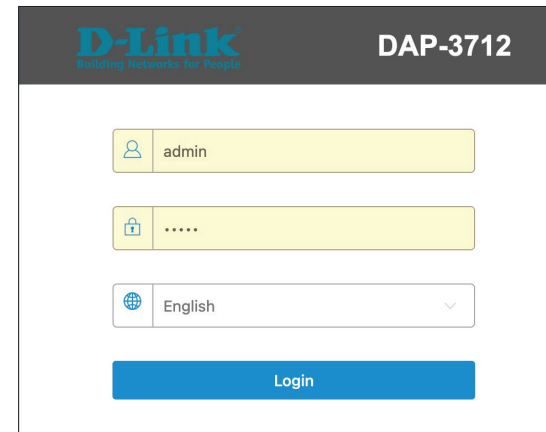

The image shows the login interface for the D-Link DAP-3712. It features the D-Link logo and the device name 'DAP-3712' at the top. Below the logo, there are three input fields: a username field containing 'admin', a password field with masked characters '.....', and a language selection dropdown menu currently set to 'English'. A blue 'Login' button is positioned at the bottom of the form.

Wizard

When you log into the DAP-3712 for the first time, the Wizard page will automatic pop-up. You can also click **Wizard** in the top right corner.

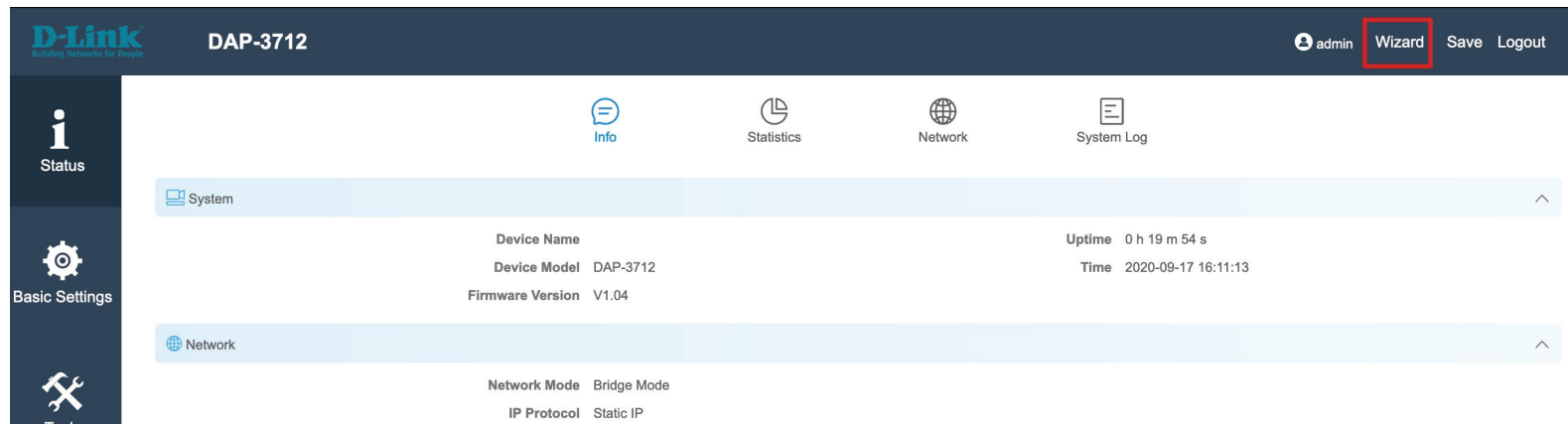

The image displays the main dashboard of the D-Link DAP-3712. The top navigation bar includes the D-Link logo, the device name 'DAP-3712', and user options: 'admin', 'Wizard' (highlighted with a red box), 'Save', and 'Logout'. Below the navigation bar, there are four main menu items: 'Info', 'Statistics', 'Network', and 'System Log'. The main content area is divided into two sections: 'System' and 'Network'. The 'System' section displays the following information:

Device Name		Uptime	0 h 19 m 54 s
Device Model	DAP-3712	Time	2020-09-17 16:11:13
Firmware Version	V1.04		

The 'Network' section displays the following information:

Network Mode	Bridge Mode
IP Protocol	Static IP

To configure the device, follow these steps:

1. Change password

If this is the first time you have logged into the DAP-3712, you will need to change the password. The default password is **admin**.

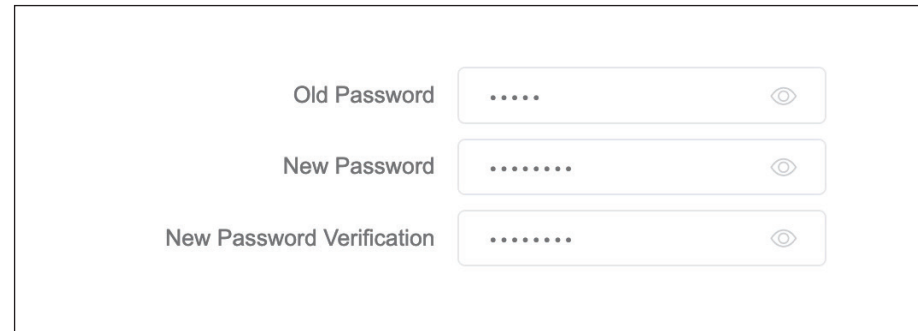

The screenshot shows a configuration screen with three password input fields. Each field has a label on the left and a text input box on the right with a small eye icon for toggling visibility. The fields are: 'Old Password' with five dots, 'New Password' with seven dots, and 'New Password Verification' with seven dots.

2. Country

On the next screen, select your country.

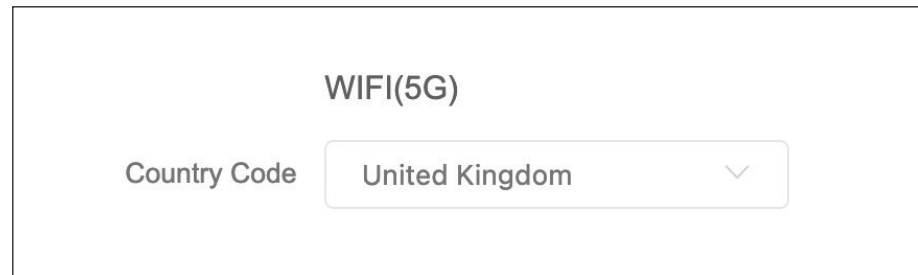

The screenshot shows a configuration screen titled 'WIFI(5G)'. Below the title is a 'Country Code' dropdown menu. The dropdown is currently set to 'United Kingdom' and has a downward-pointing arrow on the right side.

3. Network

You can change the IP address of the DAP-3712. The default IP is **192.168.0.50**. Click **Next** to advance to the next page.

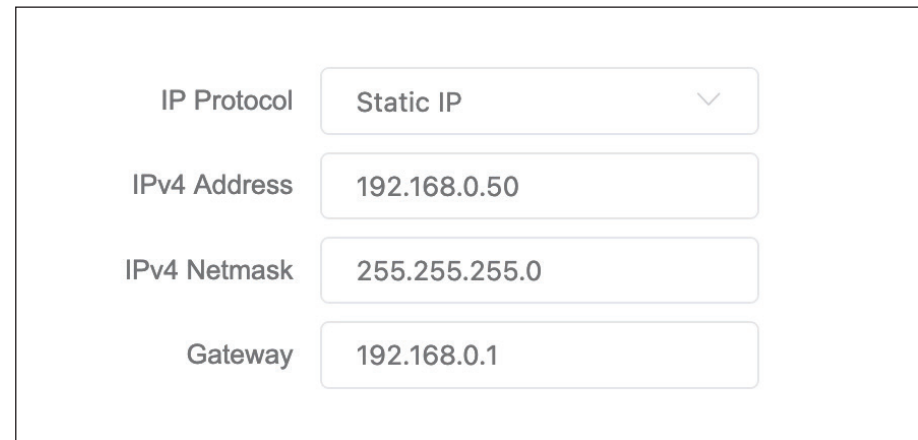

The screenshot shows a configuration screen for network settings. It contains four rows of settings, each with a label on the left and a value in a text box on the right. The settings are: 'IP Protocol' set to 'Static IP' (with a dropdown arrow), 'IPv4 Address' set to '192.168.0.50', 'IPv4 Netmask' set to '255.255.255.0', and 'Gateway' set to '192.168.0.1'.

4. Wireless

Wireless Mode: There are four wireless modes: **Access Point**, **Client**, **Access Point (WDS)**, and **Client (WDS)**. To use a point-to-point or point-to-multipoint connection, you need to configure the primary DAP-3712 in **Access Point** or **Access Point (WDS)** mode and the other DAP-3712s in **Client** mode or **Client (WDS)** mode.

If you want to preserve MAC address of clients frame, it is suggested to use Access Point(WDS) and Client (WDS) for each size.

SSID: You can set the SSID which the device will broadcast when **Access Point** or **Access Point (WDS)** is selected. Alternately, set the SSID of the remote site when **Client** or **Client (WDS)** is selected. The default SSID is **dlink**.

Channel Width: Use this to select the channel bandwidth of the DAP-3712. The default is 80 Mhz.

Frequency (Channel): Use this to select the Wi-Fi channel the AP will broadcast on. The available channels depend on the county you selected.

Transmit Power: Use this to set the DAP-3712's output power.

Encryption: You can select which Wi-Fi encryption the DAP-3712 should use: Open, WPA-PSK, WPA2-PSK, WPA/WPA2 Hybrid-PSK, or IEEE802.1X.

Key: To input the WiFi encryption key. The default key is 1234567890abc

The screenshot shows the 'Wireless(5Gwifi)' configuration page. It includes the following settings:

- Wireless Mode:** Access Point (dropdown menu)
- SSID:** dlink (text input field)
- Channel Width:** 80 MHz (dropdown menu)
- Frequency(Channel):** auto (dropdown menu)
- Transmit Power:** 23 (slider control)
- Encryption:** WPA2-PSK (dropdown menu)
- Key:** (password input field with an eye icon for visibility toggle)

Basic Settings

This section will introduce how to navigate the **Basic Settings** page. On this page, there are Five tabs: **Wireless**, **Network**, **QoS**, **Service**, and **System**.

After making changes, click **Save** to apply them.



Wireless

In the **Wireless** tab, you can configure the DAP-3712's Wi-Fi and radio settings.

Wireless Settings: Toggle the button to enable or disable Wi-Fi.

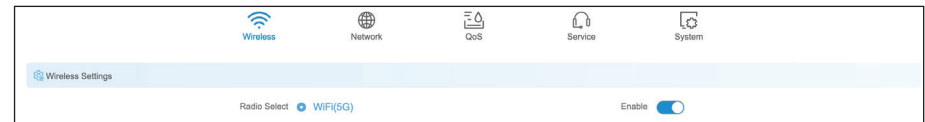

Section 3 - Configuration

Radio Setting: In this section, users can set up basic and advanced Wi-Fi and radio settings.

Basic Settings

Country Code: Use this to select the country where the DAP-3712 is installed.

Channel Width: Use this to change the AP's channel width. The default is 80 MHz.

Frequency: Use this to specify the Wi-Fi channel to use, or select Auto to determine this automatically.

Automatic Channel List: If you select Auto in Frequency, you can decide which channels to operate here. The available channels will depend on your country.

Transmit Power: The device's output power. When the output power is increased, the signal distance and signal strength will be improved.

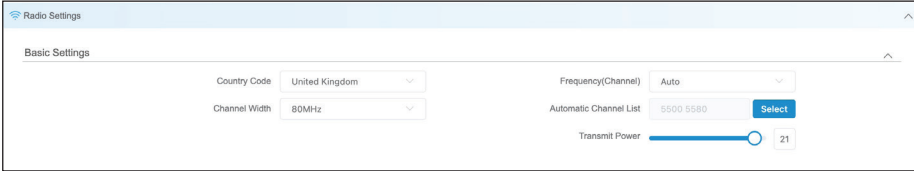

The screenshot displays the 'Radio Settings' window, specifically the 'Basic Settings' section. It features several configuration options: 'Country Code' is set to 'United Kingdom', 'Channel Width' is set to '80MHz', 'Frequency(Channel)' is set to 'Auto', and 'Automatic Channel List' is set to '5500 5580' with a 'Select' button. The 'Transmit Power' is represented by a slider set to '21'.

Advanced Settings

802.11 Mode: You can select the 802.11 mode which the DAP-3712 should use. It is suggested to keep this setting at 802.11ac to provide an optimal transmission rate.

Max Tx Rate: This can be used to limit the maximum transmission rate of the device.

MIMO: The DAP-3712 supports 2T2R Multi-Input-Multi-Output. In high-interference environments, you can set this to 1T1R to reduce the noise.

Auto ACK: Enabling this function will automatically detect the distance between the two DAP-3712 units and optimize the link quality. Enabling this is recommended. If you disable this function, you will need to manually enter the distance between the two units.

TDMA+: To use TDMA, you will need to enable TDMA mode in both DAP-3712 units. TDMA can prevent 802.11 hidden node issues. When setting up PTMP, enabling TDMA+ is recommended. The TDMA+ function can only work between two DAP-3712 units.

When TDMA+ is enabled, you can also decide whether you want to enable JTrans. JTrans can help prevent an internal wireless attack. The client and access point must be turned on at the same time when JTrans is enabled.

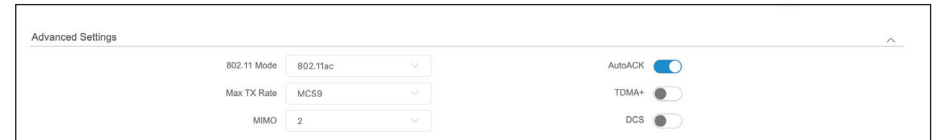

Wireless Interface Settings

In this section, you can change the settings for the DAP-3712's Wi-Fi operation mode, SSID, encryption, and site survey.

Scan Signal: When you click **Scan Signal**, the device will conduct a site survey to find the SSIDs that the DAP-3712 can detect. If you select an SSID, the DAP-3712 will switch to client mode and connect to the SSID you selected. Click the **Edit** button to set up encryption (if required).

Rescan: Click this to perform a site survey again.

Select: Click this to select which SSID the DAP-3712 should connect to.

Lock: Use this to select which SSID and MAC address the DAP-3712 should connect to. If you enable this, the DAP-3712 will only connect to the AP you specify.

Cancel: Click this to cancel the scan.

Wireless Interface Settings

Enable	SSID	Encryption	VLAN	Scan Signal	Edit
<input checked="" type="checkbox"/>	dlink	WPA2-PSK	Disabled		

Scan Results

Serial Number	SSID	MAC	Frequency(Channel)	Signal
<input type="radio"/> 1		36:0A:33:53:83:6F	5500 MHz (100)	-91
<input type="radio"/> 2	dlink-836D	36:0A:33:43:83:6F	5500 MHz (100)	-92

Total 2 10/page < 1 > Go to 1

Edit

Click this to change the DAP-3712's operation mode, encryption and key. The following page will pop up:

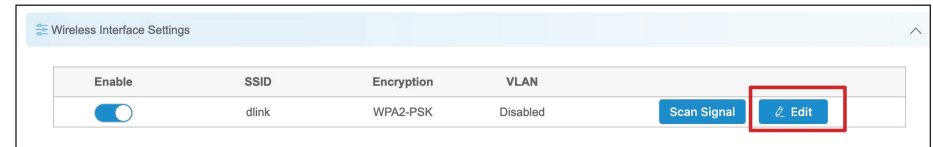

SSID: To set the SSID which the DAP-3712 will broadcast when it operates in **Access Point** or **Access Point (WDS)** or **SSID** mode, or the SSID that the DAP-3712 will attempt to connect to when it operates in **Client** or **Client (WDS)** mode.

Hidden SSID: When the DAP-3712 is in **Access Point** or **Access Point (WDS)** mode, this function will be displayed. Use this to hide the broadcast name of the wireless network.

Wireless Mode: There are four wireless modes: Access Point, Client, Access Point (WDS), and Client (WDS). To use a point-to-point or point-to-multipoint connection, you need to configure the primary DAP-3712 in Access Point or Access Point (WDS) mode and the other DAP-3712s in Client mode or Client (WDS) mode.

If you want to preserve MAC address of clients frame, it is suggested to use Access Point(WDS) and Client (WDS) for each size.

Encryption: You can select which Wi-Fi encryption the DAP-3712 should use: **Open**, **WPA-PSK**, **WPA2-PSK**, **WPA/WPA2 Hybrid-PSK**, or **IEEE802.1X**.

Key: To input the WiFi encryption key. The default key is 1234567890abc

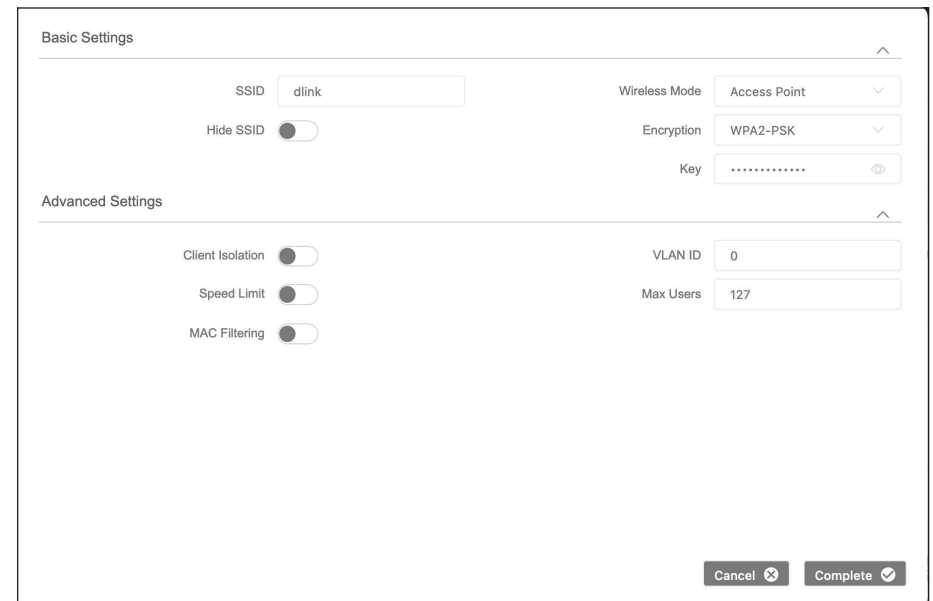

Client When you enable this function, the clients which

Isolation: are connected to the DAP-3712 will not be able to communicate with each other.

Speed Limit: When you enable this function, you will be able to set up a maximum upload/download speed for each client.

VLAN ID: Use this to set up the VLAN ID for the SSID.

Max. Users: Use this to set up the maximum number of clients that can connect to the DAP-3712.

MAC Filtering: Use this to set up a list of MAC addresses that you want to allow or disallow to connect to DAP-3712.

Network

In the **Network** tab, you can set up the DAP-3712's network mode and IP address.

Network Mode: Select either Bridge Mode or Router Mode.

Bridge Mode: In this mode, the DAP-3712's LAN Port and Wi-Fi will bridge together.

Router Mode: In this mode, the DAP-3712 will act as a router.

Management VLAN: Use this to set up a management VLAN ID tag and IP address. When the VLAN is enabled, the DAP-3712 can only be accessed with this VLAN tag and IP address.

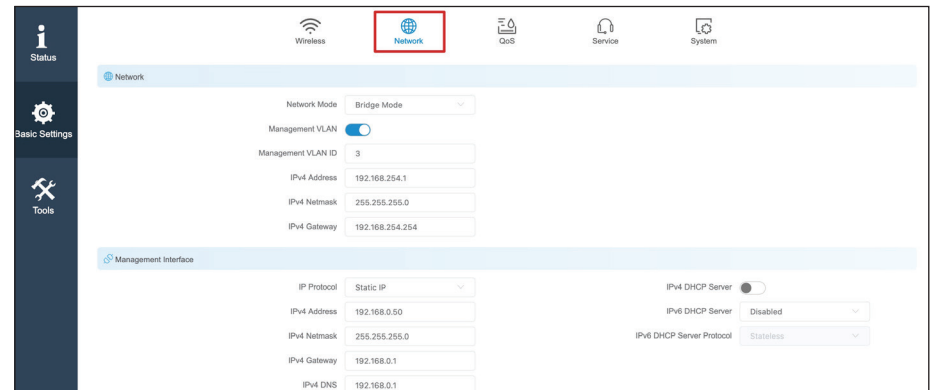

In **Bridge Mode**, users can configure the DAP-3712's LAN interface.

IP Protocol: Use this setting to select either Static IP or DHCP IP.

IPv4/IPv6 DHCP Server: Enabling this function in bridge mode is not recommended. When you enable this function, you need to make sure there are no DHCP servers in the DAP-3712's network.

In **Router Mode**, you need to configure the LAN and WAN interface of the DAP-3712.

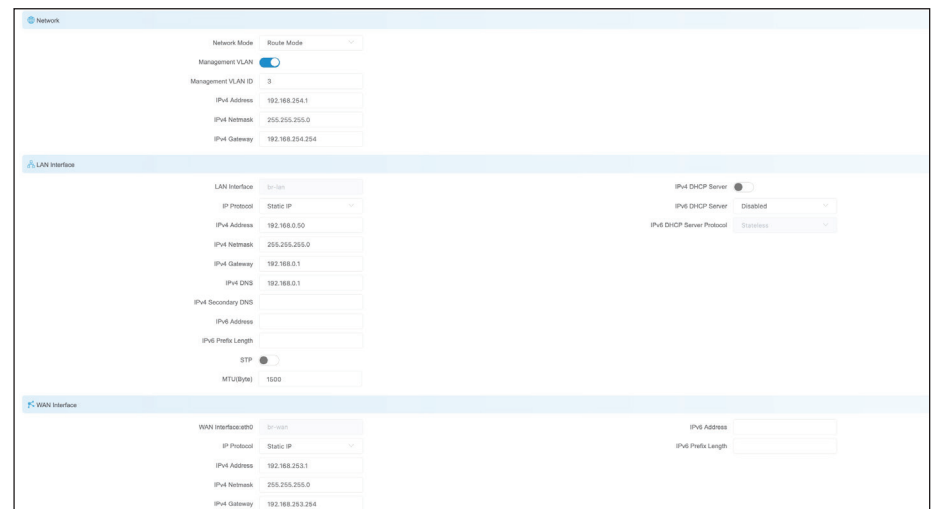

LAN interface: You can set the IP addresses of the devices which can be accessed via Wi-Fi using this setting.

WAN Interface: In router mode, the physical LAN port becomes the WAN port. You need to enter the IP address or configure DHCP clients to get the IP address as well as PPPoE.

Advanced Settings: In this section, you can configure settings such as static routes. In general, users will not need to configure anything in this section.

Bridge Interface Setting: This displays and controls the DAP-3712's bridge policy.

VLAN: This displays the DAP-3712 VLAN ID tag.

Ethernet Interface Setting: Use this to select the LAN port's speed negotiation mode.

IPv4/IPv6 Static Route: Use this to add the Static Route rule for the DAP-3712.

The screenshot shows the 'Advanced Settings' configuration page. It is organized into five main sections, each with a table of settings and an 'Add' button:

- Bridge Interface Settings:** A table with columns: Bridge Name, STP, Port, Comment, and an 'Add' button. Two entries are shown: 'br-lan' with STP 'Disabled' and Port 'ath1'; 'br-wan' with STP 'Disabled' and Port 'eth0'.
- VLAN:** A table with columns: Enable, Interface, VLAN ID, Comment, and an 'Add' button. No entries are currently listed.
- Ethernet Interface Settings:** A table with columns: Interface, Mode, Speed, Duplex, and an 'Add' button. One entry is shown for 'eth0' with Mode 'Negotiate'.
- IPv4 Static Routes:** A table with columns: Interface, Destination, Netmask, IPv4 Gateway, Metric, MTU, and an 'Add' button. No entries are currently listed.
- IPv6 Static Routes:** A table with columns: Interface, Destination, Prefix Length, IPv6 Gateway, Metric, MTU, and an 'Add' button. No entries are currently listed.

QoS

In the QoS tab, there are four sections on this page: **Firewall**, **Traffic Shaping**, **WMM**, and **QoS Priority**.

Firewall: When the firewall is enabled, the device will only allow certain devices to connect to it.

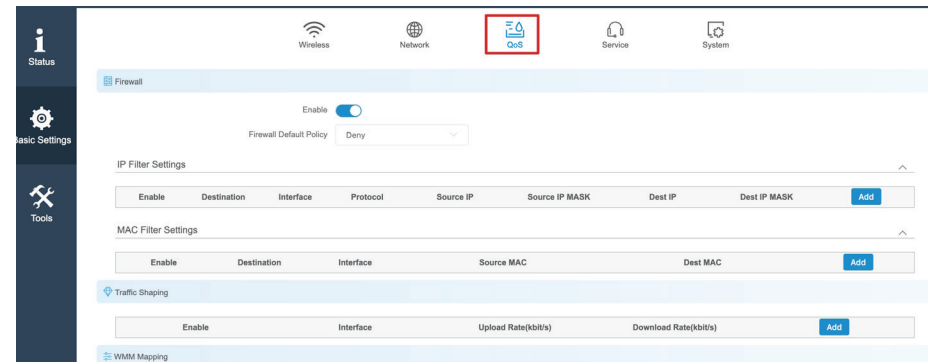

Firewall Default Policy

Accept: Only accept the devices listed in **IP Filter Settings** and **MAC Filter Settings**.

Deny: Deny the devices listed in **IP Filter Settings** and **MAC Filter Settings**.

IP Filter Settings: Click **Add** to add a new IP address to allow or deny.

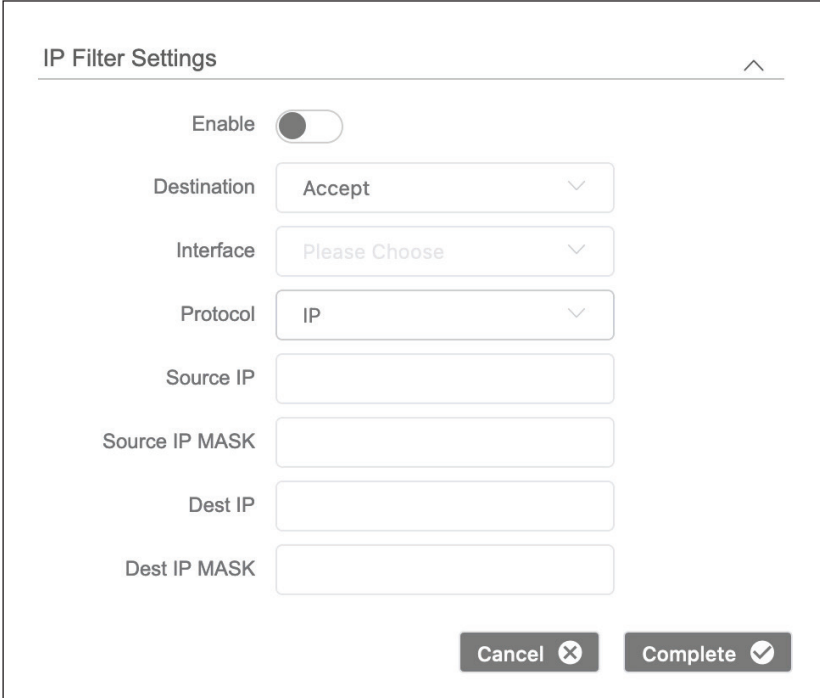

The IP Filter Settings dialog box contains the following fields and controls:

- Enable:** A toggle switch currently turned off.
- Destination:** A dropdown menu with "Accept" selected.
- Interface:** A dropdown menu with "Please Choose" selected.
- Protocol:** A dropdown menu with "IP" selected.
- Source IP:** An empty text input field.
- Source IP MASK:** An empty text input field.
- Dest IP:** An empty text input field.
- Dest IP MASK:** An empty text input field.
- Buttons:** "Cancel" (with an 'X' icon) and "Complete" (with a checkmark icon).

MAC Filter Settings: Click **Add** to add a new MAC address to accept or deny.

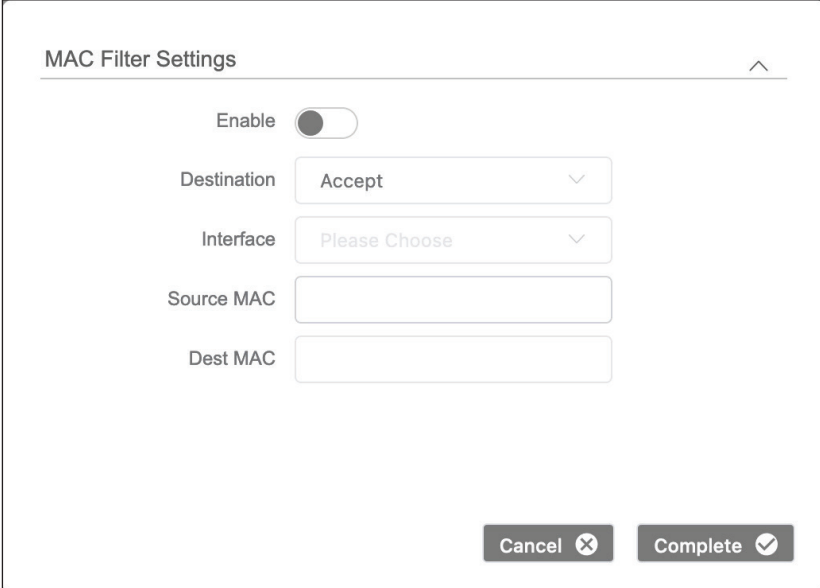

The MAC Filter Settings dialog box contains the following fields and controls:

- Enable:** A toggle switch currently turned off.
- Destination:** A dropdown menu with "Accept" selected.
- Interface:** A dropdown menu with "Please Choose" selected.
- Source MAC:** An empty text input field.
- Dest MAC:** An empty text input field.
- Buttons:** "Cancel" (with an 'X' icon) and "Complete" (with a checkmark icon).

Traffic Shaping: Traffic shaping is used to control the upload/download traffic on each network port.

Interface: Select an interface: Ath0 (wireless) or Eth0 (LAN).

Upload Rate: Enter the maximum upload speed.

Download Rate: Enter the maximum download speed.

WMM Mapping: WMM (Wi-Fi Multimedia) allows wireless communication to define a priority limit on the basis of data type. Time-sensitive data (like video/audio data) can be assigned a higher priority than other data. For WMM to be enabled, the wireless client must support it as well.

Enable	802.1p Priority	WMM Access Category
<input type="checkbox"/>	0	BE
<input type="checkbox"/>	1	BK
<input type="checkbox"/>	2	BK
<input type="checkbox"/>	3	BE
<input type="checkbox"/>	4	VI
<input type="checkbox"/>	5	VI
<input type="checkbox"/>	6	VO
<input type="checkbox"/>	7	VO

QoS Priority: Use this setting to set the QoS settings on the LAN port.

Enable	Target CoS	Target DSCP	Source MAC	Dest MAC	VLAN ID	CoS	Eth Type	DSCP	IP Type	Source IP	Dest IP	Source Port	Dest Port	Add

Service

In the service tab, you can configure the following settings: **Time**, **Automatic Restart**, **External System Log Server**, **Ping Watchdog** and **LED Settings**.

Time: Here you can configure the DAP-3712's time settings.

Time Zone: Use this to select your time zone.

Calibration Type: If **Manual** is selected, you can change the time, or click **Synchronize** to sync the DAP-3712's time with user's PC.

If **NTP** is selected, the DAP-3712 will sync with a dedicated NTP server. Internet access is required if this setting is enabled.

Time Restart: When this function is enabled, the DAP-3712 will automatically restart according to a schedule that you set.

Reboot Period: There are three items can be selected: **Every Day**, **Every Week**, and **Once**.

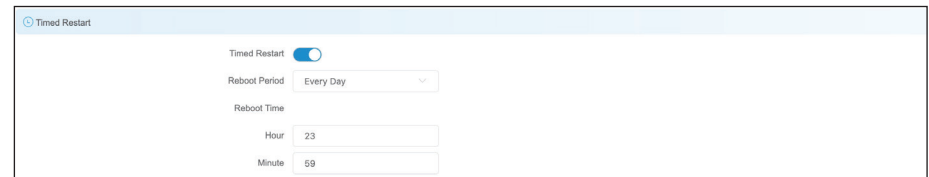
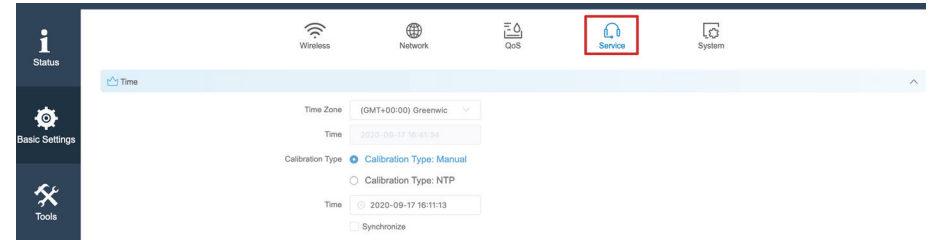

External System Log Server Settings: When this is enabled and a server IP is also set here, the log information will be saved to the Syslog server automatically.

Ping Watchdog: The Ping Watchdog sets the DAP-3712 to continuously ping a user-defined IP address (for example, the IP address of the AP that the client is connecting to). If it is unable to ping using the settings that you entered, the DAP-3712 will automatically reboot. It is highly recommended that you enable this feature when using Access Point / Access Point (WDS) Mode.

Ping IP: Specify the IP address of the target which will be monitored using ping.
If this feature is enabled in **Client/Client (WDS)** mode, the IP address should be the IP address of the AP that the client is connecting to.

Ping Interval: Specify the time interval (in seconds) that the Ping Watchdog should wait between ping requests.

Startup Delay: Specify the initial time delay (in seconds) before the first ping request should be sent by the Ping Watchdog.

Ping Failure: Specify the number of ping replies to wait for. If the designated number of ping replies is not received, the Ping Watchdog will reboot the device.

The screenshot shows a web interface with two sections. The top section, titled "External System Log Server Settings", contains three input fields: "External System Log Server IP" (empty), "External System Log Server Port" (set to 514), and "Log Output Level" (set to Info). The bottom section, titled "Ping Watchdog", has an "Enable" toggle switch turned on. Below it are four input fields: "Ping IP" (empty), "Ping Interval (Seconds)" (set to 3), "Start Delay (Seconds)" (set to 60), and "Ping Failed Times" (set to 20).

Note: If you want to modify the parameters of the Ping Watchdog, please disable it first and then apply the desired settings. When the web page shows that Ping Watchdog is disabled, users will be able to re-enable it with modified parameters.

LED Configuration: LED1, LED2, and LED3 light up to indicate the DAP-3712's signal strength. The default ranges are:

LED1: -95 dBm to -71 dBm

LED2: -71 dBm to -56 dBm

LED3: -56 dBm and above

When the signal strength is within LED1's range, only LED1 will light up. When it is within LED2's range, both LED1 and LED2 will light up. When the signal strength is above -56 dBm, all three LEDs will light up.



The screenshot shows the 'LED Settings' configuration page. It features three input fields for setting the signal strength thresholds for LED1, LED2, and LED3. The current values are -95 dBm for LED1, -71 dBm for LED2, and -56 dBm for LED3.

LED	Value (dBm)
LED1 (dB)	-95
LED2 (dB)	-71
LED3 (dB)	-56

Temperature Setting: To extend the working life of your equipment, you can enable the overheating protection function. To do this, enter the **Advanced Configuration Temperature Configuration** page. This page shows the performance degradation rate of the device at different temperatures. When the temperature is between -100°C and 110°C, the rate will not change. When the temperature is between 100°C and 120°C, the rate will drop by 50%. At a temperature between 110°C and 135°C, the rate will drop by 90%, and when the temperature is between 125°C and 150°C, the rate of decline will be 100%.

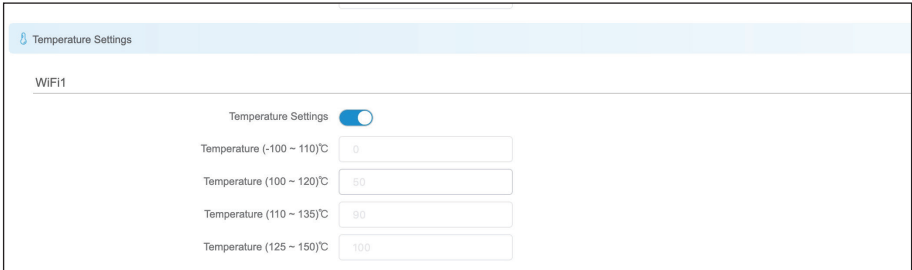

The screenshot shows the 'Temperature Settings' configuration page. It includes a toggle switch for 'Temperature Settings' which is currently turned on. Below the toggle are four input fields for setting performance degradation rates at different temperature ranges: 0% for -100 ~ 110°C, 50% for 100 ~ 120°C, 90% for 110 ~ 135°C, and 100% for 125 ~ 150°C.

Temperature Range (°C)	Rate (%)
Temperature (-100 ~ 110)°C	0
Temperature (100 ~ 120)°C	50
Temperature (110 ~ 135)°C	90
Temperature (125 ~ 150)°C	100

System

There are three subsections in the **System** section: **System**, **Firmware Management**, and **Account Management**.

Device Name: Enter the device name here.

Login Timeout: Enter the time (in minutes) before users should be automatically logged out of the web UI.

Backup Syslog: Click to back up the current system configuration settings and download them as a file.

Upload Configuration: Click **Browse** to choose the backup configuration file and then click Upload to apply the settings.

System Log Export: Click to download a backup of the current system log.

Restore Factory Settings: Click the **Reset** button to restore the device to the factory default settings.

Reboot: Click the button to reboot the DAP-3712.

Firmware Update: Click the **Browse** button and choose a firmware file, then click the **Update** button to upgrade the firmware to the latest version.

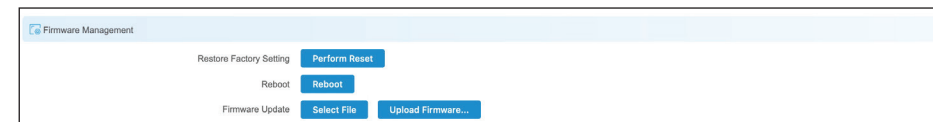
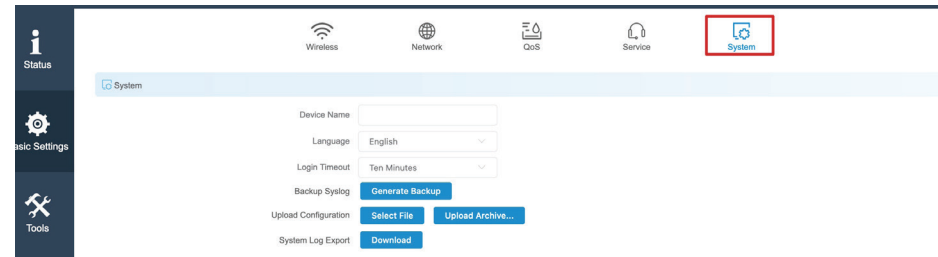

Section 3 - Configuration

Account Management: In this section you can change the admin password or set up a Read Only account.

Modify User Account: Use this to change the admin account's password

Read-Only Account: Use this to enable a Read Only guest account

Change Read-Only Account: Use this to change the guest account's password

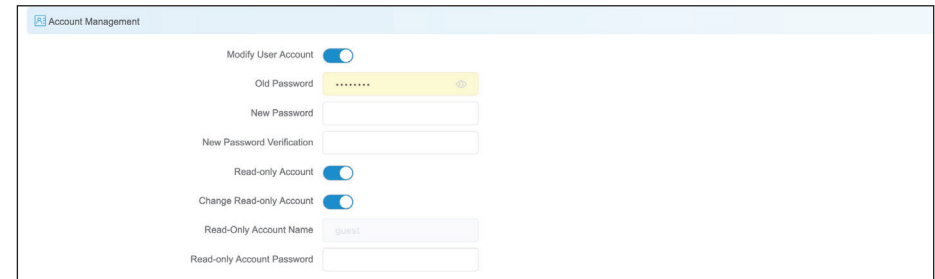

The screenshot shows the 'Account Management' configuration page. It includes the following settings:

- Modify User Account:** A toggle switch that is turned on.
- Old Password:** A text input field containing seven dots, with a visibility icon on the right.
- New Password:** A text input field.
- New Password Verification:** A text input field.
- Read-only Account:** A toggle switch that is turned on.
- Change Read-only Account:** A toggle switch that is turned on.
- Read-Only Account Name:** A text input field containing the value 'guest'.
- Read-only Account Password:** A text input field.

Status

There are four tabs in the Status section:

Info

In the **Info** tab, information about the device is displayed.

Device Name: Device Name: The name of the device

Device Model: Device Model: The model (DAP-3712)

Firmware Version: The software version number

Uptime: The length of time that the device has been powered on

Time: The current time

Network: This displays the DAP-3712's network status

Network Mode: This indicates whether the device is in Router Mode or Bridge Mode

IP Protocol: This indicates whether the device is configured with a Static IP or DHCP

Wired Port MAC Address: This displays the device's LAN MAC Address

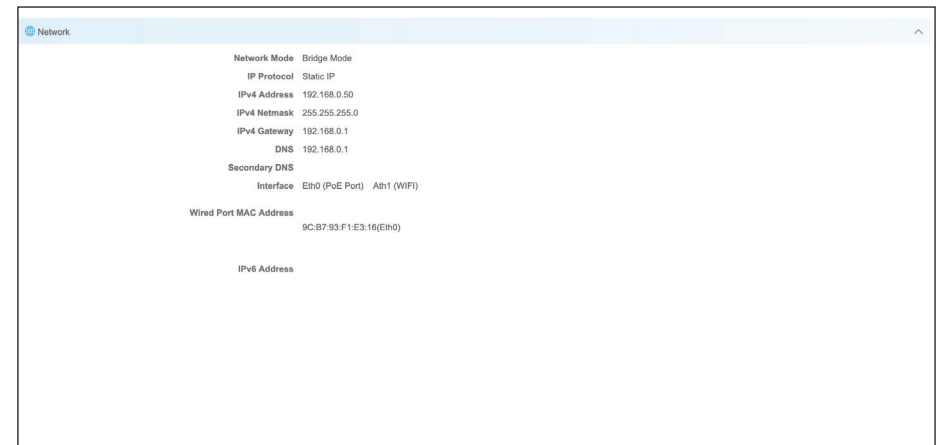
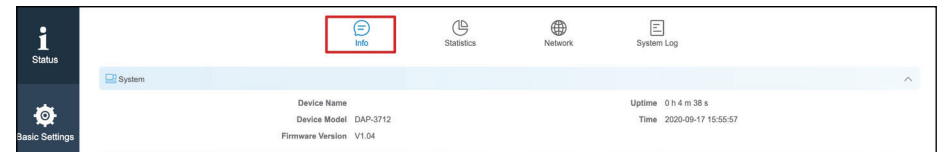

SSID: SSID: Displays the device's SSID

Wireless Mode: This displays the device's mode: Access Point, Client, Access Point (WDS), or Client (WDS)

BSSID: This displays the device's Wi-Fi MAC address

Country Code: This displays the device's country code

Channel Width: This displays the device's current operating channel width (10/20/40/80 MHz)

Frequency (Channel): Displays the device's current operating channel

802.11 Mode: This displays the device's current 802.11 mode: 802.11ac or 802.11 a/n

Encryption: Displays the current Wi-Fi encryption

Distance: Shows distance between the two associated devices

Noise Floor: Displays the current noise floor value. In order to achieve the best results, a value of less than -95dBm is recommended

Transmit Power: Displays the DAP-3712's current Wi-Fi power output

Station List Info: This will list all of the client devices which are connected to the DAP-3712.

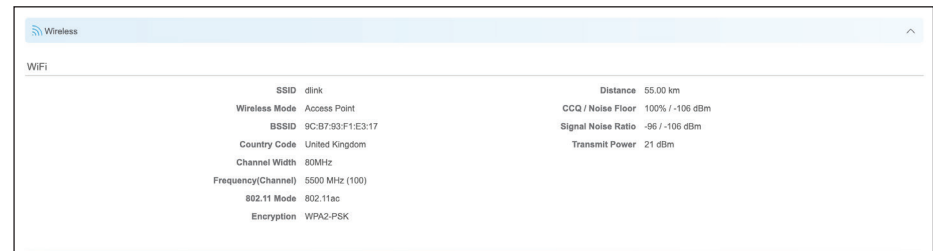

The screenshot shows the 'Wireless' configuration page with a 'WiFi' section. The details are as follows:

Parameter	Value
SSID	dlink
Wireless Mode	Access Point
BSSID	9C:B7:83:F1:E3:17
Country Code	United Kingdom
Channel Width	80MHz
Frequency(Channel)	5500 MHz (100)
802.11 Mode	802.11ac
Encryption	WPA2-PSK
Distance	55.00 km
CCQ / Noise Floor	100% / -106 dBm
Signal Noise Ratio	-96 / -106 dBm
Transmit Power	21 dBm

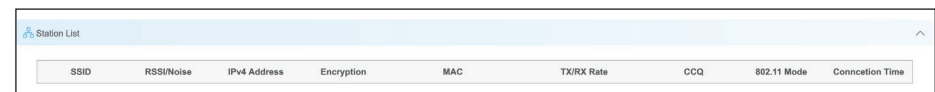

The screenshot shows the 'Station List' page with a table of connected devices. The table has the following columns:

SSID	RSSI/Noise	IPv4 Address	Encryption	MAC	TX/RX Rate	CCQ	802.11 Mode	Connction Time
------	------------	--------------	------------	-----	------------	-----	-------------	----------------

Statistics

There are two subsections: **Interface Statics** and **Throughput**.

Interface Statics: Displays the DAP-3712's traffic

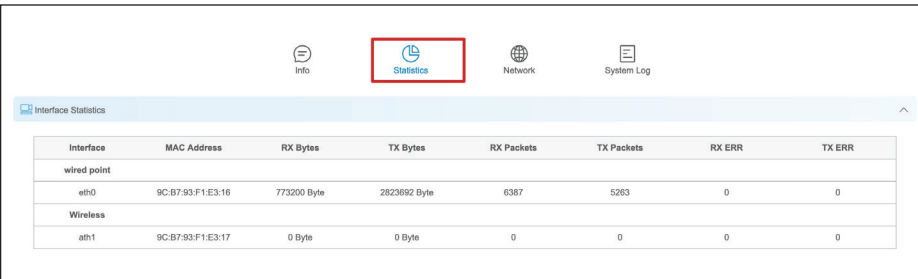

Interface	MAC Address	RX Bytes	TX Bytes	RX Packets	TX Packets	RX ERR	TX ERR
wired point							
eth0	9C:B7:93:F1:E3:16	773200 Byte	2823692 Byte	6387	5263	0	0
Wireless							
ath1	9C:B7:93:F1:E3:17	0 Byte	0 Byte	0	0	0	0

Throughput: Displays the current Ethernet and wireless traffic

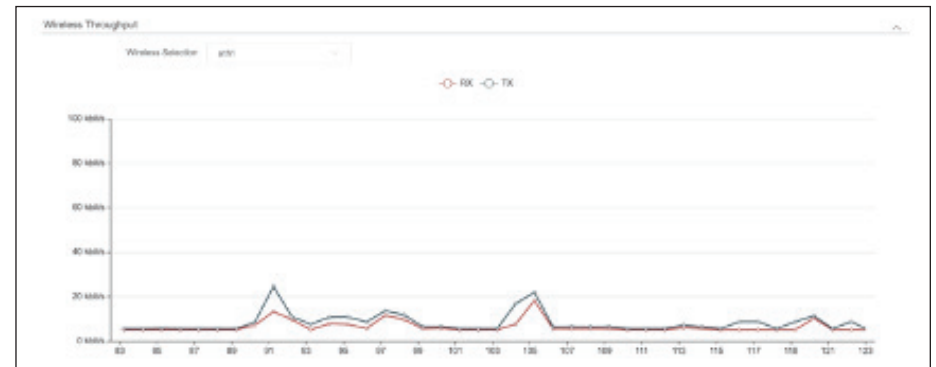
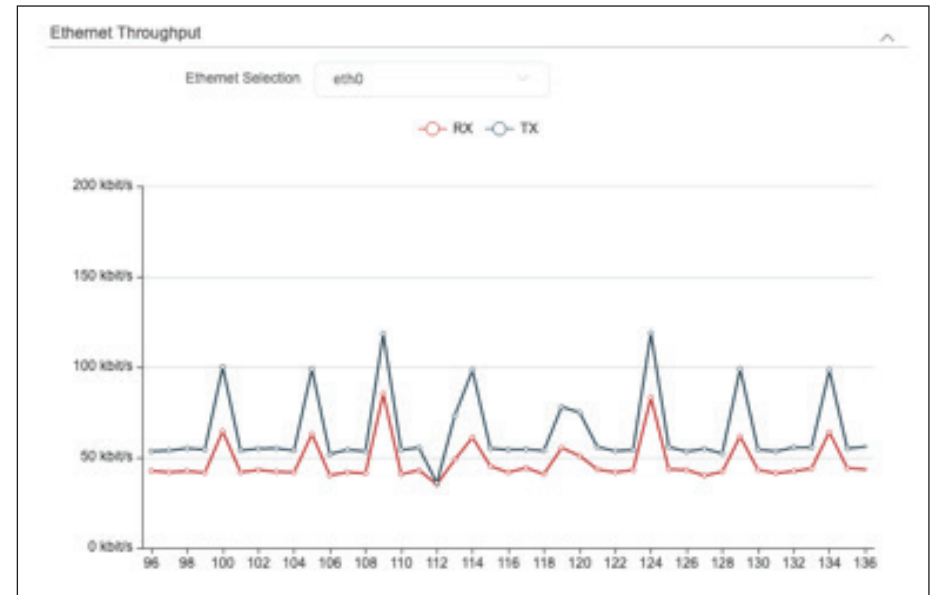

Network

In this tab, you can see the current IPv4 route table, APR table and bridge table.

The screenshot displays the Network configuration interface. At the top, there are four navigation icons: Info, Statistics, Network (highlighted with a red box), and System Log. Below these are three expandable sections:

- IPv4 Routes Table:** A table with columns: Destination, Netmask, Gateway, Interface, and Metric.
- ARP Table:** A table with columns: IPv4 Address, MAC Address, and Interface.
- Bridge Table:** A table with columns: MAC Address and Ageing Timer.

Destination	Netmask	Gateway	Interface	Metric
0.0.0.0	0.0.0.0	192.168.0.1	br-lan	0
192.168.0.0	255.255.255.0	0.0.0.0	br-lan	0
224.0.0.0	240.0.0.0	0.0.0.0	br-lan	0

IPv4 Address	MAC Address	Interface
192.168.0.12	00:E0:4C:68:00:2E	br-lan
192.168.0.1	00:00:00:00:00:00	br-lan

MAC Address	Ageing Timer
9C:B7:93:F1:E3:17	0s
9C:B7:93:F1:E3:16	0s
00:E0:4C:68:00:2E	0s

Syslog Info

This tab shows the current syslog. Click the Clear button to clear the log.

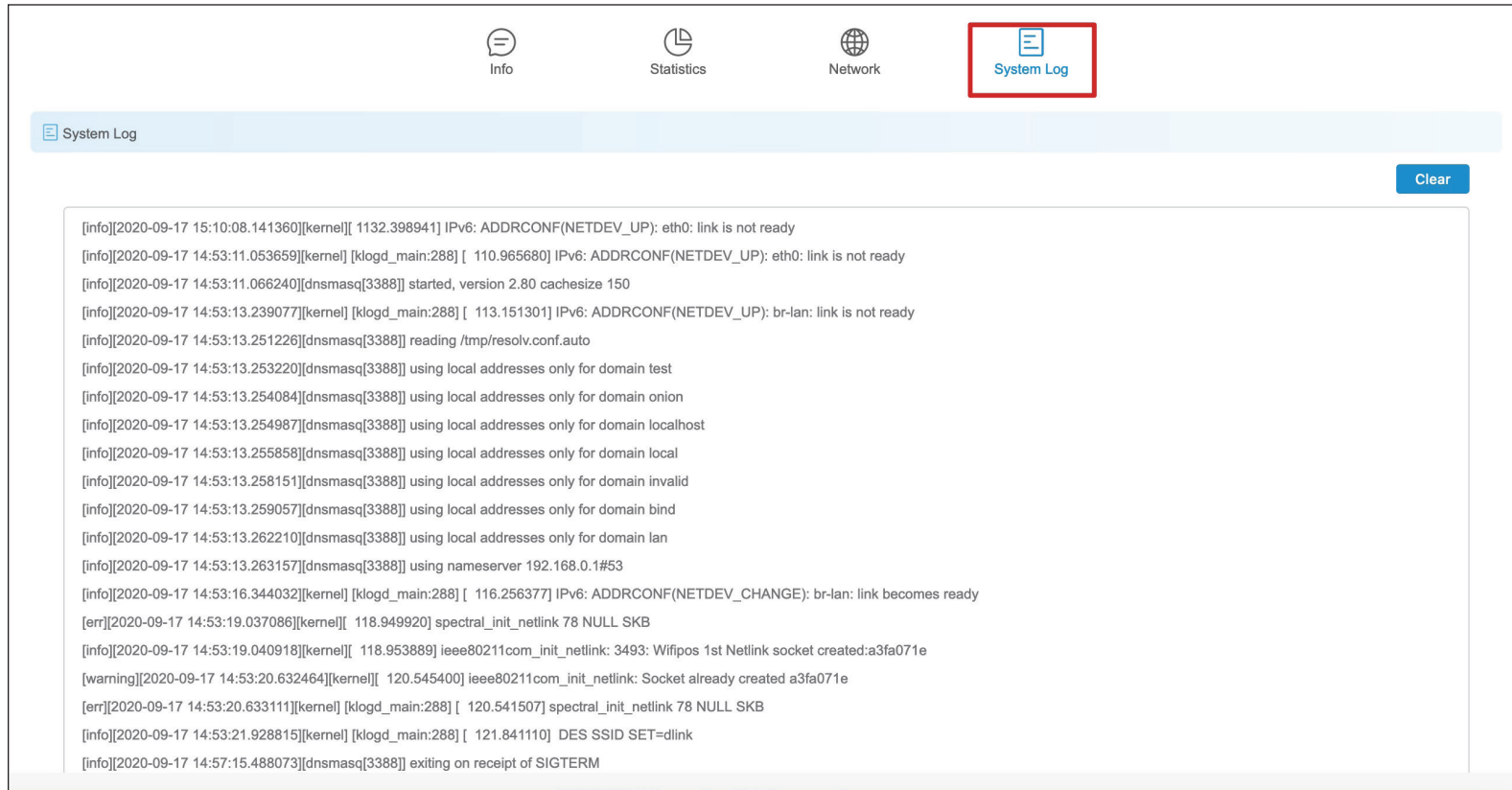

The screenshot displays the 'System Log' interface. At the top, there are four navigation icons: 'Info', 'Statistics', 'Network', and 'System Log' (which is highlighted with a red box). Below the navigation bar, the 'System Log' tab is active, showing a list of log entries. A 'Clear' button is located in the top right corner of the log area.

```
[info][2020-09-17 15:10:08.141360][kernel][ 1132.398941] IPv6: ADDRCONF(NETDEV_UP): eth0: link is not ready
[info][2020-09-17 14:53:11.053659][kernel][klogd_main:288] [ 110.965680] IPv6: ADDRCONF(NETDEV_UP): eth0: link is not ready
[info][2020-09-17 14:53:11.066240][dnsmasq[3388]] started, version 2.80 cachesize 150
[info][2020-09-17 14:53:13.239077][kernel][klogd_main:288] [ 113.151301] IPv6: ADDRCONF(NETDEV_UP): br-lan: link is not ready
[info][2020-09-17 14:53:13.251226][dnsmasq[3388]] reading /tmp/resolv.conf.auto
[info][2020-09-17 14:53:13.253220][dnsmasq[3388]] using local addresses only for domain test
[info][2020-09-17 14:53:13.254084][dnsmasq[3388]] using local addresses only for domain onion
[info][2020-09-17 14:53:13.254987][dnsmasq[3388]] using local addresses only for domain localhost
[info][2020-09-17 14:53:13.255858][dnsmasq[3388]] using local addresses only for domain local
[info][2020-09-17 14:53:13.258151][dnsmasq[3388]] using local addresses only for domain invalid
[info][2020-09-17 14:53:13.259057][dnsmasq[3388]] using local addresses only for domain bind
[info][2020-09-17 14:53:13.262210][dnsmasq[3388]] using local addresses only for domain lan
[info][2020-09-17 14:53:13.263157][dnsmasq[3388]] using nameserver 192.168.0.1#53
[info][2020-09-17 14:53:16.344032][kernel][klogd_main:288] [ 116.256377] IPv6: ADDRCONF(NETDEV_CHANGE): br-lan: link becomes ready
[err][2020-09-17 14:53:19.037086][kernel][ 118.949920] spectral_init_netlink 78 NULL SKB
[info][2020-09-17 14:53:19.040918][kernel][ 118.953889] ieee80211com_init_netlink: 3493: Wifipos 1st Netlink socket created:a3fa071e
[warning][2020-09-17 14:53:20.632464][kernel][ 120.545400] ieee80211com_init_netlink: Socket already created a3fa071e
[err][2020-09-17 14:53:20.633111][kernel][klogd_main:288] [ 120.541507] spectral_init_netlink 78 NULL SKB
[info][2020-09-17 14:53:21.928815][kernel][klogd_main:288] [ 121.841110] DES SSID SET=dlink
[info][2020-09-17 14:57:15.488073][dnsmasq[3388]] exiting on receipt of SIGTERM
```

Tools

The DAP-3712 has many useful tools built in to help you manage the device and your network. These tools include Ping IP, Traceroute, Link Test, Antenna Alignment and Spectrum Analyzer.

Ping IP

You can type in an IP address and check the ping result.

IP Address: Enter the IP address that you would like to ping.

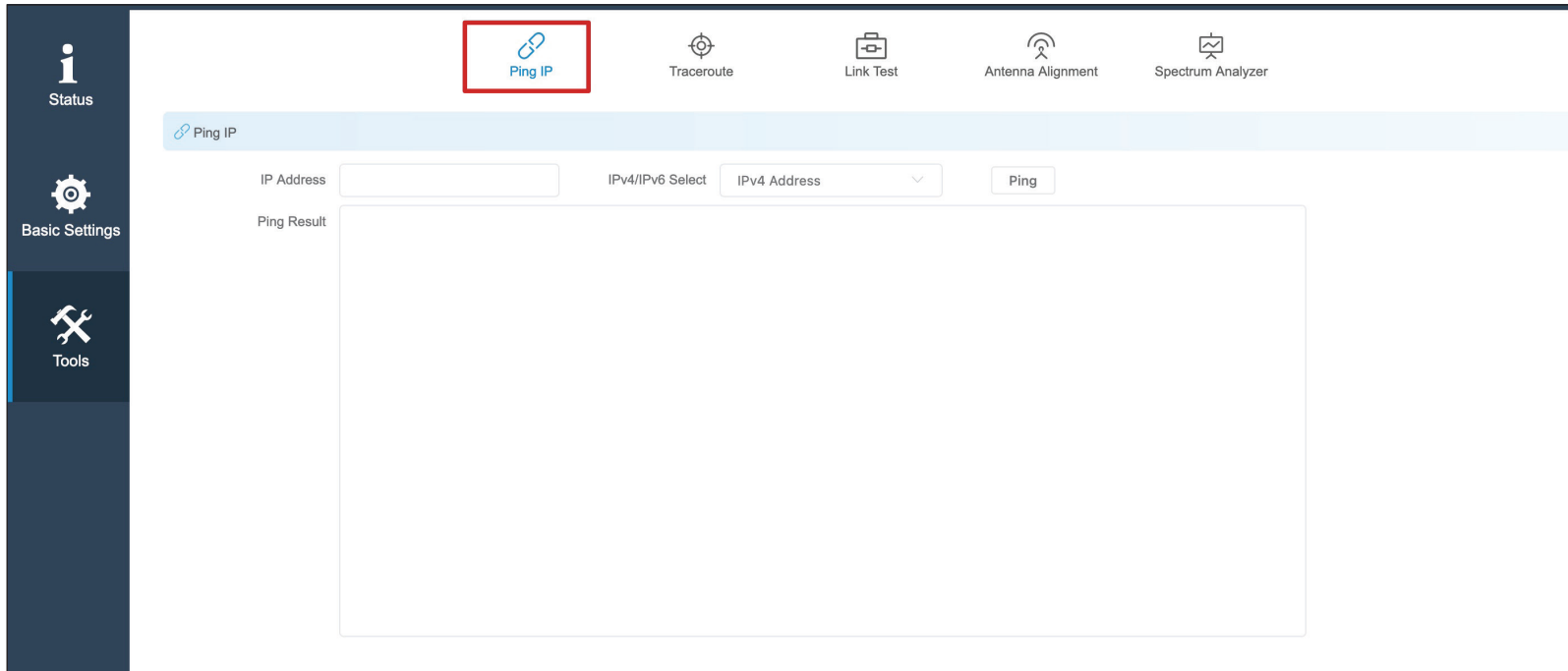

Traceroute

This allows the user to traceroute an IP address.

IP Address: Enter the IP address to traceroute

The screenshot shows a web management console interface with a top navigation bar containing five icons: Ping IP, Traceroute (highlighted with a red box), Link Test, Antenna Alignment, and Spectrum Analyzer. Below the navigation bar is a light blue header with a 'Traceroute' tab icon. The main content area contains a form with the following elements: an 'IP Address' text input field, an 'IPv4/IPv6 Select' dropdown menu currently set to 'IPv4 Address', and a 'Traceroute' button. Below these fields is a large, empty rectangular area labeled 'Traceroute Result'.

Link Test

The Link Test allows you to test the throughput of a link between an AP and a client in WDS. To perform the test, set up one DAP-3712 in AP mode on one end and another DAP-3712 in Client mode on the other end of the link.

Set up DAP-3712 in Client (WDS) mode

1. Enable the Client (WDS) mode on the DAP-3712 on one end of the link. Refer to **Wireless Mode** in **Wireless Interface Settings** on page 27 for instructions.
2. Go to **Tools > Link Test** and enable **Link Test**.
3. Click **Save**.

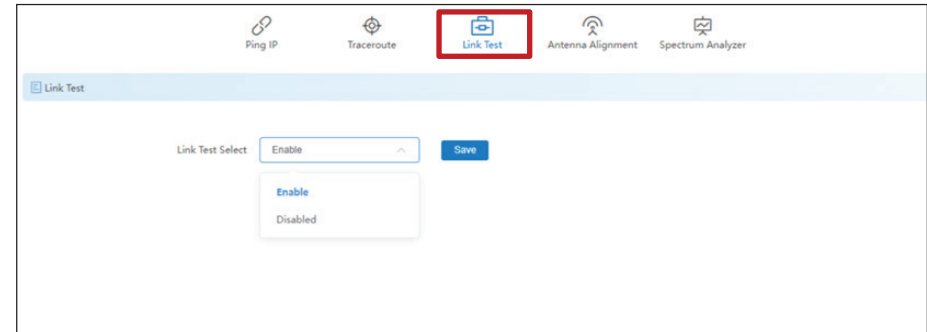

Set up the other DAP-3712 in Access Point (WDS) mode

1. Enable the Access Point (WDS) mode on the other DAP-3712 of the link. Refer to **Wireless Mode** in **Wireless Interface Settings** on page 27 for instructions.
2. Go to **Tools > Link Test** and enter the following parameters for the test.

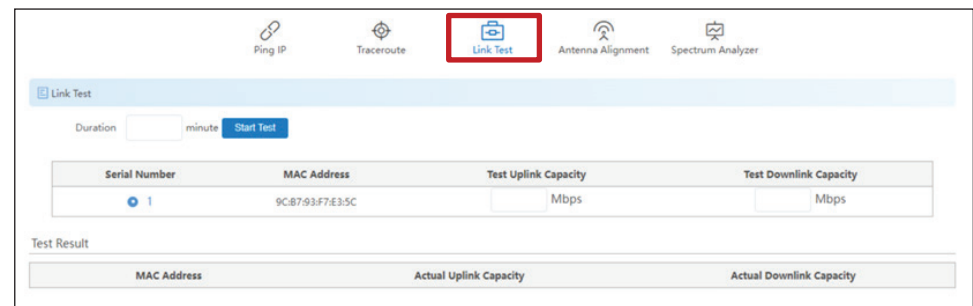

Duration: Enter how long (minutes) the test should last.

Test Uplink Capacity: Enter the available network bandwidth for uploading content to the other end of the link.

Test Downlink Capacity: Enter the available network bandwidth for downloading content from the other end of the link.

3. Click **Start Test**. The results will be displayed below.

Antenna Alignment

When you select this, the DAP-3712 will recalibrate its signal strength. You can check which angle has the best antenna alignment when you install the DAP-3712.

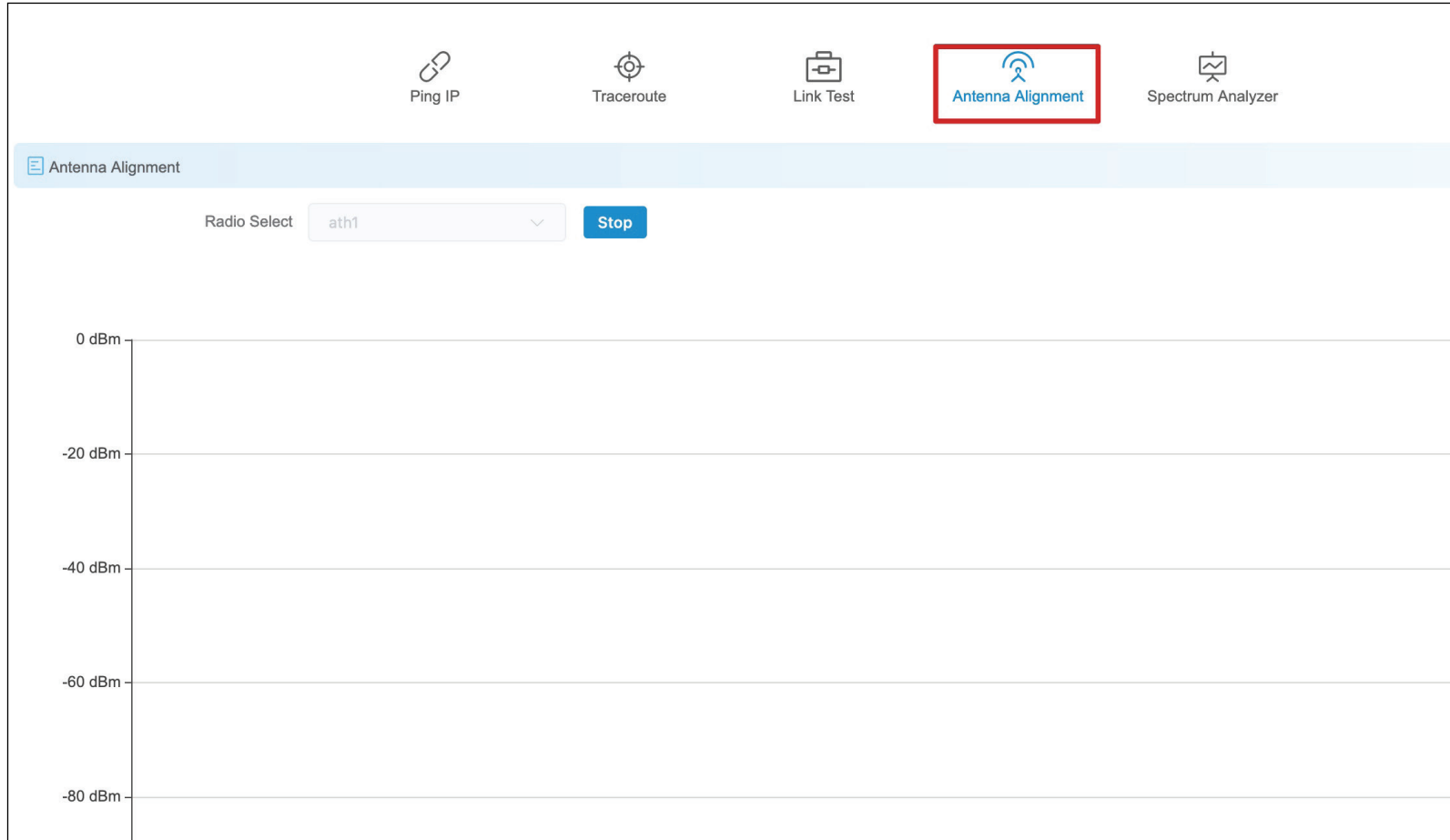

Spectrum Analyzer

You can use the Spectrum Analyzer to scan for the best channels. When performing the scan, the DAP-3712 Wi-Fi may disconnect.

Spectrum Enter the frequency range to conduct spectrum
Analysis analysis on. It will take a few seconds to finish the
Range: scan.

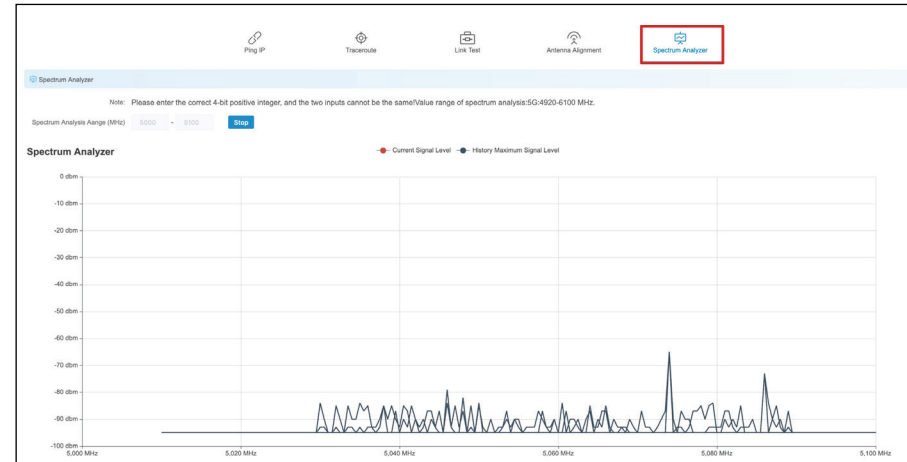

Technical Specifications

Standards

802.11a/n/ac

Device Interfaces

1 x 100/1000 Mbps Ethernet port, reset button

LEDs

Signal strength

Antenna Type

Dish

Antenna Gain

23 dBi

Beamwidth

H: 10°, V: 10°

Standards

802.11a/n/ac

Protection

8 kV ESD Protection

Enclosure

ABS, IP66 compliant

Operation Modes

AP, Station, WDS AP, WDS Station

Operating Frequency

5180~5320 MHz, 5745~5825 MHz

Max. Transmit Power¹

27 dBm

Wireless Speed

Up to 867 Mbps

Bandwidth Support

20/40/80 MHz

Wireless Configuration

Auto channel support, transmit power selection, SSID broadcast enabling/disabling

Security

802.11i 128-bit AES Personal / Enterprise

System Tools

Ping, traceroute, NTP, ping watchdog, syslog, spectrum analyzer, throughput testing (lperf)

Smart Wireless Technology

TDMA, Auto ACK, intelligent rate control, co-channel interference avoidance

Advanced Features

Max. station limit

¹Range will vary depending on country's maximum transmit power output regulation. Maximum wireless signal rate derived from IEEE Standard 802.11g and 802.11n specifications. Actual data throughput will vary. Network conditions and environmental factors, including volume of network traffic, building materials and construction, and network overhead, lower actual data throughput rate. Environmental conditions will adversely affect wireless signal range.

LAN Type

Static, DHCP

VLAN Support

Yes

Firewall

IP / MAC filter

Monitors

Throughput, interfaces, routes table, bridge table, ARP table, AP information, syslog

Firmware Upgrade

Web-based upgrade

Power Input

PoE+ 48 V

Power Consumption

≤ 15 W

Operating Temperature

-40°C to 65°C

Storage Temperature

-40°C to 85°C

Operating Humidity

0% to 90%

Storage Humidity

0% to 90%

Weight

900 g (2.0 lbs)

Dimensions

372 x 372 x 241 mm (14.6 x 14.6 x 9.5 in)

Certifications

CE

FCC

Trademarks:

D-Link is a registered trademark of D-Link Corporation/D-Link Systems, Inc. Other trademarks or registered trademarks are the property of their respective owners.

Copyright Statement:

No part of this publication or documentation accompanying this product may be reproduced in any form or by any means or used to make any derivative such as translation, transformation, or adaptation without permission from D-Link Corporation/D-Link Systems, Inc., as stipulated by the United States Copyright Act of 1976 and any amendments thereto. Contents are subject to change without prior notice.

Copyright ©2024 by D-Link Corporation/D-Link Systems, Inc. All rights reserved.

FCC Statement

This equipment has been tested and found to comply with the limits for a Class A digital device, pursuant to Part 15 of the FCC Rules. These limits are designed to provide reasonable protection against harmful interference when the equipment is operated in a commercial environment. This equipment generates, uses, and can radiate radio frequency energy and, if not installed and used in accordance with the instruction manual, may cause harmful interference to radio communications. Operation of this equipment in a residential area is likely to cause harmful interference in which case the user will be required to correct the interference at his own expense.

FCC Radiation Exposure Statement

This device complies with FCC radiation exposure limits set forth for an uncontrolled environment and it also complies with Part 15 of the FCC RF Rules. This equipment must be installed and operated in accordance with provided instructions and the antenna(s) used for this transmitter must be installed to provide a separation distance of at least 20 cm from all persons and must not be co-located or operating in conjunction with any other antenna or transmitter. End-users and installers must be provided with antenna installation instructions and consider removing the no-collocation statement.

This device complies with Part 15 of the FCC Rules. Operation is subject to the following two conditions: (1) this device may not cause harmful interference, and (2) this device must accept any interference received, including interference that may cause undesired operation.

Caution!

Any changes or modifications not expressly approved by the party responsible for compliance could void the user's authority to operate the equipment.