

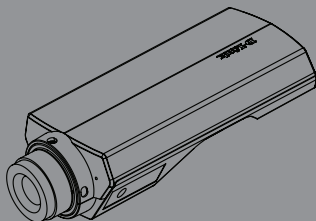

Quick Installation Guide HD PoE Network Camera

This document will guide you through the basic installation process for your new D-Link Network Camera.

DCS-3010



Quick Installation Guide
Руководство по быстрой установке
Guía de Instalación Rápida
Guia de Instalação Rápida
快速安裝指南
Petunjuk Pemasangan Cepat

Documentation also available on
CD and via the D-Link Website

DCS-3010 Quick Install Guide

This installation guide provides basic instructions for installing the DCS-3010 Network Camera on your network. For additional information about how to use the camera, please see the User's Manual which is available on the CD include in this package or from the D-Link support website.

Installation Steps

1. Verify the package contents against the list below.
2. Hardware Overview
3. Hardware Installation
4. Configuration with Wizard

1. Package Contents

- DCS-3010 HD PoE Network Camera
- Camera Stand
- Manual and Software on CD-ROM
- CAT5 Ethernet Cable
- Power Adapter
- Quick Install Guide
- lens ring fixture
- Allen wrench

If any of the above items are missing, please contact your reseller.

2. Hardware Overview

Rear Panel

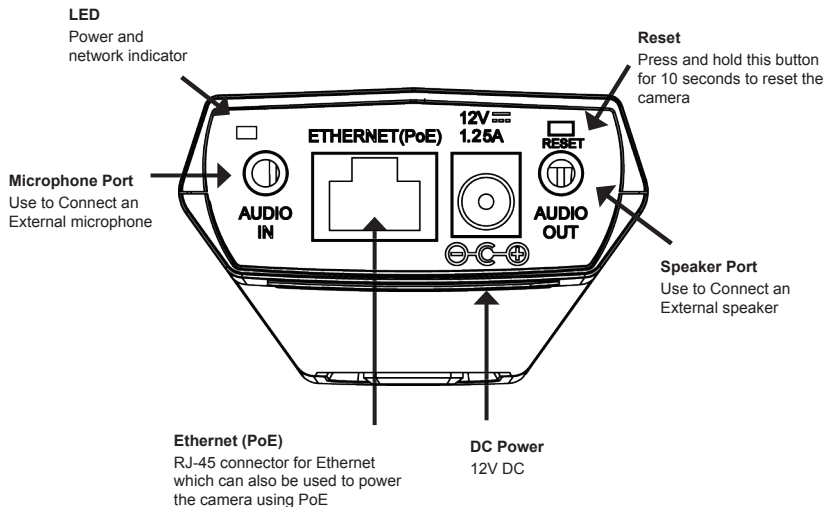

Front Panel

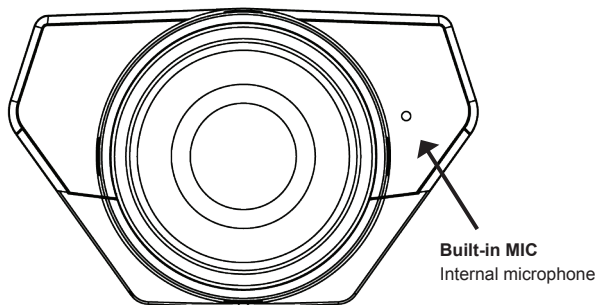

Side panel

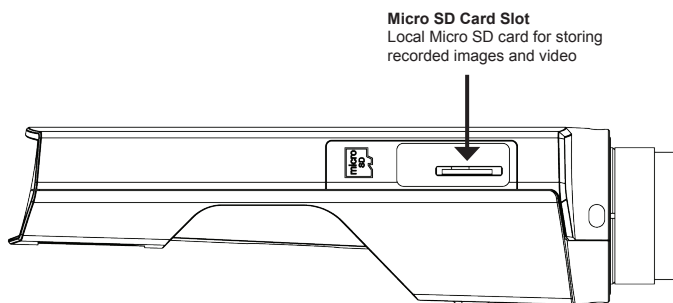

Button panel

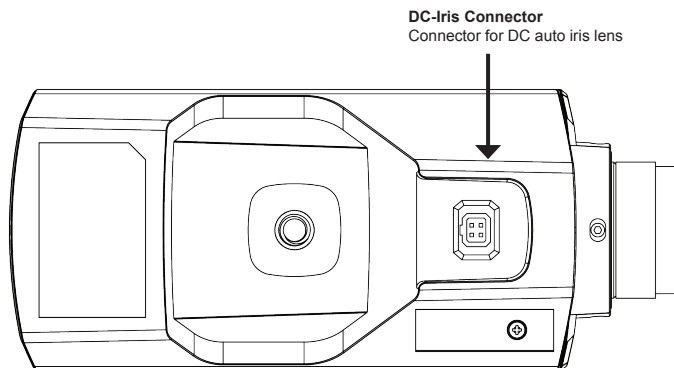

Right Panel

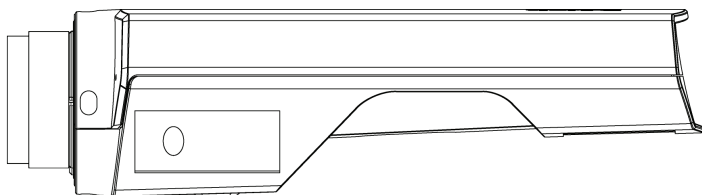

3. Hardware Installation

Basic Connection (without PoE)

Connect the camera to your switch or router via Ethernet cable.
Connect the supplied power cable from the camera to a power outlet.

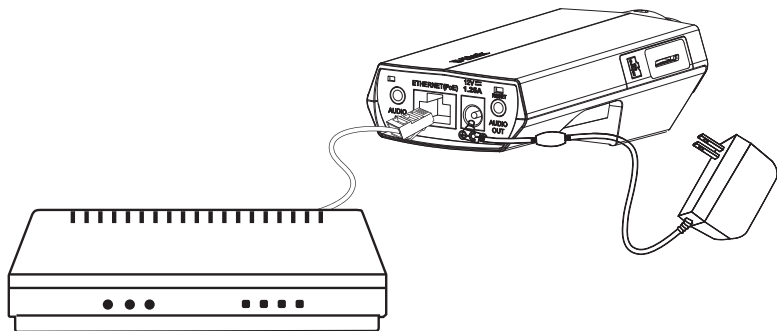

Connection Using a PoE Switch

If using a PoE switch or router, connect the network camera via Ethernet cable.
PoE will transmit both power and data over a single cable.

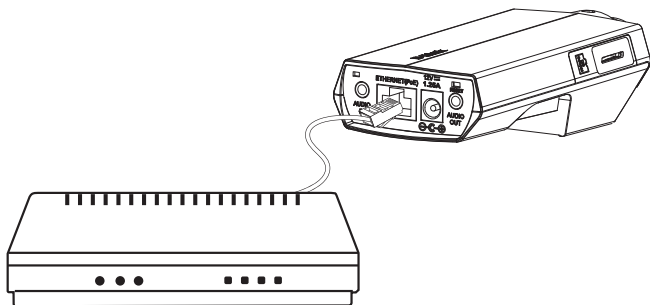

Note: Once power has been established, the LED will turn red. When the device has obtained an IP address and is accessible, the LED will turn green.

4. Configuration with Wizard

Insert the DCS-3010 CD into your computer's CD-ROM drive to begin the installation. If the Autorun function on your computer is disabled, or if the D-Link Launcher fails to start automatically, click **Start > Run**. Type **D:\autorun.exe**, where D: represents the drive letter of your CD-ROM drive.

Click **Setup Wizard** to begin the installation.



After clicking Setup Wizard, the following window will open.

Click **Next** to continue.

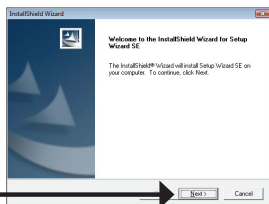

Click **Yes** to accept the License Agreement.

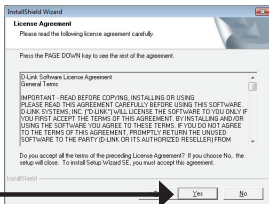

To start the installation process, click **Next**.

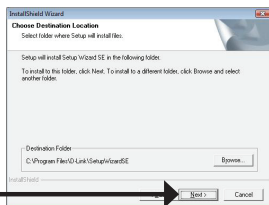

Note: The installation may take several minutes to finish.

Click **Finish** to complete the installation.

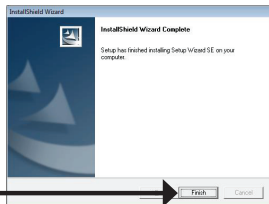

Click on the **D-Link Setup Wizard SE** icon that was created in your Windows Start menu.

Start > D-Link > Setup Wizard SE

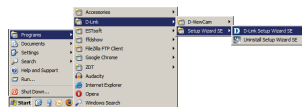

The Setup Wizard will appear and display the MAC address and IP address of your camera(s). If you have a DHCP server on your network, a valid IP Address will be displayed. If your network does not use a DHCP server, the network camera's default static IP **192.168.0.20** will be displayed.

Click the **Wizard** button to continue.

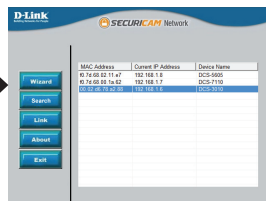

Enter the Admin ID and password. When logging in for the first time, the default Admin ID is **admin** with the password left blank.

Click **Next**, to proceed to the next page.

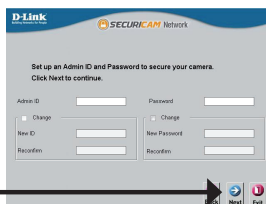

Select DHCP if your camera obtains an IP address automatically when it boots up. Select static IP if the camera will use the same IP address each time it is started.

Click **Next**, to proceed to the next page.

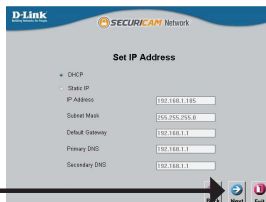

Take a moment to confirm your settings and click **Restart**.

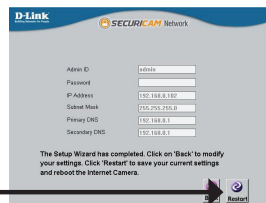

Viewing Camera via Web Browser

Click on the **D-Link Setup Wizard SE** icon that was created in your Windows Start menu.

Start > D-Link > Setup Wizard SE

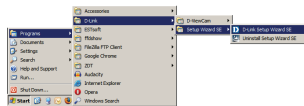

Select the camera and click the button labeled "Link" to access the web configuration.

The Setup Wizard will automatically open your web browser to the IP address of the camera.

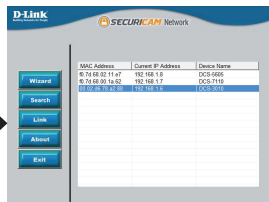

Enter **admin** as the default username and leave the password blank. Click **OK** to continue.



This section shows your camera's live video. You can select your video profile and view or operate the camera. For additional information about web configuration, please refer to the user manual included on the CD-ROM or the D-Link website.

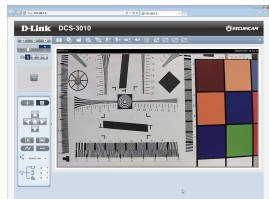

Technical Support

You can find software updates and user documentation on the D-Link website.

Tech Support for customers in

Australia:

Tel: 1300-766-868
24/7 Technical Support
Web: <http://www.dlink.com.au>
E-mail: support@dlink.com.au

India:

Tel: +91-22-27626600
Toll Free 1800-22-8998
Web: www.dlink.co.in
E-Mail: helpdesk@dlink.co.in

Singapore, Thailand, Indonesia, Malaysia, Philippines, Vietnam:

Singapore - www.dlink.com.sg
Thailand - www.dlink.co.th
Indonesia - www.dlink.co.id
Malaysia - www.dlink.com.my
Philippines - www.dlink.com.ph
Vietnam - www.dlink.com.vn

Korea:

Tel: +82-2-2028-1810
Monday to Friday 9:00am to 6:00pm
Web: <http://d-link.co.kr>
E-mail: g2b@d-link.co.kr

New Zealand:

Tel: 0800-900-900
24/7 Technical Support
Web: <http://www.dlink.co.nz>
E-mail: support@dlink.co.nz

South Africa and Sub Sahara Region:

Tel: +27 12 661 2025
08600 DLINK (for South Africa only)
Monday to Friday 8:30am to 9:00pm South Africa Time
Web: <http://www.d-link.co.za>
E-mail: support@d-link.co.za

Saudi Arabia (KSA):

Tel: +966 01 217 0008
Fax: +966 01 217 0009
Saturday to Wednesday 9.30AM to 6.30PM
Thursdays 9.30AM to 2.00 PM
E-mail: Support.sa@dlink-me.com

D-Link Middle East - Dubai, U.A.E.

Plot No. S31102,
Jebel Ali Free Zone South,
P.O.Box 18224, Dubai, U.A.E.
Tel: +971-4-8809022
Fax: +971-4-8809066 / 8809069
Technical Support: +971-4-8809033
General Inquiries: info.me@dlink-me.com
Tech Support: support.me@dlink-me.com

Egypt

1, Makram Ebeid Street - City Lights Building
Nascity - Cairo, Egypt
Floor 6, office C2
Tel.: +2 02 26718375 - +2 02 26717280
Technical Support: +2 02 26738470
General Inquiries: info.eg@dlink-me.com
Tech Support: support.eg@dlink-me.com

Kingdom of Saudi Arabia

Office # 84 ,
Al Khaleej Building (Mujamathu Al-Khaleej)
Opp. King Fahd Road, Olaya
Riyadh - Saudi Arabia
Tel: +966 1 217 0008
Technical Support:
+966 1 2170009 / +966 2 6522951
General Inquiries: info.sa@dlink-me.com
Tech Support: support.sa@dlink-me.com

Pakistan

Islamabad Office:
61-A, Jinnah Avenue, Blue Area,
Suite # 11, EBC, Saudi Pak Tower,
Islamabad - Pakistan
Tel.: +92-51-2800397, 2800398
Fax: +92-51-2800399

Karachi Office:

D-147/1, KDA Scheme # 1,
Opposite Mudassir Park, Karsaz Road,
Karachi - Pakistan
Phone: +92-21-34548158, 34326649
Fax: +92-21-4375727
Technical Support: +92-21-34548310, 34305069
General Inquiries: info.pk@dlink-me.com
Tech Support: support.pk@dlink-me.com

Iran

Unit 5, 5th Floor, No. 20, 17th Alley , Bokharest
St. , Argentine Sq. ,
Tehran IRAN
Postal Code : 1513833817
Tel: +98-21-88880918,19
+98-21-88706653,54
General Inquiries: info.ir@dlink-me.com
Tech Support: support.ir@dlink-me.com

ISRAEL

מטלון סנטר
רח' המגשימים 20
קרית מטלון, פ"ת 49348
ת.ד. 7060
טלפון: 073-796-2797
אי-מאיל כללי: info@dlink.co.il
אי-מאיל תמיכה: support@dlink.co.il

Morocco

M.I.T.C
Route de Nouaceur angle RS et CT 1029
Bureau N° 312 ET 337
Casablanca , Maroc
Phone : +212 663 72 73 24
Email: support.na@dlink-me.com

Lebanon RMA center

Dbayeh/Lebanon
PO Box:901589
Tel: +961 4 54 49 71 Ext:14
Fax: +961 4 54 49 71 Ext:12
Email: taoun@dlink-me.com

Bahrain

Technical Support: +973 1 3332904

Kuwait:

Technical Support: + 965 22453939 / +965
22453949

Türkiye Merkez İrtibat Ofisi

Ayazağa Maslak yolu
Erdebil Cevahir İş Merkezi No: 5/A Ayazağa /
Maslak İstanbul
Tel: +90 212 2895659
Ücretsiz Müşteri Destek Hattı: 0 800 211 00 65
Web:www.dlink.com.tr
Teknik Destek: support.tr@dlink.com.tr

Руководство по быстрой установке DCS-3010

Этот документ содержит пошаговые инструкции по установке камеры DCS-3010 в сети. За дополнительной информацией об использовании камеры, пожалуйста, обратитесь к руководству пользователя на CD-диске из комплекта поставки или на web-сайте D-Link.

Шаги по установке

1. Проверьте комплект поставки по списку ниже.
2. Обзор устройства
3. Установка камеры
4. Настройка с помощью мастера

1. Комплект поставки

- HD видеокамера с поддержкой PoE DCS-3010
- Подставка для камеры
- Руководство пользователя и программное обеспечение на компакт-диске
- Ethernet-кабель 5 категории
- Адаптер питания
- Краткое руководство по установке
- Крепление для кольца объектива
- Шестигранный ключ

Если что-либо из перечисленного отсутствует, пожалуйста, обратитесь к поставщику.

2. Обзор устройства

Задняя панель

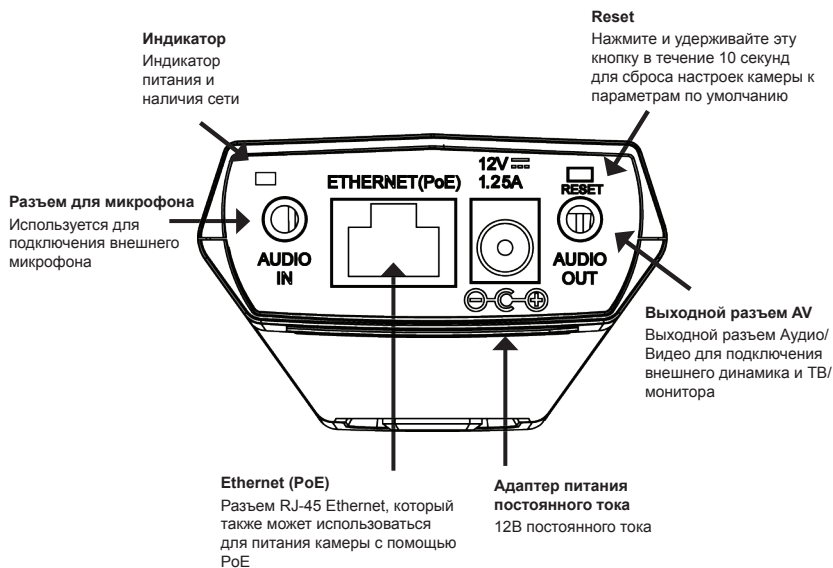

Передняя панель

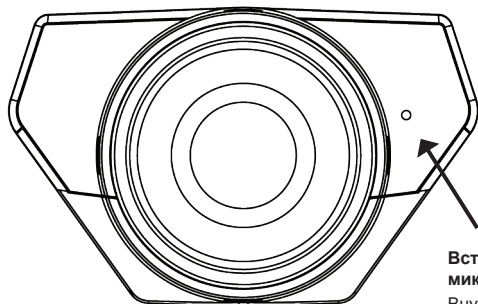

Встроенный
микрофон
Внутренний микрофон

Боковая панель

Слот для карты Micro SD
Локальная карта Micro SD для
хранения записанных изображений
и видео

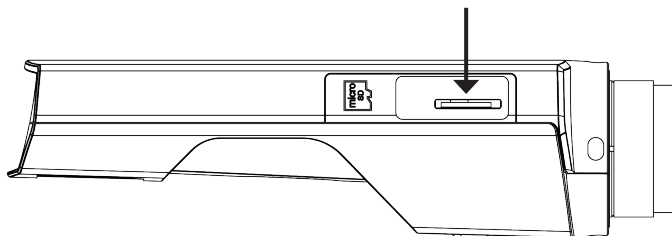

Панель кнопок

Разъем DC-Iris
Разъем для линз с
автоматической диафрагмой

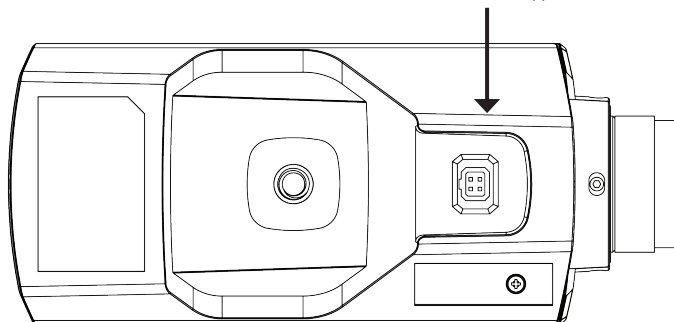

Правая панель

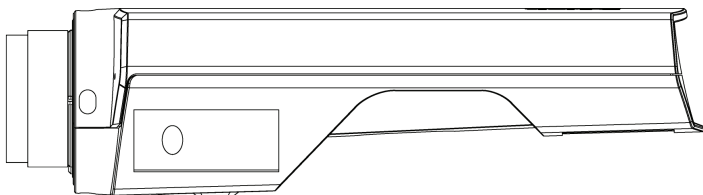

3. Установка устройства

Базовое соединение (без PoE)

Подключите камеру к коммутатору или маршрутизатору с помощью кабеля Ethernet. Подключите кабель адаптера питания к камере и к электрической розетке.

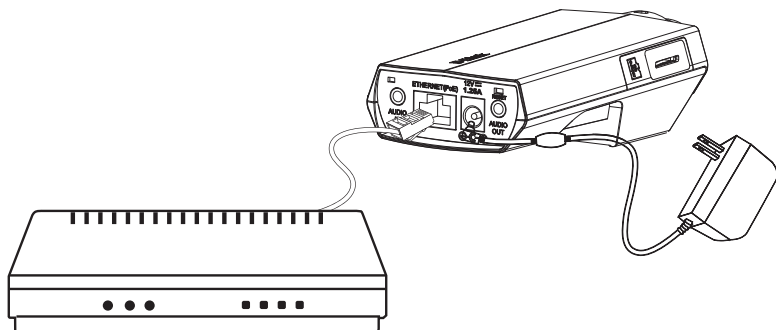

Подключение с использованием коммутатора PoE

Если используется PoE коммутатор или маршрутизатор, подключите сетевую камеру через кабель Ethernet. PoE будет передавать питание и данные по одному кабелю.

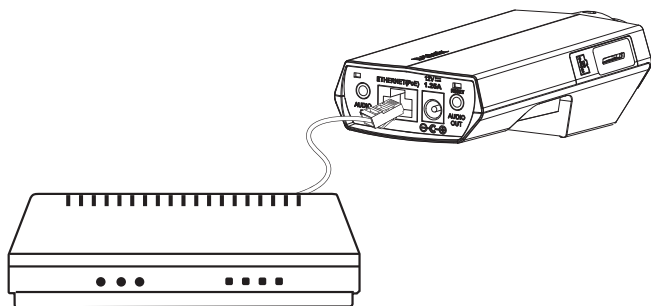

Примечание: Как только на устройство будет подаваться питание, индикатор загорится красным светом. Если устройство получило IP-адрес и станет доступным по сети, индикатор будет гореть зеленым светом.

4. Конфигурация с помощью мастера установки

Расположите компакт-диск DCS-3010 в CD-ROM привод компьютера для начала установки. Если функция автозагрузки на компьютере отключена, или файл D-Link Launcher не загрузился автоматически, то нажмите **Пуск > Выполнить**. Введите **D:\autorun.exe**, где D: означает букву привода CD-ROM.

Нажмите **Setup Wizard** для начала установки.



После нажатия на Setup Wizard откроется следующее окно.

Нажмите **Next** для продолжения.

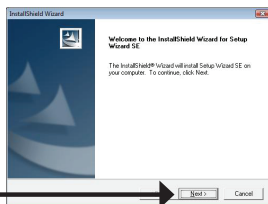

Нажмите **Yes** для принятия лицензионного соглашения.

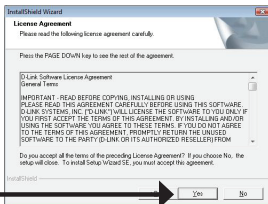

Чтобы начать процесс установки, нажмите **Next**.

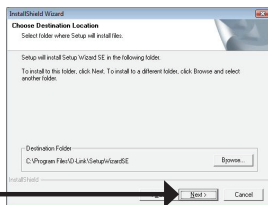

Примечание: Установка может занять несколько минут.

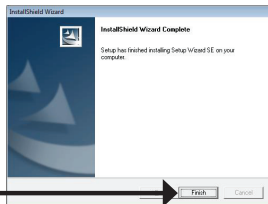

Нажмите **Finish** для завершения установки.

Нажмите на иконку **D-Link Setup Wizard SE**, созданную в меню Windows - Пуск.

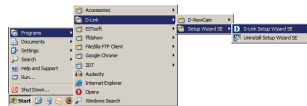

Пуск > D-Link > Setup Wizard SE

Появится мастер установки и отобразит MAC-адрес и IP-адрес камеры. Если в сети присутствует DHCP-сервер, то будет отображен корректный IP-адрес. Если в сети не используется DHCP-сервер, то будет отображен статический IP-адрес по умолчанию для сетевой камеры - **192.168.0.20**.

Нажмите кнопку **Wizard** для продолжения.



Введите имя администратора и пароль. Для первой регистрации имя администратора по умолчанию **admin** с пустым паролем.

Нажмите **Next** для перехода на следующую страницу.



Выберите DHCP-сервер, если камера при начальной загрузке получает IP-адрес автоматически. Выберите статический IP-адрес, если камера при загрузке каждый раз будет использовать тот же самый IP-адрес.

Нажмите **Next** для перехода на следующую страницу.

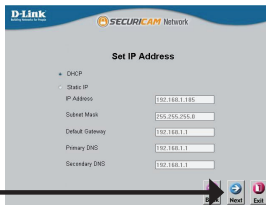

Уделите немного времени для подтверждения настроек и нажмите **Restart**.

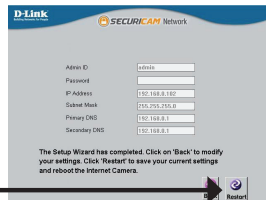

Обзор камеры через web-браузер

Нажмите на иконку **D-Link Setup Wizard SE**, созданную в меню Windows - Пуск.

Пуск > D-Link > Setup Wizard SE

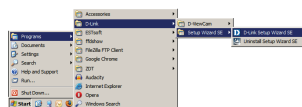

Выберите камеру и нажмите кнопку **"Link"** для доступа к web-странице конфигурации.

Мастер установки автоматически откроется в web-браузере с IP-адресом камеры.

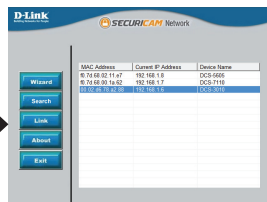

Введите имя пользователя по умолчанию - **admin** и оставьте поле с паролем пустым. Нажмите **OK** для продолжения.

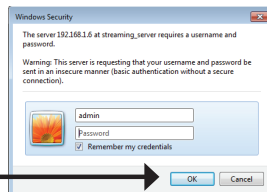

Данный раздел отображает реальное видео в реальном времени. Здесь можно выбрать свой профиль и отображение видео или управлять камерой. За дополнительной информацией по веб-конфигурации, пожалуйста, обратитесь к руководству пользователя на компакт-диске или на web-сайте D-Link.

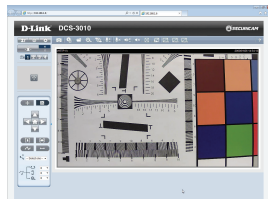

Техническая поддержка

Обновления программного обеспечения и документация доступны на Интернет-сайте D-Link. D-Link предоставляет бесплатную поддержку для клиентов в течение гарантийного срока. Клиенты могут обратиться в группу технической поддержки D-Link по телефону или через Интернет.

Техническая поддержка D-Link:

8-800-700-5465

Техническая поддержка через Интернет:

<http://www.dlink.ru>

e-mail: support@dlink.ru

Офисы

Россия

129626 г. Москва
Графский пер., 14
Тел.: +7 (495) 744-0099

Украина

04080 г. Киев, ул. Межигорская, 87-А, офис 18
Тел.: +38 (044) 545-64-40
E-mail: kiev@dlink.ru

Беларусь

220114, г. Минск, проспект Независимости,
169, БЦ "XXI Век"
Тел.: +375(17) 218-13-65
E-mail: minsk@dlink.ru

Казахстан

050008, г. Алматы, ул. Курмангазы, 143
(уг. Муканова)
Тел./факс: +7 727 378-55-90
E-mail: almaty@dlink.ru

Армения

0038, г. Ереван, ул. Абеяна, 6/1, 4 этаж
Тел./Факс: + 374 (10) 398-667
E-mail: erevan@dlink.ru

Грузия

Тел./Факс: +995 (593) 98-3210

Lietuva

09120, Vilnius, Žirmūnų 139-303
Tel./faks. +370 (5) 236-3629
E-mail: info@dlink.lt

Eesti

Mustamae 55-314
10621, Tallinn
Tel +372 613 9771
e-mail: info@dlink.ee

Latvija

Mazā noietņu 45/53 (ieeja no Nāras ielas)
LV-1002, Rīga
Tel.: +371 7 618-703
Fax: +371 7 618-706
e-pasts: info@dlink.lv

Guía de Instalación Rápida DCS-3010

Esta guía de instalación proporciona instrucciones básicas para la instalación de la cámara DCS-3010 en su red. Para obtener información adicional acerca de cómo utilizar la cámara, consulte el Manual del Usuario que se encuentra disponible en el CD incluido en este paquete o desde el sitio web de soporte de D-Link.

Pasos para la Instalación

1. Verificar el contenido del empaque con la lista de abajo
2. Descripción de Hardware
3. Instalación de Hardware
4. Configuración con Asistente

1. Contenido del Empaque

- Cámara de red DCS-3010 de alta definición PoE
- Soporte de cámara
- Manual y software en CD-ROM
- Cable Ethernet CAT5
- Adaptador de alimentación
- Guía de instalación rápida
- Anillo para fijación de lente
- Llave Allen

Si alguno de los ítems no se encuentra, por favor contáctese con su vendedor.

2. Descripción de Hardware

Panel Posterior

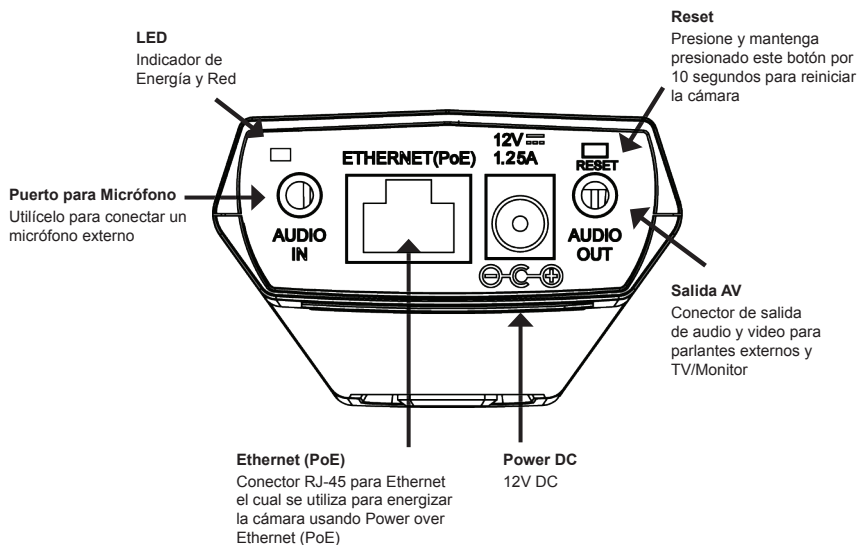

Panel Frontal

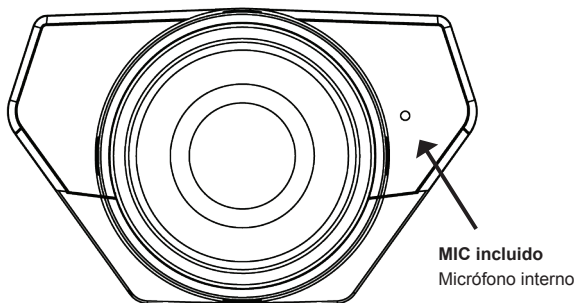

Panel lateral

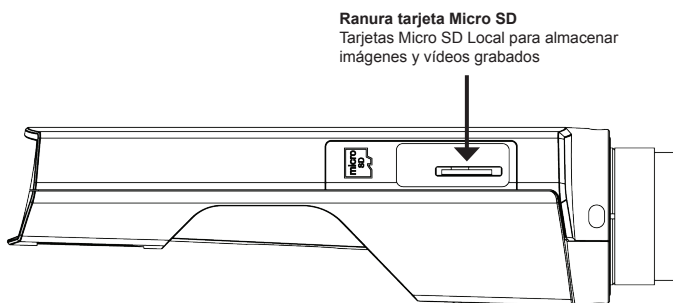

Panel de botones

Conector DC-Iris
Conector para lente DC auto iris

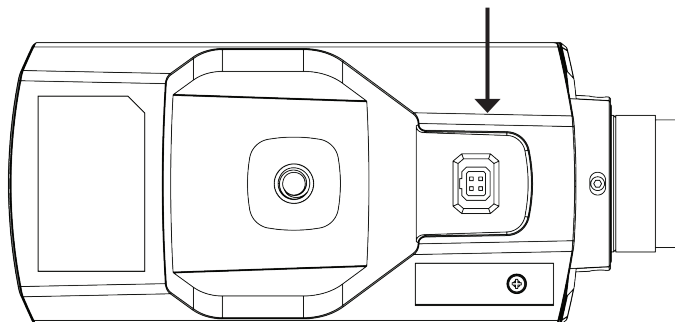

Panel Derecho

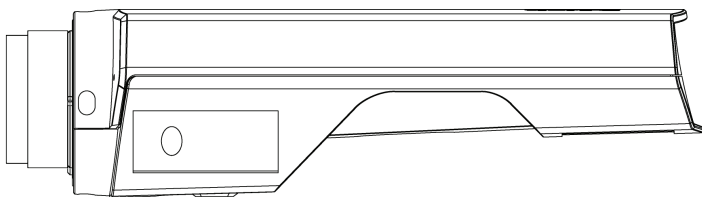

3. Instalación de Hardware

Conexión Básica (Sin PoE)

Conecte la cámara a su switch o router mediante un cable Ethernet.

Conecte el adaptador de poder suministrado desde la cámara a una toma de corriente.

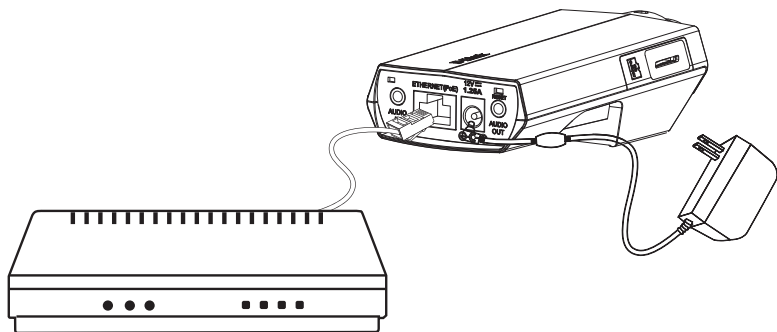

Conexión utilizando un Switch PoE

Si utiliza un switch PoE o un router, conecte la cámara de red a través del cable Ethernet. PoE transmite energía y datos sobre un único cable.

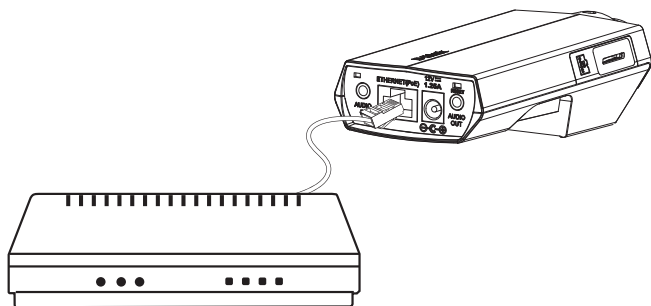

Nota: Una vez que el poder se ha establecido, el LED se iluminará rojo. Cuando el dispositivo haya obtenido una dirección IP y es accesible, el LED se vuelve verde.

4. Configuración Utilizando el Asistente

Inserte el CD de DCS-3010 en el lector de CD-ROM de su computador para comenzar la instalación. Si la función Auto-Ejecutar en su computador esta deshabilitada, o si al ejecutar el Programa de D-Link falla al iniciar, haga clic en **Inicio>Ejecutar** y escriba **D:\autorun.exe**, donde D representa la letra de la Unidad de su Lector de CD-ROM.

Haga clic en **Siguiente** para comenzar la instalación.



Después de hacer clic en **Asistente de Configuración**, la siguiente ventana aparecerá.

Haga clic en **Siguiente** para continuar.

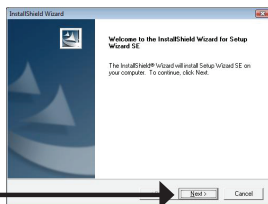

Haga clic en **SI** para aceptar el acuerdo de Licencia.

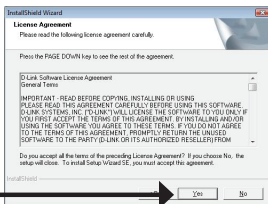

Para comenzar el proceso de instalación, haga clic en **Siguiente**.

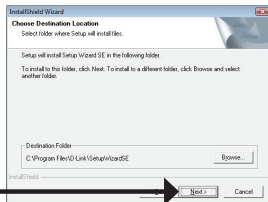

Nota: La instalación podría tomar varios minutos para finalizar.

Haga clic en **Finalizar** para completar la instalación.

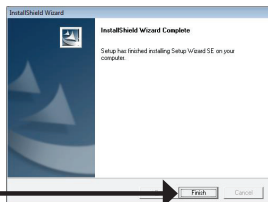

Haga clic en el icono **Asistente de configuración D-Link** que fue creado en su menú de inicio de Windows.

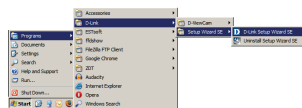

Inicio>D-Link>Asistente de Configuración

El Asistente de Configuración aparecerá y mostrará la dirección MAC y la dirección IP de su cámara(s). Si usted tiene un servidor DHCP en la red, una dirección IP válida será mostrada. Si la red no utiliza un servidor DHCP, por defecto la cámara de red mostrará la siguiente dirección IP **192.168.0.20**.

Haga clic en el Botón **Asistente** para continuar.



Ingrese el ID de admin y la Contraseña. Cuando ingresa por primera vez, el ID de admin por defecto es **admin** y la contraseña debe quedar en blanco.

Haga clic en **siguiente**, para proceder a la siguiente página.

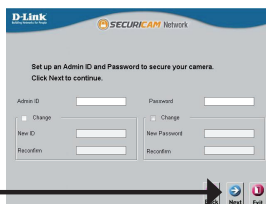

Seleccione DHCP si su cámara obtiene una dirección IP automáticamente cuando se inicia. Seleccione IP Estática si la cámara utilizará la misma dirección IP cada vez que se inicie.

Haga clic en **Siguiente** para proceder a la siguiente página.

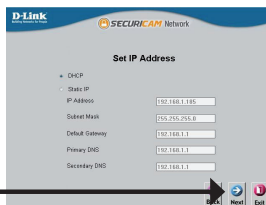

Tome un momento para confirmar la configuración y haga clic en **Reiniciar**.

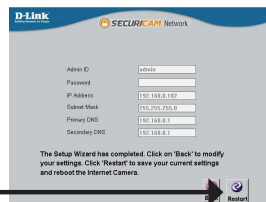

Ver Cámara vía Navegador Web

Haga clic en el icono **Asistente de configuración D-Link** que fue creado en su menú de inicio de Windows.

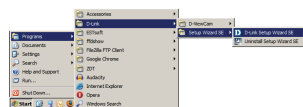

Inicio>D-Link>Asistente de configuración

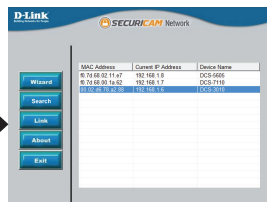

Seleccione la cámara y haga clic en el botón etiquetado como **"Link"** para acceder a la configuración Web.

El Asistente de Configuración automáticamente abrirá su Navegador Web en la dirección IP de la cámara.

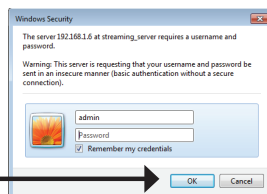

Ingrese **admin** como nombre de usuario por defecto y la contraseña dejar en blanco. Haga clic en **OK** para continuar.

Esta sección muestra vídeo en vivo de su cámara. Se puede seleccionar el perfil de video y ver o manejar la cámara. Para obtener información adicional acerca de la configuración web, por favor consulte el Manual del Usuario incluido en el CD-ROM o en el sitio web de D-Link.

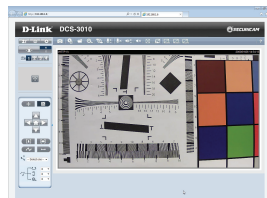

Suporte Técnico

Usted puede encontrar actualizaciones de softwares o firmwares y documentación para usuarios a través de nuestro sitio www.dlinkla.com

SOPORTE TÉCNICO PARA USUARIOS EN LATINO AMERICA

Soporte técnico a través de los siguientes teléfonos de D-Link

PAIS	NUMERO
Argentina	0800 - 12235465
Chile	800 260200
Colombia	01800 - 510070
Costa Rica	0800 - 0521478
Ecuador	1800 - 035465
El Salvador	800 - 6335
Guatemala	1800 - 8350255
México	01800 - 0626270
Panamá	011 008000525465
Perú	0800 - 00968
Venezuela	0800 - 1005767

Soporte Técnico de D-Link a través de Internet

Horario de atención Soporte Técnico en www.dlinkla.com

e-mail: soporte@dlinkla.com & consultas@dlinkla.com

DCS-3010 Guia de Instalação Rápida

Esse guia de instalação fornece instruções básicas para instalar a Câmera de Rede DCS-3010 na sua rede. Para informações adicionais sobre como utilizar a câmera, favor consultar o Manual do Usuário, que está disponível no CD incluído na embalagem, ou o website de suporte da D-Link.

Etapas da instalação

1. Verifique o conteúdo da embalagem para certificar-se de que os itens abaixo estão incluídos.
2. Visão Geral do Hardware
3. Instalação do hardware
4. Configuração com o assistente

1. Conteúdo da embalagem

- Câmera de Rede DCS-3010 HD PoE
- Suporte da Câmera
- CD- ROM com Manual e Software
- Cabo Ethernet CAT5
- Adaptador de energia
- Guia de Instalação Rápida
- Anel de fixação da Lente
- Chave Allen

Se qualquer dos itens acima estiver faltando, favor contatar o seu revendedor.

2. Visão Geral do Hardware

Painel Traseiro

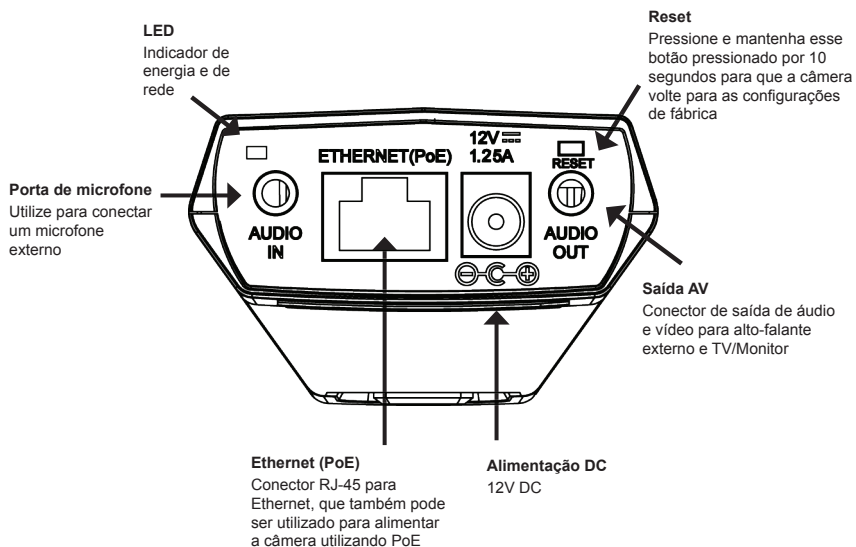

Painel Frontal

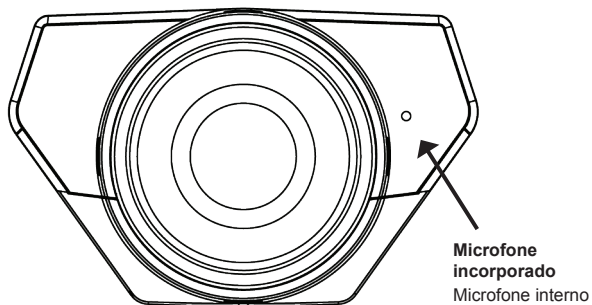

Painel Lateral

Slot para cartão micro SD
Cartão Micro SD local para armazenar
imagens e vídeos gravados

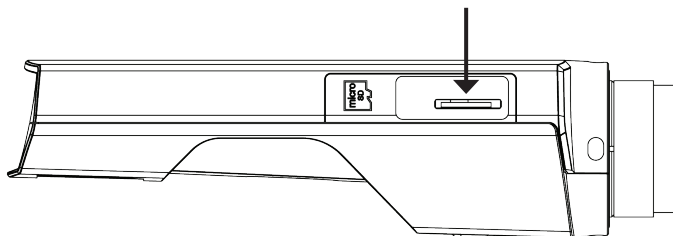

Painel de Botões

Conector DC-Iris
Conector para lentes
DC com auto íris

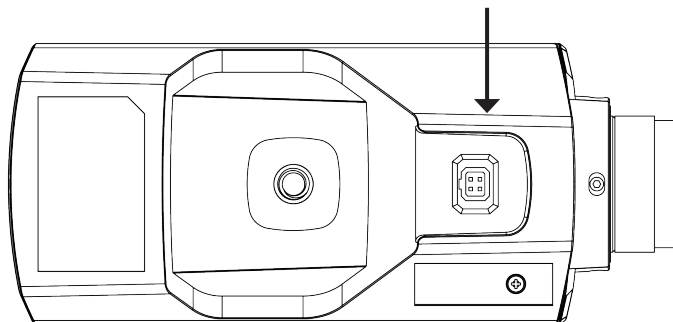

Painel direito

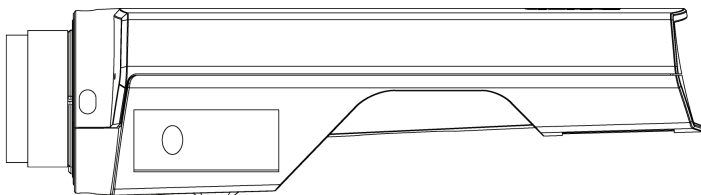

3. Instalação do hardware

Conexão básica (sem PoE)

Conecte a câmera ao seu switch ou roteador via o cabo Ethernet.
Conecte o cabo de alimentação fornecido da câmera em uma tomada.

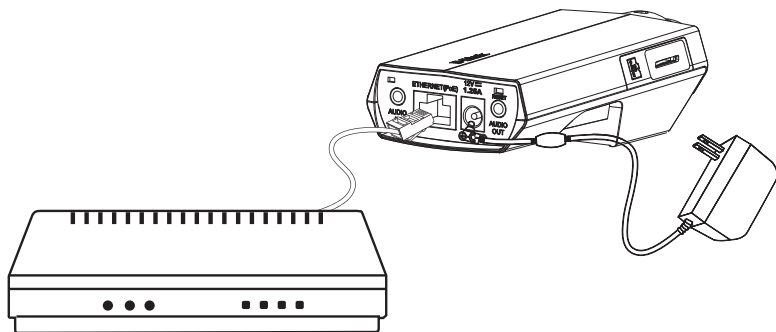

Conexão utilizando um switch PoE

Se estiver utilizando um switch ou roteador PoE, conecte a câmera de rede via o cabo Ethernet.

O PoE vai transmitir a energia e dados por um único cabo.

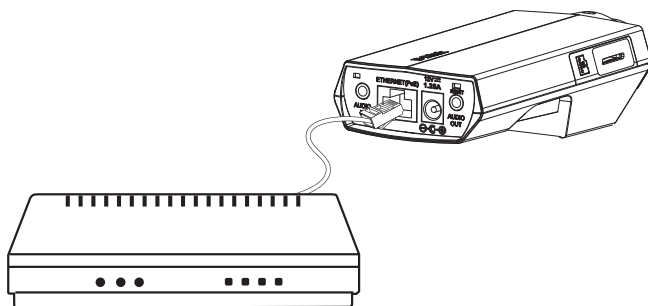

Observação: Uma vez que o dispositivo for energizado, o LED ficará vermelho.

Quando o dispositivo tiver obtido um endereço IP e estiver acessível, o LED ficará verde.

4. Configuração com o assistente

Insira o CD da câmera DCS-3010 na unidade de CD-ROM do seu computador para começar a instalação. Caso a função de execução automática (Autorun) no seu computador estiver desabilitada, ou se o Inicializador da D-Link (D-Link Launcher) não iniciar automaticamente, clique em **Start > Run**. Digite **D:\autorun.exe**, onde **D:** representa a letra da sua unidade de CD-ROM.

Clique em **Setup Wizard** para começar a instalação.



Após clicar em Setup Wizard, a janela a seguir será exibida.

Clique em **Next** para continuar.

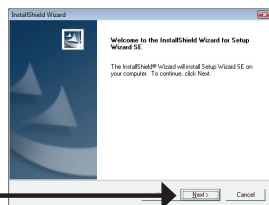

Clique em **Yes** para aceitar o Contrato de Licença.

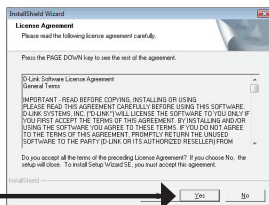

Para iniciar o processo de instalação, clique em **Next**.

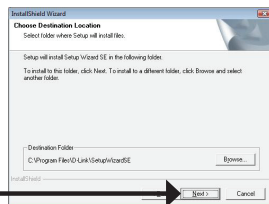

Observação: A instalação pode levar vários minutos para ser concluída.

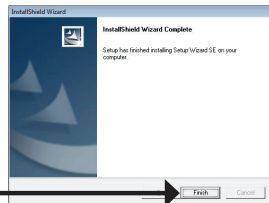

Clique em **Finish** para concluir a instalação.

Clique no ícone **D-Link Setup Wizard SE** que foi criado no seu menu Iniciar do Windows.

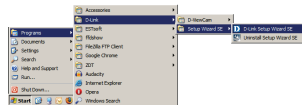

Start > D-Link > Setup Wizard SE

O Setup Wizard será exibido e exibirá o Endereço MAC e Endereço IP da(s) sua(s) câmera(s). Se você tiver um servidor DHCP na sua rede, um Endereço IP válido será exibido. Caso a sua rede não utiliza um servidor DHCP, o endereço IP estático padrão da câmera de rede **192.168.0.20** será exibido.

Clique no botão **Wizard** para continuar.



Insira o ID do Admin e senha. Ao efetuar o login pela primeira vez, o ID do Admin padrão é **admin** e a senha é palavra a ser removida em branco.

Clique em **Next** para ir para a próxima página.

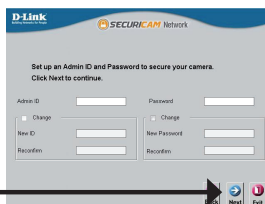

Selecione DHCP caso deseje que sua câmera obtenha um endereço de IP automaticamente ao ser inicializada. Selecione IP estático caso deseje que a sua câmera utilize o mesmo endereço IP cada vez que for inicializada.

Clique em **Next** para ir para a próxima página.

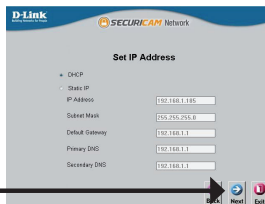

Confirme as configurações e clique em **Restart**.

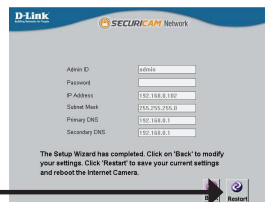
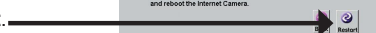

Visualizando a câmera por meio do navegador web

Clique no ícone **D-Link Setup Wizard SE** que foi criado no seu menu Iniciar do Windows.

Start > D-Link > Setup Wizard SE

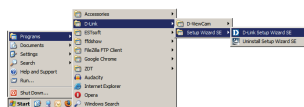

Selecione a câmera e clique no botão intitulado **"Link"** para acessar a configuração web.

O Setup Wizard vai abrir o seu navegador web automaticamente no endereço IP da câmera.



Digite **admin** como nome de usuário (username) padrão e deixe o campo de senha (password) em branco. Clique em **OK** para continuar.

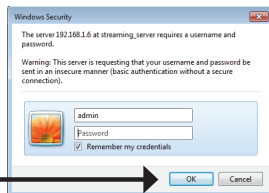

Essa seção exibe o vídeo ao vivo da sua câmera. Você pode selecionar o seu perfil de vídeo e ver ou operar a câmera. Para informações adicionais sobre a configuração web, favor consultar o manual do usuário incluído no CD-ROM ou o website da D-Link.

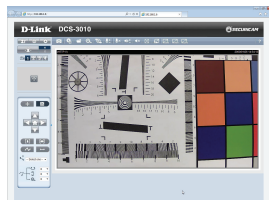

Suporte Técnico

Caso tenha dúvidas na instalação do produto, entre em contato com o Suporte Técnico D-Link.

Acesse o site: www.dlink.com.br/suporte

DCS-3010 快速安裝手冊

本手冊將導引您將DCS-3010安裝連結至您的網路。詳細的產品操作說明敬請參考包裝隨附光碟內所提供的產品操作手冊，或至D-Link網站下載。

安裝步驟

1. 確認包裝配件是否齊全如下列表
2. 硬體檢視
3. 軟體安裝
4. 設定精靈導引設定

1. 包裝清單

- DCS-3010 HD網路供電攝影機
- 攝影機架
- 光碟內附使用說明和軟體
- CAT5乙太網路線
- 電源供應器
- 快速安裝手冊
- 鏡頭環裝置
- 六角板手

假如有缺少任何配件敬請於您購買的經銷商聯繫。

2.硬體檢視

設備後面板

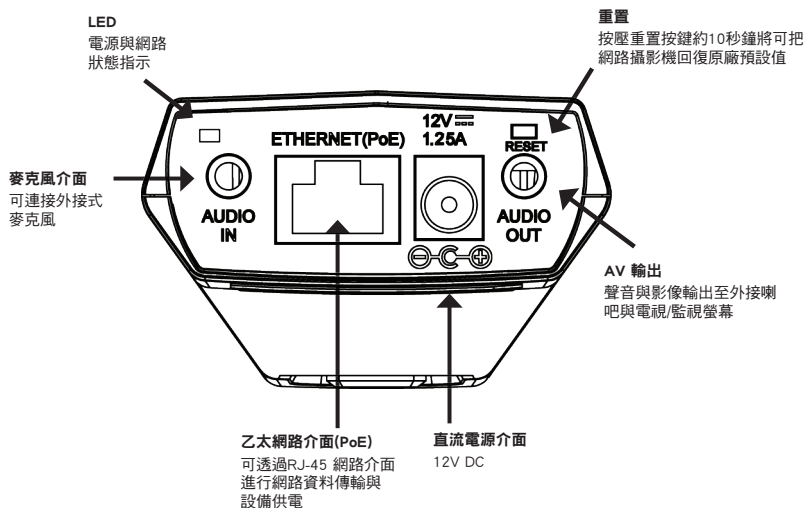

設備前端

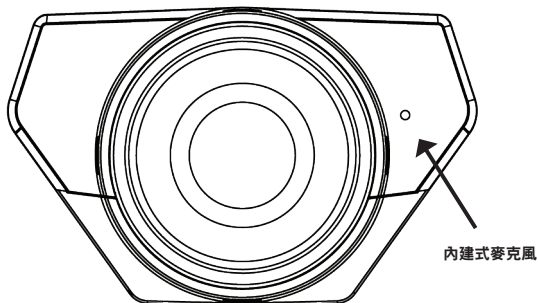

設備側面

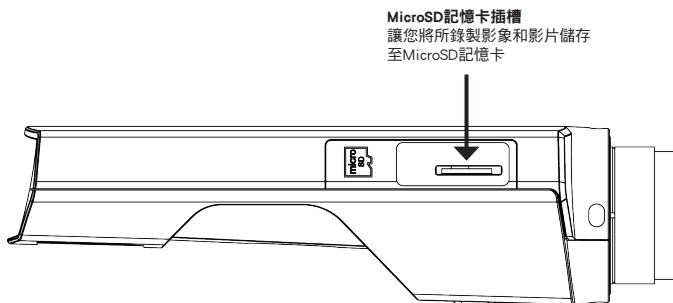

按鈕面板

DC-光圈連接器
連接DC 自動光圈鏡頭

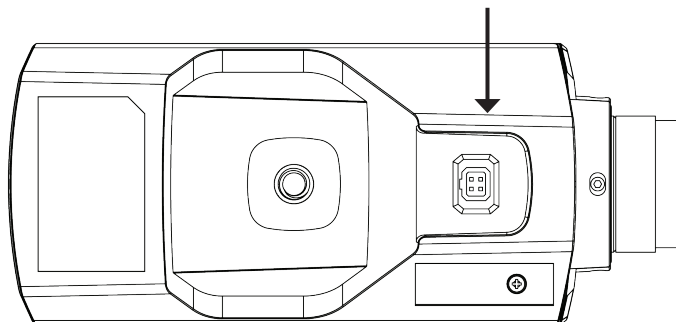

設備右端

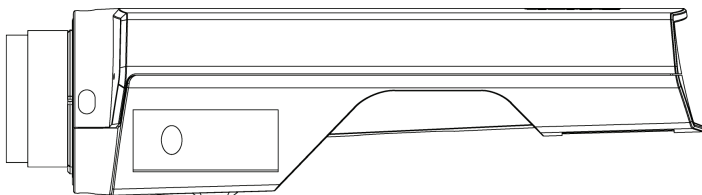

3.硬體安裝

基本連線(不含PoE)

透過網路線將網路攝影機連接至您網路環境中的網路交換器或寬頻路由器。將網路攝影機連接上電源供應器。

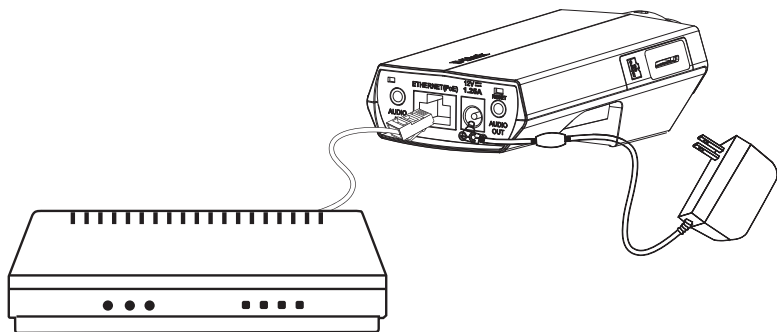

透過PoE網路交換器連線

假如您使用PoE網路交換器,請透過網路線將網路攝影機連接至PoE網路交換器的網路埠。PoE將會同時透過網路線傳送電源與資料。

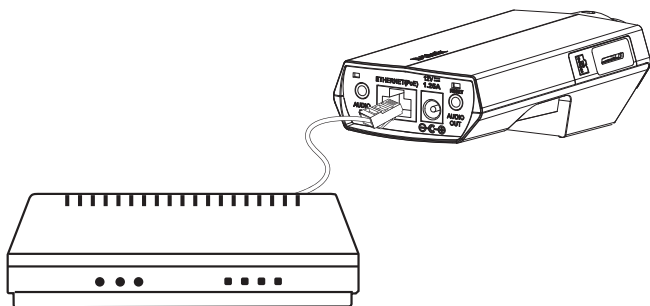

備註:當您正確的連接設備電源，LED燈號將會顯示紅色。當設備取得IP位址，LED燈號將會顯示綠色。

4. 設定精靈導引設定

將DCS-3010 光碟放入您電腦的光碟機開始進行安裝程序。假如您電腦自動執行的機制是關閉的或是光碟無法自動執行，請點選您電腦作業系統**開始>執行**。輸入D:\autorun.exe (當D:為您光碟機的代號)。

點擊**Setup Wizard** 開始進行安裝。



當您點擊完設定精靈後以下的視窗將會開啟。

點擊**下一步繼續**。

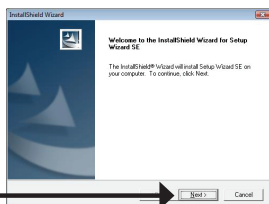

點擊**Yes**同意許可協議。

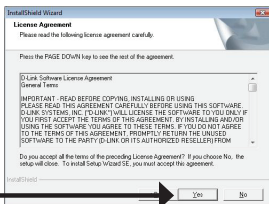

開始進行安裝程序，點擊**下一步**。

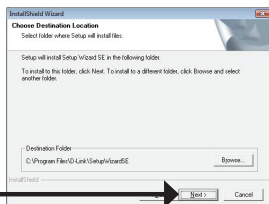

備註:安裝程序將會在幾分鐘內完成。

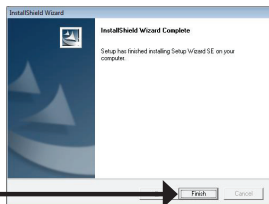

點擊**Finish** 完成安裝。

點擊您Windows作業系統所有程式列表中顯示D-Link Setup Wizard SE的圖示。

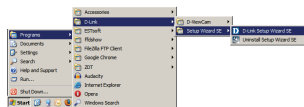

開始>所有程式>D-Link> Setup Wizard SE

設定精靈將會顯示您網路攝影機的IP與MAC位址。假如您的網路中具備DHCP伺服器，所指派的IP位址將會顯示。假如您的網路中不具備DHCP伺服器，網路攝影機的預設IP位址為**192.168.0.20**。

點擊 **Wizard** 按鍵繼續。



輸入管理者的帳號與密碼。若您是第一次登入，預設的管理者帳號為" admin"，密碼欄位空白不需輸入。

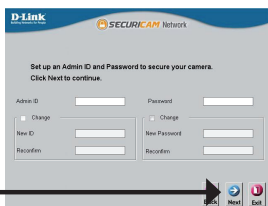

點擊**Next**，進行下一個程序。

當您希望攝影機由DHCP 伺服器於每次攝影機重開機時指派IP位址請選擇DHCP。

當您希望攝影機每次重開機都使用相同IP位址請選擇Static IP。



點擊 **Next**，進行下一個程序。

請確認您的相關設定然後點選**Restart**將設備重新開機。

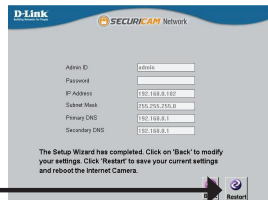

透過網頁瀏覽器觀看網路攝影機

點擊您Windows作業系統所有程式列表中顯示D-Link Setup Wizard SE的圖示。

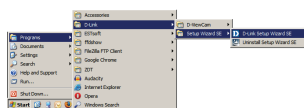

開始>所有程式>D-Link> Setup Wizard SE

選擇您所要觀看的網路攝影機然後點擊” Link ” 透過網頁存取攝影機並進行設定。



設定精靈將會自動開啟您電腦網頁瀏覽器並且顯示攝影機的設定畫面。

登入視窗請輸入管理者帳號” admin ” 然後預設密碼空白。點擊” 確認 ” 繼續。

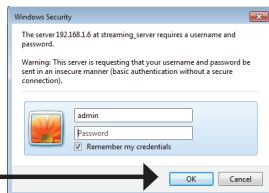

本章節將顯示您網路攝影機的即時影像。您可以選擇您網路攝影機所要顯示的影像格式。更多的網頁式設定說明,請參考光碟內的產品使用手冊。

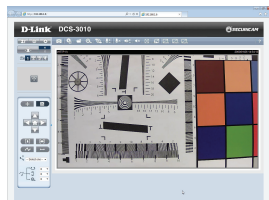

D-Link 友訊科技 台灣分公司 技術支援資訊

如果您還有任何本使用手冊無法協助您解決的產品相關問題，台灣地區用戶可以透過我們的網站、電子郵件或電話等方式與D-Link台灣地區技術支援工程師聯絡。

D-Link 免付費技術諮詢專線

0800-002-615

手機付費電話 (02)6600-0123#8715

服務時間：週一至週五，早上9:00到晚上9:00

(不含周六、日及國定假日)

網 站：<http://www.dlink.com.tw>

電子郵件：dssqa_service@dlink.com.tw

如果您是台灣地區以外的用戶，請參考D-Link網站，全球各地分公司的聯絡資訊以取得相關支援服務。

產品保固期限、台灣區維修據點查詢，請參考以下網頁說明：

<http://www.dlink.com.tw>

產品維修：

使用者可直接送至全省聯強直營維修站或請洽您的原購買經銷商。

Panduan Cepat Pemasangan DCS-3010

Panduan ini memberikan instruksi dasar mengenai cara memasang Network Kamera DCS-3010 ke dalam jaringan anda. Untuk informasi tambahan mengenai cara pemakaian kamera, silahkan lihat Manual yang tersedia di CD yang sudah termasuk dalam kemasan atau melalui website support D-Link.

Langkah-langkah Instalasi

1. Sesuaikan isi paket dengan daftar dibawah ini
2. Gambaran perangkat keras
3. Instalasi perangkat keras
4. Panduan konfigurasi

1. Isi Kemasan

- Kamera Jaringan PoE HD DCS-3010
- Stand kamera
- Manual dan perangkat lunak dalam CD-ROM
- Kabel Ethernet CAT5
- Adaptor daya
- Panduan Instalasi cepat
- Pengatur ring lensa
- Kunci-L

Bila salah satu dari barang tersebut diatas tidak ada, silahkan hubungi reseller anda.

2. Gambaran Perangkat Keras

Panel Belakang

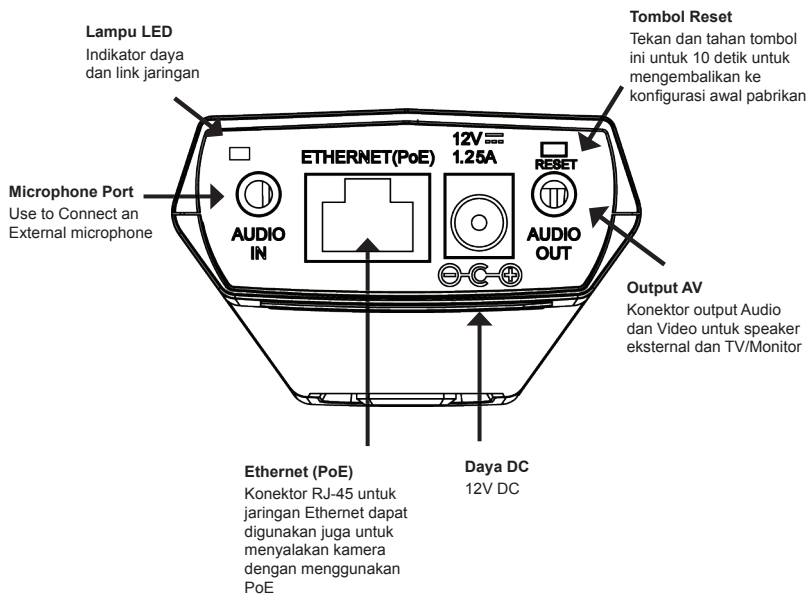

Panel Depan

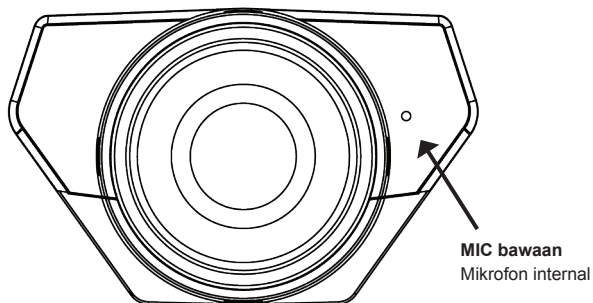

Panel Samping

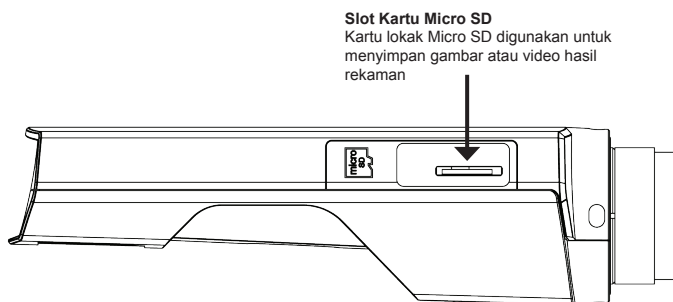

Panel Bawah

Konektor DC-Iris
Konektor untuk lensa
DC auto iris

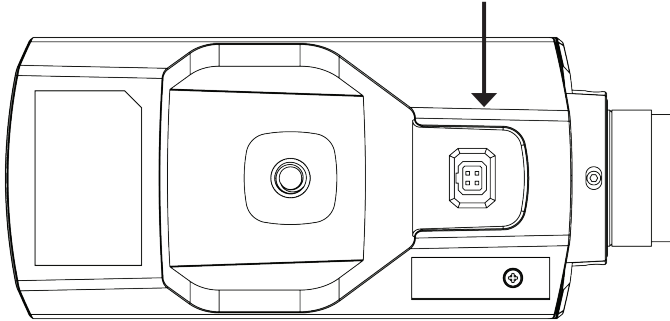

Panel Kanan

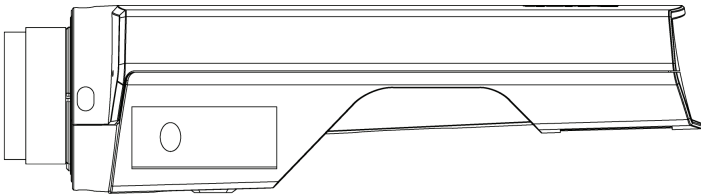

3. Instalasi Perangkat Keras

Sambungan Dasar (tanpa PoE)

Menyambungkan kamera ke switch atau router melalui kabel Ethernet

Menghubungkan kamera ke outlet daya dengan menggunakan kabel daya.

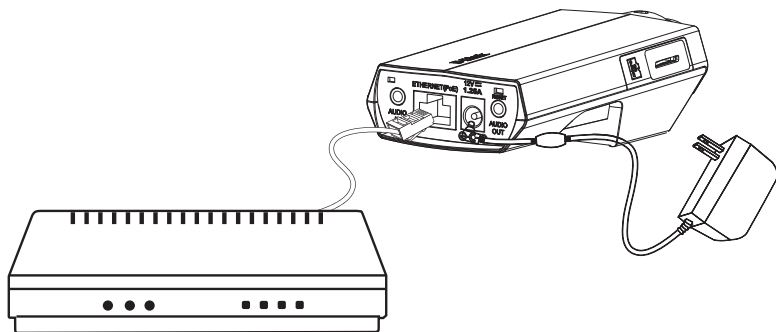

Sambungan dengan menggunakan switch PoE

Bila menggunakan switch atau router PoE, hubungkan kamera anda melalui kabel Ethernet.

PoE akan mengirimkan daya maupun data melalui satu kabel yang sama.

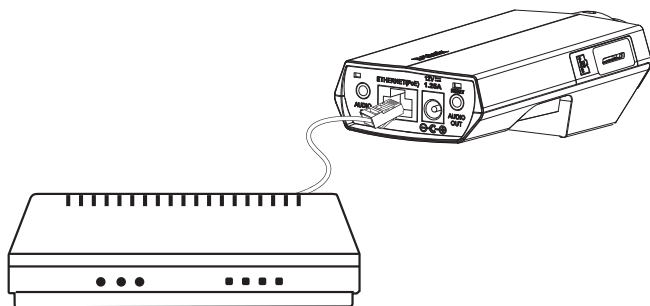

Catatan: Setelah daya listrik masuk, maka lampu LED akan berwarna merah. Bila alat telah mendapatkan alamat IP dan dapat diakses, lampu LED akan menjadi hijau

4. Panduan Konfigurasi

Masukkan CD dari DCS-3010 ke dalam CD-ROM komputer anda untuk memulai instalasi. Bila fungsi "autorun" pada PC anda dimatikan, atau bila D-Link Launcher tidak berjalan secara otomatis, maka klik **Start** → **Run**. Ketikkan **D:\autorun.exe**, dimana D: menunjuk kepada drive dimana CD-ROM anda berada.

Klik pada "**Setup Wizard**" untuk memulai instalasi



Setelah melakukan "**Setup Wizard**", maka jendela berikut akan terbuka.

Klik "**Next**" untuk melanjutkan.

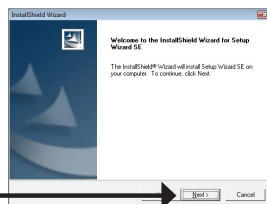

Klik "**Yes**" untuk menerima persetujuan lisensi.

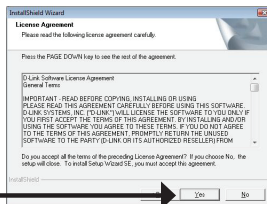

Untuk memulai proses instalasi, klik "**Next**".

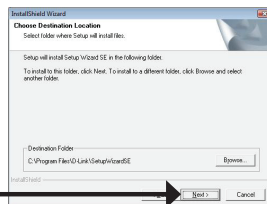

Catatan: Instalasi akan memakan waktu beberapa menit sampai selesai

Klik "**Finish**" untuk menyelesaikan instalasi.

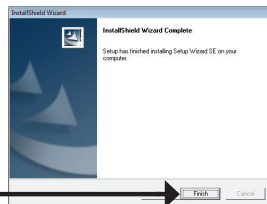

Klik pada ikon **D-Link Setup Wizard SE** yang terbentuk pada menu Windows Start anda.

Start → **D-Link** → **Setup Wizard SE**

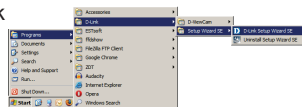

Jendela panduan Instalasi akan timbul dan alamat MAC beserta IP kamera anda akan ditampilkan. Bila anda memiliki DHCP server di jaringan anda, maka alamat IP yang sah akan ditampilkan. Bila jaringan anda tidak memiliki server DHCP, maka alamat IP statis kamera anda **192.168.0.20** yang akan ditampilkan.

Klik pada tombol "**Wizard**" untuk melanjutkan.



Masukkan ID beserta kata sandinya. Bila masuk untuk pertama kalinya, maka ID bawaannya adalah **admin** dan kata sandinya dibiarkan kosong.

Klik "**Next**" untuk melanjutkan ke halaman berikut.

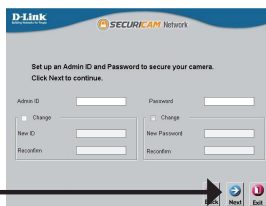

Pilih DHCP apabila kamera anda memperoleh alamat IP secara otomatis disaat menyala untuk pertama kali. Pilih "static IP" apabila kamera anda selalu menggunakan alamat IP yang sama setiap kali kamera menyala.

Klik "**Next**" untuk melanjutkan ke halaman berikutnya.



Ambil waktu sejenak untuk memastikan settingan anda, kemudian klik **Restart**.

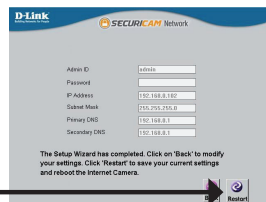

Dukungan Teknis

Update perangkat lunak dan dokumentasi pengguna dapat diperoleh pada situs web D-Link.
Dukungan Teknis untuk pelanggan:

Dukungan Teknis D-Link melalui telepon:

Tel: +62-21-5731610

Dukungan Teknis D-Link melalui Internet:

Email : support@dlink.co.id

Website : <http://support.dlink.co.id>

D-Link®



Ver. 1.10(DI)
2013/01/24
a11633L8B013