

USER MANUAL

DCS-3112

VERSION 1.00



D-Link[®]

SURVEILLANCE

Table of Contents

Product Overview	4	Advanced.....	40
Package Contents	4	Digital Input/Output	40
Hardware Overview	5	RS-485.....	41
Hardware Overview	5	ICR.....	42
Rear	5	HTTPS	43
Front	6	Access List.....	44
Configuration with Wizard.....	9	Maintenance	45
Configuration	14	Device Management.....	45
Web-based Configuration Utility	14	Backup and Restore	46
Live Video	16	Firmware Upgrade	47
Setup	18	Status	48
Wizard.....	18	Device Info.....	48
Internet Connection Setup Wizard.....	18	Logs	49
Motion Detection Setup Wizard	21	Help	50
Network Setup	23	Appendix	51
Dynamic DNS	25	DI/DO Schematics	51
Image Setup	26	Technical Specifications	52
Audio and Video	27		
Motion Detection.....	29		
Time and Date	30		
Event Setup	31		
Application	32		
Add Server.....	33		
Add Media.....	34		
SD Card	39		

Preface

D-Link reserves the right to revise this publication and to make changes in the contents hereof without obligation to notify any person or organization of such revisions or changes.

Manual Revisions

Revision	Date	Description
1.0	June 21, 2011	DCS-3112 Revision A1 with firmware version V1.00

Trademarks

D-Link and the D-Link logo are trademarks or registered trademarks of D-Link Corporation or its subsidiaries in the United States or other countries. All other company or product names mentioned herein are trademarks or registered trademarks of their respective companies.

Copyright © 2011 D-Link Corporation.

All rights reserved. This publication may not be reproduced, in whole or in part, without prior expressed written permission from D-Link Systems, Inc.

Package Contents



**DCS-3112
Network Camera**



Camera Stand

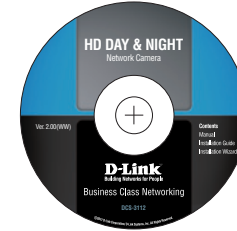

**Manual and Wizard
on CD-ROM**



**C-CS Mount Adapter
(5mm Ring)**



**CAT5 Ethernet
Cable**



Power Adapter

If any of the above items are missing, please contact your reseller.

Hardware Overview

Rear

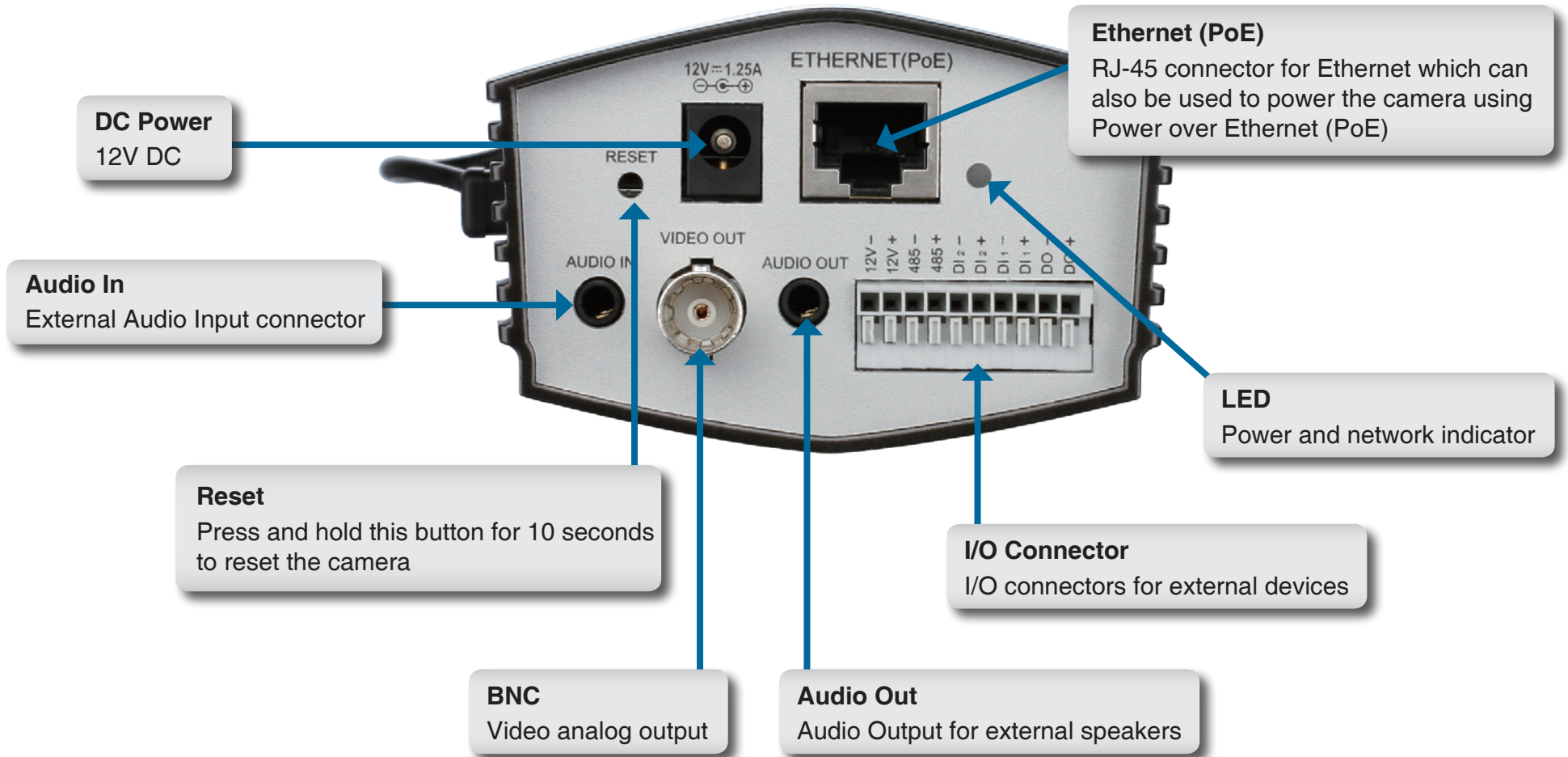

Front



Lens Connector
Connect to a CS mount

ICR Sensor
The IR-Cut Removable sensor judges lighting conditions and switches from color to infrared accordingly

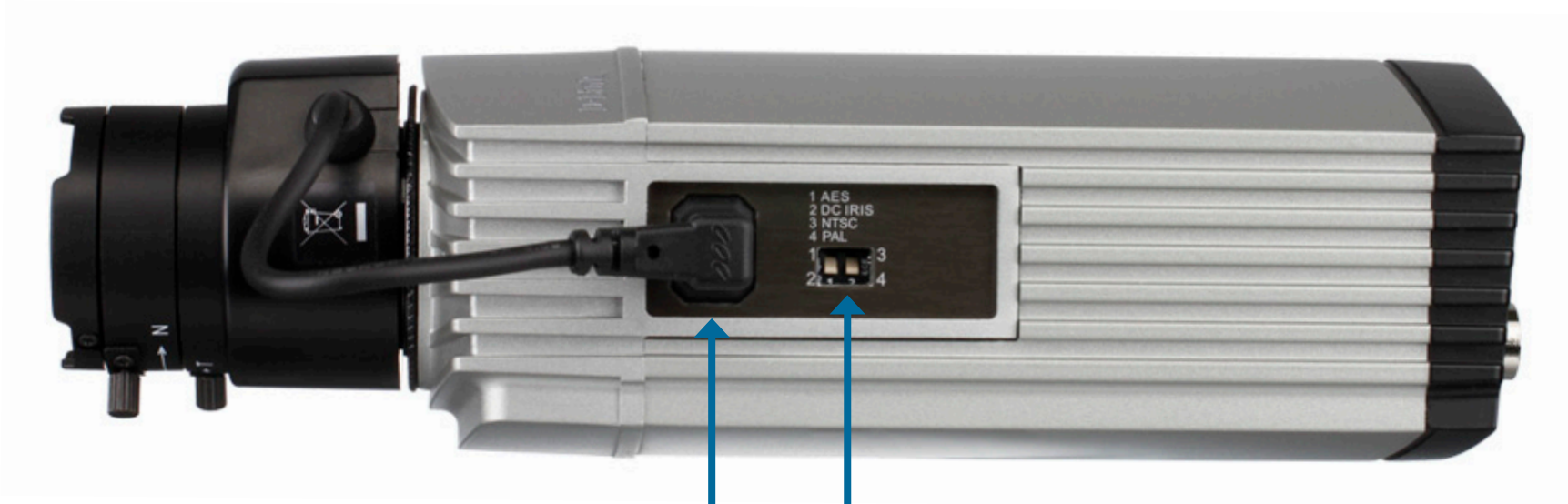

DC-Iris Connector
Connector for DC auto iris lens

DIP Switch
Toggles several different camera options

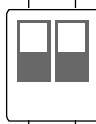
1 3	1. AES: Auto Electric Shutter
	2. DC IRIS: Use an auto iris (DC drive)
	3. NTSC: TV output signal selector
2 4	4. PAL: TV output signal selector



SD Card Slot

Local SD card for storing recorded images and video

Configuration with Wizard

Insert the DCS-3112 CD into your computer's CD-ROM drive to begin the installation. If the Autorun function on your computer is disabled, or if the D-Link Launcher fails to start automatically, click **Start > Run**. Type **D:\autorun.exe**, where D: represents the drive letter of your CD-ROM drive.

Click **Installation Wizard** to begin the installation.



After clicking Setup Wizard, the window on the right will open.

Click **Next** to continue.

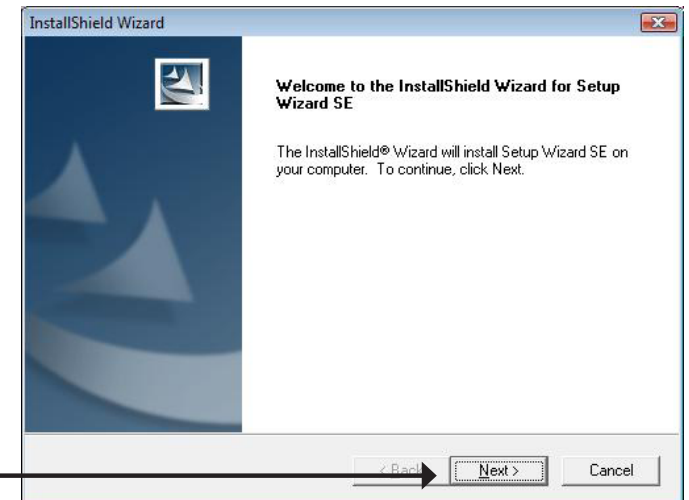

Click **Yes** to accept the License Agreement.

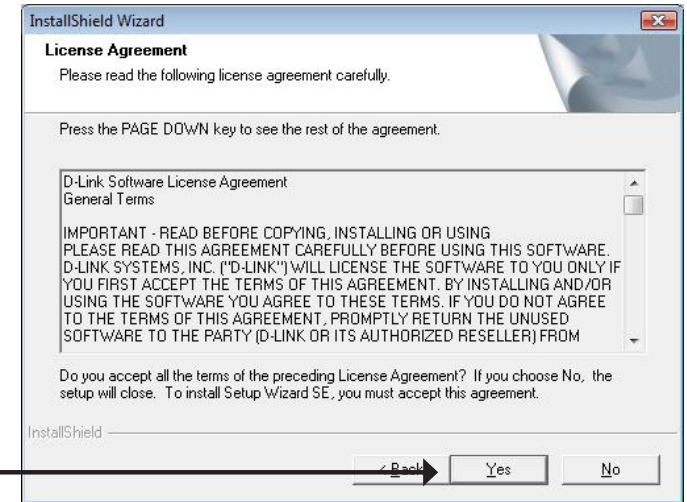

To start the installation process, click **Next**.

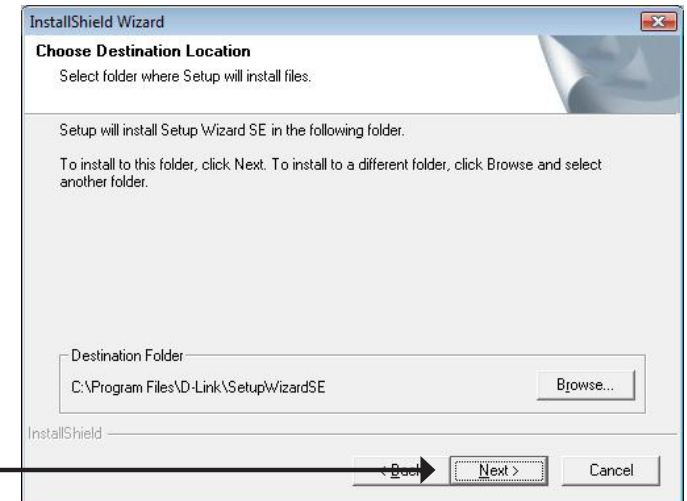

Note: The installation may take several minutes to finish.

Click **Finish** to complete the installation.

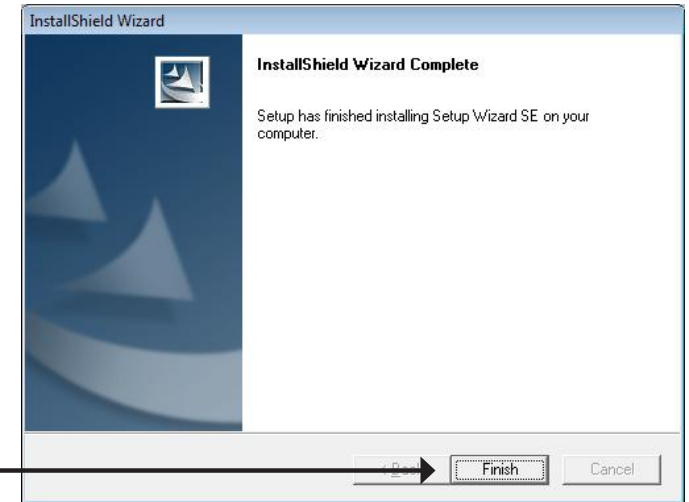

Click on the **D-Link Setup Wizard SE** icon that was created in your Windows Start menu.

Start > D-Link > Setup Wizard SE

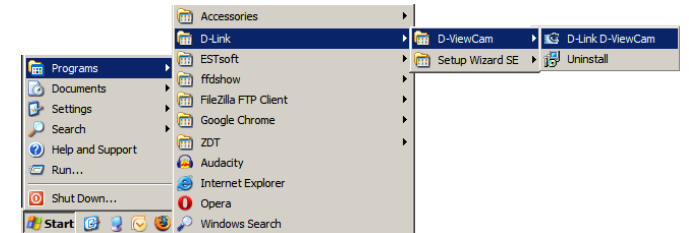

The Setup Wizard will appear and display the MAC address and IP address of your camera(s). If you have a DHCP server on your network, a valid IP Address will be displayed. If your network does not use a DHCP server, the network camera's default static IP address **192.168.0.20** will be displayed.

Click the **Wizard** button to continue.



Enter the Admin ID and password. When logging in for the first time, the default Admin ID is **admin** with the password left blank.

Click **Next**, to proceed to the next page.

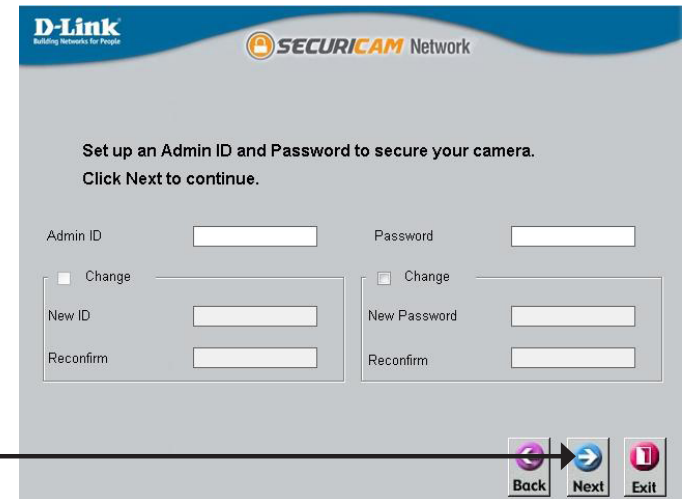

Select DHCP if your camera obtains an IP address automatically when it boots up. Select static IP if the camera will use the same IP address each time it is started.

Click **Next**, to proceed to the next page.

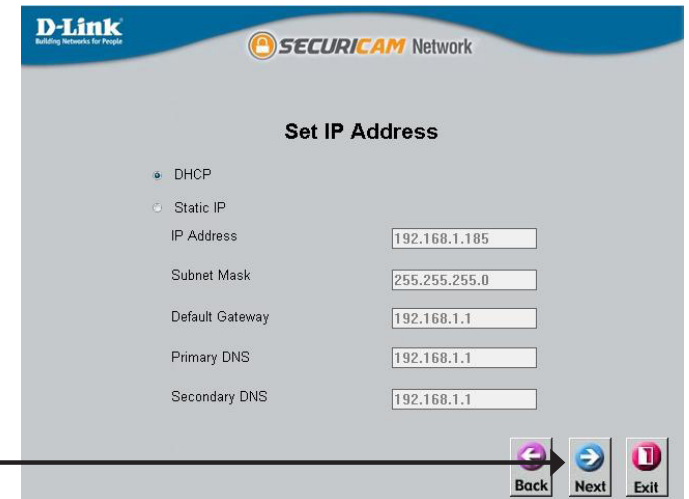

D-Link Building Networks for People

SECURICAM Network

Set IP Address

DHCP

Static IP

IP Address

Subnet Mask

Default Gateway

Primary DNS

Secondary DNS

Take a moment to confirm your settings and click **Restart**.

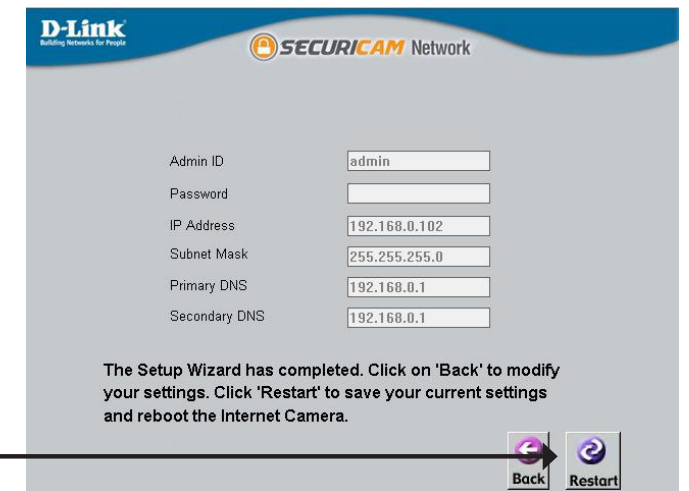

D-Link Building Networks for People

SECURICAM Network

Admin ID

Password

IP Address

Subnet Mask

Primary DNS

Secondary DNS

The Setup Wizard has completed. Click on 'Back' to modify your settings. Click 'Restart' to save your current settings and reboot the Internet Camera.

Web-based Configuration Utility

This section explains how to configure your new D-Link Network Camera using the Web-based Configuration Utility.

Click on the **D-Link Setup Wizard SE** icon that was created in your Windows Start menu.

Start > D-Link > Setup Wizard SE

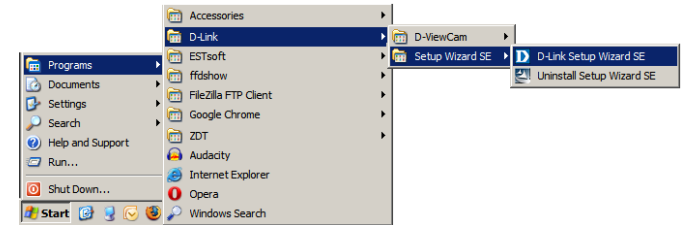

Select the camera and click the button labeled **Link** to access the web configuration.

The Setup Wizard will automatically open your web browser to the IP address of the camera.



Alternatively, you may manually open a browser and enter the IP address of the camera: **192.168.0.20**

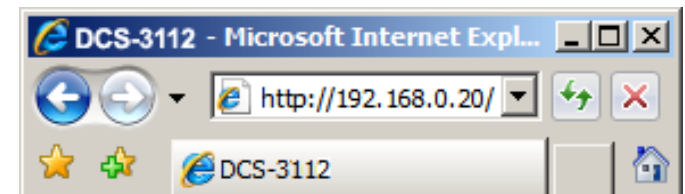

Enter **admin** as the default username and leave the password blank. Click **OK** to continue.

This section shows your camera's live video. You can select your video profile and view or operate the camera. For additional information about web configuration, please refer to the user manual included on the CD-ROM or the D-Link website.

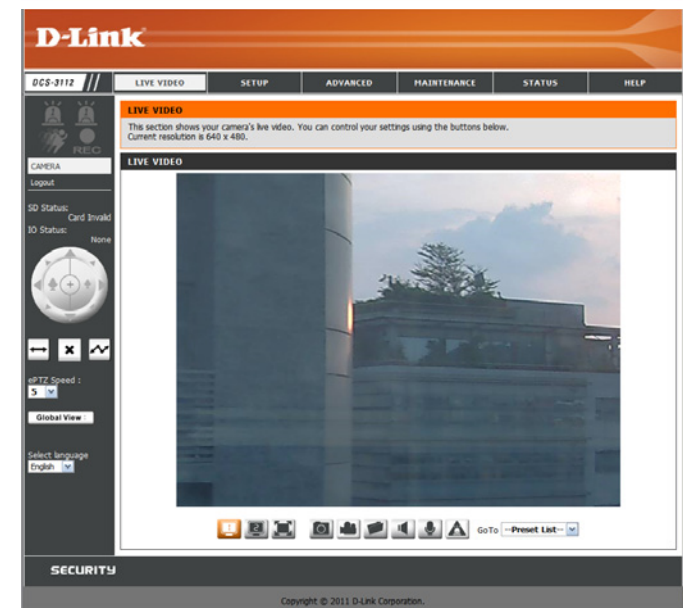
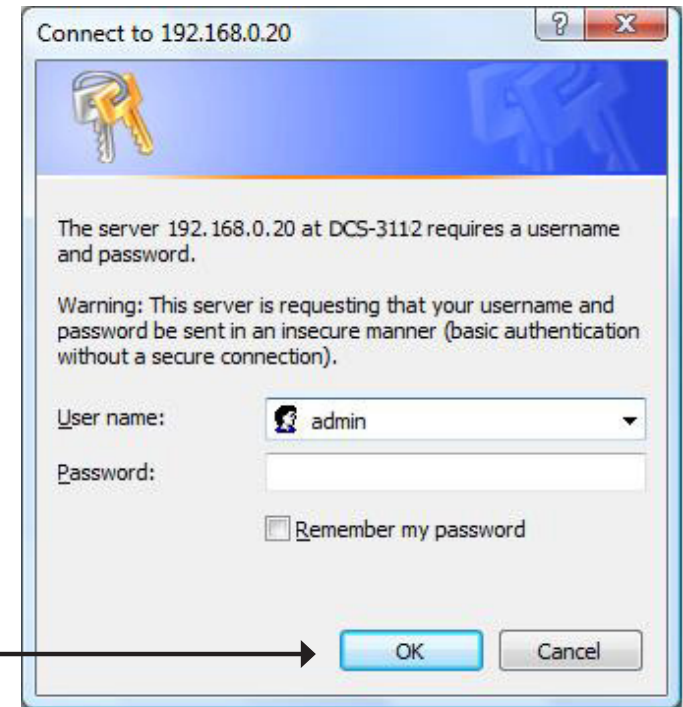

D-ViewCam Setup Wizard

D-ViewCam software is included for the administrator to manage multiple D-Link IP cameras remotely. You may use the software to configure all the advanced settings for your cameras. D-ViewCam is a comprehensive management tool for IP surveillance.

Insert the CD-ROM into the CD-ROM drive. Click "Install D-ViewCam Software" from menu, and select "D-ViewCam" to install the VMS software.

Follow the Installation Wizard to install D-ViewCam.

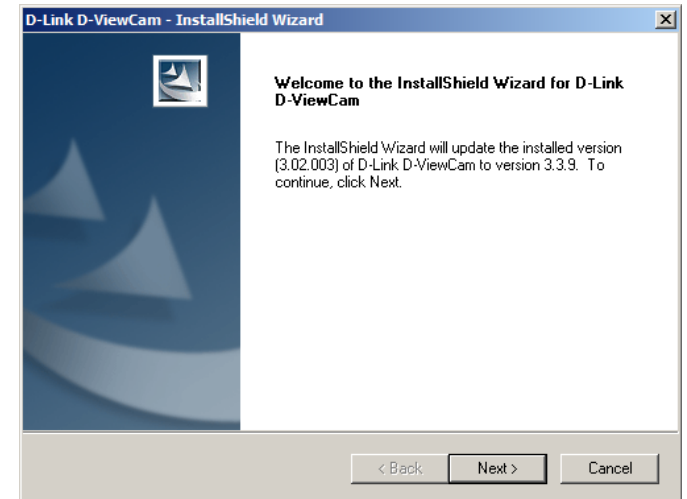

Click **Finish** to complete the installation.

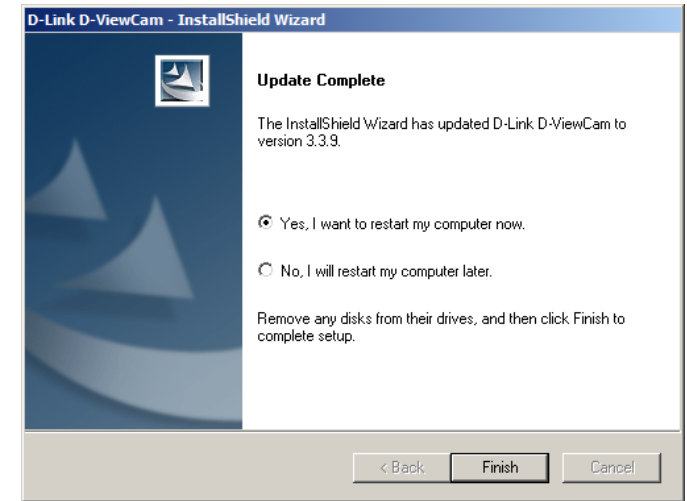

To start D-ViewCam, select **Start > All Programs > D-Link D-ViewCam > Main Console**.

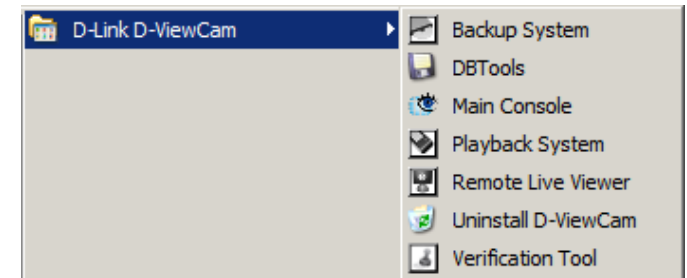

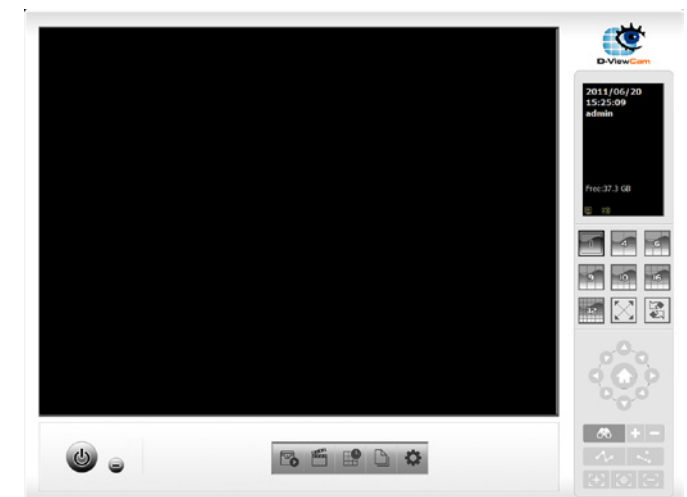

For more detail operation of using D-ViewCam software, please refer to D-ViewCam Manual.











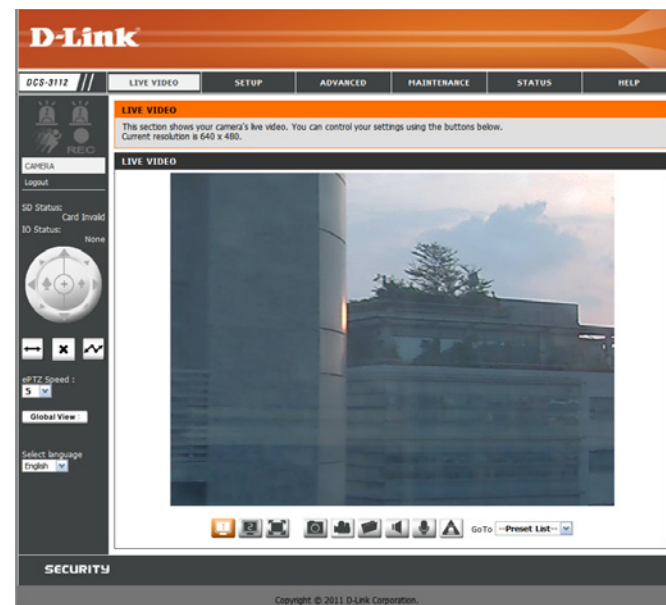

Live Video

This section shows your camera's live video. You may select any of the available icons listed below to operate the camera. You may also select your language using the drop-down menu on the left side of the screen.

You can zoom in and out on the live video image using your mouse. Right-click to zoom out or left-click to zoom in on the image.

	Digital Input Indicator	This indicator will change color when a digital input signal is detected.
	Motion Trigger Indicator	This indicator will change color when a trigger event occurs. Note: The video motion feature for your camera must be enabled.
	Recording Indicator	When a recording is in progress, this indicator will change color.



-  Video Profile 1
-  Video Profile 2
-  Video Profile 3
-  Full screen mode
-  Taking a Snapshot
-  Recording a Video Clip
-  Set a Storage Folder
-  Listen/Stop Listening
-  Talk/Stop Talking
-  Start/Stop Digital Output

	Control Pad	This control pad can be used to pan, tilt, and zoom within the camera's predefined view area, if one has been defined.
---	--------------------	--

Go To: If any presets have been defined, selecting a preset from this list (**Preset List**) will display it.

SD Status: This option displays the status of the SD card. If no SD card has been inserted, this screen will display the message "Card Invalid."

IO Status: This option displays the status of your I/O device if a device has been connected.

PTZ Control: This camera uses electronic pan/tilt/zoom (ePTZ) to select and view areas of interest in the field of view. Please see page 29 for information about setting the frame size and view window area.

ePTZ Speed: You may select a value between 0 and 64. 0 is the slowest and 64 is the fastest.

Global View: This window indicates the total field of view (FOV) of the camera. The red box indicates the visible region of interest (ROI).

Language: You may select the interface language using this menu. The available options are English and Traditional Chinese.



	Auto Pan	Starts the automatic panning function. The ROI will pan from back and forth within the FOV
	Stop	Stops the camera ePTZ motion
	Preset Path	Starts the camera's motion along the predefined path

Setup Wizard

To configure your Network Camera, click **Internet Connection Setup Wizard**. Alternatively, you may click **Manual Internet Connection Setup** to manually configure your Network Camera and skip to page 22.

To quickly configure your Network Camera's motion detection settings, click **Motion Detection Setup Wizard**. If you want to enter your settings without running the wizard, click **Manual Motion Detection Setup** and skip to page 27.

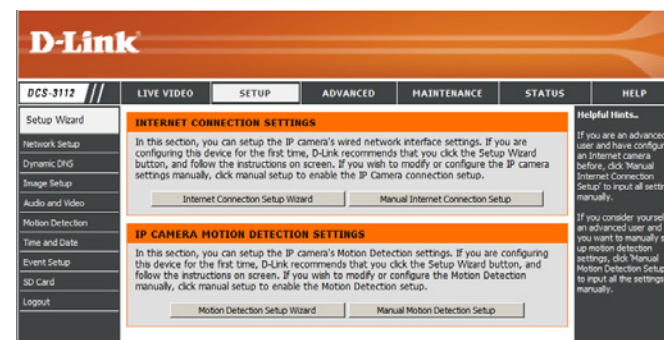

Internet Connection Setup Wizard

This wizard will guide you through a step-by-step process to configure your new D-Link Camera and connect the camera to the internet. Click **Next** to continue.

Note: Select DHCP if you are unsure of which settings to choose.

Click **Next** to continue.

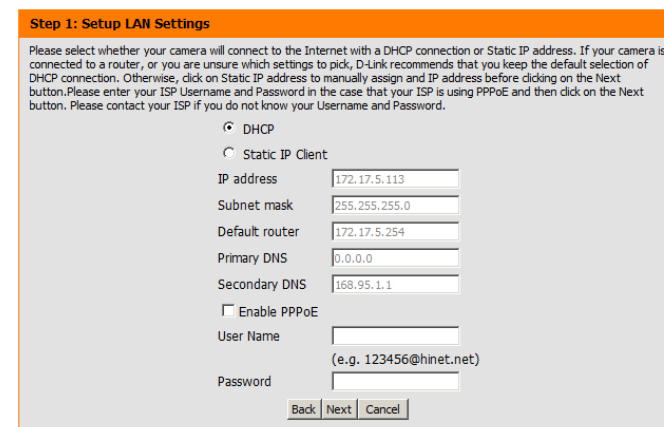
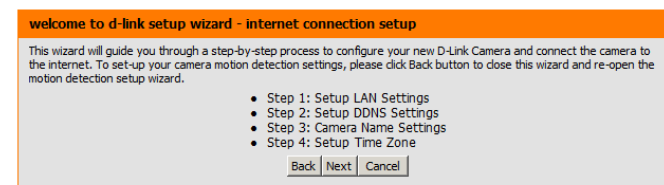

Configuration

Select Static IP if your Internet Service Provider has provided you with connection settings, or if you wish to set a static address within your home network. Enter the correct configuration information and click **Next** to continue.

If you are using PPPoE, select **Enable PPPoE** and enter your user name and password, otherwise click **Next** to continue.

If you have a Dynamic DNS account and would like the camera to update your IP address automatically, Select **Enable DDNS** and enter your host information. Click **Next** to continue.

Enter a name for your camera and click **Next** to continue.

Step 1: Setup LAN Settings

Please select whether your camera will connect to the Internet with a DHCP connection or Static IP address. If your camera is connected to a router, or you are unsure which settings to pick, D-Link recommends that you keep the default selection of DHCP connection. Otherwise, click on Static IP address to manually assign and IP address before clicking on the Next button. Please enter your ISP Username and Password in the case that your ISP is using PPPoE and then click on the Next button. Please contact your ISP if you do not know your Username and Password.

DHCP

Static IP Client

IP address

Subnet mask

Default router

Primary DNS

Secondary DNS

Enable PPPoE

User Name

(e.g. 123456@hinet.net)

Password

Step 2: Setup DDNS Settings

If you have a Dynamic DNS account and would like the camera to update your IP address automatically, enable DDNS and enter in your host information below. Please click on the Next button to continue.

Enable DDNS

Server Address <<

Host Name

User Name

Password

Verify Password

Timeout (hours)

Step 3: Camera Name Settings

D-Link recommends that you rename your camera for easy accessibility. You can then identify and connect to your camera via this name. Please assign a name of your choice before clicking on the Next button.

IP Camera Name

Configuration

Configure the correct time to ensure that all events will be triggered as scheduled. Click **Next** to continue.

If you have selected DHCP, you will see a summary of your settings, including the camera's IP address. Please write down all of this information as you will need it in order to access your camera.

Click **Apply** to save your settings.

Step 4: Setup Time Zone

Please configure the correct time to ensure that all events are triggered, captured and scheduled at the correct time and day and then click on the Next button.

Time Zone

Enable Daylight Saving

Step 5: Setup complete

Below is a summary of your camera settings. Click on the Back button to review or modify settings or click on the Apply button if all settings are correct. It is recommended to note down these settings in order to access your camera on the network or via your web browser.

IP Address	DHCP
IP Camera Name	DCS-3112
Time Zone	(GMT+08:00) Taipei
DDNS	Disable
PPPoE	Disable

Motion Detection Setup Wizard

This wizard will guide you through a step-by-step process to configure your camera's motion detection functions.

Click **Next** to continue.

Step 1

This step will allow you to enable or disable motion detection, specify the detection sensitivity, and adjust the camera's ability to detect movement.

You may specify whether the camera should capture a snapshot or a video clip when motion is detected.

Please see the **Motion Detection** section on page 27 for information about how to configure motion detection.

Step 2

This step allows you to enable motion detection based on a customized schedule. Specify the day and hours. You may also choose to always record motion.

welcome to d-link setup wizard - motion detection

This wizard will guide you through a step-by-step process to configure your camera's motion detection functions. To setup the camera LAN or Internet settings, please click on the Back button to close this wizard and re-open the Camera Setup wizard. Otherwise click on the Next button to begin.

- Step 1: Specify Motion Detection Area Settings
- Step 2: Alerts and Notifications

Back Next Cancel

Step 1: Specify Motion Detection Area Settings

This section will allow you to enable or disable motion detection as well as control the sensitivity of your camera's ability to detect movement.

Enable Video Motion Snapshot Video Clip

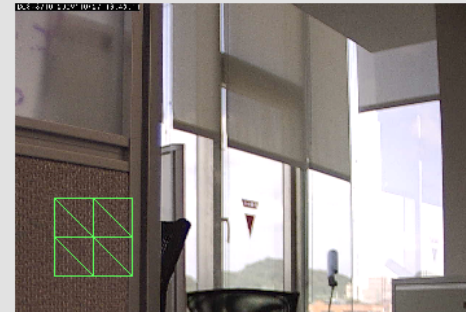

Back Next Cancel

step 2: Motion Detection Schedule

This section allows you to specify the time and dates that your camera records motion. Please note that recorded camera footage will take up space on your hard drive. It is therefore recommended that you have sufficient disk space for Always function.

Sun Mon Tue Wed Thu Fri Sat

Time

Always

From 00 To 23 To 59

Back Next Cancel

Step 3

This step allows you to specify how you will receive event notifications from your camera. You may choose not to receive notifications, or to receive notifications via e-mail or FTP.

Please enter the relevant information for your e-mail or FTP account.

Click **Next** to continue.

Step 3: Alerts and Notification

This final step allows you to specify how you receive notification of camera events. Choose between an email notification or alternatively you can setup an FTP Notification. You will need your email account settings or FTP details. If you are unsure of this information, please contact your ISP. Once you have entered this information, please click on the Next button.

Do not notify me

Email

Sender email address

Recipient email address

Server address

User name

Password

Port

FTP

Server address

Port

User name

Password

Remote folder name

Step 4

You have completed the Motion Detection Wizard.

Please verify your settings and click **Apply** to save them.

Step 4: Setup Complete

You have completed your camera setup. Please click the Back button if you want to review or modify your settings or click on the Apply button to save and apply your settings.

Motion Detection : Enable

EVENT : Video Clip

Schedule Day : Sun ,Mon ,Tue ,Wed ,Thu ,Fri ,Sat ,

Schedule Time : Always

Alerts and Notification : Email

Please wait a few moments while the camera saves your settings and restarts.

Step 4: Setup Complete

You have completed your camera setup. Please click the Back button if you want to review or modify your settings or click on the Apply button to save and apply your settings.

Changes saved.IP Camera's network is restarting, please wait for 3 seconds ...

Network Setup

Use this section to configure the network connections for your camera. All relevant information must be entered accurately.

LAN Settings: Settings for your local area network.

DHCP: Select this connection if you have a DHCP server running on your network and would like your camera to obtain an IP address automatically.

Static IP Address: You may obtain a static or fixed IP address and other network information from your network administrator for your camera. A static IP address may simplify access to your camera in the future.

IP Address: Enter the fixed IP address in this field.

Subnet Mask: This number is used to determine if the destination is in the same subnet. The default value is 255.255.255.0.

Default Gateway: The gateway used to forward frames to destinations in a different subnet. Invalid gateway settings may cause the failure of transmissions to a different subnet.

Primary DNS: The primary domain name server translates names to IP addresses.

Secondary DNS: The secondary DNS acts as a backup to the primary DNS.

Enable UPnP: Enabling this setting allows your camera to be configured as a UPnP device on your network.

Enable UPnP Port Forwarding: Enabling this setting allows the camera to add port forwarding entries into the router automatically on a UPnP capable network.

The screenshot displays the 'NETWORK SETUP' page for a D-Link DCS-3112 camera. The page is divided into several sections for configuration:

- LAN SETTINGS:** Offers a choice between DHCP and Static IP Client. The Static IP Client section includes fields for IP address (172.17.5.113), Subnet mask (255.255.255.0), Default router (172.17.5.224), Primary DNS (0.0.0.0), and Secondary DNS (168.95.1.1). There are also checkboxes for 'Enable UPnP presentation' and 'Enable UPnP port forwarding', with the latter showing a 'Forwarding Port' of 1024 and 'Forwarding Status' as 'UPnP forwarding is active'.
- PPPoE SETTINGS:** Includes a radio button to 'Enable' or 'Disable' PPPoE, and fields for 'User Name', 'Password', and 'Confirm password'. A 'PPPoE Status' field is also present.
- HTTP:** Features an 'HTTP port' field set to 80, and three 'Access name for stream' fields (stream1, stream2, stream3) with values 'video1.mjpg', 'video2.mjpg', and 'video3.mjpg' respectively.
- HTTPS:** Includes an 'HTTPS port' field set to 443.
- RTSP:** Features an 'RTSP port' field set to 554, and three 'Access name for stream' fields (stream1, stream2, stream3) with values 'rve1.sdp', 'rve2.sdp', and 'rve3.sdp' respectively.
- TRAFFIC:** Includes 'Maximum Upload Bandwidth' and 'Maximum Download Bandwidth' fields, both set to 0 Kilo Bytes Per Second.

On the right side of the interface, there is a 'Helpful Hints...' section with several informational paragraphs. At the bottom of the page, there is a 'SECURITY' section and 'Save Settings' / 'Don't Save Settings' buttons.

Enable PPPoE: Enable this setting if your network uses PPPoE.

User Name: The unique name of your account. You may obtain this information from your ISP.

Password: The password to your account. You may obtain this information from your ISP.

HTTP Port: The default port number is 80.

Access Name for Stream 1~3: The default name is video#.mjpg, where # is the number of the stream.

HTTPS Port: You may use a PC with a secure browser to connect to the HTTPS port of the camera. The default port number is 443.

RTSP Port: The port number that you use for RTSP streaming to mobile devices, such as mobile phones or PDAs. The default port number is 554. You may specify the address of a particular stream. For instance, live1.sdp can be accessed at rtsp://x.x.x.x/video1.sdp where the x.x.x.x represents the ip address of your camera.

Maximum Upload/Download Bandwidth: Specifying the maximum download/upload bandwidth for each socket can be useful when connecting your device to a busy or heavily loaded network. Entering a value of '0' indicates that the camera should not monitor bandwidth. Specifying other values will limit the camera's transfer speed to the specified number of Kilobytes per second.

D-Link

DCS-3112 // LIVE VIDEO SETUP ADVANCED MAINTENANCE STATUS HELP

Setup Wizard
Network Setup
Dynamic DNS
Image Setup
Audio and Video
Motion Detection
Time and Date
Event Setup
SD Card
Logout

NETWORK SETUP
You can configure your LAN and Internet settings here.
Save Settings Don't Save Settings

LAN SETTINGS
 DHCP
 Static IP Client
 IP address: 172.17.5.115
 Subnet mask: 255.255.255.0
 Default router: 172.17.5.254
 Primary DNS: 0.0.0.0
 Secondary DNS: 100.95.1.1
 Enable UPnP presentation
 Enable UPnP port forwarding
 Forwarding Port: 1024 Test
 Forwarding Status: UPnP forwarding is active

PPPOE SETTINGS
 Enable Disable
 User Name:
 Password:
 Confirm password:
 PPPoE Status:

HTTP
 HTTP port: 80
 Access name for stream1: video1.mjpg
 Access name for stream2: video2.mjpg
 Access name for stream3: video3.mjpg

HTTPS
 HTTPS port: 443

RTSP
 RTSP port: 554
 Access name for stream1: live1.sdp
 Access name for stream2: live2.sdp
 Access name for stream3: live3.sdp

TRAFFIC
 Maximum Upload Bandwidth: 0 Kilo Bytes Per Second
 Maximum Download Bandwidth: 0 Kilo Bytes Per Second

Save Settings Don't Save Settings

SECURITY

Helpful Hints.
 Select DHCP Connection: If you are running a DHCP server on your network and would like an IP address assigned to your camera automatically.
 Enabling UPnP settings will allow you to configure your camera as an UPnP device in the network.
 PPPoE Setting - If you use the camera to connect directly to the Internet, you will need to enter the username and password, which were given to you when you set up your account with your Internet Service Provider. If the camera is behind a router or a gateway, you do not need to configure this setting.
 HTTP Port is the port you allocate in order to connect to the camera via a standard web browser.
 HTTPS Port is a camera connects with a PC via a secure web browser.
 RTSP Port is the port you allocate in order to connect to a camera by using streaming mobile device(s), such as a mobile phone or PDA.
 Traffic - Specifying the maximum download/upload bandwidth for each socket is useful when connecting your device to a busy or heavily loaded network.
 *The value '0' means it will not monitor any traffic.

Dynamic DNS

DDNS (Dynamic Domain Name Server) will hold a DNS host name and synchronize the public IP address of the modem when it has been modified. A user name and password are required when using the DDNS service.

Enable DDNS: Select this checkbox to enable the DDNS function.

Server Address: Select your Dynamic DNS provider from the pull down menu or enter the server address manually.

Host Name: Enter the host name of the DDNS server.

User Name: Enter your user name or e-mail used to connect to the DDNS.

Password: Enter your password used to connect to the DDNS server.

Timeout: Enter DNS Timeout values.

Status: Indicates the connection status, which is automatically determined by the system.

The screenshot shows the D-Link DCS-3112 web interface. The top navigation bar includes 'LIVE VIDEO', 'SETUP', 'ADVANCED', 'MAINTENANCE', 'STATUS', and 'HELP'. The 'SETUP' tab is active, and the 'Dynamic DNS' option is selected in the left sidebar. The main content area is titled 'DYNAMIC DNS' and contains an introductory text block and a link to 'Sign up for D-Link's Free DDNS service at www.DLinkDDNS.com'. Below this is the 'DYNAMIC DNS SETTING' form, which includes a checkbox for 'Enable DDNS', a 'Server Address' dropdown menu (currently showing 'www.dlinkddns.com'), and input fields for 'Host Name', 'User Name', 'Password', and 'Verify Password'. There is also a 'Timeout' field set to '24' hours and a 'Status' field set to 'none'. 'Save Settings' and 'Don't Save Settings' buttons are located at the bottom of the form. A 'Helpful Hints...' sidebar on the right provides additional information about the Dynamic DNS feature.

Image Setup

In this section, you may configure the video image settings for your camera. A preview of the image will be shown in Live Video.

Enable Privacy Mask: The Privacy Mask setting allows you to specify upto 3 rectangular areas on the camera's image to be blocked/excluded from recordings and snapshots.

You may click and drag the mouse cursor over the camera image to draw a mask area. Right clicking on the camera image brings up the following menu options:

Disable All: Disables all mask areas

Enable All: Enables all mask areas

Reset All: Clears all mask areas.

Mirror: Mirrors the images.

Flip: Rotates the image 180 degrees.

White Balance: If this option is enabled, white objects will be rendered as white on the screen.

Exposure Mode: Changes the exposure mode. Use the dropdown box to set the camera for Indoor, Outdoor, or Night environments, or to capture Moving objects. The Low_Noise option will focus on creating a high-quality picture without noise. You can also create 3 different custom exposure modes. The Max Gain setting will allow you to control the maximum amount of gain to apply to brighten the picture.

Denoise: This setting controls the amount of noise reduction that will be applied to the picture.

Brightness: Adjust this setting to compensate for backlit subjects.

Contrast: Adjust this setting to alter the color intensity/strength.

Saturation: This setting controls the amount of coloration, from grayscale to fully saturated.

Sharpness: Specify a value from 0 to 8 for image edge enhancement.

Reset Default: Click this button to reset the image to factory default settings.



Audio and Video

You may configure up to 3 video profiles with different settings for your camera. Hence, you may set up different profiles for your computer and mobile display. In addition, you may also configure the two-way audio settings for your camera.

Number of active profiles: You can use the dropdown box to set up to 3 active profiles.

Aspect ratio: Set the aspect ratio of the video to 4:3 standard or 16:9 widescreen.

Mode: Set the video codec to be used to JPEG, MPEG-4, or H.264.

Frame size / View window area: Frame size determines the total capture resolution, and View window area determines the Live Video viewing window size. If the Frame size is larger than the Live Video size, you can use the ePTZ controls to look around.

16:9 1280x720, 800x450, 640x360, 480x270,
320x176, 176x144

4:3 1280x1024, 1280x960, 1024x768, 800x600,
640x480, 480x 360, 320x240, 176x144

Maximum frame rate: A higher frame rate provides smoother motion for videos. Lower frame rates will result in stuttering motion. The maximum number of frames that is displayed in 1 second. 30 fps is the highest video quality for this camera. In general, any frame rate above 15 fps is imperceptible to the human eye.

Video Quality: This limits the maximal refresh frame rate, which can be combined with the "Fixed quality" option to optimize the bandwidth utilization and video quality. If fixed bandwidth utilization is desired regardless of the video quality, choose "Constant bit rate" and select the desired bandwidth.

Constant bit rate: The bps will affect the bit rate of the video recorded by the camera. Higher bit rates result in higher video quality.

Fixed quality: Select the image quality level for the camera to try to maintain. High quality levels will result in increased bit rates.

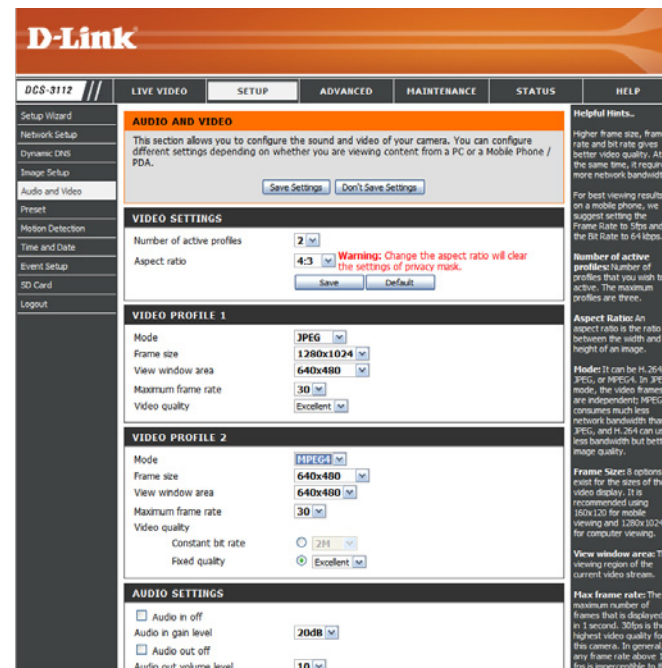

Audio in off: Ticking this checkbox will mute incoming audio.

Audio in gain level: This setting controls the amount of gain applied to incoming audio to increase its volume.

Audio out off: Ticking this checkbox will mute outgoing audio.

Audio out volume level: This setting controls the amount of gain applied to outgoing audio to increase its volume.

The screenshot shows the D-Link DCS-3112 web interface. The top navigation bar includes 'LIVE VIDEO', 'SETUP', 'ADVANCED', 'MAINTENANCE', 'STATUS', and 'HELP'. The 'SETUP' tab is active, and the 'AUDIO AND VIDEO' section is highlighted. The page contains several configuration sections:

- AUDIO AND VIDEO:** A summary section with a warning: "Warning: Change the aspect ratio will clear the settings of privacy mask." It includes 'Save Settings' and 'Don't Save Settings' buttons.
- VIDEO SETTINGS:** Includes 'Number of active profiles' (set to 2), 'Aspect ratio' (set to 4:3), and 'Save'/'Default' buttons.
- VIDEO PROFILE 1:** Includes 'Mode' (JPEG), 'Frame size' (640x480), 'View window area' (640x480), 'Maximum frame rate' (30), and 'Video quality' (Excellent).
- VIDEO PROFILE 2:** Includes 'Mode' (JPEG), 'Frame size' (640x480), 'View window area' (640x480), 'Maximum frame rate' (30), and 'Video quality' (Excellent).
- AUDIO SETTINGS:** Includes checkboxes for 'Audio in off' and 'Audio out off', and dropdowns for 'Audio in gain level' (20dB) and 'Audio out volume level' (10).

Helpful Hints on the right side provide additional information:

- Higher frame size, frame rate and bit rate gives better video quality.** At the same time, it requires more network bandwidth.
- For best viewing results on a mobile phone, we suggest setting the Frame Rate to 30ps and the Bit Rate to 64 kbps.**
- Number of active profiles:** Number of profiles that you wish to active. The maximum profiles are three.
- Aspect Ratio:** An aspect ratio is the ratio between the width and height of an image.
- Mode:** It can be H.264, JPEG, or MPEG4. In JPEG mode, the video frames are independent; MPEG4 consumes much less network bandwidth than H.264 and H.264 can use less bandwidth but better image quality.
- Frame Size:** It options exist for the size of the video display. It is recommended using 160x120 for mobile viewing and 1280x1024 for computer viewing.
- View window area:** The viewing region of the current video stream.
- Max frame rate:** The maximum number of frames that is displayed in 1 second. 30fps is the highest video quality for this camera. In general, any frame rate above 15 fps is imperceptible to the human eye.
- Video Quality:** This sets the maximal refresh frame rate, which can be

Motion Detection

Enabling Video Motion will allow your camera to use the motion detection feature. You may draw a finite motion area that will be used for monitoring.

Enable Video Motion: Select this box to enable the motion detection feature of your camera.

Sensitivity: Specifies the measurable difference between two sequential images that would indicate motion. Please enter a value between 0 and 100.

Percentage: Specifies the amount of motion in the window being monitored that is required to initiate an alert. If this is set to 100%, motion is detected within the whole window will trigger a snapshot.

Draw Motion Area: Draw the motion detection area by dragging your mouse in the window (indicated by the red square).

Erase Motion Area: To erase a motion detection area, simply click on the red square that you wish to remove.

Right clicking on the camera image brings up the following menu options:

Select All: Draws a motion detection area over the entire screen.

Clear All: Clears any motion detection areas that have been drawn.

Restore: Restores the previously specified motion detection areas.

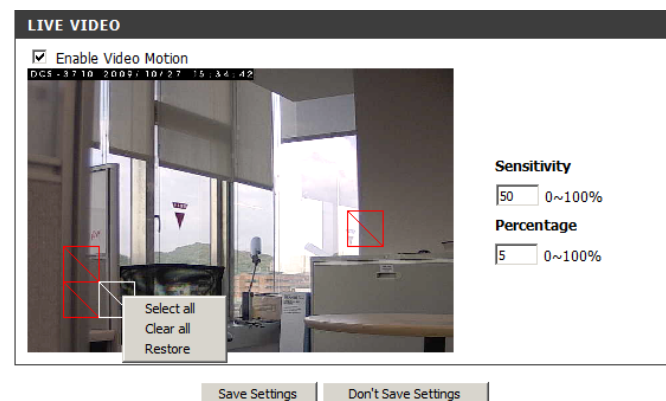
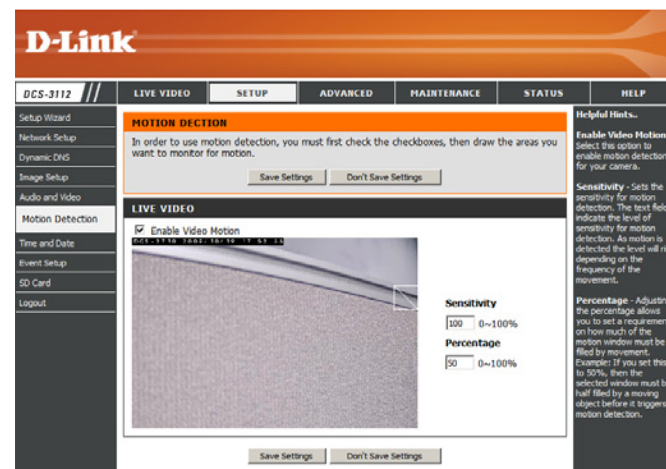

Time and Date

This section allows you to automatically or manually configure, update, and maintain the internal system clock for your camera.

Time Zone: Select your time zone from the drop-down menu.

Enable Daylight Saving: Select this to enable Daylight Saving Time.

Auto Daylight Saving: Select this option to allow your camera to configure the Daylight Saving settings automatically.

Set Date and Time Manually: Selecting this option allows you to configure the Daylight Saving date and time manually.

Offset: Sets the amount of time to be added or removed when Daylight Saving is enabled.

Synchronize with NTP Server: Enable this feature to obtain time automatically from an NTP server.

NTP Server: Network Time Protocol (NTP) synchronizes the DCS-3112 with an Internet time server. Choose the one that is closest to your location.

Set the Date and Time Manually: This option allows you to set the time and date manually.

Copy Your Computer's Time Settings: This will synchronize the time information from your PC.

D-Link

DCS-3112 // LIVE VIDEO SETUP ADVANCED MAINTENANCE STATUS HELP

TIME AND DATE

You can set the current time for the camera.

Save Settings Don't Save Settings

TIME CONFIGURATION

Time Zone [GMT+08:00] Taipei

Enable Daylight Saving

Auto Daylight Saving

Set date and time manually

Offset: +2:00

Month Week Day of week Hour Minutes

Start time: 1 1 Sunday 0 00

End time: 1 1 Sunday 0 00

AUTOMATIC TIME CONFIGURATION

Synchronize with NTP Server

NTP Server: ntp.dlink.com.tw << Select NTP Server

SET DATE AND TIME MANUALLY

Set date and time manually

Year: 2009 Month: 10 Day: 19

Hour: 17 Minute: 53 Second: 35

Copy Your Computer's Time Settings

Save Settings Don't Save Settings

Helpful Hints..

Good timekeeping is important for accurate logs and scheduled firewall rules.

Time Zone: Select your time zone from the drop-down menu.

Enable Daylight Saving: Select this to enable the daylight saving time.

Auto Daylight Saving: When you select it, the clock is automatically adjusted according to the daylight saving time of the selected time zone.

Offset: Select the time offset, if your location observes daylight saving time.

Synchronize with NTP Server: With the option selected, the camera will synchronize the time settings with the NTP server over the Internet whenever the camera starts up. If the timeserver cannot be reached, no time settings will be applied.

NTP Server: Network Time Protocol (NTP) synchronizes the camera with an Internet time server. Choose the one that is closest to your location.

Copy Your Computer's Time Settings: This will synchronize the time information from your PC.

Event Setup

The Event Setup page includes 4 different sections.

- Event
- Server
- Media
- Recording

1. To add a new item - "event, server or media," click **Add**. A screen will appear and allow you to update the fields accordingly.

2. To delete the selected item from the pull-down menu of event, server or media, click **Delete**.

3. Click on the item name to pop up a window for modifying.

Note: You can add up to four events, five servers, and five media fields.

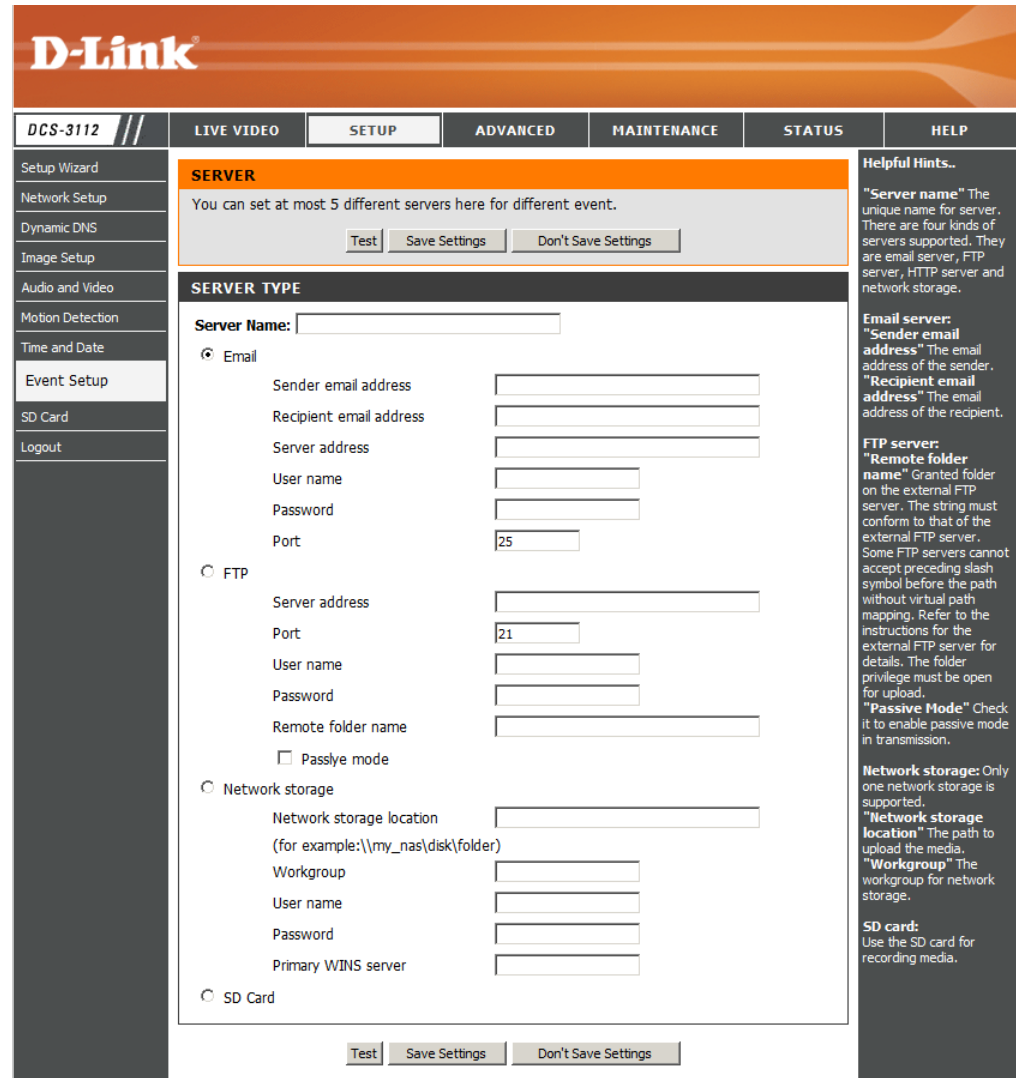

Application

In a typical application, when motion is detected, the DCS-3112 Network Camera sends images to a FTP server or via e-mail as notifications. As shown in the illustration below, an event can be triggered by many sources, such as motion detection or external digital input devices. When an event is triggered, a specified action will be performed. You can configure the Network Camera to send snapshots or videos to your e-mail address or FTP site.

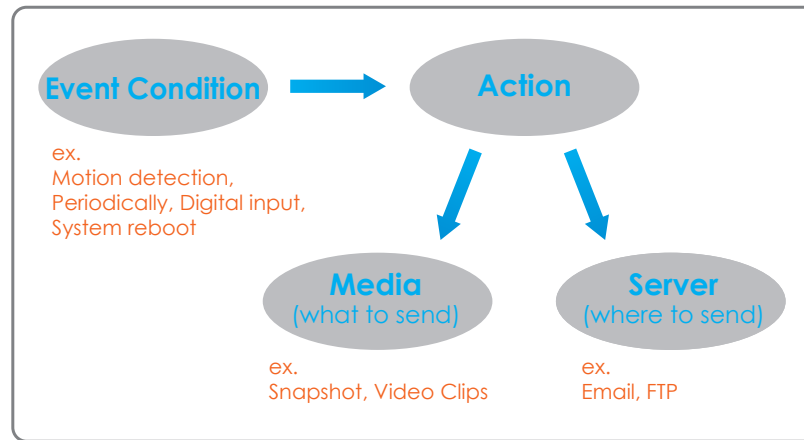

To start plotting an event, it is suggested to configure server and media columns first so that the Network Camera will know what action shall be performed when a trigger is activated.

Add Server

Configure up to 5 servers to store media.

Server Name: Enter the unique name of your server.

E-mail: Enter the configuration for the target e-mail server account.

FTP: Enter the configuration for the target FTP server account.

Network Storage: Specify a network storage device. Only one network storage device is supported.

SD Card: Use the camera's onboard SD card storage.



Add Media

There are three types of media, **Snapshot**, **Video Clip** and **System Log**.

Media Name: Enter an unique name for media.

Snapshot: Select this option to enable snapshots.

Source: The stream source: **Profile 1**, **Profile 2** or **Profile 3**.

Send pre-event image(s) [0~4]: The number of pre-event images.

Send post-event image(s) [0~7]: The number of post-event images.

File name prefix: The prefix name will be added on the file name.

Add date and time suffix to file name: Check it to add timing information as file name suffix.

Video clip: Select this option to enable video clips.

Source: The source of the profile: **profile1**, **profile2**, or **profile3**.

Pre-event recording: The interval of pre-event recording in seconds.

Maximum duration: The maximal recording file duration in seconds.

Maximum file size: The maximal file size would be generated.

File name prefix: The prefix name will be added on the file name of the video clip.

System log: Select this option to save events to the camera system log.

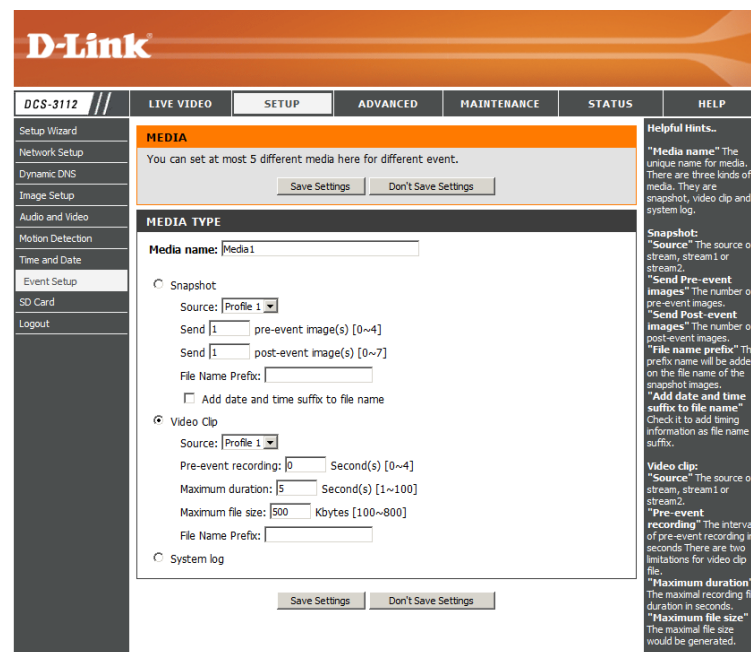

Send post-event image (s) [0~7)

Specify to capture the number of images after a trigger is activated. A maximum of seven images can be generated.

For example:

If both the Send pre-event images and Send post-event images are set to four, a total of 9 images are generated after a trigger is activated.

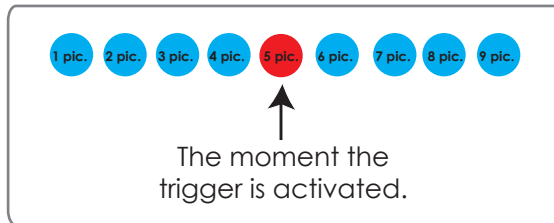

Add a date and time suffix to the file name

Select this option to add a date and time to the file name suffix.

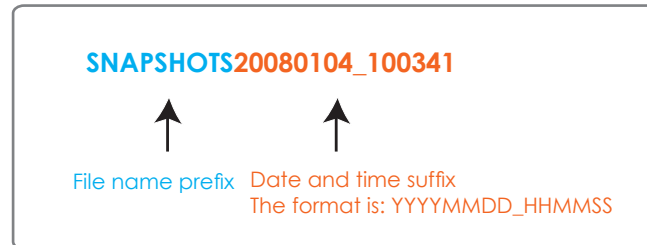

Maximum duration

Specify the maximal recording duration in seconds. You can set up to ten seconds.

For example:

Configuration

If the Pre-event recording is set to five seconds and the Maximum duration is set to ten seconds, the Network Camera continues to record for another four seconds after a trigger is activated.

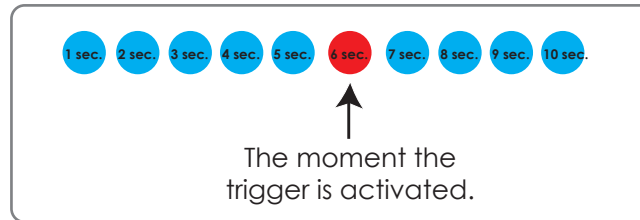

File name prefix

Enter the text that will be added at the beginning of the file name.

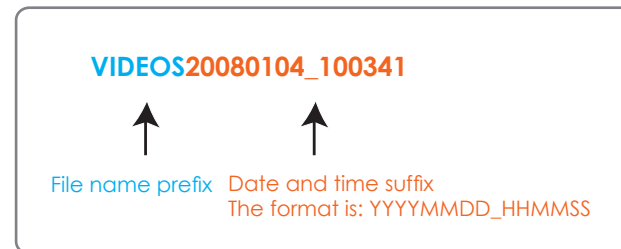

Add Event

Create and schedule up to 3 events with their own settings here.

Event name: Enter a name for the event.

Enable this event: Select this box to activate this event.

Priority: Set the priority for this event. The event with higher priority will be executed first.

Delay: Select the delay time before checking the next event. It is being used for both events of motion detection and digital input trigger.

Trigger: Specify the input type that triggers the event.

Video Motion Detection: Motion is detected during live video monitoring. Select the windows that need to be monitored.

Periodic: The event is triggered in specified intervals. The trigger interval unit is in minutes.

Digital input: The external trigger input to the camera.

System Boot: Triggers an event when the system boots up.

Network Lost: Triggers an event when if the network connection is lost.

Time: Select **Always** or enter the time interval.

Trigger D/O: Select to trigger the digital output for a specific number of seconds when an event occurs.

Server: Specify the location where the event information should be saved to.

Add Recording

Here you can configure and schedule the recording settings.

Recording entry name: The unique name of the entry.

Enable this recording: Select this to enable the recording function.

Priority: Set the priority for this entry. The entry with a higher priority value will be executed first.

Source: The source of the stream.

Recording schedule: Scheduling the recording entry.

Recording settings: Configuring the setting for the recording.

Destination: Select the folder where the recording file will be stored.

Total cycling recording size: Please input a HDD volume between 1MB and 200GB for recording space. The recording data will replace the oldest record when the total recording size exceeds this value. For example, if each recording file is 6MB, and the total cyclic recording size is 600MB, then the camera will record 100 files in the specified location (folder) and then will delete the oldest file and create new file for cyclic recording.

Please note that if the free HDD space is not enough, the recording will stop. Before you set up this option please make sure your HDD has enough space, and it is better to not save other files in the same folder as recording files.

Size of each file for recording: File size for each recording file. You may input the value in the range of 200-5000.

File Name Prefix: The prefix name will be added on the file name of the recording file(s).

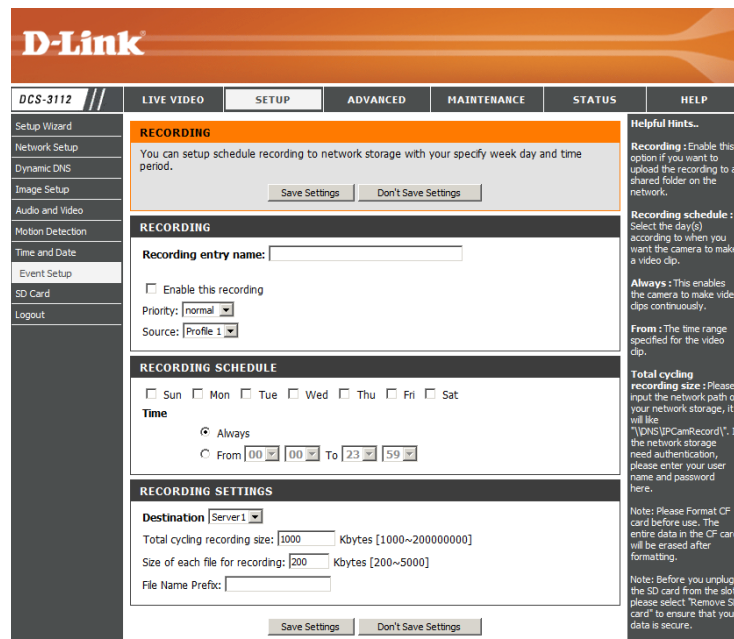

SD Card

Here you may browse and manage the recorded files which are stored on the SD card.

Format SD Card: Click this icon to automatically format the SD card and create "picture" & "video" folders.

View Recorded Picture: If the picture files are stored on the SD card, click on the picture folder and choose the picture file you would like to view.

Playback Recorded Video: If video files are stored on the SD card, click on the video folder and choose the video file you would like to view.

Refresh: Reloads the file and folder information from the SD card.

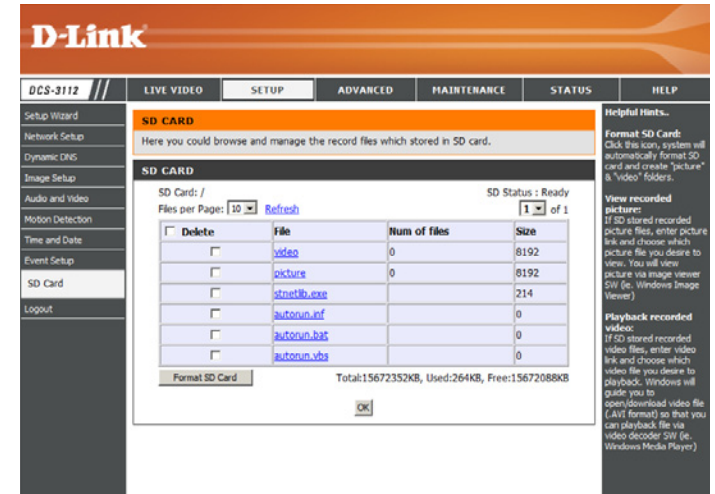

Advanced

Digital Input/Output

This screen allows you to control the behavior of digital input and digital output devices. The I/O connector provides the physical interface for digital output (DO) and digital input (DI) that is used for connecting a diversity of external alarm devices such as IR-Sensors and alarm relays. The digital input is used for connecting external alarm devices and once triggered images will be taken and e-mailed.

Select D/I or D/O Mode: The camera will send a signal when an event is triggered, depending upon the type of device connected to the DI circuit.

N.C. stands for **Normally Closed**. This means that the normal state of the circuit is closed. Therefore events are triggered when the device status changes to "Open."

N.O. stands for **Normally Open**. This means that the normal state of the circuit is open. Therefore events are triggered when the device status changes to "Closed."

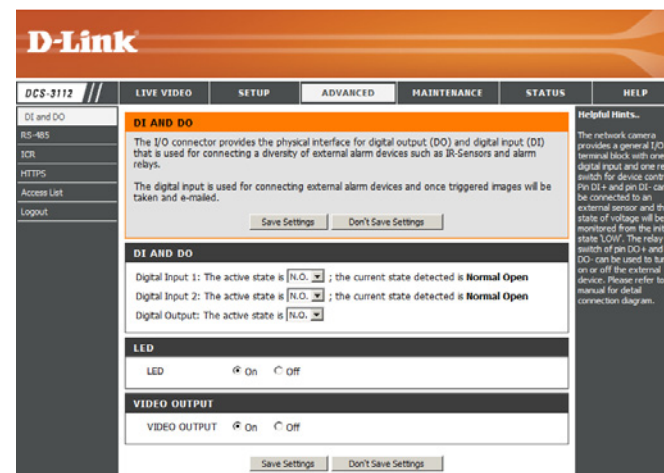

LED: You may specify whether or not to illuminate the LED on the side of the camera.

Video Output: Enable/ disable the BNC terminal TV output signal.

D/I and D/O
Pin Block

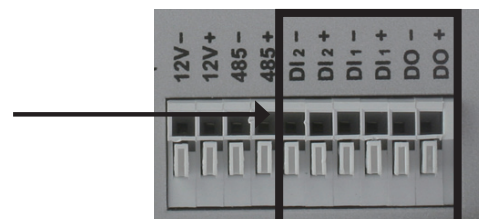

RS-485

You may configure the RS-485 settings or communication specifications (baud rate, data bit, stop bit, and parity bit) for your camera. RS-485 is a serial communication method for computers and devices. RS-485 is used to control a PAN/TILT apparatus, such as an external camera enclosure.

Support PAN-TILT: When **Support PAN-TILT** is enabled, a control panel will be displayed on the Live Video page allowing control through RS-485 for an external camera enclosure.

Protocol: Select one protocol type from the pull-down menu.

ID: This ID is the identifier for RS-485 devices. IDs range from 1 to 255.

Baud Rate: Baud Rate is a speed measurement for communication between a transmitter and receiver which indicates the number of bit transfers per second. A higher baud rate will reduce the distance of the two devices (transmitter and receiver). Values range from 2400 (default) to 19200 bps.

Data Bit: This value is the number of data bits in a transmission. The data bit can be 7 or 8 (default).

Parity Bit: Parity is a form of error checking used in serial communication. For even and odd parities, the serial port sets the parity bit (the last bit after the data bits) to a value to ensure that the transmission has an even or odd number of logic-high bits. For example, if the data is 011, for even parity, the parity bit is 0 to keep the number of logic-high bits even. If the parity is odd, the parity bit is 1, resulting in 3 logic-high bits. Parity can be set to **No** (none), **Even**, and **Odd**.

Stop Bit: The stop bit is used to signal the end of communication for a single packet. The more bits used for stop bits, the greater the lenience in synchronizing the different clocks but the slower the data transmission rate. The stop bit can be set to 1 or 2. The default value is 1.

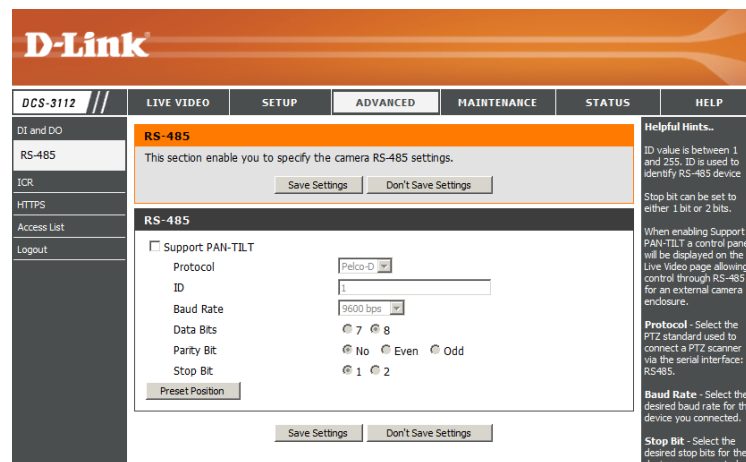

RS-485 Pin Block

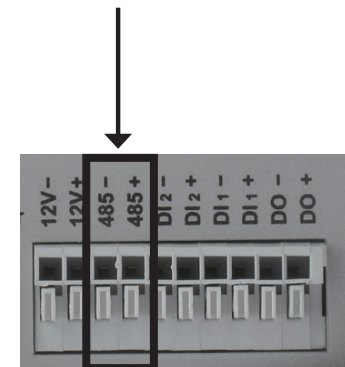

ICR

You may configure the ICR settings here. An IR(Infrared) Cut-Removable(ICR) filter can be disengaged for increased sensitivity in low light environments.

Automatic: The Day/Night mode is set automatically. Generally, the camera uses Day mode and switches to Night mode when needed.

Day Mode: Day mode enables the IR Cut Filter.

Night Mode: Night mode disables the IR Cut Filter.

Schedule Mode: Set up the Day/Night mode using a schedule. The camera will enter Day mode at the starting time and return to Night mode at the ending time.

DC Power Output: The DC 12V Power Output port can supply 12V DC, 200mA of power to another device (such as a spotlight or infrared lamp). Its default setting is **Off**, meaning it will not supply power. You can select **On** to turn on the power supply. If you choose **Sync With ICR**, the power output will be enabled whenever the IR Cut Filter is active. Alternatively, you can select **Schedule** and manually specify when the power should be enabled.

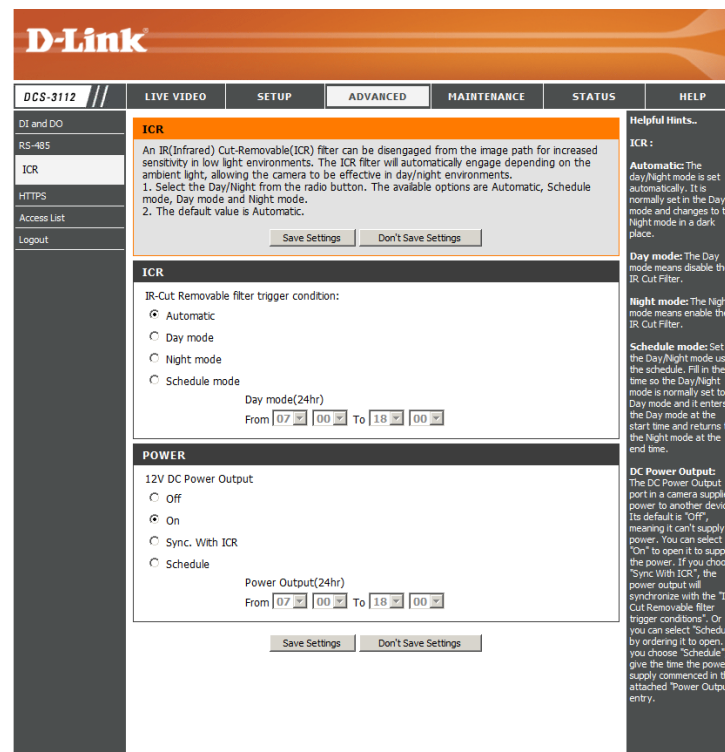

DC Power Output
12V DC, 200mA

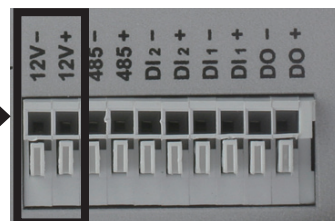

HTTPS

This page allows you to install and activate an HTTPS certificate for secure access to your camera.

Enable HTTPS Secure Connection: Enable the HTTPS service.

Create Certificate Method: Choose the way the certificate should be created. Three options are available:

- Create a self-signed certificate automatically
- Create a self-signed certificate manually
- Create a certificate request and install

Status: Displays the status of the certificate.

Note: The certificate cannot be removed while the HTTPS is still enabled. To remove the certificate you must first uncheck **Enable HTTPS secure connection**.



Access List

Here you can set access permissions for users to view your DCS-3112.

Allow list: The list of IP addresses that have the access right to the camera.

Start IP address: The starting IP Address of the devices (such as a computer) that have permission to access the video of the camera. Click Add to save the changes made.

Note: A total of seven lists can be configured for both columns.

End IP address: The ending IP Address of the devices (such as a computer) that have permission to access the video of the camera.

Delete allow list: Remove the customized setting from the Allow List.

Deny list: The list of IP addresses that have no access right to the camera.

Delete deny list: Remove the customized setting from the Delete List.

For example:

When the range of the Allowed List is set from 1.1.1.0 to 192.255.255.255 and the range of the Denied List is set from 1.1.1.0 to 170.255.255.255. Only users with IPs located between 171.0.0.0 and 192.255.255.255 can access the Network Camera.

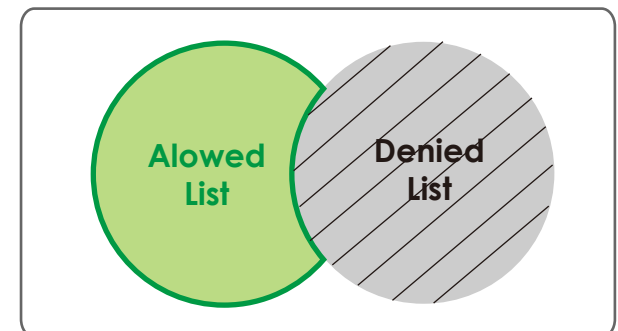

Maintenance

Device Management

You may modify the name and administrator's password of your camera, as well as add and manage the user accounts for accessing the camera. You may also use this section to create the unique name and configure the OSD setting for your camera.

Admin Password Setting: Set a new password for the administrator's account.

Add User Account: Add new user account.

User Name: The user name for the new account.

Password: The password for the new account.

User List: All the existing user accounts will be displayed here. You may delete accounts includes in the list, but please reserve at least one as guest.

Camera Name: Create a unique name for your camera that will be added to the file name prefix when creating a snapshot or a video clip.

Enable OSD: Select this option to enable the On-Screen Display feature for your camera.

Label: Enter a label for the camera.

Show Time: Select this option to enable the time-stamp display on the video screen.

D-Link

DCS-3112 // LIVE VIDEO SETUP ADVANCED MAINTENANCE STATUS HELP

Admin
System
Firmware Upgrade
Logout

ADMIN

Here you can change the administrator's password for your camera as well as add and/or delete user account(s). You can configure the information, such as camera's name and time via this page. You can also enable the OSD (On-Screen Display) feature in order to display the camera name and time stamp for your video recordings.

ADMIN PASSWORD SETTING

New Password 8 characters maximum
Retype Password Save

ADD USER ACCOUNT

User Name 20 users maximum
New Password 8 characters maximum
Retype Password
Add

USER LIST

User Name -- User list -- Delete

DEVICE SETTING

Camera Name DCS-3112 30 characters maximum
 Enable OSD
Label DCS-3112
Show time
Save

Helpful Hints..

Enabling OSD, the camera name and time will be displayed on the video screen for the user.

For security purposes, it is recommended that you change the password for your administrator account. Be sure to write down the new password to avoid having to reset the camera in the event that it is forgotten.

Backup and Restore

In this section, you may backup, restore and reset the camera configuration, or reboot the camera.

Save To Local Hard Drive: You may save and document your current settings into your computer.

Local From Local Hard Drive: Locate a pre-saved configuration by clicking **Browse** and then restore the pre-defined settings to your camera by clicking **Load Configuration**.

Restore to Factory Default: You may reset your camera and restore the factory settings by clicking **Restore Factory Defaults**.

Reboot Device: This will restart your camera.

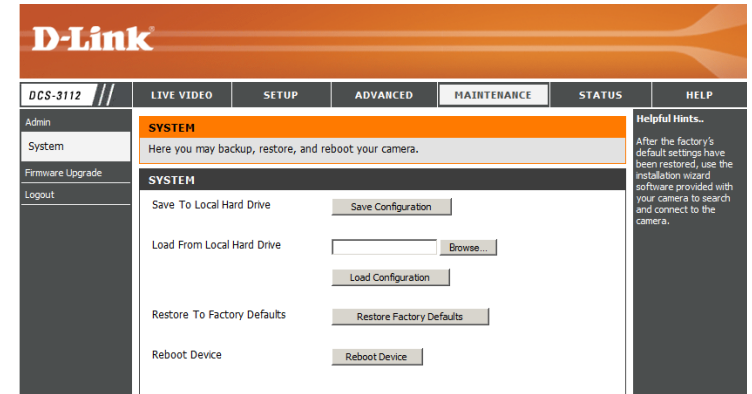

Firmware Upgrade

The camera's current firmware version will be displayed on this screen. You may visit the D-Link Support Website to check for the latest available firmware version.

To upgrade the firmware on your DCS-3112, please download and save the latest firmware version from the D-Link Support Page to your local hard drive. Locate the file on your local hard drive by clicking the **Browse** button. Select the file and click the **Upload** button to start upgrading the firmware.

Current Firmware Version: Displays the detected firmware version.

Current Product Name: Displays the camera model name.

File Path: Locate the file (upgraded firmware) on your hard drive by clicking **Browse**.

Upload: Uploads the new firmware to your camera.

The screenshot displays the D-Link web interface for the DCS-3112 camera. The top navigation bar includes 'LIVE VIDEO', 'SETUP', 'ADVANCED', 'MAINTENANCE', 'STATUS', and 'HELP'. The 'MAINTENANCE' tab is selected. The main content area is titled 'FIRMWARE UPGRADE' and contains the following text:

A new firmware upgrade may be available for your IP camera. It is recommended to keep your IP camera firmware up-to-date to maintain and improve the functionality and performance of your internet camera. Click here [D-Link Support Page](#) to check for the latest firmware version available.

To upgrade the firmware on your IP camera, please download and save the latest firmware version from the D-Link Support Page to your local hard drive. Locate the file on your local hard drive by clicking the Browse button. Once you have found and opened the file using the browse button, click the "Upload" button to start the firmware upgrade.

FIRMWARE INFORMATION

Current Firmware Version:	0.26.00
Current Product Name:	DCS-3112

FIRMWARE UPGRADE

File Path:

On the right side, there is a 'Helpful Hints...' section with additional information about firmware updates.

Status

Device Info

This page displays detailed information about your device and network connection.

DCS-3112 //		LIVE VIDEO	SETUP	ADVANCED	MAINTENANCE	STATUS	HELP																									
Device Info	DEVICE INFO						Helpful Hints... This page displays all the information about the camera and network settings.																									
Log	All of your network connection details are displayed on this page. The firmware version is also displayed here.																															
Logout	INFORMATION <table border="1"> <tbody> <tr><td>Camera Name</td><td>DCS-3112</td></tr> <tr><td>Time & Date</td><td>Mon Oct 19 17:54:46 2009</td></tr> <tr><td>Firmware Version</td><td>0.26.00</td></tr> <tr><td>MAC Address</td><td>00:0C:0C:80:09:09</td></tr> <tr><td>IP Address</td><td>172.17.5.113</td></tr> <tr><td>IP Subnet Mask</td><td>255.255.255.0</td></tr> <tr><td>Default Gateway</td><td>172.17.5.254</td></tr> <tr><td>Primary DNS</td><td>0.0.0.0</td></tr> <tr><td>Secondary DNS</td><td>168.95.1.1</td></tr> <tr><td>PPPoE</td><td>Disable</td></tr> <tr><td>DDNS</td><td>Disable</td></tr> <tr><td>AES</td><td>Enable</td></tr> <tr><td>TV Output Mode</td><td>NTSC</td></tr> </tbody> </table>							Camera Name	DCS-3112	Time & Date	Mon Oct 19 17:54:46 2009	Firmware Version	0.26.00	MAC Address	00:0C:0C:80:09:09	IP Address	172.17.5.113	IP Subnet Mask	255.255.255.0	Default Gateway	172.17.5.254	Primary DNS	0.0.0.0	Secondary DNS	168.95.1.1	PPPoE	Disable	DDNS	Disable	AES	Enable	TV Output Mode
Camera Name	DCS-3112																															
Time & Date	Mon Oct 19 17:54:46 2009																															
Firmware Version	0.26.00																															
MAC Address	00:0C:0C:80:09:09																															
IP Address	172.17.5.113																															
IP Subnet Mask	255.255.255.0																															
Default Gateway	172.17.5.254																															
Primary DNS	0.0.0.0																															
Secondary DNS	168.95.1.1																															
PPPoE	Disable																															
DDNS	Disable																															
AES	Enable																															
TV Output Mode	NTSC																															

Logs

This page displays the log information of your camera. You may download the information by clicking **Download**. You may also click **Clear** to delete the saved log information.

D-Link

DCS-3112 //

LIVE VIDEO SETUP ADVANCED MAINTENANCE STATUS HELP

Device Info

Log

Logout

SYSTEM LOG

The system log records camera events that have occurred.

CURRENT LOG

1. 2009-10-19 17:50:54 MOTION OCCURRED
2. 2009-10-19 17:50:53 MOTION OCCURRED
3. 2009-10-19 17:50:50 MOTION OCCURRED
4. 2009-10-19 17:50:49 MOTION OCCURRED
5. 2009-10-19 17:50:48 MOTION OCCURRED
6. 2009-10-19 17:50:47 MOTION OCCURRED
7. 2009-10-19 17:50:46 MOTION OCCURRED
8. 2009-10-19 17:50:45 MOTION OCCURRED
9. 2009-10-19 17:50:43 MOTION OCCURRED
10. 2009-10-19 17:50:38 MOTION OCCURRED
11. 2009-10-19 17:50:37 MOTION OCCURRED
12. 2009-10-19 17:50:36 MOTION OCCURRED
13. 2009-10-19 17:50:34 MOTION OCCURRED
14. 2009-10-19 17:50:33 MOTION OCCURRED
15. 2009-10-19 17:50:31 MOTION OCCURRED
16. 2009-10-19 17:50:30 MOTION OCCURRED
17. 2009-10-19 17:50:29 MOTION OCCURRED
18. 2009-10-19 17:50:28 MOTION OCCURRED
19. 2009-10-19 17:50:27 MOTION OCCURRED
20. 2009-10-19 17:49:48 MOTION OCCURRED

First Page Previous 20 Next 20

Clear Download

Helpful Hints..

You can save the log to your local hard drive by clicking the Download button, and you can clear the log by clicking on the Clear button.

Help

This page provides helpful information regarding camera operation.

The screenshot displays the D-Link web interface for the DCS-3112 camera. At the top, the D-Link logo is visible on an orange background. Below the logo is a navigation bar with tabs for LIVE VIDEO, SETUP, ADVANCED, MAINTENANCE, STATUS, and HELP. The HELP tab is currently selected. On the left side, there is a sidebar with 'Help' and 'Logout' options. The main content area is titled 'HELP' and contains a list of links organized into sections: LIVE VIDEO (Camera), SETUP (Setup Wizard, Network Setup, Wireless Setup, Dynamic DNS, Image Setup, Audio and Video, Preset, Motion Detection, Time and Date, Event Setup, SD Card), ADVANCED (DI and DO, HTTPS, Access List), MAINTENANCE (Admin, System, Firmware Upgrade), and STATUS (Device Info, Log).

DCS-3112		LIVE VIDEO	SETUP	ADVANCED	MAINTENANCE	STATUS	HELP
Help		HELP					
Logout		<ul style="list-style-type: none"> LIVE VIDEO SETUP MAINTENANCE ADVANCED STATUS 					
		LIVE VIDEO					
		<ul style="list-style-type: none"> Camera 					
		SETUP					
		<ul style="list-style-type: none"> Setup Wizard Network Setup Wireless Setup Dynamic DNS Image Setup Audio and Video Preset Motion Detection Time and Date Event Setup SD Card 					
		ADVANCED					
		<ul style="list-style-type: none"> DI and DO HTTPS Access List 					
		MAINTENANCE					
		<ul style="list-style-type: none"> Admin System Firmware Upgrade 					
		STATUS					
		<ul style="list-style-type: none"> Device Info Log 					

DI/DO Schematics

DI/DO

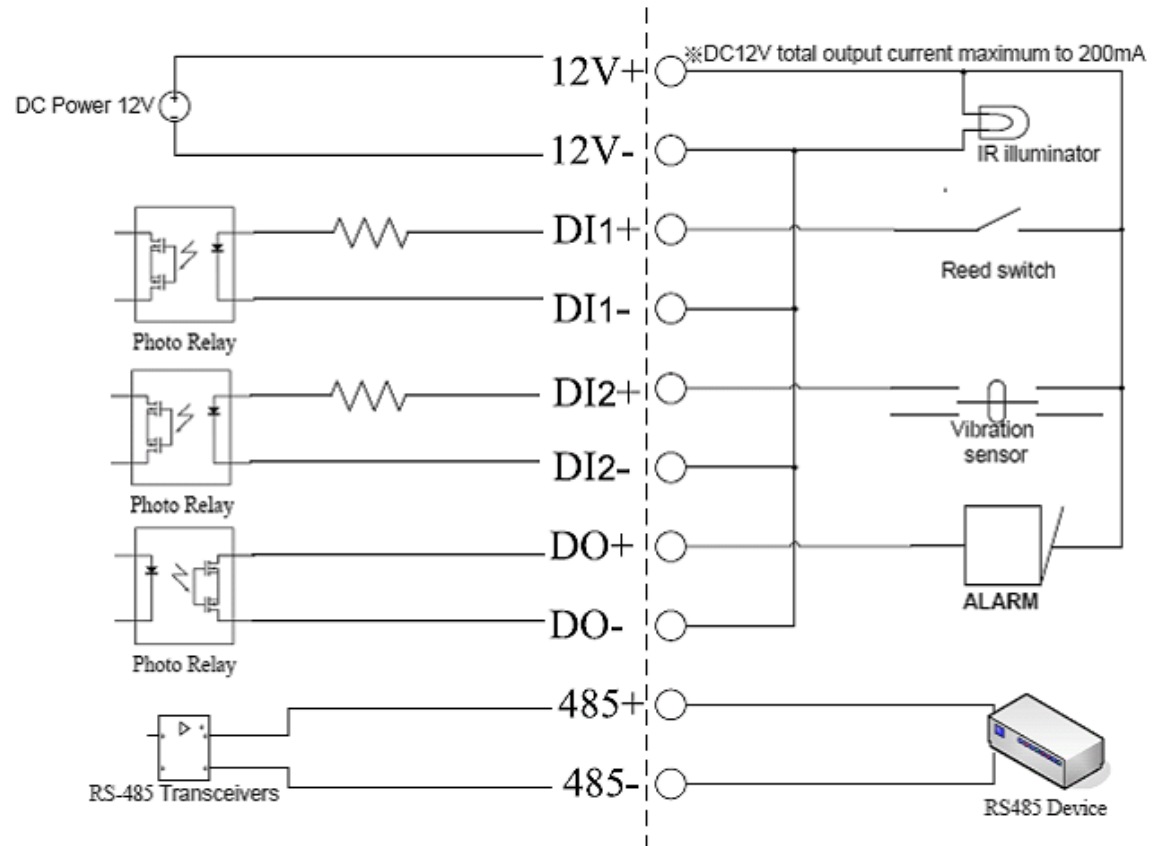

Technical Specifications

Camera	Camera Hardware Profile	<ul style="list-style-type: none"> ▪ Sony Exmor 1/4" 1.3 Megapixel progressive CMOS sensor ▪ Minimum illumination: 0.4 lux (Color); 0.04 lux (B/W) ▪ Built-in Infrared-Cut Removable (ICR) Filter module ▪ 10X digital zoom 	<ul style="list-style-type: none"> ▪ DC iris varifocal length: 3.5 mm to 8 mm ▪ Aperture: F1.4 ▪ Angle of view: (H) 35.4° to 77.6° (V) 26.6° to 57.6° (D) 44.3° to 97.9°
	Image Features	<ul style="list-style-type: none"> ▪ Configurable image size, quality, frame rate, and bit rate ▪ Time stamp and text overlays ▪ Configurable motion detection windows 	<ul style="list-style-type: none"> ▪ 3 configurable privacy mask zones ▪ Configurable white balance, shutter speed, brightness, saturation, contrast, and sharpness
	Video Compression	<ul style="list-style-type: none"> ▪ H.264/MPEG-4/MJPEG simultaneous format compression ▪ JPEG for still images 	<ul style="list-style-type: none"> ▪ H.264/MPEG-4 multicast streaming
	Video Resolution	<ul style="list-style-type: none"> ▪ 16:9 - 1280 x 720, 800 x 450, 640 x 360, 480 x 270, 320 x 176, 176 x 144 ▪ 4:3 - 1280 x 1024, 1280 x 960, 1024 x 768, 800 x 600, 640 x 480, 480 x 360, 320 x 240, 176 x 144 ▪ All resolutions support frame rates of up to 30 fps 	
	Audio Support	<ul style="list-style-type: none"> ▪ G.726 	
	External Device Interface	<ul style="list-style-type: none"> ▪ 2 DI / 1 DO interface ▪ 12 V DC, 200 mA Output ▪ RS-485 	<ul style="list-style-type: none"> ▪ SD card ▪ Audio input / output ▪ Video output
Network	Network Protocols	IPv4, TCP/IP, UDP, ICMP, DHCP Client, NTP Client (D-Link), DNS Client, DDNS Client (D-Link), SMTP Client, FTP Client, HTTP/HTTPS, Samba Client, PPPoE, UPnP Port Forwarding, RTP/RTSP/RTCP, IP filtering, 3GPP, IGMP, ONVIF compliant	
	Security	<ul style="list-style-type: none"> ▪ Administrator and user group protection ▪ Password authentication 	<ul style="list-style-type: none"> ▪ HTTP and RTSP digest encryption

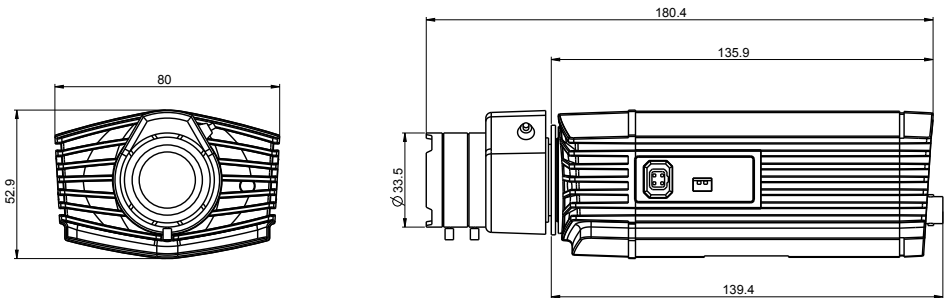
System Management	System Requirements for Web Interface	<ul style="list-style-type: none"> ▪ Operating System: Microsoft Windows 7/Vista/XP/2000 ▪ Browser: Internet Explorer, Firefox, Netscape, Opera
	Event Management	<ul style="list-style-type: none"> ▪ Motion detection ▪ Event notification and upload of snapshots/video clips via HTTP, SMTP, or FTP ▪ Supports multiple HTTP, SMTP, and FTP servers ▪ Multiple event notifications ▪ Multiple recording methods for easy backup
	Remote Management	<ul style="list-style-type: none"> ▪ Configuration accessible via web browser ▪ Take snapshots/video clips and save to local hard drive or NAS via web browser
	Mobile Support	Windows 7/Vista/XP system, Pocket PC, or mobile phone with 3GPP playback support
	D-ViewCam™ System Requirements	<ul style="list-style-type: none"> ▪ Operating System: Microsoft Windows 7/Vista/XP ▪ Web Browser: Internet Explorer 6 or higher ▪ Protocol: Standard TCP/IP
	D-ViewCam™ Software Functions	<ul style="list-style-type: none"> ▪ Remote management/control of up to 32 cameras ▪ Viewing of up to 32 cameras on one screen ▪ Supports all management functions provided in web interface ▪ Scheduled motion-triggered or manual recording options
General	Power Input	12 V DC 1.25 A, 50/60 Hz, 802.3af PoE
	Max. Power Consumption	3.6 watts
	Operating Temperature	0 to 40 °C (32 to 104 °F)
	Storage Temperature	-20 to 70 °C (-4 to 158 °F)
	Humidity	20% to 80% non-condensing
	Weight	560 g
	Certifications	CE (Class A), LVD, FCC (Class A), ICES-003, C-Tick
Dimensions	 <p>The image contains two technical drawings of the D-ViewCam camera. The left drawing is a front view showing a width of 80 mm and a height of 52.9 mm. The right drawing is a side view showing a total length of 180.4 mm, a lens diameter of 33.5 mm, a mounting bracket length of 135.9 mm, and a main body length of 139.4 mm.</p>	