



User Manual

JustConnect 16-Channel PoE Network Video Recorder

DNR-4020-16P

Preface

D-Link reserves the right to revise this publication and to make changes in the content hereof without obligation to notify any person or organization of such revisions or changes. Information in this document may become obsolete as our services and websites develop and change.

Manual Revision

Revision	Date	Description
1.00	October 8, 2020	• A1 Initial version

Trademarks

D-Link and the D-Link logo are trademarks or registered trademarks of D-Link Corporation or its subsidiaries in the United States or other countries. All other company or product names mentioned herein are trademarks or registered trademarks of their respective companies.

Copyright © 2021 by D-Link Corporation, Inc.

All rights reserved. This publication may not be reproduced, in whole or in part, without prior expressed written permission from D-Link Corporation, Inc.

Apple®, Apple logo®, iPhone®, iPad®, iPod touch® and Macintosh® are trademarks of Apple Inc., registered in the U.S. and other countries. App StoreSM is a service mark of Apple Inc. Google Play™ and Android™ are trademarks of Google Inc.

Internet Explorer®, Windows® and the Windows logo are trademarks of the Microsoft group of companies.

Table of Contents

Product Overview	1	Storage Mode.....	35
Package Contents.....	1	S.M.A.R.T.....	36
System Requirements.....	2	Disk Calculation.....	37
Introduction.....	3	FTP.....	38
Hardware Overview.....	4	Alarm.....	39
Front View.....	4	General.....	39
Rear Panel (Connections).....	5	Motion Detection.....	40
Installation	6	Video Loss.....	41
Hard Drive Installation.....	6	Alarm In.....	42
Setting Up Your DNR-4020-16P (HDMI / VGA).....	8	Abnormal Alarm.....	43
Initial Configuration.....	9	Alarm Out.....	44
Live View.....	11	Network.....	45
Setup.....	12	Network.....	45
Channel.....	12	DDNS.....	48
Camera.....	12	Port Mapping.....	49
RTSP Connection.....	14	Email.....	50
Encode.....	15	IP Filter.....	51
Sensor Settings.....	17	SNMP.....	52
OSD.....	25	Network Status.....	53
Privacy Zone.....	26	PPPoE.....	54
Microphone.....	27	Network Traffic.....	55
Human Thermometer.....	28	System.....	56
Record.....	33	Information.....	56
Record Schedule.....	33	General.....	61
Disk.....	34	User Account.....	66
		Security Center.....	68

Auto Sequence	69	Disk	109
Auxiliary Sequence	70	Storage Mode.....	110
Logs	71	S.M.A.R.T.....	111
Maintenance.....	73	Disk Calculation.....	112
Auto Reboot	75	FTP.....	113
Playback	76	Alarm.....	114
Time Search	76	General	114
Picture Grid	77	Motion Detection	115
Event Recording.....	78	Video Loss.....	116
Backup List	79	Alarm In.....	117
Setting Up Your DNR-4020-16P (Web GUI)	80	Abnormal Alarm.....	118
Initial Configuration.....	82	Alarm Out	119
Live View / Home Screen	83	Network	120
Playback.....	85	Network.....	120
Alarm Search	86	DDNS.....	123
System	87	Port Mapping	124
Channel	87	Email.....	125
Camera.....	87	IP Filter	126
RTSP Connection.....	89	SNMP	127
Encode	90	Web Mode	128
Sensor Settings.....	92	PPPoE	129
OSD	100	Network Status	130
Privacy Zone	101	System	131
Microphone	102	Information	131
Human Thermometer.....	103	System	132
Record.....	108	User Account	137
Record Schedule	108	Security Center	139

Logs	140
Maintenance.....	142
Auto Reboot	144
Password Reset.....	145
Designate E-mail Address.....	145
Obtain Verification Code.....	146
Resetting User Password.....	147
Troubleshooting	148
Technical Specifications	149
Regulatory Information.....	152

Product Overview

Package Contents

- DNR-4020-16P JustConnect 16-Channel PoE Network Video Recorder
- Power cord
- 8 x hard disk screw
- 2 x rack mount bracket
- 6 x rack mount bracket screw
- 2 x terminal block
- Documentation



Note: *Using a power supply with a different voltage than the one included with your product will cause damage and void the warranty for this product.*

If any of the above items are missing, please contact your reseller.

System Requirements

Hardware Requirements	<ul style="list-style-type: none">• Two 3.5" SATA hard disk drives (not included)
Network Requirements	<ul style="list-style-type: none">• Broadband Internet connection (for remote access)• Network camera(s) (refer to the D-Link website for a list of supported cameras)• 10/100/1000 Mbps Ethernet switch or router
Web-based Configuration Utility / Remote PC Minimum Requirements	Computer with the following: <ul style="list-style-type: none">• Microsoft Windows• Microsoft Edge, Internet Explorer, Firefox, Chrome or Safari

Introduction

The DNR-4020-16P is a standalone wired Network Video Recorder (NVR) which supports multi-channel network cameras with H.265 and H.264 recording and two SATA hard disks for backup. Thanks to a powerful embedded system, the NVR can record video from network cameras located in local or remote sites into a dedicated HDD storage without having to turn on a PC. The DNR-4020-16P NVR supports real-time monitoring and playback from everywhere via browser, HDMI or VGA port. The triplex function enables the device to continue recording while allowing the user to watch the live view and search for playback videos.

Automated Surveillance

Users are provided with a variety of options for viewing live streams and camera footage on-screen as well as automatically recording events as they happen, with or without an operator on-site. Event-based recording is available for cameras with motion detection and Alarm In connections are supported for triggers such as door and window sensors for automated recording during unusual events. User-defined scheduled recording and continuous recording with automatic overwriting options help to ensure the surveillance system is running reliably, even when no one is around.

Extensive Monitoring and Recording Features

The DNR-4020-16P's intuitive interface allows for easy configuration of many functions, including compression, resolution, and frame rate. Support for multiple encoding formats provides administrators the flexibility to prioritize storage space and video quality. Featuring live viewing of multiple channels, users can simply drag and drop selected cameras to the viewing area.

Smooth Streaming from Anywhere

The DNR-4020-16P also enables users to remotely view and manage the NVR from anywhere via a web browser. The Gigabit Ethernet port provides superior bandwidth for viewing 16 camera streams simultaneously, so critical moments can be monitored and captured at all times. Rounding out the features is the JustConnect+ mobile app that lets administrators easily and remotely access and monitor the DNR-4020-16P on a mobile device — making the JustConnect H.265 PoE Network Video Recorder a complete, easy-to-use enterprise surveillance solution.

Hardware Overview

Front View

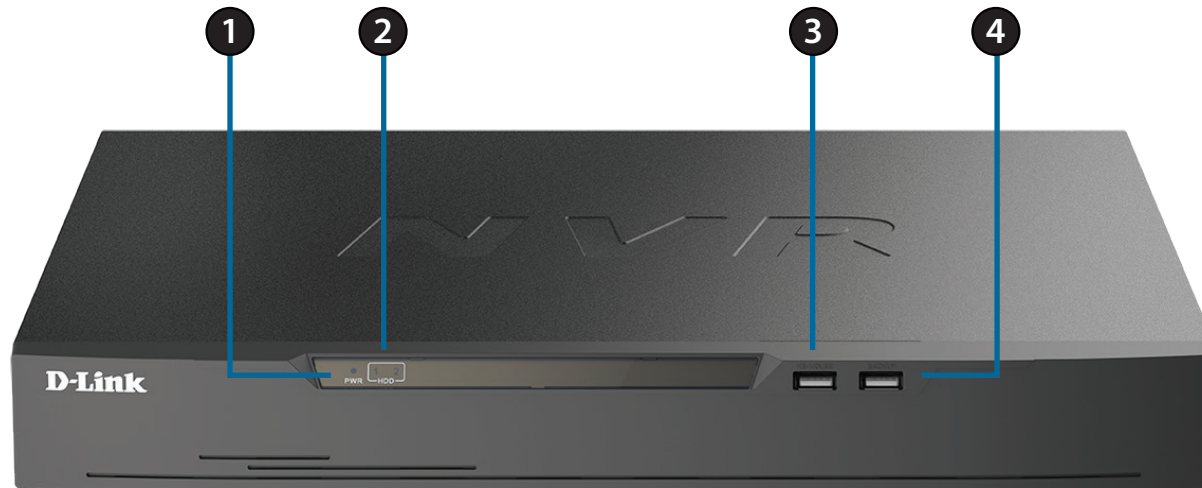

1	Power Indicator	Lights up when the device is receiving power and the power switch is turned on.
2	HDD Indicator	Hard disk status indicator. This indicator flashes when data is being transmitted.
3	KB/Mouse Port	USB port for a mouse or keyboard.
4	Backup Port	USB port for a flash drive.

Rear Panel (Connections)

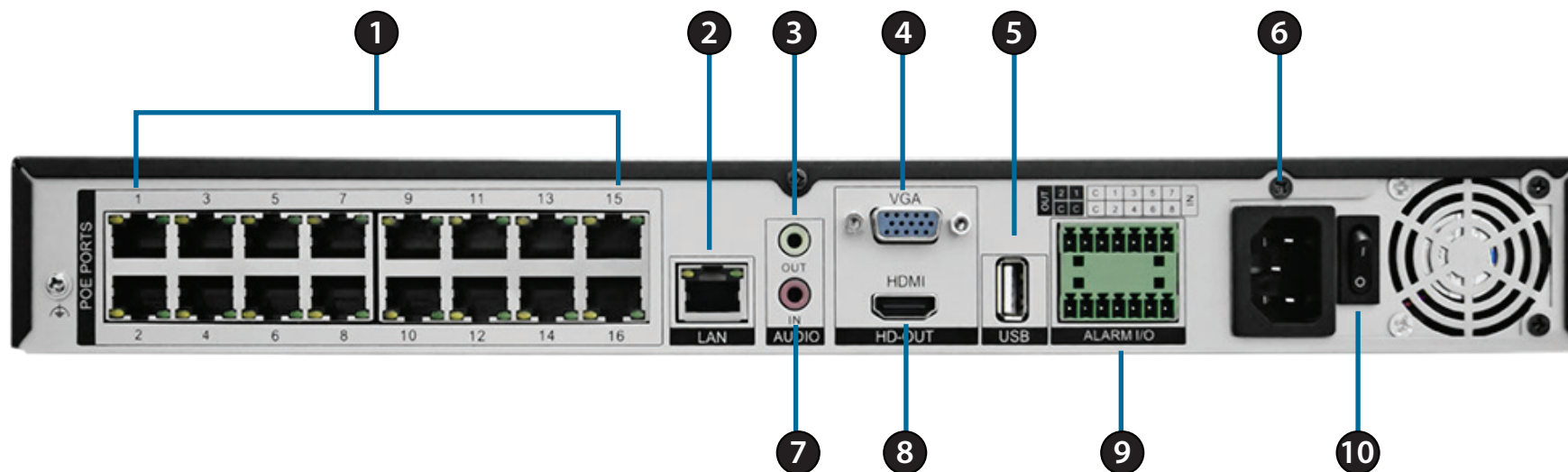

1	PoE Ports	PoE ports that offer direct connection to up to 16 cameras.
2	LAN	Uses a standard Ethernet cable to connect to a switch or router.
3	Audio OUT	Connect external speakers for live audio or audio playback.
4	VGA Output	Output connector for a VGA monitor.
5	USB 2.0 Port	Connect a USB storage device such as a flash drive.
6	Power	Connect the supplied power cord to the input port.
7	Audio IN	Connect a microphone to use 2-way communication with your camera(s).
8	HDMI Output	Output connector for an HDMI monitor.
9	Alarm I/O	Alarm I/O ports for connecting to sensors or other devices.
10	Power Switch	Press "1" to turn the device on, "0" to turn it off.

Installation

Hard Drive Installation

1. First, make sure the power cable is not plugged into a power outlet. Remove the fixing screws from the top cover of the DNR-4020-16P, then remove the top cover from the device.

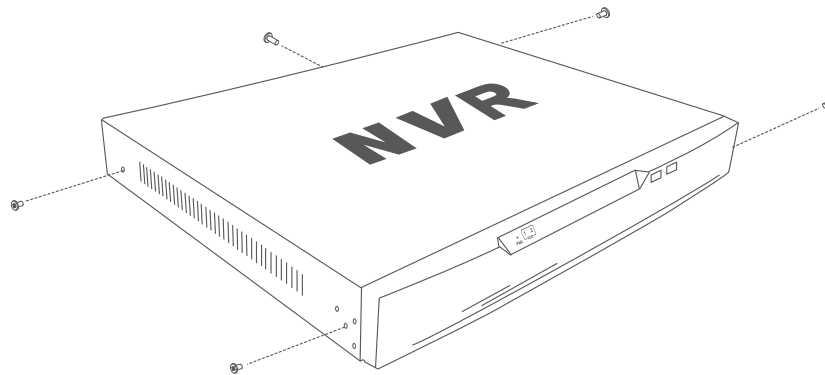

2. Insert two screws into the holes near the rear panel of the hard drive. Turn the screws twice, so that they protrude slightly.

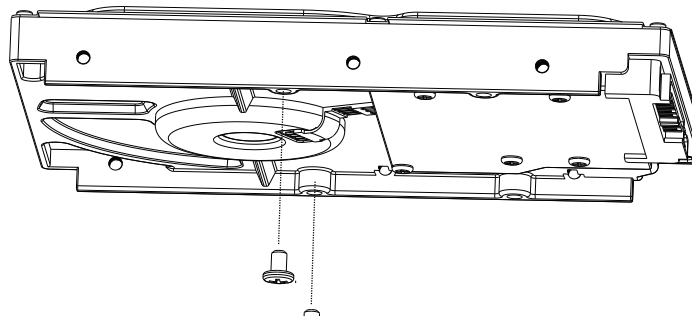

3. Insert the hard drive into the drive bay of the DNR-4020-16P, fitting the heads of the two screws into the slots on the bottom of the device. Slide the hard drive toward the center of the DNR-4020-16P so that it locks into position.

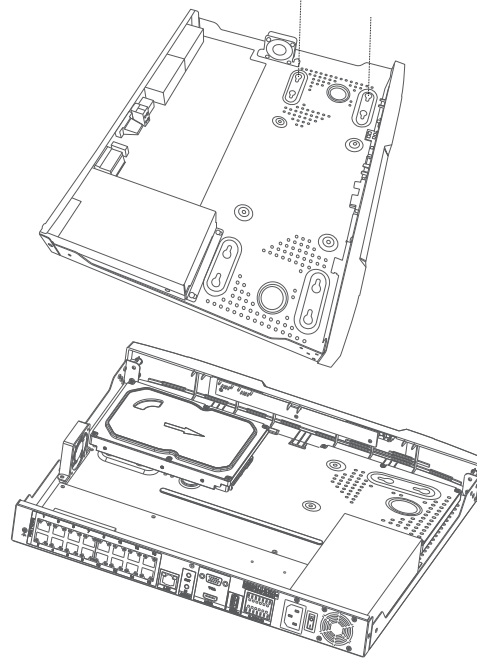

4. Turn the device over and secure the hard drive inside the device by screwing the provided screws into the four remaining holes on the bottom of the DNR-4020-16P. If desired, install a second hard drive by repeating steps 1-4. Attach the hard disk data cable and power cable to the device, then reattach the top cover and fasten the fixing screws..

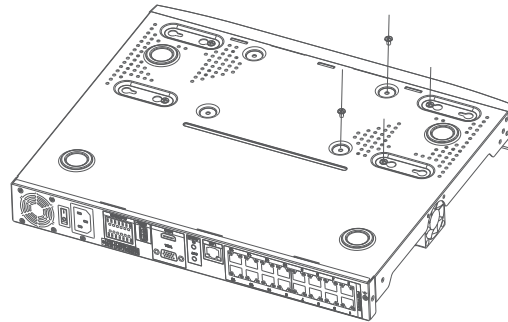

5. Re-attach the top cover by sliding it over the device. Re-insert the shorter screws in the rear and the longer screws in the sides of the cover to secure it.

Setting Up Your DNR-4020-16P (HDMI / VGA)

You can connect PoE network cameras directly to your DNR-4020-16P using the 16 PoE ports on the rear panel.

For non-PoE network cameras, you will need to locate power outlets in the on-site environment then run a CAT5 UTP cable to the LAN ports on the NVR.

You can set up your NVR without using a PC by connecting a VGA or HDMI display to the respective port on the back of the device. To control the Graphical User Interface (GUI), connect a USB mouse to the USB port on the front panel.

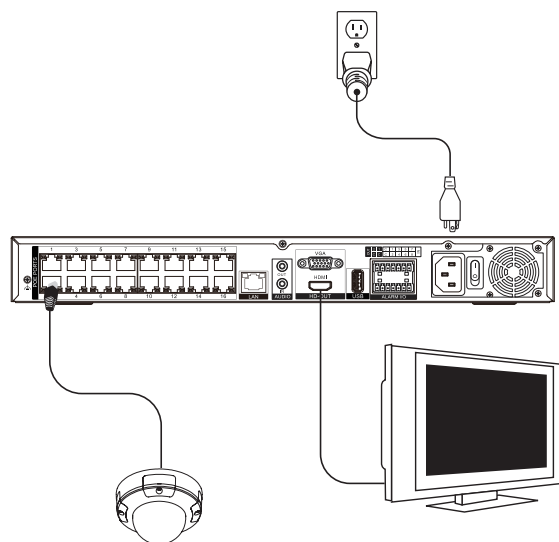

Initial Configuration

1. You can set up your NVR without using a PC by connecting a VGA or HDMI display to the respective port on the back of the device. To control the Graphical User Interface (GUI), connect a USB mouse to the USB port on the front panel. After powering on the DNR-4020-16P for the first time, the **Login** window will appear in the center of the screen.
2. Select your preferred language, and enter a user name and password that will be used to access the management interface. Confirm the password by retyping it.
3. In the Default channel password field, enter the password that will be used to view and configure the device's channels. Click OK to continue.
4. On the next screen, reenter the admin password and click Login to access the management interface.



You can set up the NVR and add cameras by using the setup wizard that will automatically load after logging in. Click Start Wizard to begin.

Configure the DNR-4020-16P's settings on the subsequent pages. For more detail, refer to the corresponding pages:

- **Network:** Refer to page 44
- **Date and Time:** Refer to page 61
- **Camera:** Refer to page 12
- **Disk:** Refer to page 33
- **Resolution:** Refer to page 15



Live View

On this screen you can view the DNR-4020-16P's channels and access its various configuration options. Click the plus (+) icon in the top right corner of an unconfigured channel window to add a new camera and configure it.

For more in-depth configuration options, hover the mouse over the bottom left corner of the screen and click **System** or click the right mouse button. To view recordings, click Playback.

Other options are also available on the bottom taskbar. From left to right:

- **Split Screen:** Set how many channels should be displayed on the home screen
- **Previous/Next Page:** Step forward or backwards through the channels
- **Auto Sequence:** Automatically configure the channel display and begin cycling through channels
- **Volume:** Increase or decrease the NVR's volume
- **Playback:** Quickly access the Playback screen
- **Channel Information:** Determine what channel information to display on this page
- **Manual Alarm:** Quickly configure the alarm interfaces on the NVR and its connected cameras
- **Event List:** Display a list of recent events, such as motion detection and triggered alarms
- **Stop Alarm:** Stop an alarm that is currently in progress
- **Information:** Display information about the DNR-4020-16P, such as its operational status and IP address

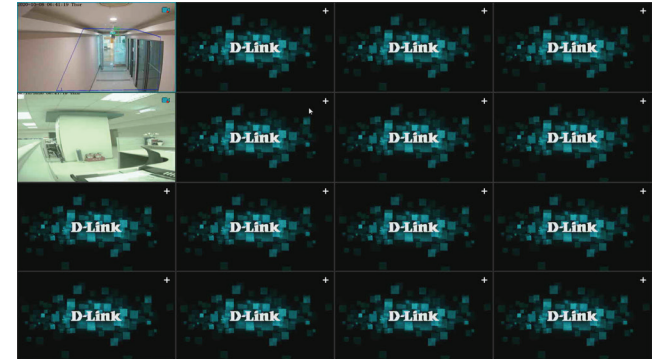

Setup Channel Camera

On this page, you can configure the DNR-4020-16P's 16 channels and add cameras to them. To search for available cameras, click Start Search. To add cameras to a channel, enter the username and password in the fields at the bottom of the screen and click Add.

Channel The channel the specified camera is on.

IP The camera's IP address.

Model The camera's model number.

Protocol The protocol used to communicate with the camera.

Firmware Version The firmware the specified camera is running.

Operate Click this to set or update the camera's settings.

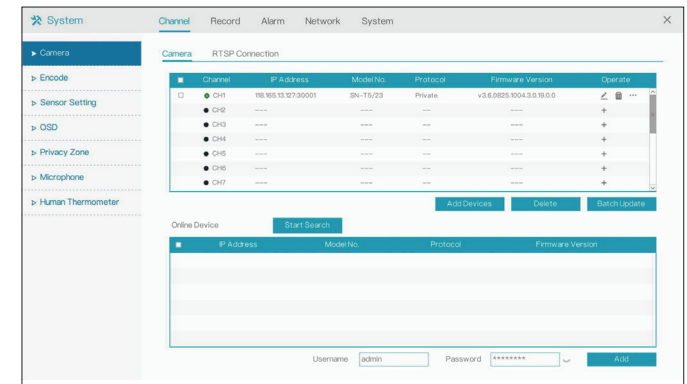

Configuring a Channel

Click the pencil icon under Operate to add a camera on a channel or to configure an existing channel.

Channel Name Enter a name to identify the channel.

IP Address Enter the IP address of the camera. If the camera is connected to one of the NVR's PoE ports, it will attempt to detect the IP address automatically.

Protocol Select the protocol to use (e.g. ONVIF).

Port Enter the port used to connect to the camera.

Username: Enter the username used to access the camera.

Password: Enter the password associated with the username above.

Remote Channel Designate a channel for the camera's display.

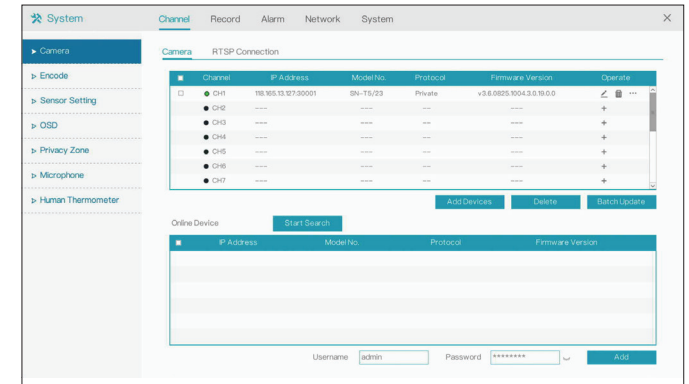

RTSP Connection

Use this page to configure your Real Time Streaming Protocol (RTSP) connection settings.

Custom Protocol Designate the custom protocol to use (select 1-16 from the drop-down menu).

Protocol Name Specify a protocol name to use.

Stream Type Select Main Stream or Sub Stream. If you select Sub Stream, the options on the right will be enabled.

Protocol Type Select the protocol type to use for the stream. This is set to RTSP by default.

Port Select the RTSP port to use. This is set to 554 by default.

Abs Path Enter the absolute path for the RTSP connection to use.

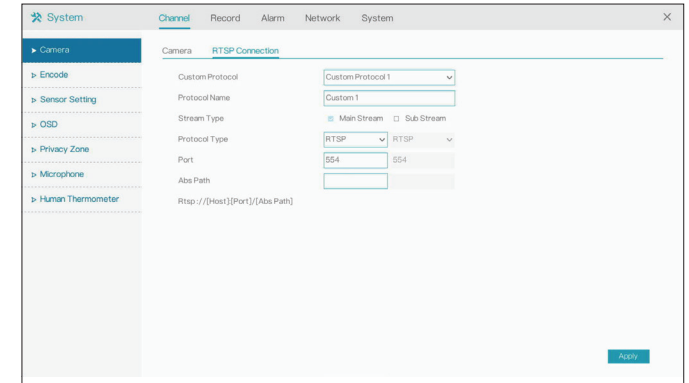

Encode

On this page, you can change the encoding settings for the video and audio streams on a particular channel.

- Channel** Specify the channel to modify.
- Stream Information** Indicates which stream the following information pertains to (i.e. Main Stream or Sub Stream).
- Video Format** Select the video encoding format to use for the channel (e.g. H.265, H.264, etc).
- Audio Encode Type** Select the audio encoding format to use for the channel (e.g. G711A, G711U, etc).
- Resolution** The resolution to use for the channel's display.
- Frame Rate (fps)** The frame rate at which to display the video.
- Bitrate Type** Select the bitrate type (e.g. CBR, VBR, etc)

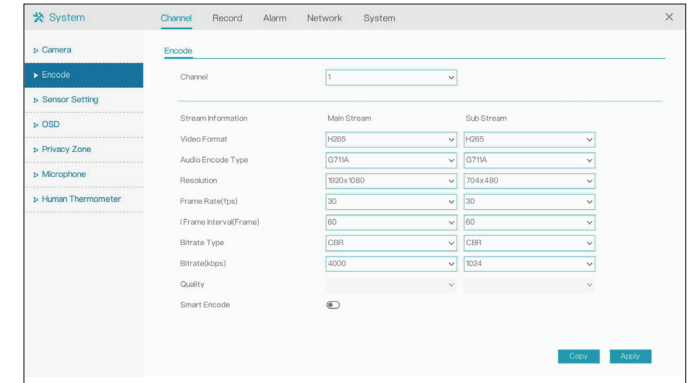

- Bitrate (kbps)** The bitrate will affect the bit rate of the video recorded by the camera. Higher bit rates result in higher video quality.
- Quality** Determine the quality of the stream from lowest to highest.
- Smart Encode** Click to enable or disable smart encoding. If selected, this will configure some of the settings above automatically. Support for IP cameras is only available via private protocol.

Sensor Settings

On the Sensor Settings page you can change aspects of the camera's display and its sensor's configuration settings.

Image

Scene Select the type of scene (Indoor or Outdoor) or select Default. The default settings are determined by the IP camera's video parameters.

Brightness Adjust the image brightness.

Sharpness Adjust the image sharpness.

Contrast Adjust the contrast.

Saturation Adjust the saturation.

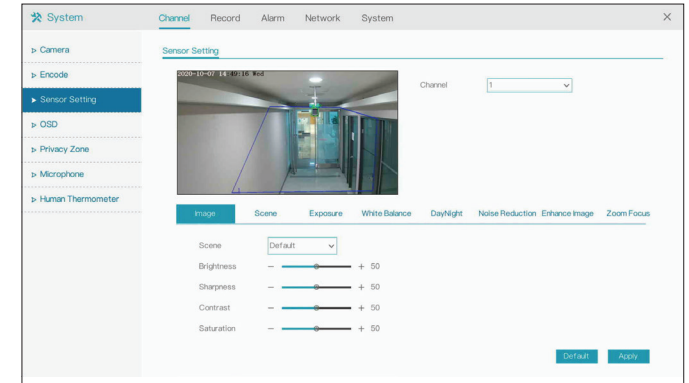

Scene

Aisle Mode Check this to enable or disable aisle (corridor) mode.

Scene Select whether the scene is Indoors or Outdoors.

Mirror From the drop-down, choose whether to display the scene normally or mirror it horizontally, vertically, or both.

The configuration options on this page are only available for cameras being accessed via private protocol.

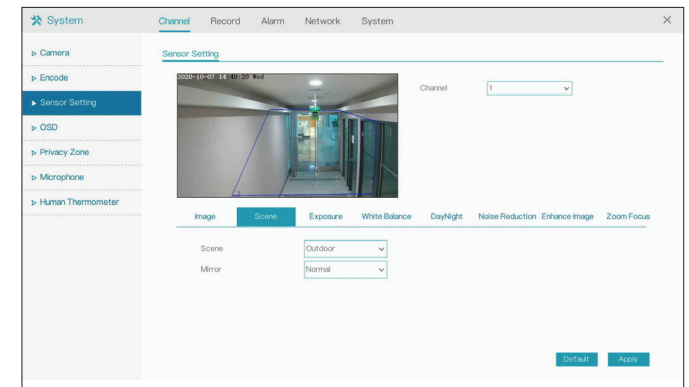

Exposure

Exposure Mode Choose the exposure mode. Select between Auto, Manual, Shutter Priority, and Iris Priority (aperture priority).

Meter Area Select the meter area.

Max Shutter Select the maximum shutter speed.

Max Gain Select the maximum gain.

The configuration options on this page are only available for cameras being accessed via private protocol.

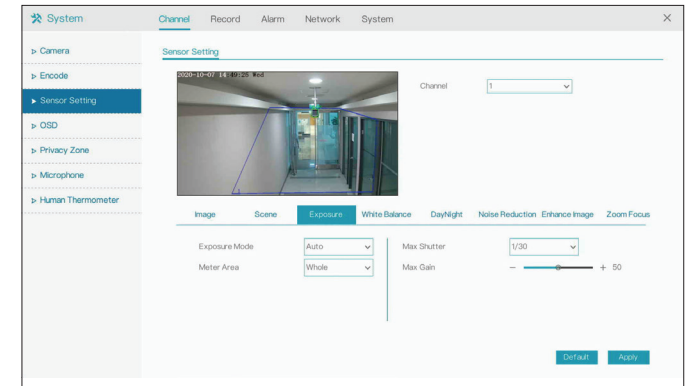

White Balance

Mode Select the mode from a variety of options, including Tungsten, Fluorescent, Daylight, Shadow, etc. If you select Manual, you will need to set the red and blue levels yourself.

The configuration options on this page are only available for cameras being accessed via private protocol.

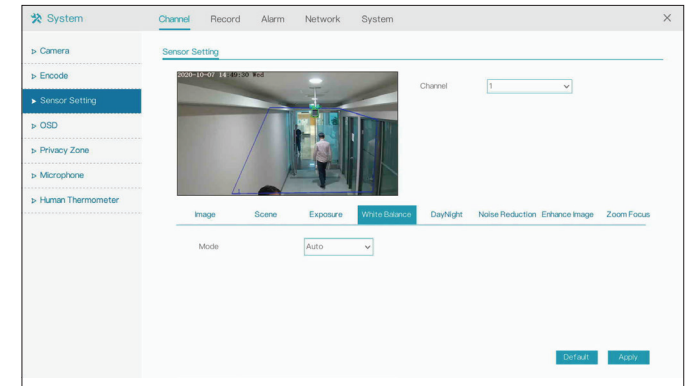

Day/Night

D/N Settings Choose whether to automatically or manually configure the day/night settings. If you select Timing, you will need to designate a day/night schedule in the fields that appear. If you select Auto, you will need to set the transition time between day and night modes, as well as the delay before the transition occurs.

The configuration options on this page are only available for cameras being accessed via private protocol.

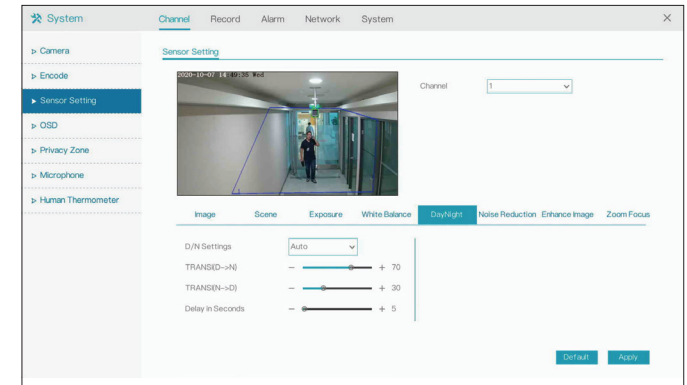

Noise Reduction

2D/3D NR Enable or disable 2D and 3D noise reduction.

Max Strength Select the maximum level of noise reduction to be applied to the image.

The configuration options on this page are only available for cameras being accessed via private protocol.

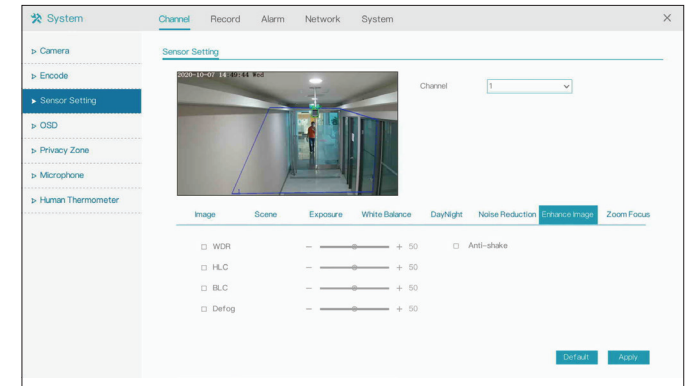

Enhance Image

WDR Enable this to optimize the display quality with wide dynamic range (WDR).

HLC Adjust for overexposure with highlight compensation (HLC).

BLC Adjust the overall lighting of the image with backlight compensation (BLC).

Defog Defog the image.

Anti-shake Enable this to compensate for minor shaking of the camera, making the video smoother.

The configuration options on this page are only available for cameras being accessed via private protocol.

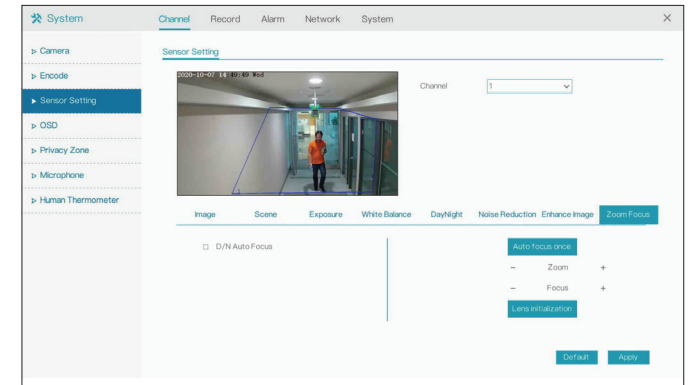

Zoom Focus

D/N Auto Focus Click this to automatically focus according to whether the camera is in day or night mode.

Auto focus once Click this to automatically focus the lens a single time.

Zoom Manually adjust the camera's zoom.

Focus Manually adjust the camera's focus.

Lens initialization Click this to recalibrate the lens's zoom and focus.

The configuration options on this page are only available for cameras being accessed via private protocol.

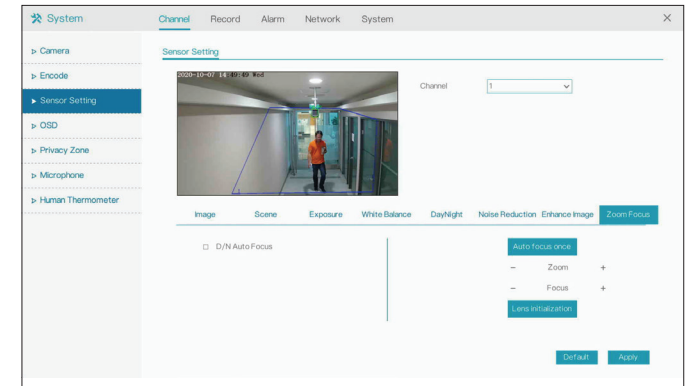

OSD

On this page you can configure the on-screen display (OSD) for the NVR's channels.

Channel Specify a channel.

Time Toggle this to display the current time on the selected channel's OSD.

Channel Name Toggle this to display the selected channel name on the OSD.

The configuration options on this page are only available for cameras being accessed via private protocol.

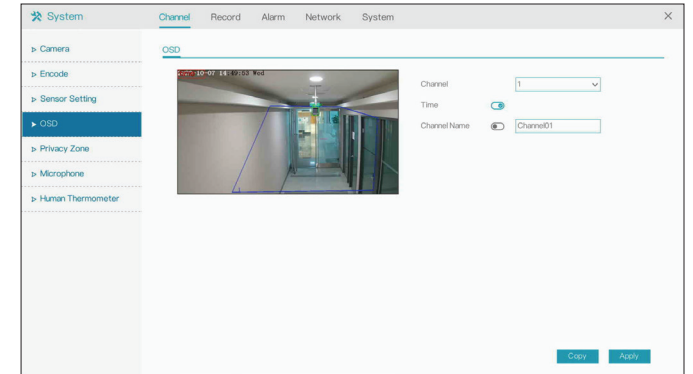

Privacy Zone

Click and drag a section of the screen to create a privacy zone. This area will not be viewable and will not be recorded. Double-click an existing privacy zone to delete it.

Channel Select the channel to add a privacy zone to. The DNR-4020-16P supports up to four zones.

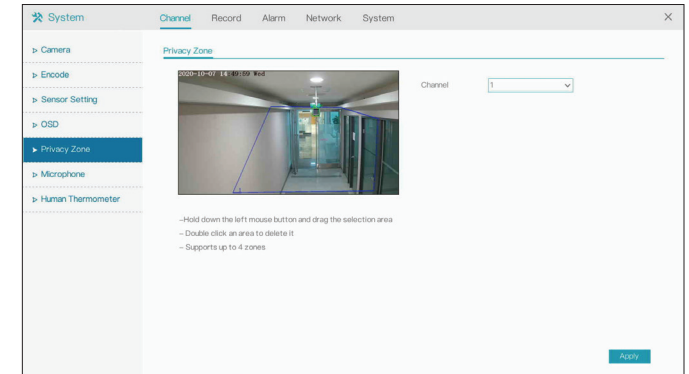

Microphone

Use this page to configure microphone settings for the specified channel. If no device with a microphone is connected, the settings will be locked.

Channel Select the channel to configure the microphone for.

Microphone Toggle this to enable or disable the microphone.

Microphone Type Specify the type of microphone connection (e.g. Line In).

Microphone Volume Adjust the microphone volume/sensitivity.

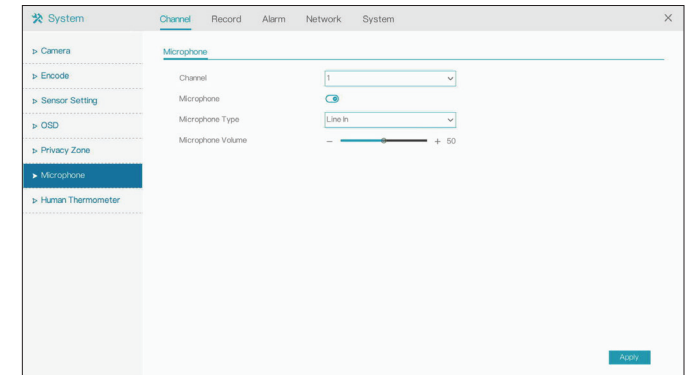

Human Thermometer

On this page you can configure the thermal mapping and calibration settings for thermal cameras on the specified channel.

Parameter Configure Use this tab to configure your thermal camera settings, if any thermal cameras are currently connected to the DNR-4020-16P.

Thermal Mapping Use this tab to set thermal mapping points on the camera's display.

Thermal Calibration Use this tab to calibrate the thermal camera with a separate calibration tool.

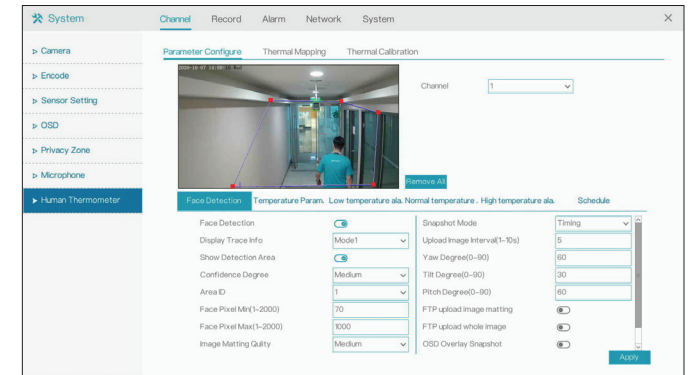

Face Detection

- Enable** Enable or disable face detection.
- Display Trace Info** Select the trace display mode from the drop-down menu.
- Show Detect. Area** Toggle this to show the temperature detection area with an outline.
- Conf. Degree** Select the confidence degree from the drop-down.
- Area ID** Designate an area ID to apply these settings to.
- Face Pixel Min/Max** Enter the minimum and maximum number of pixels that may be registered as a person's face.
- Image Matting Quality** Select the image matting quality from the drop-down.
- Snapshot Mode** Select the snapshot mode from the drop-down.
- Upload Image Interval** Select the interval (from 1 to 10, in seconds) at which snapshots should be uploaded.

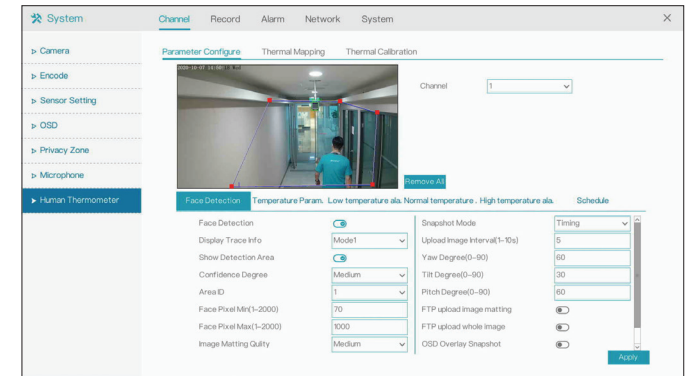

Yaw/Tilt/Pitch Degree

Enter the yaw, tilt and pitch degrees, from 0 to 90 degrees.

FTP upload image matting/whole image

Toggle this to configure which parts of the image should be uploaded via FTP at the interval entered above.

OSD Overlay Snapshot

Toggle this to overlay the time, date, channel, etc over the snapshots

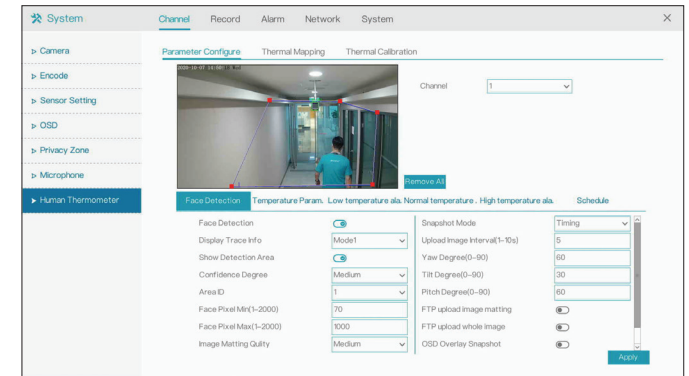

Temperature Param.

- Enable** Toggle this to enable temperature measurement.
- Temperature Unit** Select the desired unit from Fahrenheit and Celsius.
- Length Units** Select the unit to measure objects in the camera's display.
- Cavity Temp.** Enter the cavity temperature of the camera.
- Correction Coefficient** This refers to the difference between the measured temperature of an object and the actual temperature. Enter a value manually.
- Mount Distance** Enter the height at which the camera is mounted.
- Face Color** Toggle this to overlay detected faces with a color corresponding to their measured temperature.
- Environment Adaptation** Toggle this to automatically compensate for the temperature of the environment.
- Abnormal Temp. Display** Toggle this to flag detected abnormal temperatures.
- Temperature Area** Select the desired temperature area mode from the drop-down list.
- Temp. Measure Mode** Select the desired measurement mode from the drop-down list.
- Normal Temp. Range** Enter the normal temperature range. Values outside this range can be set to trigger an alarm.

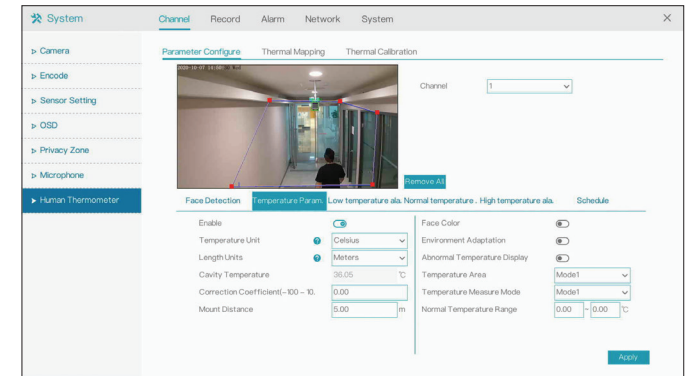

Temperature Alarm

On these tabs you can configure an alarm to trigger when an object is detected with a low, normal, or high temperature. Select the event(s) the alarm should trigger from the following list:

- **Email:** Send an email notification
- **FTP:** Send a notification via FTP
- **Popup Message:** Display a notification in a popup window
- **Full Screen:** Display a full-screen notification on the attached monitor
- **Buzzer:** Trigger a buzzer sound

Schedule

On this tab, you can click the calendar to set the thermometer to enable or disable according to a set schedule.

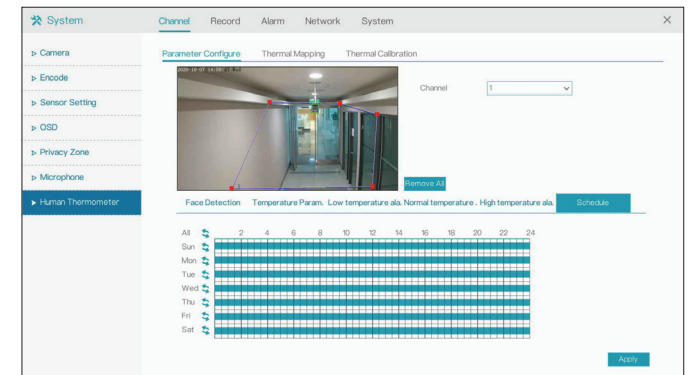
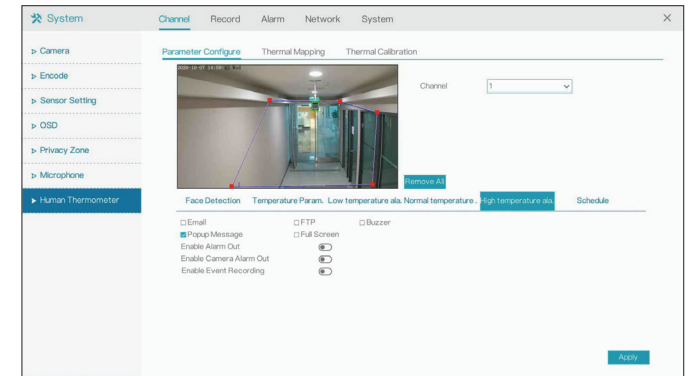

Record Record Schedule

On this page, you can set the recording schedule for the NVR.

Channel Specify the channel to set a recording schedule for.

Enable Record Toggle this to enable or disable recording for the specified channel.

Toggle this to record audio for the specified channel.

Record Audio Click the bars on the right side of the screen to determine the recording type for the channel in question. The types are:

- Continuous
- Camera Alarm In
- Motion Detection
- NVR Alarm In

Channel	Name	Status	Video Format	Resolution	Bitrate(kbps)
CH1	Channel01	Online	H265/H265	1920*1080/704*480	4000/3024
CH1	Channel02	Online	H265/H265	1920*1080/480*640	6096/3024

Disk

On this page you can view and configure the settings for the installed hard drive(s).

Format Click this to format the specified disk. This will delete all of the data on the disk. Make sure to back up your data before formatting.

Disk Status Displays the status of the hard drive.

Disk SN The hard drive serial number.

Used Space The amount of space currently used on the selected hard drive.

Disk Group The disk group that the specified hard drive belongs to.

Recording Overwrite Toggle this to allow new data to overwrite old data on the specified hard drive.

Expired Time (Day) Set the length of time (in days) after which old records will be automatically overwritten.

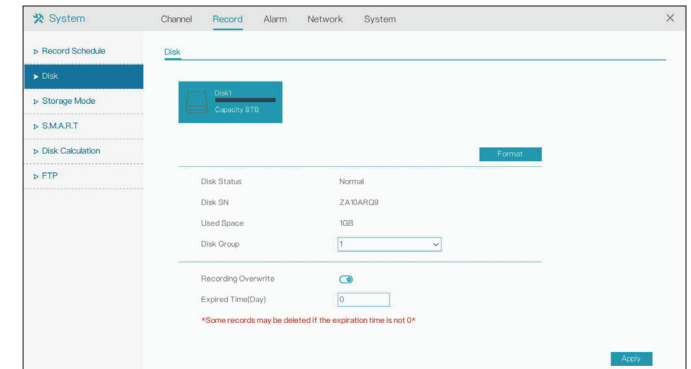

Storage Mode

Use this page to configure the recording storage settings for hard drives and disk groups.

Mode Selection Select a storage mode.

Disk Group Select a disk group to configure.

Channel Select a channel to assign to the selected disk group.

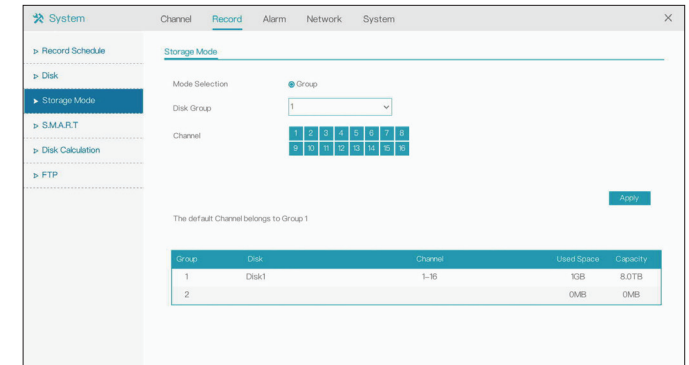

S.M.A.R.T.

This page allows you to view the inserted hard disks' attributes and ensure that they are operating smoothly.

Disk Specify a disk to check.

Disk SN Displays the serial number of the specified disk.

Temperature Displays the specified disk's current operating temperature.

Disk Health Displays the health (i.e. the operational condition) of the disk.

Disk Model The disk model number.

Working Time Indicates the specified disk's lifespan.

In the box at the bottom of the page, you can view various attributes for the specified disk, such as the power cycle count. If no serious issues are detected, the attribute will display Good in the Status column.

ID	Attribute Name	Status	Value	Worst	Threshold	Type	Raw Value
1	raw-read-error-rate	OK	80	64	44	prefail	0x004201000000
3	spin-up-time	OK	84	84	0	prefail	0x000000000000
4	start-stop-count	OK	100	100	20	old-age	0x150100000000
5	reallocated-sector-c	OK	100	100	10	prefail	0x000000000000
7	seek-error-rate	OK	85	60	45	prefail	0x40e0210000
9	power-on-hours	OK	92	92	0	old-age	0x0810000e9e8
10	spin-retry-count	OK	100	100	97	prefail	0x000000000000
12	power-cycle-count	OK	100	100	20	old-age	0x180000000000

Disk Calculation

On this page you can calculate the disk space required for the NVR's current configuration. Enter an amount of data to determine how long it will take for the current setup to fill it, or a period of time to determine how much data will be filled at the current rate of recording.

Total camera bitrate The total bitrate of the cameras connected to the NVR in kb / second.

Calculation mode Choose whether to display the computing capacity or the computation time.

Expect to save time / Disk Capacity Select an amount of time or an amount of storage, depending on whether Computation time or Computing Capacity was selected above.

Recording time per day Enter the number of hours that NVR will record data (per day).

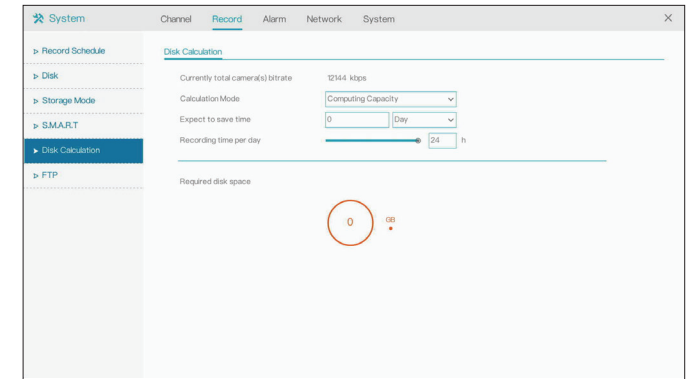

FTP

On this page you can set the NVR to automatically upload its recordings to an external server via FTP.

FTP Upload Check this to begin uploading saved recordings via FTP.

FTP Address Enter the IP address of the FTP server.

FTP Port Enter the port to use to connect to the FTP server.

Account Enter the username of the account used to connect.

Password Enter the password associated with the username entered above.

FTP Path Enter the path to the directory where you would like to save your files.

File Size (0-64 MB) Enter the desired file size of each recording. A smaller size means more frequent uploads.

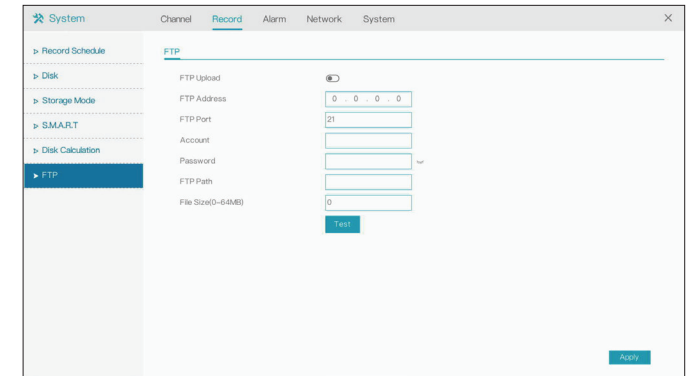

The screenshot shows the 'System' configuration window with the 'Record' tab selected. The 'FTP' section is expanded in the left sidebar. The main area displays the following settings:

- FTP Upload:
- FTP Address:
- FTP Port:
- Account:
- Password:
- FTP Path:
- File Size(0-64MB):

A 'Test' button is located below the File Size field, and an 'Apply' button is in the bottom right corner.

Alarm General

On this page you can configure general alarm settings for your NVR.

Enable Alarm In this tab you can enable and configure the NVR's general alarm.

Duration Time Enter the duration that the alarm should activate for.

Buzzer duration time Enter the duration that the alarm buzzer should sound for.

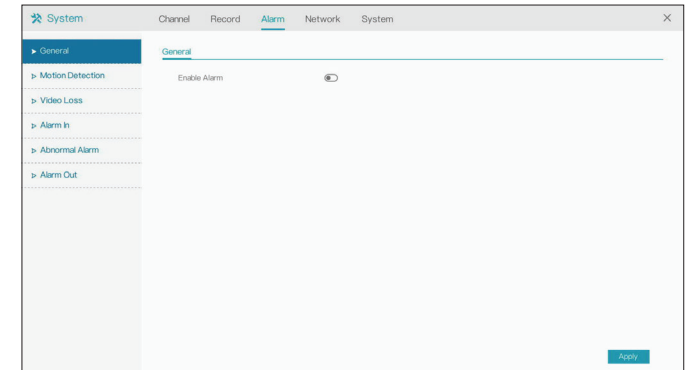

Motion Detection

Configure an alarm to trigger when the camera detects motion.

Channel Select the channel to configure.

Enable Toggle this to cause motion detection to trigger an alarm.

Motion Analysis Toggle this to enable or disable motion analysis.

Event Actions Select the event(s) the alarm should trigger from the following list:

- Email: Send an email notification
- Buzzer: Trigger a buzzer sound
- Popup Message: Display a notification in a popup window
- Full Screen: Display a full-screen notification on the attached monitor

Enable Alarm Out / Camera Alarm Out Trigger a notification on the Alarm Out interface(s).

Enable Event Recording Toggle to keep a record of alarm events.

Detection Area Select the area of the display to scan for motion.

Detection Schedule Enable or disable the alarm according to a particular schedule.

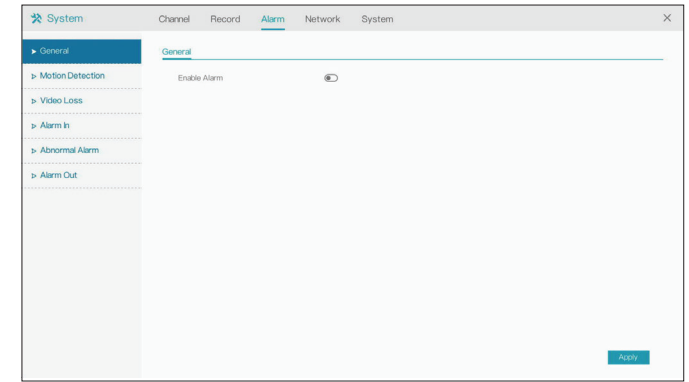

Video Loss

On this page you can enable an alarm to trigger when video loss occurs.

- Channel** Select the channel to configure.
- Enable Video Loss** Toggle this to cause video loss to trigger an alarm.
- Event Actions** Select the event(s) the alarm should trigger from the following list:
- Email: Send an email notification
 - Buzzer: Trigger a buzzer sound
 - Popup Message: Display a notification in a popup window
- Enable Alarm Out** Trigger a notification on the Alarm Out interface(s).
- Enable Event Recording** Toggle to keep a record of alarm events.
- Detection Schedule** Enable or disable the alarm according to a particular schedule.

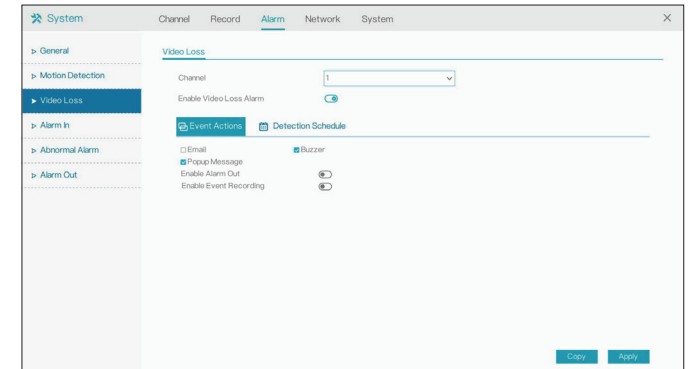

Alarm In

Use this page to enable an alarm when a signal from an external device connected to the NVR's Alarm In interface is detected.

- Alarm In** Select the channel to configure.
- Enable Alarm In** Toggle this to enable or disable Alarm In events and alarms.
- Event Actions** Select the event(s) the alarm should trigger from the following list:
- Email: Send an email notification
 - Buzzer: Trigger a buzzer sound
 - Popup Message: Display a notification in a popup window
- Enable Alarm Out** Trigger a notification on the Alarm Out interface(s).
- Enable Event Recording** Toggle to keep a record of alarm events.
- Detection Schedule** Enable or disable the alarm according to a particular schedule.
- Normal State** Specify the normal state of the sensor. A change from this state will trigger the alarm.
- Port Name** Designate a name for the sensor.
- Camera Alarm In** Click this tab to configure similar settings for sensors connected to a camera's Alarm In interface.

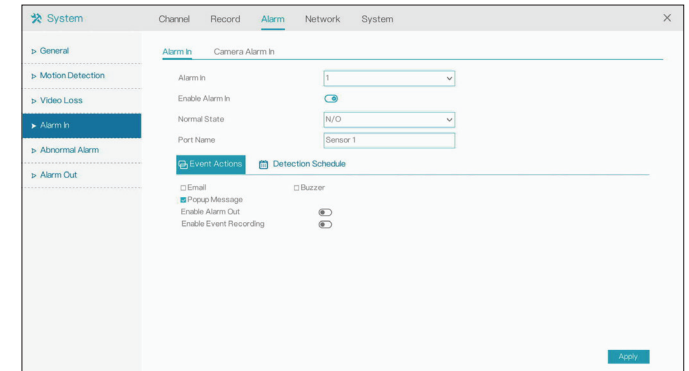

Abnormal Alarm

On this page you can enable or disable an alarm to trigger when an unusual event occurs, such as a hard drive failure or loss of connectivity.

Enable Abnormal Alarm

Enable or disable an abnormal alarm.

Alarm Type

From left to right: trigger an alarm when the NVR fails to detect a hard drive, when it detects an IP conflict, or when it loses its network connection.

Event Actions

Select the event(s) the alarm should trigger from the following list:

- Email: Send an email notification
- Buzzer: Trigger a buzzer sound
- Popup Message: Display a notification in a popup window

Enable Alarm Out

Trigger a notification on the Alarm Out interface(s).

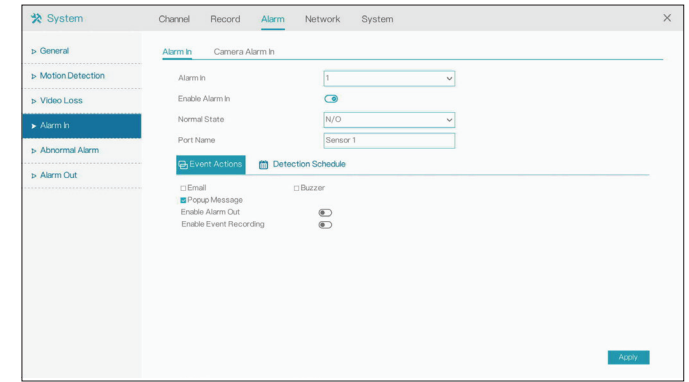

Alarm Out

On this page you can configure the NVR's interactions with external devices connected to its Alarm Out interface.

- Port Number** Select the alarm out interface (either 1 or 2).

- Port Name** Designate a name for the alarm out connection.

- Action After Receiving Trigger** Select either **Close** or **Open**.

- Alarm Output Mode** Select the alarm out put mode (**Switch Mode** by default).

- Camera Alarm Out** Configure similar settings for devices connected to a camera's alarm out interface.

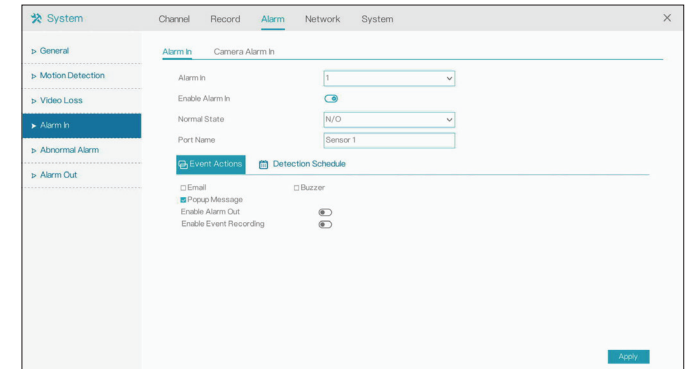

Network Network

IP Address

This page lets you configure the NVR's connection to the Internet or local network.

Enable DHCP Client Select this connection if you have a DHCP server running on your network and would like a dynamic IP address to be automatically updated to your NVR.

You may obtain a static or fixed IP address and other network information from your network administrator. A static IP address will simplify access to your NVR in the future.

IP Address Enter the fixed IP address of the NVR. This is used to access the web interface. If the NVR does not receive its address from a DHCP server, then its default IP address is will be **192.168.0.20**.

Subnet Mask Set this to match the subnet mask of the provided IP address. The default value is 255.255.255.0.

Default Gateway Set this to the default gateway on your router or local subnet for proper network routing.

Obtain DNS Automatically Toggle this to enable DNS automatically.

Preferred DNS Server Primary domain name server that translates names to IP addresses.

Alternate DNS Server Secondary domain name server to back up the primary domain name server

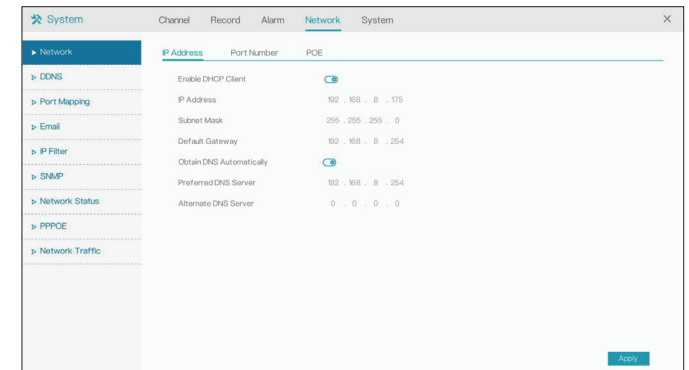

Port Number

On this page you can set the ports that the NVR will use to transfer data and allow clients to connect to.

- HTTP Port** The HTTP port for the web UI.
- Data Port** The port that data will be transferred over. The port that client devices will connect to.
- Client Port** It is necessary to reboot the device after modifying any of the port configuration settings.

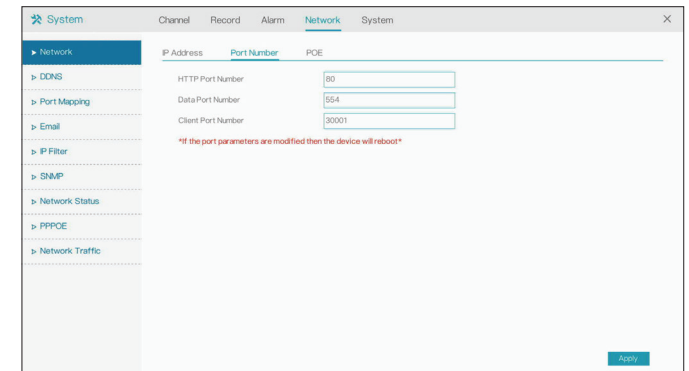

PoE

On this page you can configure the settings for the NVR's PoE interfaces.

Auto Manage For PoE Camera Toggle this to automatically manage PoE settings for PoE-capable cameras.

IP Address Enter the fixed IP address of the NVR. The default IP address is **10.10.10.121**.

Subnet Mask Set this to match the subnet mask of the provided IP address. The default value is 255.255.255.0.

Default Gateway Set this to the default gateway on your router or local subnet for proper network routing. The default gateway is **10.10.10.1**.

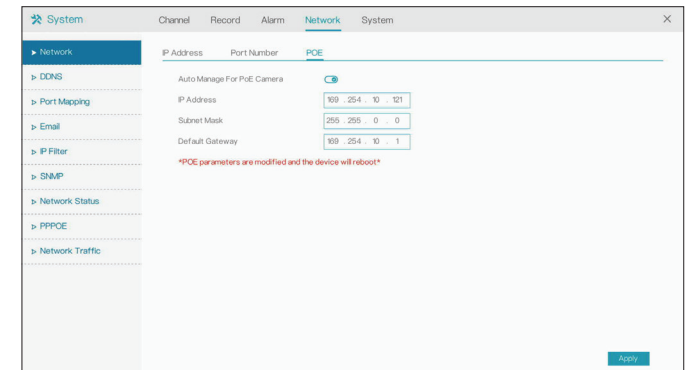

DDNS

Enable this option only if you have registered a domain name with a dynamic DNS service provider. The following parameters are displayed when the option is enabled.

Enable Select a dynamic DNS service provider from the pull-down list.

Protocol Select the DDNS protocol to use.

Domain Name Enter your host name. For example: myhost.mydomain.net.

Username Enter the username for your dynamic DNS account.

Password Enter the password for your dynamic DNS account. Confirm it in the next text box.

Test Click this to test the DDNS settings.

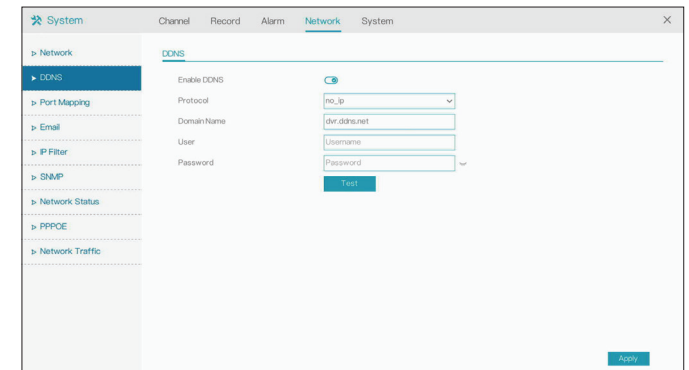

The screenshot shows a web browser window titled "System" with a navigation menu at the top containing "Channel", "Record", "Alarm", "Network", and "System". The "Network" tab is active, and the "DDNS" sub-tab is selected. On the left, a sidebar menu lists various network settings: "Network", "DDNS", "Port Mapping", "Email", "IP Filter", "SNMP", "Network Status", "PPPOE", and "Network Traffic". The main content area is titled "DDNS" and contains the following configuration options:

- Enable DDNS:** A radio button that is currently selected.
- Protocol:** A dropdown menu with "no_ip" selected.
- Domain Name:** A text input field containing "dnt.ddns.net".
- User:** A text input field containing "Username".
- Password:** A text input field containing "Password".

Below the password field is a "Test" button. At the bottom right of the configuration area is an "Apply" button.

Port Mapping

On this page you can enable or disable the port mapping feature.

Port Mapping Toggle this to enable or disable port mapping. If you enable this, you will also have to select a mode (Manual or Auto) and HTTP, client and data ports.

NAT Port In this tab you can enter a start and end port for the NAT port range.

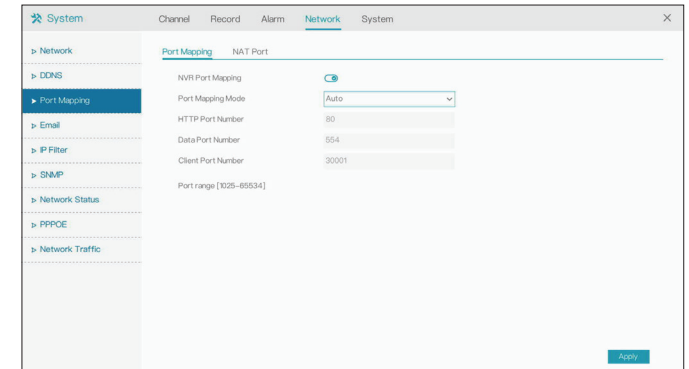

Email

On this page you can configure the DNR-4020-16P's email settings, such as the email addresses that alerts and notifications should be sent to.

SMTP Server Enter the SMTP server to use, such as **smtp.gmail.com**.

SMTP Server Port Enter the port to connect to the SMTP server on. The default is 25.

Username Enter the username for the SMTP server.

Password Enter the corresponding password.

Email Sender Enter the address to send alert emails from.

Alarm Receiver 1-3 Enter the emails that should receive the NVR's alerts.

SSL Encryption Enter the form of encryption to use, or select OFF.

Sending interval Enter an interval between 0 and 600 seconds.

Test Click this to send a test email.

IP Filter

On this page you can block or allow visitors from specified IPs from accessing the NVR. Click the plus (+) sign to add a range of IPs to the list, and then click Apply to save.

IP Filter Toggle this to enable IP filtering.

Rule Type Select Black List to block all IPs from the ranges you specify, or White List to only allow IPs from the ranges you specify.

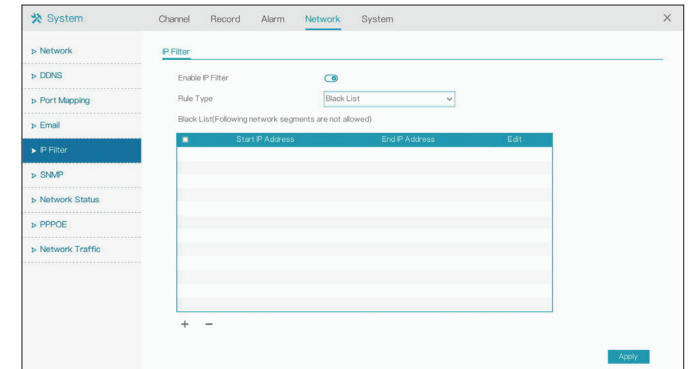

SNMP

If you have SNMP agents that you would like to send traps (such as alarms and syslog messages) to your NVR, you can enable and configure your SNMP settings on this page.

**SNMPV1/
SNMPV2C** Enable and enter a password for the Read/Write and Read-Only community strings here. Change the community string to keep intruders from getting information about the network setup.

SNMPV3 This SNMP version adds encryption and authentication to the service for better security. You can specify separate Read/Write versus Read-only name and passwords as well as the type of encryption to use.

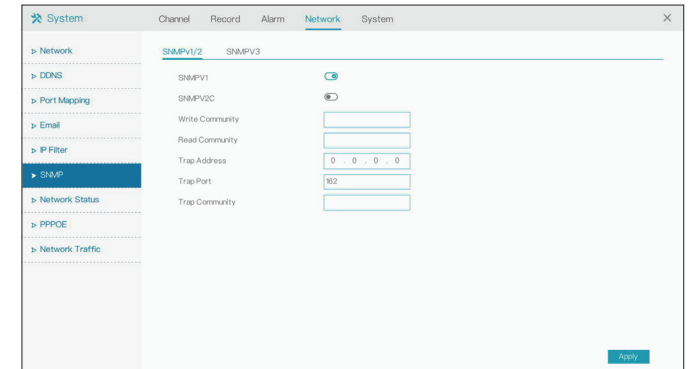

Network Status

On this page you can view the status of the NVR's LAN and PoE ports and check your Internet connection.

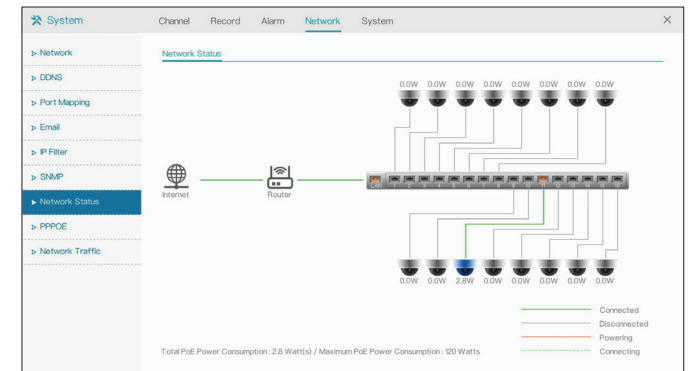

PPPoE

On this page you can enable, disable or configure PPPoE settings on your NVR.

Enable Enable this setting if your ISP is using PPPoE.

Username Enter the username provided by your ISP.

Password IP Enter the password provided by your ISP.

Address Enter the fixed address of the NVR and the port that is used to access the web interface.

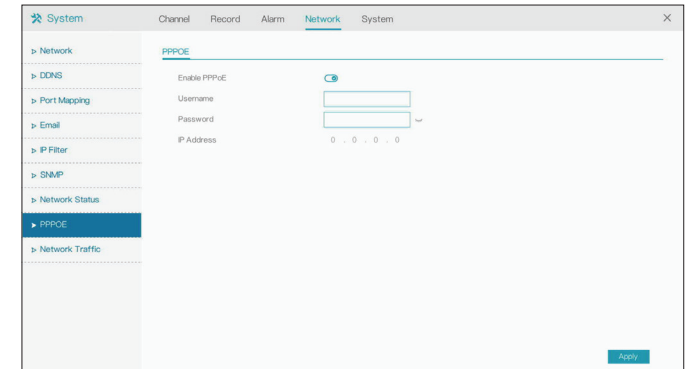

Network Traffic

This page displays the traffic being sent and received on the NVR's various network interfaces, and information (such as MAC addresses).



System Information

System

This page displays information about the NVR.

Device ID A unique ID used to identify the device.

Device Name The name used to identify the device.

Device Type Indicates the type of device (NVR).

Model The device's model number.

Firmware Version The device's current firmware version.

U-boot Version The device's current U-boot version.

Kernel Version The device's current kernel version.

HDD Number The number of HDD supported by the device.

Channels Supported The number of channels supported by the device.

Alarm In The number of Alarm In interfaces.

Alarm Out The number of Alarm Out interfaces.

Audio In The number of Audio In interfaces.

Audio Out The number of Audio Out interfaces

Category	Item	Value
General	Device ID	B01003AEFY56155
	Device Name	Device
User Account	Device Type	NVR
Security Center	Model No.	DNR-4020-16P
	Firmware Version	v1.00.11
Auto Sequence	U-boot Version	1404B090C21
Auxiliary Screen	Kernel Version	1406020E1D16
Logs	HDD Number	2
	Channels Supported	16
Maintenance	Alarm In	8
	Alarm Out	2
Auto Reboot	Audio In	1
	Audio Out	1

Network

Displays network status for the NVR.

Status Indicates whether the device is online or offline.

IP Address Displays the device's IP address.

Subnet Mask Displays the device's subnet mask.

Default Gateway Displays the default gateway IP address.

MAC Address Displays the device's unique MAC address.

DHCP Displays the DHCP status of the device (on/off).

Preferred DNS Server Displays the IP address of the preferred DNS server.

Alternate DNS Server Displays the IP address of the backup DNS server, if applicable.

LAN Speed Displays the speed on the device's LAN interface.

Received Packet Displays the total size of the received packets per second in Mb

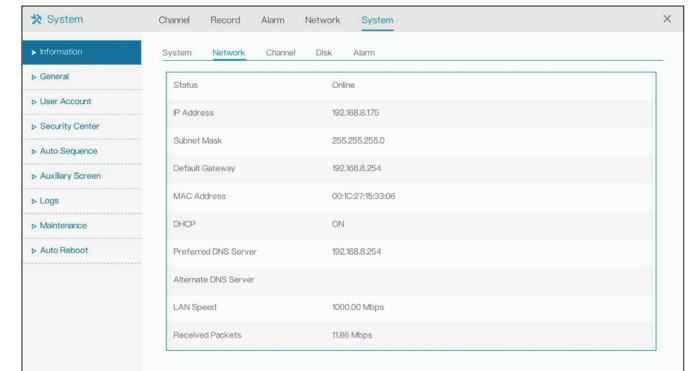

Channel

This page displays the name, online status, video format, resolution and bitrate of all of the DNR-4020-16P's channels

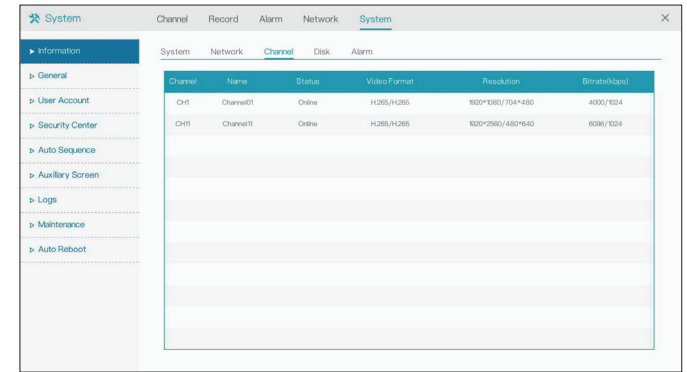

Channel	Name	Status	Video Format	Resolution	Bitrate(Kbps)
CH1	Channel01	Online	H265/H265	1000*1080/704*480	4000/1024
CH2	Channel02	Online	H265/H265	1000*2560/480*640	6096/1024

Disk

On this page you can view information on the inserted hard drives, including their total capacity, the amount of space currently being used, and their operational status.

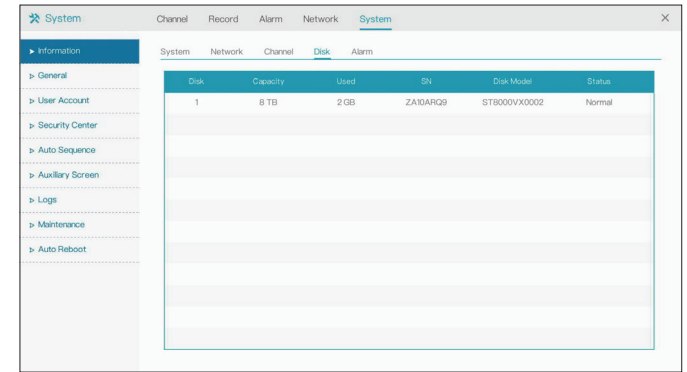

The screenshot shows a web interface for system configuration. The 'System' tab is active, and the 'Disk' sub-tab is selected. A table displays the following information:

Disk	Capacity	Used	SN	Disk Model	Status
1	8 TB	2 GB	ZA10ARQ9	ST8000VX0002	Normal

Alarm

On this page you can view information on the sensors and other devices connected to the DNR-4020-16P on its Alarm In and Alarm Out interfaces.

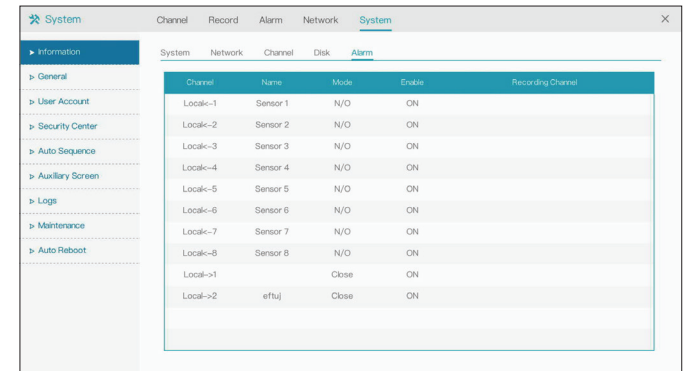

The screenshot shows the 'System' configuration page with the 'Alarm' tab selected. The left sidebar contains a navigation menu with the following items: Information, General, User Account, Security Center, Auto Sequence, Auxiliary Screen, Logs, Maintenance, and Auto Reboot. The main content area displays a table of sensors.

Channel	Name	Mode	Enable	Recording Channel
Local-1	Sensor 1	N/O	ON	
Local-2	Sensor 2	N/O	ON	
Local-3	Sensor 3	N/O	ON	
Local-4	Sensor 4	N/O	ON	
Local-5	Sensor 5	N/O	ON	
Local-6	Sensor 6	N/O	ON	
Local-7	Sensor 7	N/O	ON	
Local-8	Sensor 8	N/O	ON	
Local-1		Close	ON	
Local-2	effuj	Close	ON	

General

System

Allows you to change general configuration settings (e.g. by setting the device name and language).

Device Name Enter the a new name to identify the NVR to other devices.

Display Port Resolution Enter the desired resolution for the NVR's configuration interface.

Language Select your preferred language.

Temperature Units Select either Celsius or Fahrenheit.

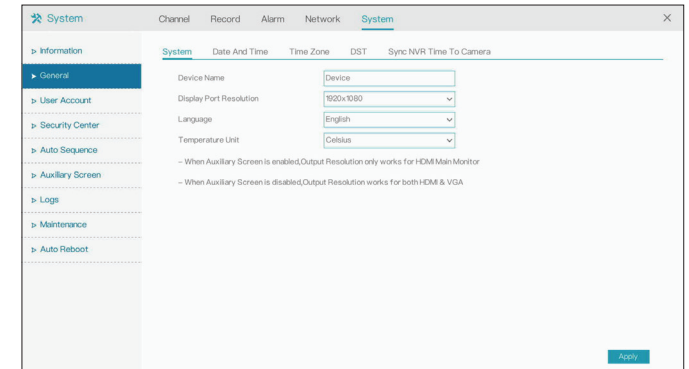

Date and Time

On this page you can change the device's date and time manually, or specify NTP settings to acquire the date and time automatically.

Date Format Specify the desired format that the device should use to display the date.

Time Format Specify the desired format that the device should use to display the system time.

NTP Sync Toggle this to automatically obtain the date and time from an NTP server.

NTP Server Specify the NTP server to use.

Frequency of Checks Specify how frequently (in seconds) to verify the system time with the NTP server.

Date If NTP Sync is disabled, automatically enter the date.

Time If NTP Sync is disabled, automatically enter the current time.

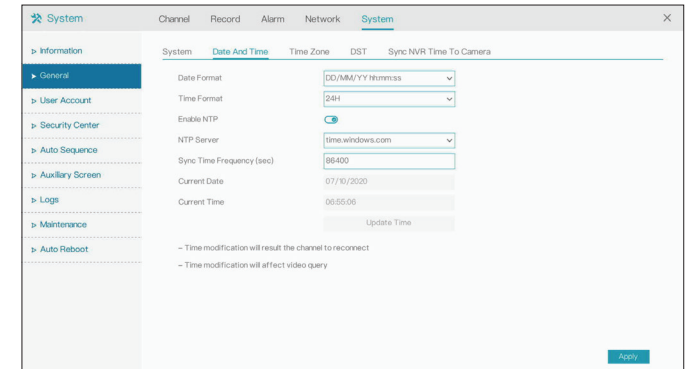

Time Zone

On this page, you can select your current time zone and apply it to the NVR's time settings.

Time Zone Select your current time zone from the drop-down menu.

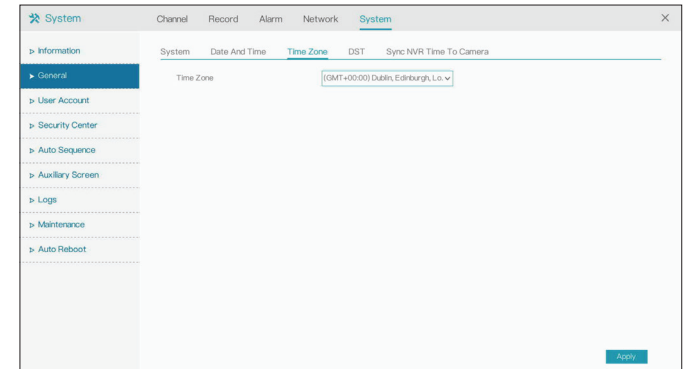

Daylight Saving Time

On this page you can enable or disable Daylight Saving Time.

Daylight Savings Time Toggle this to enable or disable Daylight Saving Time.

Start Time The date and time that DST should start.

End Time The date and time that DST should end.

Offset Time The number of hours to adjust the clock during DST

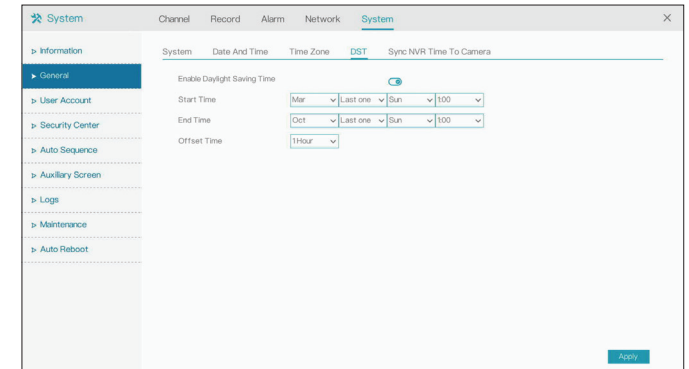

Sync NVR Time To Camera

On this page you can configure the cameras connected to the DNR-4020-16P to automatically sync their time settings with the NVR's.

Sync Camera Time Toggle this to enable time syncing with the connected cameras.

Frequency of Checks Enter how often (in seconds) the NVR should sync its time settings with its cameras' time settings.

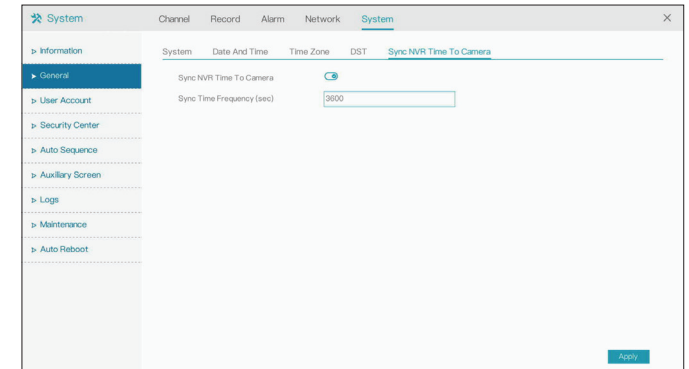

User Account

User

On this page you can create or change the account information for the NVR's user accounts (for example, by updating the password). Click the pencil icon under the Operate tab to edit an existing user account, or click Add to create a new one.

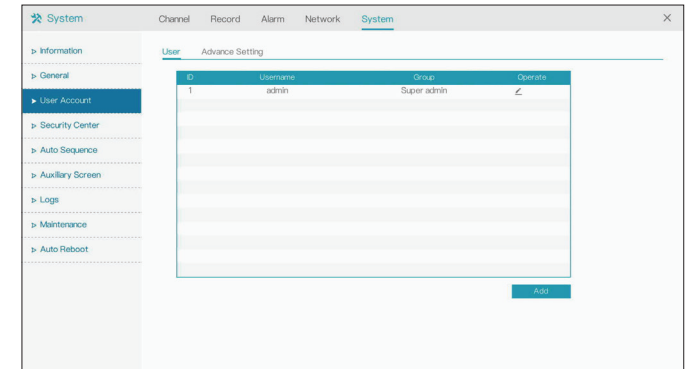

Advance Setting

On this tab you can configure advanced settings for the NVR's user accounts.

Password double auth. Toggle this to enable double password authentication.

Boot Wizard Toggle this to set the boot wizard to load automatically when the device is booted up.

Auto Login Toggle this to set the device to log in automatically.

Logout time Set the number of minutes of inactivity after which the device should log out automatically.

Monitor channel(s) when logout Select the channels to continue to monitor after logging out from the device.

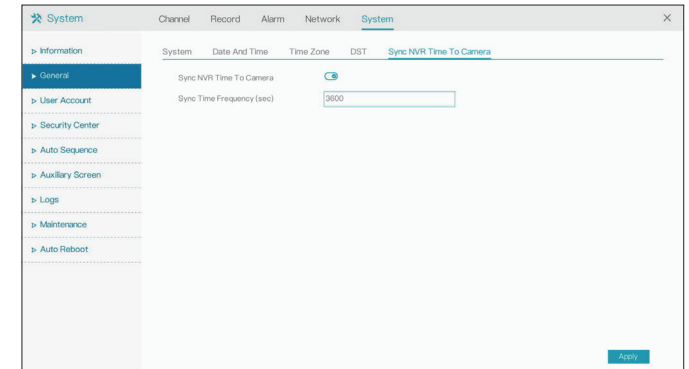

Security Center

On this page you can update the password settings for the NVR.

Old Password Enter the current password.

New Password Enter the desired new password.

Confirm Password Confirm the new password by reentering it.

Unlock Pattern Use this tab to set a pattern to unlock your NVR instead of a typed password.

Secure Email Use this tab to set a recovery email to use in case you forget your password

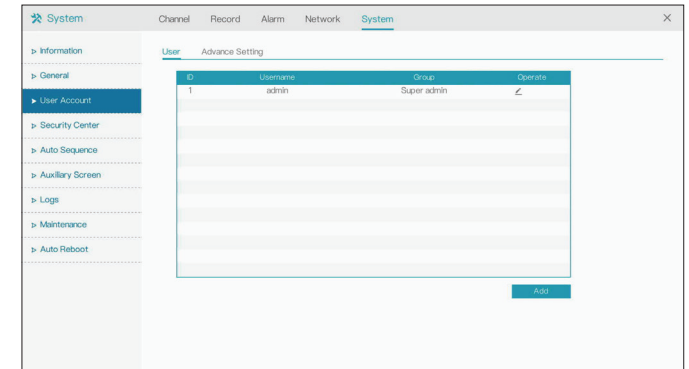

Auto Sequence

On this page you can configure auto sequencing of the NVR's various channels. Select the number of channels to display on the screen at any given time, and the length of time that they will be displayed there. Use the arrows at the bottom of the screen to cycle through the channels.

Dwell Time Select the period of time (in seconds) to wait before displaying the next screen of channels.

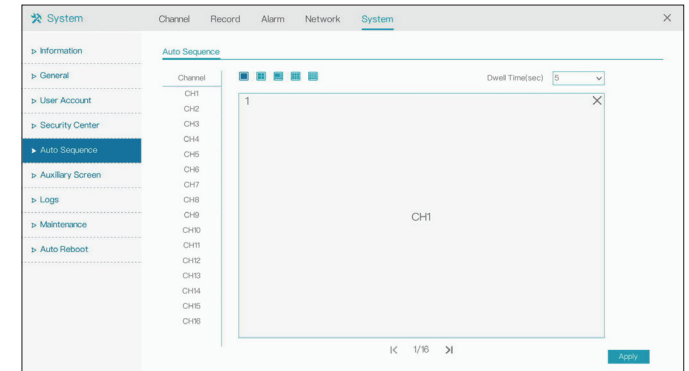

Auxiliary Sequence

On this screen you can enable, disable, or configure the auxiliary screen for your device.

Enable Auxiliary Screen

Toggle this to enable an auxiliary display. If this is enabled, you will also need to configure the auxiliary display's output resolution, decoding ability, and layout.

VGA Output Resolution

Select the display resolution to use.

Maximum Channel for HDMI and VGA

Configure how many channels will display on the HDMI and VGA screens respectively.

Layout Mode

Configure how many channels will display at one time on each screen.

Default Display Channel

Select the channel to display by default.

Enable Auto Sequence

Toggle this to enable or disable auto sequencing on the auxiliary screen. If enabled, you may configure the auto sequence settings in the Auto Sequence tab.

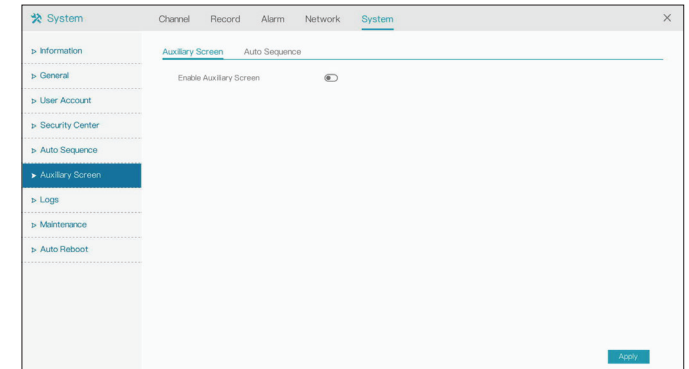

Logs

System Log

On this page you can view the NVR's operational and system logs and search the log for specific events.

Start Date Enter the starting date to search the logs from.

End Date Enter the end date to search the logs until.

Type Enter the type of logs to search or export.

Start Time Enter the starting time to search the logs from.

End Time Enter the end time to search the logs until.

Search Click this to search for logs.

Export Click this to export the logs to a file.

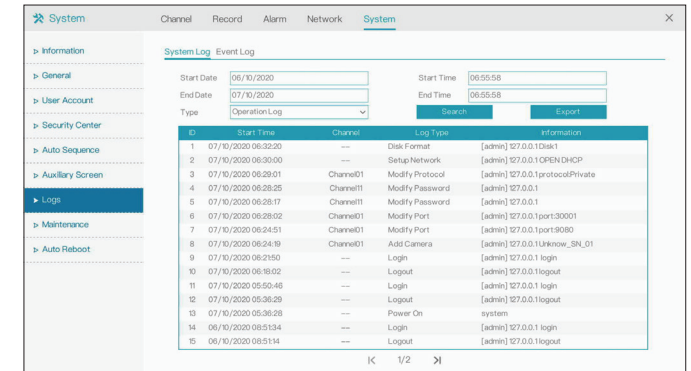

The screenshot shows the 'System Log' interface with the following data:

ID	Start Time	Channel	Log Type	Information
1	07/10/2020 08:32:20	---	Disk Format	[admin] 127.0.0.1 Disk1
2	07/10/2020 08:30:00	---	Setup Network	[admin] 127.0.0.1 OPEN DHCP
3	07/10/2020 08:29:01	Channel01	Modify Protocol	[admin] 127.0.0.1 protocolPrivate
4	07/10/2020 08:28:25	Channel01	Modify Password	[admin] 127.0.0.1
5	07/10/2020 08:28:17	Channel01	Modify Password	[admin] 127.0.0.1
6	07/10/2020 08:28:02	Channel01	Modify Port	[admin] 127.0.0.1 port:30001
7	07/10/2020 08:24:51	Channel01	Modify Port	[admin] 127.0.0.1 port:9090
8	07/10/2020 08:24:19	Channel01	Add Camera	[admin] 127.0.0.1 Unknown_SH_01
9	07/10/2020 08:2150	---	Login	[admin] 127.0.0.1 login
10	07/10/2020 08:18:02	---	Logout	[admin] 127.0.0.1 logout
11	07/10/2020 05:50:46	---	Login	[admin] 127.0.0.1 login
12	07/10/2020 05:36:29	---	Logout	[admin] 127.0.0.1 logout
13	07/10/2020 05:36:26	---	Power On	system
14	06/10/2020 08:51:34	---	Login	[admin] 127.0.0.1 login
15	06/10/2020 08:51:14	---	Logout	[admin] 127.0.0.1 logout

Event Log

On this page you can view the logs of events (such as triggered alarms).

Start Date Enter the starting date to search the logs from.

End Date Enter the end date to search the logs until.

Type Enter the type of logs to search or export.

Start Time Enter the starting time to search the logs from.

End Time Enter the end time to search the logs until.

Search Click this to search for logs.

Export Click this to export the logs to a file.

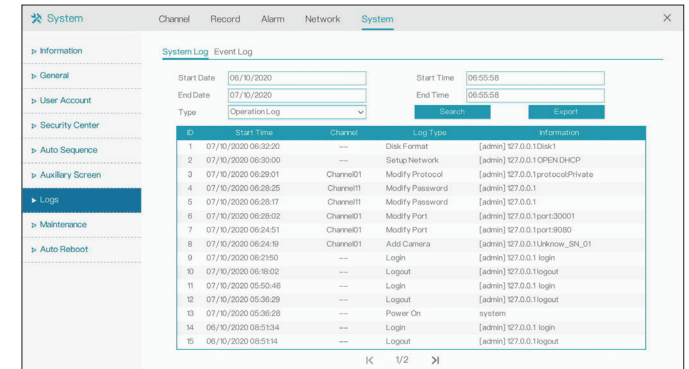

The screenshot shows the 'System' configuration page with the 'Event Log' tab selected. The interface includes search filters for Start Date (06/10/2020), End Date (07/10/2020), Start Time (06:55:58), and End Time (06:55:58). A dropdown menu is set to 'OperationLog'. There are 'Search' and 'Export' buttons. Below the filters is a table of event logs:

ID	Start Time	Channel	Log Type	Information
1	07/10/2020 08:32:20	---	Disk Format	[admin] 127.0.0.1Disk1
2	07/10/2020 08:30:00	---	Setup Network	[admin] 127.0.0.1 OPEN DHCP
3	07/10/2020 08:29:01	Channel01	Modify Protocol	[admin] 127.0.0.1 protocolPrivate
4	07/10/2020 08:28:25	Channel01	Modify Password	[admin] 127.0.0.1
5	07/10/2020 08:28:17	Channel01	Modify Password	[admin] 127.0.0.1
6	07/10/2020 08:28:02	Channel01	Modify Port	[admin] 127.0.0.1port:30001
7	07/10/2020 08:24:51	Channel01	Modify Port	[admin] 127.0.0.1port:9090
8	07/10/2020 08:24:19	Channel01	Add Camera	[admin] 127.0.0.1Unknown_SH_01
9	07/10/2020 08:2150	---	Login	[admin] 127.0.0.1 login
10	07/10/2020 08:18:02	---	Logout	[admin] 127.0.0.1logout
11	07/10/2020 05:50:48	---	Login	[admin] 127.0.0.1 login
12	07/10/2020 05:38:29	---	Logout	[admin] 127.0.0.1logout
13	07/10/2020 05:38:28	---	Power On	system
14	06/10/2020 08:5134	---	Login	[admin] 127.0.0.1 login
15	06/10/2020 08:5114	---	Logout	[admin] 127.0.0.1logout

Maintenance

Maintenance

On this page you can perform miscellaneous maintenance tasks. Select the relevant icon to perform the task.

Shutdown Click this icon to shut down the NVR.

Reboot Click to reboot the NVR.

Logout Log out from the user interface.

Reset Reset the device to factory settings.

Import Config. Import configuration settings from a file.

Export Config. Export current configuration settings to a file.

FW Update Update the device's firmware. This requires a firmware file on an inserted USB storage device.

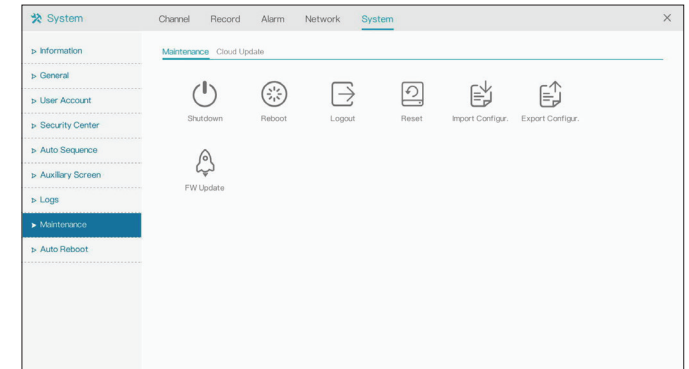

Cloud Update

Current Version current firmware version number.

Latest Version It shows the latest firmware version number after checking FOTA server.

Auto Check latest Version Enable or disable to auto check the latest firmware version with FOTA server.

Auto Update Enable or disable to auto update device firmware.
Setting hour, minute and the day for auto firmware update.

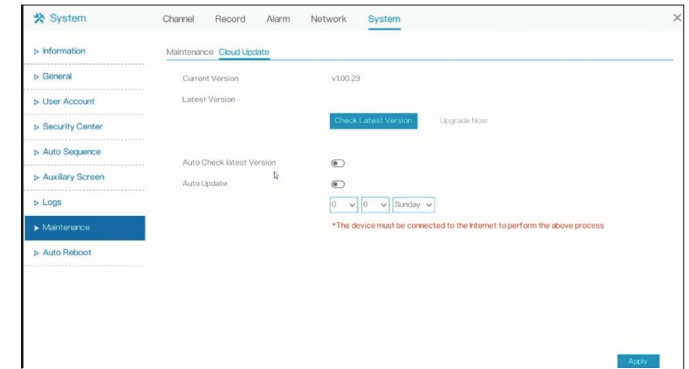

Auto Reboot

Toggle this to enable the device's automatic restart feature.

Enable Auto Reboot Toggle this to enable the automatic restart feature.



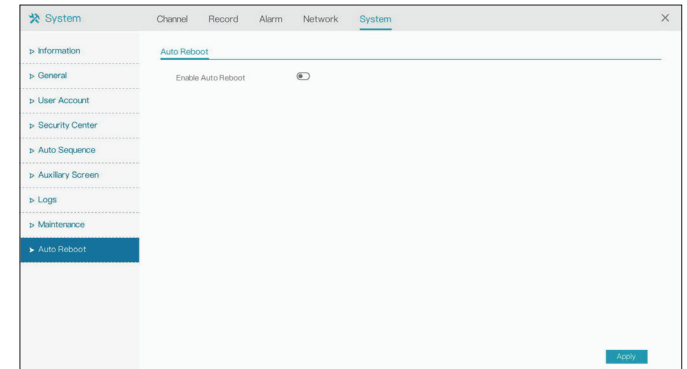











Reboot Time Set the frequency at which the device should restart (i.e. per day, week, or month) and the time that it should do so.



Playback

Time Search

On this page you can view the NVR's recorded footage. In the sidebar, select the channel(s) that you want to view. Use the calendar to navigate to the date and time that you want to view footage from. Use the buttons on the left to control the playback. From left to right, the buttons are:

-  **Split Screen:** Determine how many channels to view
-  **Reversed:** Play the recording backwards
-  **Play:** Play the recording
-  **Stop:** Pause the recording
-  **Next Frame:** Advance by one frame (if paused)
-  **30S Backwards/Forwards:** Jump forward or back by 30 seconds
-  **Triple Speed (Backwards):** Play backwards in 3x speed
-  **1x:** Return to normal speed
-  **Triple Speed (Forwards):** Play forwards in 3x speed
-  **Zoom:** Zoom in on the display
-  **Audio:** Adjust the volume
-  **Start Backup:** Begin a backup of the current recording
-  **Batch Backup:** Create a backup of a batch of recordings (configured in a popup)
-  **Snapshot:** Take a still snapshot of the current playback

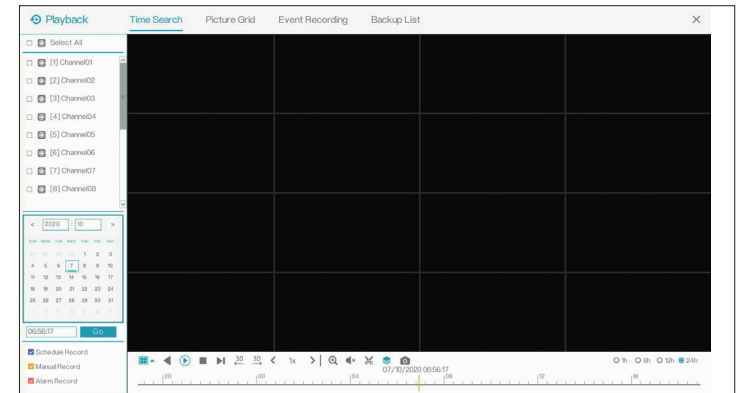

Picture Grid

This page allows you to easily view recordings for a specified channel (selected in the sidebar) according to the time they were recorded. Frames are separated on the grid at two-hour intervals. Click a frame to view the playback for that time. Use the calendar in the left sidebar or the slider on the bottom of the screen to navigate to a different date.

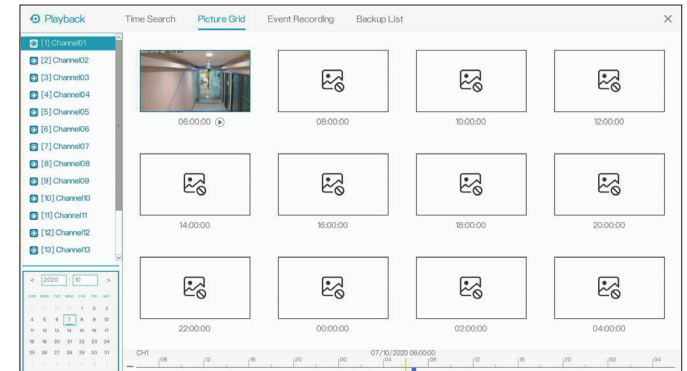

Event Recording

This page displays recordings that triggered an event of some type, such as motion detection or an alarm. Select the channel and navigate to the date and time that you want to view events for using the sidebar. Check the boxes in the bottom left corner of the screen to search for a particular type of event.

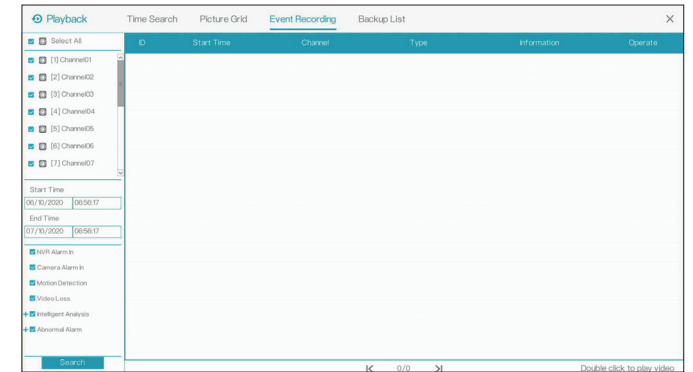

Backup List

On this page you can view recordings that you have saved using the **Backup** (scissors) icon in the playback screen. Backups must be saved on an inserted USB storage device.

ID An ID number that identifies the backup.

Channel The channel that the backup was saved from.

Start Time The start time of the recording.

End Time The ending time of the recording.

Size The size (in MB) of the backup file.

Stream Displays whether the backup came from the main or sub stream.

Path The path to the backup file on the USB drive.

Progress Indicates whether the backup is in progress or has finished.

Operate Click the trash can to delete the backup.

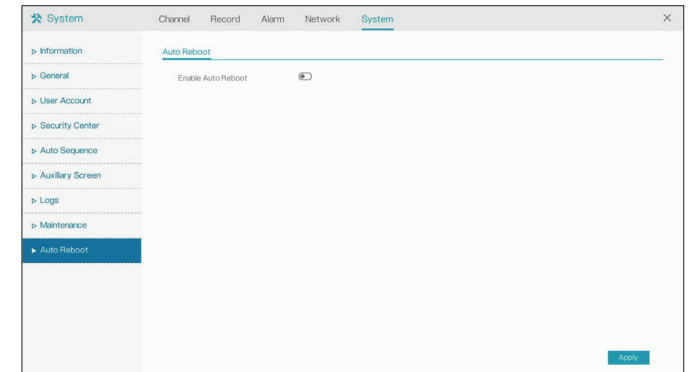

Setting Up Your DNR-4020-16P (Web GUI)

You can connect PoE network cameras directly to your DNR-4020-16P using the 16 PoE ports on the rear panel. For non-PoE network cameras, you will need to locate power outlets in the on-site environment then run a CAT5E UTP cable to the LAN ports on the NVR.

You can set up your NVR via the web UI. To do this, connect an Ethernet cable to the LAN port on the rear panel of the device. Connect the other end of the cable to an Ethernet port on your switch, router, or computer.

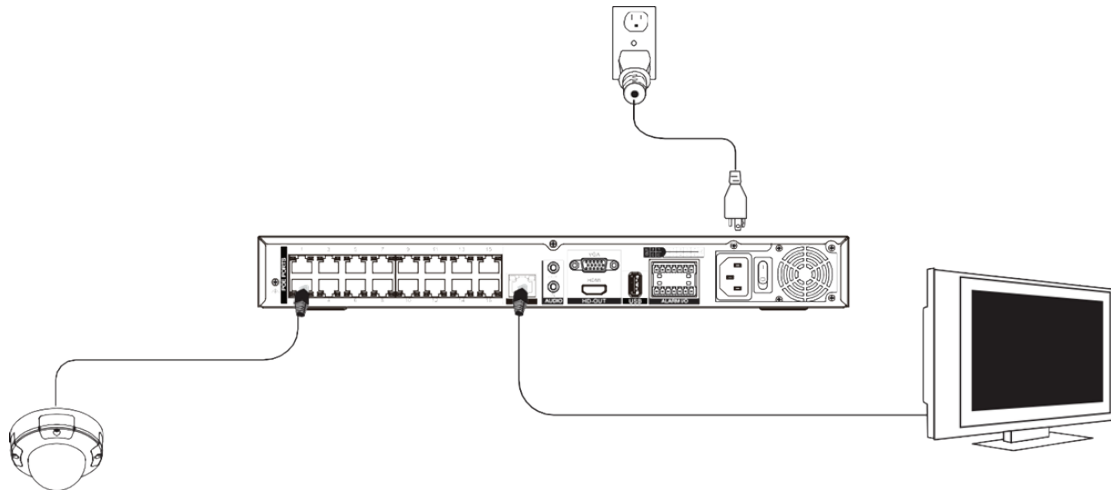

1. Using a web browser, navigate to dlink.com/support/ and select your region.
2. On the next screen, enter the model number of your NVR in the search bar and click Search. Click the picture of your NVR. On the product page, click the Download button next to Setup Wizard.
3. Once the executable file has finished downloading, click it and follow the instructions to install the Setup Wizard.
4. Open the Setup Wizard. It will display the MAC address and IP address of your NVR. If you have a DHCP server on your network, this will be a dynamic IP address. If your network does not use a DHCP server, the NVR's default static IP 192.168.0.20 will be displayed. Select your NVR, then click the **Link** button to continue.
5. Log into the web user interface using the same username and password used to access the HDMI / VGA interface. If this is your first time using the device, you will be prompted to create a username and password. Click **Save**.
6. To view the NVR display and configure the NVR, on the main screen of the Setup Wizard, click the Search button, then select your NVR and click the **Link** button to open the Web UI.

Alternatively, open a web browser and type the NVR's IP address into the URL bar and press Enter.

Or enter **<http://DNR-4020-16P-xxxx.local>** in the address bar of your web browser (xxxx is the last four alphanumeric characters of the MAC ID on the device label).

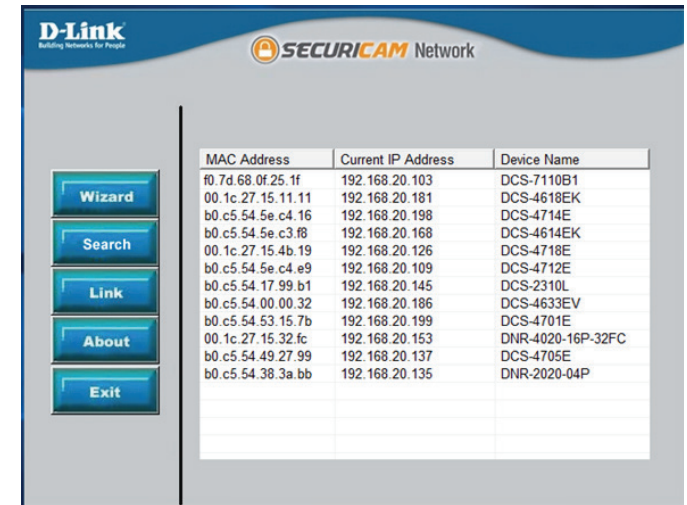

MAC Address	Current IP Address	Device Name
0.7d.68.0f.25.1f	192.168.20.103	DCS-7110B1
00.1c.27.15.11.11	192.168.20.181	DCS-4618EK
b0.c5.54.5e.c4.16	192.168.20.198	DCS-4714E
b0.c5.54.5e.c3.f8	192.168.20.168	DCS-4614EK
00.1c.27.15.4b.19	192.168.20.126	DCS-4718E
b0.c5.54.5e.c4.e9	192.168.20.109	DCS-4712E
b0.c5.54.17.99.b1	192.168.20.145	DCS-2310L
b0.c5.54.00.00.32	192.168.20.186	DCS-4633EV
b0.c5.54.53.15.7b	192.168.20.199	DCS-4701E
00.1c.27.15.32.fc	192.168.20.153	DNR-4020-16P-32FC
b0.c5.54.49.27.99	192.168.20.137	DCS-4705E
b0.c5.54.38.3a.bb	192.168.20.135	DNR-2020-04P

Initial Configuration

If you are logging into the DNR-4020-16P for the first time, you will be prompted to create a password for the admin account. Enter the password in both fields to confirm it. You will also be prompted to enter the default password to use to access cameras connected to the NVR. This password can also be set manually from the web UI for each camera.



Live View / Home Screen

On this screen you can view the DNR-4020-16P's channels and access its various configuration options. Select the channels you would like to view in the side bar on the left. Use the icons on the bar at the top to navigate to different screens, and the right sidebar for channel configuration options.

Navigation

From left to right, on the top sidebar:

- **Live View:** View the home screen
- **Playback:** View the playback screen
- **Alarm Search:** Search records of alarm events
- **Settings:** Configure the NVR's settings
- **Event List:** Display a list of recent events in the sidebar
- **Download:** Download a backup of saved recordings
- **Logout:** Sign off from the web UI
- **Help:** Display the help menu

On the bottom sidebar, click the buttons to determine how many channels should be displayed at one time.

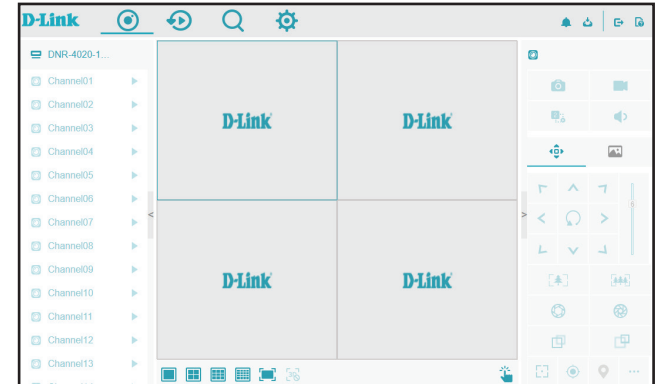

Channel Configuration

You can configure the channel's display using the buttons on the right sidebar.

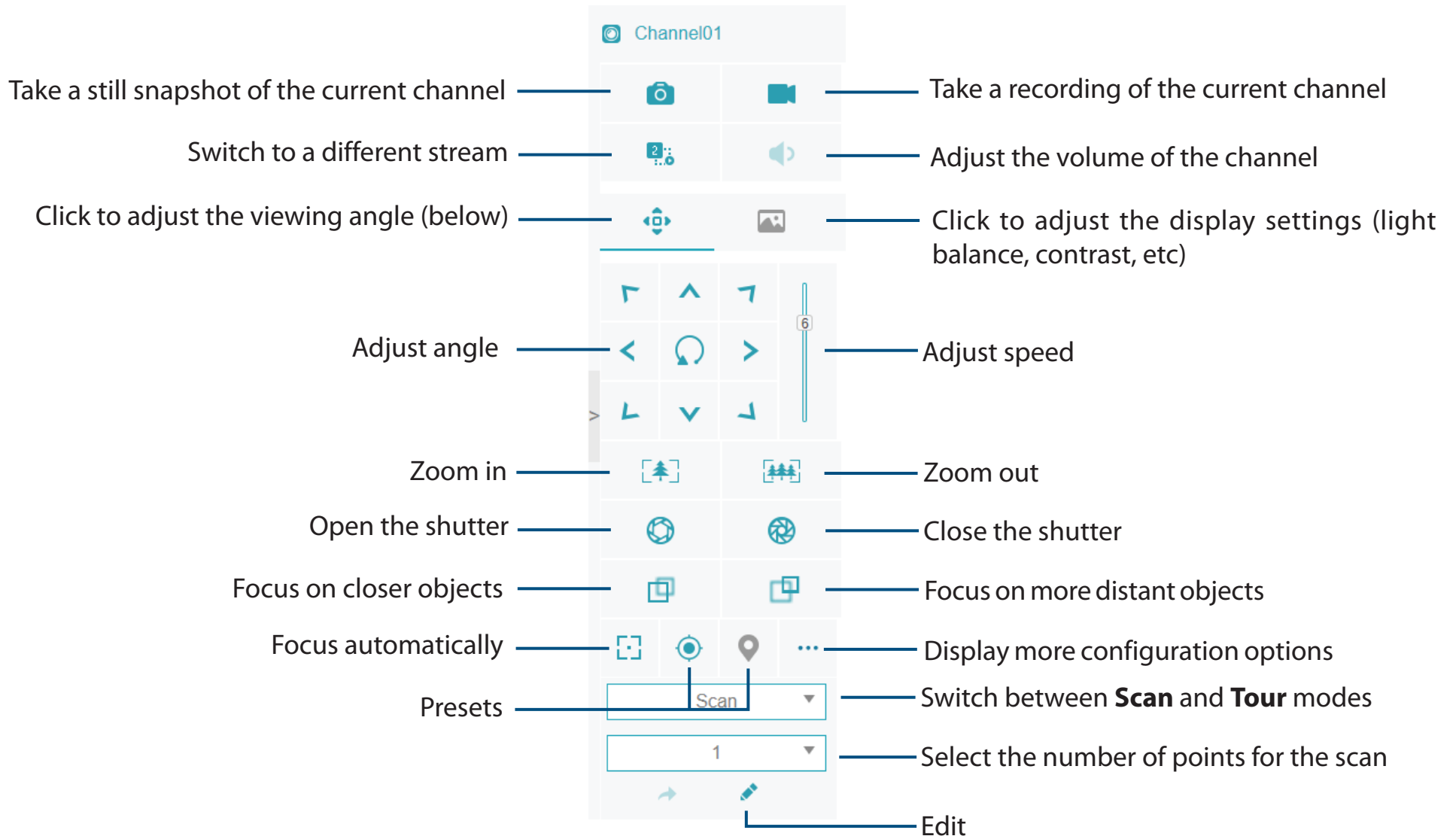

Playback

On this page you can view the NVR's recorded footage. In the sidebar, select the channel(s) that you want to view. Use the calendar to navigate to the date and time that you want to view footage from. Use the buttons on the bottom to control the playback. From left to right, the buttons are:

- **Reversed:** Play the recording backwards
- **Stop/Play:** Play the recording
- **Triple Speed (Backwards):** Play backwards in 3x speed
- **Triple Speed (Forwards):** Play forwards in 3x speed
- **Async:** Set the different channels to play synchronously or asynchronously
- **Split Screen 1/2:** Determine how many channels to view
- **Backup:** Begin a backup of the current recording
- **Batch Backup:** Create a backup of a batch of recordings (configured in a popup)

Use the buttons on the right sidebar to take snapshots, recordings, or control the stream. From left to right, the buttons are:

- **Snapshot:** Take a snapshot of the specified channel
- **Recording:** Take a recording of the specified channel
- **Stream switch:** Switch to a different stream

To choose what date and time to play the recording of, use the calendar in the bottom left sidebar to select your desired date. Enter a time of day in the field and click **Go**. Recorded footage will be indicated by a blue bar on the bottom of the screen. You can click the bar at the desired time to view the recording.

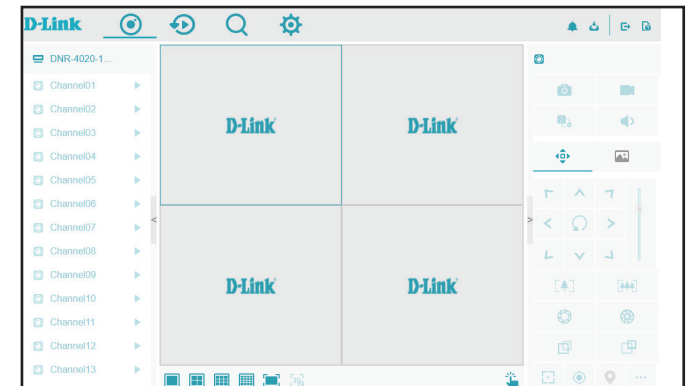

Alarm Search

On this page you can search the NVR's alarm records for specific alarm types. Click the icon in the top right to select the channel(s), the type of alarm (e.g. video loss or motion detection) and dates/times to search. Click the tabs to view **Channel Alarms** or **System Alarms**.

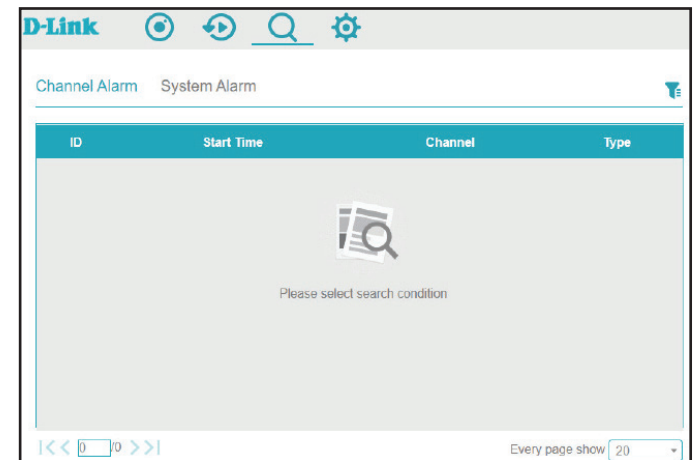

System Channel Camera

On this page, you can configure the DNR-4020-16P's 16 channels and add cameras to them. To search for available cameras, click Start Search. To add cameras to a channel, enter the username and password in the fields at the bottom of the screen and click Add.

- Channel** The channel the specified camera is on.
- IP** The camera's IP address.
- Model** The camera's model number.
- Protocol** The protocol used to communicate with the camera.
- Firmware Version** The firmware the specified camera is running.
- Operate** Click this to set or update the camera's settings.

E (Explorer) Click the blue **E** icon to open a browser to view the camera in the web GUI.

Click the ... icon to reboot or reset the IP camera (for cameras operating via private protocol only).

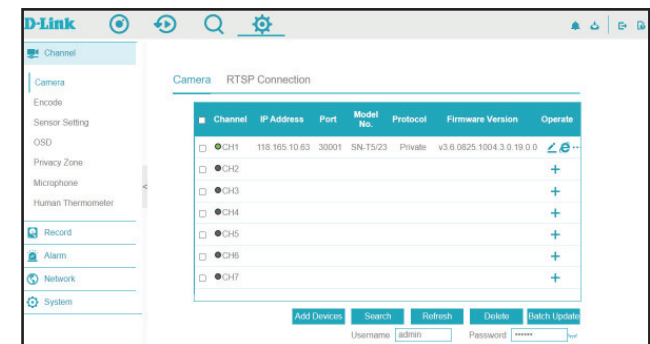

Configuring a Channel

Click the pencil icon under **Operate** to add a camera on a channel or to configure an existing channel.

Channel Name Enter a name to identify the channel.

IP Address Enter the IP address of the camera. If the camera is connected to one of the NVR's PoE ports, it will attempt to detect the IP address automatically.

Protocol Select the protocol to use (e.g. ONVIF).

Port Enter the port used to connect to the camera.

Username: Enter the username used to access the camera.

Password: Enter the password associated with the username above.

Remote Channel Designate a channel for the camera's display.

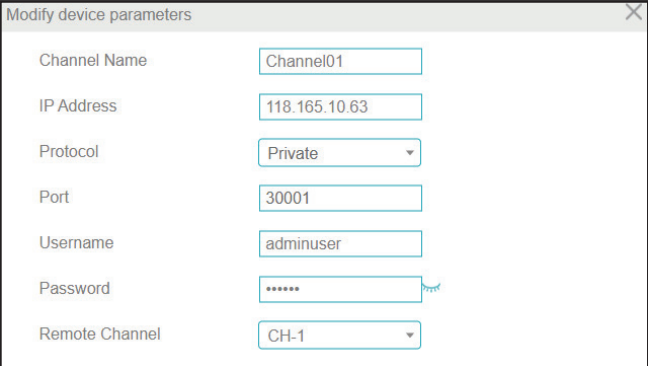

The screenshot shows a dialog box titled "Modify device parameters" with a close button (X) in the top right corner. The dialog contains the following fields:

Channel Name	<input type="text" value="Channel01"/>
IP Address	<input type="text" value="118.165.10.63"/>
Protocol	<input type="text" value="Private"/>
Port	<input type="text" value="30001"/>
Username	<input type="text" value="adminuser"/>
Password	<input type="password" value="*****"/>
Remote Channel	<input type="text" value="CH-1"/>

RTSP Connection

Use this page to configure your Real Time Streaming Protocol (RTSP) connection settings.

Custom Protocol Designate the custom protocol to use (select 1-16 from the drop-down menu).

Protocol Name Specify a protocol name to use.

Stream Type Select Main Stream or Sub Stream. If you select Sub Stream, the options on the right will be enabled.

Protocol Type Select the protocol type to use for the stream. This is set to RTSP by default.

Port Select the RTSP port to use. This is set to 554 by default.

Abs Path Enter the absolute path for the RTSP connection to use.

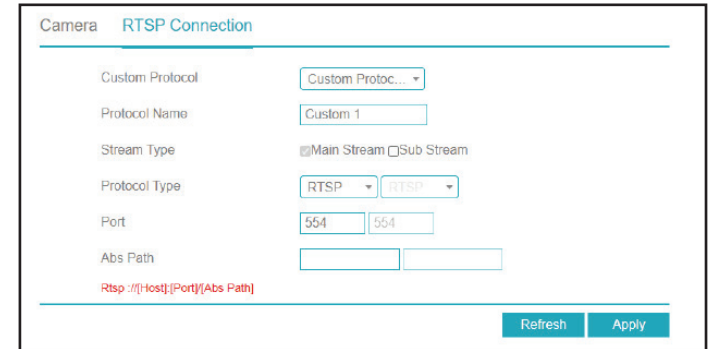

The screenshot shows a web interface for configuring an RTSP connection. The page title is "Camera RTSP Connection". The configuration fields are as follows:

- Custom Protocol:** A dropdown menu with "Custom Protoc..." selected.
- Protocol Name:** A text input field containing "Custom 1".
- Stream Type:** Radio buttons for "Main Stream" (selected) and "Sub Stream".
- Protocol Type:** A dropdown menu with "RTSP" selected, and a secondary dropdown menu with "RTSP" selected.
- Port:** Two text input fields, both containing "554".
- Abs Path:** Two empty text input fields.

Below the fields, there is a red text label: `Rtsp://[Host]:[Port]/[Abs Path]`. At the bottom right, there are two buttons: "Refresh" and "Apply".

Encode

On this page, you can change the encoding settings for the video and audio streams on a particular channel.

Channel	Specify the channel to modify.
Stream Information	Indicates which stream the following information pertains to (i.e. Main Stream or Sub Stream).
Video Format	Select the video encoding format to use for the channel (e.g. H.265, H.264, etc).
Audio Encode Type	Select the audio encoding format to use for the channel (e.g. G711A, G711U, etc).
Resolution	The resolution to use for the channel's display.
Frame Rate (fps)	The frame rate at which to display the video.
Bitrate Type	Select the bitrate type (e.g. CBR, VBR, etc)

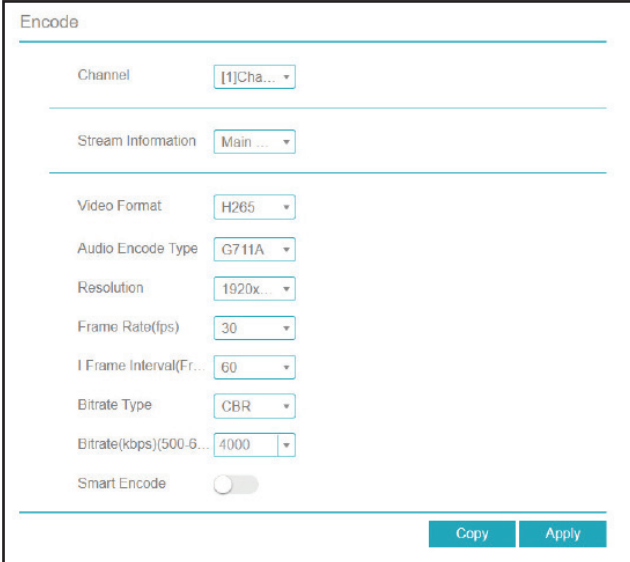

The screenshot shows the 'Encode' configuration page with the following settings:

- Channel: [1]Cha...
- Stream Information: Main ...
- Video Format: H265
- Audio Encode Type: G711A
- Resolution: 1920x...
- Frame Rate(fps): 30
- I Frame Interval(Fr...): 60
- Bitrate Type: CBR
- Bitrate(kbps)(500.6...): 4000
- Smart Encode:

Buttons: Copy, Apply

Bitrate (kbps) The bitrate will affect the bit rate of the video recorded by the camera. Higher bit rates result in higher video quality.

Smart Encode Click to enable or disable smart encoding. If selected, this will configure some of the settings above automatically. Support for IP cameras is only available via private protocol.

Sensor Settings

On the Sensor Settings page you can change aspects of the camera's display and its sensor's configuration settings.

Image

Scene Select the type of scene (Indoor or Outdoor) or select Default. The default settings are determined by the IP camera's video parameters.

Brightness Adjust the image brightness.

Sharpness Adjust the image sharpness.

Contrast Adjust the contrast.

Saturation Adjust the saturation.

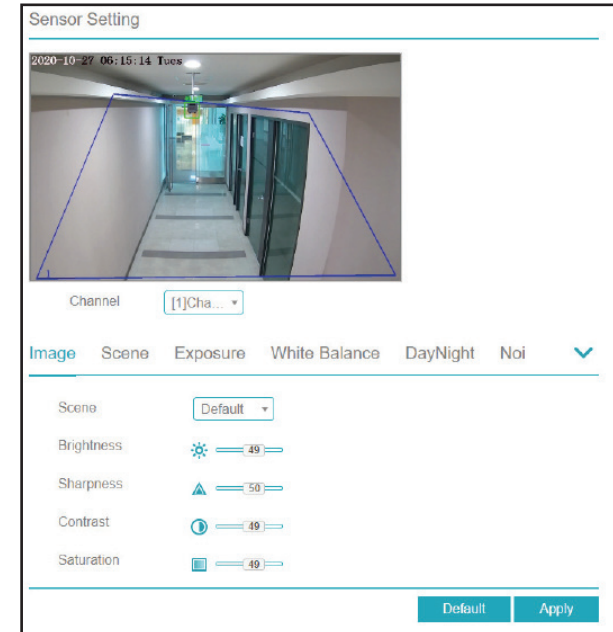

Scene

Scene Select whether the scene is **Indoors** or **Outdoors**.

Mirror From the drop-down, choose whether to display the scene normally or mirror it horizontally, vertically, or both.

The configuration options on this page are only available for cameras being accessed via private protocol.

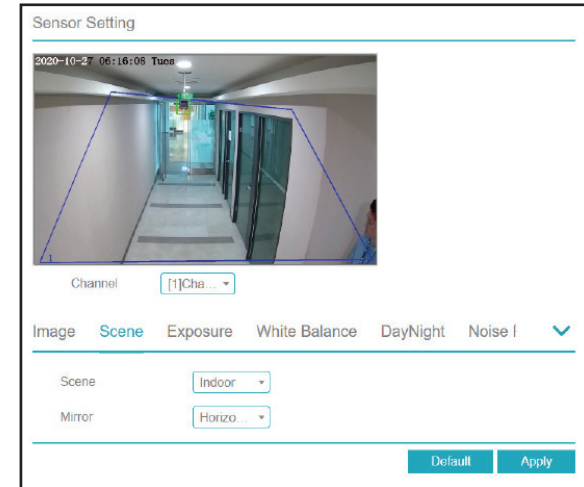

Exposure

Exposure Mode Choose the exposure mode. Select between Auto, Manual, Shutter Priority, and Iris Priority (aperture priority).

Meter Area Select the meter area.

Max Shutter Select the maximum shutter speed.

Max Gain Select the maximum gain.

The configuration options on this page are only available for cameras being accessed via private protocol.

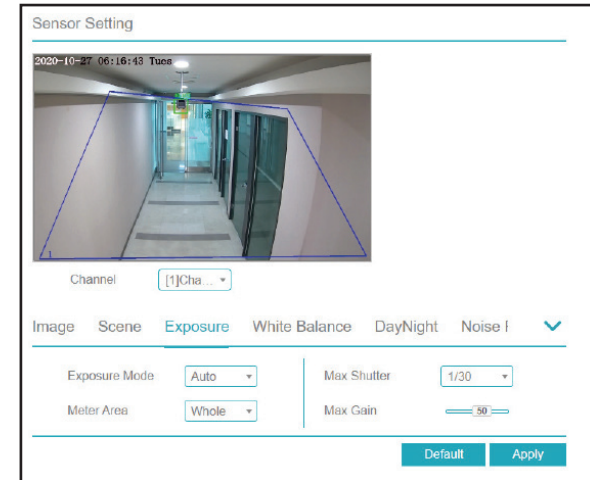

White Balance

Mode Select the mode from a variety of options, including Tungsten, Fluorescent, Daylight, Shadow, etc. If you select Manual, you will need to set the red and blue levels yourself.

The configuration options on this page are only available for cameras being accessed via private protocol.

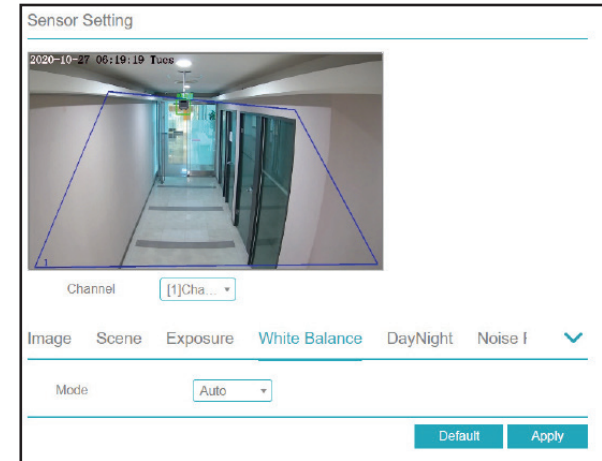

Day/Night

D/N Settings Choose whether to automatically or manually configure the day/night settings. If you select Timing, you will need to designate a day/night schedule in the fields that appear. If you select Auto, you will need to set the transition time between day and night modes, as well as the delay before the transition occurs.

The configuration options on this page are only available for cameras being accessed via private protocol.

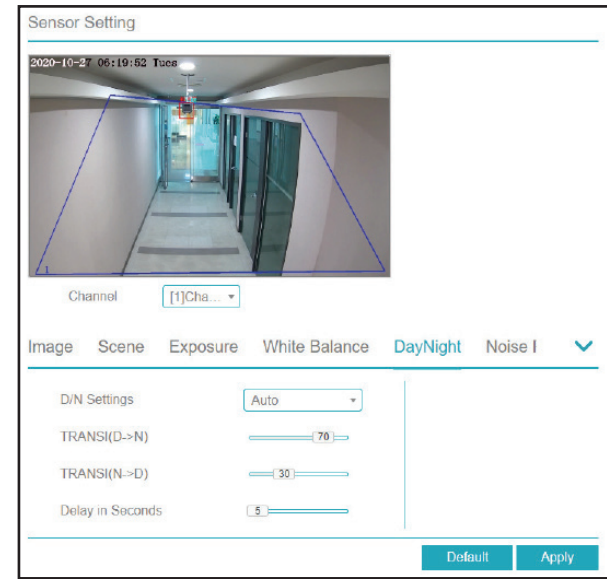

Noise Reduction

2D/3D NR Enable or disable 2D and 3D noise reduction.

Max Strength Select the maximum level of noise reduction to be applied to the image.

The configuration options on this page are only available for cameras being accessed via private protocol.

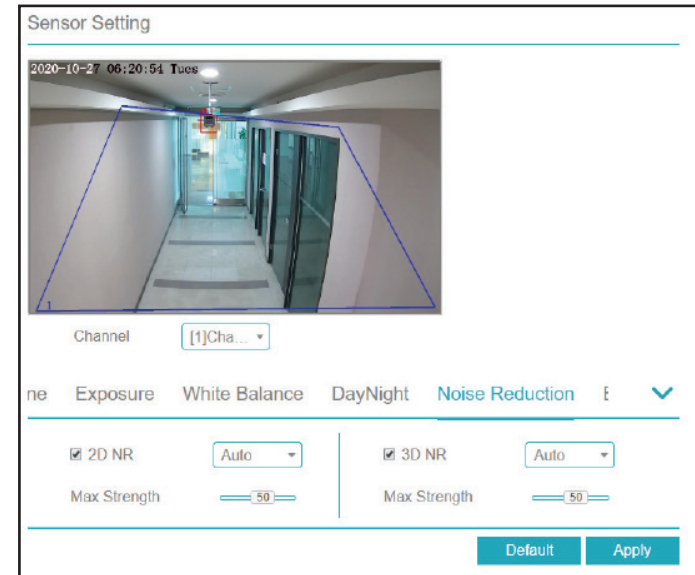

Enhance Image

WDR Enable this to optimize the display quality with wide dynamic range (WDR).

HLC Adjust for overexposure with highlight compensation (HLC).

BLC Adjust the overall lighting of the image with backlight compensation (BLC).

Defog Defog the image.

Anti-shake Enable this to compensate for minor shaking of the camera, making the video smoother.

The configuration options on this page are only available for cameras being accessed via private protocol.

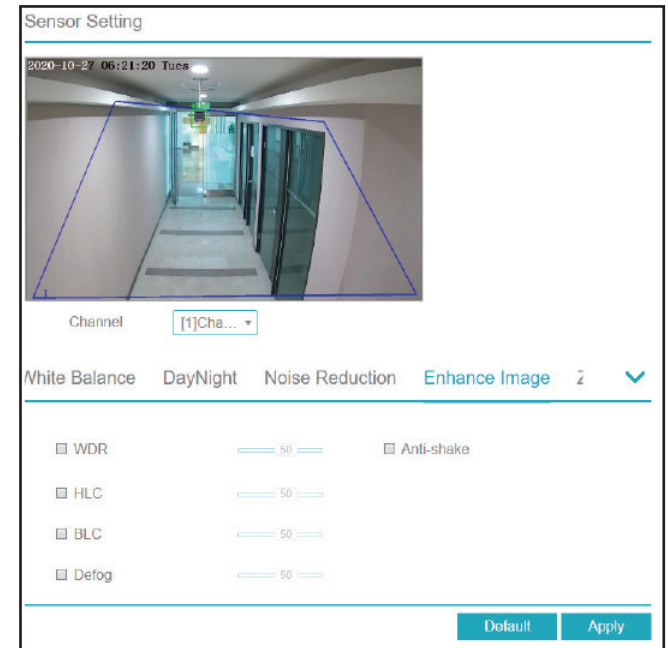

Zoom Focus

D/N Auto Focus Click this to automatically focus according to whether the camera is in day or night mode.

Auto focus once Click this to automatically focus the lens a single time.

Zoom Manually adjust the camera's zoom.

Focus Manually adjust the camera's focus.

Lens initialization Click this to recalibrate the lens's zoom and focus.

The configuration options on this page are only available for cameras being accessed via private protocol.

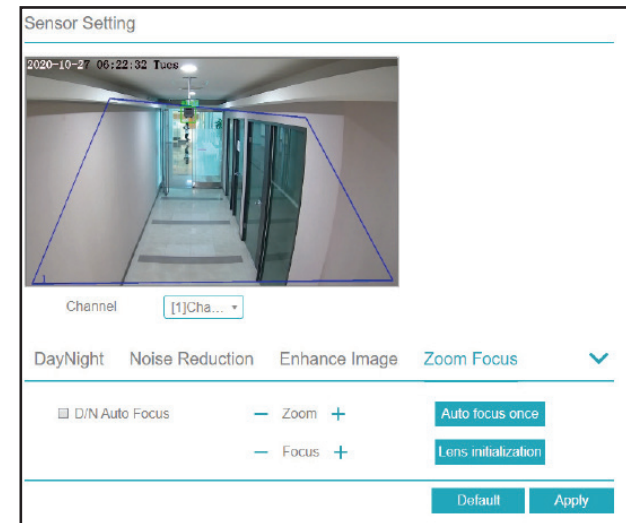

OSD

On this page you can configure the on-screen display (OSD) for the NVR's channels.

Channel Specify a channel.

Time Toggle this to display the current time on the selected channel's OSD.

Channel Name Toggle this to display the selected channel name on the OSD.

The configuration options on this page are only available for cameras being accessed via private protocol.

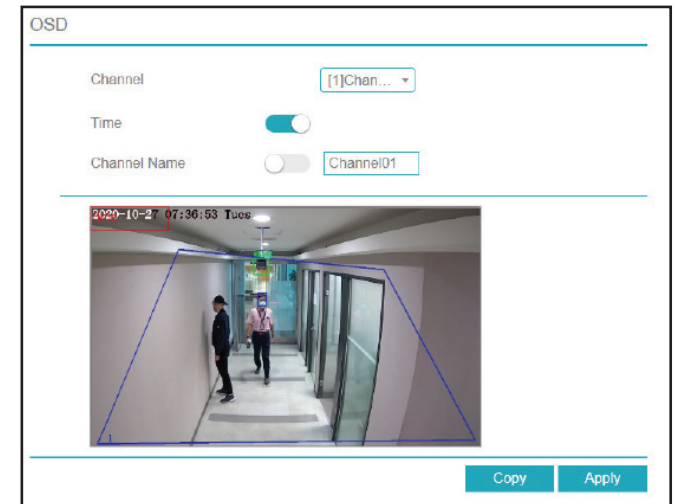

Privacy Zone

Click and drag a section of the screen to create a privacy zone. This area will not be viewable and will not be recorded. Double-click an existing privacy zone to delete it.

Channel Select the channel to add a privacy zone to. The DNR-4020-16P supports up to four zones.



Microphone

Use this page to configure microphone settings for the specified channel. If no device with a microphone is connected, the settings will be locked.

Channel Select the channel to configure the microphone for.

Microphone Toggle this to enable or disable the microphone.

Microphone Type Specify the type of microphone connection (e.g. Line In).

Microphone Volume Adjust the microphone volume/sensitivity.

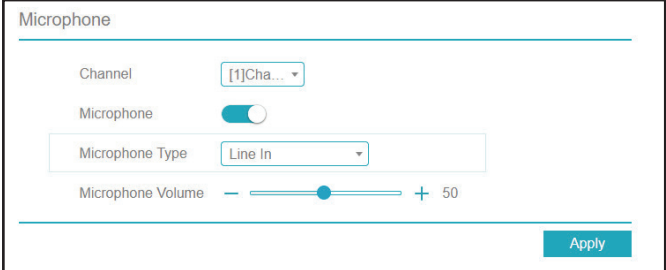

The screenshot shows a configuration panel titled "Microphone". It contains the following elements:

- Channel:** A dropdown menu with the text "[1]Cha..." and a downward arrow.
- Microphone:** A toggle switch that is currently turned on (indicated by a blue circle).
- Microphone Type:** A dropdown menu with the text "Line In" and a downward arrow.
- Microphone Volume:** A slider control with a blue knob in the middle. To the right of the slider is a plus sign followed by the number "50".
- Apply:** A blue button with the text "Apply" located at the bottom right of the panel.

Human Thermometer

On this page you can configure the thermal mapping and calibration settings for thermal cameras on the specified channel.

Parameter Configure Use this tab to configure your thermal camera settings, if any thermal cameras are currently connected to the DNR-4020-16P.

Thermal Mapping Use this tab to set thermal mapping points on the camera's display.

Thermal Calibration Use this tab to calibrate the thermal camera with a separate calibration tool.

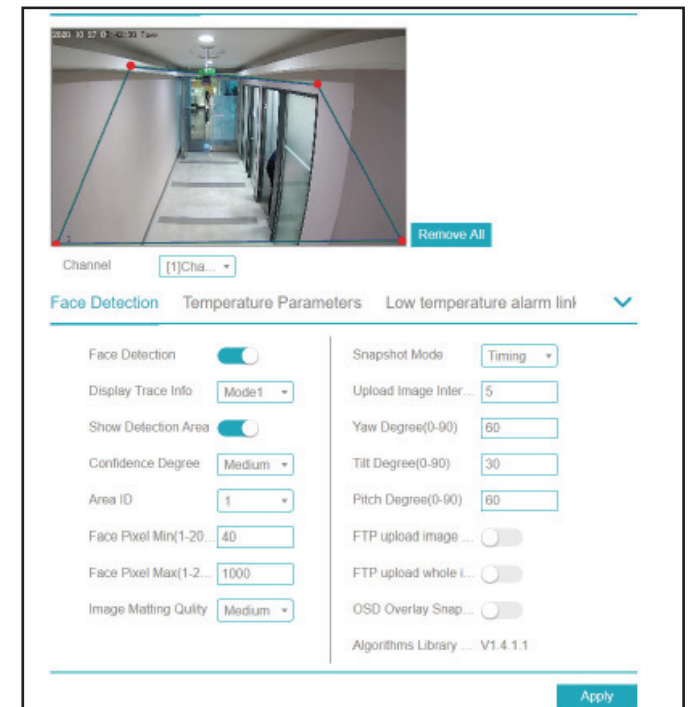

Face Detection

- Enable** Enable or disable face detection.
- Display Trace Info** Select the trace display mode from the drop-down menu.
- Show Detect. Area** Toggle this to show the temperature detection area with an outline.
- Conf. Degree** Select the confidence degree from the drop-down.
- Area ID** Designate an area ID to apply these settings to.
- Face Pixel Min/Max** Enter the minimum and maximum number of pixels that may be registered as a person's face.
- Image Matting Quality** Select the image matting quality from the drop-down.
- Snapshot Mode** Select the snapshot mode from the drop-down.
- Upload Image Interval** Select the interval (from 1 to 10, in seconds) at which snapshots should be uploaded.

Yaw/Tilt/Pitch Degree

Enter the yaw, tilt and pitch degrees, from 0 to 90 degrees.

FTP upload image matting/whole image

Toggle this to configure which parts of the image should be uploaded via FTP at the interval entered above.

OSD Overlay Snapshot

Toggle this to overlay the time, date, channel, etc over the snapshots

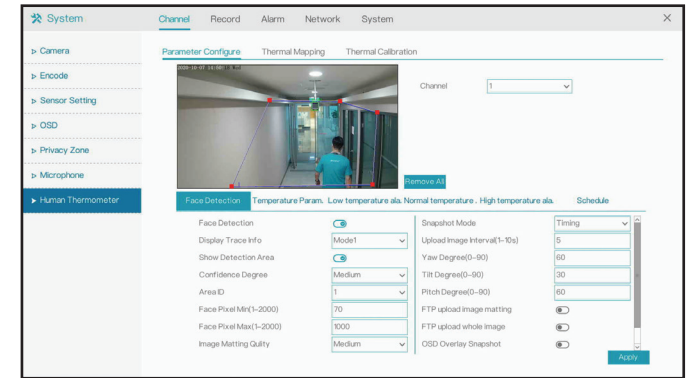

Temperature Param.

- Enable** Toggle this to enable temperature measurement.
- Temperature Unit** Select the desired unit from Fahrenheit and Celsius.
- Length Units** Select the unit to measure objects in the camera's display.
- Cavity Temp.** Enter the cavity temperature of the camera.
- Correction Coefficient** This refers to the difference between the measured temperature of an object and the actual temperature. Enter a value manually.
- Mount Distance** Enter the height at which the camera is mounted.
- Face Color** Toggle this to overlay detected faces with a color corresponding to their measured temperature.
- Environment Adaptation** Toggle this to automatically compensate for the temperature of the environment.
- Abnormal Temp. Display** Toggle this to flag detected abnormal temperatures.
- Temperature Area** Select the desired temperature area mode from the drop-down list.
- Temp. Measure Mode** Select the desired measurement mode from the drop-down list.
- Normal Temp. Range** Enter the normal temperature range. Values outside this range can be set to trigger an alarm.

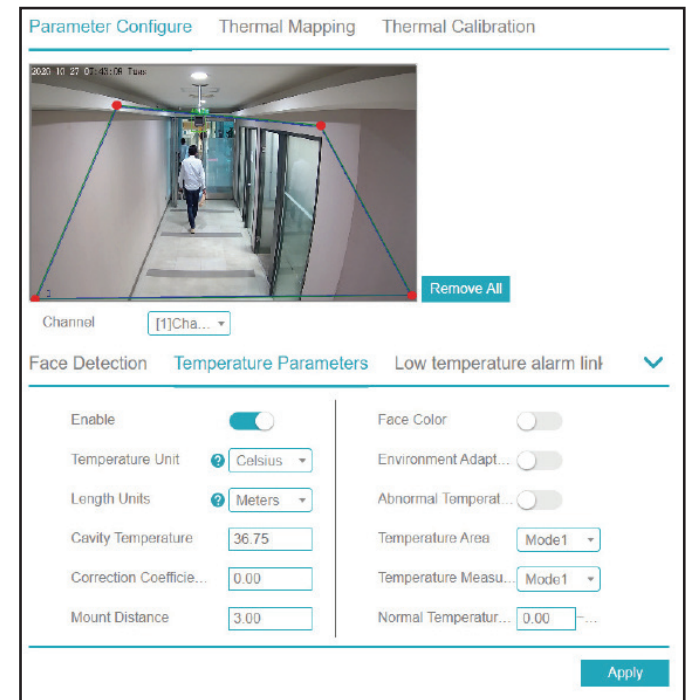

Temperature Alarm

On these tabs you can configure an alarm to trigger when an object is detected with a low, normal, or high temperature. Select the event(s) the alarm should trigger from the following list:

- **Email:** Send an email notification
- **FTP:** Send a notification via FTP
- **Popup Message:** Display a notification in a popup window
- **Full Screen:** Display a full-screen notification on the attached monitor
- **Buzzer:** Trigger a buzzer sound

Schedule

On this tab, you can click the calendar to set the thermometer to enable or disable according to a set schedule.

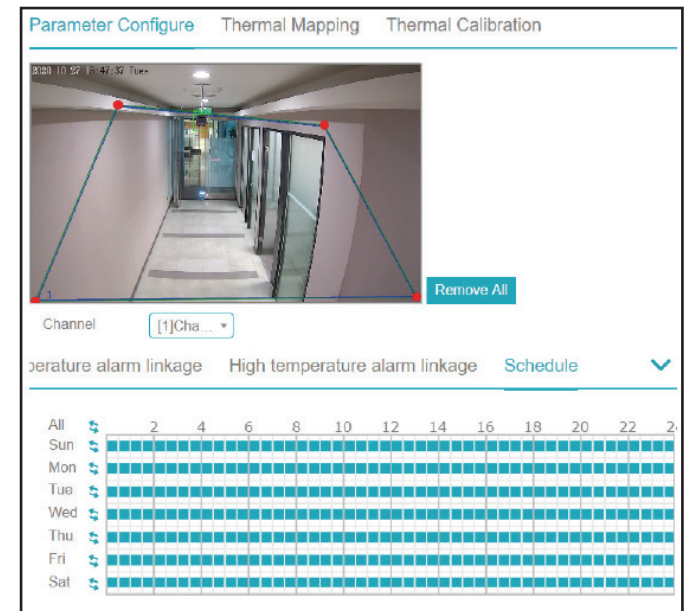
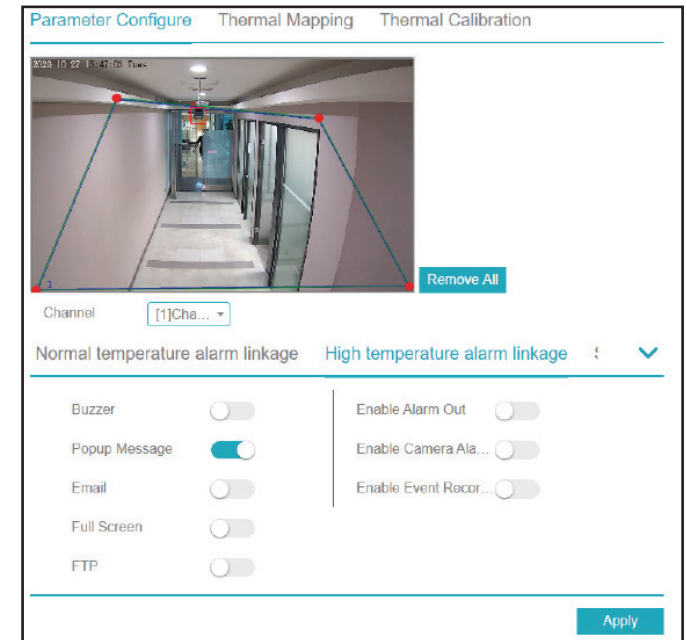

Record Record Schedule

On this page, you can set the recording schedule for the NVR.

Channel Specify the channel to set a recording schedule for.

Enable Record Toggle this to enable or disable recording for the specified channel.

Record Audio Toggle this to record audio for the specified channel.

Click the bars on the right side of the screen to determine the recording type for the channel in question. The types are:

- Continuous
- Camera Alarm In
- Motion Detection
- NVR Alarm In

Record Schedule

Channel [1]Cha...

Enable Record

Record Audio

	2	4	6	8	10	12	14	16	18	20	22
All	📺	📺	📺	📺	📺	📺	📺	📺	📺	📺	📺
Sun	📺	📺	📺	📺	📺	📺	📺	📺	📺	📺	📺
Mon	📺	📺	📺	📺	📺	📺	📺	📺	📺	📺	📺
Tue	📺	📺	📺	📺	📺	📺	📺	📺	📺	📺	📺
Wed	📺	📺	📺	📺	📺	📺	📺	📺	📺	📺	📺
Thu	📺	📺	📺	📺	📺	📺	📺	📺	📺	📺	📺
Fri	📺	📺	📺	📺	📺	📺	📺	📺	📺	📺	📺
Sat	📺	📺	📺	📺	📺	📺	📺	📺	📺	📺	📺

Copy Refresh Apply

Disk

On this page you can view and configure the settings for the installed hard drive(s).

Format Click this to format the specified disk. This will delete all of the data on the disk. Make sure to back up your data before formatting.

Disk Status Displays the status of the hard drive.

Disk SN The hard drive serial number.

Used Space The amount of space currently used on the selected hard drive.

Disk Group The disk group that the specified hard drive belongs to.

Recording Overwrite Toggle this to allow new data to overwrite old data on the specified hard drive.

Expired Time (Day) Set the length of time (in days) after which old records will be automatically overwritten.

Disk

HDD Disk1
Capacity 6TB

Format

Disk Status	Normal
Disk SN	ZA10ARQ9
Used Space	30GB
Disk Group	1

Recording Overwrite

Expired Time(Day)

Some records may be deleted if the expiration time is not 0

Apply

Storage Mode

Use this page to configure the recording storage settings for hard drives and disk groups.

Mode Selection Select a storage mode.

Disk Group Select a disk group to configure.

Channel Select a channel to assign to the selected disk group.

Storage Mode

Mode Selection Group

Disk Group

Channel

1	2	3	4	5	6	7	8
9	10	11	12	13	14	15	16

The default Channel belongs to Group 1

Group	Disk	Channel	Used Space	Capacity
1	Disk1	1-16	31GB	8.0TB
2			0MB	0MB

S.M.A.R.T.

This page allows you to view the inserted hard disks' attributes and ensure that they are operating smoothly.

Disk Specify a disk to check.

Disk SN Displays the serial number of the specified disk.

Temperature Displays the specified disk's current operating temperature.

Disk Health Displays the health (i.e. the operational condition) of the disk.

Disk Model The disk model number.

Working Time Indicates the specified disk's lifespan.

In the box at the bottom of the page, you can view various attributes for the specified disk, such as the power cycle count. If no serious issues are detected, the attribute will display Good in the Status column.

S.M.A.R.T

Disk:

Disk SN: ZA10ARQ9 Disk Model: ST8000VX0002-1Z6112

Temperature: 39.0 C Working Time: 10.4 Month

Disk Health: GOOD

ID	Attribute Name	Status	Value	Worst	Thresh	Type	Raw value
	uncorrect						
188	command-timeout	OK	100	99	0	old-age	0x020002000200
189	high-fly-writes	OK	100	100	0	old-age	0x000000000000
190	airflow-temperature-celsius	OK	61	41	40	old-age	0x270022270000
191	g-sense-error-rate	OK	100	100	0	old-age	0x000000000000
192	power-off-retract-count	OK	100	100	0	old-age	0xd20000000000
193	load-cycle-count	OK	100	100	0	old-age	0xca0200000000
194	temperature	OK	39	59	0	old-age	0x270000001800

Disk Calculation

On this page you can calculate the disk space required for the NVR's current configuration. Enter an amount of data to determine how long it will take for the current setup to fill it, or a period of time to determine how much data will be filled at the current rate of recording.

Total camera bitrate The total bitrate of the cameras connected to the NVR in kb / second.

Calculation mode Choose whether to display the computing capacity or the computation time.

Expect to save time / Disk Capacity Select an amount of time or an amount of storage, depending on whether Computation time or Computing Capacity was selected above.

Recording time per day Enter the number of hours that NVR will record data (per day).

Disk Calculation

Currently total camer... 5024 kbps

Calculation Mode:

Expect to save time:

Recording time per day: h

Required disk space

FTP

On this page you can set the NVR to automatically upload its recordings to an external server via FTP.

FTP Upload Check this to begin uploading saved recordings via FTP.

FTP Address Enter the IP address of the FTP server.

FTP Port Enter the port to use to connect to the FTP server.

Account Enter the username of the account used to connect.

Password Enter the password associated with the username entered above.

FTP Path Enter the path to the directory where you would like to save your files.

File Size (0-64 MB) Enter the desired file size of each recording. A smaller size means more frequent uploads.

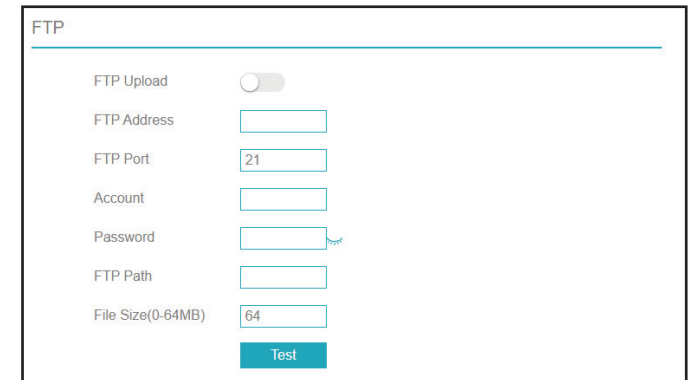

The screenshot shows a web interface titled "FTP" with the following configuration options:

- FTP Upload:** A toggle switch that is currently turned off.
- FTP Address:** An empty text input field.
- FTP Port:** A text input field containing the number "21".
- Account:** An empty text input field.
- Password:** A text input field with a small eye icon to the right, indicating a password field.
- FTP Path:** An empty text input field.
- File Size(0-64MB):** A text input field containing the number "64".

At the bottom right of the form is a blue button labeled "Test".

Alarm General

On this page you can configure general alarm settings for your NVR.

Enable Alarm In this tab you can enable and configure the NVR's general alarm.

Duration Time Enter the duration that the alarm should activate for.

Buzzer duration time Enter the duration that the alarm buzzer should sound for.

The screenshot shows a web interface for configuring alarm settings. At the top left, the word "General" is displayed in a light blue font. Below it, there is a section titled "Enable Alarm" with a toggle switch that is currently turned on. Underneath, there are two dropdown menus: "Alarm Duration Time..." set to "10s" and "Buzzer Duration Tim..." set to "30s". At the bottom right of the form, there are two buttons: "Refresh" and "Apply".

Motion Detection

Configure an alarm to trigger when the camera detects motion.

- Channel** Select the channel to configure.
- Enable** Toggle this to cause motion detection to trigger an alarm.
- Motion Analysis** Toggle this to enable or disable motion analysis.
- Event Actions** Select the event(s) the alarm should trigger from the following list:
- Email: Send an email notification
 - Buzzer: Trigger a buzzer sound
 - Popup Message: Display a notification in a popup window
 - Full Screen: Display a full-screen notification on the attached monitor
- Enable Alarm Out / Camera Alarm Out** Trigger a notification on the Alarm Out interface(s).
- Enable Event Recording** Toggle to keep a record of alarm events.
- Detection Area** Select the area of the display to scan for motion.
- Detection Schedule** Enable or disable the alarm according to a particular schedule.

Motion Detection

Channel [1]Cha ...

Enable Motion Detec...

Event Ac... Detectio... Detectio...

Buzzer

Popup Message

Full Screen

Email

FTP

Enable Alarm Out

Enable Camera Alar...

Enable Event Record...

Copy Apply

Video Loss

On this page you can enable an alarm to trigger when video loss occurs.

- Channel** Select the channel to configure.
- Enable Video Loss** Toggle this to cause video loss to trigger an alarm.
- Event Actions** Select the event(s) the alarm should trigger from the following list:
- Email: Send an email notification
 - Buzzer: Trigger a buzzer sound
 - Popup Message: Display a notification in a popup window
- Enable Alarm Out** Trigger a notification on the Alarm Out interface(s).
- Enable Event Recording** Toggle to keep a record of alarm events.
- Detection Schedule** Enable or disable the alarm according to a particular schedule.

The screenshot displays the 'Video Loss' configuration page. At the top, there is a 'Channel' dropdown menu showing '[1]Cha...'. Below it is a toggle switch for 'Enable Video Loss Al...' which is currently turned on. There are two tabs: 'Event Ac...' and 'Detectio...'. Underneath the tabs, there are five more toggle switches: 'Buzzer', 'Popup Message', 'Email', 'Enable Alarm Out', and 'Enable Event Record...', all of which are currently turned off. At the bottom right of the form, there are two buttons: 'Copy' and 'Apply'.

Alarm In

Use this page to enable an alarm when a signal from an external device connected to the NVR's Alarm In interface is detected.

- Alarm In** Select the channel to configure.
- Enable Alarm In** Toggle this to enable or disable Alarm In events and alarms.
- Event Actions** Select the event(s) the alarm should trigger from the following list:
- Email: Send an email notification
 - Buzzer: Trigger a buzzer sound
 - Popup Message: Display a notification in a popup window
- Enable Alarm Out** Trigger a notification on the Alarm Out interface(s).
- Enable Event Recording** Toggle to keep a record of alarm events.
- Detection Schedule** Enable or disable the alarm according to a particular schedule.
- Normal State** Specify the normal state of the sensor. A change from this state will trigger the alarm.
- Port Name** Designate a name for the sensor.
- Camera Alarm In** Click this tab to configure similar settings for sensors connected to a camera's Alarm In interface.

Abnormal Alarm

On this page you can enable or disable an alarm to trigger when an unusual event occurs, such as a hard drive failure or loss of connectivity.

Enable Abnormal Alarm

Enable or disable an abnormal alarm.

Alarm Type

From left to right: trigger an alarm when the NVR fails to detect a hard drive, when it detects an IP conflict, or when it loses its network connection.

Event Actions

Select the event(s) the alarm should trigger from the following list:

- Email: Send an email notification
- Buzzer: Trigger a buzzer sound
- Popup Message: Display a notification in a popup window

Enable Alarm Out

Trigger a notification on the Alarm Out interface(s).

Alarm Out

On this page you can configure the NVR's interactions with external devices connected to its Alarm Out interface.

- Port Number** Select the alarm out interface (either 1 or 2).
- Port Name** Designate a name for the alarm out connection.
- Action After Receiving Trigger** Select either **Close** or **Open**.
- Alarm Output Mode** Select the alarm out put mode (**Switch Mode** by default).
- Camera Alarm Out** Configure similar settings for devices connected to a camera's alarm out interface.

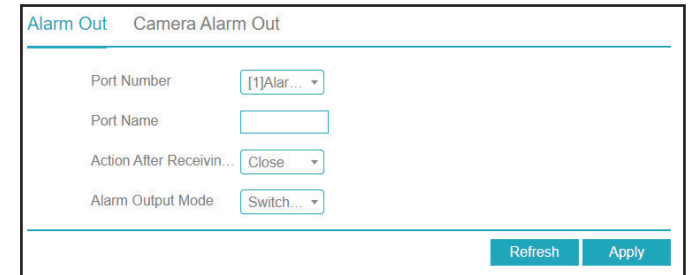

The screenshot shows a web interface for configuring the 'Camera Alarm Out' settings. The page title is 'Alarm Out Camera Alarm Out'. There are four configuration fields: 'Port Number' with a dropdown menu showing '[1]Alar...', 'Port Name' with an empty text input field, 'Action After Receiving...' with a dropdown menu showing 'Close', and 'Alarm Output Mode' with a dropdown menu showing 'Switch...'. At the bottom right of the form, there are two buttons: 'Refresh' and 'Apply'.

Network Network

IP Address

This page lets you configure the NVR's connection to the Internet or local network.

Enable DHCP Client Select this connection if you have a DHCP server running on your network and would like a dynamic IP address to be automatically updated to your NVR.

You may obtain a static or fixed IP address and other network information from your network administrator. A static IP address will simplify access to your NVR in the future.

IP Address Enter the fixed IP address of the NVR. This is used to access the web interface. If the NVR does not receive its address from a DHCP server, then its default IP address is will be **192.168.0.20**.

Subnet Mask Set this to match the subnet mask of the provided IP address. The default value is 255.255.255.0.

Default Gateway Set this to the default gateway on your router or local subnet for proper network routing.

Obtain DNS Automatically Toggle this to enable DNS automatically.

Preferred DNS Server Primary domain name server that translates names to IP addresses.

Alternate DNS Server Secondary domain name server to back up the primary domain name server

The screenshot shows the 'IP Address' configuration page. It features a header with three tabs: 'IP Address', 'Port Number', and 'POE'. The 'IP Address' tab is selected. Below the header, there are several configuration options:

- Enable DHCP Client:** A toggle switch that is currently turned on (checked).
- IP Address:** A text input field containing the value '192.168.100'.
- Subnet Mask:** A text input field containing the value '255.255.255'.
- Default Gateway:** A text input field containing the value '192.168.100'.
- Obtain DNS Automatically:** A toggle switch that is currently turned on (checked).
- Preferred DNS Server:** A text input field containing the value '192.168.100'.
- Alternate DNS Server:** An empty text input field.

At the bottom right of the page, there are two buttons: 'Refresh' and 'Apply'.

Port Number

On this page you can set the ports that the NVR will use to transfer data and allow clients to connect to.

HTTP Port The HTTP port for the web UI.

Data Port The port that data will be transferred over. The port that client devices will connect to.

Client Port It is necessary to reboot the device after modifying any of the port configuration settings.

IP Address	Port Number	POE
	HTTP Port Number	<input type="text" value="80"/>
	Data Port Number	<input type="text" value="554"/>
	Client Port Number	<input type="text" value="30001"/>

If the port parameters are modified then the device will reboot

PoE

On this page you can configure the settings for the NVR's PoE interfaces.

Auto Manage For PoE Camera Toggle this to automatically manage PoE settings for PoE-capable cameras.

IP Address Enter the fixed IP address of the NVR. The default IP address is **10.10.10.121**.

Subnet Mask Set this to match the subnet mask of the provided IP address. The default value is 255.255.255.0.

Default Gateway Set this to the default gateway on your router or local subnet for proper network routing. The default gateway is **10.10.10.1**.

The screenshot shows a configuration page for PoE settings. At the top, there are three tabs: "IP Address", "Port Number", and "POE", with "POE" being the active tab. Below the tabs, there is a section for "Auto Manage For PoE Camera" with a toggle switch that is currently turned on. Underneath, there are three input fields: "IP Address" with the value "10.10.10.121", "Subnet Mask" with the value "255.255.255", and "Default Gateway" with the value "10.10.10.1". At the bottom of the form, there is a red warning message: "*POE parameters are modified and the device will reboot*". To the right of the warning are two buttons: "Refresh" and "Apply".

DDNS

Enable this option only if you have registered a domain name with a dynamic DNS service provider. The following parameters are displayed when the option is enabled.

- Enable** Select a dynamic DNS service provider from the pull-down list.
- Protocol** Select the DDNS protocol to use.
- Domain Name** Enter your host name. For example: myhost.mydomain.net.
- Username** Enter the username for your dynamic DNS account.
- Password** Enter the password for your dynamic DNS account. Confirm it in the next text box.
- Test** Click this to test the DDNS settings.

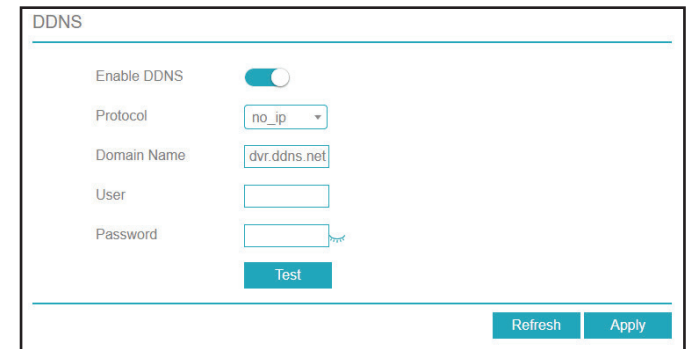

The screenshot shows a web interface for configuring DDNS. The title is "DDNS". It features a toggle switch for "Enable DDNS" which is currently turned on. Below it are several input fields: "Protocol" is a dropdown menu showing "no_ip"; "Domain Name" is a text box containing "dvr.ddns.net"; "User" and "Password" are empty text boxes. A "Test" button is located below the password field. At the bottom right, there are "Refresh" and "Apply" buttons.

Port Mapping

On this page you can enable or disable the port mapping feature.

Port Mapping Toggle this to enable or disable port mapping. If you enable this, you will also have to select a mode (Manual or Auto) and HTTP, client and data ports.

NAT Port In this tab you can enter a start and end port for the NAT port range.

The screenshot shows the 'Port Mapping' configuration page with the 'NAT Port' tab selected. The interface includes a toggle for 'NVR Port Mapping' which is currently turned on. Below it are four input fields: 'Port Mapping Mode' set to 'Auto', 'HTTP Port Number' set to '80', 'Data Port Number' set to '554', and 'Client Port Number' set to '30001'. At the bottom right, there are 'Refresh' and 'Apply' buttons.

Field	Value
NVR Port Mapping	<input checked="" type="checkbox"/>
Port Mapping Mode	Auto
HTTP Port Number	80
Data Port Number	554
Client Port Number	30001

Email

On this page you can configure the DNR-4020-16P's email settings, such as the email addresses that alerts and notifications should be sent to.

SMTP Server Enter the SMTP server to use, such as **smtp.gmail.com**.

SMTP Server Port Enter the port to connect to the SMTP server on. The default is 25.

Username Enter the username for the SMTP server.

Password Enter the corresponding password.

Email Sender Enter the address to send alert emails from.

Alarm Receiver 1-3 Enter the emails that should receive the NVR's alerts.

SSL Encryption Enter the form of encryption to use, or select OFF.

Sending interval Enter an interval between 0 and 600 seconds.

Test Click this to send a test email.

The screenshot shows a configuration page for 'Email Server 1' and 'Email Server 2'. The form contains the following fields and controls:

- SMTP Server: Text input field.
- SMTP Server Port Number: Text input field with the value '25'.
- Username: Text input field.
- Password: Text input field with a toggle for visibility.
- Email Sender: Text input field.
- Alarm Receiver 1: Text input field.
- Alarm Receiver 2: Text input field.
- Alarm Receiver 3: Text input field.
- SSL Encryption: Dropdown menu set to 'OFF'.
- Sending interval(0-600s): Text input field with the value '0'.
- Test: A blue button to send a test email.
- Refresh and Apply: Two buttons at the bottom right of the form.

IP Filter

On this page you can block or allow visitors from specified IPs from accessing the NVR. Click the plus (+) sign to add a range of IPs to the list, and then click Apply to save.

IP Filter Toggle this to enable IP filtering.

Rule Type Select Black List to block all IPs from the ranges you specify, or White List to only allow IPs from the ranges you specify.

IP Filter

Enable IP Filter

Rule Type Black List

Black List(Following network segments are not allowed) + -

Start IP Address	End IP Address	Edit
------------------	----------------	------

Refresh Apply

SNMP

If you have SNMP agents that you would like to send traps (such as alarms and syslog messages) to your NVR, you can enable and configure your SNMP settings on this page.

**SNMPV1/
SNMPV2C** Enable and enter a password for the Read/Write and Read-Only community strings here. Change the community string to keep intruders from getting information about the network setup.

SNMPV3 This SNMP version adds encryption and authentication to the service for better security. You can specify separate Read/Write versus Read-only name and passwords as well as the type of encryption to use.

SNMP

SNMPV1

SNMPV2C

Write Community

Read Community

Trap Address

Trap Port

Trap Community

SNMPV3

Read Security Name

Security Level

Auth Algorithm

Auth Password

Encry Algorithm

Encry Password

Write Security Name

Security Level

Auth Algorithm

Auth Password

Encry Algorithm

Encry Password

Web Mode

Click the switch on this page to enable or disable HTTPS for the web UI.

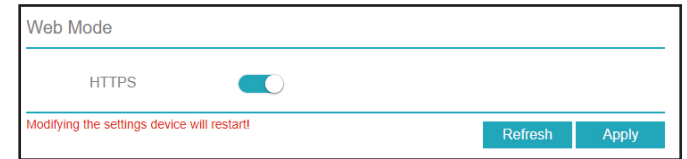

PPPoE

On this page you can enable, disable or configure PPPoE settings on your NVR.

Enable Enable this setting if your ISP is using PPPoE.

Username Enter the username provided by your ISP.

Password IP Enter the password provided by your ISP.

Address Enter the fixed address of the NVR and the port that is used to access the web interface.

The screenshot shows a web interface titled "PPPOE". It contains four configuration items: "Enable PPPoE" with a toggle switch that is turned on; "Username" with a text input field; "Password" with a text input field and a small eye icon to the right; and "IP Address" with a text input field.

Network Status

On this page you can view the status of the NVR's LAN and PoE ports and check your Internet connection.

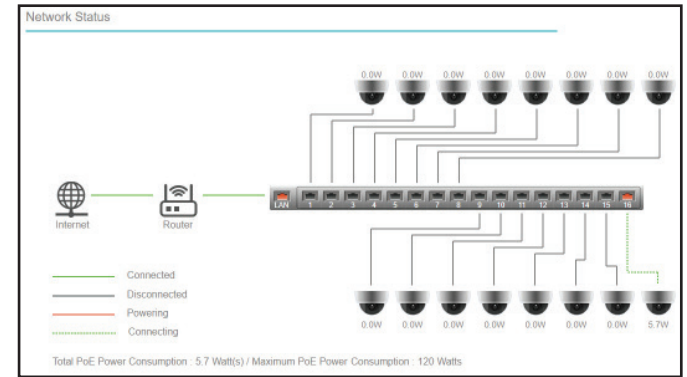

System Information

System

This page displays information about the NVR.

Device ID A unique ID used to identify the device.

Device Name The name used to identify the device.

Device Type Indicates the type of device (NVR).

Model The device's model number.

Firmware Version The device's current firmware version.

U-boot Version The device's current U-boot version.

Kernel Version The device's current kernel version.

HDD Number The number of HDD supported by the device.

Channels Supported The number of channels supported by the device.

Alarm In The number of Alarm In interfaces.

Alarm Out The number of Alarm Out interfaces.

Audio In The number of Audio In interfaces.

Audio Out The number of Audio Out interfaces

Information	
Device ID	B011003AEFY556155
Device Name	DNR-4020-16P-3306
Device Type	NVR
Model No.	DNR-4020-16P
Firmware Version	v1.00.12
U-boot Version	14041B090C21
Kernel Version	1406020E1D16
HDD Number	2
Channels Supported	16
Alarm In	8
Alarm Out	2
Audio In	1
Audio Out	1

System

Allows you to change general configuration settings (e.g. by setting the device name and language).

- Device Name** Enter the a new name to identify the NVR to other devices.
- Display Port Resolution** Enter the desired resolution for the NVR's configuration interface.
- Language** Select your preferred language.
- Temperature Units** Select either Celsius or Fahrenheit.

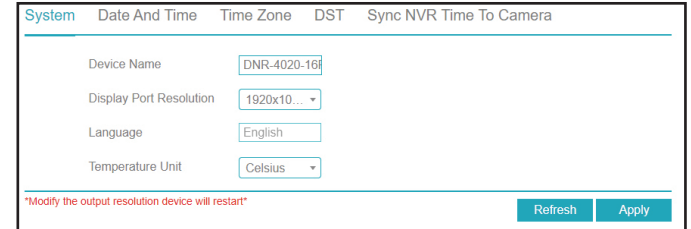

The screenshot shows a web configuration page for a D-Link NVR. The page has a navigation bar with tabs: System, Date And Time, Time Zone, DST, Sync NVR, Time To Camera. The 'System' tab is active. Below the navigation bar, there are four configuration items:

- Device Name: A text input field containing 'DNR-4020-16P'.
- Display Port Resolution: A dropdown menu showing '1920x10...'.
- Language: A dropdown menu showing 'English'.
- Temperature Unit: A dropdown menu showing 'Celsius'.

At the bottom of the configuration area, there is a red warning message: '*Modify the output resolution device will restart*'. To the right of the warning are two buttons: 'Refresh' and 'Apply'.

Date and Time

On this page you can change the device's date and time manually, or specify NTP settings to acquire the date and time automatically.

- Date Format** Specify the desired format that the device should use to display the date.
- Time Format** Specify the desired format that the device should use to display the system time.
- NTP Sync** Toggle this to automatically obtain the date and time from an NTP server.
- NTP Server** Specify the NTP server to use.
- Frequency of Checks** Specify how frequently (in seconds) to verify the system time with the NTP server.

 - Date** If NTP Sync is disabled, automatically enter the date.
 - Time** If NTP Sync is disabled, automatically enter the current time.

The screenshot shows the 'Date And Time' configuration page. It includes the following fields and controls:

- Date Format:** DD/MM/YY h...
- Time Format:** 12H
- Enable NTP:** A toggle switch that is currently turned on.
- NTP Server:** time.windows.co
- Sync Time Frequency (sec):** 86400s
- Time:** 28/10/2020 01:45:0

At the bottom of the form, there are two buttons: 'Refresh' and 'Apply'. A red warning message at the bottom left reads: 'Time modification will result the channel to reconnect' and 'Time modification will affect video query'.

Time Zone

On this page, you can select your current time zone and apply it to the NVR's time settings.

Time Zone Select your current time zone from the drop-down menu.

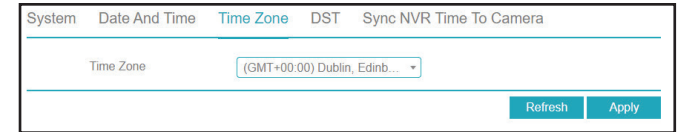

The screenshot shows a web interface for configuring the NVR's time settings. At the top, there is a navigation bar with tabs for 'System', 'Date And Time', 'Time Zone', 'DST', and 'Sync NVR Time To Camera'. The 'Time Zone' tab is currently selected. Below the navigation bar, there is a form with a label 'Time Zone' and a drop-down menu. The drop-down menu is open, showing the selected option '(GMT+00:00) Dublin, Edinb...'. At the bottom right of the form, there are two buttons: 'Refresh' and 'Apply'.

Daylight Saving Time

On this page you can enable or disable Daylight Saving Time.

Daylight Savings Time Toggle this to enable or disable Daylight Saving Time.

Start Time The date and time that DST should start.

End Time The date and time that DST should end.

Offset Time The number of hours to adjust the clock during DST

The screenshot shows a configuration page with a navigation bar at the top containing 'System', 'Date And Time', 'Time Zone', 'DST', and 'Sync NVR Time To Camera'. The 'DST' tab is selected. Below the navigation bar, there is a section titled 'Enable Daylight Saving Time' with a toggle switch that is currently turned on. Underneath, there are three rows of configuration options: 'Start Time' with dropdowns for 'Mar', 'Last one', 'Sun', and '1:00AM'; 'End Time' with dropdowns for 'Oct', 'Last one', 'Sun', and '1:00AM'; and 'Offset Time' with a dropdown for '1 Hour'. At the bottom right of the configuration area, there are two buttons: 'Refresh' and 'Apply'.

Sync NVR Time To Camera

On this page you can configure the cameras connected to the DNR-4020-16P to automatically sync their time settings with the NVR's.

Sync Camera Time Toggle this to enable time syncing with the connected cameras.

Frequency of Checks Enter how often (in seconds) the NVR should sync its time settings with its cameras' time settings.

System Date And Time Time Zone DST Sync NVR Time To Camera

Sync NVR Time To Camera

Sync Time Frequency (sec)

Refresh Apply

User Account

User

On this page you can create or change the account information for the NVR's user accounts (for example, by updating the password). Click the pencil icon under the Operate tab to edit an existing user account, or click Add to create a new one.

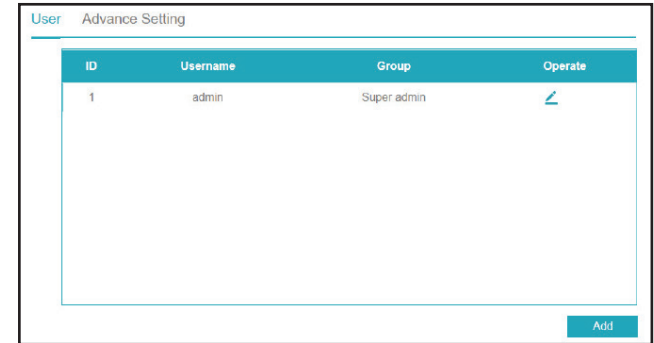

The screenshot shows a web interface for user management. At the top, there are tabs for 'User' and 'Advance Setting'. Below the tabs is a table with the following data:

ID	Username	Group	Operate
1	admin	Super admin	

An 'Add' button is located at the bottom right of the table area.

Advance Setting

On this tab you can configure advanced settings for the NVR's user accounts.

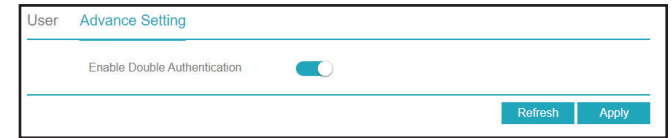

Password double auth. Toggle this to enable double password authentication.

Boot Wizard Toggle this to set the boot wizard to load automatically when the device is booted up.

Auto Login Toggle this to set the device to log in automatically.

Logout time Set the number of minutes of inactivity after which the device should log out automatically.

Monitor channel(s) when logout Select the channels to continue to monitor after logging out from the device.

Security Center

On this page you can update the password settings for the NVR.

Old Password Enter the current password.

New Password Enter the desired new password.

Confirm Password Confirm the new password by reentering it.

Unlock Pattern Use this tab to set a pattern to unlock your NVR instead of a typed password.

Secure Email Use this tab to set a recovery email to use in case you forget your password

The screenshot shows the 'Password' tab selected. It contains three input fields: 'Old Password', 'New Password', and 'Confirm Password'. The 'New Password' field has a small question mark icon to its right. At the bottom right of the form are two buttons: 'Refresh' and 'Apply'.

The screenshot shows the 'Secure Email' tab selected. It contains two input fields: 'Verify Password' and 'Email Address'. At the bottom right of the form are two buttons: 'Refresh' and 'Apply'.

Logs

System Log

On this page you can view the NVR's operational and system logs and search the log for specific events.

Start Date Enter the starting date to search the logs from.

End Date Enter the end date to search the logs until.

Type Enter the type of logs to search or export.

Start Time Enter the starting time to search the logs from.

End Time Enter the end time to search the logs until.

Search Click this to search for logs.

Export Click this to export the logs to a file.

The screenshot displays the 'System Log' interface. At the top, there are two tabs: 'System Log' and 'Event Log'. Below the tabs, there are search filters: 'Start' (27/10/2020 01:57:00), 'End' (28/10/2020 01:57:00), and 'Type' (All). There are 'Search' and 'Export' buttons. Below the filters is a table with the following headers: ID, Start Time, Channel, Log Type, and Information. The table is currently empty. At the bottom, there are navigation arrows and a 'Every page show' dropdown set to 20.

Event Log

On this page you can view the logs of events (such as triggered alarms).

Start Date Enter the starting date to search the logs from.

End Date Enter the end date to search the logs until.

Type Enter the type of logs to search or export.

Start Time Enter the starting time to search the logs from.

End Time Enter the end time to search the logs until.

Search Click this to search for logs.

Export Click this to export the logs to a file.

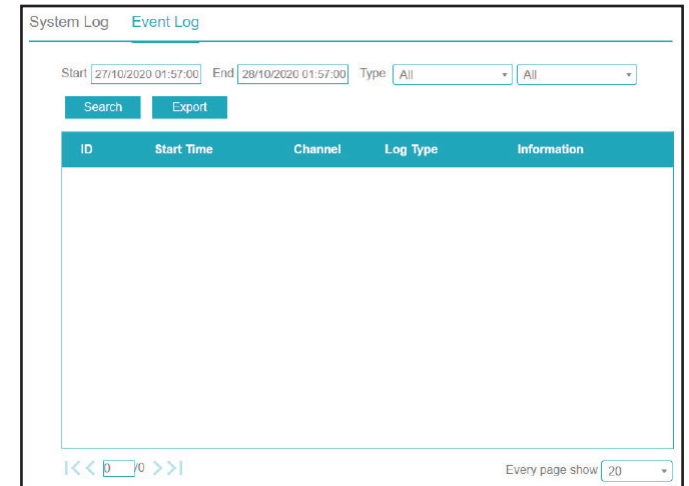

Maintenance

Maintenance

On this page you can perform miscellaneous maintenance tasks. Select the relevant icon to perform the task.

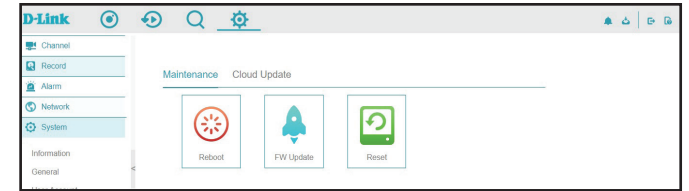

Shutdown Click this icon to shut down the NVR.

Reboot Click to reboot the NVR.

Logout Log out from the user interface.

Reset Reset the device to factory settings.

Import Config. Import configuration settings from a file.

Export Config. Export current configuration settings to a file.

FW Update Update the device's firmware. This requires a firmware file on an inserted USB storage device.

Cloud Update

Current Version Current firmware version number.

Latest Version It shows the latest firmware version number after checking FOTA server.

Auto Check latest Version Enable or disable to auto check the latest firmware version with FOTA server.

Auto Update Enable or disable to auto update device firmware. Setting hour, minute and the day for auto firmware update.

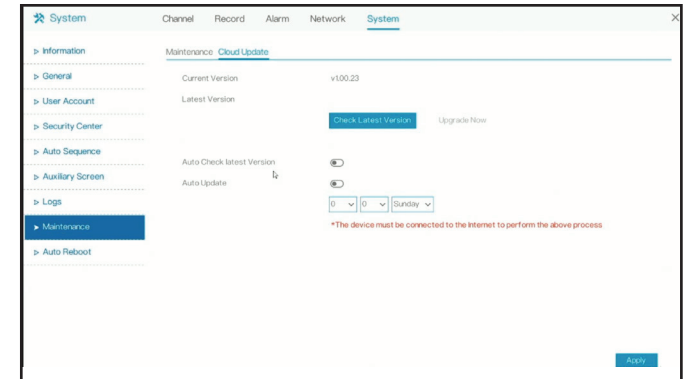

Auto Reboot

Toggle this to enable the device's automatic restart feature.

Enable Auto Reboot Toggle this to enable the automatic restart feature.

Reboot Time Set the frequency at which the device should restart (i.e. per day, week, or month) and the time that it should do so.

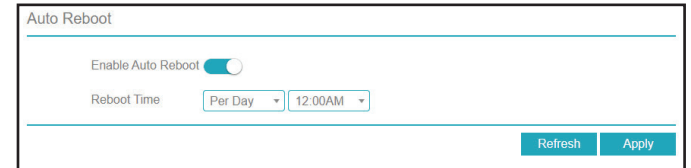

The screenshot shows a configuration panel titled "Auto Reboot". It contains two main settings: "Enable Auto Reboot" with a toggle switch that is currently turned on, and "Reboot Time" with two dropdown menus. The first dropdown is set to "Per Day" and the second is set to "12:00AM". At the bottom right of the panel, there are two buttons: "Refresh" and "Apply".

Password Reset

Designate E-mail Address

To protect video clips in the DNR-4020-16P, its design does not include a Reset Button. To reset the password, a temporary verification code can be obtained via the designated e-mail address in the NVR GUI.

To designate the e-mail address for password reset:

1. Log in to the NVR and right click the mouse to access the main menu.
2. Under **System** menu, select **Security Center**.

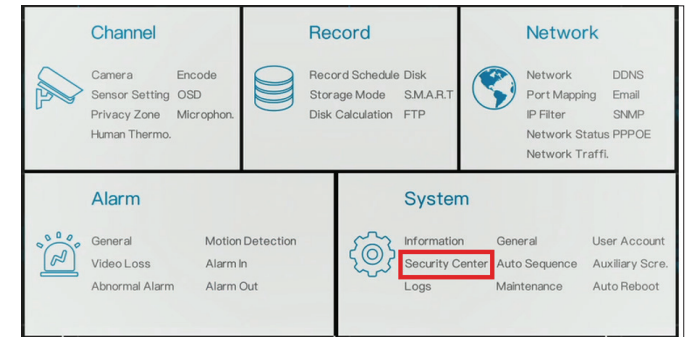

3. Go to **Secure Email** and input the administrator password and designate the **Email Address**.

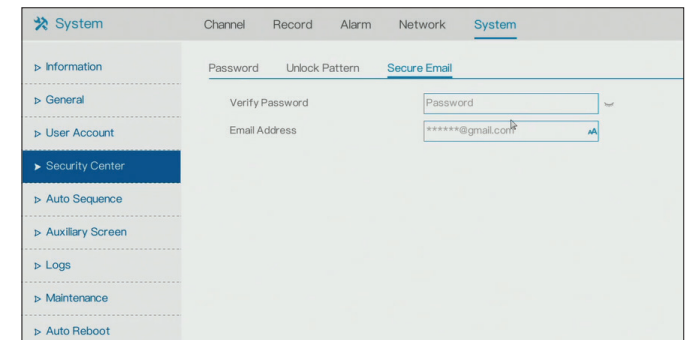

Obtain Verification Code

To obtain a temporary verification code to reset the password, click **Forgot Password** at the login screen.

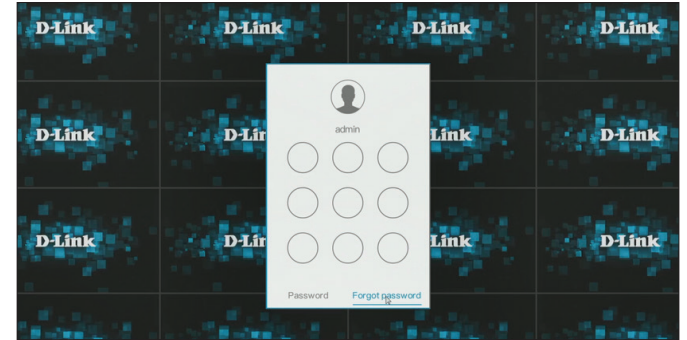

Select **Email Verification** option in **Recovery Method**.

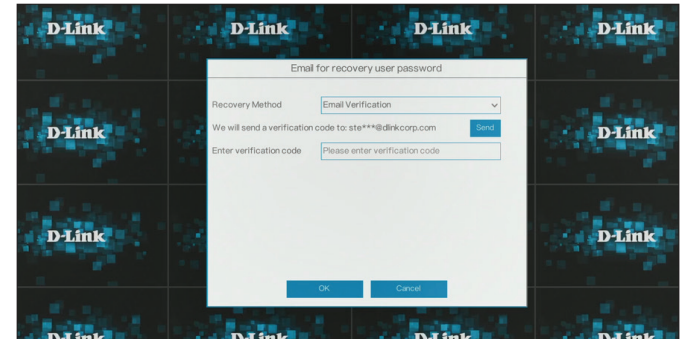

Click **Send** button and the NVR will send a temporary verification code to the designated e-mail address mentioned on **page 142**.

Note: The temporary verification code is only valid before 00:00am NVR time. If the code expires you will need to request a new verification code. The NVR will generate a new verification code every day and after reboot. The NVR will need internet access to send out verification code e-mails.

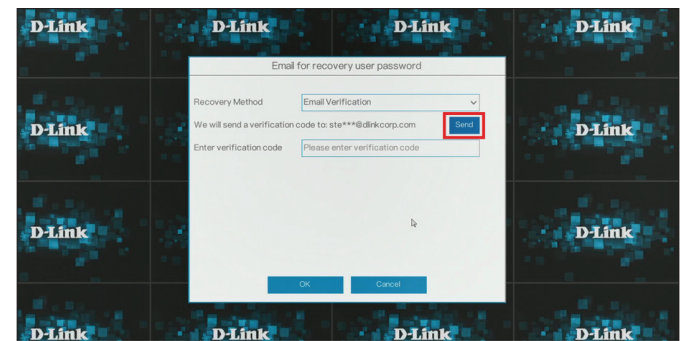

Resetting User Password

After receiving the verification code, enter it into the **Enter verification code** field and click **OK**.

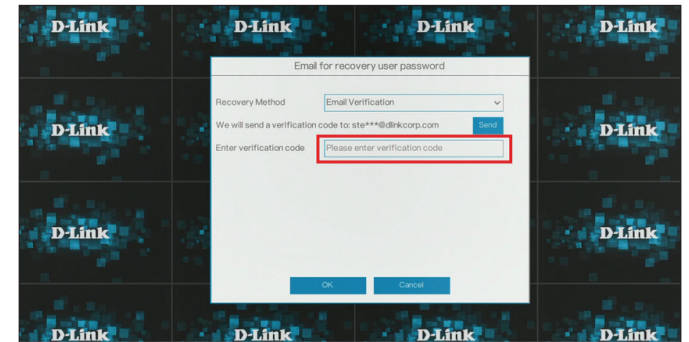

The screenshot shows a dialog box titled "Email for recovery user password" with a dark blue background. The dialog contains a "Recovery Method" dropdown menu set to "Email Verification". Below it, a message states "We will send a verification code to: ste***@dlinkcorp.com" with a "Send" button. The "Enter verification code" field is highlighted with a red border and contains the placeholder text "Please enter verification code". At the bottom, there are "OK" and "Cancel" buttons.

Input the new password in the **New Password** field and confirm the new password again in the **Confirm Password** field. Then click **Modify Password** to apply the new password.

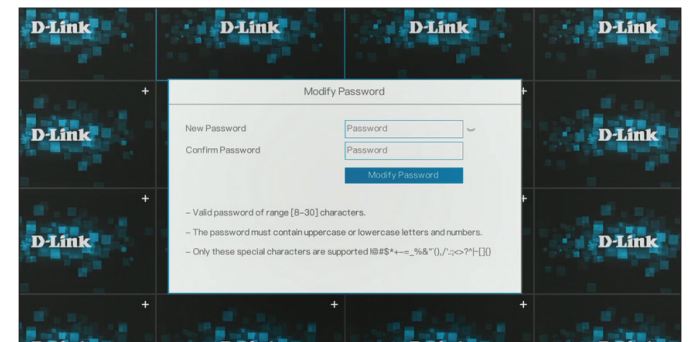

The screenshot shows a dialog box titled "Modify Password" with a dark blue background. It features two password input fields: "New Password" and "Confirm Password", both containing the placeholder "Password". A "Modify Password" button is located below the fields. At the bottom, there are three lines of password requirements: "Valid password of range [8-30] characters.", "The password must contain uppercase or lowercase letters and numbers.", and "Only these special characters are supported |@#\$%^&*+~_=-_%&'()/,:;>?}*|~[]".

The new password can now be used to log into the NVR.

Troubleshooting

Replacing a failed disk drive

If a disk drive fails, the Disk Status LED will turn red. When replacing a failed disk drive, be sure to use a new drive of the same or slightly greater capacity.

Step 1: Power off the NVR.

Step 2: Open the unit's cover.

Step 3: Pull out the failed disk drive.

Step 4: Install a new disk drive into the slot. Please refer to **Hard Drive Installation** on page <6>.

If you cannot log in to the NVR using your web browser

Check the settings of your anti-virus software to make sure it isn't blocking access to the NVR web interface.

If you cannot see the complete web interface in your web browser

If you cannot see the complete page of the system, the ActiveX installation process may not be complete.

Step 1: Open your web browser and connect to your NVR.

Step 2: The browser will ask whether to install ActiveX.

Step 3: Click the upper bar to begin the installation process.

Step 4: Click **Install** to complete the process.

Technical Specifications

Technical Specifications	
General	
Standards	<ul style="list-style-type: none"> • IEEE 802.3x/u/ab • SATA I/II/III • Auto MDI/MDI-X
HDD ¹	<ul style="list-style-type: none"> • Up to 8TB capacity per HDD drive²
Reset Button	<ul style="list-style-type: none"> • Reset through web GUI
Network Interface	<ul style="list-style-type: none"> • Gigabit Ethernet port (10/100/1000 Mbps)
I/O Ports	<ul style="list-style-type: none"> • 1 x 10/100/1000 Base-T RJ-45 port • HDMI (supports 4k resolution) • VGA (supports 1080P resolution) • 3 x USB 2.0 port³ • 3.5 mm audio input x 1, output x 1 • 8 x alarm in, 2 x alarm out
PoE	<ul style="list-style-type: none"> • IEEE 802.3af • 16 x 10/100 Base-T RJ-45 ports • Supplies up to 15 W per port • 120 W total PoE budget
Cooling	<ul style="list-style-type: none"> • 1 x Fan
Features	
Network Client OS	<ul style="list-style-type: none"> • Microsoft Windows 10
Supported Cameras ⁴	<ul style="list-style-type: none"> • Supports D-Link brand IP cameras • Supports auto-discovery
Live View/Playback	<ul style="list-style-type: none"> • HDMI port max output resolution: 4k⁵ • VGA port max output resolution: 1080p⁶
System Requirements for Web Interface	<ul style="list-style-type: none"> • Full support with Internet Explorer 10 and above • Partial support for Edge, Chrome, Safari and Firefox
Recording Performance	<ul style="list-style-type: none"> • Max recording bitrate: 112 Mbps
Camera Search	<ul style="list-style-type: none"> • WS-Discovery
Audio and Video Recording	<ul style="list-style-type: none"> • Synchronized audio and video recording
Compression Format	<ul style="list-style-type: none"> • H.264 • H.265
Audio Compression Format	<ul style="list-style-type: none"> • G.711 • AAC

Appendix A - Technical Specifications

Video Setting	<ul style="list-style-type: none"> • Resolution • Bitrate 	<ul style="list-style-type: none"> • Frame rate • Video profile selection
Recording Mode	<ul style="list-style-type: none"> • Schedule, manual and event-based recording 	<ul style="list-style-type: none"> • Motion-triggered recording
Alarm Recording	<ul style="list-style-type: none"> • Post-alarm: 30/40/50/60 seconds per channel 	
Live View Control	<ul style="list-style-type: none"> • Manual record • Instant playback • Audio enable/disable • PTZ control 	<ul style="list-style-type: none"> • 3D (on screen PTZ) • Digital zoom in/zoom out • Image setting • Two way audio
Playback Control	<ul style="list-style-type: none"> • Normal • Rewind • Play • Stop • Next frame • 30 second forward/backward 	<ul style="list-style-type: none"> • Playback speed adjust (maximum triple speeds) • Audio enable/disable • Start Backup • Batch Backup • 1/6/12/24 hour(s) options • Zoom
Overwrite Recording	<ul style="list-style-type: none"> • Auto recycling when disk storage is full 	
Video Export	<ul style="list-style-type: none"> • Export video to MP4 file format 	
User Account	<ul style="list-style-type: none"> • Additional accounts can be created to allow users system access and specify authorization for camera channels, PTZ, etc. 	
DDNS	<ul style="list-style-type: none"> • No_IP • AutoDNS 	<ul style="list-style-type: none"> • DynDNS
System Time	<ul style="list-style-type: none"> • Sync with NTP server • Manual Input time 	<ul style="list-style-type: none"> • Time Zone • Daylight Saving Time
System Status	<ul style="list-style-type: none"> • Channel status • HDD status 	<ul style="list-style-type: none"> • System status • Network status
Network Service Protocols	<ul style="list-style-type: none"> • IPv4, ARP, TCP, UDP, ICMP • DHCP Server (PoE ports) • DHCP Client (LAN ports) • NTP Client • DNS Client • DDNS Client • SMTP Client 	<ul style="list-style-type: none"> • HTTP/HTTPS Server • RTP • RTSP • RTCP • IP filtering • SNMP v1/v2c/v3
User Interface	<ul style="list-style-type: none"> • HTTP Web browser • Console via HDMI/VGA 	<ul style="list-style-type: none"> • JustConnect+ mobile app
Physical		
Weight	<ul style="list-style-type: none"> • 2.8 kg (6.2 lbs) (No Disk) 	
Power Input	<ul style="list-style-type: none"> • Input: 100 to 240 V AC/ 3.0 A, 50 to 60 Hz 	<ul style="list-style-type: none"> • Output: 52 V AC/ 2.5 A, DC 12V/ 5.0A

Power Consumption	<ul style="list-style-type: none"> • Max. 143 W
Temperature	<ul style="list-style-type: none"> • Operating: 0 to 40 °C (32 to 104 °F) • Storage: -20 to 70 °C (-4 to 158 °F)
Humidity	<ul style="list-style-type: none"> • Max of 90% non-condensing
Certifications	<ul style="list-style-type: none"> • CE • FCC • RoHS
Dimensions	<p>Technical drawings of the D-Link DNR-4020-16P NVR. The top row shows a front view with dimensions 372mm width and 310.5mm height, and an isometric view. The bottom row shows a side view with a height dimension of 46.5mm and a detailed view of the rear panel with various ports.</p>

Regulatory Information

Federal Communication Commission Interference Statement

This equipment has been tested and found to comply with the limits for a Class A digital device, pursuant to part 15 of the FCC Rules. These limits are designed to provide reasonable protection against harmful interference when the equipment is operated in a commercial environment. This equipment generates, uses, and can radiate radio frequency energy and, if not installed and used in accordance with the instruction manual, may cause harmful interference to radio communications. Operation of this equipment in a residential area is likely to cause harmful interference in which case the user will be required to correct the interference at his own expense.

Non-modification Statement

Any changes or modifications not expressly approved by the party responsible for compliance could void the user's authority to operate the equipment.

Caution

This device complies with Part 15 of the FCC Rules. Operation is subject to the following two conditions:

(1) This device may not cause harmful interference, and (2) this device must accept any interference received, including interference that may cause undesired operation.

Innovation, Science and Economic Development Canada (ISED) Statement:

This Class A digital apparatus complies with Canadian ICES-003.

Cet appareil numérique de la classe A est conforme à la norme NMB-003 du Canada.

CE EMI Class A Warning

This equipment is compliant with Class A of CISPR 32. In a residential environment this equipment may cause radio interference.

SAFETY INSTRUCTIONS

The following general safety guidelines are provided to help ensure your own personal safety and protect your product from potential damage. Remember to consult the product user instructions for more details.

- Static electricity can be harmful to electronic components. Discharge static electricity from your body (i.e. touching grounded bare metal) before touching the product.
- Do not attempt to service the product and never disassemble the product. For some products with a user replaceable battery, please read and follow the instructions in the user manual.
- Do not spill food or liquid on your product and never push any objects into the openings of your product.
- Do not use this product near water, areas with high humidity, or condensation unless the product is specifically rated for outdoor application.
- Keep the product away from radiators and other heat sources.
- Always unplug the product from mains power before cleaning and use a dry lint free cloth only.

SICHERHEITSVORSCHRIFTEN

Die folgenden allgemeinen Sicherheitsvorschriften dienen als Hilfe zur Gewährleistung Ihrer eigenen Sicherheit und zum Schutz Ihres Produkts. Weitere Details finden Sie in den Benutzeranleitungen zum Produkt.

- Statische Elektrizität kann elektronischen Komponenten schaden. Um Schäden durch statische Aufladung zu vermeiden, leiten Sie elektrostatische Ladungen von Ihrem Körper ab, (z. B. durch Berühren eines geerdeten blanken Metallteils), bevor Sie das Produkt berühren.
- Unterlassen Sie jeden Versuch, das Produkt zu warten, und versuchen Sie nicht, es in seine Bestandteile zu zerlegen. Für einige Produkte mit austauschbaren Akkus lesen Sie bitte das Benutzerhandbuch und befolgen Sie die dort beschriebenen Anleitungen.
- Vermeiden Sie, dass Speisen oder Flüssigkeiten auf Ihr Produkt gelangen, und stecken Sie keine Gegenstände in die Gehäuseschlitze oder -öffnungen Ihres Produkts.
- Verwenden Sie dieses Produkt nicht in unmittelbarer Nähe von Wasser und nicht in Bereichen mit hoher Luftfeuchtigkeit oder Kondensation, es sei denn, es ist speziell zur Nutzung in Außenbereichen vorgesehen und eingestuft.
- Halten Sie das Produkt von Heizkörpern und anderen Quellen fern, die Wärme erzeugen.
- Trennen Sie das Produkt immer von der Stromzufuhr, bevor Sie es reinigen und verwenden Sie dazu ausschließlich ein trockenes fusselfreies Tuch.

CONSIGNES DE SÉCURITÉ

Les consignes générales de sécurité ci-après sont fournies afin d'assurer votre sécurité personnelle et de protéger le produit d'éventuels dommages. Veuillez consulter les consignes d'utilisation du produit pour plus de détails.

- L'électricité statique peut endommager les composants électroniques. Déchargez l'électricité statique de votre corps (en touchant un objet en métal relié à la terre par exemple) avant de toucher le produit.
- N'essayez pas d'intervenir sur le produit et ne le démontez jamais. Pour certains produits contenant une batterie remplaçable par l'utilisateur,

- veuillez lire et suivre les consignes contenues dans le manuel d'utilisation.
- Ne renversez pas d'aliments ou de liquide sur le produit et n'insérez jamais d'objets dans les orifices.
- N'utilisez pas ce produit à proximité d'un point d'eau, de zones très humides ou de condensation sauf si le produit a été spécifiquement conçu pour une application extérieure.
- Éloignez le produit des radiateurs et autres sources de chaleur.
- Débranchez toujours le produit de l'alimentation avant de le nettoyer et utilisez uniquement un chiffon sec non pelucheux.

INSTRUCCIONES DE SEGURIDAD

Las siguientes directrices de seguridad general se facilitan para ayudarle a garantizar su propia seguridad personal y para proteger el producto frente a posibles daños. No olvide consultar las instrucciones del usuario del producto para obtener más información.

- La electricidad estática puede resultar nociva para los componentes electrónicos. Descargue la electricidad estática de su cuerpo (p. ej., tocando algún metal sin revestimiento conectado a tierra) antes de tocar el producto.
- No intente realizar el mantenimiento del producto ni lo desmonte nunca. Para algunos productos con batería reemplazable por el usuario, lea y siga las instrucciones del manual de usuario.
- No derrame comida o líquidos sobre el producto y nunca deje que caigan objetos en las aberturas del mismo.
- No utilice este producto cerca del agua, en zonas con humedad o condensación elevadas a menos que el producto esté clasificado específicamente para aplicación en exteriores.
- Mantenga el producto alejado de los radiadores y de otras fuentes de calor.
- Desenchufe siempre el producto de la alimentación de red antes de limpiarlo y utilice solo un paño seco sin pelusa"

ISTRUZIONI PER LA SICUREZZA

Las siguientes directrices de seguridad general se facilitan para ayudarle a garantizar su propia seguridad personal y para proteger el producto frente a posibles daños. No olvide consultar las instrucciones del usuario del producto para obtener más información.

- La electricidad estática puede resultar nociva para los componentes electrónicos. Descargue la electricidad estática de su cuerpo (p. ej., tocando algún metal sin revestimiento conectado a tierra) antes de tocar el producto.
- No intente realizar el mantenimiento del producto ni lo desmonte nunca. Para algunos productos con batería reemplazable por el usuario, lea y siga las instrucciones del manual de usuario.
- No derrame comida o líquidos sobre el producto y nunca deje que caigan objetos en las aberturas del mismo.
- No utilice este producto cerca del agua, en zonas con humedad o condensación elevadas a menos que el producto esté clasificado específicamente para aplicación en exteriores.
- Mantenga el producto alejado de los radiadores y de otras fuentes de calor.
- Desenchufe siempre el producto de la alimentación de red antes de limpiarlo y utilice solo un paño seco sin pelusa"

VEILIGHEIDSINFORMATIE

De volgende algemene veiligheidsinformatie werd verstrekt om uw eigen persoonlijke veiligheid te waarborgen en uw product te beschermen tegen mogelijke schade. Denk eraan om de gebruikersinstructies van het product te raadplegen voor meer informatie.

- Statische elektriciteit kan schadelijk zijn voor elektronische componenten. Ontlaad de statische elektriciteit van uw lichaam (d.w.z. het aanraken van geaard bloot metaal) voordat u het product aanraakt.
- U mag nooit proberen het product te onderhouden en u mag het product nooit demonteren. Voor sommige producten met door de gebruiker te vervangen batterij, dient u de instructies in de gebruikershandleiding te lezen en te volgen.
- Mors geen voedsel of vloeistof op uw product en u mag nooit voorwerpen in de openingen van uw product duwen.
- Gebruik dit product niet in de buurt van water, gebieden met hoge vochtigheid of condensatie, tenzij het product specifiek geclassificeerd is voor gebruik buitenshuis.
- Houd het product uit de buurt van radiators en andere warmtebronnen.
- U dient het product steeds los te koppelen van de stroom voordat u het reinigt en gebruik uitsluitend een droge pluisvrije doek"

Disposing and Recycling Your Product

ENGLISH

EN



This symbol on the product or packaging means that according to local laws and regulations this product should not be disposed of in household waste but sent for recycling. Please take it to a collection point designated by your local authorities once it has reached the end of its life, some will accept products for free. By recycling the product and its packaging in this manner you help to conserve the environment and protect human health.

D-Link and the Environment

At D-Link, we understand and are committed to reducing any impact our operations and products may have on the environment. To minimise this impact D-Link designs and builds its products to be as environmentally friendly as possible, by using recyclable, low toxic materials in both products and packaging.

D-Link recommends that you always switch off or unplug your D-Link products when they are not in use. By doing so you will help to save energy and reduce CO2 emissions.

To learn more about our environmentally responsible products and packaging please visit www.dlinkgreen.com.

DEUTSCH

DE



Dieses Symbol auf dem Produkt oder der Verpackung weist darauf hin, dass dieses Produkt gemäß bestehender örtlicher Gesetze und Vorschriften nicht über den normalen Hausmüll entsorgt werden sollte, sondern einer Wiederverwertung zuzuführen ist. Bringen Sie es bitte zu einer von Ihrer Kommunalbehörde entsprechend amtlich ausgewiesenen Sammelstelle, sobald das Produkt das Ende seiner Nutzungsdauer erreicht hat. Für die Annahme solcher Produkte erheben einige dieser Stellen keine Gebühren. Durch ein auf diese Weise durchgeführtes Recycling des Produkts und seiner Verpackung helfen Sie, die Umwelt zu schonen und die menschliche Gesundheit zu schützen.

D-Link und die Umwelt

D-Link ist sich den möglichen Auswirkungen seiner Geschäftstätigkeiten und seiner Produkte auf die Umwelt bewusst und fühlt sich verpflichtet, diese entsprechend zu mindern. Zu diesem Zweck entwickelt und stellt D-Link seine Produkte mit dem Ziel größtmöglicher Umweltfreundlichkeit her und verwendet wiederverwertbare, schadstoffarme Materialien bei Produktherstellung und Verpackung.

D-Link empfiehlt, Ihre Produkte von D-Link, wenn nicht in Gebrauch, immer auszuschalten oder vom Netz zu nehmen. Auf diese Weise helfen Sie, Energie zu sparen und CO2-Emissionen zu reduzieren.

Wenn Sie mehr über unsere umweltgerechten Produkte und Verpackungen wissen möchten, finden Sie entsprechende Informationen im Internet unter www.dlinkgreen.com.

FRANÇAIS**FR**

Ce symbole apposé sur le produit ou son emballage signifie que, conformément aux lois et réglementations locales, ce produit ne doit pas être éliminé avec les déchets domestiques mais recyclé. Veuillez le rapporter à un point de collecte prévu à cet effet par les autorités locales; certains accepteront vos produits gratuitement. En recyclant le produit et son emballage de cette manière, vous aidez à préserver l'environnement et à protéger la santé de l'homme.

D-Link et l'environnement

Chez D-Link, nous sommes conscients de l'impact de nos opérations et produits sur l'environnement et nous engageons à le réduire. Pour limiter cet impact, D-Link conçoit et fabrique ses produits de manière aussi écologique que possible, en utilisant des matériaux recyclables et faiblement toxiques, tant dans ses produits que ses emballages.

D-Link recommande de toujours éteindre ou débrancher vos produits D-Link lorsque vous ne les utilisez pas. Vous réaliserez ainsi des économies d'énergie et réduirez vos émissions de CO₂.

Pour en savoir plus sur les produits et emballages respectueux de l'environnement, veuillez consulter le www.dlinkgreen.com.

ESPAÑOL**ES**

Este símbolo en el producto o el embalaje significa que, de acuerdo con la legislación y la normativa local, este producto no se debe desechar en la basura doméstica sino que se debe reciclar. Llévelo a un punto de recogida designado por las autoridades locales una vez que ha llegado al fin de su vida útil; algunos de ellos aceptan recogerlos de forma gratuita. Al reciclar el producto y su embalaje de esta forma, contribuye a preservar el medio ambiente y a proteger la salud de los seres humanos.

D-Link y el medio ambiente

En D-Link, comprendemos y estamos comprometidos con la reducción del impacto que puedan tener nuestras actividades y nuestros productos en el medio ambiente. Para reducir este impacto, D-Link diseña y fabrica sus productos para que sean lo más ecológicos posible, utilizando materiales reciclables y de baja toxicidad tanto en los productos como en el embalaje.

D-Link recomienda apagar o desenchufar los productos D-Link cuando no se estén utilizando. Al hacerlo, contribuirá a ahorrar energía y a reducir las emisiones de CO₂.

Para obtener más información acerca de nuestros productos y embalajes ecológicos, visite el sitio www.dlinkgreen.com.

ITALIANO**IT**

La presenza di questo simbolo sul prodotto o sulla confezione del prodotto indica che, in conformità alle leggi e alle normative locali, questo prodotto non deve essere smaltito nei rifiuti domestici, ma avviato al riciclo. Una volta terminato il ciclo di vita utile, portare il prodotto presso un punto di raccolta indicato dalle autorità locali. Alcuni questi punti di raccolta accettano gratuitamente i prodotti da riciclare. Scegliendo di riciclare il prodotto e il relativo imballaggio, si contribuirà a preservare l'ambiente e a salvaguardare la salute umana.

D-Link e l'ambiente

D-Link cerca da sempre di ridurre l'impatto ambientale dei propri stabilimenti e dei propri prodotti. Allo scopo di ridurre al minimo tale impatto, D-Link progetta e realizza i propri prodotti in modo che rispettino il più possibile l'ambiente, utilizzando materiali riciclabili a basso tasso di tossicità sia per i prodotti che per gli imballaggi.

D-Link raccomanda di spegnere sempre i prodotti D-Link o di scollegarne la spina quando non vengono utilizzati. In questo modo si contribuirà a risparmiare energia e a ridurre le emissioni di anidride carbonica.

Per ulteriori informazioni sui prodotti e sugli imballaggi D-Link a ridotto impatto ambientale, visitate il sito all'indirizzo www.dlinkgreen.com.

NEDERLANDS**NL**

Dit symbool op het product of de verpakking betekent dat dit product volgens de plaatselijke wetgeving niet mag worden weggegooid met het huishoudelijk afval, maar voor recyclage moeten worden ingeleverd. Zodra het product het einde van de levensduur heeft bereikt, dient u het naar een inzamelpunt te brengen dat hiertoe werd aangeduid door uw plaatselijke autoriteiten, sommige autoriteiten accepteren producten zonder dat u hiervoor dient te betalen. Door het product en de verpakking op deze manier te recyclen helpt u het milieu en de gezondheid van de mens te beschermen.

D-Link en het milieu

Bij D-Link spannen we ons in om de impact van onze handelingen en producten op het milieu te beperken. Om deze impact te beperken, ontwerpt en bouwt D-Link zijn producten zo milieuvriendelijk mogelijk, door het gebruik van recycleerbare producten met lage toxiciteit in product en verpakking.

D-Link raadt aan om steeds uw D-Link producten uit te schakelen of uit de stekker te halen wanneer u ze niet gebruikt. Door dit te doen bespaart u energie en beperkt u de CO₂-emissies.

Breng een bezoek aan www.dlinkgreen.com voor meer informatie over onze milieuverantwoorde producten en verpakkingen.

POLSKI**PL**

Ten symbol umieszczony na produkcie lub opakowaniu oznacza, że zgodnie z miejscowym prawem i lokalnymi przepisami niniejszego produktu nie wolno wyrzucać jak odpady czy śmieci z gospodarstwa domowego, lecz należy go poddać procesowi recyklingu. Po zakończeniu użytkowania produktu, niektóre odpowiednie do tego celu podmioty przyjmą takie produkty nieodpłatnie, dlatego prosimy dostarczyć go do punktu zbiórki wskazanego przez lokalne władze. Poprzez proces recyklingu i dzięki takiemu postępowaniu z produktem oraz jego opakowaniem, pomogą Państwo chronić środowisko naturalne i dbać o ludzkie zdrowie.

D-Link i środowisko

D-Link podchodzimy w sposób świadomy do ochrony otoczenia oraz jesteśmy zaangażowani w zmniejszanie wpływu naszych działań i produktów na środowisko naturalne. W celu zminimalizowania takiego wpływu firma D-Link konstruuje i wytwarza swoje produkty w taki sposób, aby były one jak najbardziej przyjazne środowisku, stosując do tych celów materiały nadające się do powtórnego wykorzystania, charakteryzujące się małą toksycznością zarówno w przypadku samych produktów jak i opakowań.

Firma D-Link zaleca, aby Państwo zawsze prawidłowo wyłączali z użytku swoje produkty D-Link, gdy nie są one wykorzystywane. Postępując w ten sposób pozwalają Państwo oszczędzać energię i zmniejszać emisje CO₂.

Aby dowiedzieć się więcej na temat produktów i opakowań mających wpływ na środowisko prosimy zapoznać się ze stroną Internetową www.dlinkgreen.com.

ČESKY**CZ**

Tento symbol na výrobku nebo jeho obalu znamená, že podle místně platných předpisů se výrobek nesmí vyhazovat do komunálního odpadu, ale odeslat k recyklaci. Až výrobek doslouží, odneste jej prosím na sběrné místo určené místními úřady k tomuto účelu. Některá sběrná místa přijímají výrobky zdarma. Recyklací výrobku i obalu pomáháte chránit životní prostředí i lidské zdraví.

D-Link a životní prostředí

Ve společnosti D-Link jsme si vědomi vlivu našich provozů a výrobků na životní prostředí a snažíme se o minimalizaci těchto vlivů. Proto své výrobky navrhujeme a vyrábíme tak, aby byly co nejekologičtější, a ve výrobcích i obalech používáme recyklovatelné a nízkotoxické materiály.

Společnost D-Link doporučuje, abyste své výrobky značky D-Link vypnuli nebo vytáhli ze zásuvky vždy, když je nepoužíváte. Pomůžete tak šetřit energii a snížit emise CO₂.

Více informací o našich ekologických výrobcích a obalech najdete na adrese www.dlinkgreen.com.

MAGYAR**HU**

Ez a szimbólum a terméken vagy a csomagoláson azt jelenti, hogy a helyi törvényeknek és szabályoknak megfelelően ez a termék nem semmisíthető meg a háztartási hulladékkal együtt, hanem újrahasznosításra kell küldeni. Kérjük, hogy a termék élettartamának elteltét követően vigye azt a helyi hatóság által kijelölt gyűjtőhelyre. A termékek egyes helyeken ingyen elhelyezhetők. A termék és a csomagolás újrahasznosításával segíti védeni a környezetet és az emberek egészségét.

A D-Link és a környezet

A D-Linknél megértjük és elköteleztük magunkat a műveleteink és termékeink környezetre gyakorolt hatásainak csökkentésére. Az ezen hatás csökkentése érdekében a D-Link a lehető leginkább környezetbarát termékeket tervez és gyárt azáltal, hogy újrahasznosítható, alacsony károsanyag-tartalmú termékeket gyárt és csomagolásokat alkalmaz.

A D-Link azt javasolja, hogy mindig kapcsolja ki vagy húzza ki a D-Link termékeket a tápforrásból, ha nem használja azokat. Ezzel segít az energia megtakarításában és a széndioxid kibocsátásának csökkentésében.

Környezetbarát termékeinkről és csomagolásainkról további információkat a www.dlinkgreen.com weboldalon tudhat meg.

NORSK**NO**

Dette symbolet på produktet eller forpakningen betyr at dette produktet ifølge lokale lover og forskrifter ikke skal kastes sammen med husholdningsavfall, men leveres inn til gjenvinning. Vennligst ta det til et innsamlingssted anvist av lokale myndigheter når det er kommet til slutten av levetiden. Noen steder aksepteres produkter uten avgift. Ved på denne måten å gjenvinne produktet og forpakningen hjelper du å verne miljøet og beskytte folks helse.

D-Link og miljøet

Hos D-Link forstår vi oss på og er forpliktet til å minske innvirkningen som vår drift og våre produkter kan ha på miljøet. For å minimalisere denne innvirkningen designer og lager D-Link produkter som er så miljøvennlig som mulig, ved å bruke resirkulerbare, lav-toksiske materialer både i produktene og forpakningen.

D-Link anbefaler at du alltid slår av eller frakobler D-Link-produkter når de ikke er i bruk. Ved å gjøre dette hjelper du å spare energi og å redusere CO2-utslipp.

For mer informasjon angående våre miljøansvarlige produkter og forpakninger kan du gå til www.dlinkgreen.com.

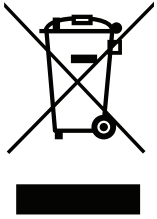
DANSK**DK**

Dette symbol på produktet eller emballagen betyder, at dette produkt i henhold til lokale love og regler ikke må bortskaffes som husholdningsaffald, mens skal sendes til genbrug. Indlever produktet til et indsamlingssted som angivet af de lokale myndigheder, når det er nået til slutningen af dets levetid. I nogle tilfælde vil produktet blive modtaget gratis. Ved at indlevere produktet og dets emballage til genbrug på denne måde bidrager du til at beskytte miljøet og den menneskelige sundhed.

D-Link og miljøet

Hos D-Link forstår vi og bestræber os på at reducere enhver indvirkning, som vores aktiviteter og produkter kan have på miljøet. For at minimere denne indvirkning designer og producerer D-Link sine produkter, så de er så miljøvenlige som muligt, ved at bruge genanvendelige materialer med lavt giftighedsniveau i både produkter og emballage.

D-Link anbefaler, at du altid slukker eller frakobler dine D-Link-produkter, når de ikke er i brug. Ved at gøre det bidrager du til at spare energi og reducere CO₂-udledningerne.

Du kan finde flere oplysninger om vores miljømæssigt ansvarlige produkter og emballage på www.dlinkgreen.com.

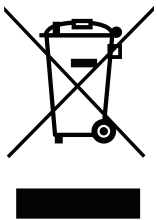
SUOMI**FI**

Tämä symboli tuotteen pakkauksessa tarkoittaa, että paikallisten lakien ja säännösten mukaisesti tätä tuotetta ei pidä hävittää yleisen kotitalousjätteen seassa vaan se tulee toimittaa kierrätettäväksi. Kun tuote on elinkaarensa päässä, toimita se lähimpään viranomaisten hyväksymään kierrätyspisteeseen. Kierrättämällä käytetyn tuotteen ja sen pakkauksen autat tukemaan sekä ympäristön että ihmisten terveyttä ja hyvinvointia.

D-Link ja ympäristö

D-Link ymmärtää ympäristönsuojelun tärkeyden ja on sitoutunut vähentämään tuotteistaan ja niiden valmistuksesta ympäristölle mahdollisesti aiheutuvia haittavaikutuksia. Nämä negatiiviset vaikutukset minimoidakseen D-Link suunnittelee ja valmistaa tuotteensa mahdollisimman ympäristöystävällisiksi käyttämällä kierrätettäviä, alhaisia pitoisuuksia haitallisia aineita sisältäviä materiaaleja sekä tuotteissaan että niiden pakkauksissa.

Suosittellemme, että irrotat D-Link-tuotteesi virtalähteestä tai sammutat ne aina, kun ne eivät ole käytössä. Toimimalla näin autat säästämään energiaa ja vähentämään hiilidioksiidipäästöjä.

Lue lisää ympäristöystävällisistä D-Link-tuotteista ja pakkauksistamme osoitteesta www.dlinkgreen.com.

SVENSKA**SE**

Den här symbolen på produkten eller förpackningen betyder att produkten enligt lokala lagar och föreskrifter inte skall kastas i hushållssoporna utan i stället återvinnas. Ta den vid slutet av dess livslängd till en av din lokala myndighet utsedd uppsamlingsplats, vissa accepterar produkter utan kostnad. Genom att på detta sätt återvinna produkten och förpackningen hjälper du till att bevara miljön och skydda människors hälsa.

D-Link och miljön

På D-Link förstår vi och är fast beslutna att minska den påverkan våra verksamheter och produkter kan ha på miljön. För att minska denna påverkan utformar och bygger D-Link sina produkter för att de ska vara så miljövänliga som möjligt, genom att använda återvinningsbara material med låg gifthalt i både produkter och förpackningar.

D-Link rekommenderar att du alltid stänger av eller kopplar ur dina D-Link produkter när du inte använder dem. Genom att göra detta hjälper du till att spara energi och minska utsläpp av koldioxid.

För mer information om våra miljöansvariga produkter och förpackningar www.dlinkgreen.com.

PORTUGUÊS**PT**

Este símbolo no produto ou embalagem significa que, de acordo com as leis e regulamentações locais, este produto não deverá ser eliminado juntamente com o lixo doméstico mas enviado para a reciclagem. Transporte-o para um ponto de recolha designado pelas suas autoridades locais quando este tiver atingido o fim da sua vida útil, alguns destes pontos aceitam produtos gratuitamente. Ao reciclar o produto e respectiva embalagem desta forma, ajuda a preservar o ambiente e protege a saúde humana.

A D-Link e o ambiente

Na D-Link compreendemos e comprometemo-nos com a redução do impacto que as nossas operações e produtos possam ter no ambiente. Para minimizar este impacto a D-Link concebe e constrói os seus produtos para que estes sejam o mais inofensivos para o ambiente possível, utilizando materiais recicláveis e não tóxicos tanto nos produtos como nas embalagens.

A D-Link recomenda que desligue os seus produtos D-Link quando estes não se encontrarem em utilização. Com esta acção ajudará a poupar energia e reduzir as emissões de CO₂.

Para saber mais sobre os nossos produtos e embalagens responsáveis a nível ambiental visite www.dlinkgreen.com.