

D-View 8

Network Management System
User Manual

V2.07



Information in this document is subject to change without notice. Reproduction of this document in any manner, without the written permission of the D-Link Corporation, is strictly forbidden.

Trademarks used in this text: D-Link and the D-Link logo are trademarks of the D-Link Corporation; Microsoft and Windows are registered trademarks of the Microsoft Corporation.

Other trademarks and trade names may be used in this document to refer to either as the entities claiming the marks and the names or their products. D-Link Corporation disclaims any proprietary interest in trademarks and trade names other than its own.

© 2024 D-Link Corporation. All rights reserved.

Table of Contents

1	Introduction	1
1.1.	D-Link D-View 8 Network Management Software	1
1.2.	D-View 8 Features	2
1.3.	D-View 8 Licenses	4
1.4.	90-Day Free Trial.....	5
1.5.	D-View 8 Server System Requirements.....	6
1.6.	D-View 8 Remote Probe Requirements	6
1.7.	D-View 8 Client Requirements.....	7
1.8.	Network Environment Models.....	7
1.9.	Device Groups.....	8
1.10.	User Authentication Types	8
1.11.	Prepare Network Devices for Discovery	8
1.12.	Start D-View 8	8
2	Installation	9
2.1.	Requirements	9
2.2.	Windows Installation.....	9
2.2.1.	Standalone Edition Installation	9
2.2.2.	Cluster Mode Installation (Only Available for Enterprise Edition)	14
2.2.3.	Probe Package Installation.....	28
2.3.	Linux Installation.....	30
2.3.1.	Standalone Edition Installation	30
2.3.2.	Cluster Mode Installation (Only Available for Enterprise Edition)	32
2.3.3	Probe Package Installation	51
2.4	Software Upgrade.....	54
2.4.1.	On Windows.....	54
2.4.2.	On Linux.....	56
2.5	Uninstallation.....	57
2.5.1.	Uninstall under Windows	57
2.5.2.	Uninstall under Linux.....	57
2.6	Software Migration	58
2.6.1.	D-View 7 and D-View 8 Architecture.....	58
2.6.2.	Install D-View 8 on a New Server	58

2.6.3. Install D-View 8 on the Original D-View 7 Server.....	62
2.6.4. Upgrade Remote Probes.....	65
3 Overview and Basics	67
3.1. Login and Basic Configurations	67
3.2. Launch the D-View 8 Web GUI.....	67
3.3. Overview of the Web Dashboard.....	70
3.3.1. Common Features.....	70
3.3.2. Menus and Toolbar	71
3.3.3. Annunciator	80
3.3.4. Workspace Preferences	81
3.4 Change User Password.....	81
3.5 Configure Email Server for Notification.....	82
3.6 Configure the Notification Center.....	83
4 Organizations and Networks	87
4.1. Network Discovery.....	87
4.1.1. Add Network for Discovery	87
4.1.2. Execute Network Discovery	92
4.1.3. Modify or Delete a Network Discovery Profile.....	92
4.2. Manage Wired & Wireless Network Devices.....	94
4.2.1. View Device Information.....	94
4.2.2. Modify Device Information	96
4.2.3. Ping or Reboot Device	99
4.2.4. View and Export an Interface List.....	99
4.2.5. View and Export a Connection List.....	101
4.3. Manage Device Groups.....	102
4.3.1. Add a Device Group	102
4.3.2. Edit or Remove a Device Group.....	103
4.3.3. Remove a Device from a Group.....	104
4.4. SNMP Configuration.....	105
4.4.1 Configure SNMP Credentials	105
4.4.2 Test SNMP.....	105
4.4.3. MIBs	106
4.4.4. Monitor Devices with SNMP	106

4.4.5. View Traps and Generate Alarms for Traps	107
4.5. Manage Multiple Networks with Batch Configuration	108
4.5.1 Configuration Categories and Templates	108
4.5.2 Batch Configuration	110
4.5.3. Create Tasks for Batch Configuration	110
5 Monitoring and Reporting	112
5.1. View the Default Dashboard	112
5.2. Switch Dashboard	113
5.3. Wireless Dashboard	113
5.4. Host Dashboard.....	114
5.5. sFlow Dashboard.....	114
5.6. PoE Dashboard	114
5.7. Customize the Dashboard	115
5.7.1. Create a Customized Dashboard	115
5.7.2. Modify a Customized Dashboard.....	118
5.8. View and Export Reports	120
5.9. View Report Settings	122
5.10.View Firmware Version	124
5.11.View D-View 8 Notifications	126
5.12.Monitor Multiple Networks	127
5.12.1 Create Monitor Templates	127
5.12.2 Configure Monitor Settings.....	128
5.12.3 Create Alarm Rules	129
6 Configuration and Firmware	131
6.1. Create Configuration and Profiles	131
6.2. Manage Tasks	136
6.2.1. Current Tasks.....	136
6.2.2 Historical Tasks	137
6.3. Schedule a Firmware Upgrade	138
6.4. Back Up and Restore Device Configuration	141
6.4.1. Add or Modify a Backup Profile	141
6.4.2. Restore Device Configurations.....	143

6.5. File Management.....	144
6.5.1. Firmware Management	145
6.5.2. Configuration Management	149
7 Alarm and Notification.....	154
7.1. View Alarms.....	154
7.2. View Traps and Syslog	155
7.3. Trap Editor.....	157
7.4. Syslog Editor	158
7.5. Monitor and Alarms	159
7.5.1 Alarm Settings.....	159
7.5.2 Monitor Settings	162
7.6. Manage Notifications	163
8 Network Architecture	167
8.1. View and Manage Network Topology.....	167
8.2. Create a Topology View.....	170
9 Rack Groups and Devices.....	172
9.1. Add a Rack Group	172
9.2. View and Modify a Rack Group	175
10 sFlow Monitoring	179
10.1. Configure sFlow Monitor.....	179
10.2. Manage sFlow Monitor	183
10.3. Configure sFlow in Supported Devices	184
10.4. sFlow Network Monitor	186
10.5. View and Export sFlow Monitoring Results	188
189	
11 Templates.....	189
11.1 Generate Device Templates	189
11.2 Manage Device Vendor and Device Type.....	190
11.3 Generate Panel Templates.....	191
11.4 Generate Monitor Templates	192
11.5 Generate Configuration Templates.....	194

12 Reports	197
12.1 Generate Scheduled Reports and My Reports	197
12.2 Manage Report Templates	199
12.2.1. Add a Report	201
12.2.2. Modify a Report	202
12.3 View and Remove Reports	204
13 Users and Security Profiles	205
13.1 Profile Role Types	205
13.2 Authentication.....	207
13.2.1. Join an AD Server	207
13.3 Add a User Profile	208
14 System Settings	211
14.1 Configure Global Settings.....	211
14.2 Scheduling.....	224
14.3 Licenses	226
14.4 View D-View 8 Logs	231
15 Tools.....	232
15.1 MIB Browser.....	232
15.2 MIB Compiler Tool.....	234
15.3 Perform an ICMP Ping.....	236
15.4 Perform an SNMP Test	237
15.5 Perform a Trace Route Test	239
15.6 Configure Network Management from CLI.....	240
15.7 Compare Configuration Files	242
Appendix A: Deployment with Five-server Topology	243
Structure.....	243

1 Introduction

1.1. D-Link D-View 8 Network Management Software

D-View 8 is a comprehensive management tool for both Ethernet and wireless Ethernet designed with the server and probe architecture, supporting troubleshooting, configuration, performance monitoring, and security of your network. It provides end-to-end operational management of IT structure, scalability of the system architecture, and accommodation of new technology that complements the management of D-Link and third-party devices.

D-View 8's offering of standard and enterprise licensing options is sufficient for different network requirements ranging from SMB to Enterprise deployment. Both Standard and Enterprise licenses can manage up to 5000 nodes, and the Enterprise Edition has richer features and supports multiple server probes either locally or remotely across multiple sites and networks.

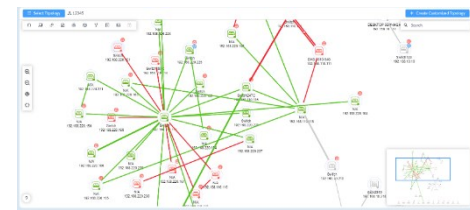
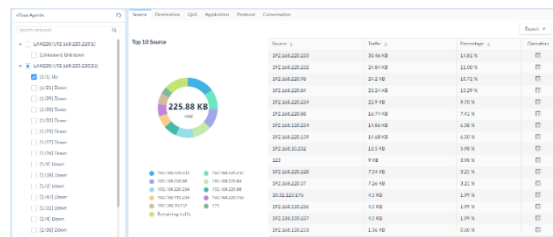
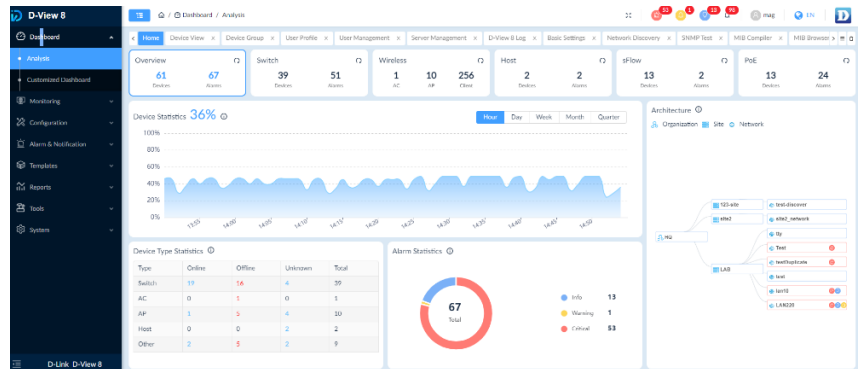

Real-Time Network Analytics

sFlow Analyzer

Role-Based Administration

Intuitive Dashboard

Centralized Reporting

Highly Flexible and Scalable Deployment

Rich Resource Management

Inventory Management

Batch Configuration









Firmware Management

Service Monitoring

1.2. D-View 8 Features

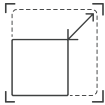
The D-View 8 is a standards-based management tool designed for the centralized management of networks to achieve device availability, reliability, and resilience.

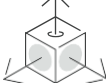
This manual is intended for network administrators. The D-View 8 supports the following features:

D-View 8 Features		
	Real-Time Network Analytics	Real-time network analysis provides insight into network operation. With instant visibility, you can obtain information on device statistics, such as critical alarm events, memory utilization statistics and analysis, response time statistics and analysis, and CPU utilization statistics as well as bandwidth utilization.
	sFlow Analyzer*	Configure sFlow analyzer to detect network anomalies in your organization, especially when the network is large and complex. It helps collect the sFlow data from devices and generate related statistics.
	Role-Based Administration	Allows easy integration of user management with a common authentication system such as Windows AD. User privileges are assigned by role and the access to each network can be individually granted with read or write or both.
	Intuitive Dashboard	The user-friendly dashboard can be customized to your needs for network device overview, device statistics, alarm statistics, CPU/memory utilization, response time, temperature, and much more.
	Centralized Reporting	Provides a wide variety of performance information with templates for resource reporting, including top N resource utilization with respective optional indicators, network device and connection status, traps, and traffic. It also provides options for automatic reports or saving as My Reports.
	Highly Flexible and Scalable Deployment	No matter the scale of your network environment, D-View 8 provides you with a whole suite of network management capabilities and deployment options.
	Rich Resource Management	Provides the exploration and topology of the network, including comprehensive network inventory. Views include both Layer 2 and Layer 3, as well as VLAN topology which can all be customized.
	Inventory Management	Provides holistic management in one place for multi-vendor devices. Monitor key indicators of a network by accessing the device page, which shows real-time data of performance information, connected clients, and more.
	Batch Configuration	Configures multiple devices at the same time by creating tasks with schedules to allow for automatic configuration and rapid deployment.
	Firmware Management	Conveniently upgrades firmware for multiple devices from a centralized location.
	Service Monitoring	Monitors the availability and responsiveness of common network services via probes. The probes reside on local and remote D-View 8 software agents to check the connectivity of servers and devices.
* This feature is only supported on Enterprise Edition.		

NOTE: For the purposes of this manual, the D-View 8 application is referred to as the application. The device on which the application is installed is referred to as the D-View 8 server.

NOTE: For further information about the latest D-View 8 release, see the D-View 8 application information on the D-View 8 website (<https://dview.dlink.com/>).

NOTE: For the latest software updates with new features and bug fixes, visit the D-View 8 website (<https://dview.dlink.com/>). Some devices require regular downloads and update of new software and can do so only through manual update.

1.3. D-View 8 Licenses

License Types	
Standard (DV-800S)	<p>Product license determines the edition of the D-View 8 application.</p> <p>Target Customer: SMB</p> <ol style="list-style-type: none"> Nodes: < 5000 (applicable to D-View 8 Version 2.0.0 and later) D-View 8 server and probe: <ul style="list-style-type: none"> • Single server, no support for redundancy. • Single probe Supports local probe only The Org-Site-Network architecture: <ul style="list-style-type: none"> • Single Organization • Multiple Sites • Multiple Networks Supports limited features. Free maintenance & product support for one year (365 days). Annual renewal will be required to operate with complete functionality without the limitation of 30 nodes and to keep the support contract valid.
Standard Maintenance (DV-800MS)	<p>The maintenance license determines the length of time maintenance service is valid and the support service stops when it reaches the expiration date; however, the D-View 8 application will still be operational with a reduction of manageable nodes.</p> <p>DV-800MS-Y1-LIC DV-800MS-Y2-LIC DV-800MS-Y3-LIC DV-800MS-Y4-LIC DV-800MS-Y5-LIC (Y1=365 days, Y2=730 days, Y3=1095 days, Y4=1460 days, Y5=1825 days)</p> <p>The above annual maintenance licenses can only be activated on the Standard Software edition.</p>
Enterprise (DV-800E)	<p>Product license determines the edition of the D-View 8 application.</p> <p>Target Customer: Enterprise.</p> <ol style="list-style-type: none"> Nodes: <5000 D-View 8 server and probe: <ul style="list-style-type: none"> • Supports 2 servers and HA (high availability) • Multiple probes (up to 20) Supports both local and remote probes. The Org-Site-Network architecture: <ul style="list-style-type: none"> • Single Organization • Multiple Sites • Multiple Networks Supports all features including advanced development and

	<p>management tools:</p> <ul style="list-style-type: none"> • REST API (full graphic user interface) • sFlow Analyzer • HA (MongoDB cluster, NLB/Keepalived) • MIB Browser and Compiler <p>6. Free maintenance & product support for one year (365 days). Annual renewal will be required to operate with complete functionality without the limitation of 30 nodes and to keep the support contract valid.</p>
Enterprise Maintenance (DV-800ME)	<p>The maintenance license determines the length of time maintenance service is valid and the support service stops when it reaches the expiration date; however, the D-View 8 application will still be operational with a reduction of manageable nodes.</p> <p>DV-800ME-Y1-LIC DV-800ME-Y2-LIC DV-800ME-Y3-LIC DV-800ME-Y4-LIC DV-800ME-Y5-LIC (Y1=365 days, Y2=730 days, Y3=1095 days, Y4=1460 days, Y5=1825 days)</p> <p>The above annual maintenance licenses can only be activated on the Enterprise Software edition.</p>
<p>Notes:</p> <ol style="list-style-type: none"> 1. Licensing only allows the upgrade from Standard to Enterprise but not the other way around. 2. When the maintenance license expires (free for the 1st year of product purchase), D-View 8 will be limited to 30 nodes without an annual maintenance license; functions such as Device View, Topology Map, Batch Configuration, Firmware Management, and Configuration Management will be restricted to only 30 nodes with full functionality. Refer to 14.3 Licenses for more information. 3. If you have remote probes in D-View 7, it is strongly recommended that you upgrade the system to D-View 8 Enterprise so that remote probes can be upgraded and maintained. 	

1.4. 90-Day Free Trial

Network administrators need advanced tools to help maintain and manage their network systems. D-Link stays at the competitive edge of innovation and is fully committed to continuous development of cutting-edge applications to match growing demands.

Download the D-View 8 application and test it free for a total of 90 days no matter the version of edition of the application. The current version of the application is available for download at <https://dview.dlink.com/>. After the trial period, you will be prompted to enter your activation information. Refer to **Chapter 2 Installation** for activation options and procedure.

1.5. D-View 8 Server System Requirements

Server Requirements	
CPU	Quad-core, 3.5 GHz or above
RAM	16 GB or above
Storage	200 GB or above
Supported OS (English version only)	<ul style="list-style-type: none"> • Windows Server 2016 64-bit (Standard Edition or above with the latest version) • Windows Server 2019 64-bit (Standard Edition or above with the latest version) • Windows Server 2022 64-bit (Standard Edition) • Windows 10 64-bit (Professional Edition or above with the latest version) • Windows 11 64-bit (Professional Edition or above with the latest version) • Ubuntu 18.04 64-bit or above • Debian 10 64-bit or above
Database	MongoDB 4.0 or above
Web Browser	<ul style="list-style-type: none"> • Microsoft Edge • Firefox • Chrome • Safari

1.6. D-View 8 Remote Probe Requirements

Remote Probe Requirements	
CPU	Dual-core, 3.0 GHz or above
RAM	4 GB or above
Storage	200 GB or above
Supported OS (English version only)	<ul style="list-style-type: none"> • Windows Server 2016 64-bit (Standard Edition or above with the latest version) • Windows Server 2019 64-bit (Standard Edition or above with the latest version) • Windows Server 2022 64-bit (Standard Edition) • Windows 10 64-bit (Professional Edition or above with the latest version) • Windows 11 64-bit (Professional Edition or above with the latest version) • Ubuntu 18.04 64-bit or above • Debian 10 64-bit or above
Management Capability	500 nodes

1.7. D-View 8 Client Requirements

Client System Requirements	
Web Browser	<ul style="list-style-type: none"> • Chrome • Firefox • Safari • Edge
CPU	Dual-core, 3.0 GHz or above
RAM	4 GB or above
Storage	100 GB or above

1.8. Network Environment Models

The application resides on the D-View 8 server with a static IP address on the local area network (LAN).

The D-View 8 application manages both D-Link and third-party devices on the network.

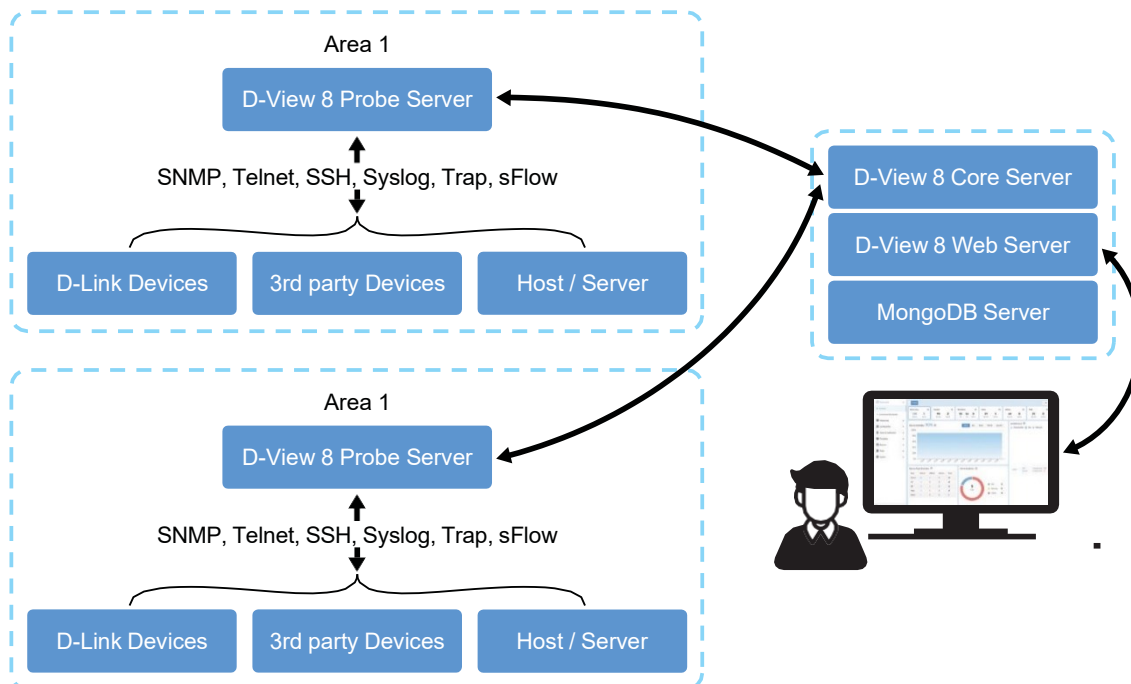

The D-View 8 application is accessed through a web browser. If the IP address cannot be accessed locally, access to the specific network must first be configured.

The application supports the following devices:

- D-Link devices support SNMP protocol. For further information about supported D-Link devices including model numbers, visit the D-View 8 website (<https://dview.dlink.com/supportedModel>).

1.9. Device Groups

Network management (e.g. firmware upgrade) is simplified with the use of the device group function of the D-View 8. Groups can be identified by site, network, location, device type or other device properties.

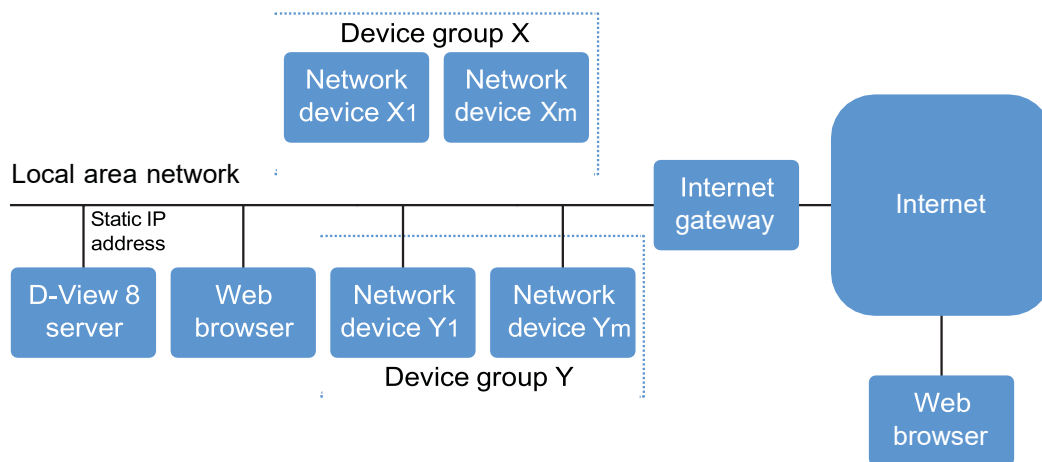

1.10. User Authentication Types

User authentication for the D-View 8 application can be accomplished in three methods. By associating an authentication profile to a user, privileges can be granted to users with restricted access to specific networks. The following are these types of authentication methods:

- Local: user account authenticated on a local system.
- Active Directory: user account authenticated by the Microsoft Management Console.

1.11. Prepare Network Devices for Discovery

Preparing a device on your network for management requires setup and configuration.

To prepare a device for network discovery:

1. Enable SNMP and configure the community's name and associated read/write privilege.
2. Make sure that the device on the network has a valid IPv4 setting.

1.12. Start D-View 8

Please read **Chapter 2: Installation** and **Chapter 3: Overview and Basics** prior to using the D-View 8 system to understand the basic system configuration and device discovery procedure.

2 Installation

The D-View 8 software supports installation on a Linux or Windows operating system. The following sections provide guidance for software installation on both platforms.

To begin the installation process, download the D-View 8 setup application from the D-View 8 website (<https://dview.dlink.com/>). It provides setup assistance with wizard to guide you through the installation process.

2.1. Requirements

See 1.5 [D-View 8 Server System Requirements](#) for minimum hardware and software required to install and run the application on Windows and Linux.

2.2. Windows Installation

2.2.1. Standalone Edition Installation

To begin the installation process, download the software package.

1. Locate the software package and double-click it to start the installation wizard.
2. The Installation Wizard page displays. Click **Next** to continue the installation process.



3. The License Agreement page displays. Review the terms and click **I Agree** to continue. Otherwise, click **Back** or **Cancel** to restart the process.

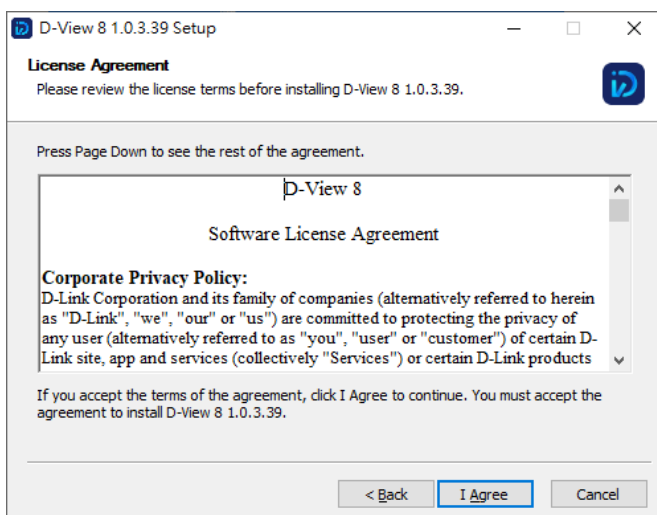

4. The Port Configuration page displays. In the **MongoDB Type** field, click the drop-down menu and select **Standalone**.
5. In the Server IP field, select the local IP address.
6. Click **Check** to test the service port availability. The green Check Pass! displays to indicate correct configuration.
7. Click **Next** to continue.

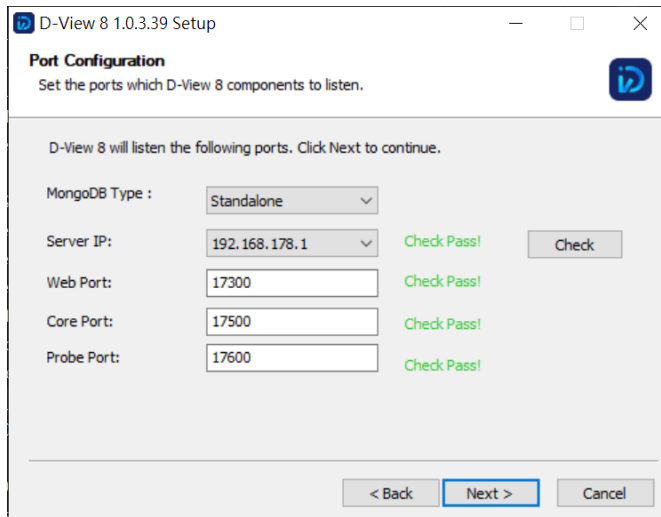

D-View 8 requires a database such as MongoDB. You can select to install a new database or use an existing one as explained in the following options.

To install a new MongoDB database:

- a. Select Install a new MongoDB.
- b. Click **Next** to continue.

To access the database, a username and password must be assigned. In the MongoDB Port field, enter the designated port to access the database.

- c. Enter the username and password for database authentication.
- d. Click **Next** to continue the process.

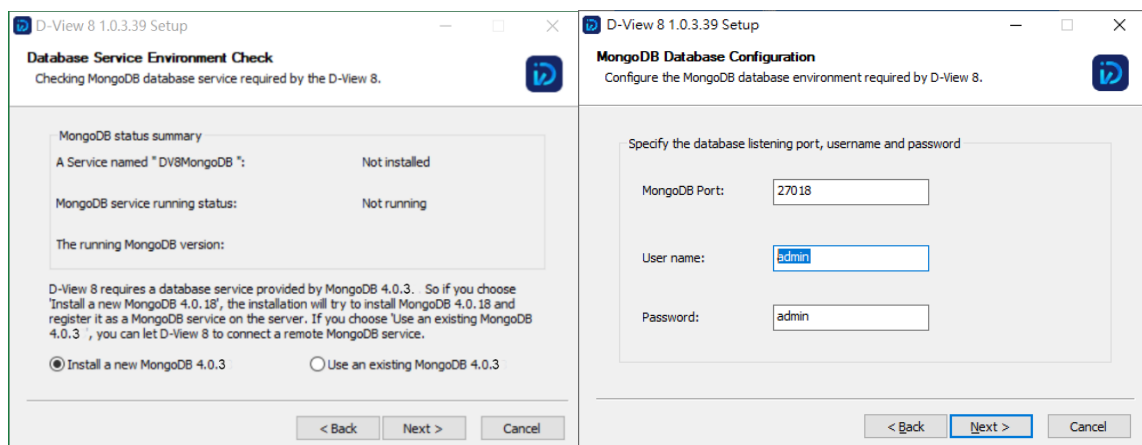

To use an existing MongoDB database:

- a. Select **Use an existing MongoDB**.
- b. Click **Next** to continue.

Then provide the required settings to access the existing database.

- c. In the MongoDB Address field, enter the IP address and port of the database.
- d. Select Password Authentication if the database requires a username and password to access.
- e. Enter the username and password of an account with authority to access the database.
- f. Click **Check Connection** to test the settings.

If the settings are configured properly, the **Next** button is enabled.

If the connection fails, check the settings and enter the related information again.

- g. Click **Next** to continue the process.

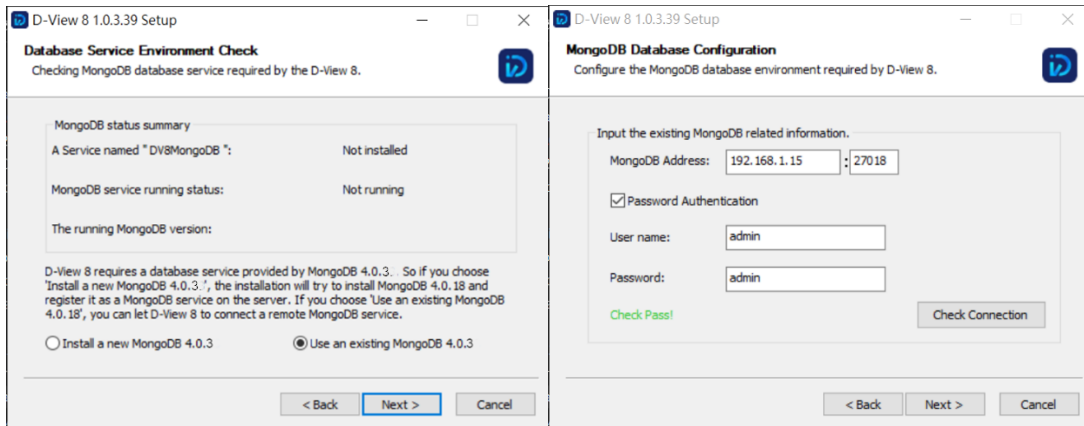

The Choose Install Location page displays.

8. In the Destination Folder field, click **Browse** to select the destination folder, then click **Next** to continue.
9. Click **Install** to continue or **Back** to return to the previous page or **Cancel** to restart the process.

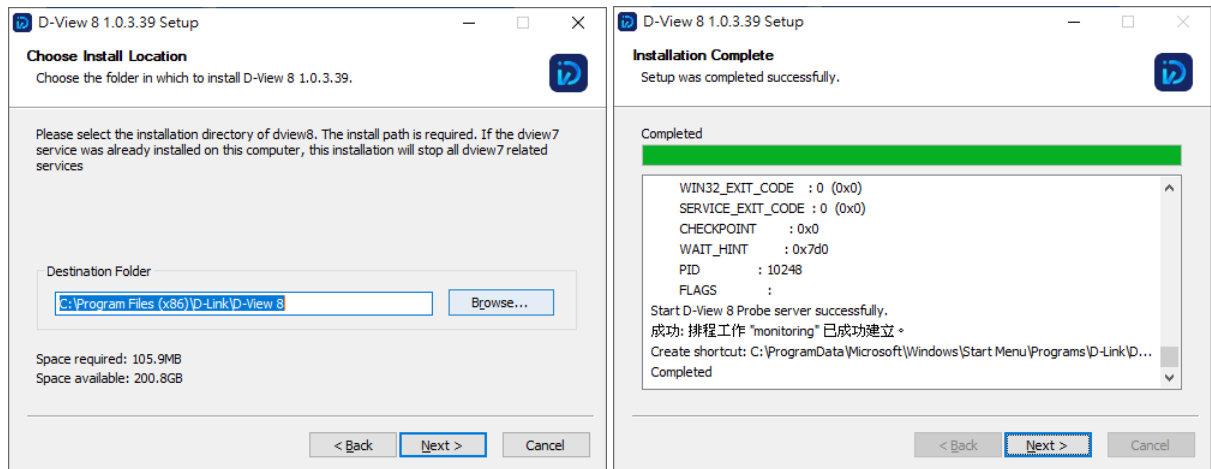

Once the installation process is completed, the Setup Wizard page displays.

10. Select Launch D-View 8 and click **Finish** to open the application interface using the default browser.



If this is the first time that you open the application, more login details will be presented. You can opt to enter an activation code or use a trial account.

11. In the username and password fields, enter the following default values: admin (username), admin (password).

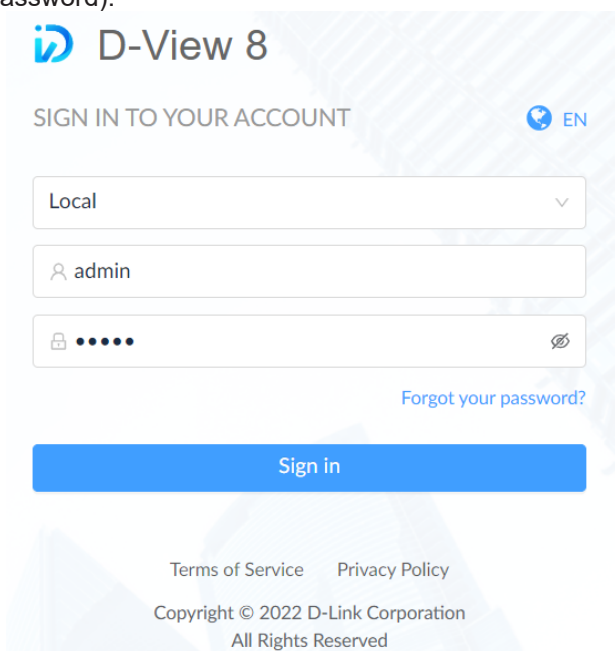

The Add License page displays. From this screen, you can set a preferred language (default: English).

For Activation, select a license type to activate, or click **Start Trial** to activate a trial license.

- Online Activation: enter the license key as provided to activate the application software. The server must be connected to the Internet for this function to authorize a license.
- Offline Activation: locate the activation file as provided to activate the application software. The function is available when the server is not connected to the Internet.
- Start Trial: try the application for 90 days. You can download the trial from the D-View 8 website ([https://dview.dlink.com/.](https://dview.dlink.com/))

12. Click **Next** to continue.

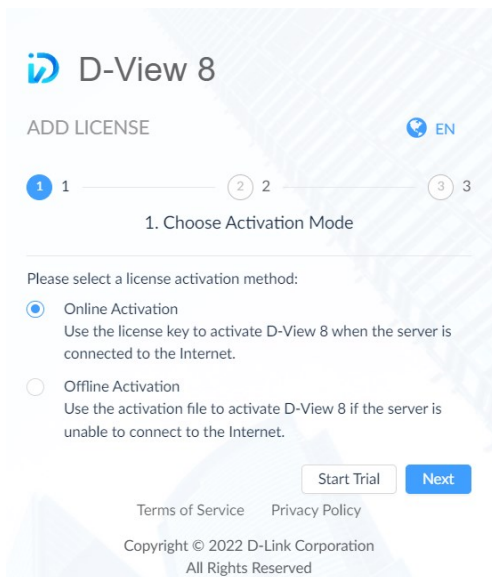

The D-View 8 Wizard page displays. The available configuration options are based on the account privilege:

- D-View 7 Upgrade: Migrate the D-View 7 database and probes to the current application.
- Discovery: Discover available networks and connected devices.
- Monitoring: Create topologies, rack simulations, and dashboard to help monitor the network.
- Alarm: Configure notifications and alarms.

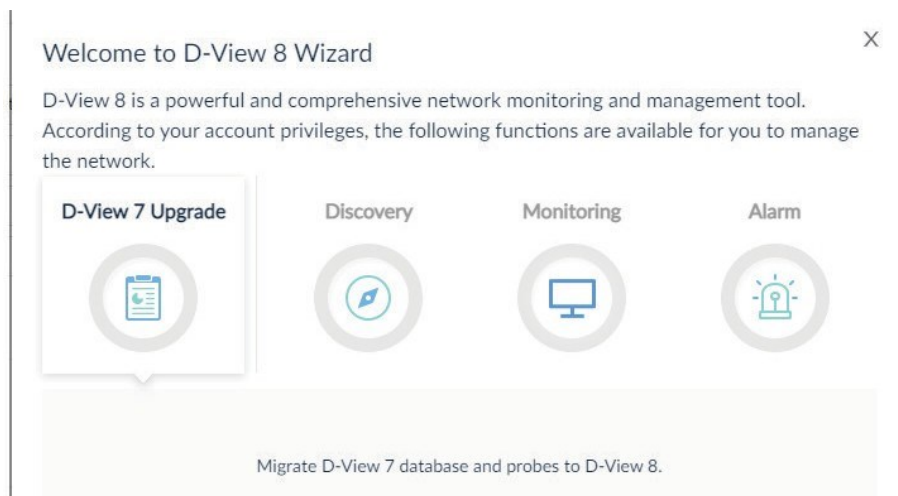

NOTE: Please follow the wizard's guidance to set up an organization first. It is required for the subsequent Network Discovery to perform properly.

Once the installation is complete, the user Dashboard displays.

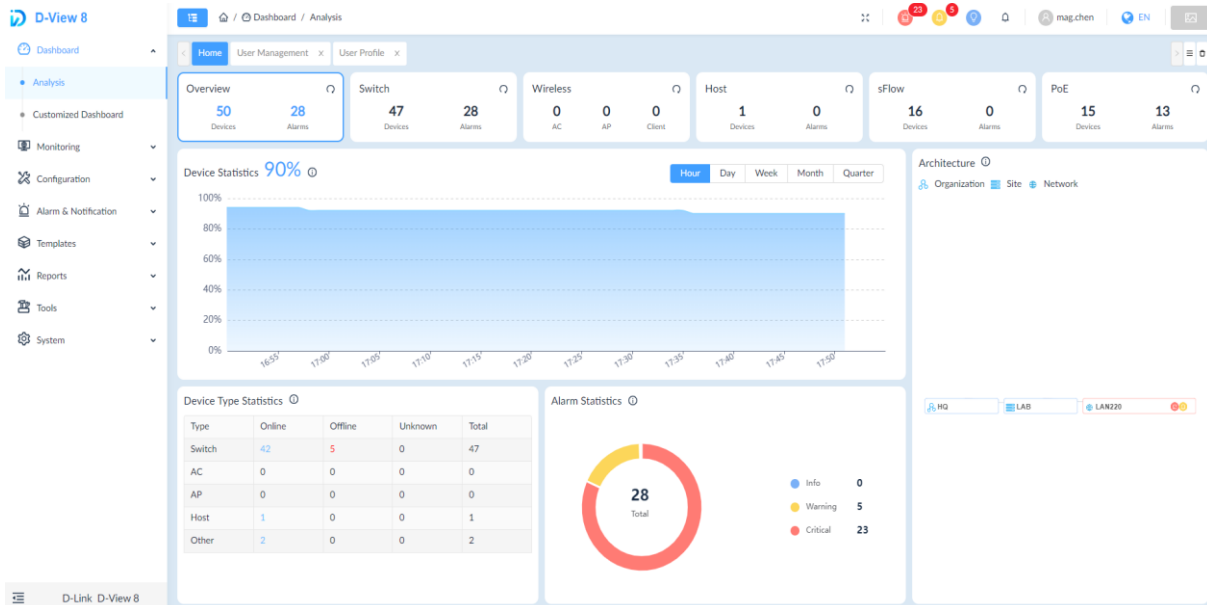

2.2.2. Cluster Mode Installation (Only Available for Enterprise Edition)

Cluster Architecture

The D-View 8 supports data redundancy and load balancing features. The following diagram depicts the cluster architecture.

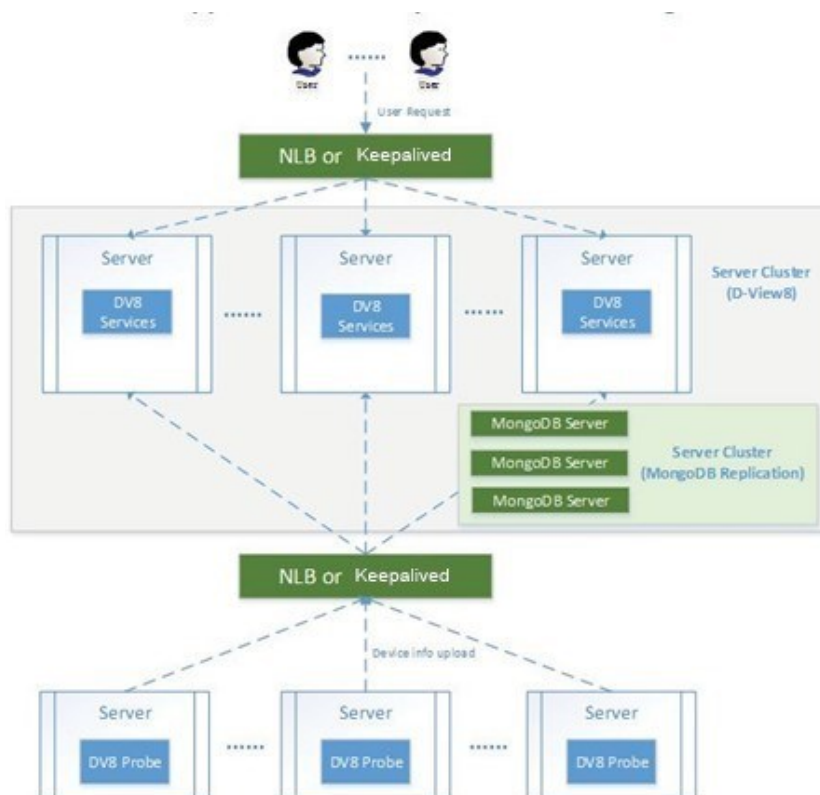

The following shows the structure of D-View 8 application and MongoDB. The structure includes a primary, secondary, and an arbiter database. The application connects to both the primary and secondary database.

A primary database may be reassigned as the secondary while the secondary may also become the primary. By default, clients read from the primary database, but a read preference can be configured to allow read operations on the secondary database.

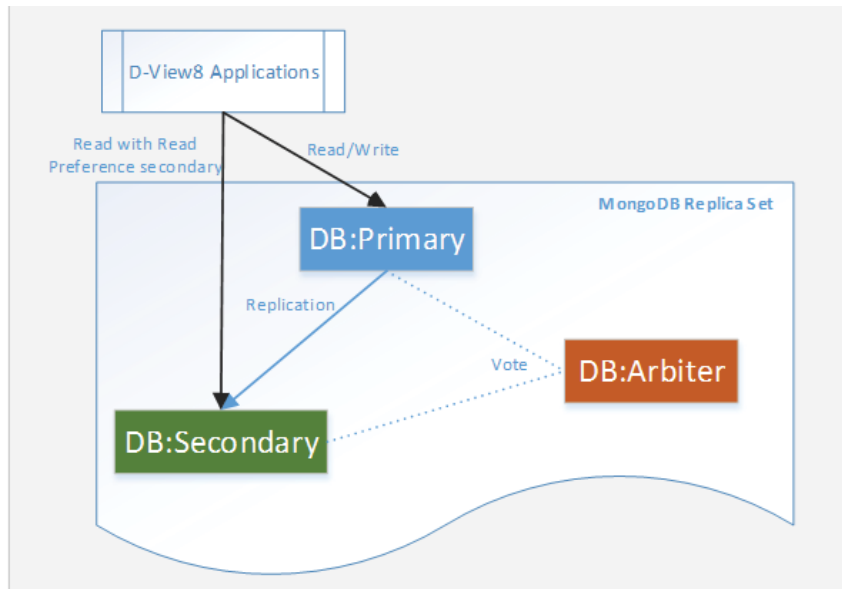

Building a Cluster

Clusters help support data redundancy and load balancing. Building clusters is outlined in this section.

First, Install MongoDB on 3 Windows servers with the designated roles to support the above mentioned structure.

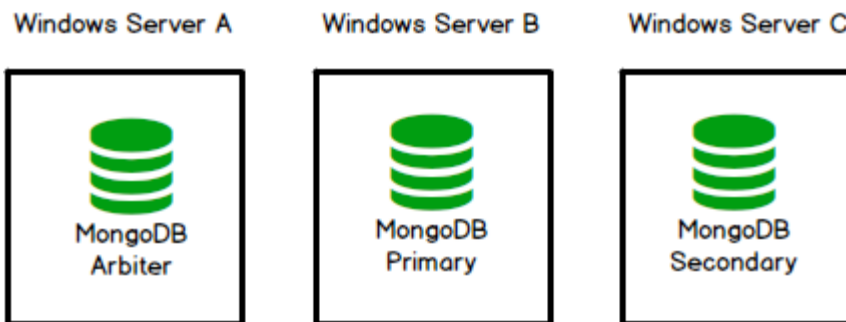

Deploy D-View 8 on additional servers and connect the D-View 8 application to the MongoDB cluster.

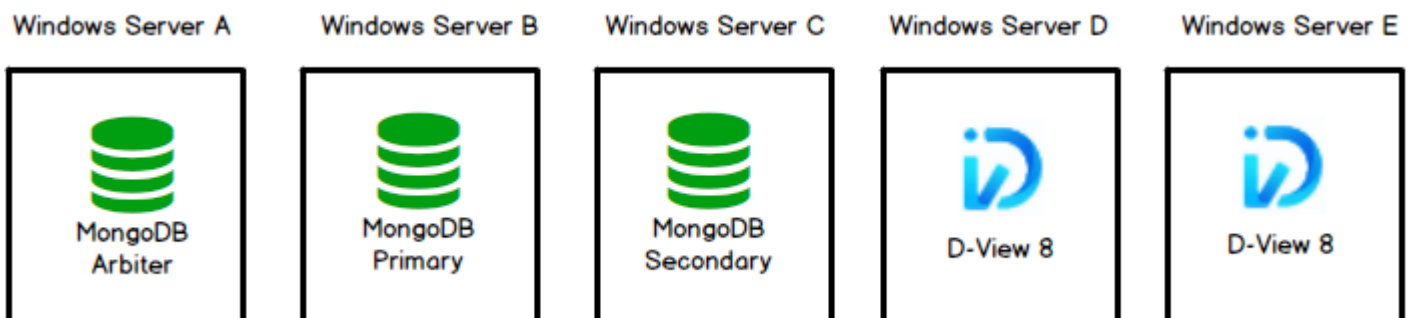

Then, enable NLB on Windows to support server load balancing:

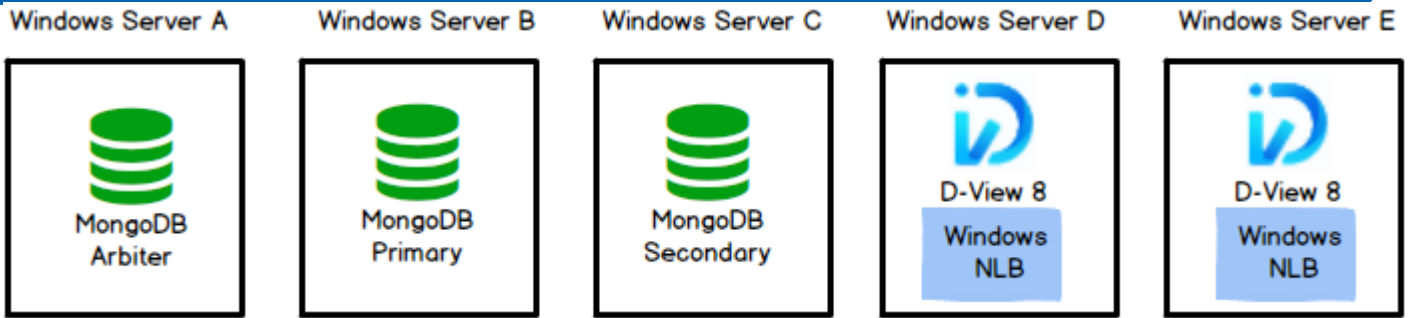

NOTE: You may opt to install D-View 8 on the primary and secondary database in lieu of additional servers. The following diagram depicts this three-server deployment topology:

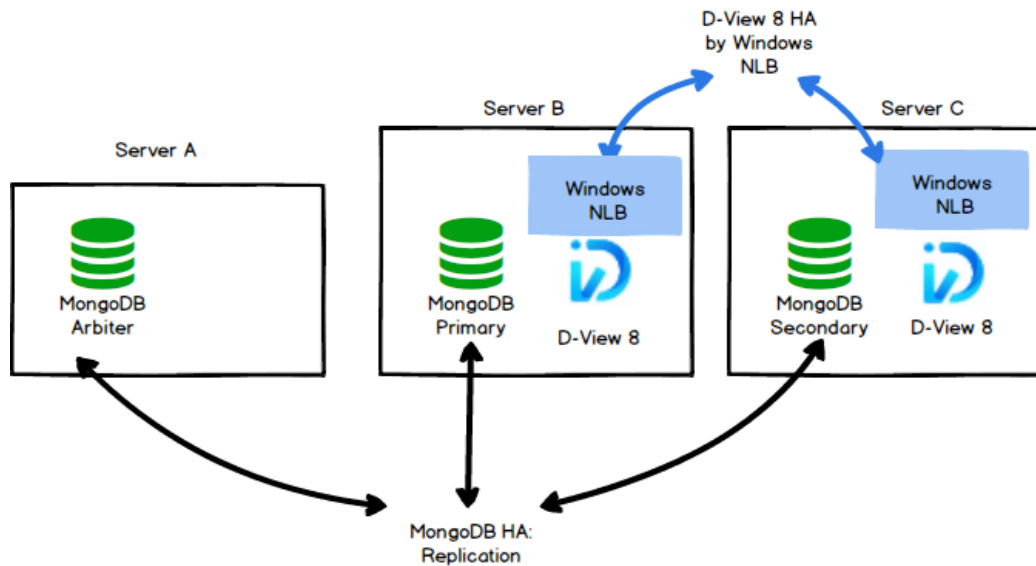

To manage additional devices through Windows servers, you need to add probes in these servers to enable the connection to the D-View 8 servers with load-balancing managed by NLB.

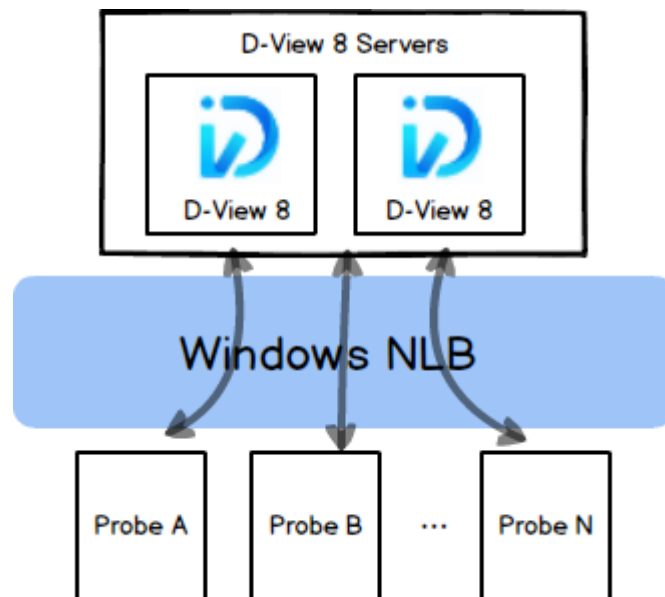

NOTE: The following example demonstrates the deployment of three-server topology; for deployment example of five-server topology, refer to **Appendix A: Deployment with Five-server Topology**.

Preparation for Three-server Deployment

When planning for server cluster deployment, you must first set up 3 Windows servers with the following system configuration:

- SERVER A

OS: Windows 10, Windows Server 2016/ Windows Server 2019

MongoDB

IP Address: 192.168.1.203

Replica set role: arbiter

- SERVER B

OS: Windows Server 2016/ Windows Server 2019

MongoDB

IP Address: 192.168.1.201

Replica set Role: primary

NLB enabled with virtual IP: 192.168.1.200

- SERVER C

OS: Windows Server 2016/ Windows Server 2019

MongoDB

IP Address: 192.168.1.202

Replica set Role: secondary

NLB enabled with virtual IP: 192.168.1.200

Data Redundancy Support on the MongoDB Server Cluster

This section details the steps to install the required MongoDB database and enable data redundancy in the database cluster.

MongoDB Cluster Installation

To install MongoDB in the database cluster:

1. Download the D-View 8 MongoDB installation package (e.g. D-View 8 MongoDB_2.0.0.26_Installation.exe) from the [D-View 8 website](#).
2. Install the package on server, A, B, and C.
3. On the Connection Configuration page, select **Replication** in the MongoDB Type drop-down menu.
4. Enter the MongoDB port number for server communication.

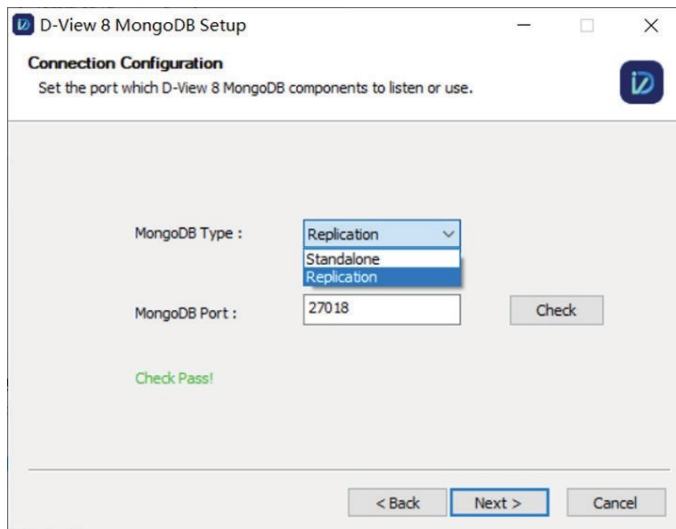

5. Click **Check** to test the setting. If it is configured correctly, a **Check Pass!** notification displays. If the test fails, verify the port setting and try again.
6. Click **Next** to continue and the installation should start.

D-View 8 Installation

D-View 8 can be deployed in three-server or five-server topology as illustrated above.

Use the following procedure to install D-View 8 on multiple servers (e.g. server B & C) and connect them to the MongoDB cluster.

Installation on server B:

1. Download the D-View 8 Installation package (e.g. D-View 8_1.0.0.70_Installation.exe) from the [D-View 8 website](#).
2. Install the package.
3. In the Port Configuration page, select **Replication** in the MongoDB Type menu.
4. In the Server IP field, enter the host server's IP address. As for our example, 192.168.1.201.
5. For port settings, enter the port number required for web access, core communication, and probe communication: 17300, 17500, and 17600.

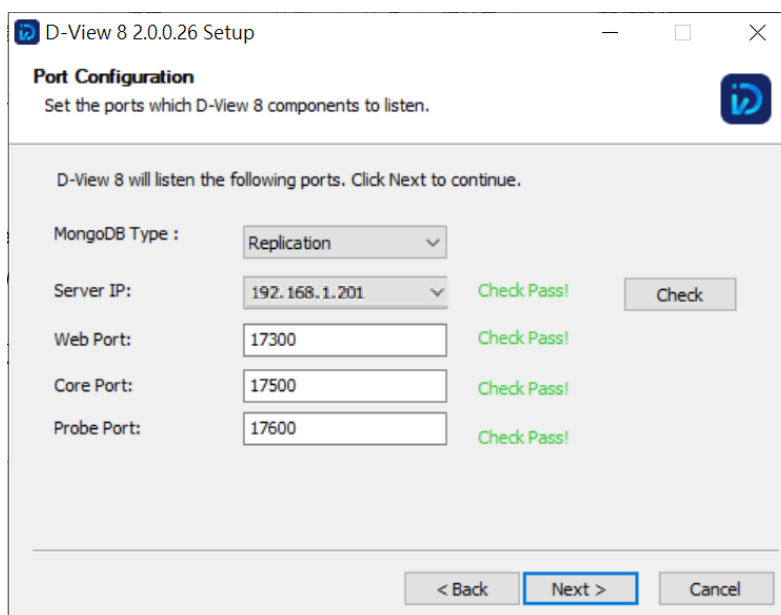

6. Click **Check** to test the settings. If configured correctly, a **Check Pass!** notification displays. If the test fails,

verify the port settings and try again.

- Click **Next** to continue.
- The MongoDB Database Configuration page displays. Enter the IP address and port number for the primary, secondary and arbiter database.

D-View 8 2.0.0.26 Setup

MongoDB Database Configuration
Configure the MongoDB database environment required by D-View 8.

The Primary: receives write and read operations.
The Secondary: become a primary if the current primary becomes unavailable.
The Arbiter: decide the secondary to upgrade as a primary after the primary is unavailable.

Primary: :

Secondary: :

Arbiter: :

- Click **Check** to test the settings. If configured correctly, a **Check Pass!** notification displays. If the test fails, verify the settings and try again.
- Click **Install** to continue.
- Once the installation completes, click **Finish** to close the Setup Wizard.
- The D-View 8 Server can be accessed using a web browser on the server.

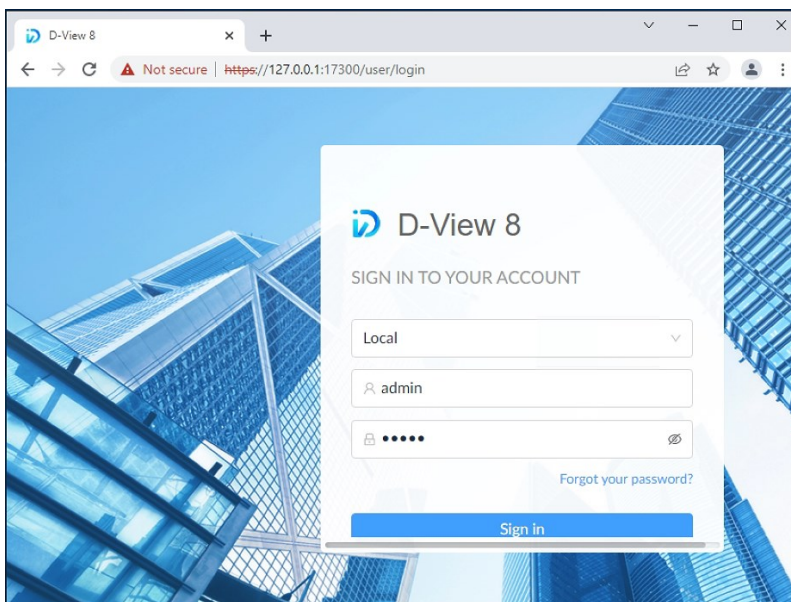

Installation on server C:

1. Download the D-View 8 Installation package (e.g. D-View 8_1.0.0.70_Installation.exe).
2. Install the package.
3. In the Port Configuration page, select **Replication** in the MongoDB Type menu.
4. In the Server IP field, enter the host server's IP address. As for our example, 192.168.1.202.
5. For port settings, enter the port number required for web access, core communication, and probe communication: 17300, 17500, and 17600.

6. Click **Check** to test the settings. If configured correctly, a **Check Pass!** notification displays. If the test fails, verify the port settings and try again.
7. Click **Next** to continue.
8. The MongoDB Database Configuration page displays. Enter the IP address and port number for the primary, secondary and arbiter database.

9. Click **Check** to test the settings. If configured correctly, a **Check Pass!** notification displays. If the test fails, verify the settings and try again.
10. Click **Install** to continue.
11. Once the installation completes, click **Finish** to close the Setup Wizard.
12. The D-View 8 Server can be accessed using a web browser on the server.

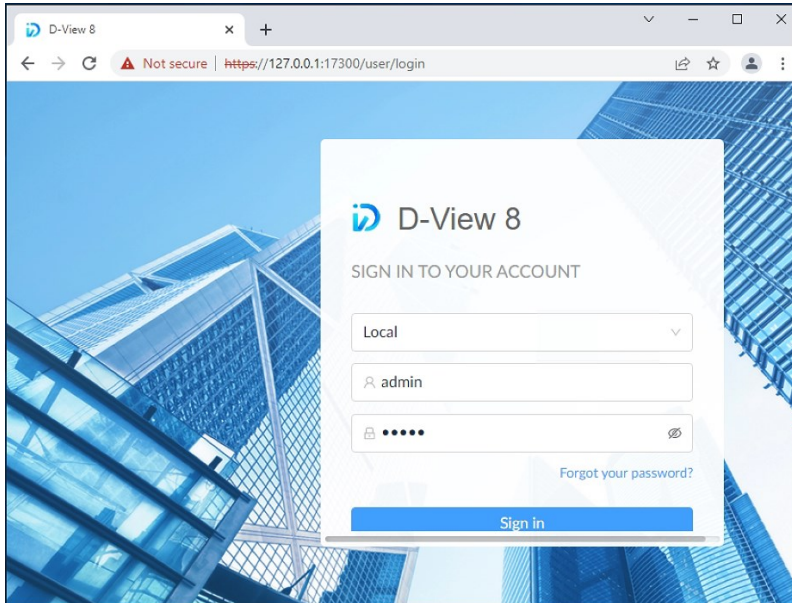

Network Load Balancing Setup on D-View 8 Servers

Server load balancing is supported on D-View 8. At least two Windows servers on the same subnet will be required to configure load balancing. For our deployment demonstration of three-server topology, use the following procedure to set up NLB on D-View 8 servers.

To set up NLB on server B & C:

1. Install the Network Load Balancing service on both server B & C.

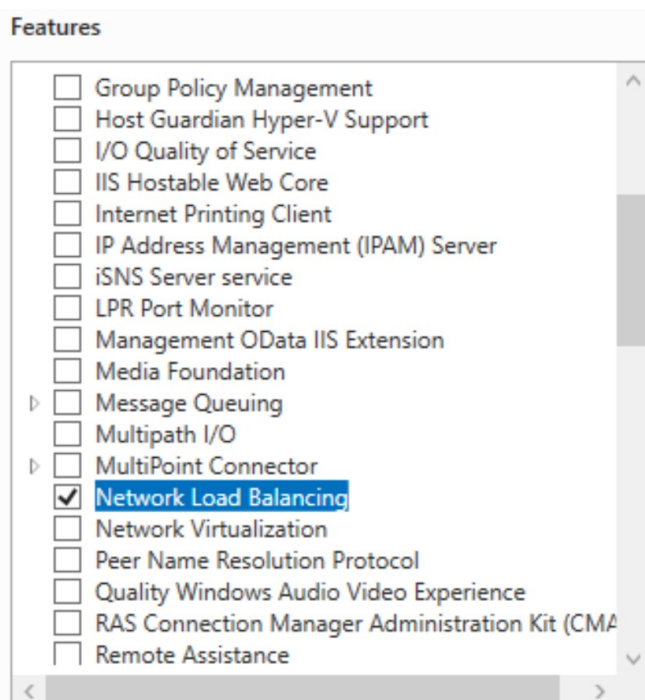

2. Start Network Load Balancing Manager on both servers. Then use the following procedure to configure them individually.

Configuration on server B

1. In NLB Manager, click **Cluster > New** to create a new cluster.

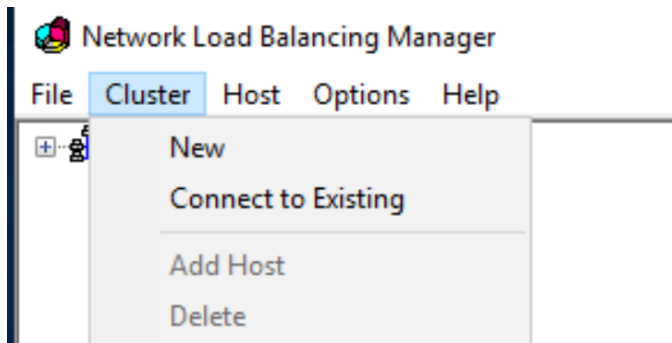

2. In the Host field, enter the IP address of server B: 192.168.1.201 and click the **Connect** button.

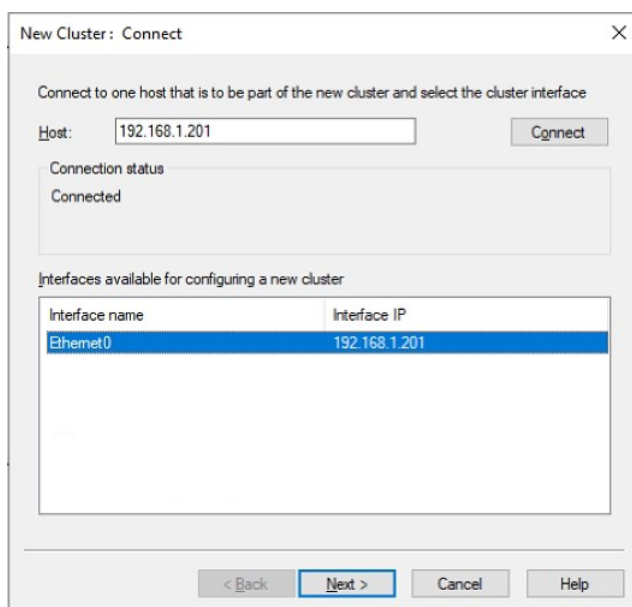

3. Click **Next** to continue. The New Cluster: Host Parameters page displays.

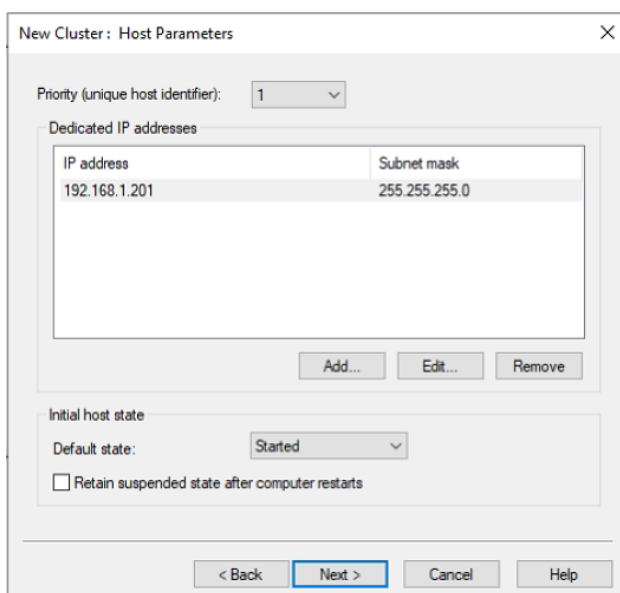

4. Click **Next** to continue. The New Cluster: Cluster IP Addresses page displays.

New Cluster: Cluster IP Addresses

The cluster IP addresses are shared by every member of the cluster for load balancing. The first IP address listed is considered the primary cluster IP address and used for cluster heartbeats.

Cluster IP addresses:

IP address	Subnet mask

Add... Edit... Remove

< Back Next > Cancel Help

5. Click **Add** to enter a Virtual IP address and subnet mask that will be used as the cluster IP and netmask. Click **OK** to continue.

The cluster IP addresses are shared by every member of the cluster for load balancing. The first IP address listed is considered the primary cluster IP address and used for cluster heartbeats.

Cluster IP addresses:

Add IP Address

Add IPv4 address:

IPv4 address: 192.168.1.200

Subnet mask: 255.255.255.0

Add IPv6 address:

IPv6 address:

Generate IPv6 addresses:

Link-local Site-local Global

OK Cancel

< Back Next > Cancel Help

6. Select **Multicast** for **Cluster Operation Mode** for optimal performance.

New Cluster: Cluster Parameters

Cluster IP configuration

IP address: 192.168.1.200

Subnet mask: 255.255.255.0

Full Internet name:

Network address: 03:bf:c0:a8:01:c8

Cluster operation mode

Unicast

Multicast

IGMP multicast

< Back Next > Cancel Help

7. Click **Next** to continue to configure the port rules. The Port Rules page displays.

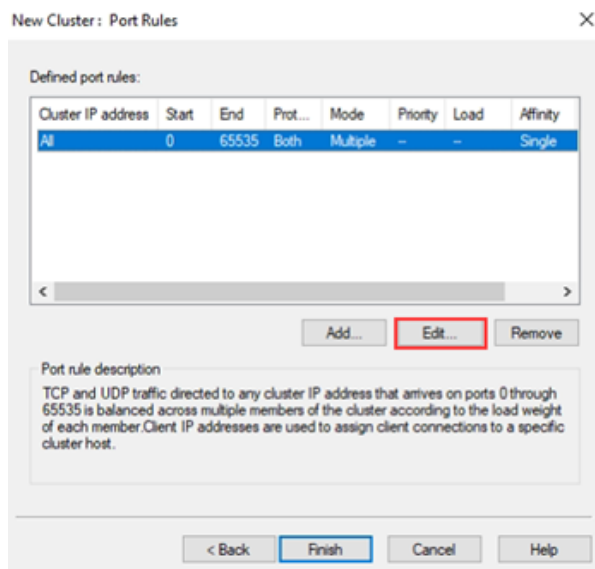

8. Select the defined port rule and click **Edit**. The Add/Edit Port Rule page displays.

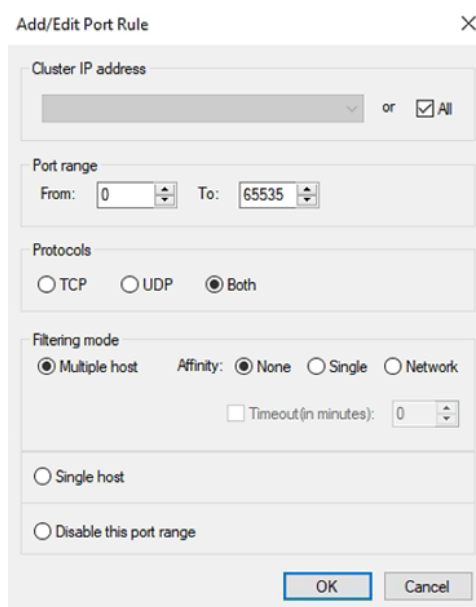

9. In the Filtering mode section, Select **Multiple host** for **Filtering mode** and **None** for **Affinity**. Click **OK** to continue.

10. An NLB cluster will be created as shown below.

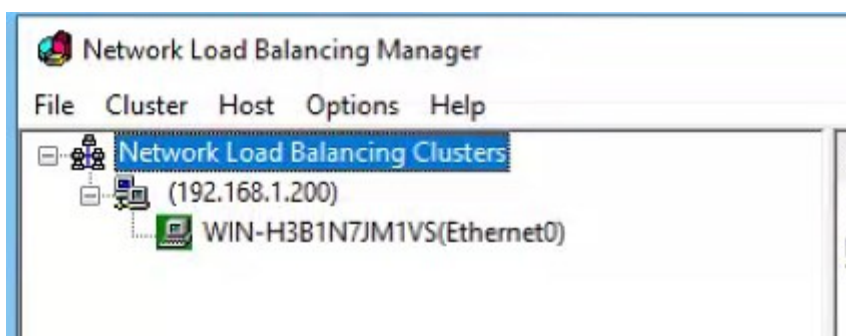

11. Right click on the cluster node and click **Add Host To Cluster**.

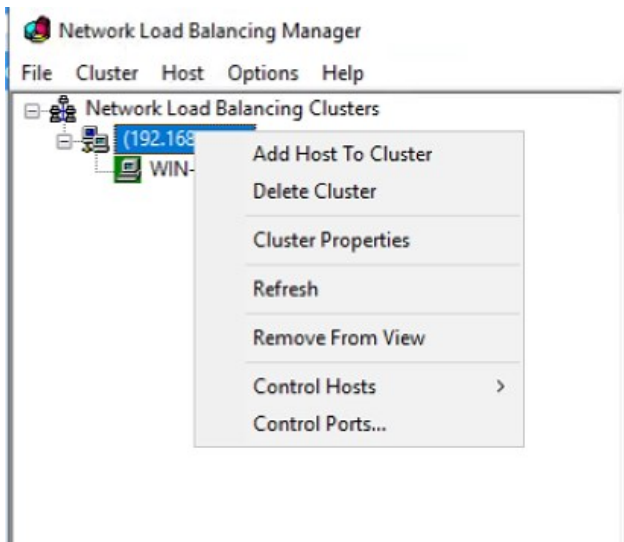

12. Click **Next** to continue.
13. In the Host field, enter the server node 2's IP address.
14. Click **Connect** to establish the connection to the node. The interface will then appear in the Interface pane.

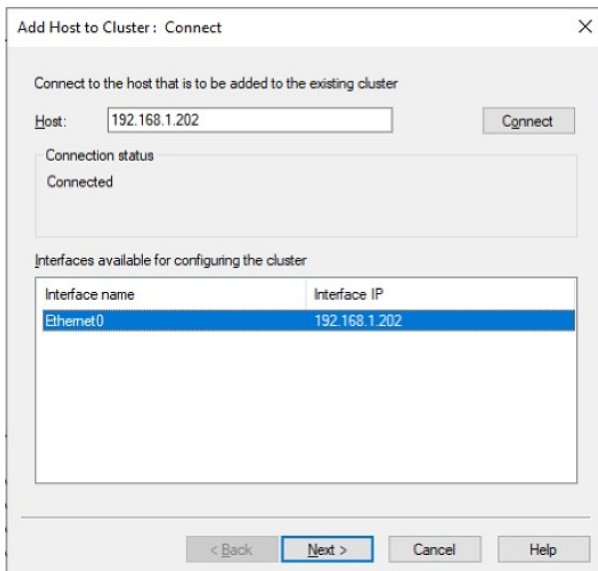

15. Click **Next** to continue.

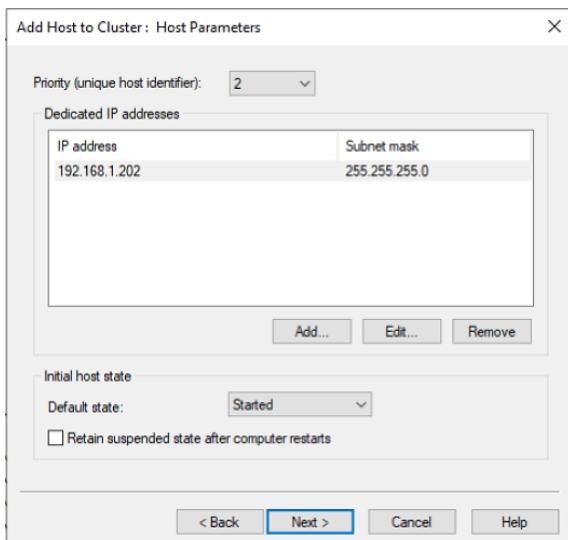

16. Click **Finish** to close the screen.

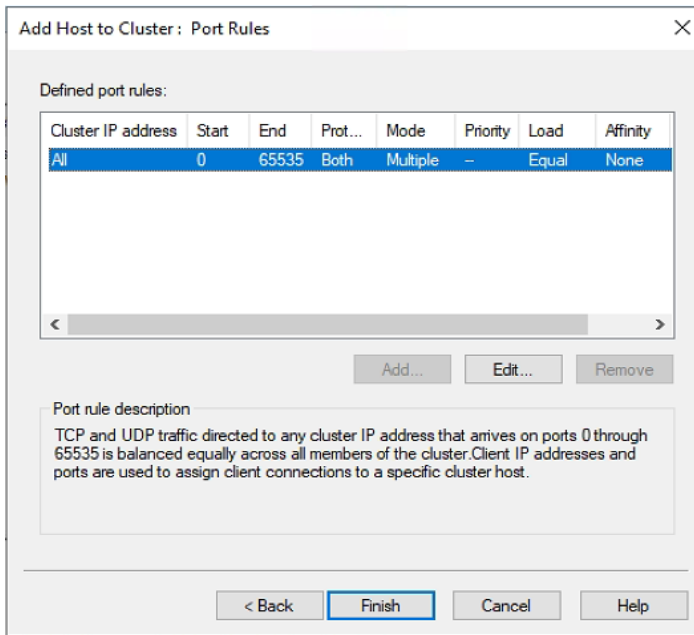

17. Open the Network Load Balancing Manager. Now a cluster containing both server B and C was created.

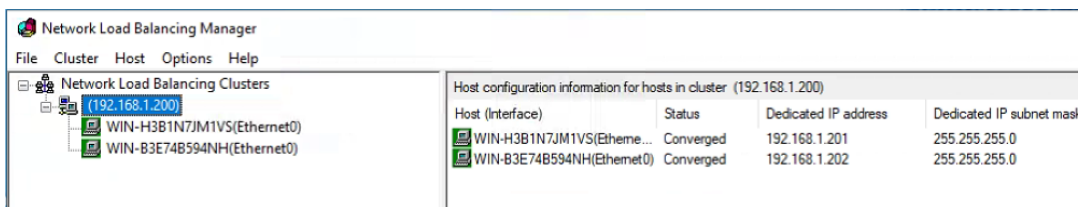

18. And the D-View 8 can be accessed with the Virtual IP.

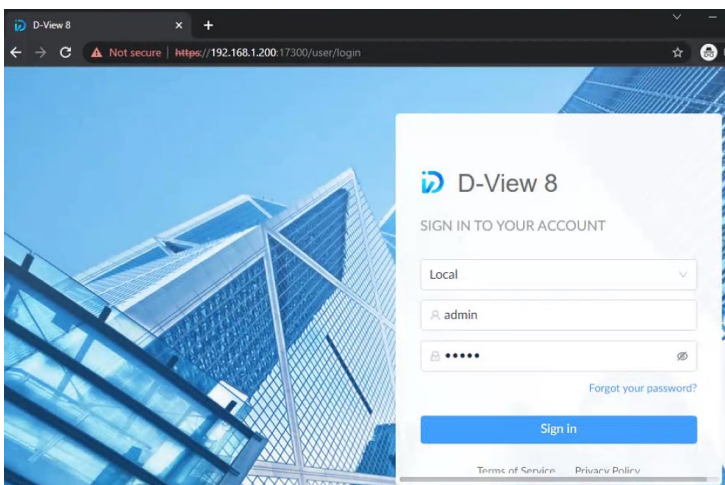

Configuration on Server C

You can also manage the NLB cluster on the other server (C) by configuring NLB with the Network Load Balancing Manager.

1. Go to **Cluster > Connect to Existing**.

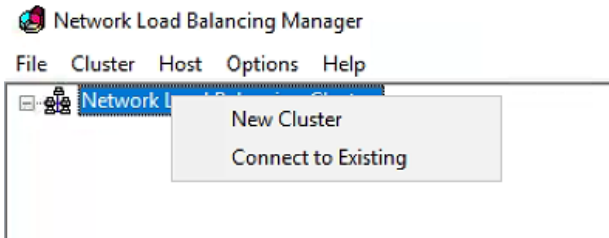

2. Enter the NLB cluster IP: 192.168.1.200 and click **Connect**.

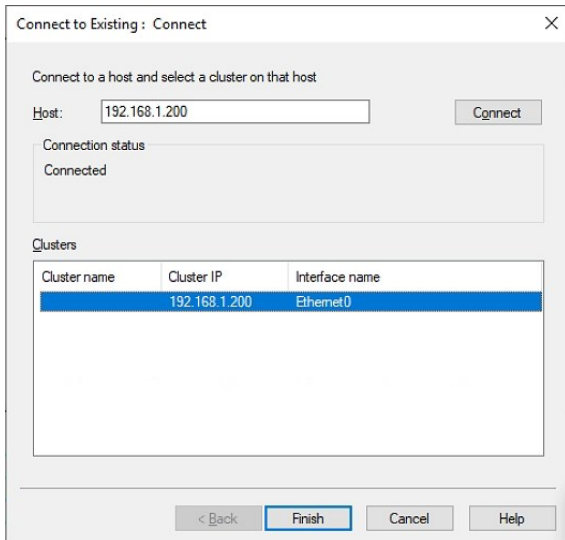

3. The NLB cluster will also be shown on the other server node (C) of the cluster.

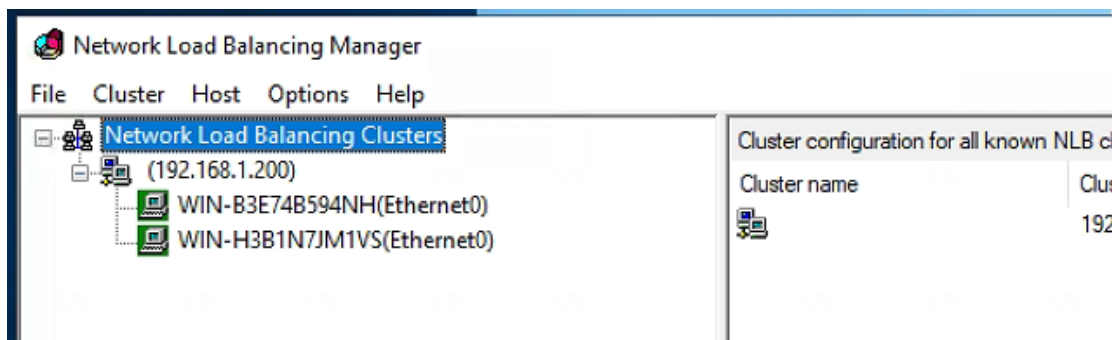

Verify the NLB

Disable the network adapter of one of the server node of the cluster (for example, 192.168.1.201). Then access the connectivity to the cluster by entering the Virtual IP as well as the IP address of the other server node into a browser. The Virtual IP (192.168.1.200) as well as the IP address of the other server node (192.168.1.202) should be accessible but the disconnected server (192.168.1.201) node will not be accessible.

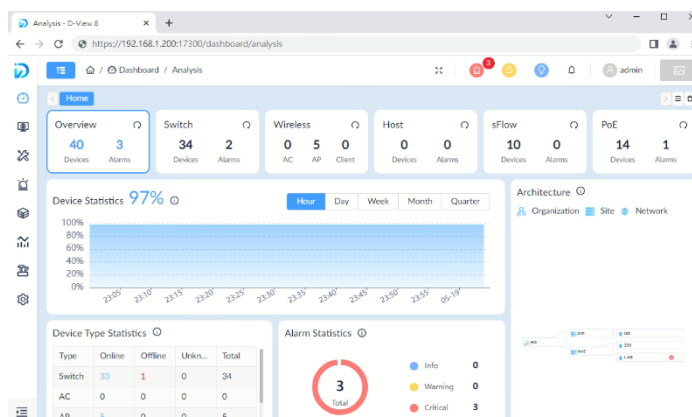

2.2.3. Probe Package Installation

Probes can be installed on a Windows PC. There are two types of Probes:

Local Probe: The Local Probe connects to the D-View 8 Core using the same IP address as the core. It is installed on the D-View 8 server via the D-View 8 Installation package by default.

Remote Probe: The Remote Probe that connects to the D-View 8 Core has a different IP address. It can be installed using the Probe Installation Package.

Mode

Probes can operate with or without high-availability and load-balancing features offered by NLB. With high availability, a remote probe connects to the server cluster via a Virtual IP using port 17500, which is the default port for communicating with the D-View 8 server. Without high availability, a remote probe connects to the D-View 8 server directly using its physical IP address.

The D-View 8 probe installation can be accomplished through the setup wizard. Prior to starting the process, it is recommended that you close all applications to allow for the update of related system files without the need to reboot the system.

1. Download the D-View 8 Probe Setup package from the [D-View 8 website](#) and double-click it to start the wizard. The Probe Setup page displays.
2. Click **Next** to continue the installation process.



3. The License Agreement page displays. Review the license terms prior to installation. Click **I Agree** to continue the process. Click **Back** to return to the previous menu or **Cancel** to stop the process.

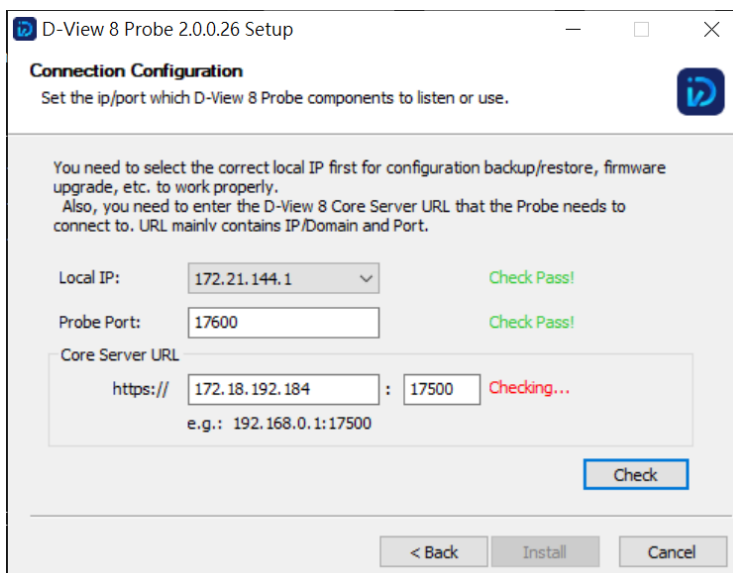

4. The Connection Configuration page displays.
5. Click the Local IP drop-down menu to select the local IP address.
6. In the Probe Port field, enter the port with authorized access to allow probe communication.
7. Enter the Core Server IP of the core D-View 8 server along with the port number.
8. Click **Check** to validate the configuration. A **Check Pass!** message displays if the IP addresses and ports are configured correctly. Otherwise, restart the configuration process.
9. Click **Next** to continue the installation process. The Choose Install Location page displays. Click **Browse** to select the destination folder.
10. Then click **Install** to begin the process.
11. Click **Finish** to end the process when the Completing Setup Wizard page displays.

The Probe Setup process is completed and a shortcut is generated on the desktop containing the following

D-View 8 probe tools:

- D-View 8 Service Management Tool
- Uninstall

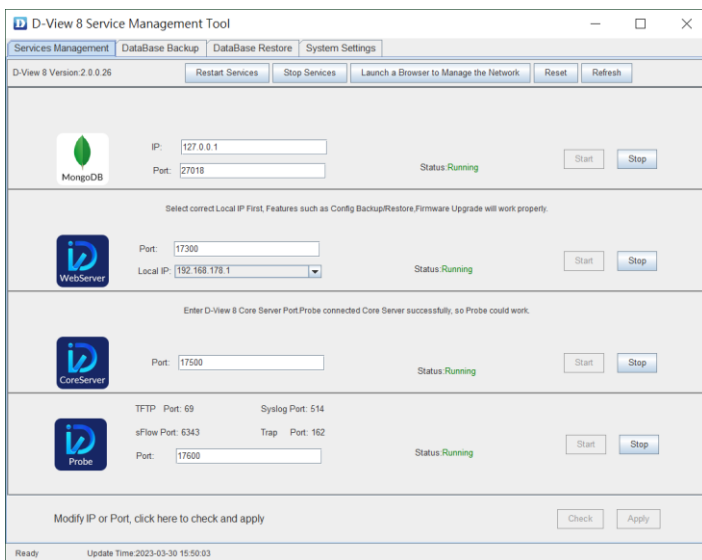

The Service Management Tool allows for management of the probe.

2.3. Linux Installation

2.3.1. Standalone Edition Installation

To begin the installation process, download the installation package.

1. Download the package:

```
DVIEW8_2.0.0.26.deb
```

2. In the root menu enter the following command to select the downloaded package:

```
dpkg -i DVIEW8_2.0.0.26.deb
```

3. At the prompt enter the local IP address:



NOTE: This IP address is for reference only. Please enter the IP address of the local server.

Input the local IP: 172.18.192.256

The D-View 8 application requires a database service (MongoDB) to function. If this is the first time it is being installed, a new database instance must be created.

4. At the prompt, enter 1 to select the standalone MongoDB installation type.

```
You intend to use: 1.standalone MongoDB; 2.MongoDB cluster [1/2]
```

To install a new database instance:

- a. At the prompt, enter y to install a new database instance:

```
If you need to install a new MongoDB. [y/n]
```

Once the installation is initialized, the administrator account for the database must be created. This will continue the process and initialize the built-in data for the D-View 8 instance.

- b. At the username prompt, enter the username for the administrator account:

```
Username: [admin]
```

- c. At the password prompt, enter the admin password. Enter it again for Confirm Password.

```
Password: [admin]
```

```
Confirm Password: [admin]
```

The installation process continues to install the web, core, and probe services. Once the process is completed, the services will be activated.

To use an existing database:

- a. At the prompt, enter n to detect any existing database instances:

```
If you need to install a new MongoDB. [y/n]
```

- b. At the prompt, enter y to configure an existing instance:

```
The system detects that you have MongoDB installed, do you want to use it? [y/n]
```

- c. Enter the IP address and port of the MongoDB instance.

```
Input the existing mongodb IP: 172.18.192.201
```

- d. At the prompt, enter the port of the database instance:

Input the existing mongodb port: 27018



NOTE: The IP address and port information is for reference only. Enter the information of your database configuration.

e. For database authentication, enter y if access is required:

Do MongoDB access require authentication? [y/n]

f. When prompted, enter the username and password to access the database instance.

Username: root

Password: root

5. Once the instance is created or connected, start the application using a web browser.

6. Open a web browser and enter the IP address of the D-View 8 application in the address bar. In the following figure the IP address is shown for the created instance.

```
start web service...
start core service...
start probe service...
----- (7/7) Set D-View8 Auto Start-----
D-View8 Services are running...
Installation completed.
Enter the https://172.18.192.236:17300/ to open D-View 8 in your browser.
(D-View8 will use traceroute, so you can input 'apt-get install traceroute' to suppo
```

2.3.2. Cluster Mode Installation (Only Available for Enterprise Edition)

The D-View 8 supports redundancy and load balancing features. The following diagram depicts the cluster architecture.

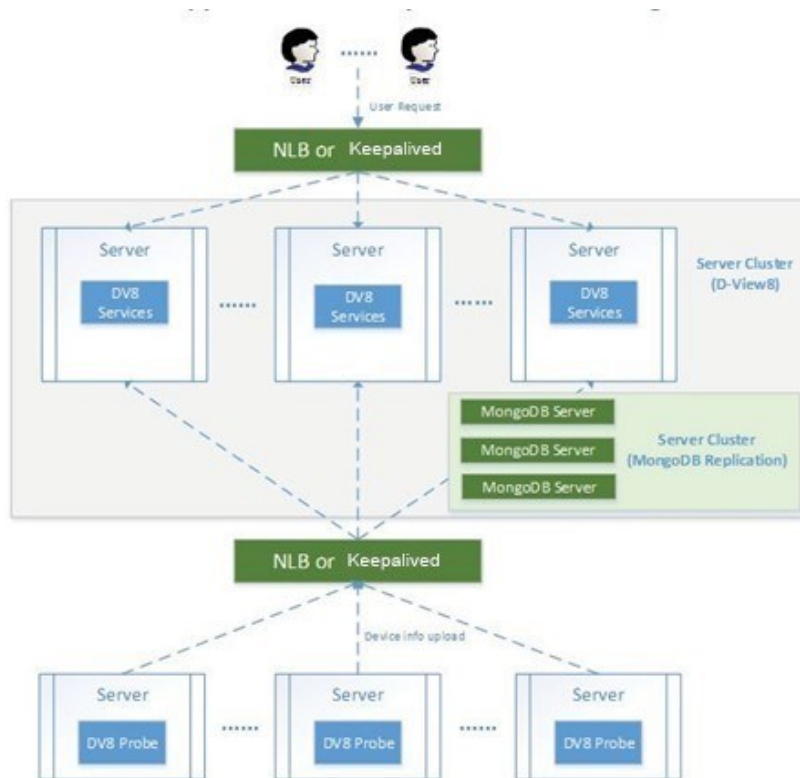

Cluster Architecture

The following shows the structure of D-View 8 application and MongoDB. The structure includes a primary, secondary, and an arbiter database. In the foundational architecture, the application connects to both the primary and secondary databases.

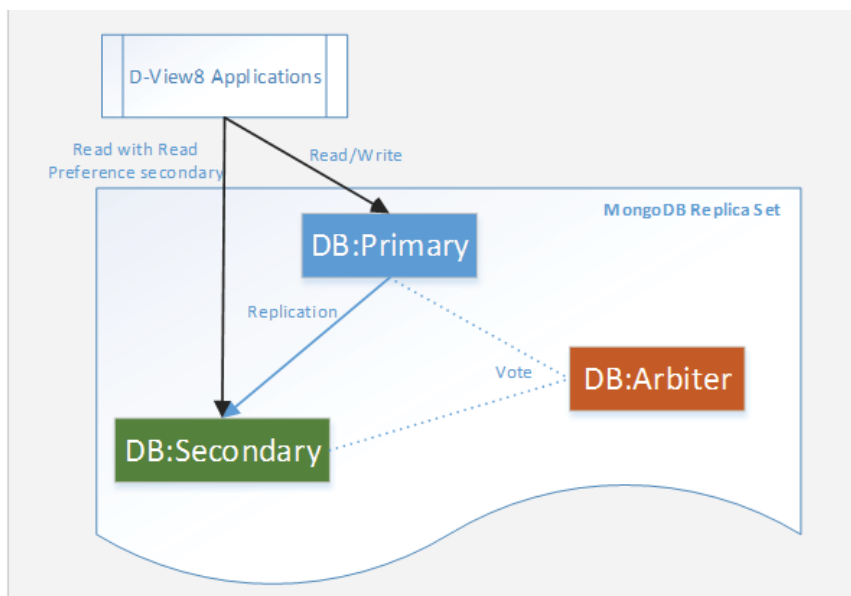

A primary database may become a secondary one, while the secondary may also be designated as the primary. By default, clients read from the primary, but a read preference can be configured to allow read operations on the secondary database.

Build a Cluster

Clusters help support data redundancy and load balancing. Building clusters is outlined in this section.

First, Install MongoDB on 3 Linux servers with the designated roles to support the above mentioned structure.

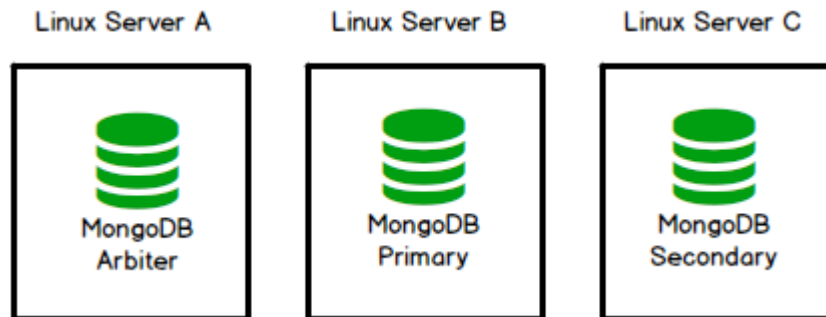

Install D-View 8 on additional servers and connect the D-View 8 application to the MongoDB cluster.

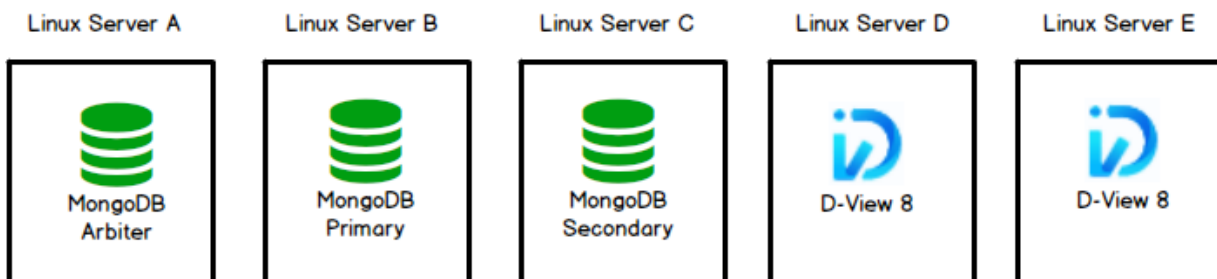

Or you may opt to install D-View 8 on the primary and secondary database servers in lieu of additional servers as the following diagram depicts:

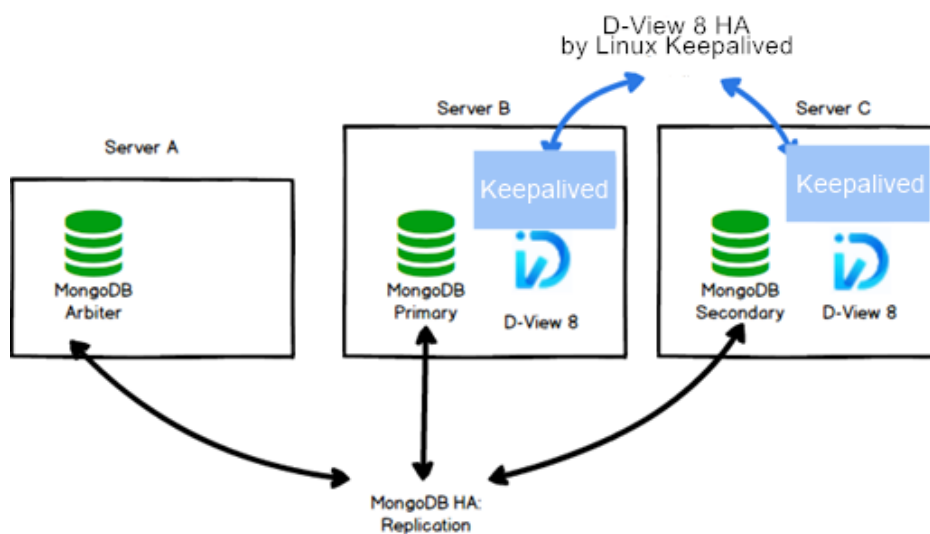

Then, install Keepalived on the D-View 8 servers to support load balancing:

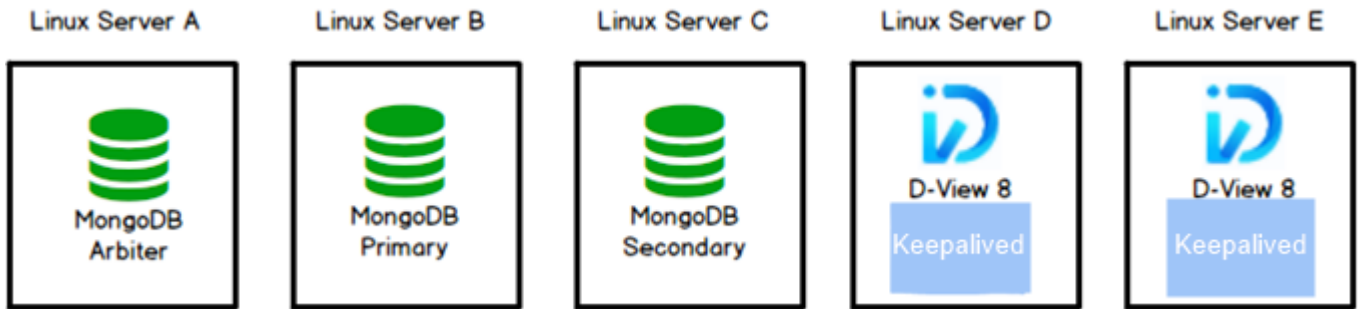

Note: To support high availability and load balancing, please install the MongoDB servers, D-View 8 servers, and Keepalived in sequence as instructed. And the Keepalived must be enabled on the D-View 8 servers which can be a cluster of two servers depending on your network environment.

To manage additional devices through Linux servers, you need to add probes in these servers and connect them to the D-View 8 servers with high-availability clustering managed by Keepalived.

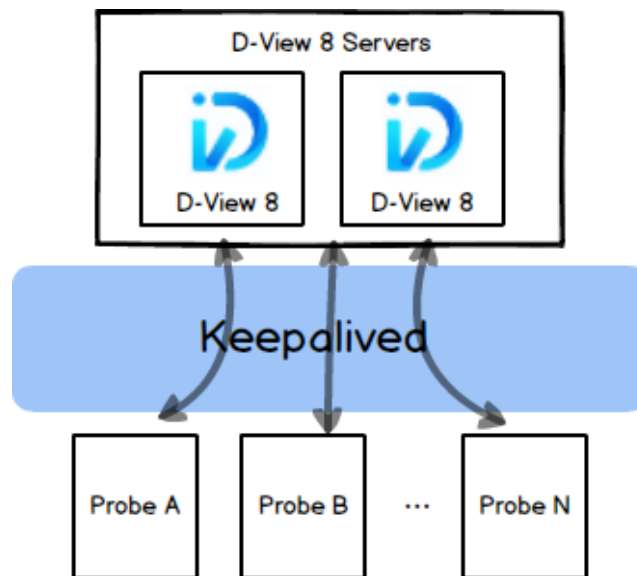

Preparation for Three-server Deployment

When planning for server cluster deployment, you must first set up 3 Linux servers with the following system configuration:

- SERVER A
OS: Ubuntu 18.04 or above
MongoDB
IP Address: 10.32.123.130
Replica set role: arbiter
- SERVER B
OS: Ubuntu 18.04 or above
MongoDB
IP Address: 10.32.123.131
Replica set Role: primary
Keepalived with virtual IP: 10.32.123.133
- SERVER C
OS: Ubuntu 18.04 above
MongoDB
IP Address: 10.32.123.132
Replica set Role: secondary
Keepalived with virtual IP: 10.32.123.133

A D-View 8 server includes 3 components: D-View 8 WebAPI, D-View 8 Core, and D-View 8 Probe. Both D-View-8 WebAPI and D-View 8 Core support load-balancing. We will only show load-balancing with D-View 8 WebAPI in our example. D-View 8 servers support load-balancing and failover features via the keepalived package in Linux. In our example, D-View 8 server B and C will be the load balancer and network traffic will be redirected to server B and C via a virtual IP. And users should be able to connect to the D-View 8 server with the virtual IP from a web browser.

Data Redundancy on the MongoDB Server Cluster

This section details the steps to install the required MongoDB database and enable data redundancy in the database cluster.

MongoDB Cluster Installation

Install MongoDB with the [MongoDB PSA](#) structure:

Note: MongoDB cluster can still work when either the primary or secondary database is malfunctioned. But when

the arbiter is malfunctioned, MongoDB PSA will fail.

Perform MongoDB installation on 3 servers (server A, B, C) for the replica set.

To install a MongoDB Server on server A:

1. Obtain the D-View 8 - MongoDB Installation Package (e.g. `dview8-mongodb-linux-version.tgz`) from your sales representative.
2. Log in to the system as a root user.
3. Change the current directory to the D-View 8 directory, for example, `/home/dview8`
4. Enter the following to extract the package: `tar -zxvf dview8-mongodb-linux-1.0.2.8.tgz`.
5. Change the current directory to the extracted path. Then execute the `init_mongo.sh` shell script: `./init_mongo.sh`
6. You will need to import the built-in data by entering `y` in the following question:

```
Whether you first start MongoDB, first start will import D-View 8 built-in data. [y/n]
```

```
Choose to use cluster MongoDB by starting the instance in replication mode:
```

```
Are you going to use Cluster MongoDB and start MongoDB in replication mode. [y/n]
```

```
root@dview8:/home/dview8/mongodb-linux-x86_64-4.0.0# ./init_mongo.sh
```

```
!
```

```
---- check MongoDB port ----
```

```
MongoDB port : 27018 is free
```

```
Whether you first start MongoDB, first start will import D-View 8 built-in data.[y/n]
```

```
y
```

```
mongodb is not running!
```

```
stop mongodb.....
```

```
about to fork child process, waiting until server is ready for connections.
```

```
forked process: 385940
```

```
child process started successfully, parent exiting
```

```
Creating built-in data for D-View8 database...
```

```
Creating built-in data system.js.
```

```
Creating built-in data DView8_ConfigurationCategory.
```

```
Creating built-in data DView8_ConfigurationTemplate.
```

```
Creating built-in data DView8_Credit.
```

```
Creating built-in data DView8_DeviceCategory.
```

```
...
```

```
...
```

```
Creating built-in data DView8_SyslogKeyWords.
```

```
D-View8 database built-in data created.
```

```
Are you going to use Cluster MongoDB and start MongoDB in replication mode.[y/n]
```

```

y
mongodb is running!
stop mongodb.....
2022-08-20T06:04:11.324+0000 W CONTROL [main] enableMajorityReadConcern startup
parameter was supplied, but its value was ignored; majority read concern cannot
be disabled.
about to fork child process, waiting until server is ready for connections.
forked process: 386317
child process started successfully, parent exiting
----- all completed -----
root@dview8:/home/dview8/mongodb-linux-x86_64-4.0.0#

```

The database server is ready for connections and will use TCP port 27018 for communication. Perform the above installation procedure on server B and C as well.

D-View 8 Installation

Note: You can opt to install D-View 8 on the primary and secondary database (server B & C) to reduce the total number of servers as illustrated in the above three-server topology. Another option is to install D-View 8 on two additional servers.

To install D-View 8 on multiple servers and connect them to the MongoDB cluster:

1. Log in as a root user.
2. Download the package from the [D-View 8 website](#):
D-View_8_version_Installation.deb (e.g. dpkg -i D-View_8_2.0.0.26_Installation.deb)
3. Change the current directory to the D-View 8 directory, for example, /home/dview8
4. Execute the dpkg command to start the installation process:

```
dpkg -i D-View_8_2.0.0.26_Installation.deb
```

5. At the prompt enter the physical IP address for the local server:

Input the local IP: x.x.x.x (10.32.123.131 for server B as in our example)

The D-View 8 application requires a database service (MongoDB) to function.

6. At the prompt, enter 2 for MongoDB cluster installation.

You intend to use: 1. standalone MongoDB; 2. MongoDB cluster [1/2]

7. At the prompt, enter the physical IP address and port of the primary, secondary, and arbiter database.

```
root@dview8:/home/dview8# dpkg -i D-View_8_2.0.0.26_Installation.deb
```

```
Selecting previously unselected package dview8.
```

```
(Reading database ... 108358 files and directories currently installed.)
```

```
Preparing to unpack D-View_8_2.0.0.26_Installation.deb ...
```

```
Before installation...
```

```

.
---
Unpacking dview8 (2.0.0.26) ...
Setting up dview8 (2.0.0.26) ...
Installing...
.
-----
----- ( 1/7 ) check local file and directory environments-----
----- ( 2/7 ) check local port environments-----
---- check WebServer ----
WebServer_port is free
---- check CoreServer_port ----
CoreServer_port is free
---- check Probe_port ----
Probe_port is free
Now initial set the local IP for D-View 8 (input format similar to: 192.168.131.25),
Local IP address detected may be as follows, Select correct local IP First, Features such as Config Backup/Restore,
Firmware Upgrade, Send Activation Email will work properly.
10.32.123.131
172.18.0.1
-----
please confirm that the input IP is valid:
Input the local IP : 10.32.123.131 #Input the physical IP addresses for the D-VIEW 8 server
input: 10.32.123.131
----- ( 3/7 ) Chmod installation files-----
----- ( 4/7 ) Install D-View8 MongoDB Services-----
D-View 8 requires a database service provided by MongoDB 4.0.3. So if you choose 'Install a new MongoDB 4.0.3',
the installation will try to install MongoDB 4.0.3. If you choose 'Use an existing MongoDB 4.0.3', you can
let D-View 8 to connect a remote MongoDB service.
You intend to use: 1.standalone MongoDB; 2.MongoDB cluster[1/2]
2
-----
MongoDB cluster contains Primary node, Secondary node and Arbiter node.
The Primary: receives write and read operations.
The Secondary: become a primary if the current primary becomes unavailable.

```

The Arbiter: decide the secondary to upgrade as an primary after the primary is unavailable.

Input the existing the Primary IP : 10.32.123.131

input: 10.32.123.131

Input the existing the Primary port : 27018

input: 27018

Input the existing the Secondary IP : 10.32.123.132

input: 10.32.123.132

Input the existing the Secondary port : 27018

input: 27018

Input the existing the Arbiter IP : 10.32.123.130

input: 10.32.123.130

Input the existing the Arbiter port : 27018

input: 27018

Creating built-in data for D-View8 database...

Creating built-in data DView8_ConfigurationCategory.

Creating built-in data DView8_ConfigurationTemplate.

Creating built-in data DView8_Credit.

Creating built-in data DView8_DeviceCategory.

Creating built-in data DView8_DeviceTemplate.

Creating built-in data DView8_DeviceType.

Creating built-in data DView8_Email.

Creating built-in data DView8_MailServer.

Creating built-in data DView8_MonitorCategory.

Creating built-in data DView8_MonitorTemplate.

Creating built-in data DView8_NotificationSoundSetting.

Creating built-in data DView8_Organization.

Creating built-in data DView8_PanelTemplate.

Creating built-in data DView8_Role.

Creating built-in data DView8_TimeSetting.

Creating built-in data DView8_PortGlobalSetting.

Creating built-in data DView8_AlarmRuleDefine.

Creating built-in data DView8_User.

Creating built-in data DView8_VendorTemplate.

```
Creating built-in data sFlow_mapping_DSCP.
```

```
Creating built-in data template_config_view.
```

```
Creating built-in data DView8_TrapOID.
```

```
Creating built-in data snmp_mib_node.
```

```
Creating built-in data sFlow_NicVendorMapping.
```

```
Creating built-in data sFlow_mapping_application.
```

```
Creating built-in data DView8_SyslogKeyWords.
```

```
Creating built-in data DView8_MonitorBatchAlarmSetting.
```

```
Creating built-in data system.js.
```

```
D-View8 database built-in data created.
```

```
----- ( 5/7 ) Modify D-View8 Service files-----
```

```
modify webservice files
```

```
modify coreserver files
```

```
modify probe files
```

```
----- ( 6/7 ) Install D-View8 Local Services-----
```

```
start web service...
```

```
start core service...
```

```
start probe service...
```

```
----- ( 7/7 ) Set D-View8 Auto Start-----
```

```
D-View8 Services are running...
```

```
Installation completed.
```

```
Enter the https://10.32.123.131:17300/ to open D-View 8 in your browser.
```

```
(D-View8 will use traceroute, so you can input 'apt-get install traceroute' to support)
```

```
root@dview8:/home/dview8#
```

8. Perform the installation procedure for D-View 8 server C but using a different local IP address. For the above Step 5, input the physical IP address for server C (10.32.123.132):

After the installation, you can access the application's dashboard by opening a web browser and entering the assigned IP address and port number (e.g. <https://10.32.123.131:17300/> and https://10.32.123.132:17300 from the above example) in the browser's address field.

Server Load Balancing on D-View 8 Servers

The [Keepalived](#) package needs to be installed on the D-View 8 servers to enable load balancing. Keepalived uses LVS and VRRP to be the load-balancer. VRRP defines two states, MASTER and BACKUP. We will set server B (10.32.123.131) as the MASTER and server C (10.32.123.132) as the BACKUP.

1. Log in to server B using SSH with a root account.

2. Install Keepalived:

```

root@dview8:~# apt install keepalived
Reading package lists... Done
Building dependency tree
Reading state information... Done
The following NEW packages will be installed:
  keepalived
0 upgraded, 1 newly installed, 0 to remove and 71 not upgraded.
Need to get 361 kB of archives.
After this operation, 1,250 kB of additional disk space will be used.
Get:1 http://tw.archive.ubuntu.com/ubuntu focal-updates/main amd64
keepalived amd64 1:2.0.19-2ubuntu0.2 [361 kB]
Fetched 361 kB in 0s (1,129 kB/s)
Selecting previously unselected package keepalived.
(Reading database ... 108694 files and directories currently
installed.)
Preparing to unpack ../keepalived_1%3a2.0.19-
2ubuntu0.2_amd64.deb ...
Unpacking keepalived (1:2.0.19-2ubuntu0.2) ...
Setting up keepalived (1:2.0.19-2ubuntu0.2) ...
Processing triggers for man-db (2.9.1-1) ...

Processing triggers for dbus (1.12.16-2ubuntu2.2) ...
Processing triggers for systemd (245.4-4ubuntu3.15) ...

root@dview8:~#

```

3. Create the /etc/keepalived directory if it is not created.

```

root@dview8:~# mkdir /etc/keepalived

```

4. Copy keepalived.conf and vip_service.sh from /usr/local/dview8/keepalived to /etc/keepalived:

```

root@dview8:~# cp /usr/local/dview8/keepalived/* /etc/keepalived

```

5. Modify the configuration file keepalived.conf as follows:

Note: The DView-8 server uses ports 17300 and 17500 for D-View 8 WebAPI and D-View 8 Core respectively and the port number will be configured in this file.

etc/keepalived/keepalived.conf

```

! Configuration File for keepalived

```

```

global_defs {
    #Global Configuration

```

```

    router_id LVS_36 #The router_id is the load-balancing identifier, which should be unique.

```



```

}

vrrp_instance VI_1 { # Identify a VRRP instance definition block

    state MASTER # Specify the instance state in standard use: MASTER or BACKUP, has to be capitalized.

    interface eth0 # Specify the network interface for the instance to run on

    virtual_router_id 51 # Specify to which VRRP router id the instance belongs

    priority 50 # Specify the instance priority for VRRP MASTER router (lower means higher priority), the main node has the
                # highest priority than other nodes.

    advert_int 1 # Specify the advertisement interval in seconds

    authentication { # Identify a VRRP authentication definition block

        auth_type PASS # specify the authentication method: PASS|AH

        auth_pass 1111 #Specify the password for authentication

    }

    virtual_ipaddress { # identify a VRRP VIP definition block

        10.32.123.133

    }

}

virtual_server 10.32.123.133 17300 { #Assign service to use the Virtual IP, the D-View 8 WebAPI uses port 17300

    delay_loop 6 # Healthcheck time interval

    lb_algo rr

    lb_kind DR #Use the LVSDR mode

    persistence_timeout 5

    protocol TCP # specify the protocol kind: TCP|UDP

    real_server 10.32.123.131 17300 {

        weight 1 #Assign weight to service node

        TCP_CHECK {

            connect_timeout 3

            retry 1

            delay_before_retry 3

            connect_port 17300

        }

    }

}

real_server 10.32.123.132 17300 {

```

```
weight 1 #Assign weight to service node
```

```
TCP_CHECK {
    connect_timeout 3
    retry 1
    delay_before_retry 3
    connect_port 17300
}
}
```

```
virtual_server 10.32.123.133 17500 { #Assign service to use the Virtual IP, the D-View 8 Core uses port 17500
```

```
    delay_loop 6 #Healthcheck time interval
```

```
    lb_algo rr
```

```
    lb_kind DR # Use the LVSDR mode
```

```
    persistence_timeout 5
```

```
    protocol TCP # specify the protocol kind: TCP|UDP
```

```
    real_server 10.32.123.131 17500 {
```

```
        weight 1 #Assign weight to service node
```

```
        TCP_CHECK {
```

```
            connect_timeout 3
```

```
            retry 1
```

```
            delay_before_retry 3
```

```
            connect_port 17500
```

```
        }
```

```
    }
```

```
    real_server 10.32.123.132 17500 {
```

```
        weight 1 #Assign weight to service node
```

```
        TCP_CHECK {
```

```
            connect_timeout 3
```

```
            retry 1
```

```
            delay_before_retry 3
```

```
            connect_port 17500
```

```

}
}
}

```

6. Start the Keepalived service and check its status by entering the following:

```

root@dview8:~# service keepalived start
root@dview8:~# service keepalived status

```

Make sure that active (running) is displayed:

● keepalived.service - Keepalive Daemon (LVS and VRRP)

Loaded: loaded (/lib/systemd/system/keepalived.service; enabled; vendor preset: enabled)

Active: active (running) since Sat 2022-08-20 11:20:45 UTC; 51min ago

Main PID: 198630 (keepalived)

Tasks: 3 (limit: 9434)

Memory: 3.1M

CGroup: /system.slice/keepalived.service

```

├─198630 /usr/sbin/keepalived --dont-fork
├─198651 /usr/sbin/keepalived --dont-fork
└─198652 /usr/sbin/keepalived --dont-fork

```

```

Aug 20 11:20:45 dview8 Keepalived_healthcheckers[198651]: Activating healthchecker for service [10.32.123.131]:tcp:17500 for VS
[10>

```

```

Aug 20 11:20:45 dview8 Keepalived_healthcheckers[198651]: Activating healthchecker for service [10.32.123.132]:tcp:17500 for VS
[10>

```

```

Aug 20 11:20:45 dview8 Keepalived_healthcheckers[198651]: Activating BFD healthchecker

```

```

Aug 20 11:20:47 dview8 Keepalived_healthcheckers[198651]: TCP connection to [10.32.123.132]:tcp:17500 success.

```

```

Aug 20 11:20:49 dview8 Keepalived_vrrp[198652]: (VI_1) Entering MASTER STATE

```

```

Aug 20 11:20:49 dview8 Keepalived_healthcheckers[198651]: TCP connection to [10.32.123.132]:tcp:17300 success.

```

```

Aug 20 11:20:50 dview8 Keepalived_healthcheckers[198651]: TCP_CHECK on service [10.32.123.131]:tcp:17300 failed.

```

```

Aug 20 11:20:50 dview8 Keepalived_healthcheckers[198651]: Removing service [10.32.123.131]:tcp:17300 to VS
[10.32.123.133]:tcp:17300

```

```

Aug 20 11:20:50 dview8 Keepalived_healthcheckers[198651]: TCP_CHECK on service [10.32.123.131]:tcp:17500 failed.

```

```

Aug 20 11:20:50 dview8 Keepalived_healthcheckers[198651]: Removing service [10.32.123.131]:tcp:17500 to VS
[10.32.123.133]:tcp:17500

```

```

lines 1-21/21 (END)

```

7. Modify the vip_service.sh by entering the assigned Virtual IP address:

```

/etc/keepalived/vip_service.sh

```

```

#!/bin/bash

```

```

check_ptah=`which ifconfig |wc -l`

```

```

if [ $check_ptah -eq 0 ]

```

```

then echo -e "\033[31mPlease run the 'apt install net-tools' command\033[0m"

```

```

exit 1

```

```

fi

```

```
SNS_VIP=10.32.123.133 #Enter the Virtual IP address
```

```
case "$1" in

start)

    ifconfig lo:0 $SNS_VIP netmask 255.255.255.255 broadcast $SNS_VIP

    /sbin/route add -host $SNS_VIP dev lo:0

    echo "1" >/proc/sys/net/ipv4/conf/lo/arp_ignore

    echo "2" >/proc/sys/net/ipv4/conf/lo/arp_announce

    echo "1" >/proc/sys/net/ipv4/conf/all/arp_ignore

    echo "2" >/proc/sys/net/ipv4/conf/all/arp_announce

    sysctl -p >/dev/null 2>&1

    echo "RealServer Start OK"

    ;;

stop)

    ifconfig lo:0 down

    route del $SNS_VIP >/dev/null 2>&1

    echo "0" >/proc/sys/net/ipv4/conf/lo/arp_ignore

    echo "0" >/proc/sys/net/ipv4/conf/lo/arp_announce

    echo "0" >/proc/sys/net/ipv4/conf/all/arp_ignore

    echo "0" >/proc/sys/net/ipv4/conf/all/arp_announce

    echo "RealServer Stoped"

    ;;

*)

    echo "Usage: $0 {start|stop}"

    exit 1

esac

exit 0
```

- Verify that the Virtual IP service is configured with an extra loopback network interface lo:0

```
root@dview8:/etc/keepalived# ./vip_service.sh start
```

```
RealServer Start OK
```

```
root@dview8:/etc/keepalived# ip a
```

```
1: lo: <LOOPBACK,UP,LOWER_UP> mtu 65536 qdisc noqueue state UNKNOWN group default qlen 1000
```

```
link/loopback 00:00:00:00:00:00 brd 00:00:00:00:00:00
```

```
inet 127.0.0.1/8 scope host lo
```

```
valid_lft forever preferred_lft forever
```

```
inet 10.32.123.133/32 brd 10.32.123.133 scope global lo:0 # The loopback network interface
```

```
valid_lft forever preferred_lft forever
```

```
inet6 ::1/128 scope host
```

```
valid_lft forever preferred_lft forever
```

```
2: eth0: <BROADCAST,MULTICAST,UP,LOWER_UP> mtu 1500 qdisc mq state UP group default qlen 1000
```

```
link/ether ca:e1:88:d7:da:40 brd ff:ff:ff:ff:ff:ff
```

```
inet 10.32.123.131/16 brd 10.32.255.255 scope global eth0
```

```
valid_lft forever preferred_lft forever
```

```
inet 10.32.123.133/32 scope global eth0
```

```
valid_lft forever preferred_lft forever
```

```
inet6 fe80::c8e1:88ff:fed7:da40/64 scope link
```

```
valid_lft forever preferred_lft forever
```

```
3: docker0: <NO-CARRIER,BROADCAST,MULTICAST,UP> mtu 1500 qdisc noqueue state DOWN group default
```

```
link/ether 02:42:8e:b9:f3:bd brd ff:ff:ff:ff:ff:ff
```

```
inet 172.18.0.1/16 brd 172.18.255.255 scope global docker0
```

```
valid_lft forever preferred_lft forever
```

- To start or stop `/etc/keepalived/vip_service.sh` whenever keepalived starts or stops, modify `/lib/systemd/system/keepalived.service`:

Add the following two lines to `/lib/systemd/system/keepalived.service`:

```
ExecStartPre=bash /etc/keepalived/vip_service.sh start
```

```
ExecStopPost=bash /etc/keepalived/vip_service.sh stop
```

`/lib/systemd/system/keepalived.service`

```
[Unit]
```

```
Description=Keepalive Daemon (LVS and VRRP)
```

```
After=network-online.target
```

```
Wants=network-online.target
```

```
# Only start if there is a configuration file
```

```
ConditionFileNotEmpty=/etc/keepalived/keepalived.conf
```

```
[Service]
```

```
Type=simple
```

```
# Read configuration variable file if it is present
```

```
EnvironmentFile=-/etc/default/keepalived
```

```
ExecStart=/usr/sbin/keepalived --dont-fork $DAEMON_ARGS
```

```
ExecStartPre=bash /etc/keepalived/vip_service.sh start # Add this line and the following line
```

```
ExecStopPost=bash /etc/keepalived/vip_service.sh stop
```

```
ExecReload=/bin/kill -HUP $MAINPID
```

```
[Install]
```

```
WantedBy=multi-user.target
```

10. Reload keepalived by entering the following commands:

```
root@dview8:/lib/systemd/system# systemctl daemon-reload
```

```
root@dview8:/lib/systemd/system# service keepalived restart
```

Perform the above installation procedure on the designated VRRP backup server (server C). However, the `/etc/keepalived/keepalived.conf` should be modified accordingly as the following example file shows:

`/etc/keepalived/keepalived.conf`

```
! Configuration File for keepalived
```

```
global_defs { #Global configuration
```

```
router_id LVS_36 #router_id should be unique in the LAN
```

```
}
```

```
vrrp_instance VI_1 { # identify a VRRP instance definition block
```

```
state BACKUP #Here identify the VRRP backup server, has to be capitalized
```

```
interface eth0 # Specify the network interface for the instance to run on
```

```
virtual_router_id 51 # specify to which VRRP router id the instance belongs
```

```
priority 100 # specify the instance priority for the VRRP BACKUP router
```

```
advert_int 1 # Specify the advertisement interval in seconds (set to 1)
```

```
authentication { # Identify a VRRP authentication definition block
```

```
auth_type PASS #Authentication method
```

```

auth_pass 1111 #Authentication password

}

virtual_ipaddress { #Identify a VRRP VIP definition block; it can contain multiple addresses without specifying subnetwork masks, but
it must

    align with the Virtual IP address in the LVS client setting.

    10.32.123.133
}
}

virtual_server 10.32.123.133 17300 { #Assign the service to use the Virtual IP, the D-View 8 WebAPI uses port 17300

    delay_loop 6 #Healthcheck time interval

    lb_algo rr

    lb_kind DR # Use the LVSDR mode

    persistence_timeout 5

    protocol TCP #specify the protocol kind: TCP|UDP

    real_server 10.32.123.131 17300 { # Service Node 1

        weight 1 #Assign weight to the service node

        TCP_CHECK {

            connect_timeout 3

            retry 1

            delay_before_retry 3

            connect_port 17300

        }

    }

    real_server 10.32.123.132 17300 { #Service Node 2

        weight 1 #Assign weight to the service node

        TCP_CHECK {

            connect_timeout 3

            retry 1

            delay_before_retry 3

            connect_port 17300

        }

    }
}

```

}

```
virtual_server 10.32.123.133 17500 { # Assign the service to use the Virtual IP and port #17500, the D-View 8 Core uses port 17500
```

```
    delay_loop 6 # Healthcheck time interval
```

```
    lb_algo rr
```

```
    lb_algo rr
```

```
    lb_kind DR # Use the LVSDR mode
```

```
    persistence_timeout 5
```

```
    protocol TCP # specify the protocol kind: TCP|UDP
```

```
    real_server 10.32.123.131 17500 {
```

```
        weight 1 # Assign weight to the service node
```

```
        TCP_CHECK {
```

```
            connect_timeout 3
```

```
            retry 1
```

```
            delay_before_retry 3
```

```
            connect_port 17500
```

```
        }
```

```
    }
```

```
    real_server 10.32.123.132 17500 {
```

```
        weight 1 # Assign weight to the service node
```

```
        TCP_CHECK {
```

```
            connect_timeout 3
```

```
            retry 1
```

```
            delay_before_retry 3
```

```
            connect_port 17500
```

```
        }
```

```
    }
```

```
}
```

Also modify `/etc/keepalived/vip_service.sh` for the VRRP backup server as shown in the above Step 7 using the assigned Virtual IP address (e.g. 10.32.123.133 as shown in the above example). Perform Step 8 as for the

master server to verify that the Virtual IP service is configured with an extra loopback network interface `lo:0`. And modify `keepalived.service` so that `vip_service.sh` can start or stop whenever `keepalived` starts or stops as shown in the above Step 9.

The installation package also provides scripts for restarting and stopping database services as well as status checking:

```
root@dview8:/home/dview8/mongodb-linux-x86_64-4.0.0# ls -la *.sh
```

```
-rwxr-xr-x 1 root root 983 Aug 17 07:43 restart_mongo.sh
```

```
-rwxrwxrwx 1 root root 496 Aug 17 07:43 status_mongo.sh
```

```
-rwxrwxrwx 1 root root 686 Aug 17 07:43 stop_mongo.sh
```

To obtain the D-View 8 version:

```
root@dview8:/home/dview8/mongodb-linux-x86_64-4.0.0# cat dv8-version
```

```
2.0.0.26
```

You can now verify the D-View 8 installation by entering the Virtual IP address of the server cluster. The

D-View 8 web interface can be accessed with the port 17300 (<https://10.32.123.133:17300>). The D-View 8 web interface should be operational even one D-View 8 sever of the cluster is disconnected.

5. Input the physical IP address of the local server and the core server using the Virtual IP and the port number of the server cluster. For design without HA, enter the physical IP address of local server and the core server using the physical IP and the port number instead.

```
----- ( 1/7 ) check local file and directory environments-----
```

```
----- ( 2/7 ) check local port environments-----
```

```
---- check probe_port ----
```

```
probe_port is free
```

```
----- ( 3/7 ) input local ip / coreserver url-----
```

```
----- local IP address detected may be as follows -----
```

```
-----
```

```
172.18.0.1
```

```
10.32.123.134
```

```
172.17.134.220
```

```
-----
```

```
Now initial set the local IP for D-View 8 Probe, features such as Config Backup/Restore,Firmware Upgrade will work properly.
```

```
please confirm that the input IP is valid:(input format similar to: 192.168.131.25)
```

```
input: 10.32.123.134
```

```
Now please enter D-View8 Core Server IP and Port. Probe connected Core Server successfully, So Probe could work.
```

```
please confirm that the input IP is valid:(input format similar to: 192.168.131.25)
```

```
Input the CoreServer IP : 10.32.123.133 #Input the Virtual IP and port number of the server cluster for HA or a physical IP address of the server without HA
```

```
input: 10.32.123.133
```

```
Input the CoreServer Port : 17500
```

```
input: 17500
```

```
-----
```

```
----- ( 4/7 ) Chmod installation files-----
```

```
----- ( 5/7 ) Modify D-View8 Probe Service files-----
```

```
modify probe files
```

```
check file finished
```

```
----- ( 6/7 ) Install D-View8 Probe Local Services-----
```

```
start probe service
```

```
----- ( 7/7 ) Set D-View8 Probe Auto Start-----
```

```
D-View8 Probe Service are running...
```

Installation completed.

You can verify the installation of the remote probe by opening a web browser and entering the Virtual IP address (or the physical IP address if HA is not used) of the server cluster with the port: `https://10.32.123.133:17300`. Then go to **System > Server Management**. On the Probe tab, the remote probe should be listed in the table.

Status	Probe Name	Binding IP	Listening Ports	Core Server IP	Location	Discovered Devices	Managed Devices
●	LocalProbe-192.168.2...	192.168.220.84	Listening:Syslog(514), sFlow(6343), TFTP(69), Probe(17600)	127.0.0.1	NA1	66	47
●	10.32.123.134	10.32.123.134	Listening:Trap(162), Syslog(514), sFlow(6343), TFTP(69), Probe(17600)	61.216.155.109	NA	3	1

The installation package also provides scripts for restart and stop as well as status checking. You can also modify IP settings using the `config.sh` script.

```
dview8@dview8:~$ cd /usr/local/dview8_probe/
```

```
dview8@dview8:/usr/local/dview8_probe$ ls -la
```

```
total 312
drwxr-xr-x  8 root root  4096 Aug 26 14:34 .
drwxr-xr-x 12 root root  4096 Aug 26 14:30 ..
-rwxr-xr-x  1 root root  3298 Jul 27 14:25 config.sh
-rwxr-xr-x  1 root root 11676 Aug 20 02:53 init.sh
drwxrwxrwx  4 root root  4096 Aug 26 14:30 jre
-rwxr--r--  1 root root 246605 Aug 26 14:33 libsigar-amd64-linux.so
drwxrwxrwx  2 root root  4096 Aug 26 14:30 LICENSE
drwxr-xr-x  2 root root  4096 Aug 26 14:34 logs
-rwxr-xr-x  1 root root   738 Jul 27 14:25 monitorProbe.sh
drwxrwxrwx  3 root root  4096 Aug 26 14:56 Probe
drwxrwxrwx  2 root root  4096 Aug 26 14:30 probeLibs
-rwxrwxrwx  1 root root  1553 Jul 27 14:25 restart.sh
-rwxrwxrwx  1 root root   550 Jul 27 14:25 status.sh
-rwxrwxrwx  1 root root   877 Jul 27 14:25 stop.sh
-rwxr-xr-x  1 root root   530 Jul 27 14:25 stop-upgradeprobe.sh
drwxr-xr-x  2 root root  4096 Aug 26 14:34 tftpfile
```

Uninstallation

Uninstallation can be accomplished by removing the probe package `dview8probe` using the `dpkg` command with a parameter.

```
root@dview8:~# dpkg -P dview8probe
(Reading database ... 109422 files and directories currently installed.)
Removing dview8probe (2.0.0.26) ...
pre remove.....
probe is running!
stop probe.....
----- all completed -----
post remove.....
Purging configuration files for dview8probe (2.0.0.26) ...
post remove.....
dpkg: warning: while removing dview8probe, directory '/usr/local/dview8_probe/Probe' not empty so not removed
```

2.4 Software Upgrade



NOTE: Software upgrade is only supported after D-View 8 version 1.0.1.28. For D-View 8 version before 1.0.1.28, you can only install the new version after removing the old one.

2.4.1. On Windows

The D-View 8 application is upgraded from time to time to increase the performance and functionality of the software. Upgrading the software can be done by downloading a newer version of the full installation package.

To upgrade the software:

1. Download the latest D-View 8 installation package from the [D-View 8 website](#).
2. Double-click the package file to start the installer.

The Installation Setup wizard displays.

3. Click **"Next"** to begin the installation process.



4. Select "Upgrade My D-View 8" and click "Next" to continue.

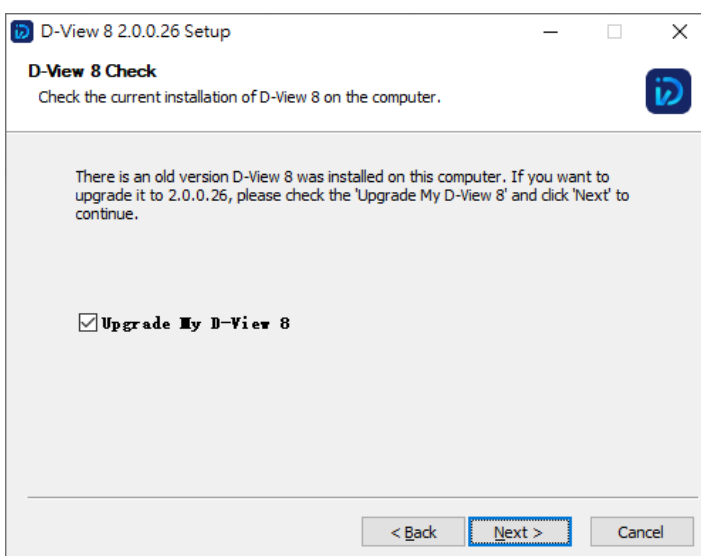

- When the Installation Complete page displays, click **Next** to continue.

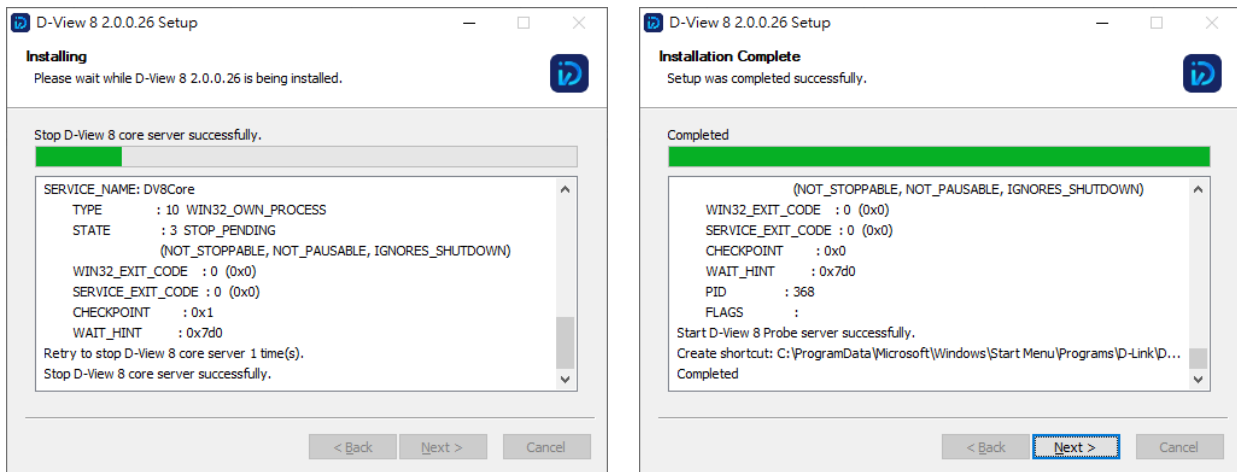

- Click **Finish** to exit the wizard.



- To verify the current version of the application, open the application by logging in through a browser, see 0 .
- In the application interface, navigate to **System > About** to view the Software Version.



NOTE: Manual upgrade of remote probes will be required for software versions earlier than 2.0.0. Refer to [2.6.4 Upgrade Remote Probes](#) for more information.

2.4.2. On Linux

The D-View 8 application is upgraded from time to time to enhance the performance and functionality of the software. Upgrading the software can be done by downloading a newer version of the full installation package.

The following shows how to upgrade the application through an installation package.

1. Log in with the su command to have root access.
2. Download the latest D-View 8 upgrade package from the [D-View 8 website](#).
3. Go to the root directory.
4. Locate the package file and unpack it:

```
dpkg -i -G D-View_8_2.0.0.26_installation.deb
```

To continue with the update process, the application service must be stopped.

At the prompt, enter **y** to stop the service.

```
Choose whether to stop D-View 8 Services? [y/n]
```

5. Once the service is stopped, a prompt displays to confirm the input IP. Enter the local IP address.

For Standalone versions:

6. Select the type of MongoDB type, enter 1 to select standalone MongoDB.

```
You intend to use: 1. standalone MongoDB; 2 MongoDB cluster[1/2]
```

7. Select if a new MongoDB is required, enter n to skip a new installation:

```
If you need to install a new MongoDB. [y/n]
```

8. If a current MongoDB is installed, enter y to select the installed instance:

```
The system detects that you have MongoDB installed, do you want to use it? [y/n]
```

The update process continues and once complete, the application can be opened through a web browser. The

```
----- (7/7) Set D-View8 Auto Start-----
D-View8 Services are running...
Installation completed.
Enter the https://172.18.192.236:17300/ to open D-View 8 in your browser.
(D-View8 will use traceroute, so you can input 'apt-get install traceroute' to support)
```

application's corresponding IP address is listed as seen in the following figure.

For Cluster versions:

1. Select the MongoDB type, enter 2 to select MongoDB cluster.

```
You intend to use: 1. standalone MongoDB; 2 MongoDB cluster[1/2]
```

2. To view the current software version, enter the following in the command line:

```
dpkg -s dview8
```

3. Auto upgrade is supported through the remote probe.

2.5 Uninstallation

2.5.1. Uninstall under Windows

Before the application can be uninstalled, close the application before starting the uninstallation process.



NOTE: The screens and instructions may vary depending on the Windows operating system.

1. To uninstall, click **Windows> Start Menu> Programs > D-Link > D-View 8** and locate the Uninstall shortcut.
2. Click on the D-View 8 program shortcut to start the uninstallation process.
3. Follow the instructions as directed by the uninstallation wizard.

2.5.2. Uninstall under Linux

Before the application can be uninstalled, close the application before starting the uninstallation process.

1. Logon with the su command to obtain root access rights.
2. Enter the following command to stop the services: `dpkg -P dview8`.
3. The D-View 8 services must be stopped to continue, at the prompt enter y to stop the service and continue.

Choose whether to stop D-View 8 Services? [y/n]

4. The configuration files are purged from the application. A prompt to delete the database displays. At the prompt,

enter y to delete MongoDB:

Do you want to delete mongodb? [y/n]

The application is uninstalled.

2.6 Software Migration

Migrating your D-View 7 to D-View 8 version requires the completion of the following:

- Migrate the D-View 7 to D-View 8 database
- Upgrade the D-View 7 to D-View 8 probes

	<p>NOTE: The system does not support the migration from D-View 7 to D-View 8 2.0 and later versions. You need to upgrade your D-View 7 to D-View 8 Version 1.0.3.39 first.</p>
---	---

The entire migration process can be performed through the D-View 8 web interface, see **System > D-View 7 Upgrade** in the application interface menu.

Before you start, make sure your anti-virus software is disabled throughout the migration process.

	<p>NOTES: Migration to D-View 8 involves the following changes to the system:</p> <ol style="list-style-type: none"> 1. The role and privilege will be converted to the D-View 8 structure (User Management). 2. Probe settings will be converted to D-View 8 configuration (Sites and Networks). 3. Sensor settings will be converted to D-View 8 configuration (Monitor & Alarm Settings).
---	--

2.6.1. D-View 7 and D-View 8 Architecture

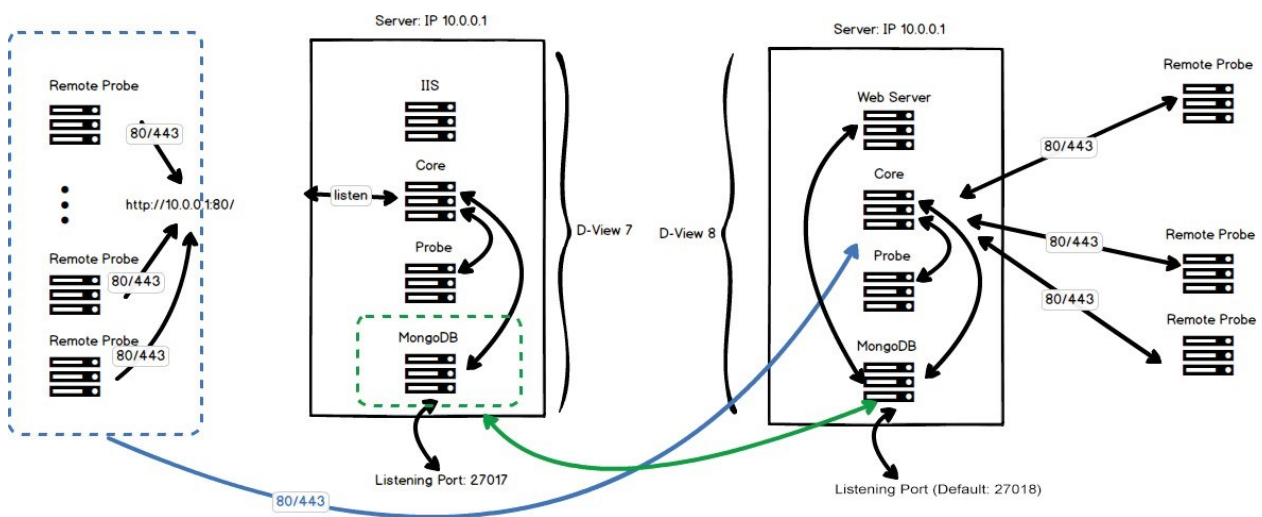

2.6.2. Install D-View 8 on a New Server

	<p>NOTE: The D-View 8 and D-View 7 can be installed on different servers. If you would like to install D-View 8 on a D-View 7 server, refer to Install D-View 8 on the Original D-View 7 Server.</p>
---	---

1. Open the D-View 7 Service Management Tool.
2. In the Services Management tab, click **Stop** to stop the following D-View 7 services: Windows IIS, Core Server, License Agent Server, Probe Server, and Probe File Server. However, *do not* stop the MongoDB server.

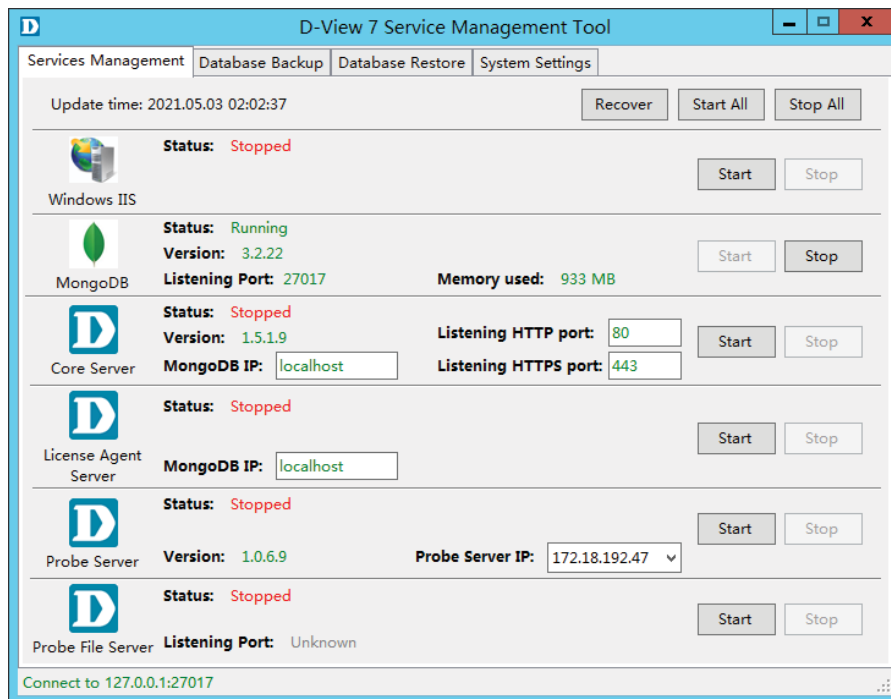

3. Change the D-View 7 server's IP address so as to use the current server IP address for the new D-View 8 server. For example, if the IP address is 10.0.0.1, change it to 10.0.0.X, where X is a value other than 1. We use the IP address 10.0.0.3 for demonstration on Windows:

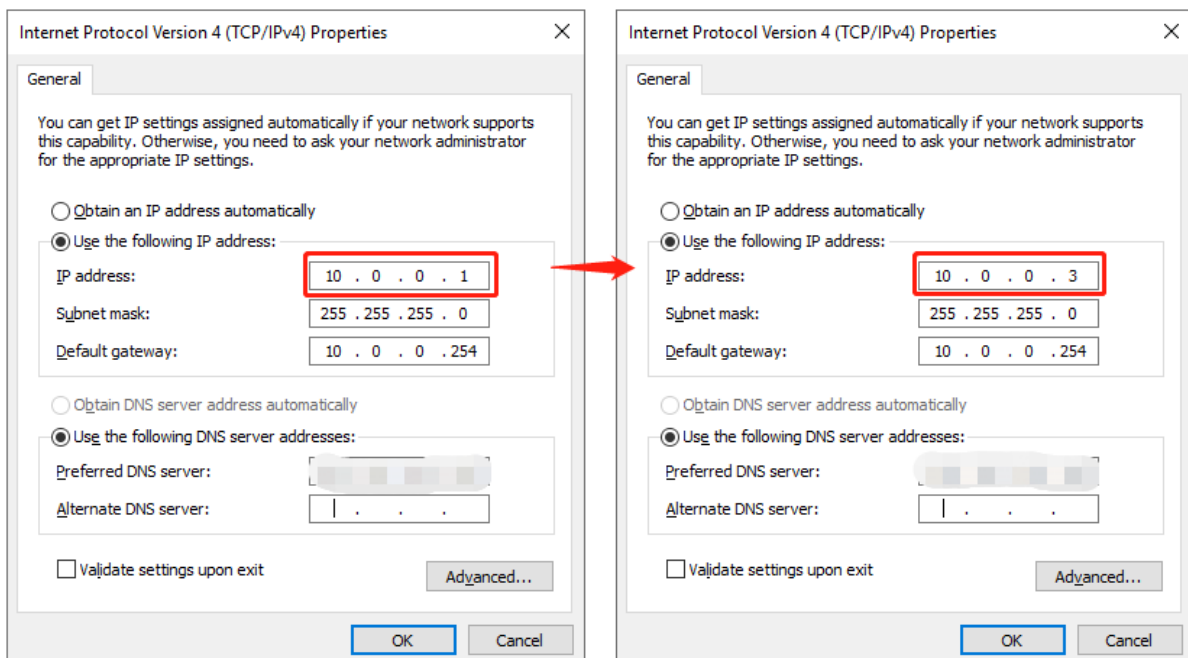

4. Download the D-View 8 package to your local directory.
5. Click on the installation package to begin installing the D-View 8 package. See Installation for more information.
6. The core listening port must be configured to use the D-View 7 port instead. (By default, the D-View 7 listening port is set to 80 while the D-View 8 port is set to 17500.) To do this, in the Port Configuration page, locate the Core Port field and change the value to 80.
7. Click **Check** to validate the configuration setup. If a connection can be established, the Check Pass! notification displays. Otherwise, check the settings and run the validation process.

8. Click **Next** to continue the process of installing the D-View 8 server.
9. Once the installation of the D-View 8 server is complete, log in to the application interface.
10. The D-View 8 Wizard will be displayed as shown below after you log in.

Welcome to D-View 8 Wizard

D-View 8 is a powerful and comprehensive network monitoring and management tool.

According to your account privileges, the following functions are available for you to manage the network.

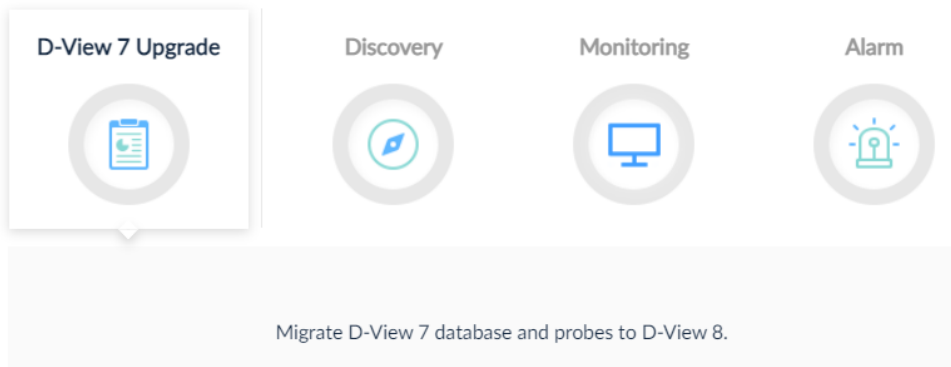

11. In the Wizard, click **D-View 7 Upgrade** to begin the process. This will migrate the D-View 7 database and probes to the D-View 8 server.



NOTE: The wizard will start by asking you to enter your organization name, do *not* skip this step as subsequent Network Discovery requires this information being set.

The Database Migration page displays.

The following settings are required to establish a connection to the D-View 7 MongoDB server:

- In the MongoDB Address field, enter the new IP address and port as previously configured, see previous steps: IP address: 10.0.0.3/ Port: 27017
- If the D-View 7 MongoDB server was installed using the D-View 7 installation wizard, click the Authentication drop-down menu and select SCRAM-SHA-1 (Mongo 3.x default). Otherwise, select **None**.
- In the Username field, enter the registered profile with administration access (admin).
- Enter the corresponding password for the registered admin profile.
- In the Authentication database field, enter admin.



NOTE: If the Connection attempt fails, select None under Authentication and attempt to establish the connection once again.

12. Click **Connect** to initiate the connection with the D-View 7 MongoDB server.

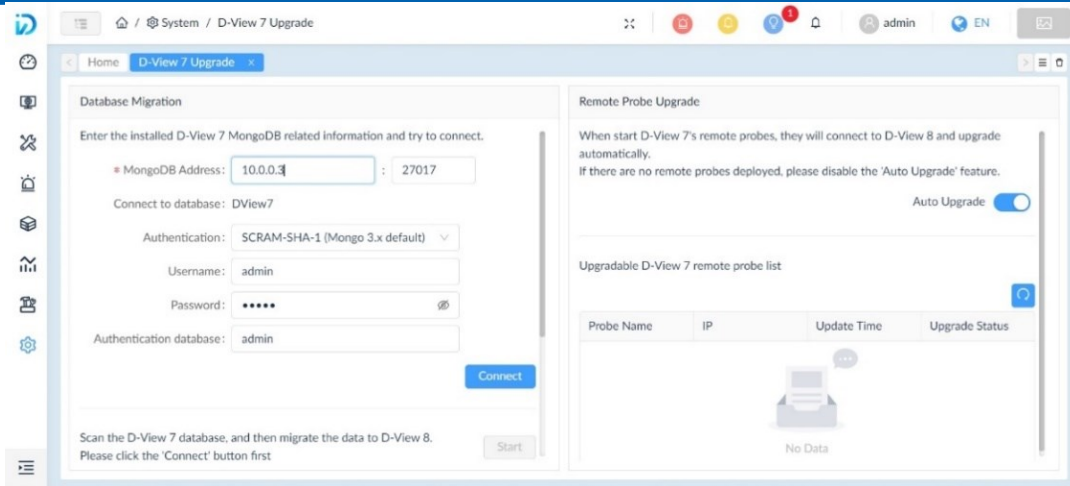

13. The Migrate D-View 7 Database pop-up screen displays. Click **Start** to begin the migration. The wizard provides step-by-step guidance for the process.
14. Click **Next** to continue, **Previous** to return to the previous step, or **Skip All** to automate the process and complete it.



NOTE: If interruption occurs during the migration process, restart the process by clicking **System > D-View 7 Upgrade**.

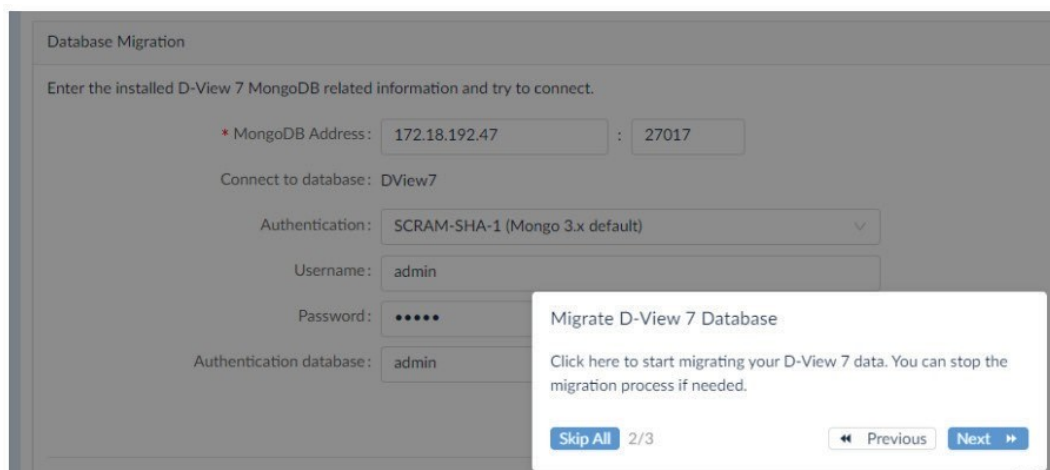

Once the process is completed, the D-View 8 local probes will take over as the bridge to the core server; however, you need to manually upgrade the remote probes (refer to [2.6.4 Upgrade Remote Probes.](#)) Moreover, the data of the original D-View 7 MongoDB is retained and imported to the D-View 8 database.

2.6.3. Install D-View 8 on the Original D-View 7 Server

1. Open the D-View 7 Service Management Tool.
2. In the Services Management tab, click **Stop** to stop the following D-View 7 services: Windows IIS, Core Server, License Agent Server, Probe Server, and Probe File Server. However, *do not* stop the MongoDB server.

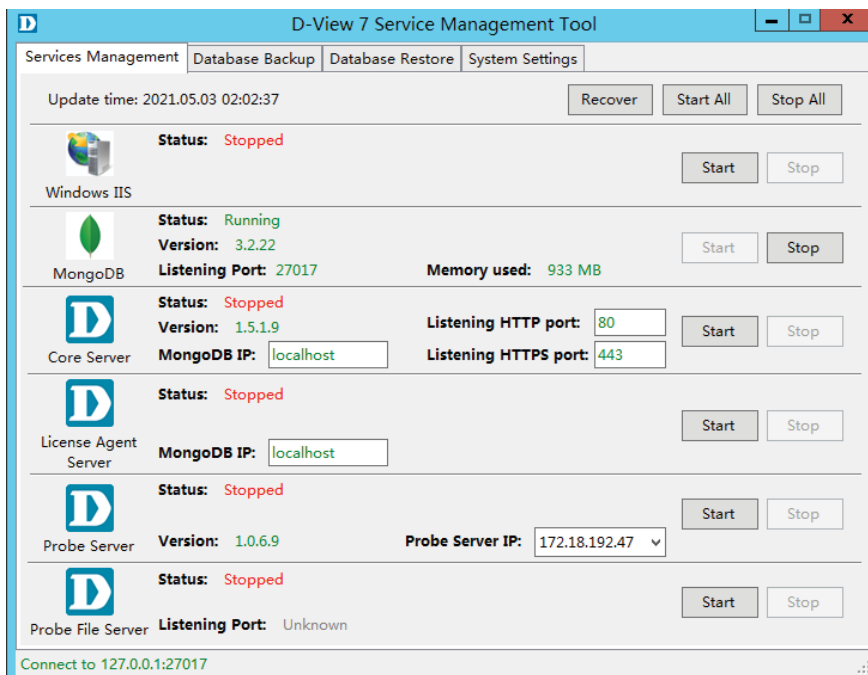

3. Download the D-View 8 package to a local directory.
4. Click on the installation package to begin the installation process. See **2 Installation** for further information.
5. The core listening port must be configured to use the D-View 7 port. (By default, the D-View 7 listening port is set to 80 while the D-View 8 port is set to 17500.) To do this, in the Port Configuration page, locate the Core Port field and change the value to 80.

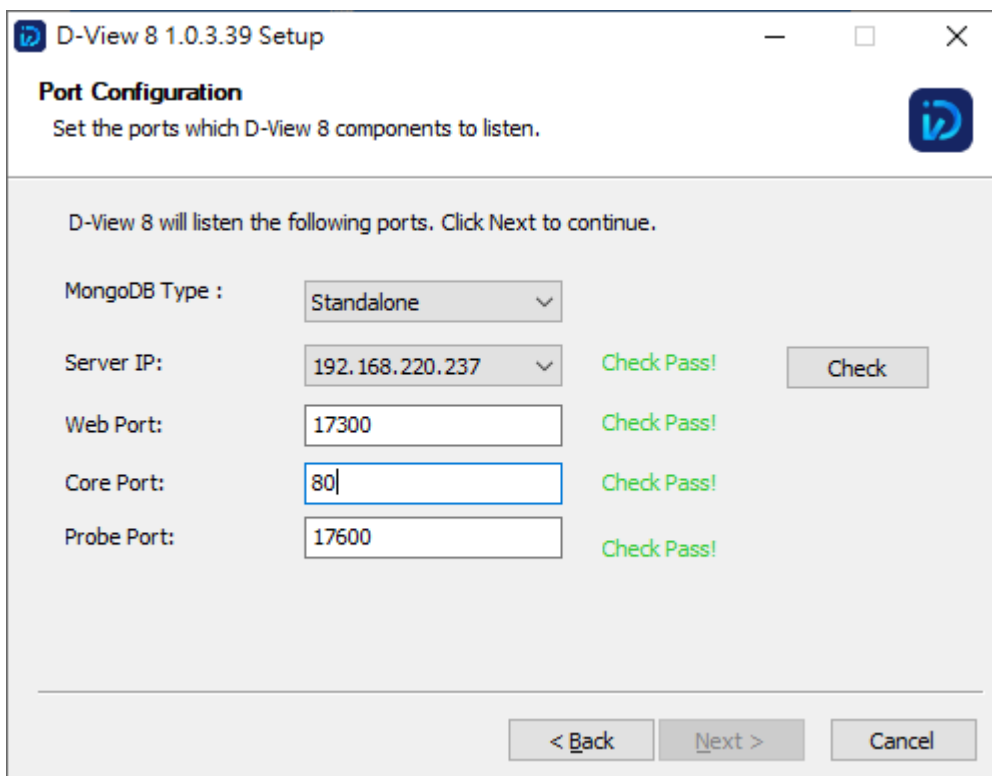

6. Click **Check** to validate the configuration setup. If a connection can be established, the Check Pass! notification displays. Otherwise, check the settings and run the validation process.
7. Click **Next** to continue with the installation process and follow the installation wizard to completely setup the new server.
8. Once the installation of the D-View 8 server is complete, log in to the application interface.
9. The D-View 8 Wizard panel will be displayed as shown below after you log in.

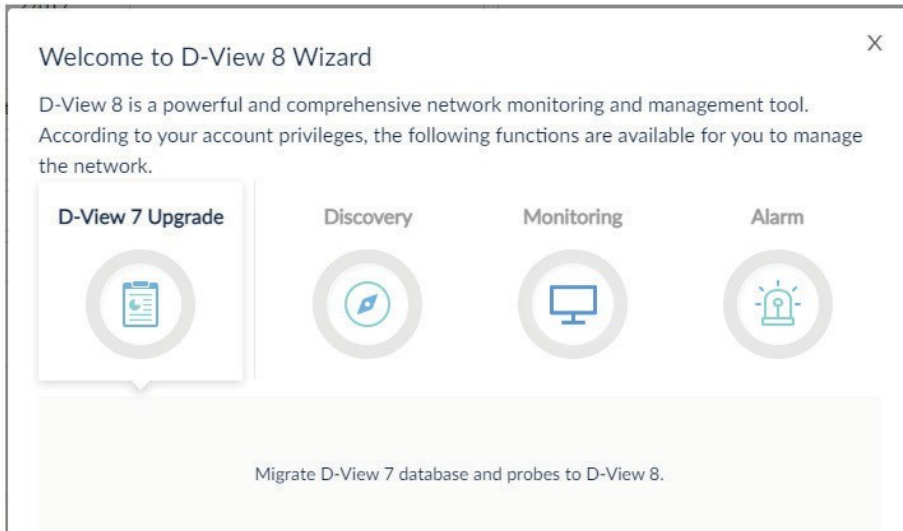

10. In the Wizard panel, click **D-View 7 Upgrade** to begin the process. This will migrate the D-View 7 database and probes to the D-View 8 server.

The Database Migration page displays.

The following settings are required to establish a connection to the D-View 7 MongoDB server:

- In the MongoDB Address field, enter the IP address and port of the MongoDB server (the localhost):

IP address: 127.0.0.1

Port: 27017

- If the D-View 7 MongoDB server was installed using the D-View 7 installation wizard, click the Authentication drop-down menu and select SCRAM-SHA-1 (Mongo 3.x default).

Otherwise select **None**.

- In the Username field, enter the registered profile with administration access (admin).
- Enter the corresponding password for the registered admin profile.
- In the Authentication database field, enter admin.



NOTE: If the Connection attempt fails, select None under Authentication and attempt to establish the connection once again.

11. Click **Connect** to initiate the connection with the D-View 7 MongoDB server.

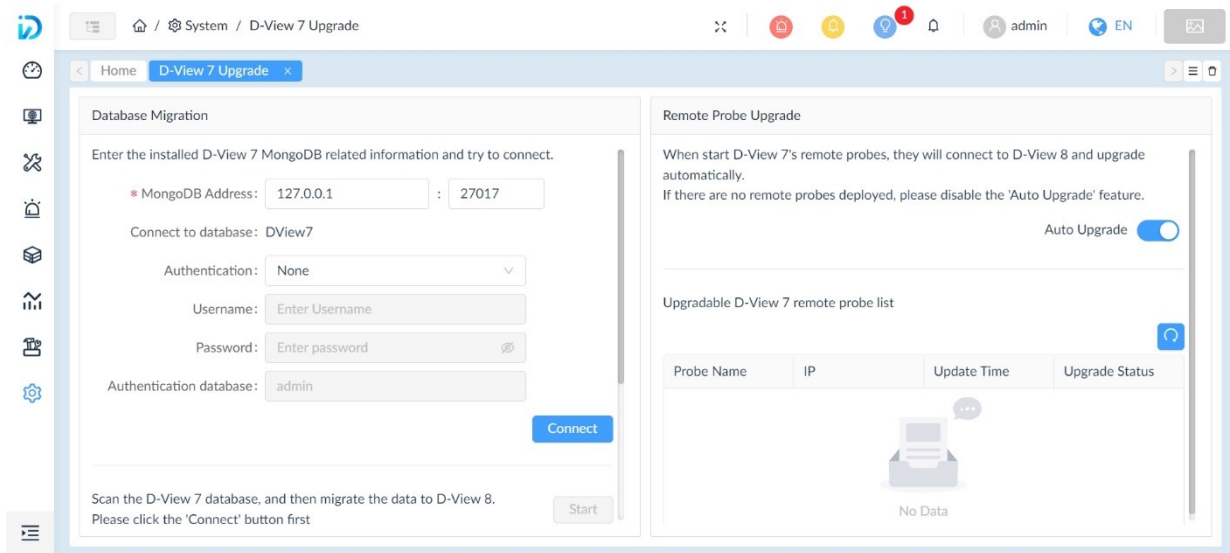

12. The Migrate D-View 7 Database pop-up screen displays. Click Start to begin the migration. The wizard provides step-by-step guidance for the process.
13. Click **Next** to continue, **Previous** to return to the previous step, or **Skip All** to automate the process and complete it.



NOTE: In the event of an interruption in the migration process, restart the process by clicking **System > D-View 7 Upgrade**.

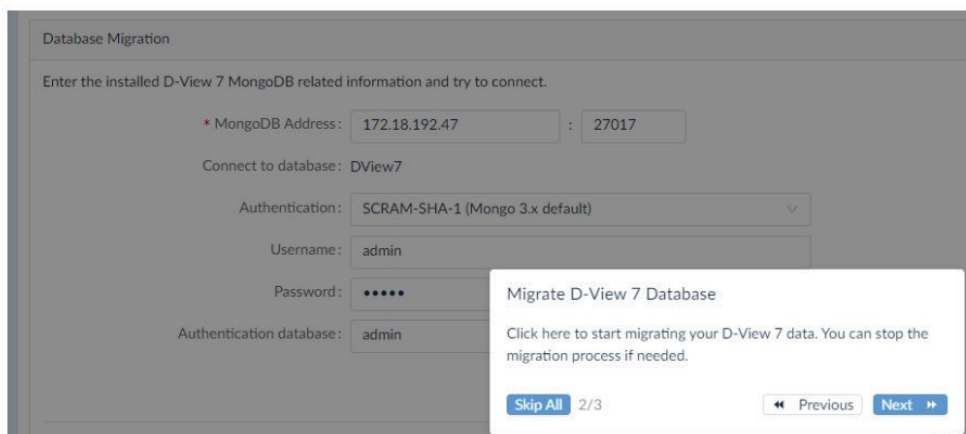

Once the process is completed, the D-View 8 local probes will take over as the bridge to the core server; however, you need to manually upgrade the remote probes (refer to [2.6.4 Upgrade Remote Probes](#)). Moreover, the data of the original D-View 7 MongoDB is retained and imported to the D-View 8 database.



NOTE: After successful migration, it is necessary that the corresponding ports used in D-View 7 being stopped while D-View 8 is running. Stop these services: World Wide Web Publishing Service (Windows built-in service), D-View7 CoreServer, D-View 7 License Agent Server, D-View 7 Probe File Server, and D-View7 Probe Server. To manage services on Windows, Select **Start**, and type **services**. Then click a service in the list and click an action button at the top to start, stop, pause, or resume it.

2.6.4. Upgrade Remote Probes



NOTE: Manual upgrade of remote probes will be required for software versions earlier than 2.0.0.

After the upgrade process is completed with the wizard of the web application, perform manual upgrade for all remote probes.

1. Check the connection status and the IP addresses of the remote probes: go to **System > Server Management** and select the **Probe** tab. The core server and remote probes information can be obtained from the probe list. Note that the remote probes are displayed in red color to indicate disconnection with the core server.
2. Install the probe package on the remote probes by double-clicking on the installation file. A warning message states that it is necessary that you have upgraded the core server to the intended version before upgrading your remote probes to this same version.

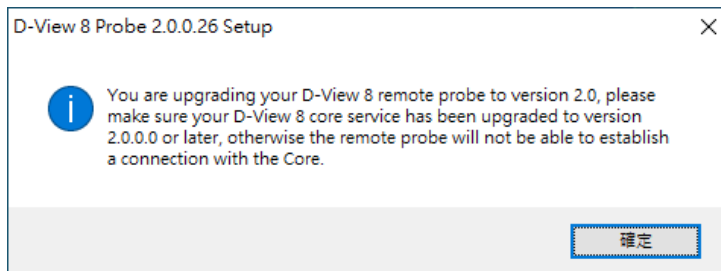

3. Click **Next** when the Welcome page displays.



4. The system automatically detects an older version of probe has been installed. Check **Upgrade My D-View 8 Probe** and click **Next** to continue.

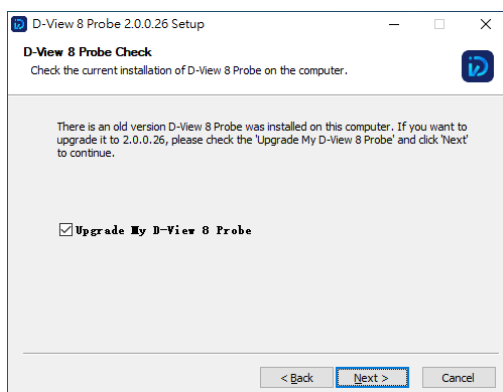

The installation will progress and completes. The remote probe should be upgraded to the desired version.

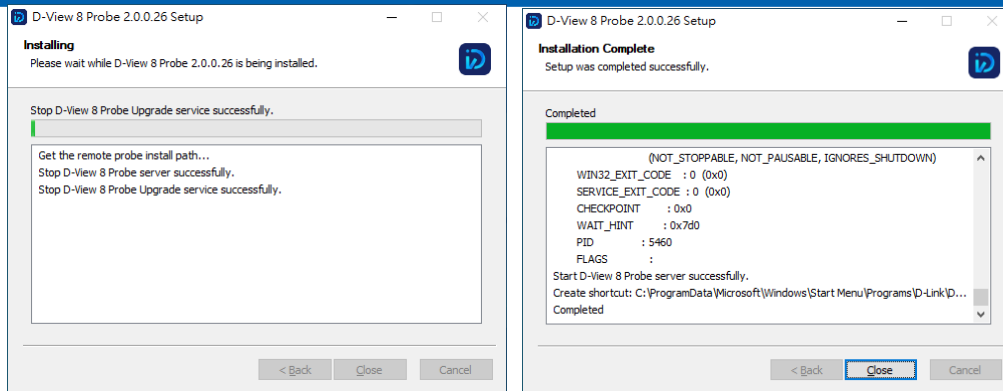

You can now go back to the probe list and check the connection status of the remote probes (**System > Server Management > Probe.**)

3 Overview and Basics

Before connecting to the D-View 8 server, you need to install the required software package. Please refer to **Chapter 2 Installation** for instructions and procedure.

3.1. Login and Basic Configurations

After you log in to the application, it is highly recommended that you change your password and account information and configure the email settings for alert notifications. Refer to the following sections for more information:

- Launch the D-View 8 Web GUI
- Change User Password
- Configure Email Server for Notification

3.2. Launch the D-View 8 Web GUI

The application is accessible through a browser. Before logging in to the application, make sure that the D-View 8 application is installed on a server with a static IP address.



NOTE: The D-View 8 supports multiple concurrent users. Two users can make changes to the same page at the same time. To avoid management discrepancy, it is recommended that users coordinate management activities in advance.

To log in to the application:

1. Open a browser and enter the assigned IP address of the D-View 8 server.
 - If connecting to the same D-View 8 server in which the application is installed, enter localhost and the default port 17300:

<https://localhost:17300>.

If connecting from a remote computer, enter the IP address of the D-View 8 server into the address field of the browser. Before connecting to the D-View 8 server, clear browser cache data. The Sign-in page appears.

- In the account type menu, select the account type of the user:
 - Local:** user account authenticated on a local system.
 - Active Directory:** user accounts authenticated by Microsoft® Active Directory.
 - Enter an account name and a password.
- By default, the administrator's username is **admin** and the default password is also **admin**.

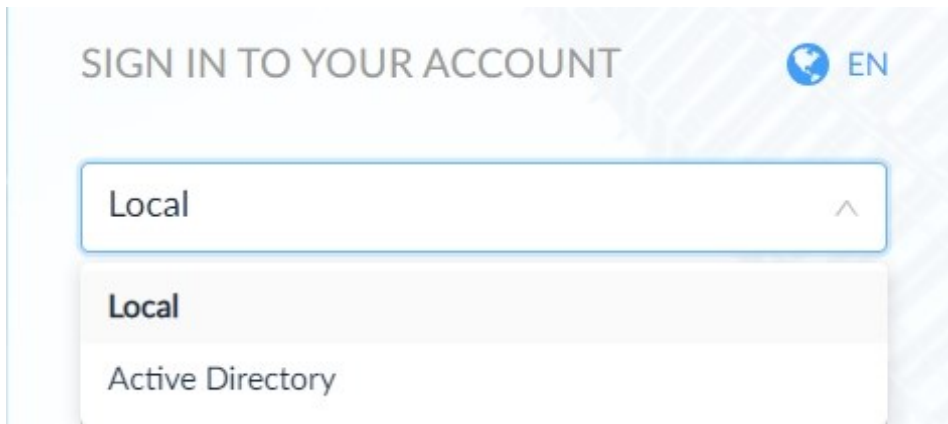

- Click the **Sign In** button to continue. The D-View 8 Dashboard displays.

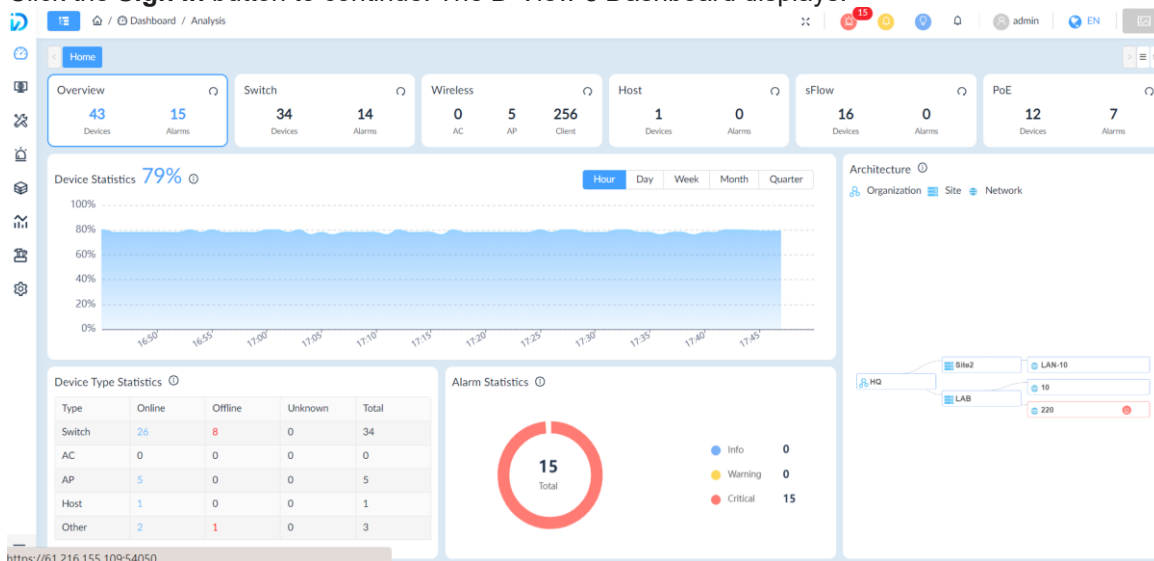

For more information on the **Dashboard**, refer to **3.3 Overview of the Web Dashboard** below.

First Time Login

When a Super Administrator logs into the application for the first time with the above username and password, a wizard will appear. Please select the **Discovery** tab to set up an organization and discover networks with the following guided steps:

- Enter the fields required to fill in information for your organization.
- Click **+ Add Network** to open the “Add Network” window.
- Enter the following information to create a network:
 - Network Name: Enter a name for the network.
 - Site Name: Enter a name for the site.

4. Select the probes. A Primary probe will be required to discover and communicate with devices in the network.
5. Click **+ Add Discovery Range**. The discovery range can be specified with the following methods: IP, IP Range, Subnet, or Import CSV File. Refer to [4.1 Network Discovery](#) for more information.
6. Click the SNMP field and select **Add SNMP Credential**. SNMP is the required protocol for device management.
7. Click Save to save the settings for network discovery.

Please wait while the system is discovering devices in the defined network.

3.3. Overview of the Web Dashboard

The D-View 8 Dashboard features and functionality can be accessed through the menus and toolbar of the web interface. The availability of the tools is determined by a user's role.

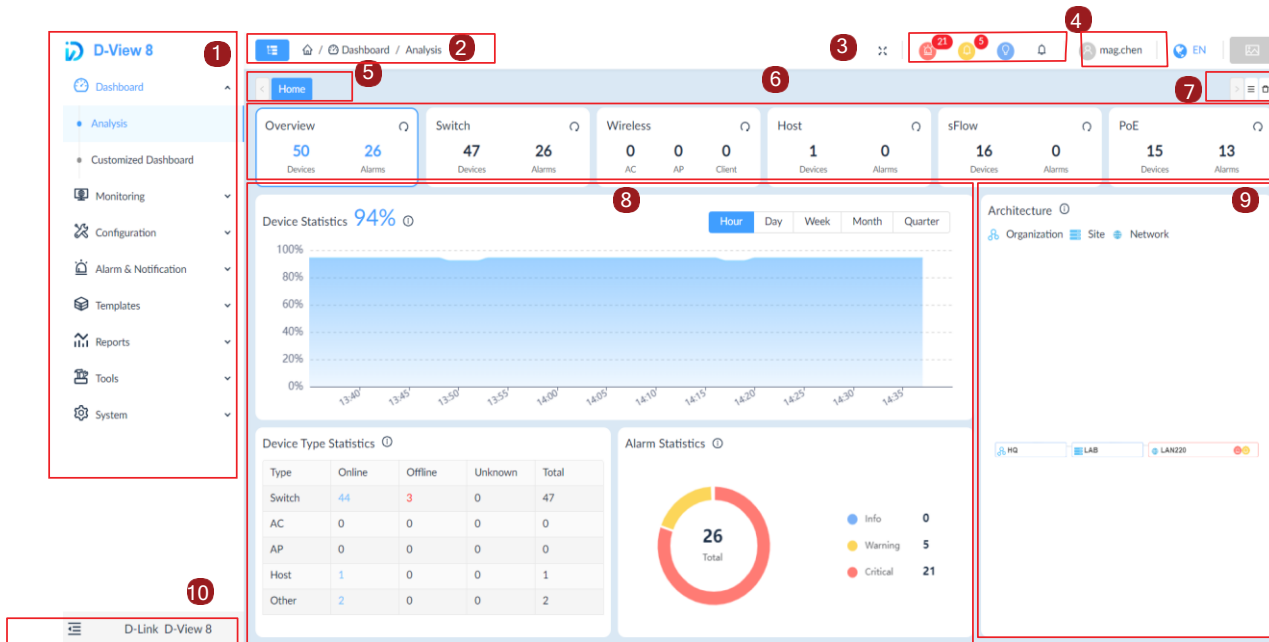

Web Dashboard Annotations			
1.	Main menu	2.	Title bar
3.	Annunciators	4.	User Profile and Wizard
5.	Menu tab	6.	Widget menu
7.	Tab selector	8.	Widget information
9.	Architecture diagram	10.	Collapse/expand sidebar

3.3.1. Common Features

There are several features that are common on the D-View 8 dashboard regardless of the user privilege and license type.

- **Menus** are used to access tools and configurations.
 - Sort and Filter functions help you refine table data.
 - Configuration menus help you access features that are available on a configuration page, which can be accessed through toolbar buttons.
- **Help** menus can be opened by clicking  to obtain additional information relevant to the displayed page.
- **Toolbars** give quick access to the functions or pages of corresponding menu options.
- **Annunciators** offer visual notification of system state or alarms.

3.3.2. Menus and Toolbard

The following section describes the menu and toolbar options available through the D-View 8 dashboard. The menu items are listed along with the corresponding submenus and description.



NOTE: Menu and toolbar options vary depending on the user role, license type, and device type.

System Configuration

Item	Description
Basic Settings	<ul style="list-style-type: none"> • Organization <ul style="list-style-type: none"> ▪ Configures the organization’s name, country, time zone, etc. ▪ Upload the organization logo in PNG or JPG file format (less than 2MB file size) • Mail Server Settings <ul style="list-style-type: none"> ▪ Configures mail server settings • Forward Trap <ul style="list-style-type: none"> ▪ Configures the trap receiver to send incoming device trap messages • Forward Syslog <ul style="list-style-type: none"> ▪ Configures the system log receiver to send device syslog messages • REST API <ul style="list-style-type: none"> ▪ Generating an API key which will be used by other applications to acquire a token from D-View 8 ▪ Third-party applications can use tokens to acquire needed information from D-View 8 • Credentials <ul style="list-style-type: none"> ▪ Configures the SNMP protocol types, community name and related parameters ▪ Configures Windows WMI (Windows Management Instrumentation) and SSH/Telnet communication credentials • sFlow Settings <ul style="list-style-type: none"> ▪ Configures sFlow parameter mapping for different traffic indicators • System Preferences <ul style="list-style-type: none"> ▪ Configures the table display settings and theme of D-View 8
User Management	<ul style="list-style-type: none"> • Users <ul style="list-style-type: none"> ▪ Lists user information: user’s email address, username, login time, authentication type, etc. ▪ Add, delete, remove users. • Role Privileges <ul style="list-style-type: none"> ▪ Lists the types of user role: Organization/ Site/ Network Administrator roles. ▪ Lists each role’s privileges. • AD Server <ul style="list-style-type: none"> ▪ Configures the Windows Active Directory Server’s information.

Item	Description
Scheduling	<ul style="list-style-type: none"> • Configures the “Recurrent Schedule” and “Time-range Schedule” • Recurrent Schedule List <ul style="list-style-type: none"> ▪ Allows users to configure recurrent schedules with customized frequency and duration • Time-range Schedule List <ul style="list-style-type: none"> ▪ Allows users to configure a specific range of time of a designated weekday or weekdays
Server Management	<ul style="list-style-type: none"> • Monitors the status of D-View Core Server, Web Server and Probe • Checks the real-time report of server’s status, which includes the utilization of CPU, memory, hard drive, and the network traffic
D-View 8 Log	<ul style="list-style-type: none"> • D-View 8 features three types of logs: User Operation Log, System Log, and Device Maintenance Log • User Operation Log: <ul style="list-style-type: none"> ▪ Records user operational activity via web interface • System Log: <ul style="list-style-type: none"> ▪ Keeps the records of D-View 8’s running status of servers and probes • Device Maintenance Log: <ul style="list-style-type: none"> ▪ Keeps configuration activity logs for devices
D-View 7 Upgrade	<ul style="list-style-type: none"> • Support for the following upgrade functions: • Database Migration • Remote Probe Upgrade
About Page	<ul style="list-style-type: none"> • The About page keeps the following information: • D-View 8’s edition: Standard or Enterprise • Brief description for the purchased edition • Software version • The latest update time • The number of supported and used nodes • System uptime information • Product license information and activation link • Remaining days of the maintenance license and the license activation link

Dashboard

Item	Description
Analysis	<ul style="list-style-type: none"> • By default, there are six tabs representing major topics or device types in the analysis page: <ul style="list-style-type: none"> ▪ Overview ▪ Switch ▪ Wireless ▪ Host ▪ sFlow ▪ PoE • Provides an overview of alarm statistics, online/offline status of the devices, CPU/memory utilization, performance report, device health, etc. • The information varies according to device type
Customized Dashboard	<ul style="list-style-type: none"> • Customizable dashboard to display specific information

Monitoring

Item	Description
Network Discovery	<ul style="list-style-type: none"> • Configures network discovery parameters, which include: <ul style="list-style-type: none"> ▪ Basic Information: the name of the network and site to discover. ▪ Probe Mode: Choose the primary and secondary probe ▪ Discovery Range: Define the range that may include a single IPv4/v6 address, an IPv4/v6 address range, an IPv4/v6 subnet, or import of IP ranges from a file ▪ Schedule: Define the discovery schedule that may include one-time discovery or recurrent discovery • Displays discovery jobs' running status and related information
Device View	<ul style="list-style-type: none"> • Includes 5 categories: All, Managed, Unmanaged, Ignored and Conflicted • Displays a summary and detailed information of the devices • Detailed information can be accessed via the "System Name" link, which also allows login to a device using different protocols
Interface View	<ul style="list-style-type: none"> • List of devices' network connection properties, which includes: <ul style="list-style-type: none"> ▪ System/Model Name ▪ Device's IP address ▪ Interface and MAC address information ▪ VLAN information ▪ Update time information • Each of the above can be searched to find a specific device
Topology Map	<ul style="list-style-type: none"> • Displays connections between devices for the entire network, site or organization • Displays the online/offline status of devices • Displays link information of devices • PNG or JPG format files can be uploaded as the topology's background image • Supports Star, Tree, Circular and Grid topology layout • Zoom in and out the topology map • Supports customized topologies
Connection View	<ul style="list-style-type: none"> • List of the interface link information which includes: <ul style="list-style-type: none"> ▪ Link status ▪ Link name ▪ Name and IP address of the connected devices ▪ The connected interfaces of the devices ▪ The connected devices and interface information ▪ Traffic statistics of TX and RX ▪ Link utilization ▪ Link type (LACP or general) ▪ Link's related info such as update time ▪ Source of the detection, such as LLDP or FDB • Clicking the link interface name, more detailed information will be displayed, such as: <ul style="list-style-type: none"> ▪ Summary information of the selected link ▪ Monitor information of the selected link ▪ Alarm information of the selected link

Rack View	<ul style="list-style-type: none"> ▪ Provides visualization of the device rack
sFlow Analyzer	<ul style="list-style-type: none"> • Collects the sFlow data from devices and generates related statistics reports • The statistics report information includes: <ul style="list-style-type: none"> ▪ Report based on the source or destination of packets ▪ Report based on QoS rules ▪ Report based on layer 4 applications ▪ Report based on protocols • Report based on conversation of two endpoints
Device Group	<ul style="list-style-type: none"> • Allows users to create device groups to simplify management tasks

Configuration

Item	Description
Batch Configuration	<ul style="list-style-type: none"> • Allows simultaneous configuration of multiple devices' parameters at the same time • Two sub-features: <ul style="list-style-type: none"> • Quick Configuration: a template for each function to apply the settings to multiple devices • Advanced Configuration: a profile for a specific type of device. The profile contains configurations of multiple features. Users can apply the profile to multiple devices of the same type/model.
Task Management	<ul style="list-style-type: none"> • Lists all created tasks to show the execution result with messages indicating a success or failure. It includes both Current and Historical Tasks. If a failure occurs, it will also state the reason of failure.
Firmware Management	<ul style="list-style-type: none"> • Management of devices' firmware centrally • Schedule-based updates of device firmware
Configuration Management	<ul style="list-style-type: none"> • Management of device configuration • Backup or restore of multiple device configuration files at the same time • Schedule-based backup or restore • Supports file baselining
File Management	<ul style="list-style-type: none"> • File comparison of configuration files to verify the differences • Upload of configuration or firmware files on D-View • Set the configuration file as the baselined file for easy comparison or version tracking

Alarms & Notifications

Item	Description
Alarms	<ul style="list-style-type: none"> • Displays all alarm information collected from network devices. The alarms include: <ul style="list-style-type: none"> • Active Alarms <ul style="list-style-type: none"> ▪ Lists all unacknowledged network alarms • Historical Alarms <ul style="list-style-type: none"> ▪ Lists all acknowledged network alarms
Trap & Syslog	<ul style="list-style-type: none"> • Displays the trap and system log receiving from devices. The trap log's information contains: <ul style="list-style-type: none"> ▪ Time received ▪ Device system name ▪ Device IP address ▪ SNMP version ▪ Generic type ▪ Trap description ▪ Original message of the trap • The syslog information contains: <ul style="list-style-type: none"> ▪ Time received ▪ System name of device generating the log ▪ Device IP address ▪ Syslog severity levels ▪ Syslog messages ▪ The associated alarm for the syslog ▪ The site and network of the device
Trap & Syslog Editor	Edits OID description for a specific trap OID Edits syslog description with matched keywords
Monitor & Alarm Settings	<ul style="list-style-type: none"> • Monitor Settings <ul style="list-style-type: none"> ▪ Configure the monitor status and interval for data collection • Alarm Settings <ul style="list-style-type: none"> ▪ Configure alarm rules to generate alarms with threshold values ▪ Configure the CLI commands for devices and D-View 8 servers to execute when the alarm is triggered ▪ Define the alarm properties for customized monitors and alarms
Notification Center	<ul style="list-style-type: none"> • Allows users to set the notification method when alarms are triggered: Web Scrolling Message, Email, and Execute script.

Templates

Item	Description
Device Template	<ul style="list-style-type: none"> • Add a device to be managed by D-View 8 if it's not in the managed device list; a useful tool especially for managing third-party devices • Allows users to customize device's information as the following: <ul style="list-style-type: none"> ▪ Model Name ▪ Device Type ▪ Vendor Name ▪ Device's System OID (SOID) ▪ Panel Template • Allows advanced monitoring and configuration for different device models.
Device Support	<ul style="list-style-type: none"> • Create useful information to manage third-party vendors and devices, which includes: • Vendor <ul style="list-style-type: none"> ▪ Vendor name ▪ Vendor OID • Device Category <ul style="list-style-type: none"> ▪ Category name ▪ Photo of the category • Device Type <ul style="list-style-type: none"> ▪ Type name ▪ Device category ▪ Description
Panel Template	<ul style="list-style-type: none"> • Includes D-Link default device panel templates and customizable panels • Customizable panel details: <ul style="list-style-type: none"> ▪ Panel name ▪ Description ▪ Port type: 10G, 5G, 1G,100M, etc. • Customizable panel diagrams: <ul style="list-style-type: none"> ▪ Panel logo (PNG/JPG files less than 2 MB in size) ▪ Panel height and width • Port numbering scheme • Port layout design
Monitor Template	<ul style="list-style-type: none"> • Provides different monitoring templates for collection of device information • Multiple monitor templates can be associated with Device Template to monitor specified devices. • Customizable categories to identify specific monitoring data source. The following properties are available for each category: <ul style="list-style-type: none"> ▪ Category name ▪ Unit (-, °C, %, bits, bps, ms, pps, rpm) ▪ Protocol (WMI, SNMP/ HTTP(S)) ▪ Line chart (not supported, default/supported) ▪ Build type (system / user) ▪ Description ▪ Operation (User type: edit, delete; System type: view only) • Customizable Monitor Template to monitor and collect defined data source <ul style="list-style-type: none"> ▪ Template name ▪ Category ▪ Vendor name ▪ Monitoring Interval

	<ul style="list-style-type: none"> ▪ Build type ▪ Description <p>• Operation (User: edit, download, delete; System: download, view)</p>
Configuration Template	<ul style="list-style-type: none"> • Configuration Template: Provides multiple configuration templates to configure devices • Multiple configuration templates can be associated with Device Template to configure devices. • Customizable Configuration Template to configure specified devices with the following properties: <ul style="list-style-type: none"> ▪ Vendor name ▪ Template description ▪ Selected configuration template for engineering view ▪ Protocols (SSH/Telnet or SNMP) ▪ CLI commands list (if selected) • Programmable graphical objects to customize layout and control elements

Reports





Item	Description
General Reports	<p>Each report type has distinctive configurable parameters such as data source and data collection time interval. When reports are generated, they can be exported immediately, saved to My Report, or upgraded to Scheduled Report . The following types of reports are available:</p> <ul style="list-style-type: none"> • Device Reports • Device Health • Trap • Syslog • Device Top N • Wired Interface Reports • Wired Traffic • Wired Throughput Top N • Wireless Reports • Wireless Client Count • Wireless Traffic • Advanced Reports • Inventory
Scheduled Reports	<ul style="list-style-type: none"> • Reports can be a one-time report or recurrent report.
My Reports	The My Reports category displays the saved list of reports categorized as My Reports from the general report category. Up to 500 report entries can be saved.

Tools

Item	Description
MIB Browser	<ul style="list-style-type: none"> • Retrieves and displays MIB data in readable format • Provides a graphical interface to read MIB information
MIB Compiler	<ul style="list-style-type: none"> • Compiles device MIB files into D-View 8. The MIB Compiler allows users to compile standard or proprietary MIBs but does not accept malformed MIBs. The compiled MIB file can then be loaded and managed only in the MIB browser.
ICMP Ping	<ul style="list-style-type: none"> • Checks device operation status and network performance
SNMP Test	<ul style="list-style-type: none"> • Checks device SNMP capabilities using SNMPv1, SNMPv2c or SNMPv3
Trace Route	<ul style="list-style-type: none"> • Checks the route and measures transmit delay of packets across the network • Terminal interface for users to connect with the device
Command Line Inter- face (CLI)	<ul style="list-style-type: none"> • Terminal interface for users to connect with the device
File Comparison	<ul style="list-style-type: none"> • Lets user check differences between two configuration files • Differences are highlighted in colors

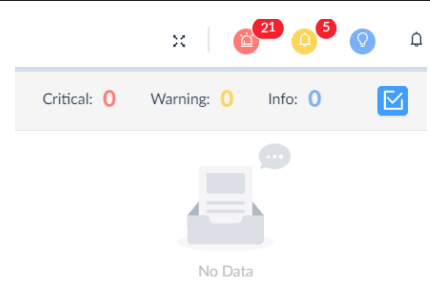
3.3.3. Annunciator

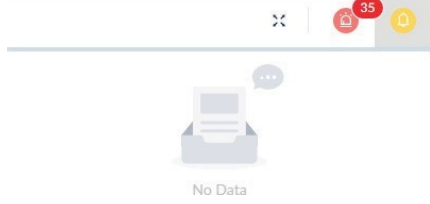
The Annunciator is typically located at the top right of the application webpage to notify users of the system status. The following are the different types of alarms displayed via the annunciator:

Item	Description	Icon
Notifications	Defined events to send notifications when an alarm is triggered	
Info Alarm	Information regarding system function requiring further attention to maintain proper system operation or to avoid unintended result.	
Warning Alarm	Information regarding system errors or faults that may affect system operation.	
Critical Alarm	Information regarding system errors or faults and requiring immediate attention and remediation to prevent further damage.	

User Menu

Item	Description
User Profile	Displays information about the current user
Wizard	<ul style="list-style-type: none"> • D-View 7 Upgrade: migrate D-View 7 database and probes to D-View 8 (only available to Super Administrator) • Discovery: discover the network and add devices to the network • Monitoring: create customized topologies, rack display, and customized dashboards • Alarm: customize related network alarms and notifications
Network Discovery Records	Displays the record of the discovered networks
Sign out	Sign out the current user from the application

3.3.4. Workspace Preferences

The D-View 8 workspace starts with a standard configuration displaying the available system and network information. Through the interface, you can quickly obtain the corresponding settings of the information displayed on the dashboard.

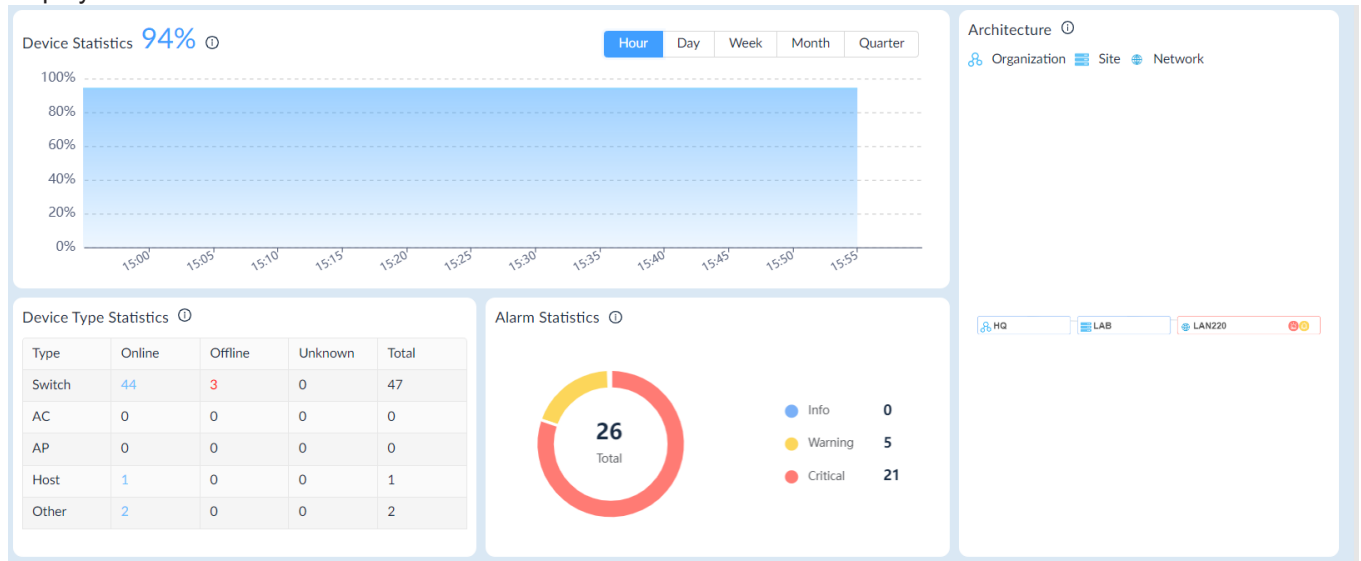

The workspace is designed for complete visibility and control of the entire network.

To view specific information, click on the link of the content.

3.4 Change User Password

It is highly recommended that you change your password for better security. An administrator can also create users within his administrative domain (i.e. a Super Admin can create users for an organization, a site, or a network while an Organization Admin can create users for only a site or a network.)

To change your password:

1. Log in to the Dashboard, see 0 .
2. Locate the User Profile Menu under the account name.

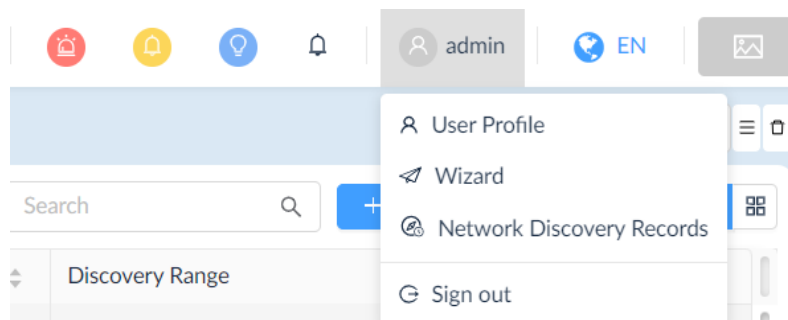

3. Select **User Profile** to display the user's profile page.

The Personal Information page displays.

Personal Information

Nickname:

Location:

Telephone:

Description:

Change Password

* Current Password:

* New Password:

* Confirm Password:

Reset Password

Click the 'Reset' button, the system will send an email to the address associated with your account. You can reset your password by clicking the link in the email.

4. Under the **Change Password** section, enter the Current Password.
5. Enter a New Password, then type the New Password again.
6. Click **Save** to save the new settings. The password will be updated.

you can also modify your account information such as name and email address as well as automatic sign-out time.

3.5 Configure Email Server for Notification

Prior to sending notifications, an Email server must be configured. Only an Organization-privileged Administrator or a Super Administrator can configure the email server settings.



NOTE: For information about generating notifications when an alarm is triggered, refer to the below 3.6 Configure the Notification Center.

To configure mail server settings:

1. Click the **System**  and select **Basic Settings**.

Select the **Mail Server Settings** tab. The **Mail Server Settings** page displays.

D-View 8 URL

* D-View 8 URL:

Mail Server

* SMTP Host:

* Port: (1 to 65535)

* Sender Email Address:

* Sender:

Security Type:

Encoding Type:

Authentication:

* Username:

* Password:

Test Mail Server

- In the D-View 8 URL field, enter the URL with the correct port, for example, <https://63.216.155.109:59800>. This information will be used for email verification of user accounts and appear in password reset emails.
- Under **Mail Server**, enter the following information:

Item	Description
SMTP Host	Enter the address of the SMTP server.
Port	Enter the SMTP port of the outgoing email server.
Sender Email Address	Enter the sender's email address.
Sender	Enter the sender's name for the outgoing email
Security Type	Select the encryption method used by the outgoing mail server (optional): None or SSL.
Encoding Type	Select the character encoding method which converts the sequence of bytes into characters:UTF8 or ASCII (optional).
Authentication	Enter the authentication method for use with the server: Anonymous or SMTP Authentication. If SMTP Authentication is selected, enter the following: <ul style="list-style-type: none"> • Username: Enter the authorized username to access the server. • Password: Enter the password.
Save	Click Save to save the Mail Server settings.

- In the Test Mail Server field, enter a valid email to send a test email to verify the above mail server settings.

3.6 Configure the Notification Center

Notifications are messages that the system sends via emails or the notification display of the D-View 8 application. It provides you with timely information that requires your attention. The notifications can be easily accessed from the display at the top right of the D-View 8 web application. The Notification Rule is generated according to a monitoring condition with the triggered alarm level. Only an Organization-privileged Administrator or a Super Administrator can configure notification settings.

- Log in to the Dashboard, refer to [3.2 Launch the D-View 8 Web GUI](#).
- Click the **Alarm & Notification > Notification Center**.

The **Notification Center** page displays.

- Click **+ Add Notification Rule**.

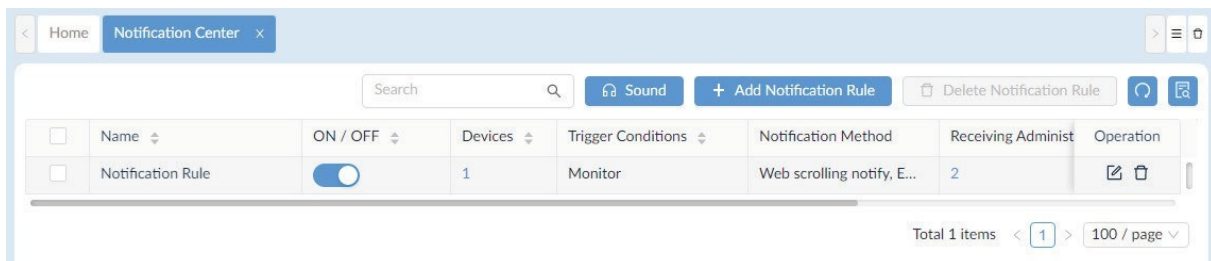

The **Notification Management Details** page displays.

- Fill in the Basic Information.

- Click the **ON/OFF** button to enable or disable the rule.

Notification Management Details

Basic Information

* Name: Notification Name

Description: Description of notification

ON / OFF:

Source Devices

+ Add

System Name	IP	Network	Model Name	Operation
No Data				

Total 0 items < 0 > 15 / page

Trigger Conditions

* Condition Type: Monitor Please choose one or more

* Alarm Level: All Critical Warning Info

Cancel Save

- In Source Devices, click **Add** to select target devices. The Batch Select Devices page displays.
- From the Device List, select the device(s) to which the notification rule will be applied.

Batch Select Devices

Resource Tree

Search network

- Beijing
- USA
 - RD
- Tokyo
- Taipei
- London
- Paris

Device List

Search

	System Name	IP	Network	Model Name
<input checked="" type="checkbox"/>	D-Link	172.18.193.253	Marketing	DES-3226STK
<input type="checkbox"/>	N/A	172.18.193.237	Marketing	Other
<input type="checkbox"/>	N/A	172.18.193.235	Marketing	Other
<input type="checkbox"/>	N/A	172.18.193.234	Marketing	Other
<input checked="" type="checkbox"/>	ACC_SW_STAC...	172.18.193.230	Marketing	DES-3028
<input type="checkbox"/>	ACC_SW_DES_...	172.18.193.226	Marketing	DES-3026
<input type="checkbox"/>	LAB_Uni_SW_3...	172.18.193.212	Marketing	DGS-3120-24TC
<input type="checkbox"/>	MAIN_AC1	172.18.193.209	Marketing	DWS-3160-24PC
<input type="checkbox"/>	4433	172.18.193.204	Marketing	DAP-2680
<input type="checkbox"/>	SASACK_SW_3...	172.18.193.199	Marketing	DES-3552
<input type="checkbox"/>	DLINK-WLAN-AP	172.18.193.184	Marketing	DWL-8500AP
<input type="checkbox"/>	N/A	172.18.193.163	Marketing	Other
<input type="checkbox"/>	N/A	172.18.193.161	Marketing	Other

Total 95 items < 1 2 3 4 5 6 7 > 15 / page Go to

Cancel OK

- Click **OK** to accept the device selection and return to the previous menu.

9. Under **Trigger Conditions**, click the **Condition Type** drop-down menu to define a condition that generates notifications.

The screenshot shows the 'Trigger Conditions' configuration interface. It includes sections for 'Trigger Conditions', 'Notification Details', 'Scrolling Settings', and 'Notification Receiving Administrator'. The 'Condition Type' dropdown menu is open, displaying a list of monitoring conditions. The 'Response Time' option is currently selected. Below the dropdown, there are checkboxes for 'All' and 'Critical' alarm levels. The 'Notification Method' is set to 'Web Scrolling Message'. In the 'Scrolling Settings' section, the 'Sound' is set to 'Enabled'. The 'Notification Receiving Administrator' section shows a table with columns for 'Email', 'Username', 'Role', and 'Operation', with a '+ Add' button to the right.

The following table displays available options for trigger conditions:

Item	Description
Condition Type	
	The availability of monitoring conditions varies depending on the selected device model.
Monitor	<ul style="list-style-type: none"> • CPU Utilization • DHCP Server Status • Device Common Information • Fan • HTTP Status • LACP • LLDP • Memory Utilization • Private Port • RMON Status • Response Time • SNTP Status • SSH Status • STP Status • Safeguard Status • Syslog Status • Telnet Status • Trap Status • Wireless Access Points • Wireless Error Packets
Trap	Select Trap as the condition type for notification so that alarms triggered by the trap alarm rules will also generate notifications. To configure trap alarm rules, go to Alarm & Notification > Monitor & Alarm Settings > Alarm Settings , from the Type pane, select the Trap category.
Syslog	Select Syslog as the condition type for notification so that alarms triggered by the syslog alarm rules will also generate notifications. To configure syslog alarm rules, go to Alarm & Notification > Monitor & Alarm Settings > Alarm Settings , from the Type pane, select Syslog .
Wired Traffic	Select Wired Traffic as the condition type for notification so that alarms triggered by wired traffic alarm rules will also generate notifications. To configure wired traffic alarm rules, go to Alarm & Notification > Monitor & Alarm Settings > Alarm Settings , from the Type pane, select Monitor > Wired Traffic .

Alarm Level	<p>Select the level of severity that will activate the notification: All: all severity levels will activate the notification. Or select one of the following alarm levels: Critical: error information indicating failure or malfunction. Warning: error information that may cause future problems Info: information-only alarm level</p> <p>Note that there must be an alarm rule with the corresponding severity level for the notification to take effect.</p>
-------------	--

10. Under **Notification Details**, select the method to deliver the notification.

Item	Description
Notification Method	Configure the respective settings for each of the following notification methods.
Web Scrolling Message	Select whether to enable the sound: Mute or Enable Voice.
Email	<ul style="list-style-type: none"> • Click the Current Administrator to automatically select the current admin user. • Click Add to select another user to receive email notifications. You can select criteria (Email, Username, or Role) to search for a user. • Click OK to accept. Click Cancel to return to the previous screen.
Execute Script	<ul style="list-style-type: none"> • In the Command Line, enter a script to automate a task or modify device properties or status on the source devices (Itself) or devices other than the source devices (Other Devices) when a notification is generated. • For Other Devices, select the devices to run the script. To execute a script, you need to provide credentials to log in to the system remotely. • The Acknowledge Alarm after Script Execution parameter can be used to terminate the repetitive execution of the script. For each execution of the script, the alarm will be automatically acknowledged. Enter the total Number of Repetitions (1-100) and Cycle Time (5-1440) minutes. The automatic script execution will stop when the maximum number of repetitions has been reached in the defined cycle time.

11. Under the **Notification Suspension Period**, click **Add** to select a pre-defined schedule. Or click **Add Schedule** to add a new schedule. The schedule prohibits delivery of notifications at the specified time range of a designated weekday or weekdays for the effective duration of dates.
12. Click **Save** to accept the notification rule or **Cancel** to return to the previous screen. For more detailed instructions, refer to [7.6 Manage Notifications](#).

4 Organizations and Networks

Before you can manage your network, you must let the application find the devices on your network.

This chapter covers the following topics:

- Network Discovery
- Manage Wired and Wireless Devices on a Network
- Manage Device Groups
- SNMP Configuration
- Manage Multiple Networks with Batch Configuration

4.1. Network Discovery

D-View 8 is designed to utilize probes to connect network devices. Probes run as a background process, discovering devices, polling devices for statistics, and forwarding data to the D-View 8 server if devices are on other networks behind a firewall or in an NAT environment.

D-View 8 probes are not limited to D-Link products and will communicate with any network device that supports standard reporting protocols based on SNMP.

Deploying probes on servers for each network segment helps preserve bandwidth, as data is collected by the probe before being forwarded to the D-View 8 server to be compiled and analyzed. This reduces network overhead by reducing the number of open connections and the need to have all the devices communicating directly with the server. Separating network devices into groups also simplifies management.

Probes are also responsible for executing commands received from the application's administrator on devices that are connected to the probe. Examples of this would be scheduling a reboot, managing event logs, or making changes to device configuration.

With network and device discovery, D-View 8 can discover wired devices and wireless devices such as access points and switches, no matter D-Link devices or third-party devices supporting standard SNMP MIBs.

Network Discovery allows an administrator to monitor and manage active networks configured with the D-View 8 server. Each network is displayed in the Architecture pane of the Dashboard. The number of managed devices is also displayed, along with device statistics, alarm statistics and an overview for all discovered devices.

4.1.1. Add Network for Discovery

The application is accessible through a browser. Before logging in to the application, make sure that the D-View 8 application is installed on a server with a static IP address.



NOTE: When a Super Admin logs into the D-View 8 application for the first time with the default username/password, a wizard will appear, please select **Discovery** to be guided through the Network Discovery process, which requires you to set up an organization first.

To add a network:

1. Go to **Monitoring > Network Discovery**.
2. Click **+ Add Network**.

The screenshot shows the 'Network Discovery' page with a table of networks. The table has columns for Site, Network Name, Probe Status, Managed Device, Auto-Managed, Latest Discovery Status, Discovery Range, and Operation. Two networks are listed: 'CS' with Network Name 'Beijing_Marketing' and 'site_sim' with Network Name 'Shanghai_Finance'.

Site	Network Name	Probe Status	Managed Device	Auto-Managed	Latest Discovery Status	Discovery Range	Operation
CS	Beijing_Marketing	Primary; LocalProbe-172....	29	Enabled	End	1. 172.18.192.1/2	[Edit] [Refresh] [Delete]
site_sim	Shanghai_Finance	Primary; LocalProbe-172....	101	Enabled	End	1. 2.0.0.0~2.0.0.9	[Edit] [Refresh] [Delete]

Total 2 items < 1 > 100 / page

The Add Network page displays.

The 'Add Network' form is shown with a sidebar on the left containing 'Basic Information', 'Probe Mode', 'Discovery Range', and 'Schedule'. The 'Basic Information' section includes fields for 'Network Name' (text input), 'Site Name' (dropdown menu with a 'New' button), and two checked checkboxes: 'Discover all pingable devices' and 'Manage SNMP devices and WMI servers automatically'. The 'Probe Mode' section has 'Primary' and 'Standby' dropdown menus. The 'Discovery Range' section features a table with columns 'Discovery Range', 'Type', 'Credentials', and 'Operation', and a '+ Add Discovery Range' button. The table is currently empty with a 'No Data' message and a printer icon. At the bottom right are 'Cancel' and 'Save' buttons.

3. Enter the new network information for discovery:

Item	Description
Basic Information	
Network Name	Enter a text string to name the new network.
Site Name	Click the drop-down menu to select an existing site or click New to name this site.
Discover all pingable devices	Enable or disable the function to discover all devices that respond to the ping command automatically. The default is enabled.
Manage SNMP devices and WMI servers automatically	Enable or disable the automatic management of all SNMP or WMI devices. If it is not selected, all detected devices via SNMP will be placed under the Unmanaged category. The default is enabled.
Probe Mode	
Primary	Click the drop-down menu to select the primary probe. NOTE: If a probe is identified as primary, it cannot be designated as a standby probe.
Standby	Click the drop-down menu to select the standby probe. The Standby probe is a backup probe in case the primary probe fails.

Item	Description
Discovery Range	
Add Discovery Range	Click the Add Discovery Range button to define a range for network search.
Discovery Range	List of the configured range settings. See “ Add a Discovery Range ” below for further information.
SNMP Credentials	Click the SNMP field and select the credential version for discovery: SNMP v3 , SNMP v2c , SNMP v1 , or Add SNMP Credential . The available credentials are set via the Basic Settings menu (go to System > Basic Settings and click the Credentials tab; refer to Set Up Credentials .) If you would like to add a new SNMP credential, click Add SNMP Credential .
WMI Credentials	Click the WMI field and select the credential for discovery or click Add WMI Credential . The available credentials are set via the Basic Settings menu (go to System > Basic Settings and click the Credentials tab; refer to Set Up Credentials .) If you would like to add a new WMI credential, click Add WMI Credential .
Edit	Click the Edit button to modify the discovery range.
Delete	Click the Delete button to remove the discovery range.
Schedule Information	
Schedule Type	<ul style="list-style-type: none"> • One Time: Select this option to specify a date and time or immediately to initiate the network discovery. • Recurrent: Select this option to specify the frequency and effective time frame to initiate network discovery. Refer to 14.2 Scheduling for more information.
Cancel	Click Cancel to return to the previous page.
Save	Click Save to add the new network.

Add a Discovery Range

To add a discovery range:

1. Go to **Monitoring > Network Discovery**.
2. The **Network Discovery** information displays.

Site	Network Name	Probe Status	Managed Device	Auto-Managed	Latest Discovery Status	Operation
Taipei	Finance	Primary: LocalProbe-172....	0	Enabled	End	Edit Delete Refresh Close
Taipei	Marketing	Primary: LocalProbe-172....	95	Enabled	End	Edit Delete Refresh Close
London	Sales	Primary: LocalProbe-172....	0	Enabled	End	Edit Delete Refresh Close
Tokyo	Supply	Primary: LocalProbe-172....	0	Enabled	End	Edit Delete Refresh Close
Beijing	Manufacture	Primary: LocalProbe-172....	0	Enabled	End	Edit Delete Refresh Close
USA	RD	Primary: LocalProbe-172....	0	Enabled	End	Edit Delete Refresh Close
Paris	Sales	Primary: LocalProbe-172....	0	Enabled	End	Edit Delete Refresh Close

Total 9 items < 1 > 15 / page

3. Click **+ Add Network** to add a new network. To add a discovery range under an existing network, select a network and click **Edit**.

4. Select **Probe Mode** and click **Add Discovery Range** or **Edit Discovery Range**. The Add Discovery Range or **Edit Discovery Range** screen displays.

Add Discovery Range
✕

Type: IP IP Range Subnet Import CSV File

IP Protocol: IPv4 IPv6

Starting IP:

Ending IP:

Cancel
OK

Item	Description
Type	Click to select the coverage range: IP, IP Range, Subnet, Import CSV File.
IP Protocol	Enter a single IP address as the discovery range. Select either IPv4 or IPv6 IP protocol.
IP Range	Enter the starting IP and ending IP addresses to define the range. <ul style="list-style-type: none"> • Use Starting IP to express the start of the discovery range. • Use Ending IP to express the end of the discovery range.
Subnet	Enter the subnet address in CIDR notation (e.g. 172.17.2.0/24 for IPv4 addressing or 2001:db8:abcd:0012::0/64 for IPv6 addressing) to define the discovery range. Select IPv4 or IPv6 to specify the IP protocol.
Import CSV File	<p>Click Select File to select a pre-configured file.</p> <p>The following shows how the data should be recorded in the CSV file:</p> <ol style="list-style-type: none"> 1. The import file extension must be “.csv”. 2. Each line must contain no more than one discovery rule. 3. Use a comma “,” to separate the parameters for each discovery rule: 4. The order of SNMP v2 parameters is: Discover IP, SNMP Version, Read-Only Community, RW Community. 5. The order of SNMP v3 parameters is: Discover IP, SNMP Version, Username, Mode, Auth Algorithm, Auth Password, Private Algorithm, Private Password. 6. Parameters can be set to the following values: <ul style="list-style-type: none"> ▪ Security Level: authNoPriv, noAuthNoPriv, Auth. ▪ Auth Protocol: MD5, SHA ▪ Privacy Protocol: AES, DES. 7. The “Discovery IP” can be a single IP, an IP range, or a subnet. 8. Use “Start IP - End IP” to express the IP range. The starting IP expression cannot be greater than the ending IP expression. 9. Use “IP/subnet mask” to express a subnet. 10. The “Import CSV File” method only supports discovery of SNMP V1/V2/V3 devices. The acceptable “SNMP Version” values are “V1, v1, V2, v2, V3, v3”. 11. The number of IP addresses defined in the CSV file must not exceed 5,000. 12. The file size must not exceed 1 MB. <p>Sample rules:</p> <pre> 192.168.1.10,v2,public,private 192.168.1.15-192.168.1.17,v2,public,private 192.168.2.0/24,v2,public,private 192.168.1.1,V3,user,noAuthNoPriv 192.168.1.1-192.168.1.17,V3,user,AuthNoPriv,SHA,password 192.168.1.0/24,v3,user,authPriv,MD5,password,AES,password </pre>
Cancel	Click Cancel to return to the previous page.
OK	Click OK to add the new range.

- Under the **Discovery Range** section, select an existing range and click the **Credentials** field.
- Click **Add SNMP Credential** or **Add WMI Credential** to define a new SNMP or WMI credential or select a pre-defined credential. Refer to **Set Up Credentials** in [14.1 Configure Global Settings](#) for more information about WMI and SNMP credentials.

Discovery Range			
Discovery Range	Type	Credentials	Operation
192.168.220.150-192.168.220.240	IP Range	* SNMP: <input type="text" value="SNMP v2c default x"/> <input type="text" value="SNMP v1 default x"/> WMI: <input type="text" value="Please select WMI credentials"/>	
192.168.110.100-192.168.110.120	IP Range	* SNMP: <input type="text" value="SNMP v2c default x"/> <input type="text" value="snmpv3166659487277... x"/> WMI: <input type="text" value="Please select WMI credentials"/>	

Total 2 items < 1 > 200 / page v

If Add SNMP Credential is selected, the **Add SNMP Credential** page displays.

Add SNMP Credential
X

SNMP Protocol Version: SNMP v1 SNMP v2c SNMP v3

* Name:

* Port:

* Timeout [s]:

* Retransmit:

* Read Community:

Write Community:

* Non-Repeaters:

* Max-Repetitions:

Description:

Sharing Status : OFF

If Add WMI Credential is selected, the **Add WMI Credential** page displays.

Add WMI Credential
X

* Name:

Domain Name:

* Username:

* Password:

Description:

Sharing Status : OFF







Note the added entry will be listed in the Credentials tab (go to **System > Basic Settings**).

4.1.2. Execute Network Discovery

The D-View 8 provides quick discovery of devices in a defined network.

To execute a discovery job:

1. Go to **Monitoring > Network Discovery**.
2. Select an existing network profile and click **Discover**  to start detecting devices in the network.

Site	Network Name	Probe Status	Managed Device	Auto-Managed	Latest Discovery Status	Discovery Range	Operation
Taipei	Finance	Primary: LocalProbe-172... ●	0	Enabled	● End	1. 3.3.3.3; 2. 4.4.4.4; 3. 5.5.5.5; 4. FE80::E12E:4A92:C840:EF7A-FEF7F;	  
Taipei	RD	Primary: LocalProbe-172... ●	0	Enabled	● End	1. 1.1.1.3;	  

The Latest Discovery Status field displays the discovery result.



For example, it displays Running when the discovery is in progress

The Discovery Results page displays. The list of discovered devices will be shown.

LAN220

The network scan was successful. You can see the results below.

- 192.168.220.150**
A device was discovered. Protocol used: SNMP. Device category: Switch
- 192.168.220.152**
A device was discovered. Protocol used: SNMP. Device category: Switch
- 192.168.220.153**
A device was discovered. Protocol used: SNMP. Device category: Switch
- 192.168.220.154**
A device was discovered. Protocol used: SNMP. Device category: Switch
- 192.168.220.155**
A device was discovered. Protocol used: SNMP. Device category: Switch
- 192.168.220.156**
A device was discovered. Protocol used: SNMP. Device category: Switch
- 192.168.220.157**
A device was discovered. Protocol used: SNMP. Device category: Switch







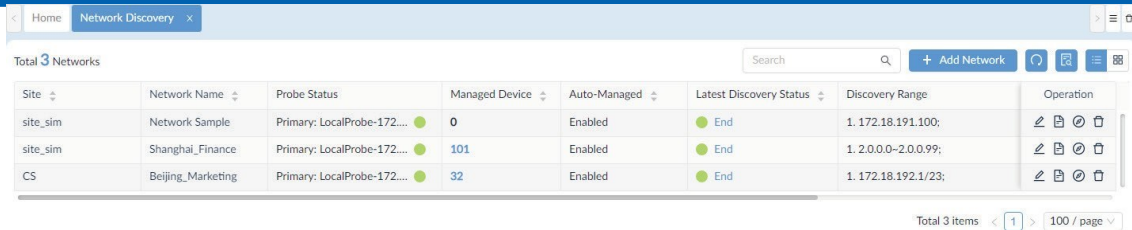

4.1.3. Modify or Delete a Network Discovery Profile

If you delete a network discovery profile from the network list, the system deletes the profile along with the device information.

1. Go to **Monitoring > Network Discovery**. The **Network Discovery** information displays.



The screenshot shows a web interface for Network Discovery. At the top, there are tabs for 'Home' and 'Network Discovery'. Below the tabs, there is a search bar and a '+ Add Network' button. The main content is a table titled 'Total 3 Networks'. The table has columns for Site, Network Name, Probe Status, Managed Device, Auto-Managed, Latest Discovery Status, Discovery Range, and Operation. There are three rows of data.

Site	Network Name	Probe Status	Managed Device	Auto-Managed	Latest Discovery Status	Discovery Range	Operation
site_sim	Network Sample	Primary: LocalProbe-172... ●	0	Enabled	● End	1. 172.18.191.100;	  
site_sim	Shanghai_Finance	Primary: LocalProbe-172... ●	101	Enabled	● End	1. 2.0.0.0~2.0.0.99;	  
CS	Beijing_Marketing	Primary: LocalProbe-172... ●	32	Enabled	● End	1. 172.18.192.1/23;	  

At the bottom right of the table, there is a pagination control: 'Total 3 items' followed by a page number '1' in a box and '>' and '100 / page' with a dropdown arrow.

2. You can obtain more information about the network discovery profile by clicking **Network Information** . It also provides detailed information about probes.

Select a network discovery profile and click **Delete**  to delete the selected network or **Edit** to modify the network settings. A confirmation page displays for deletion; click **OK** to delete the profile or **Cancel** to return to the previous menu. To edit a discovered network, fill in the information on the **Edit Network** page. For detailed instruction, refer to the above [4.1.1 Add Network for Discovery](#).

4.2. Manage Wired & Wireless Network Devices

D-View 8 is designed to help you manage your fleet of devices centrally. This section covers the following tasks that you can perform on devices:

- View Device Information
- Modify Device Information
- Ping or Reboot Device
- View and Export Interface List
- View and Export Connection List

4.2.1. View Device Information

The **Device View** shows devices, which are categorized by managed/unmanaged, ignored, and conflicted. The default view is All. For each device category, device information such as status, system name, IP, and MAC address is displayed. For more detailed information, click on the system name link to display the device's detail page.

Note: When the license expires, the **Device View** page will alert you that the system is running under a restriction on the number of nodes with full functionality and encourage you to renew your annual maintenance. To add maintenance licenses, refer to [14.3 Licenses](#).

1. Go to **Monitoring > Device View**. The **Device View** information page displays.

Status	System Name	IP	MAC	Device Type	Model Name	Site Name	Network
●	N/A	172.18.190.95	00:22:44:66:88:00	Unified AP	DWL-3600AP	site_sim	Shanghai_Fi
●	LAPTOP-FMRE1AMM	172.18.192.184	08:97:98:8C:80:29	Host	WindowsWorkstation	CS	Beijing_Mar
●	N/A	172.18.193.163	84:2B:2B:6A:A2:53	Other	Other	CS	Beijing_Mar
●	N/A	172.18.192.206	8E:CF:E5:01:0E:EE	Other	Other	CS	Beijing_Mar
●	DGS-3120-24-16100	2.0.0.8	51:51:00:90:6C:B5	Chassis Switch	DES-8510	site_sim	Shanghai_Fi
●	DESKTOP-O4R0H1G	172.18.192.213	E0:DB:55:9E:A7:4B	Host	WindowsWorkstation	CS	Beijing_Mar
●	DGS-3120-24-16100	2.0.0.54	51:51:00:82:6F:DE	L3 10G Switch	DXS-1100-16TC	site_sim	Shanghai_Fi
●	N/A	172.18.192.46	00:0C:29:83:95:6D	Other	Other	CS	Beijing_Mar
●	DGS-3120-24-16100	2.0.0.94	51:51:00:AE:42:3F	L3 10G Switch	DXS-3400-24TC	site_sim	Shanghai_Fi
●	DES-3528444	172.18.193.199	00:22:80:82:C2:80	L2 FE Switch	DES-3552	CS	Beijing_Mar
●	N/A	172.18.192.154	C8:5B:76:7E:1B:E7	Other	Other	CS	Beijing_Mar
●	N/A	172.18.193.101	1C:15:1F:B3:44:2D	Other	Other	CS	Beijing_Mar

The following table describes the properties of the devices:

Item	Description
Management Type	<p>All, Managed, Unmanaged, Ignored, and Conflicted.</p> <p>Managed: Displays all devices managed by the D-View 8 server.</p> <p>Unmanaged: Displays all unmanaged devices. There are several reasons that a device is classified as Unmanaged:</p> <ul style="list-style-type: none"> - Not being able to communicate with SNMP or WMI. - Lack of required system parameters such as SOID. - Exceeding the number of supported nodes. <p>Ignored: Devices that are excluded from discovery.</p>

	Conflicted: Devices that have an IP address conflict.
Status	Online (Green), Offline (Red), Unknown (Grey).
System Name	A unique name that identifies the device.
IP	The IP address of the device.
MAC	The MAC address of the device.
Device Type	The type of the device, e.g., L2/L3 switch, access point, or workstation.
Model Name	The device's model name.
Site Name	The defined network site of the device.
Network	The defined network of the device.
Vendor	Displays the vendor name of the device.
Discovered Time	Displays the latest discovered time of the device.

You can click on a column to sort the list by the column name; click it again to reverse the order. You can also

configure the column headers with Column Selector .

View Managed Device Information



Managed devices are devices that can be communicated with the D-View 8 system and have the required SNMP parameters.



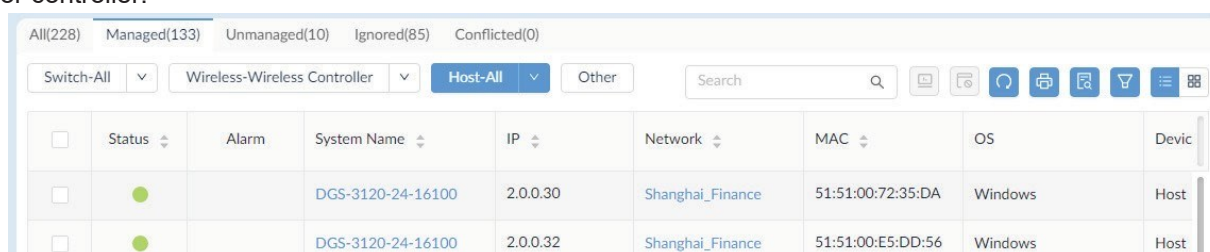



1. Go to **Monitoring > Device View**.
2. Select the **Managed** tab to view all the discovered devices that are managed by D-View 8.

The drop-down menu at the top of the table allows you to refine the list with device type, for example, wireless AP or controller.



All(228) Managed(133) Unmanaged(10) Ignored(85) Conflicted(0)								
Switch-All		Wireless-Wireless Controller		Host-All		Other		
Search								
<input type="checkbox"/>	Status	Alarm	System Name	IP	Network	MAC	OS	Device
<input type="checkbox"/>	●		DGS-3120-24-16100	2.0.0.30	Shanghai_Finance	51:51:00:72:35:DA	Windows	Host
<input type="checkbox"/>	●		DGS-3120-24-16100	2.0.0.32	Shanghai_Finance	51:51:00:E5:DD:56	Windows	Host

Item	Description
All	Displays all detected devices.
Managed	Displays all devices managed by the D-View 8 server.
	Switch-All: click the drop-down menu to list All, sFlow, or PoE-capable switch devices.
	Wireless-Wireless Controller: click the drop-down menu to list the devices grouped by Wireless Controller, Access Point, SSID, or Wireless Client.
	Host-All: click the drop-down menu to list All, Process, or Software-hosting devices.
Other: click to list devices that do not belong to any of the above device categories.	
Toolbar Function	
Search	Enter a keyword and select the matching property for search .
Unmanage	 Click to classify the selected device as unmanaged under the Managed category.
Manage	 Click to classify the selected device as managed under the Unmanaged category.

Ignore	 Click to classify the selected device as ignored. This device will be excluded from discovery. You can ignore a device under either Managed or Unmanaged category.
Refresh	 Click to refresh the list information.
Export	 Click to export the discovered device list to a CSV file. Up to 5000 entries can be included in a single export job.
Advanced query	 Select the criteria to filter the list.
Columns Selector	 Click to customize column headers. The available column properties vary depending on the device type. Default: Status, Alarm, System Name, Network, IP, MAC, Uptime, Vendor, CPU Utilization, Memory Utilization, Firmware Version, Hardware Version, Model Name, Temperature, Device Type, Serial Number, Discovered Time, SNMP Privilege. Other: Device Category, Site Name, PoE Status, sFlow Status, Stack Info, Current Activated License, Activated / Total Licenses, Port Count, Latest Discovered Time, Trap Status, DHCP Status, Total Flash, Syslog Status, Attached on Probe, SNTP / NTP Status, SSH Status, Spanning Tree, LLDP Status, LACP Status, RMON Status, Safeguard Engine Status, FDB MAC. Click All to select or deselect all the categories. Click Apply to save the selection.
View List	 Click to view the list either in a list format or a graphical representation.

To view the details of a device, click the device's **System Name** link.

4.2.2. Modify Device Information

Device information can be modified for managed devices. You can modify device information such as system name, system location, system contact, and other properties depending on the device type.

To modify a device's information:

1. Log in to the Dashboard, see "0".
2. Click **Monitoring** and select **Device View**. The **Device View** information displays.
3. From the category menu select the **Managed** tab.
4. Select a device and click the **System Name**.

The device's detailed information page displays.

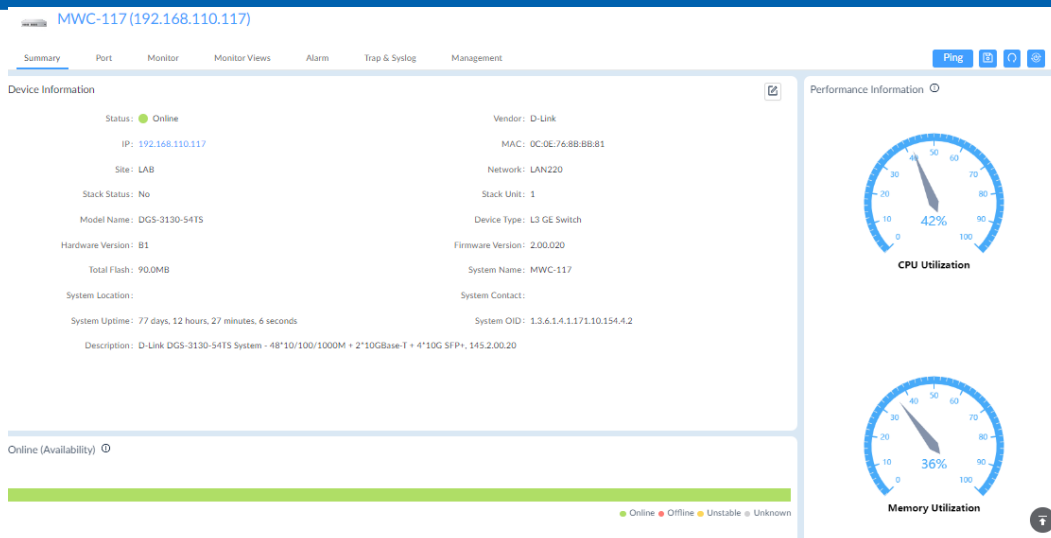

5. From the **Device Summary** page, click the edit button .
6. Click on a field to edit its property.
7. Click **Save** to update the device information.

Note: The device information also provides other tabs for additional information such as alarms and resource monitoring. The available information depends on the type of the managed device, for example, a wireless AP will have the **Wireless** tab showing the SSIDs and channel as well as authentication information.

The following table describes the information available through the **Device Information** page.

Item	Description
Summary	
Device Information	<p>Displays an overview of the device information. You can click Edit to modify the following: System Name, System Location, and System Contact.</p> <p>If a switch supports stacking and it has been enabled and configured as the Primary Master, the stack status can be obtained by hovering over the "view" button. The information for the stacked units includes the unit ID, model name, stack priority, and MAC address as well as firmware version (note that switches assigned with stacking roles as Slave and Backup Master will display Offline status). The Port and Monitor tab will incorporate the information of all the stacked units (refer to the below Port and Monitor status description).</p> <p>Click Save to accept the updates or Cancel to continue without saving.</p>
Performance Information	Displays charts for the device's CPU and memory usage.
Online (Availability)	Displays the online status of the equipment in the past 24 hours.
SNMP Protocol Credentials	<p>Set the SNMP settings for the device. Refer to Set Up SNMP Credentials in .</p> <p>Click Reset to discard any setting updates.</p> <p>Click Test to test the settings to verify if they are correct.</p> <p>Click Save to accept the settings.</p>
SSH/Telnet Credentials	Enter security settings for SSH or Telnet connection. Refer to Set Up SNMP Credentials in .
Additional Information	Click Edit Additional Information to include further device details: Purchase Date, Keeper, Warranty Expiration, Service Vendor, Service Contact, and Description.
LACP Working Status	Provides Link Aggregation Control Protocol (LACP) data if LACP is enabled.
Hardware	Provides a tabular view of the operational status of the device's fan, power supply, and

Health	temperature.
Port	<p>Click to display the Port List overview page. The following information categories are available: Monitor, Comparison, and Alarm Settings. The Monitor and Alarm settings can be set on a per-port basis. You can enable or disable the monitoring status and configure alarm settings using the on/off switch. Or you can go to the Alarm & Notification > Monitor & Alarm Settings and select the Wired Traffic category on the Monitor Settings tab and the Alarm Settings tab. The Monitor Settings can be used to select the ports to be monitored whereas the Alarm Settings allows you to set alarm rules based on Rx/Tx traffic, error rate, discard rate and bandwidth utilization. The Admin Status switch allows you to enable or disable each port.</p> <p>If a switch supports stacking and it has been enabled and configured as the Primary Master, the ports of the stacked units will be displayed. Hover the button to display the information on the selected port, including the unit Rx/Tx rate, port type, bandwidth, and PoE information.</p> <p>Note: The connectivity information of the device is only available for managed devices which can send SNMP data to the D-View server with a unique and identifiable SOID.</p>
Monitor	<p>Click to view a graphical presentation of the CPU and memory utilization, response time, etc. The information can be shown by Hour, Day, Week, Month, or Quarter (3 months retention period).</p> <p>Monitoring Settings: click to enable/disable a specific measurement to monitor. The following categories are available: 802.1Q VLAN, BaseInfo, CPU Utilization, Device Common Information, DHCP Server Status, HTTP Status, LACP, LLDP, Memory Utilization, Power Status, Private Port, RMON Status, Response Time, SNMP Status, SSH Status, STP Status, Temperature, Syslog Status, Telnet Status, Trap Status, Safeguard Status, Syslog Status, and sFlow Profile. Note that the available monitor categories depend on the device's capability. Go to Alarm & Notification > Monitor & Alarm Settings for monitoring status control and Templates > Monitor Template for available monitor categories and templates. You can create customized monitoring functions for devices; for detailed instructions, refer to 11.1 Generate Device Template. Once you have added a customized monitoring function to the device, a Customized Monitor tab will appear next the default System Monitor tab.</p> <p>If a switch supports stacking and it has been enabled and configured as the Primary Master, the ports of the stacked units will be displayed. Hover the button to display the information on the selected port, including the unit Rx/Tx rate, port type, bandwidth, and PoE information.</p>
Monitor Views	Click to view monitoring information in a topological format: Rack View and System as well as Customized topology. Click the topology name link or go to Monitoring > Topology Map to access the topology map view. (Refer to 8.1 View and Manage Network Topology for more information.)
Alarm	Click to view the active or historical (either automatically resolved by automatic script or manually resolved with admin acknowledgement) alarm events. Click Alarm Settings to turn on or off specific alarm rule listed by monitor category as in Alarm & Notification > Monitor & Alarm Settings > Alarm Settings . The Trap and Syslog tabs list alarms configured under the Trap and Syslog category.
Trap & Syslog	Click to view the trap messages and system logs. Go to Alarm & Notification > Trap & Syslog to access the Trap & Syslog page to view all trap events and system logs. (Refer to 7.2 View Traps and Syslog for more information.)
Management	Click to view and configure device service settings and manage firmware and configuration files. It also provides links to Task Management in Configuration . Note that the available configuration categories depend on the device's supported features. To view all supported configuration features, click the More Settings tab. (Go to Configuration > Batch Configuration > Quick Configuration and Advanced Configuration to view available settings for both Quick Configuration and Advanced Configuration categories.) You can add configuration functions for devices using configuration templates; go to Templates > Configuration Template . For detailed instructions, refer to 11.5 Generate Configuration Templates and 11.1 Generate Device Templates . You can also create tasks to be executed immediately by clicking "+ Create Task " from this menu (refer to 4.5.3 Create Tasks for Batch Configuration).

PoE	If a switch supports PoE and the PoE monitoring has been enabled, the PoE utilization status will be displayed. The PoE Power Supply Summary displays the total power supply in the defined timespan: Hour, Day, Week, Month, and Quarter. You can view the PoE supply status by port and configure PoE schedules if the device supports time-based PoE. The schedules can last for a specific period and can be defined with the days in the week and the hours that PoE is enabled for each port.
Ping	Click Ping at the upper right to display the ICMP ping menu.
Save	Click Save to Device at the upper right to save the updated settings to the device.
Refresh	Click Refresh from Device at the upper right to synchronize the device and panel information.
Reboot	Click Reboot at the upper right to reboot the device.
<p>Note: You can view the Monitor and Management features supported for each model managed by D-View via Device Template (go to Templates > Device Template and search for a specific model to display all monitor and configuration templates configured for this model). However, some of the system-built templates that have been employed as system-defaults on managed devices are still undergoing the verification process and may not work correctly; please visit the D-View website (https://dview.dlink.com/supportedModel) to obtain the latest list of supported models.</p>	

4.2.3. Ping or Reboot Device

You can ping or reboot a network device. The device must be online to perform these tasks.

1. Go to **Monitoring > Device View**. The **Device View** information displays.
2. Select a device from the list and click its **System Name**. The **Device Information** page displays.



3. From the toolbar at the top right, perform one of the following actions:
 - **Ping** the device: click Ping to initiate a ping command on the device. For ping, you can specify the supported parameters such as the number of times and packet size to send the ping request.
 - **Save to Devices**: Click to save the updated information to the device.
 - **Refresh** the information: click Refresh to update the information with the device.
 - **Reboot** the device: click **Reboot** to restart the device.

View and Export an Interface List

4.2.4. View and Export an Interface List

You can view the interfaces (or ports) of device(s) managed by the application, and export the table to a tabular formatted (.csv) file. The export list only lists the information of managed devices.

1. Go to **Monitoring > Interface View**. The **Interface View** information page displays.

The following device interface information is displayed:

Item	Description
System Name	The link redirects to the Device Information page.
Model Name	Device model name
IP	Device IP address
Network	The network of the device
Interface Index	The number of the port of the device.
Interface Name	The name of the port of the device.
Interface MAC	The MAC address of the port.
Connected MAC	The MAC address of connected port of the other device.
Connected Interface Name	The Interface Name of the connected port of the other device.
VLAN ID	The VLAN ID to which the port belongs.
VLAN Name	The VLAN name to which the port belongs.
VLAN Type	The configured VLAN type of the port.
VLAN Port Status	The status of the VLAN port: tagged or untagged.
Update Time	The last time that the information synced with the device.

2. Click **Export** to start the export job. The exported file will be saved in the default download folder of your browser.

4.2.5. View and Export a Connection List

You can view the connected devices from the connection point of view with interface-level details. You can also export the data to a tabular file format file. The export list only lists the information of managed devices.

1. Go to **Monitoring > Connection View**. The **Connection View** information page displays.

The following connected interface information is displayed:

Item	Description
Status	The connection status of the link
Alarm	Alarms on either of the connected devices of the link.
Link Name	The device IP addresses of the two ends of the link. You can click on it to obtain more information of the link such as the device performance information and online status of the ports
Device A	The device IP address of one end.
Interface A	The connected port of the Device A.
Device B	The device IP address of the other end.
Interface B	The connected port of the Device B.
RX/TX	The transport and receiving data.
Utilization	The bandwidth utilization in percentage.
Type	The connection type
Last Updated	The last time that the information synced with the device.
Detection Source	The detection protocol.

2. Click **Export** to start the export job. The exported file will be saved in the default download folder of your browser.

4.3. Manage Device Groups

Device groups are designed to simplify the organization of the network devices. It can be used for applying target devices in **Batch Configuration** and **Firmware Management**. Once a device is discovered, it can be added to a group. Groups can be created across sites or networks within an organization. After a device group is created, you can perform maintenance operation such as firmware upgrade on the devices of the group.

4.3.1. Add a Device Group

To add a device group:

1. Go to **Monitoring > Device Group** to open the device group page.

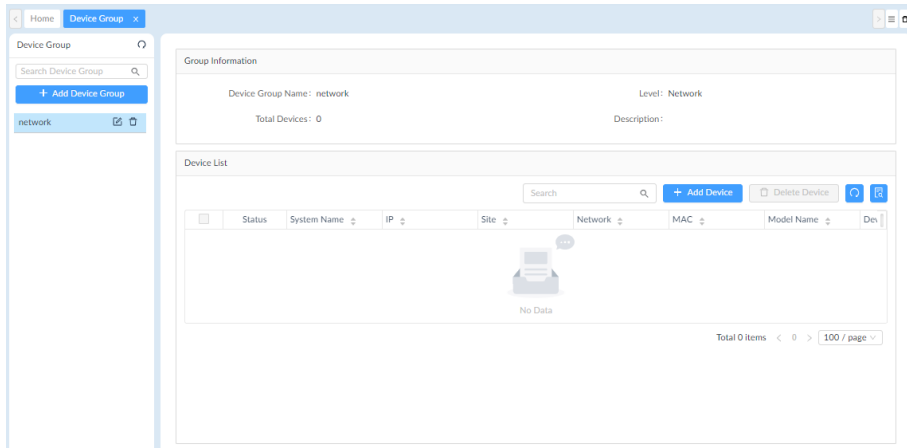

2. Click **+Add Device Group** from the left list pane.

The **Add Device Group** page displays.

Enter the group information:

Item	Description
Name	Enter a name for the group.
Level	Click to select the group level (default: Organization). Organization: Select an organization to add all discovered devices in the organization. Site: Click the Range drop-down menu to select a site to add devices in the designated site. Network: Click the Range drop-down menu to select a network to add devices in the designated network.
Description	Enter a short description for easy identification.

3. Click **Save** to create the group.

The **Group Information** page will be shown on the right side.

4. Click **+ Add Device**. The **Add Device** page displays. From the **Resource Tree** pane, select the site and network to find the desired devices.
5. From the entries in the **Device List**, select a device to be included in the selected group. Or enter an IP address or a model name to find the desired devices.

The screenshot shows the 'Add Device' interface. On the left, the 'Resource Tree' shows a hierarchy: Site-101 > network-101. The main area is the 'Device List' table:

<input type="checkbox"/>	System Name	IP	Network	Model Name
<input type="checkbox"/>	N/A	192.168.220.60	network-101	DGS-1210-52/ME
<input type="checkbox"/>	DESKTOP-5SSNHQH	192.168.220.88	network-101	WindowsWorkstation
<input type="checkbox"/>	MWC-100	192.168.220.100	network-101	DGS-1210-24P
<input type="checkbox"/>	N/A	192.168.220.101	network-101	DGS-1210-10/ME
<input type="checkbox"/>	N/A	192.168.220.102	network-101	DGS-1210-20/ME
<input type="checkbox"/>	Switch	192.168.220.141	network-101	DGS-1510-28XMP
<input type="checkbox"/>	Switch	192.168.220.142	network-101	DGS-1510-52X
<input type="checkbox"/>	Switch	192.168.220.143	network-101	DGS-1510-52X
<input type="checkbox"/>	Switch	192.168.220.144	network-101	DGS-1510-28P
<input type="checkbox"/>	N/A	192.168.220.145	network-101	DGS-1510-28XS/ME
<input type="checkbox"/>	N/A	192.168.220.148	network-101	DES-1210-28
<input type="checkbox"/>	D-Linktest456	192.168.220.149	network-101	DGS-1100-26MP
<input type="checkbox"/>	NA	192.168.220.150	network-101	DGS-1100-05V2

At the bottom right of the Device List, it says 'Total 45 items' and '1 / 100 / page'. Below the Device List are 'Cancel' and 'Save' buttons.

6. Click **Save** to add the devices to the group.

4.3.2. Edit or Remove a Device Group

1. Go to **Monitoring > Device Group**.
2. The **Device Group** page displays.

The screenshot shows the 'Device Group' page. The 'Group Information' section displays:

- Device Group Name: network
- Level: Network
- Total Devices: 6
- Description:

The 'Device List' section shows a table of devices:

<input type="checkbox"/>	Status	System Name	IP	Site	Network	MAC	Model Name	Device Type
<input type="checkbox"/>	●	Switch	192.168.220.141	Site-101	network-101	54:B8:0A:C6:E0:40	DGS-1510-28XMP	Swi
<input type="checkbox"/>	●	MWC-100	192.168.220.100	Site-101	network-101	78:32:1B:82:3C:E4	DGS-1210-24P	Swi
<input type="checkbox"/>	●	Switch	192.168.220.143	Site-101	network-101	54:B8:0A:B4:6E:D8	DGS-1510-52X	Swi
<input type="checkbox"/>	●	Switch	192.168.220.142	Site-101	network-101	78:32:1B:B7:15:F8	DGS-1510-52X	Swi
<input type="checkbox"/>	●	DESKTOP-5SSNHQH	192.168.220.88	Site-101	network-101	F4:96:34:D1:2C:A7	WindowsWorkstation	Hos
<input type="checkbox"/>	●	D-Linktest456	192.168.220.149	Site-101	network-101	F4:8C:EB:47:BF:29	DGS-1100-26MP	Swi

At the bottom right of the Device List, it says 'Total 6 items' and '1 / 100 / page'. Above the table are search and '+ Add Device' buttons.

3. Select an existing device group and perform the following:
 - **Edit**: click to edit the device group name and description.

- **Delete:** click to remove the device group.

Dialog box titled "Edit Device Group" with a close button (X) in the top right corner.

* Name:

Level: Organization Site Network

Range: All Devices

Description:

Buttons: Cancel, Save

4.3.3. Remove a Device from a Group

1. Go to **Monitoring > Device Group**. The **Device Group** page displays.
2. Select a Group from the **Device Group** pane.

The Device List page displays the devices in the group.

3. Select a device and click **Delete Device** to remove it.
4. A confirmation message appears. Click **Yes** to remove the device from the group or **No** to cancel the deletion.

4.4. SNMP Configuration

Network discovery and the device information is accomplished via Simple Network Management Protocol (SNMP). It allows D-View 8 application to monitor certain parameters of the devices. In addition, an alarm can be triggered when certain types of traps are sent from devices.

4.4.1 Configure SNMP Credentials

Devices can be polled individually for network discovery and monitoring. The required SNMP settings should be configured in SNMP credentials list.

To access the configuration page:

1. Go to **System > Basic Settings > Credentials**.
2. The SNMP Credentials page displays:

Name	Type	Sharing Status	Description	Operation
12345	SNMP v2c	OFF		
snmpv2c1666595311153a4	SNMP v2c	ON	Credit with web ip	
snmpv3166659487277244	SNMP v3	ON	Credit with web ip	
snmpv316665947540699b	SNMP v3	ON	Credit with web ip	
snmpv3166659469197409	SNMP v3	ON	Credit with web ip	
snmpv2c1666594594085a5	SNMP v2c	ON	Credit with web ip	
SNMP v1 default	SNMP v1	ON	SNMP v1 default c	
SNMP v2c default	SNMP v2c	ON	SNMP v2c default	

3. Click **Add Credential** to add SNMP credentials for devices within the network:

Add Credential ×

SNMP Protocol Version: SNMP v1 SNMP v2c SNMP v3

* Name:

* Port:

* Timeout [s]:

* Retransmit:

* Read Community:

Write Community:

* Non-Repeaters:

* Max Repeats:

For detailed instructions, refer to **Set Up Credentials** in [14.1 Configure Global Settings](#)

4.4.2 Test SNMP

SNMP functionality can be tested on various platforms using compatible tools. The D-View 8 provides a convenient SNMP tool to test SNMP access to SNMP agents.

To use this tool:

1. Go to **Tools > SNMP Test**.
2. Enter the SNMP Parameters in the left pane to access the device agent. The verified SNMP parameters can be maintained in the above Credentials list.
3. The test result should be displayed in the right pane.

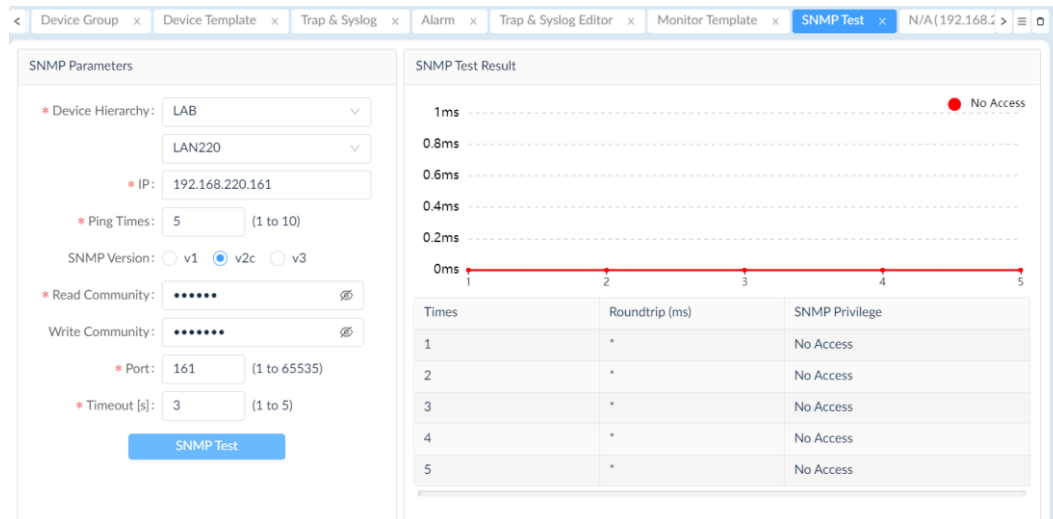

For detailed instructions, refer to [15.4 Perform an SNMP Test](#).

4.4.3. MIBs

Management Information Base (MIB) is an organized data that facilitates configuration and query of network devices. The D-View 8 provides a MIB browser to help extract data polled via SNMP. It supports all 3 versions of SNMP. MIB objects should be displayed after a successful connection.

To view MIBs with a MIB browser.

1. Go to **Tools > MIB Browser**.
2. Select the MIB file from the left pane to obtain information of each object or select the network and enter the SNMP agent IP address to contact with.

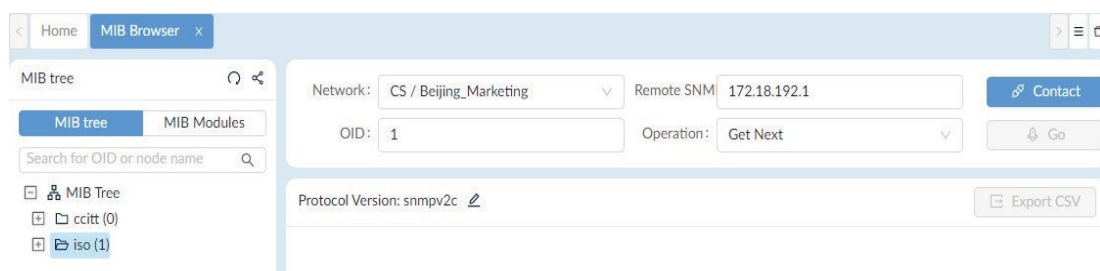

For detailed instructions, refer to [15.1 MIB Browser](#).

4.4.4. Monitor Devices with SNMP

SNMP can be used to monitor devices and the network by collecting data of packet transmission and associated errors and presenting them in a report.

To monitor devices with SNMP:

1. Go to **Templates > Monitor Template**. Create a monitor category defining the source data type. Then create a monitor template with specific OIDs according to the data type defined in the category.

2. Go to **Templates > Device Template**. Then associate a device model with the configured template. For detailed instructions, refer to [11.1 Generate Device Template](#) and [11.4 Generate Monitor template](#).

4.4.5. View Traps and Generate Alarms for Traps

Traps can be viewed from the D-View 8 application and forwarded from the D-View 8 server to a configured destination. Alerts can also be triggered when a specific trap has been sent.

To enable traps on a device:

1. Go to **Monitoring > Device View**.
2. Select a device to open the **Device Information** page. Then click the **Management** tab and enable **Trap Status** to set the D-View as the trap server.
3. You can then obtain trap information on the **Trap & Syslog** tab of the **Device Information** page or by going to **Alarm & Notification > Trap & Syslog**.

To manage traps:

1. Go to **Alarm & Notification > Trap & Syslog** to view all trap events.
2. You can also define a trap OID by adding an OID description in the **Trap & Syslog Editor** menu below.

Refer to [7.2 View Traps and Syslog](#) and [7.3 Trap Editor](#).

To set an alarm with a specific trap:

1. Go to **Alarm & Notification > Monitor & Alarm Settings**. Then click the **Alarm Settings** tab.

Scroll down to the Trap section for traps that are available for triggering an alarm. Then click **Add** to add an alarm rule to define a trigger condition with the specified trap OID or binding values for a variable.

For detailed instructions, refer to [7.5.1 Alarm Settings](#).

To forward traps:

1. Go to **System > Basic Settings**. Then click the **Forward Trap** tab.
2. Click **Add Destination Host** to add a destination to send the traps.

4.5. Manage Multiple Networks with Batch Configuration

The D-View 8 allows for batch configuration of devices across networks using a pre-configured schedule. To start, a configuration template must be created. There are system-built templates and customized templates. The templates are designed to cater for two different configuration types – quick configuration for a single configuration category or advanced configuration for multiple configuration categories when setting batch configuration.

4.5.1 Configuration Categories and Templates

A configuration category, which defines the components of the configuration items and their layout, needs to be verified first for successful operation of the intended device model.

To view a configuration category:

1. Go to **Templates > Configuration Template**.
2. The Configuration Category displays:

Category Name	Configuration Type	Build Type	Description	Operation
<input type="checkbox"/> v2_firmware_upgrade	Advanced Configuration	System	v2. Upgrade firmware of devices. Required to comply with the built-in traits.	
<input type="checkbox"/> v2_backup	Advanced Configuration	System	v2. Backup the configuration files of devices. Required to comply with the built-in traits.	
<input type="checkbox"/> v2_restore	Advanced Configuration	System	v2. Restore the configuration files of devices. Required to comply with the built-in traits.	
<input type="checkbox"/> Trap Status	Advanced Configuration	System	Configure the trap status and host of devices.	
<input type="checkbox"/> Syslog Status	Advanced Configuration	System	Configure the Syslog status and host of devices.	
<input type="checkbox"/> Save	Quick Configuration	System	Save the running configuration to the bootup configuration.	
<input type="checkbox"/> Safeguard Engine Status	Quick Configuration	System	Configure the safeguard engine status of devices.	
<input type="checkbox"/> Spanning Tree Status	Quick Configuration	System	Configure the spanning tree status of devices.	
<input type="checkbox"/> SSH Status	Quick Configuration	System	Configure the SSH status of devices.	
<input type="checkbox"/> Restore	Advanced Configuration	System	Restore the configuration files of devices.	
<input type="checkbox"/> Reboot	Quick Configuration	System	Reboot devices.	
<input type="checkbox"/> v2_reboot	Quick Configuration	System	v2. Reboot devices. Required to comply with the built-in traits.	
<input type="checkbox"/> v2_save	Quick Configuration	System	v2. Save the running configuration to the bootup configuration. Required to comply with the built-in traits.	
<input type="checkbox"/> RMON Status	Quick Configuration	System	Configure the RMON status of devices.	
<input type="checkbox"/> DrF View	Advanced Configuration	System	Configure the DrF status of devices.	

It lists two types of configuration categories: Advanced and Quick Configuration. It also gives a brief description of each configuration category. For **Configuration Type**, the **Quick Configuration** category will be available for Quick Configuration whereas the **Advanced Configuration** will be available for configuration profiles for Advanced Configuration in **Batch Configuration**.

3. Select a Configuration Category or enter a keyword to search for a particular category. Click **View** under **Operation** to view the design layout for the configuration category. Select a trait from the Category Traits drop-down list (for configuration categories prefixed by v2). The required SNMP objects (or component names) and value types will be shown under the UI Appearance (or the Engineering View) section. A configuration template under the selected category can only be implemented successfully if the specific functionality has been configured and tested using an SNMP tool with SNMP commands for validity. Furthermore, devices cannot dissociate from any system-built templates.
4. Click **X** or **Cancel** to exit the window.

To create a configuration template:

1. Select the desired category in the left pane, then click **Add Template** at the top right.
2. Enter a Name for the template, choose the Vendor from the drop-down menu, then enter a description for the template. Also choose the Protocol and enter CLI commands to process the input values if SSH/Telnet has been selected as the communication protocol. Refer to the following table for more details:

Item	Description
Name	Enter a name for the template.
Configuration Category	It shows the selected category for configuration.
Vendor	Select the vendor with the vendor OID from the drop-down menu.

Protocol	Select the protocol used for configuration: SSH/Telnet or SNMP.
Description	Enter a brief description for this template.
CLI Command	<p>Enter the CLI command to configure the device if using SSH/Telnet. Observe the following when writing CLI command:</p> <ol style="list-style-type: none"> 1. Lines begin with a '#' will be considered as comments and will not be considered as commands. 2. Use '%' before and after the word to label it as a variable, for example, %IP%. 3. The value of the variables can be set in the 'Name' field in the Component Settings. 4. Each line must contain no more than one CLI command. 5. Avoid endless CLI commands to prevent deadlock operation. Example: ping 10.0.0.1. 6. Avoid CLI commands that may require special inputs to interrupt the operation. Example: show ports. <p>Sample script:</p> <pre>config ssh authmode password enable config ssh server contimeout 120 enable SSH</pre> <p>Sample script with variables:</p> <pre>config fdb aging_time %TimeoutSeconds%</pre> <p>Sample comments:</p> <pre># this is a comment</pre>
Engineering View/UI Appearance	The template design page at the bottom allows you to configure the component settings such as the names and types of the preset configuration layout and items. For SNMP objects, you need to enter the OID and the associated value type. For certain templates, you have the option to add more control or input elements to the design (e.g. text input, radio selection buttons, and drop-down menus).

3. Modify or add more control or input elements to the design or configure the component settings of the preset configuration items. For the required SNMP objects, enter the correct OIDs and select the value types. It is important that the SNMP operations being tested and verified first for validity using a MIB browser or an SNMP tool. If the template allows for additional design elements, select the layout first with the following options in the design window: one-full column, two columns, three columns, or four columns. Then select and configure the input controls and text fields to be displayed.
4. Click **Save** to create the template.

You can choose to edit the template once it is created. Or you can preview the final layout of the template, delete it or download it as a JSON (JavaScript Object Notation) file.

Note: The above template creation only applies to configuration categories without the v2 prefix. To create a configuration template prefixed by v2, refer to [11.5 Generate Configuration Templates](#).

To associate devices with a template:

Once a template has been created, devices associated with this template can utilize its configuration as a base.

To associate devices with a template:

1. Go to **Templates > Device Template**.
2. Choose the device model from the **Device Type** pane.
3. Select the **Configuration** tab at the bottom of the **Template Information** window. Then select **Associate Configuration Template** to choose the desired configuration template to associate with.

For more detailed instructions, refer to [11.1 Generate Device Template](#).

4.5.2 Batch Configuration

Once a template has been associated with devices, batch configuration can be used to apply a configuration or a set of configurations to selected devices.

To apply batch configuration to devices:

1. Go to **Configuration > Batch Configuration**.
2. Select either **Quick Configuration** or **Advanced Configuration** tab according to the type of the configuration template.

For Advanced Configuration, click **Add Profile** at the top right.

1. Enter a name and description for the profile, select the device model in the **Device Hierarchy** field, then select configuration categories for the device model in the **Configuration Feature List**. Note that you can select multiple categories for a profile.
2. Click **Next** to continue configuring configuration items of selected categories.
3. Click **Save** to create the configuration profile.

For **Quick Configuration**, select a configuration category in the left pane. Then create a task to apply the configuration changes (see below [4.5.3 Create Tasks for Batch Configuration](#)).

For more detailed instructions, refer to [6.1 Create Configuration and Profiles](#).

4.5.3. Create Tasks for Batch Configuration

For Quick Configuration, select a configuration category in the left pane, then enter the following information:

Task Information	
Task Name	Enter the name for the task.
Task Description	Enter a brief description to identify the task.
Configuration Information	
Status/Input	Apply the configuration changes for the task. For custom category, the options depend on the design of the template and selected protocol.
Target Devices	
Add Devices	Click to add the device(s) for configuration. Note that only devices that support this function can be selected. For custom configuration categories, you need to associate the configuration template to the device template first (go to Templates > Device Template).
Schedule Information	
Schedule Type	<ul style="list-style-type: none"> • One Time: Select this option to specify a date and time or immediately to initiate the task. • Recurrent: Select this option to specify the frequency and effective time frame to initiate the task. Refer to 14.2 Scheduling for more information.

Click **Add Task** at the upper right to save the task.

You can click **Task Management**  to open the **Task Management** page.

For Advanced Configuration, select a profile in the list, then click **Create Task +** under **Operation**.

Enter the following information:

Task Information	
Task Name	Enter a name for the task.
Task Description	Enter a brief description to identify the task.

Target Devices	
Add Devices	Click to add the device(s) for configuration. The Batch Select Devices screen opens. Select the desired devices or use the Search function to find devices.
Schedule Information	
Schedule Type	<ul style="list-style-type: none"> • One Time: Select this option to specify a date and time or immediately to initiate the task. • Recurrent: Select this option to specify the frequency and effective time frame to initiate the task. Refer to 14.2 Scheduling for more information.

Click **Save** to create the new task and return to the previous menu.

You can click **Task Management** to open the **Task Management** page. Refer to [6.2.1 Current Tasks](#) for details about tasks.

For more detailed instructions, refer to **Apply a Profile to Devices with Task** in [6.1 Create Configuration and Profiles](#).

5 Monitoring and Reporting

You can monitor your network through the Dashboard to obtain real-time statistics. The information to be displayed can be customized on the Customized Dashboard page.

5.1. View the Default Dashboard

The default dashboard provides information related to the distribution and management of the resources in the managed networks. The information can be used to assess, utilize, and centrally manage your networks.

Note: When the license expires, the **Dashboard** page will alert you that the system is running under a restriction on the number of nodes with full functionality and encourage you to renew your annual maintenance. To add maintenance licenses, refer to [14.3 Licenses](#).

To view the Overview dashboard, log in to the D-View 8 application. The Overview dashboard will be displayed.

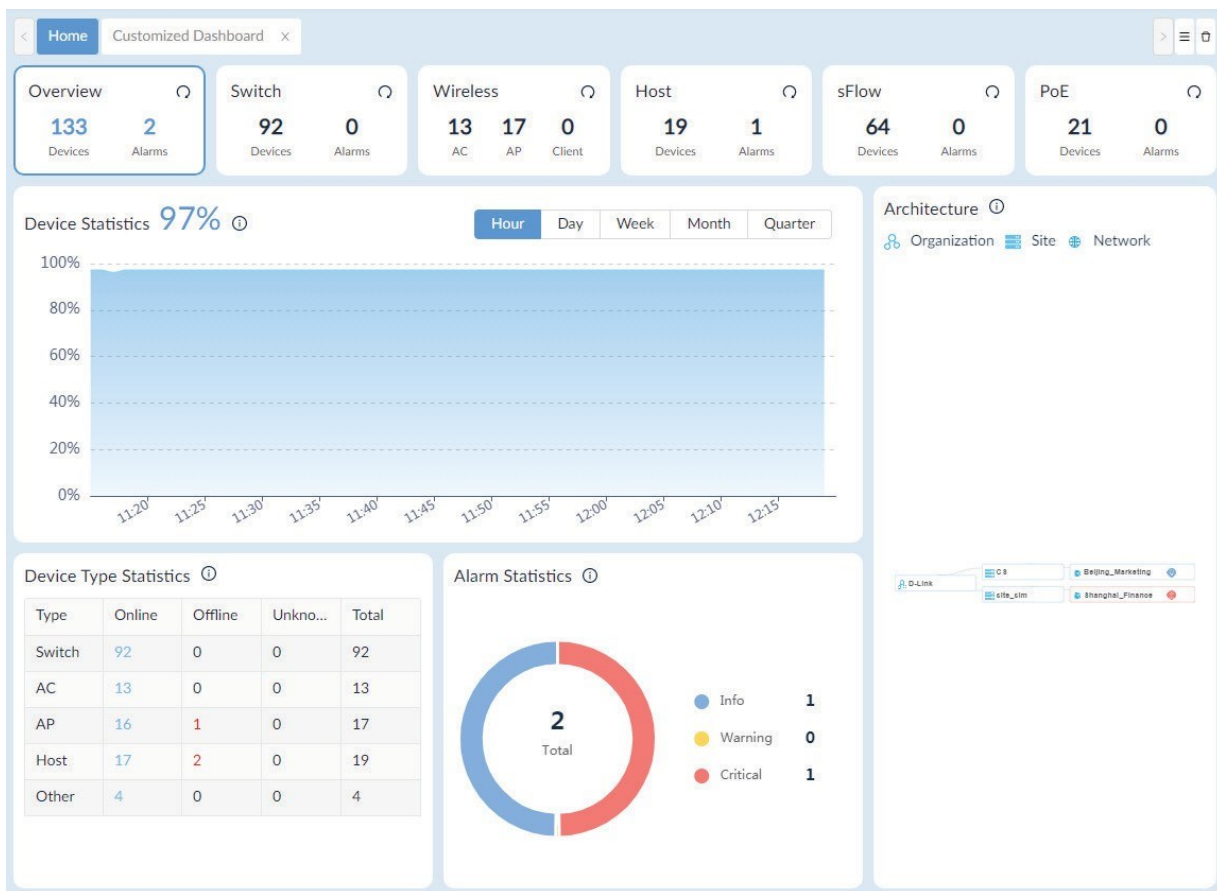

By default, the overview displays the following widgets. To refresh data, click **Refresh**  at the upper right.

Widget	Description
Device Statistics	The percentage of managed devices that are online.
Architecture	The D-View 8 network architecture diagram.
Device Type Statistics	The operating status of different types of managed devices.
Alarm Statistics	The distribution of alarm severity for managed devices.

You can click on any number or icon on the charts or graphs to be directed to the configuration page.

5.2. Switch Dashboard

From the Dashboard, click the Switch tab. The Switch Dashboard displays the following widgets. To refresh data, click **Refresh**  at the upper right.

Widget	Description
Alarm Statistics	The distribution of alarm severity for managed switches.
Running Status	The online status of managed switches.
Temperature Statistics	The distribution of managed switches based on the specified temperature range: 40, 60, 80, or 90 °C.
Top 10 Wired Throughput (Rx / Tx)	The top 10 managed switches that currently send and receive the most traffic.
Top 10 Memory Utilization	The top 10 managed switches with the highest current memory utilization.
Top 10 CPU Utilization	The top 10 managed switches with the highest CPU utilization.
Top 10 Response Times	The top 10 managed switches with the longest response time according to a specified time frame: current, last hour, last 24 hours, last 7 days, last 30 days, or last 90 days.

5.3. Wireless Dashboard

From the Dashboard, click the Wireless tab. The Wireless Dashboard displays the following widgets. To refresh data, click **Refresh**  at the upper right.

Widget	Description
Alarm Statistics	The distribution of alarm severity for managed switches.
Running Status	The online status of wireless devices (AC/AP).
AP Summary	The distribution of AP device types.
Top 10 Wireless Throughput	The top 10 wireless devices that send and receive the most traffic in the specified time frame: current, last hour, last 24 hours, last 7 days, last 30 days, or last 90 days.
Top 10 Wireless Error Packets	The top 10 wireless devices with the most error packets in the specified time frame: current, last hour, last 24 hours, last 7 days, last 30 days, or last 90 days.
Clients by 802.11 Protocol	The distribution of 802.11 protocol types used by the clients.
Clients by Authentication Type	The distribution of client authentication type.
Top 10 Devices by Critical Alarms	The top 10 wireless devices that generated the most critical alarms.
Top 10 SSIDs by Current Client	The top 10 SSIDs with the most clients currently connected.
Top 10 Response Times	The top 10 wireless devices with the longest response time in the specified time frame: current, last hour, last 24 hours, last 7 days, last 30 days, or last 90 days.
Top 10 APs by Current Client	The top 10 APs with the most clients currently connected.

5.4. Host Dashboard

From the Dashboard, click the Host tab. The Host Dashboard displays the following widgets. To refresh data, click **Refresh**  at the upper right.

Widget	Description
Alarm Statistics	The distribution of alarm severity for all hosts.
Running Status	The online status of host devices.
Top 10 CPU Utilization	Display the top 10 hosts with the highest CPU utilization.
Top 10 Memory Utilization	Displays the top 10 hosts with the highest memory utilization in the specified time frame: current, last hour, last 24 hours, last 7 days, last 30 days, or last 90 days.
Top 10 Most Installed Applications	Display the top 10 most installed applications on the hosts in the network.
Top 10 Volumes with Most Disk Usage	Display the top 10 volumes with the most disk usage in the network.
Top 10 Response Times	Display the top 10 hosts with the longest response time in the specified time frame: current, last hour, last 24 hours, last 7 days, last 30 days, or last 90 days.
Top 10 Volumes with Least Disk Usage	Display the top 10 volumes with the least disk usage in the network.

5.5. sFlow Dashboard

From the Dashboard, click the sFlow tab. The sFlow panel displays the following widgets. To refresh data, click **Refresh**  at the upper right. Note that sFlow Dashboard is only supported in Enterprise version.

Widget	Description
Top 10 Endpoints	Display the top 10 most used endpoints.
Alarm Statistics	The distribution of alarm severity in the network.
Top 10 Applications	Display the top 10 applications with the most traffic in the specified time frame: last hour, last 24 hours, last 7 days, last 30 days, or last 90 days.
Top 10 QoS	Display the top 10 QoS with the most traffic in the specified time frame: last hour, last 24 hours, last 7 days, last 30 days, or last 90 days.
Top 10 Protocols	Display the top 10 protocols with the most traffic in the specified time frame: last hour, last 24 hours, last 7 days, last 30 days, or last 90 days.
Top 10 Conversations	Display the top 10 conversations with the most traffic in the specified time frame: current, last hour, last 24 hours, last 7 days, last 30 days, or last 90 days.

5.6. PoE Dashboard

From the Dashboard, click the PoE details panel. The PoE panel displays the following widgets. To refresh data, click **Refresh**  at the upper right.

Widget	Description
Alarm Statistics	The distribution of alarm severity of the managed PoE devices.
Running Status	The online status of the managed PSE devices.
Top 10 PSEs by Current PD Count	The top 10 PSE devices with respect to the number of powered devices.
Top 10 Ports by Current Flow	The top 10 PoE device ports with the highest data flow.
Top 10 Ports by Power Output	The top 10 PoE ports with the highest power consumption.
Top 10 PSEs by Power Output	The top 10 PSE devices with the highest power output.
Top 10 Response Times	The top 10 PoE devices with the longest response time in the specified time frame: current, last hour, last 24 hours, last 7 days, last 30 days, or last 90 days.

5.7. Customize the Dashboard

By default, the application displays the dashboard with standard information. You can customize the dashboard views by selecting the widgets.

5.7.1. Create a Customized Dashboard

To create a customized dashboard:

1. Go to **Dashboard > Customized Dashboard**.

The Customized Dashboard page displays.

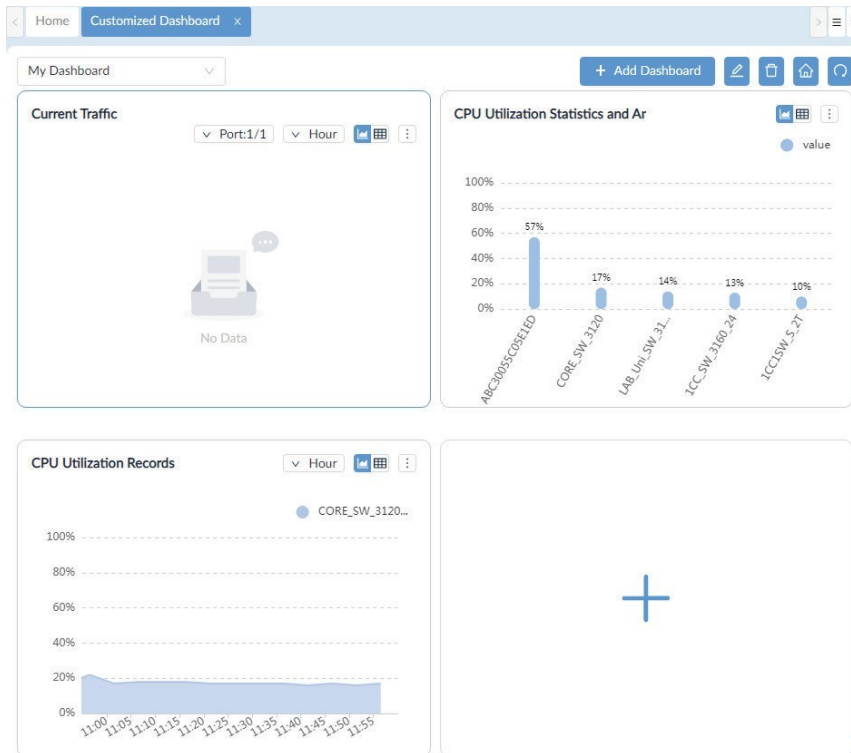

2. Click **Add Dashboard**. The **Add Customized Dashboard** page displays.

The screenshot shows the 'Add Customized Dashboard' form with the following fields and options:

- Name:** A text input field with the placeholder 'Enter Name'.
- Level:** Radio buttons for 'Organization' (selected), 'Site', and 'Network'.
- Range:** A dropdown menu set to 'All Devices'.
- Description:** A text area with the placeholder 'Enter Description'.
- Sharing Status:** A toggle switch labeled 'OFF'.
- Buttons:** 'Cancel' and 'Save' buttons at the bottom.

Enter the following information:

Item	Description
Name	Enter a name for the new dashboard.
Level	Click to select the network hierarchy level (default: Organization).
Organization	Add all discovered devices within the organization.
Site	Click the Range drop-down menu to select the devices within the desired site.
Network	Click the Range drop-down menu to select the devices within the desired network.
Description	Enter a short description to identify the group.
Sharing status	Slide the option to enable or disable (default) the sharing of the dashboard. After enabling the sharing status, other administrators with authorized role in your organization will be able to view or edit it.
Save	Click Save to create the dashboard.

The customized dashboard displays.

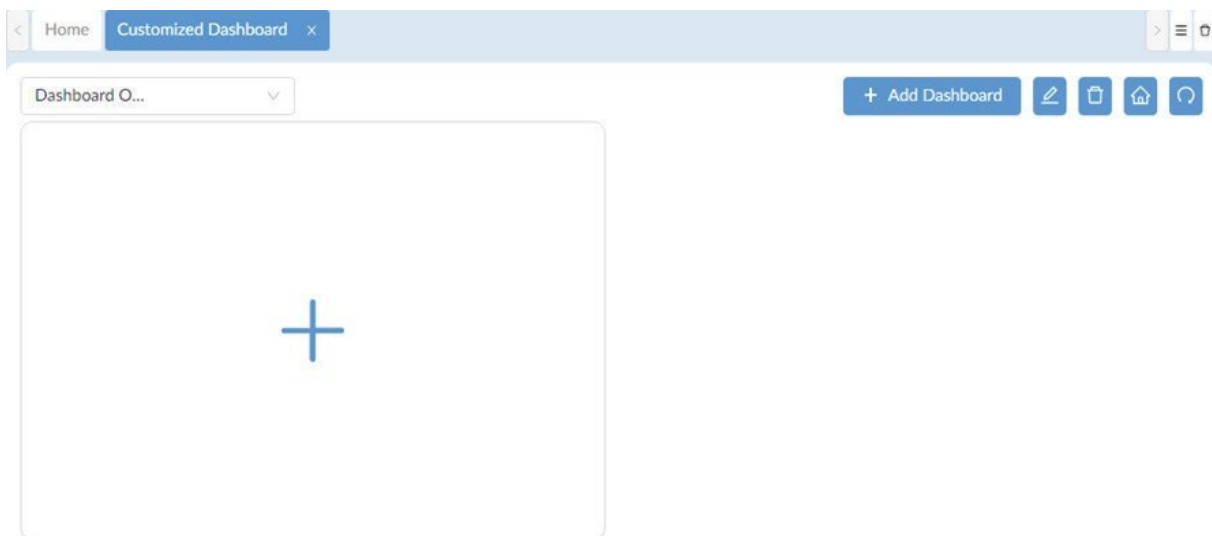

- On the dashboard for the specified network level, click + (Add) to add a graphical presentation of network performance indicator to the dashboard. The **Add Graphics** page displays.
- In the Select device step, select device(s) for the source data.

Or you can search devices by one of the following properties: System Name, IP, Model Name, Device Category, or Network Name. Then click **Next** to continue.

Add Graphics X

1 Select device 2 Select Indicator 3 Preview

Search

You can select up to 20 devices.

<input type="checkbox"/>	Status	System Name	IP	Model Name	Device Category	Network Name
<input checked="" type="checkbox"/>	●	N/A	172.18.193.11	Other	Other	Marketing
<input type="checkbox"/>	●	N/A	172.18.192.188	Other	Other	Marketing
<input checked="" type="checkbox"/>	●	N/A	172.18.192.107	Other	Other	Marketing
<input type="checkbox"/>	●	N/A	172.18.192.209	Other	Other	Marketing
<input type="checkbox"/>	●	N/A	172.18.192.161	Other	Other	Marketing
<input type="checkbox"/>	●	N/A	172.18.193.226	DES-3026	Switch	Marketing
<input type="checkbox"/>	●	N/A	172.18.193.26	Other	Other	Marketing
<input type="checkbox"/>	●	LAPTOP-FMREI1AMM	172.18.192.184	WindowsWorkstation	Host	Marketing
<input type="checkbox"/>	●	N/A	172.18.192.195	Other	Other	Marketing

Total 95 items < 1 2 3 4 5 6 7 > 15 / page Go to

[Next](#)

- Click on an indicator to define the statistics. The availability of performance indicators depends on the supported device functions. Also, the report timing for some statistics depends on the polling interval of the respective monitoring function. To edit monitoring status or interval, go to **Alarm & Notification > Monitor & Alarm Settings > Monitor Settings**. You can also adjust monitoring status or interval by accessing the device information page (go to **Monitoring > Device View** and select the **System Name** link to open the device information page and click the **Monitor** tab.)

Add Graphics X

1 Select device 2 Select Indicator 3 Preview

<input type="radio"/>	Indicator Name	Graphics
<input type="radio"/>	Device Alarm Statistics	
<input type="radio"/>	Device Running Status Statistics	
<input type="radio"/>	CPU Utilization Statistics and Analysis	
<input type="radio"/>	Memory Utilization Statistics and Analysis	
<input type="radio"/>	Response Times Statistics and Analysis	
<input type="radio"/>	Response Time Records	
<input type="radio"/>	CPU Utilization Records	
<input type="radio"/>	Memory Utilization Records	
<input type="radio"/>	Temperature Statistics and Analysis	
<input type="radio"/>	Temperature Records	

[Previous](#) [Next](#)

<ul style="list-style-type: none"> • Device Alarm Statistics • Device Running Status Statistics • CPU Utilization Statistics and Analysis • Memory Utilization Statistics and Analysis • Response Times Statistics and Analysis • Response Time Records • CPU Utilization Records • Memory Utilization Records • Wireless Throughput (Bytes) • Total Bytes Transmitted • Total Packets Transmitted • Current Traffic • Packets Per Second 	<ul style="list-style-type: none"> • Interface Utilization • Total Errors and Discards • Discard Rate • Error Rate • Wireless Throughput (Packets) • Wireless Error Packets • Wireless Clients by Protocol • Wireless Clients by Authentication Type • Wireless Clients by SSID • Wireless Clients by AP • SIM Traffic • Temperature Statistics and Analysis • Temperature Records
--	---

The Preview page displays.

Add Graphics
✕

✓ Select device
✓ Select Indicator
3 Preview

* Title: Indicator Name: Device Alarm Statistics

Graphics Preview:

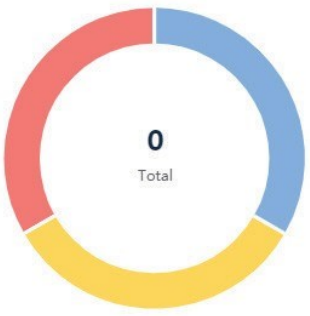

● Critical	0
● Warning	0
● Info	0

◀ Previous
OK

7. Click **OK** to create the new graphical presentation.

5.7.2. Modify a Customized Dashboard

To modify a customized dashboard:

1. Go to **Dashboard > Customized Dashboard**. The **Customized Dashboard** page displays.

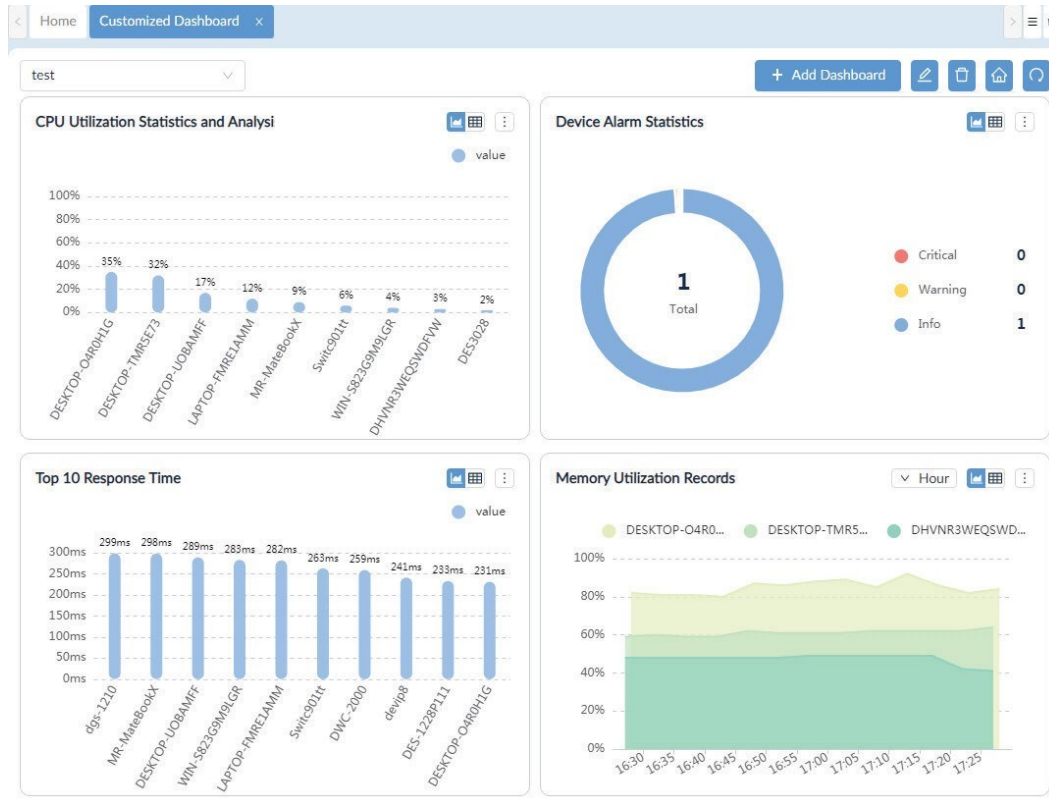

Click **Edit** at the upper right to modify the dashboard or **Delete** to delete the dashboard. You can also modify a widget of the dashboard.

The following example uses CPU Utilization Statistics and Analysis widget:

- Click on the **More Settings** button. Available options depend on the widget function.

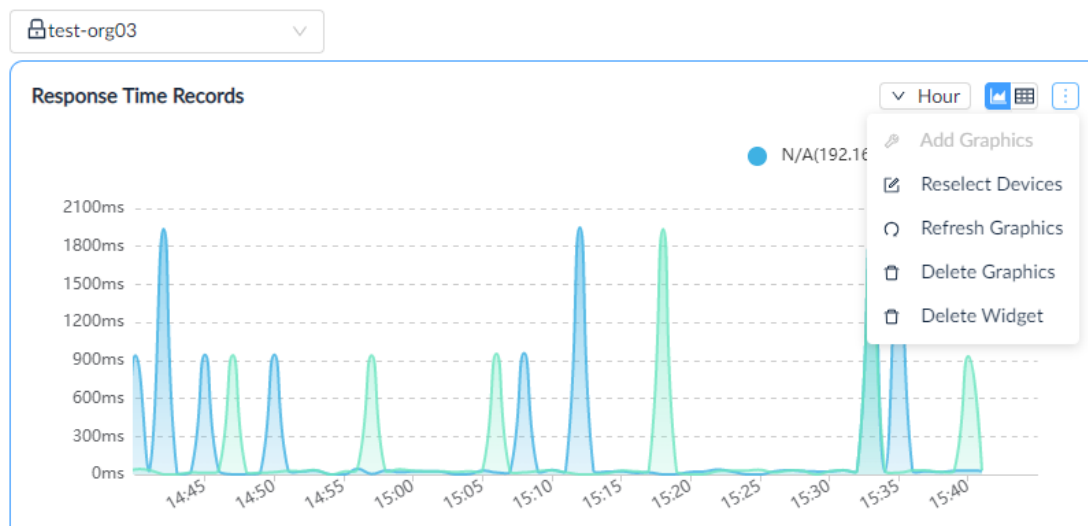

- Click to perform an action:

Refresh Graphics: re-sync the function information.

Delete Graphics: remove the graphic from the widget frame.

Add Graphics: when the graphic is deleted, add a new performance indicator.

Delete Widget: remove the widget from the dashboard.

Reselect Devices: specify a different device(s).

The widget will be updated. The new dashboard can also be applied to the Home page to replace the default system dashboard. Click **Apply to homepage**  at the upper right.

5.8. View and Export Reports

The system provides a method to view information regarding the performance and resource utilization on the network.

The following reports are available:

- General Reports
- Scheduled Reports
- My Reports

The period for statistics generation is based on the scheduled retention period. To view and export reports:

1. Go to **Reports > General Reports**.
2. Select the report type from the General Reports pane.

Report Category	Category	Event
General Reports	Device Reports	Device Health Reports
		Trap Reports
		Syslog Reports
		Device Top N Reports
	Wired Interface Reports	Wired Traffic Reports
		Wired Throughput Top N Reports
	Wireless Reports	Wireless Client Count Reports
Wireless Traffic Reports		
Advanced Reports	Inventory Reports	
Scheduled Reports	One Time	
	Recurrent	
My Reports	My Reports	

3. From Reports, click **General Reports**. The default Device Health Reports page displays.

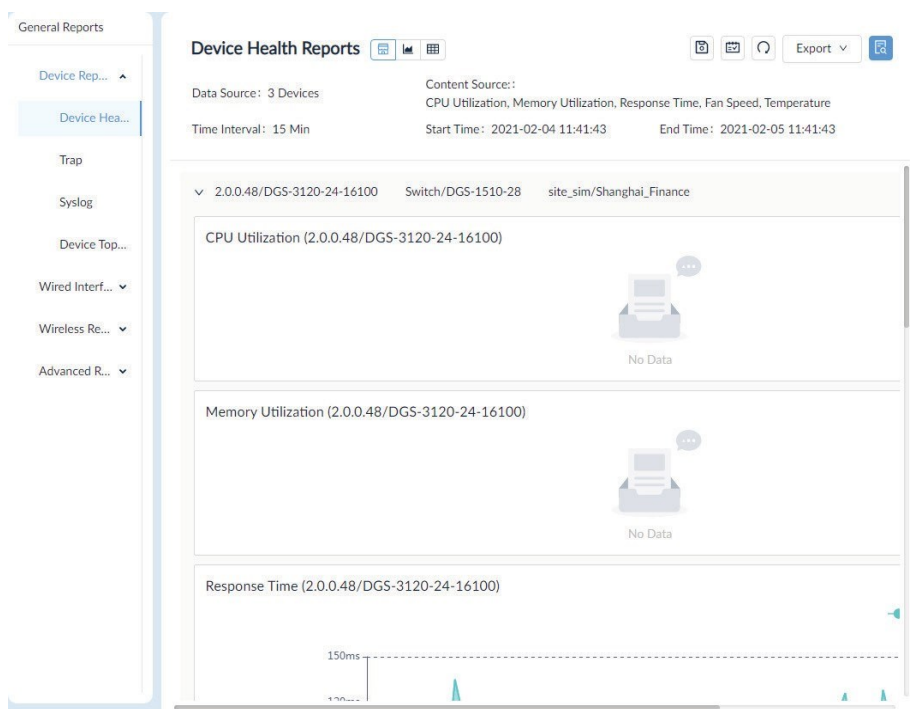

You will need to configure the settings if a report does not display any data. Refer to the below section for more information.

4. Click the **Export** drop-down menu at the top right and select the type of file format for download: PDF, Excel, or CSV. The report file is downloaded to the default download folder of your browser.







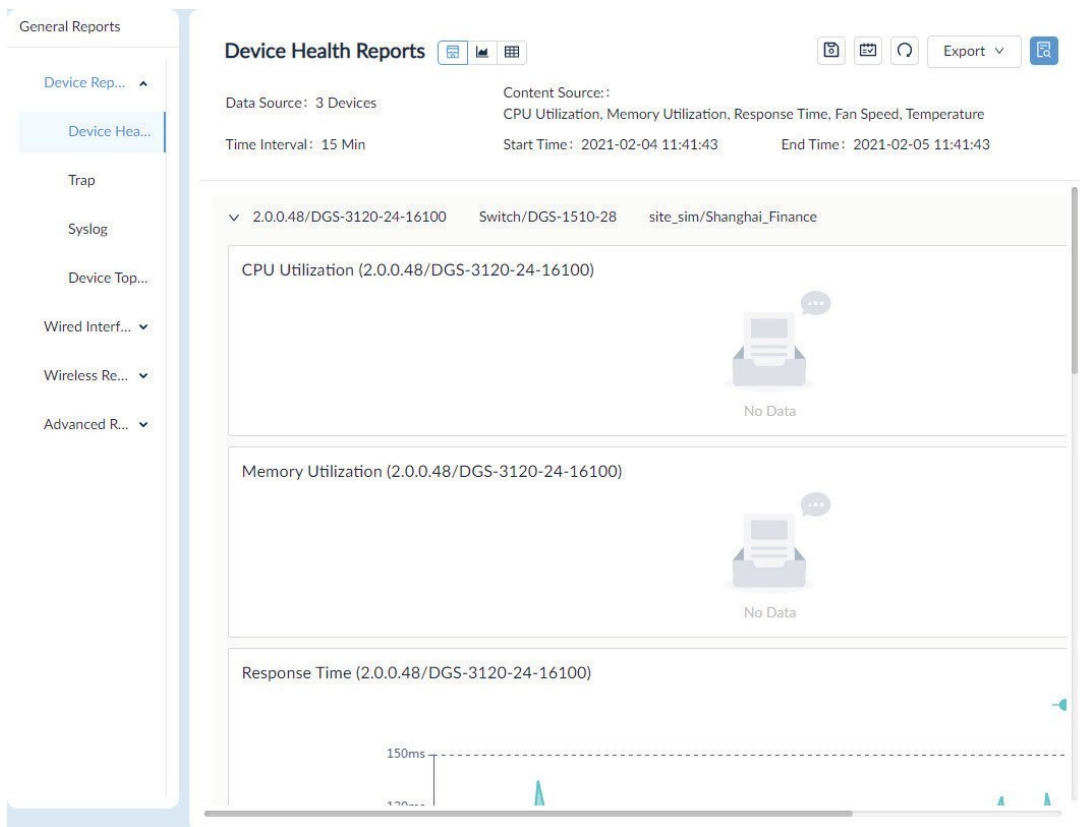

5.9. View Report Settings

- From Reports, click **General Reports**.

The default **Device Health Reports** page displays.



The toolbar displays available functions:

Item	Description
Show All 	Display all information.
Show Chart Only 	Display available information in chart format.
Show Table Only 	Display available information in tabular format.
Save to My Reports 	Designate the current report as My Report.
Upgrade to Scheduled Reports 	Designate the current report as Scheduled Report.
Refresh 	Re-synchronize the report information.
Export 	Save the information to a file.
Report Settings 	Configure the settings for the current report type.

- Click **Report Settings** . The **Report Settings** page displays.

* Select Devices: All Selected Selected count: 5

<input type="checkbox"/>	Status	System Name	IP	Model Name	Site	Network
<input checked="" type="checkbox"/>	●	DGS-3120-24-16100	2.0.0.48	DGS-1510-28	site_sim	Shanghai_...
<input checked="" type="checkbox"/>	●	DGS-3120-24-16100	2.0.0.12	DWS-3160-24TC	site_sim	Shanghai_...
<input checked="" type="checkbox"/>	●	DGS-3120-24-16100	2.0.0.75	DGS-1520-28	site_sim	Shanghai_...
<input checked="" type="checkbox"/>	●	DGS-3120-24-16100	2.0.0.64	DGS-3630-52PC	site_sim	Shanghai_...
<input checked="" type="checkbox"/>	●	DGS-3120-24-16100	2.0.0.71	DGS-1520-28	site_sim	Shanghai_...

Total 133 items < 1 2 > 100 / page

* Content Source: CPU Utilization Memory Utilization Response Time Fan Speed Temperature

Time Interval: 15 Min

Duration: Last 24 Hours

Available report setting options:

Item	Description
Select Devices	Click the slide bar to view All or only the Selected devices. To select a device, click a specific device.
Search	Enter a keyword to search for a device by System Name, IP, Model Name, Site, or Network.
Content Source	Click the report type: CPU Utilization, Memory Utilization, Response Time, Fan Speed, or Temperature.
Time Interval	Click to set the interval time to define the display interval for the report: Configured minimum interval, 15 min., 2 Hour, 8 Hour, 1 Day.
Duration	Click to select the duration for each report: Last 24 Hours, Today, Yesterday, Customized. If you select Customized, enter the Start and End Time.
Reset	Click to reset the report settings to the default settings.
Save	Click Save to create the report.
Note: The report settings vary depending on the report type.	

5.10. View Firmware Version

You can view the firmware version for all discovered D-Link devices.

To view the firmware version:

1. Go to **Configuration > Firmware Management**. The Firmware Management page displays.

Status	System Name	IP	Firmware Version	Model Name	Operation
●	LAB_Uni_SW_3120test	172.18.193.212	Build 2.00.010	DGS-3120-24TC(A1)	
●	DLINK-WLAN-AP	172.18.193.184	3.0.0.16	DWL-8500AP()	
●	1CC1SW_S_2T	172.18.193.99	2.60.017	DES-3528(A1)	
●	ABC30055C05E1ED	172.18.192.22	Build 1.28.009	DES-3200-28(A1)	
●	DSR-500AC	172.18.192.1	3.14	DSR-500AC(A1)	
●	MAIN AC1	172.18.193.209	Build 1.00.038	DWS-3160-24PC(A1)	

To upgrade firmware for devices”

2. Select devices for firmware upgrade.



NOTE: If multiple devices are selected, make sure that correct firmware is selected for update for each model.

3. Click **Upgrade** to display Firmware Upgrade page.
4. Under **Firmware File**, click **Select Firmware File** to view available firmware sources.



NOTE: Make sure that you confirm the firmware version and its compatibility with the device before proceeding. Refer to **Configuration > File Management** for firmware files that have been uploaded to the D-View 8 server.

5. On the **Other Firmware** tab, select the appropriate file and click **OK** to continue. These firmware files have been uploaded to the D-View 8 server (refer to **Configuration > File Management**).

File Name	Description	Site Name	Network Name	Uploaded by
<input checked="" type="radio"/> DGS-1210-28MPI(E1).png		LAB	LAN220	mag
<input type="radio"/> FAN.png	shared-on	LAB	testDuplicate	mag12345
<input type="radio"/> Port_Settings.png	fw-file	LAB	LAN220	mag
<input type="radio"/> cert03.cer	test	LAB	LAN220	mag
<input type="radio"/> DGS-1210-GX-GX-7-30-004.hex		LAB	LAN220	xuexue.yin

6. Alternatively, select the **Associate Firmware** tab to view firmware that was uploaded specifically for this device model or to upload firmware from a local directory, then click **Upload Firmware**.

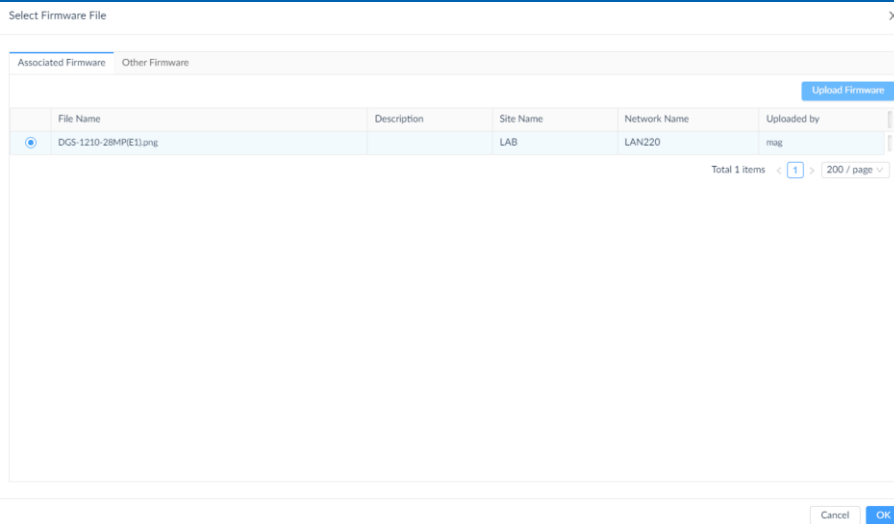

- The **Upload Firmware** page appears. The **Share** slide bar can be used to enable or disable sharing this firmware file with other networks besides the device's current network. After selecting the firmware, click **Save** to upload the file selection or **Cancel** to delete the upload.

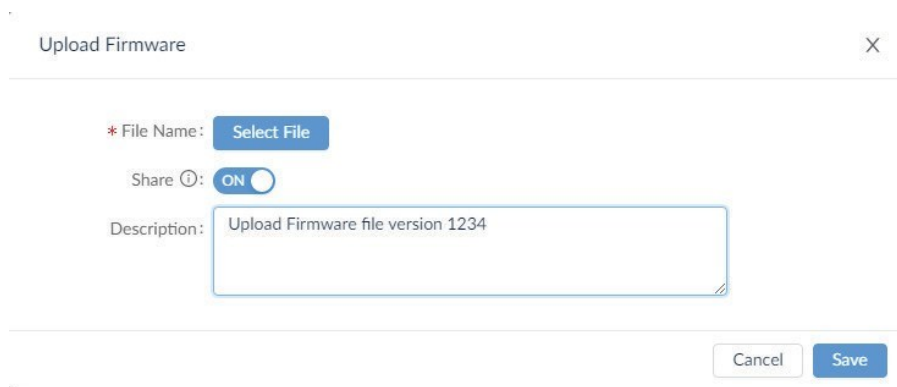

- From the Firmware Upgrade page, set the Schedule under Schedule Information:
 - Schedule Type: One Time
 - Execution Time:
 - Immediately: start the firmware updating once the upload file is saved.
 - Specify a Date: click the **Date** drop-down menu to select a date and time.

Click **OK** to set the date.

- From Reboot Type, click **Reboot by D-View 8** to enable a restart of the device through the D-View 8 application. By default, the Reboot by D-View 8 option is disabled. A reboot is generally required for the new firmware to take effect.
- Click **Save** to confirm the new upgrade job. Click **Cancel** to return to the previous menu.

5.11. View D-View 8 Notifications

D-View 8 provides notifications via the D-View 8 web application and email. You can configure the notification rules for events that required immediate attention. For more information, refer to 3.6 Configure the Notification Center.

To view notifications:

1. Log in to the Dashboard, see “3.2. Launching D-View 8 Web GUI”.

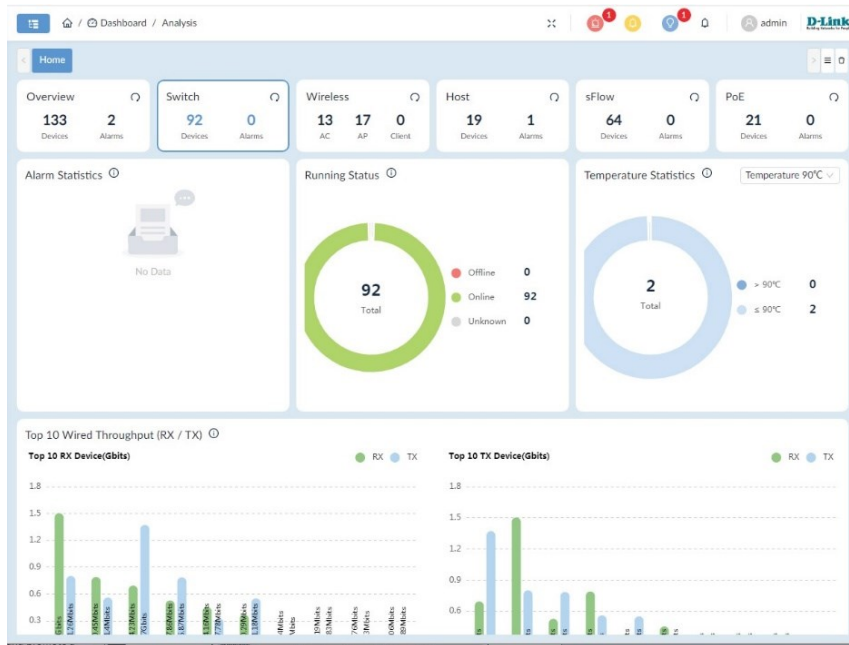

2. On the right side of the toolbar, click the Notification icon . The Notification message page displays.

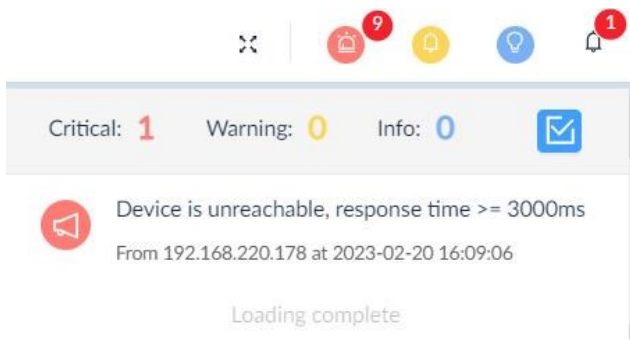

To clear the list, click . (Note that no historical records will be kept.) Click on a notification entry to open the Alarm Details page to obtain the alarms pertinent to this notification. You can view the notification rules from the Notification Center (go to **Alarm & Notification > Notification Center**).

5.12. Monitor Multiple Networks

The D-View 8 allows for efficient monitoring of devices across networks with system default and customized monitor functions. To start, a monitor category and template must be created. There are system and user build monitor templates. You also have a choice among one of three communication protocols: SNMP, WMI or HTTP(s).

5.12.1 Create Monitor Templates

You need to create a monitor category first to define the communication protocol and measurement unit as well as data source definition for monitor templates. To create a monitor category:

1. Go to **Templates > Monitor Template**. Then select the **Monitor Category** tab.
2. The Monitor Category displays:

Category Name	Units	Protocol	Line Chart	Build Type	Description	Operation
category-for-	%	HTTP(S)	Not Supported	User		
test-2022-12-20-monitor	%	WMI	Not Supported	User	test	
monitor-temp-20221125	-	SNMP	Not Supported	User		
Interface_Monitor	-	SNMP	Not Supported	User		
FAN	-	SNMP	Not Supported	User		
1234567	%	SNMP	Not Supported	User		
test-20221116	%	SNMP	Support	User	test	
1234	%	HTTP(S)	Not Supported	User	1234	
12345	%	SNMP	Support	User	12345	
TestHttp	bits	HTTP(S)	Not Supported	User		
test category	%	SNMP	Not Supported	User		
Windows Running Process	-	WMI	Not Supported	System	Collect the running process of windows OS through WMI.	
Windows Installed Product <MSI>	-	WMI	Not Supported	System	Collect software installed with MSI from Windows OS through WMI.	
Windows Computer Information	-	WMI	Not Supported	System	Collect the basic information of computer from Windows Server	
Windows OS Information	-	WMI	Not Supported	System	Collect the basic information of operating system from Windows Server	

It lists two build types of templates: System and User. The User type is created by users whereas system type is created by system and cannot be modified.

To add a monitor category:

1. Go to **Templates > Monitor Template**. Then select the **Monitor Category** tab.
2. Click **Add Category** at the upper right.
3. Enter the following information:

Item	Description
Category Name	Enter a name for configuration.
Units	Select the measurement unit for configuration.
Protocol	Select the protocol for configuration: SNMP, HTTPs, or WMI.
Line Chart	Enable or disable the line chart function for graphical representation of the monitoring results. Open the Device Information page (go to Monitoring > Device View and click the System Name link of the selected device) and select Monitor > Customized Monitor to view the added monitoring results.
Description	Enter a brief description for the category.
Data Source Definition	Click Add to define a name with value type for each data type.

Click **Save** to create the monitor category.

To add a monitor template:

1. Go to **Templates > Monitor Template** and select the **Monitor Template** tab. Select the desired category from the Monitor Category pane in the left pane. Then Click **+ Add Monitor Template** at the upper right.
2. Enter the following information:

Item	Description
Template Name	Enter a name for the template.
Monitor Category	Select the desired category for configuration.
Vendor Name	Select the vendor with the vendor OID from the drop-down menu. Or click New at the right to add a new vendor. For more information about vendor, refer to Templates > Device Support .
Monitoring Interval	Select the polling interval for monitoring: 60, 300, 600, 1800, and 7200. The default is 60 seconds.
Description	Enter a brief description for this template.
Data Source Definition	Click Add to define a name with value type for the specific data object obtained from the monitored devices. The configuration options depend on the communication protocol used for device monitoring.
Script	Enter a script to process the value of the added data source in Groovy.

Click **Save** to create the monitor template. Once a template is created, you can associate it to a device model. It can then be configured for monitoring a device with the preset condition, refer to **Templates > Device Template**.

5.12.2 Configure Monitor Settings

You can configure monitoring settings such as monitoring status and polling interval.

1. Go to **Alarm & Notification > Monitor & Alarm Settings**. Then Select the **Monitor Settings** tab.

The screenshot shows the 'Monitor Settings' interface. On the left, there is a 'Monitor Category' pane with a search bar and a list of categories including 'Wired Traffic', '1234', '12345', '1234567', '802.1Q VLAN', 'AC L3 Discovery Details', 'AC VLAN Discovery Details', 'AC Valid AP', 'Authenticated Clients', 'Baseline', 'CPU Utilization', and 'Cellular Running Details'. The main area is titled 'Monitor List' and contains a table of monitored devices. The table has columns for 'System Name', 'IP', 'Network', 'Model Name', 'Monitoring Status', and 'Polling Interval(s)'. The 'Monitoring Status' column shows 'OFF' in red for the first two rows and 'ON' in green for the remaining rows. At the bottom right, there is a pagination control showing 'Total 23 items' and '200 / page'.

System Name	IP	Network	Model Name	Monitoring Status	Polling Interval(s)
Switch123	192.168.10.10	lan10	DGS-1510-28P	OFF	300
Switch	192.168.10.210	lan10	DXS-3400-24SC	OFF	300
Switch	192.168.10.213	lan10	DGS-3130-30S	ON	300
Switch	192.168.10.214	lan10	DGS-1250-28XMP	ON	300
DXS-3610-54S	192.168.110.111	LAN220	DXS-3610-54T	ON	300
Switch	192.168.110.112	LAN220	DXS-3600-16S	ON	300
Switch	192.168.110.113	LAN220	DXS-3600-32S	ON	300
Switch28SC	192.168.110.114	LAN220	DGS-3630-28SC	ON	300
Switch24TC	192.168.110.115	LAN220	DXS-3400-24TC	ON	300
Switch	192.168.110.117	LAN220	DGS-3130-54TS	ON	300
N/A	192.168.220.150	LAN220	DGS-3000-28LP	ON	300
Switch	192.168.220.151	LAN220	DGS-3130-30PS	ON	300
Switch	192.168.220.152	LAN220	DGS-1520-28	ON	300
Switch	192.168.220.155	LAN220	DGS-1520-28MP	ON	300
Switch	192.168.220.156	LAN220	DGS-3630-28TC	ON	300

2. Select the monitor category from the left pane. The devices that have been associated with monitoring templates in this category will be displayed.

Monitor Settings Alarm Settings Alarmable Item Definition

Monitor Category

Search Monitor Category

Wired Traffic

1234

12345

1234567

802.1Q VLAN

AC L3 Discovery Details

AC VLAN Discovery Details

AC Valid AP

Authenticated Clients

BaseInfo

CPU Utilization

Cellular Running Details

Monitor List

Search

Edit Interval Edit Monitoring Status

System Name	IP	Network	Model Name	Monitoring Status	Polling Intervals(s)
Switch123	192.168.10.10	lan10	DGS-1510-28P	OFF	300
Switch	192.168.10.210	lan10	DXS-3400-245C	OFF	300
Switch	192.168.10.213	lan10	DGS-3130-30S	ON	300
Switch	192.168.10.214	lan10	DGS-1250-28XMP	ON	300
DXS-3610-54S	192.168.110.111	LAN220	DXS-3610-54T	ON	300
Switch	192.168.110.112	LAN220	DXS-3600-16S	ON	300
Switch	192.168.110.113	LAN220	DXS-3600-32S	ON	300
Switch285C	192.168.110.114	LAN220	DGS-3630-285C	ON	300
Switch24TC	192.168.110.115	LAN220	DXS-3400-24TC	ON	300
Switch	192.168.110.117	LAN220	DGS-3130-54TS	ON	300
N/A	192.168.220.150	LAN220	DGS-3000-28LP	ON	300
Switch	192.168.220.151	LAN220	DGS-3130-30PS	ON	300
Switch	192.168.220.152	LAN220	DGS-1520-28	ON	300
Switch	192.168.220.155	LAN220	DGS-1520-28MP	ON	300
Switch	192.168.220.156	LAN220	DGS-3630-28TC	ON	300

Total 23 items < 1 > 200 / page

- Select the devices for configuration and the **Edit Interval** and **Edit Monitoring Status** button will be activated.

Monitor Settings Alarm Settings Alarmable Item Definition

Monitor Category

Search Monitor Category

Chassis Port LED

Chassis Power

Chassis Slot

Cluster

DHCP Server Status

DLMS

Device Common Information

FAN

Fan

HTTP Status

HTTPS Status

Monitor List

Search

Edit Interval Edit Monitoring Status

System Name	IP	Network	Model Name	Monitoring Status	Polling Intervals(s)
Switch123	192.168.10.10	lan10	DGS-1510-28P	OFF	300
Switch	192.168.10.210	lan10	DXS-3400-245C	OFF	300
Switch	192.168.10.213	lan10	DGS-3130-30S	ON	300
Switch	192.168.10.214	lan10	DGS-1250-28XMP	ON	300
DXS-3610-54S	192.168.110.111	LAN220	DXS-3610-54T	ON	300
Switch	192.168.110.112	LAN220	DXS-3600-16S	ON	300
Switch	192.168.110.113	LAN220	DXS-3600-32S	ON	300
Switch285C	192.168.110.114	LAN220	DGS-3630-285C	ON	300
Switch24TC	192.168.110.115	LAN220	DXS-3400-24TC	ON	300
Switch	192.168.110.117	LAN220	DGS-3130-54TS	ON	300
N/A	192.168.220.150	LAN220	DGS-3000-28LP	ON	300
Switch	192.168.220.151	LAN220	DGS-3130-30PS	ON	300
Switch	192.168.220.152	LAN220	DGS-1520-28	ON	300
Switch	192.168.220.155	LAN220	DGS-1520-28MP	ON	300
Switch	192.168.220.156	LAN220	DGS-3630-28TC	ON	300

You can also enable or disable a monitor function on a per-device basis; go to the **Monitoring > Device View** and select the **Device Information** page by clicking the **System Name** link of the selected device. Then click the **Monitor** tab to access the **Monitoring Settings** button (refer to [4.2.2 Modify Device Information](#)).

5.12.3 Create Alarm Rules

Alarms can be generated to be displayed in the Annunciator to notify users if a configured condition for alarms has been raised. Refer to [3.3.3 Annunciator](#).

To add an alarm rule:

- Go to **Alarm & Notification > Monitor & Alarm Settings**. Then select the **Alarm Settings** tab.
- From the left pane, select a monitoring condition for configuration.
- Click **+Add** to configure a rule.

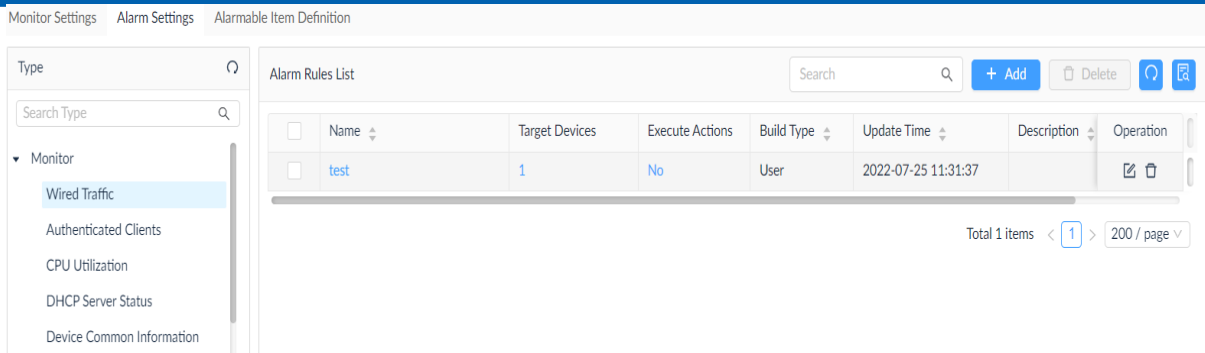

The **Add Alarm Rule** page displays.

Different rules require different configurations. However, the following general settings are presented for all alarm rule types:

- Set profile information: enter a name and description for the alarm rule.
 - Set alarm generation conditions: set the threshold value for different levels of severity of the alarm: Info, Warning, and Critical.
 - Set alarm release conditions: set the threshold value for clearing the alarm.
 - Add Inhibition Schedule Settings: select a pre-defined schedule. Or click **Add Schedule** to add a new schedule. The schedule prohibits delivery of alarms at the specified time range of a designated weekday or weekdays for the effective duration of dates.
 - Select target devices: add devices for configuration.
 - Set Action: execute a designated script. The script can be executed on designated device(s) other than the device configured as the alarm source or on selected D-View 8 servers. Click the respective Device Command or Server Command tab. For executing commands on device(s), configure the credentials and method for logging in to the devices.
4. Click **Next** or **OK** to continue the rule configuration.
 5. Click **Save** to create the rule and exit the screen.

6 Configuration and Firmware

The D-View 8 makes it easy to save and restore device configurations. It also allows schedule-based firmware upgrade and configuration changes..

The following topics are covered:

- Create Configuration
- Manage Tasks
- Upgrade Firmware
- Back Up and Restore Device Configuration
- Import Configuration and Firmware Files

6.1. Create Configuration and Profiles

You can apply specific configurations to designated devices on the network with quick or advanced batch operations.

Note: When the license expires, the **Batch Configuration** page will alert you that the system is running under a restriction on the number of nodes with full functionality and encourage you to renew your annual maintenance. To add maintenance licenses, refer to [14.3 Licenses](#).

Add a Configuration Task

1. Go to **Configuration > Batch Configuration**. The Batch Configuration page displays.

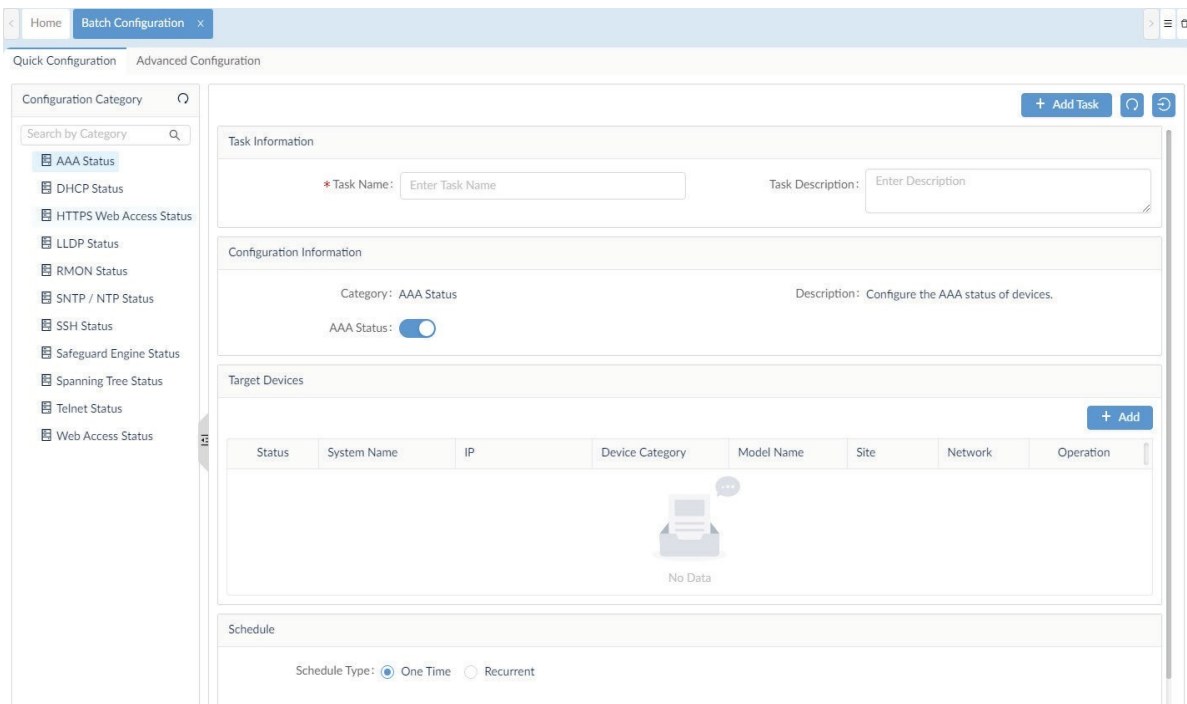

2. From the Configuration Category, select a category or enter a keyword in the search field to search for a desired configuration category. The system default configuration categories are explained below:

AAA Status	Select to set the Authentication, Authorization, and Accounting status configuration task
DHCP Status	Select to set the DHCP Status configuration task
HTTPS Web Access Status	Select to set the HTTPS Web Access Status configuration task

LLDP Status	Select to set the Link Layer Discovery Protocol Status configuration task
SNTP/NTP	Select to set the SNTP (Simple Network Time Protocol) or NTP (Network Time Protocol) status configuration task.
RMON Status	Select to set the RMON alarm status configuration task
SSH Status	Select to set the SSH Status configuration task
Safeguard Engine Status	Select to set the Safeguard Engine Status configuration task
Spanning Tree Status	Select to set Spanning Tree Status configuration task
Telnet Status	Select to set the Telnet Status configuration task.
Web Access Status	Select to set the Web Access Status configuration task
<p>Note: The above listed are system-built categories and it also displays customized categories of the Quick Configuration type. For user-defined categories, go to Templates > Configuration Template to add configuration categories and templates. Refer to 4.5.1 Configuration Categories and Templates.</p>	

3. Complete the fields as explained below:

Task Information	
Task Name	Enter the name to define the task.
Task Description	Enter a brief description to identify the task.
Add Task	Click to create the defined task.
Refresh	Click to refresh the task.
Configuration Information	
Status/Input	Apply the configuration changes for the job. For customized category, the options depend on the design of the template and selected protocol.
Target Devices	
Add	Click to add the device(s) for configuration. Note that only devices that support this function can be selected. For customized configuration categories, you need to associate the configuration template to the device template first. Refer to Templates > Device Template .
<p>Note: You can select multiple devices across different networks. To confine the configuration to only devices under the same network for better security, use the below Configuration Profile method.</p>	
Schedule Information	
Schedule Type	<ul style="list-style-type: none"> • One Time: Select this option to specify a date and time or immediately to initiate the network discovery. • Recurrent: Select this option to specify the frequency and effective time frame to initiate network discovery. Refer to 14.2 Scheduling for more information.

You can click **Task Management**  to open the **Task Management** page or **Configuration Template** to open the template page. Refer to [6.2.1 Current Tasks](#) for details about tasks.

Add a Configuration Profile

Configuration profiles are designed to allow multiple configuration categories for rapid network deployment. Unlike the above quick configuration, it can accommodate different categories of the **Advanced Configuration** type in a profile. Once a profile is defined, you can apply it to multiple devices in a network.

1. Go to **Configuration > Batch Configuration**.
2. Select the **Advanced Configuration** tab.

The Advanced Configuration page displays.

<input type="checkbox"/>	Profile Name	Model Name	Related Tasks	Related Devices	Site	Network	Update Time	De	Operation
<input type="checkbox"/>	Configure Profile LACP	DGS-1210-24(A1)	0	1	CS	Beijing_Marketing	2021-02-06 13:51:44	De	✎ 🗑️ + 🔍
<input type="checkbox"/>	Switch Profile2	DES-3028(A1)	0	1	CS	Beijing_Marketing	2020-12-17 13:51:46		✎ 🗑️ + 🔍
<input type="checkbox"/>	Switch Profile	DGS-3120-24TC(A1)	0	2	CS	Beijing_Marketing	2020-12-17 13:51:15	Sw	✎ 🗑️ + 🔍

Total 3 items < 1 > 100 / page

3. Click **Add Profile** to display the **Add Profile** page.

Add Profile

Profile Information

* Profile Name: * Device Hierarchy:

Profile Description:

* Configuration Feature:

<input type="checkbox"/>	Configuration Category	Description
<input type="checkbox"/>	AAA Status	
<input type="checkbox"/>	DHCP Status	
<input checked="" type="checkbox"/>	Telnet Status	
<input type="checkbox"/>	Syslog Status	
<input type="checkbox"/>	Spanning Tree Status	
<input type="checkbox"/>	SSH Status	
<input type="checkbox"/>	SNTP / NTP Status	
<input type="checkbox"/>	LLDP Status	
<input type="checkbox"/>	LACP	
<input type="checkbox"/>	Web Access Status	
<input type="checkbox"/>	Port Security	
<input type="checkbox"/>	MAC Notification	
<input type="checkbox"/>	802.1V Protocol VLAN	
<input type="checkbox"/>	Voice VLAN	
<input type="checkbox"/>	Loopback Detection	
<input type="checkbox"/>	MAC VLAN	

[Next](#)

4. Enter the following information to define the profile:

Profile Name	Enter a name to define the profile.
Device Hierarchy	Click the drop-down menu to select a device. Note that here you only need to specify a model to apply the configuration to. You can select devices of the designated model when creating tasks. Refer to the below Apply a Profile to Devices with Task .
Profile Description	Enter a brief description to identify the profile.
Configuration Feature List	<p>Select categories for the profile:</p> <ul style="list-style-type: none"> • AAA Status • DHCP Status • HTTPS Web Access Status • LLDP Status • RMON Status • SNTP/NTP Status • SSH Status • Trap Status • Syslog Status • Safeguard Engine Status • Spanning Tree Status • Telnet Status • Web Access Status
<p>Note: The available configuration category depends on the features supported. Unlike the Quick Configuration page described above, it allows you to select categories of the Advanced Configuration type. For customized (or user-built) configuration categories, you need to associate the configuration template to the device template first (go to Templates > Device Template).</p>	

5. Click **Next** to continue and configure the selected features.
6. Click **Save** after configuring the features for each category. Click **Previous** to return to the previous screen.

After a configuration profile is created, you can modify or delete it with the options under the Operation column.

The screenshot shows a web interface for 'Batch Configuration'. At the top, there are tabs for 'Quick Configuration' and 'Advanced Configuration'. Below the tabs is a search bar and several action buttons: '+ Add Profile', 'Task Management', 'Delete', and a refresh icon. The main content is a table with the following columns: Profile Name, Model Name, Related Tasks, Related Devices, Site, Network, Update Time, and Operation. The table contains three rows of data:

Profile Name	Model Name	Related Tasks	Related Devices	Site	Network	Update Time	Operation
Configure Profile LACP	DGS-1210-24(A1)	0	1	CS	Beijing_Marketing	2021-02-06 13:51:44	De [edit] [share] [task]
Switch Profile2	DES-3028(A1)	0	1	CS	Beijing_Marketing	2020-12-17 13:51:46	[edit] [share] [task]
Switch Profile	DGS-3120-24TC(A1)	0	2	CS	Beijing_Marketing	2020-12-17 13:51:15	Sw [edit] [share] [task]



At the bottom right of the table, there is a pagination control showing 'Total 3 items', a page number '1', and '100 / page'.









Item	Description
Edit	Modify the configuration profile settings.
Share	Copy the profile to configure devices of the same model on other networks.
Create Task	Create a task for the profile to perform the configuration on selected devices according to a set schedule. Refer to the following section for detailed instructions.
Delete	Remove the profile from the list.

Apply a Profile to Devices with Task

1. Go to **Configuration > Batch Configuration**.
2. Select **Advanced Configuration**.
3. Select a profile, then click + (**Create Task**) from the Operation column on the right to apply the profile to devices by creating a task.

Quick Configuration **Advanced Configuration**

Search **Add Profile** **Task Management** Delete  

<input type="checkbox"/>	Profile Name ↓	Model Name ↓	Related Tasks	Site ↓	Network ↓	Update Time ↓	Description	Operation
<input type="checkbox"/>	advanced-config-profile-for-DG S-3630	DGS-3630-28PC(Ax)	0	LAB	LAN220	2022-11-15 17:02:57		  + 
<input type="checkbox"/>	benson-test	DGS-1210-52(B1)	0	LAB	LAN220	2022-11-07 17:06:20		  + 
<input type="checkbox"/>	test_2022-11-02 21:05:48_Cop y1	DAP-2682(A1)	0	LAB	lan10	2022-11-02 21:11:28	test	  + 

The Task Settings page displays.

Task Settings X

Task Information

* Task Name:

Site: LAB Network: lan10

Model Name: DAP-2682(A1) Task Type: Advanced Config

Task Description:

Target Devices [Add Devices](#)



No Data

Schedule Information

Schedule Type: One Time Recurrent

[Cancel](#) [Save](#)

4. Enter the following information:

Task Information	
Task Name	Enter a name to define the task.
Task Description	Enter a brief description to identify the task.
Target Devices	
Add Devices	Click to add the device(s) for configuration. The Batch Select Devices screen displays. Select the desired devices or use the Search function to find devices.
Note: You can only select devices of the same model under the designated network. To apply the configuration profile to other networks, use the Share function under Operation . You can also create device groups with devices across networks in advance and select the desired group from the Device Group tab. (Refer to 4.3 Manage Device Groups .)	
Schedule Information	
Schedule Type	<ul style="list-style-type: none"> ● One Time: Select this option to specify a date and time or immediately to execute the task. ● Recurrent: Select this option to specify the frequency and effective duration to execute the task. Refer to 14.2 Scheduling for more information.

5. Click **Save** to create the new task and return to the previous menu. You can click **Task Management** to open the **Task Management** page. Refer to [6.2.1 Current Tasks](#) for details about tasks.

6.2. Manage Tasks

The Task Management function lets you manage current and previously performed tasks. Tasks initiated in the system can be edited, deleted, and restarted. You can also view the task execution record.

6.2.1. Current Tasks

Current tasks are tasks that are scheduled to be perform in the future.

To view current tasks:

1. Go to **Configuration > Task Management**. Then select the **Current Task** tab.

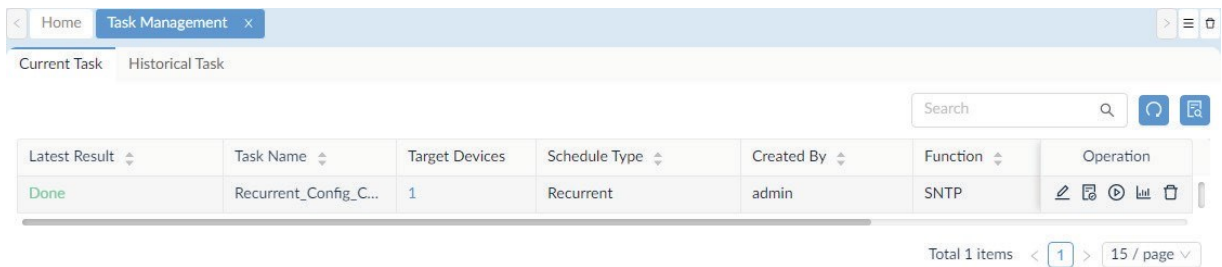

The following table displays the properties of the tasks and the functions that you can perform on them:

Item	Description
Task Name	Displays the defined name of the task.
Target Devices	Displays the number of devices that the task will be applied to.
Schedule Type	The configured schedule type: one-time or recurrent.
Created By	Displays the name of the task creator.
Function	Displays the featured functions or configuration profile name to be executed with the task.
Time Created	Displays the creation date of the task.
Next Execution Time	Displays the next scheduled start of the task.
Operation	
Edit Configuration	Click to edit the defined configuration.
Edit Task	Click to modify the task settings.
Restart/Pause Task	Click to activate/deactivate the task.
Show Task Record	Click to display the event timeline of the task, listed in chronological order.
Delete Task	Click to delete the task. You need to pause the task first for deletion.

6.2.2 Historical Tasks

Historical Tasks are tasks that have been performed in the past.

To view historical tasks:

Go to **Configuration > Task Management**. Then select the **Historical Task** tab.

Latest Result	Task Name	Created By	Function	End Time	Operation
Failed To Deliver	TEST03	mag	AAA Status ON	2022-11-02 15:17:02	

The following table shows the properties of the tasks and the functions you can perform on them:

Item	Description
Latest Result	Displays the results of the task: Partially done, Done, or Failed. Click on the link to open the result details page.
Task Name	Displays the defined name of the task.
Target Devices	Displays the number of devices that the task will be applied to.
Schedule Type	The configured schedule information
Created By	Displays the name of the task creator.
Function	Displays the featured functions or configuration profiles to be executed with the task.
End Time	Displays the finishing time of the task.
Time Created	Displays the creation date of the task.
Operation	
Edit Configuration	Click to edit the corresponding configuration file.
Re-execute Task	Click to modify the task and reschedule the task to be performed again. It will appear in the above Current Task tab for future execution dates.
Review Task	Obtain task details including name and type, target devices and task scheduling.
Show Task Record	Click to display the event timeline of the task, listed in chronological order.

6.3. Schedule a Firmware Upgrade

Scheduling a firmware upgrade task requires uploading firmware files first in File Management (refer to **Configuration > File Management**).

Note: When the license expires, the **Firmware Management** page will alert you that the system is running under a restriction on the number of nodes with full functionality and encourage you to renew your annual maintenance. To add maintenance licenses, refer to [14.3 Licenses](#).

To configure a firmware upgrade task:

1. Go to **Configuration > Firmware Management**.
2. In the **Resource Tree** pane, select the desired device model under the designated site(s) and network(s) for the upgrade task. Or enter a keyword in the Search field to locate the target network or model name. You can select the **Device Group** tab if you have created device groups for designated devices.
3. From the discovered or listed devices, select device(s) for firmware upgrade.

Device firmware information will be displayed:

Item	Description
Status	Displays the online/offline status of the device.
System Name	Displays the system name of the device.
IP	Displays the IP address of the device.
Firmware Version	Displays the device's firmware version.
Model Name	Displays the model name of the device.
Upgrade Result	Displays the result of the last firmware upgrade or the scheduled firmware upgrade.
Site/Network	Displays the site and network where the device resides.
Operation	
Edit	Click to modify the firmware upgrade task. You may need to stop the firmware upgrade task first to edit it.
Stop	Click to stop the task.
Reboot Device	Click to reboot the device after the firmware upgrade.

4. Click **Upgrade** in the upper right corner to configure the task.

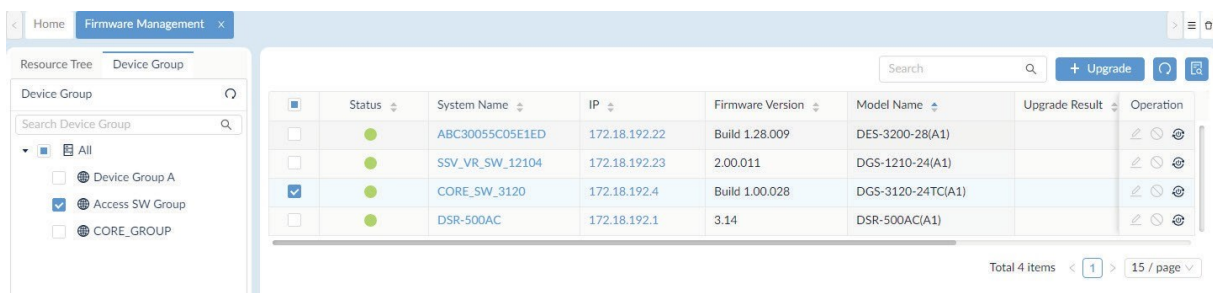

- The **Firmware Upgrade** page displays.

- Click **Select Firmware File**  to select a firmware file for the specified devices.
- The **Select Firmware File** page displays. Select the **Associated Firmware** tab to upload firmware from your local file system. Or select a firmware file stored in the server from the **Other Firmware** tab.

- Configure the following:

Item	Description
Selected Device	Displays the device(s) selected for the task. You can click Delete to remove the selected devices.
Schedule Information	
Schedule Type	Firmware upgrade is a one-time event.
Execution Time	Define the execution time, immediately or a specific date and time.

Reboot Type	Click to enable or disable (default) device reboot after firmware upgrade. A reboot is typically required for the new firmware to take effect.
-------------	--

9. Click **Save** to create the firmware upgrade task. Click **Cancel** to return to the previous screen.

The **Upgrade Result** column will record the results of the firmware upgrade task.

6.4. Back Up and Restore Device Configuration

The D-View 8 provides backup function to maintain configuration files on the server.

6.4.1. Add or Modify a Backup Profile

Regular system backup can be accomplished automatically through backup profiles.

Note: When the license expires, the **Configuration Management** page will alert you that the system is running under a restriction on the number of nodes with full functionality and encourage you to renew your annual maintenance. To add maintenance licenses, refer to [14.3 Licenses](#).

1. Go to **Configuration > Configuration Management**.
2. Select devices for backup.

Available devices with device information are displayed:

Item	Description
Status	Displays the online/offline status of the device.
System Name	Displays the system name of the device.
IP	Displays the IP address of the device.
Firmware Version	Displays the device's firmware version.
Model Name	Displays the model name of the device.
Backup Result	Displays the result of the last configuration backup or the scheduled backup.
Site/Network	Displays the site and network where the device resides.
Operation	
Edit	Click to modify the backup task. You may need to stop the backup task first to modify it.
Stop	Click to stop the task.

3. Click **Backup** to configure the task.

Status	System Name	IP	Firmware Version	Backup Result	Model Name	Site	Network	Operation
<input checked="" type="checkbox"/>	Switc901tt	172.18.192.22	Build 1.28.009		DES-3200-28	CS	Beijing_	
<input type="checkbox"/>	N/A	172.18.192.15	6.30.B008		DGS-1210-10	CS	Beijing_	
<input type="checkbox"/>	DWC-2000	172.18.193.98	4.7.4.2_Ax_WW		DWC-2000	CS	Beijing_	
<input type="checkbox"/>	DES3028	172.18.193.230	Build 2.00.B27		DES-3028	CS	Beijing_	
<input checked="" type="checkbox"/>	D-Link AP	172.18.192.20	4.3.0.2		DWL-8600AP	CS	Beijing_	
<input checked="" type="checkbox"/>	4911	172.18.193.49	Build 1.00.038		DWS-3160-24TC	CS	Beijing_	
<input type="checkbox"/>	dap3662	172.18.193.166	v2.01		DAP-3662	CS	Beijing_	
<input type="checkbox"/>	DES-3528	172.18.193.99	2.60.017		DES-3528	CS	Beijing_	
<input type="checkbox"/>	DLINK-WLAN-AP	172.18.193.184	3.0.0.16		DWL-8500AP	CS	Beijing_	
<input type="checkbox"/>	2126666	172.18.193.212	Build 3.10.012		DGS-3120-24TC	CS	Beijing_	
<input type="checkbox"/>	D-Link DAP-2690	172.18.192.182	3.16		DAP-2690B	CS	Beijing_	

The **Backup** page displays.

An existing configuration template or an uploaded new one can be used to compare the device's configuration settings. If there is any difference between the selected template and the existing configuration settings, an alarm can be triggered.

To compare configuration settings:

1. Click **Compare with specified file** to enable the comparison function.
2. For **Actions when different**, select the severity level for an alarm: Critical, Warning, or Info.

3. Enable **Restore Configuration** to restore the device's configuration with the specified file when the device's current settings show any difference. A configuration file for comparison and restoration must be selected.
4. For the selected devices, click **Upload File** in the **File** field to upload the configuration file for comparison.

Backup
✕

Selected Device

Compare with specified file:

Status	System Name	IP	Site	Network
●	Switc901tt	172.18.192.22	CS	Beijing_Marketing
●	D-Link AP	172.18.192.20	CS	Beijing_Marketing
●	4911	172.18.193.49	CS	Beijing_Marketing

Total 3 items < 1 > 100 / page ▾

Schedule

Schedule Type: One Time Recurrent

Execution Time: Immediately Specify a Date

Cancel
Save

5. The **Upload File** page displays. Click **Select File** to browse for a configuration file for comparison.
6. Click **Set as Baseline** if you would like to set this file as the baselined configuration for distinguishability or tracking between other configuration files.
7. Click **Save** to define the baseline file. Click **Cancel** to return to the previous screen. The uploaded files will be listed in **File Management** and will be available for configuration restoration.

Upload File
✕

Uploaded Files

* File Name: Select File

Baselined:

Description:

Cancel
Save

8. Under Schedule, select the scheduling method to perform the task:
 - Schedule Type: Click to define the frequency of the task, a single event or recurring task. For a recurring task, specify a pre-defined schedule or add a new schedule by specifying the repetition frequency (daily, weekly, monthly, or discrete dates) and effective duration. Refer to [14.2 Scheduling](#) for more information.
 - Execution Time: For a single event, define the execution time, immediately or a specific date and time.
9. Click **Save** to create the backup task. Click **Cancel** to return to the previous screen. The task is created and the backup task will be recorded in the **Backup Result** column.

10. You can also edit or stop a task. Under Operation, click the **Edit** or **Stop** on the right.

Backup Restore									
Search									
	Status	System Name	IP	Firmware Version	Backup Result	Model Name	Site	Network	Operation
<input type="checkbox"/>	●	Switc901tt	172.18.192.22	Build 1.28.009	Waiting for backup 2021-02-18 16:15:00	DES-3200-28	CS	Beijing_	
<input type="checkbox"/>	●	D-Link AP	172.18.192.20	4.3.0.2	Waiting for backup 2021-02-18 16:15:00	DWL-8600AP	CS	Beijing_	
<input type="checkbox"/>	●	4911	172.18.193.49	Build 1.00.038	Waiting for backup 2021-02-18 16:15:00	DWS-3160-24TC	CS	Beijing_	

6.4.2. Restore Device Configurations

Device configuration settings can be restored through a defined backup task with an assigned configuration file.

To restore a device configuration:

1. Go to **Configuration > Configuration Management**.
2. Click the **Restore** tab to view the defined restore tasks.

Backup Restore									
Search									
	Status	System Name	IP	Firmware Version	Restore Result	Restore File	Model Name	S	Operation
<input type="checkbox"/>	●	4911	172.18.193.49	Build 1.00.038	Waiting for restore 2021-02-25 16:44:00	filematching.docx	DWS-3160-24TC	C	
<input type="checkbox"/>	●	D-Link AP	172.18.192.20	4.3.0.2	Waiting for restore 2021-02-26 16:30:00	filematching.docx	DWL-8600AP	C	
<input type="checkbox"/>	●	N/A	172.18.192.15	6.30.B008		filematching.docx	DGS-1210-10	C	

3. Select a device with a pre-defined baseline file or the most recent backup version and click **Restore** to configure the task.



NOTE: Files that will be used for restoration can be selected by clicking the **Select** button under the **Restore File** column. You can also upload additional configuration files and assign a baseline file on the **Select Restoration File** page.

In the **Select Restoration File** page, you can perform the following on restoration files:

- Upload file
- Download file
- Set as baseline configuration

3. On the **Restore** page, under **Schedule Information**, select the scheduling method to perform the task:
 - **Schedule Type:** Click to define the frequency of the task, a single event or recurring task. For a recurring task, specify a pre-defined schedule or add a new schedule by specifying the repetition frequency (daily, weekly, monthly, or discrete dates) and effective duration. Refer to [14.2 Scheduling](#) for more information.
 - **Execution Time:** For a single event, define the execution, immediately or a specific date and time.
4. Click **Save** to create the restore task. Click **Cancel** to return to the previous screen.
5. You can also edit or stop a restore task. Under **Operation**, click **Edit** or **Stop** on the right.

The task is created and the restore task will be recorded in the **Restore Result** column along with other information such as system name, IP address, firmware version, and device model as well as device category.

6.5. File Management

You can manage firmware and configuration files for different models through the File Management function in Configuration. This function allows uploading, deleting, file comparison, and searching to help organize and apply uploaded files to upgrade firmware or restore configuration. In this manner, templates for firmware and configuration settings can be utilized to streamline the maintenance process. With a firmware or configuration template, maintaining consistency across networks can be easily achieved.

The following section provides descriptions of the functions in File Management and the operations that you can perform in File Management.

To access File Management menu:

Go to **Configuration > File Management**.

File Name	Baselined	File Type	Model Name	Site	Network	File Size	Related Devices	Operation
filematching.docx	★	Configuration File	DGS-1210-10	CS	Beijing_Marketing	11KB	1	🔗 ⬇️ 🗑️
filematching.docx	★	Configuration File	DWS-3160-24TC	CS	Beijing_Marketing	11KB	1	🔗 ⬇️ 🗑️
filematching.docx	★	Configuration File	DWL-8600AP	CS	Beijing_Marketing	11KB	1	🔗 ⬇️ 🗑️
filematching.docx	★	Configuration File	DES-3200-28	CS	Beijing_Marketing	11KB	1	🔗 ⬇️ 🗑️
edmhero-D.jpg	★	Configuration File	DES-3200-28	CS	Beijing_Marketing	184KB	1	🔗 ⬇️ 🗑️
PrivatePortInfo_DGS_3120_24TC_A1_MonitorTemplate.json	★	Configuration File	DWL-8600AP	site_sim	Shanghai_Finance	10KB	0	🔗 ⬇️ 🗑️
172.18.192.4_DGS-3120-24TC.cfg		Firmware File	DWL-8600AP	site_sim	Shanghai_Finance	35KB	10	🔗 ⬇️ 🗑️
DView8_Device.json	★	Configuration File	DGS-1210-10	CS	Beijing_Marketing	14MB	0	🔗 ⬇️ 🗑️

Total 8 items < 1 > 100 / page

The following table describes the functions in the File Management page.

Item	Description
Search	Enter a keyword to search for a file name, site, or network.
Delete	Select an entry and click Delete to remove it.
File Comparison	Select two configuration files to compare. Both files must be text based. You may also go to Tools > File Comparison to access this function.
Refresh	Refresh the table.
Advanced Query	Filter by File Name, File Type, Upload Time, Status, Site, Network, Uploaded by, or Model Name.
Column Selector	Click to add or remove columns from the File Management table. The following column properties are available: File Name, Baselined, File Type, Site, File Size, Status, Description, Model Name, Network, Related Devices, and Upload Time. Select All to enable all column options. Click Apply to confirm the new header selection.
Operation	
Edit	Click to edit the file listing.
Download	Click to export the file to a local system.
Delete	Click to remove the listing.

To upload a file to the server:

1. Click the **Upload File** at the top right.

2. Configure the following:

File Information	
Select File	Click to browse and define a configuration or firmware template.
File Type	Click the drop-down menu to select the type of file: Firmware File or Configuration File.
Description	Give a description of this file.
Set as Baseline	Designate the file as a baseline template. This is only available for the configuration file type.
Share	Enable this option to allow the uploaded file to be shared with other networks. This is only available for the firmware file type.
Description	Enter a short description to help identify this file.
Corresponding Device	
Site	Select a corresponding site.
Network	Select a network from the above selected site.
Model Name	Select the model name for file upload.
Device	Select the device for the file upload (only available for the configuration file type).
Cancel	Click Cancel to return to the previous menu.
Save	Click Save to add the defined file upload.

6.5.1. Firmware Management

Devices benefit from the latest firmware version, which may enhance the overall security and functionality. Check your device's support or about page to obtain the latest firmware version.

Caution:

When updating firmware, make sure the firmware is correct for the selected device. Employing the right firmware to the selected devices is essential for successful upload. The wrong firmware may cause damage to devices.

This section covers the following topics:

- Import a firmware file
- Modify a firmware file

- Export a firmware file
- Remove a firmware file

Import a Firmware File

To import a firmware file:

1. Go to **Configuration > File Management**.
2. Click **Upload File** at the right. The Upload File page appears.

3. Click **Select File** to browse and select the target file for upload.
4. From **File Type**, select **Firmware File** for the uploaded file type.
5. Enable the **Share** option to share the uploaded firmware with other networks.
6. In the **Description** field, enter a brief description for the file.
7. Click the **Site** drop-down menu to select a site where the device model belongs to.
8. Click the **Network** drop-down menu to select a network under the selected site.
9. Click the **Model Name** drop-down menu to select a model to apply the firmware.
10. Click **Save** to create a firmware file entry or **Cancel** to return to the previous menu.

Modify a Firmware File Entry

To modify an existing firmware file entry:

1. Go to **Configuration > File Management**.
2. From the File Management page, select an existing entry from the list, then click **Edit** under **Operation**.

<input type="checkbox"/>	File Name	Baselined	File Type	Model Name	Site	Network	Operation
<input checked="" type="checkbox"/>	config.bin	N/A	Firmware File	DAP-2690B	Taipei	Marketing	Edit Download Delete
<input type="checkbox"/>	2021-03-30_09-32-27_172.18.193.212_DGS-3120-24TC.cfg	★	Configuration File	DGS-3120-24TC	Taipei	Marketing	Edit Download Delete
<input type="checkbox"/>	2021-03-29_20-12-57_172.18.193.209_DWS-3160-24PC.cfg	★	Configuration File	DWS-3160-24PC	Taipei	Marketing	Edit Download Delete
<input type="checkbox"/>	2021-03-29_20-12-16_172.18.193.212_DGS-3120-24TC.cfg	★	Configuration File	DGS-3120-24TC	Taipei	Marketing	Edit Download Delete
<input type="checkbox"/>	2021-03-23_10-50-00_172.18.193.209_DWS-3160-24PC.cfg	★	Configuration File	DWS-3160-24PC	Taipei	Marketing	Edit Download Delete
<input type="checkbox"/>	2021-03-22_17-30-00_172.18.193.209_DWS-3160-24PC.cfg	★	Configuration File	DWS-3160-24PC	Taipei	Marketing	Edit Download Delete
<input type="checkbox"/>	2021-03-22_17-52-01_172.18.193.209_DWS-3160-24PC.cfg	★	Configuration File	N/A	Taipei	Marketing	Edit Download Delete

Total 7 items < 1 > 15 / page

3. The File Information page displays. From this page you can modify the file information.

File Information

File Name: config.bin

File Type: Firmware File

File Size: 7KB

Related Devices: 1

Status: Not used

Upload Time: 2021-04-26 11:00:17

Share:

Description:

Corresponding Device

* Site: * Network:

Model Name:

4. Enter a description to help identify the entry.
5. Modify the corresponding device information:
 - Site
 - Network
 - Model Name
6. Click **Save** to apply the changes or **Cancel** to return to the previous menu.

Export a Firmware File

To export an existing firmware file:

1. Go to **Configuration > File Management**.
2. From the File Management page, select an existing entry from the list, then click **Download**.

<input type="checkbox"/>	File Name	Baselined	File Type	Model Name	Site	Network	Operation
<input type="checkbox"/>	config.bin	N/A	Firmware File	DAP-2690B	Taipei	Marketing	Download Refresh Delete
<input type="checkbox"/>	2021-03-30_09-32-27_172.18.193.212_DGS-3120-24TC.cfg	★	Configuration File	DGS-3120-24TC	Taipei	Marketing	Download Refresh Delete
<input type="checkbox"/>	2021-03-29_20-12-57_172.18.193.209_DWS-3160-24PC.cfg	★	Configuration File	DWS-3160-24PC	Taipei	Marketing	Download Refresh Delete
<input type="checkbox"/>	2021-03-29_20-12-16_172.18.193.212_DGS-3120-24TC.cfg	★	Configuration File	DGS-3120-24TC	Taipei	Marketing	Download Refresh Delete
<input type="checkbox"/>	2021-03-23_10-50-00_172.18.193.209_DWS-3160-24PC.cfg	★	Configuration File	DWS-3160-24PC	Taipei	Marketing	Download Refresh Delete
<input type="checkbox"/>	2021-03-22_17-30-00_172.18.193.209_DWS-3160-24PC.cfg	★	Configuration File	DWS-3160-24PC	Taipei	Marketing	Download Refresh Delete
<input type="checkbox"/>	2021-03-22_17-52-01_172.18.193.209_DWS-3160-24PC.cfg	★	Configuration File	N/A	Taipei	Marketing	Download Refresh Delete

Total 7 items < 1 > 15 / page

The file will be downloaded to the default download folder of your browser. A successful download notification will be displayed once the file is exported to your local system.

Remove a Firmware File

To remove a firmware file:

1. Go to **Configuration > File Management**.
2. From the **File Management** page, select an existing entry from the list, then click **Delete File** under **Operation**.

<input type="checkbox"/>	File Name	Baselined	File Type	Model Name	Site	Network	Operation
<input type="checkbox"/>	config.bin	N/A	Firmware File	DAP-2690B	Taipei	Marketing	Download Refresh Delete
<input type="checkbox"/>	2021-03-30_09-32-27_172.18.193.212_DGS-3120-24TC.cfg	★	Configuration File	DGS-3120-24TC	Taipei	Marketing	Download Refresh Delete
<input type="checkbox"/>	2021-03-29_20-12-57_172.18.193.209_DWS-3160-24PC.cfg	★	Configuration File	DWS-3160-24PC	Taipei	Marketing	Download Refresh Delete
<input type="checkbox"/>	2021-03-29_20-12-16_172.18.193.212_DGS-3120-24TC.cfg	★	Configuration File	DGS-3120-24TC	Taipei	Marketing	Download Refresh Delete
<input type="checkbox"/>	2021-03-23_10-50-00_172.18.193.209_DWS-3160-24PC.cfg	★	Configuration File	DWS-3160-24PC	Taipei	Marketing	Download Refresh Delete
<input type="checkbox"/>	2021-03-22_17-30-00_172.18.193.209_DWS-3160-24PC.cfg	★	Configuration File	DWS-3160-24PC	Taipei	Marketing	Download Refresh Delete
<input type="checkbox"/>	2021-03-22_17-52-01_172.18.193.209_DWS-3160-24PC.cfg	★	Configuration File	N/A	Taipei	Marketing	Download Refresh Delete

Total 7 items < 1 > 15 / page

A confirmation prompt will be displayed. Click **Yes** to delete or **No** to cancel the operation.

6.5.2. Configuration Management

The Configuration Management allows you to back up and restore device configurations.

This section covers the following topics:

- Import a configuration file
- Modify a configuration file
- Export a configuration file
- Remove a configuration file

Import a Configuration File

You can restore the configuration of D-Link devices on your network. You can also schedule restoration tasks to be executed on a recurrent basis for batch operations.

To import a configuration file:

1. Go to **Configuration > File Management**.

<input type="checkbox"/>	File Name	Baselined	File Type	Model Name	Site	Network	Operation
<input type="checkbox"/>	config.bin	N/A	Firmware File	DAP-2690B	Taipei	Marketing	✎ ↓ 🗑️
<input type="checkbox"/>	2021-03-30_09-32-27_172.18.193.212_DGS-3120-24TC.cfg	★	Configuration File	DGS-3120-24TC	Taipei	Marketing	✎ ↓ 🗑️
<input type="checkbox"/>	2021-03-29_20-12-57_172.18.193.209_DWS-3160-24PC.cfg	★	Configuration File	DWS-3160-24PC	Taipei	Marketing	✎ ↓ 🗑️
<input type="checkbox"/>	2021-03-29_20-12-16_172.18.193.212_DGS-3120-24TC.cfg	★	Configuration File	DGS-3120-24TC	Taipei	Marketing	✎ ↓ 🗑️
<input type="checkbox"/>	2021-03-23_10-50-00_172.18.193.209_DWS-3160-24PC.cfg	★	Configuration File	DWS-3160-24PC	Taipei	Marketing	✎ ↓ 🗑️
<input type="checkbox"/>	2021-03-22_17-30-00_172.18.193.209_DWS-3160-24PC.cfg	★	Configuration File	DWS-3160-24PC	Taipei	Marketing	✎ ↓ 🗑️
<input type="checkbox"/>	2021-03-22_17-52-01_172.18.193.209_DWS-3160-24PC.cfg	★	Configuration File	N/A	Taipei	Marketing	✎ ↓ 🗑️

Total 7 items < 1 > 15 / page

2. Click **Upload File** to display the Upload File page.

Upload File
✕

File Information

* File Name: Select File

* File Type: Firmware File

Share:

Description:

Corresponding Device

* Site: Select site * Network: Select network

Model Name: Select model name

Cancel
Save

3. Click **Select File** to browse and select the file for upload.
4. From **File Type**, select Configuration File for the uploaded file type.
5. Click **Set as Baseline** to set the uploaded configuration as the baseline file for file comparison or default restore file.
6. In the **Description** field, enter a brief description for the file.
7. Click the **Site** drop-down menu to select a site for the devices.
8. Click the **Network** drop-down menu to select a network under the selected site.
9. Click the **Model Name** drop-down menu to select a model to apply the configuration.
10. Click the **Device** drop-down menu to select a device to apply the configuration.
11. Click **Save** to create a configuration file entry or **Cancel** to return to the previous menu.

Upload File
✕

File Information

* File Name: Select File

* File Type: Configuration File ▼

Set as Baseline:

Description:

Corresponding Device

* Site: Select site ▼ * Network: Select network ▼

Model Name: Select model name ▼ Device: Select device ▼

Cancel
Save

Modify a Configuration File Entry

A configuration file of a device can be used as a template to configure other devices on the network. The first step is to assign a configuration file to apply for the target device(s).

To modify settings of a configuration file:

1. Go to **Configuration > File Management**.

2. From the File Management page, select an existing entry from the list, then click **Edit**.

File Name	Baselined	File Type	Model Name	Site	Network	Operation
config.bin	N/A	Firmware File	DAP-2690B	Taipei	Marketing	
2021-03-30_09-32-27_172.18.193.212_DGS-3120-24TC.cfg	★	Configuration File	DGS-3120-24TC	Taipei	Marketing	
2021-03-29_20-12-57_172.18.193.209_DWS-3160-24PC.cfg	★	Configuration File	DWS-3160-24PC	Taipei	Marketing	
2021-03-29_20-12-16_172.18.193.212_DGS-3120-24TC.cfg	★	Configuration File	DGS-3120-24TC	Taipei	Marketing	
2021-03-23_10-50-00_172.18.193.209_DWS-3160-24PC.cfg	★	Configuration File	DWS-3160-24PC	Taipei	Marketing	
2021-03-22_17-30-00_172.18.193.209_DWS-3160-24PC.cfg	★	Configuration File	DWS-3160-24PC	Taipei	Marketing	
2021-03-22_17-52-01_172.18.193.209_DWS-3160-24PC.cfg	★	Configuration File	N/A	Taipei	Marketing	

Total 7 items < 1 > 15 / page

3. The File Information page displays. From this page you can modify file information.

2021-03-29_20-12-57_172.18.193.209_DWS-3160-24PC.cfg ✕

File Information

File Name: 2021-03-29_20-12-57_172.18.193.209_DWS-3160-24PC.cfg

File Type: Configuration File

File Size: 77KB

Related Devices: 1

Status: Not used

Upload Time: 2021-03-29 20:12:59

Set as Baseline:

Description:

Corresponding Device

* Site: * Network:

* Model Name: * Device:

4. Click **Set as Baseline** to designate this file as a baseline to be used as the default configuration for restoration.
5. Enter a description to identify the entry.
6. Modify the corresponding device information:
 - Site
 - Network
 - Model Name
 - Device
7. Click **Save** to apply the changes or **Cancel** to return to the previous menu.

Export a Configuration File

To export an existing configuration file:

1. Go to **Configuration > File Management**. The File Management page displays.

File Name	Baselined	File Type	Model Name	Site	Network	Operation
config.bin	N/A	Firmware File	DAP-2690B	Taipei	Marketing	Edit Download Delete
<input checked="" type="checkbox"/> 2021-03-30_09-32-27_172.18.193.212_DGS-3120-24TC.cfg	★	Configuration File	DGS-3120-24TC	Taipei	Marketing	Edit Download Delete
<input type="checkbox"/> 2021-03-29_20-12-57_172.18.193.209_DWS-3160-24PC.cfg	★	Configuration File	DWS-3160-24PC	Taipei	Marketing	Edit Download Delete
<input type="checkbox"/> 2021-03-29_20-12-16_172.18.193.212_DGS-3120-24TC.cfg	★	Configuration File	DGS-3120-24TC	Taipei	Marketing	Edit Download Delete
<input type="checkbox"/> 2021-03-23_10-50-00_172.18.193.209_DWS-3160-24PC.cfg	★	Configuration File	DWS-3160-24PC	Taipei	Marketing	Edit Download Delete
<input type="checkbox"/> 2021-03-22_17-30-00_172.18.193.209_DWS-3160-24PC.cfg	★	Configuration File	DWS-3160-24PC	Taipei	Marketing	Edit Download Delete
<input type="checkbox"/> 2021-03-22_17-52-01_172.18.193.209_DWS-3160-24PC.cfg	★	Configuration File	N/A	Taipei	Marketing	Edit Download Delete

Total 7 items < 1 > 15 / page

2. From the File Management page, select the desired entry from the list, then click **Download**.

The file will be downloaded to the default download folder of your browser. A successful download message will be displayed once the file is exported to the local system.

Remove a Configuration File

To remove a configuration file:

1. Go to **Configuration > File Management**.

The screenshot shows a web interface for File Management. At the top, there are navigation tabs for 'Home' and 'File Management'. Below the tabs is a search bar and several action buttons: '+ Upload File', 'Delete', 'File Comparison', and three utility icons. The main content is a table with the following columns: File Name, Baselined, File Type, Model Name, Site, Network, and Operation. The table contains seven rows of configuration files. The second row is selected, indicated by a blue checkmark in the first column and a blue background for the entire row.

File Name	Baselined	File Type	Model Name	Site	Network	Operation
config.bin	N/A	Firmware File	DAP-2690B	Taipei	Marketing	✎ ⬇ 🗑
2021-03-30_09-32-27_172.18.193.212_DGS-3120-24TC.cfg	★	Configuration File	DGS-3120-24TC	Taipei	Marketing	✎ ⬇ 🗑
2021-03-29_20-12-57_172.18.193.209_DWS-3160-24PC.cfg	★	Configuration File	DWS-3160-24PC	Taipei	Marketing	✎ ⬇ 🗑
2021-03-29_20-12-16_172.18.193.212_DGS-3120-24TC.cfg	★	Configuration File	DGS-3120-24TC	Taipei	Marketing	✎ ⬇ 🗑
2021-03-23_10-50-00_172.18.193.209_DWS-3160-24PC.cfg	★	Configuration File	DWS-3160-24PC	Taipei	Marketing	✎ ⬇ 🗑
2021-03-22_17-30-00_172.18.193.209_DWS-3160-24PC.cfg	★	Configuration File	DWS-3160-24PC	Taipei	Marketing	✎ ⬇ 🗑
2021-03-22_17-52-01_172.18.193.209_DWS-3160-24PC.cfg	★	Configuration File	N/A	Taipei	Marketing	✎ ⬇ 🗑

At the bottom right of the table, there is a pagination control showing 'Total 7 items', a page number '1' in a box, and '15 / page'.

2. From the File Management page, select the desired entry with the configuration file type, then click **Delete File**.
3. A confirmation prompt will be displayed for the deletion. Click **Yes** to delete or **No** to cancel the operation.

7 Alarm and Notification

Alerts and notifications can be sent automatically when an upper or a lower threshold has been reached. If the threshold is exceeded, an alarm will be generated. You can set alarm notifications to be received by email, web scrolling notification, or as a script to be executed on selected devices.

The section covers the following topics:

- View Alarms
- View Traps and Syslog
- Trap Editor
- Syslog Editor
- Monitor and Alarms
- View and Manage Notifications

7.1. View Alarms

Alarms for all devices can be viewed centrally from the D-View application interface.

1. Go to **Alarm & Notification > Alarm**.
2. You can view both active and historical alarms.

Level	Last Updated	Duration	System Name	IP	Alarm Type	Latest Message
Critical	2021-02-08 10:42:02	612h8min56s	N/A	172.18.190.95	Response Time	Response Time (Time Out) <= Time Out

Item	Description
Active Alarms	Displays a list of the currently active alarm events.
Historical Alarms	Displays a list of alarm events already been acknowledged or been stopped.
Critical	Indicates a critical (highest) severity level for the alarm (red).
Warning	Indicates a warning (middle) severity level for the alarm (yellow).
Info	Indicates an informative (lowest) level for the alarm (blue).
Search	Enter a keyword to filter the list by System Name, IP, or Latest Message.
Acknowledge	Select an alarm event and click Acknowledge to move the alarm entry to Historical Alarms. Note that this will not disable the alarm setting.
Column Selector	Click to add or remove columns from the list. The following column properties are available: Level, Last Updated, Duration, System Name, IP, Alarm Type, and Latest Message.
Refresh	Click to refresh the table listing.
Export	Click to export the list as a CSV file. Up to 10,000 entries can be downloaded in one export job.
Advanced Query	Click to perform an advanced search job. Select the criteria to filter the table listing. Click Search to start the search.

7.2. View Traps and Syslog

The Trap & Syslog list displays the device trap events and syslog messages with the time. For trap events, the SNMP version, the original trap messages and the translated messages will be recorded. For syslog, messages will be assigned with a severity label. You can also send traps and logs to a remote logging server (go to **System > Basic Settings > Forward Trap** and **System > Basic Settings > Forward Syslog** to configure a remote trap and syslog server respectively). Both Trap and Syslog page allows you to refresh the list and export the records as a CSV file.

Note: You need to configure the D-View as Trap Server and Syslog Server for the managed devices so that logs and traps can be collected by the system (go to **Monitoring > Device View** and select the **System Name** link of a device to open its Device Information page. Then click the **Management** tab to find the Trap and Syslog status switch.) From the Device Information page, you can also view trap events and syslog messages generated from the selected device by clicking the Trap & Syslog tab.

To view device's logs, follow these steps:

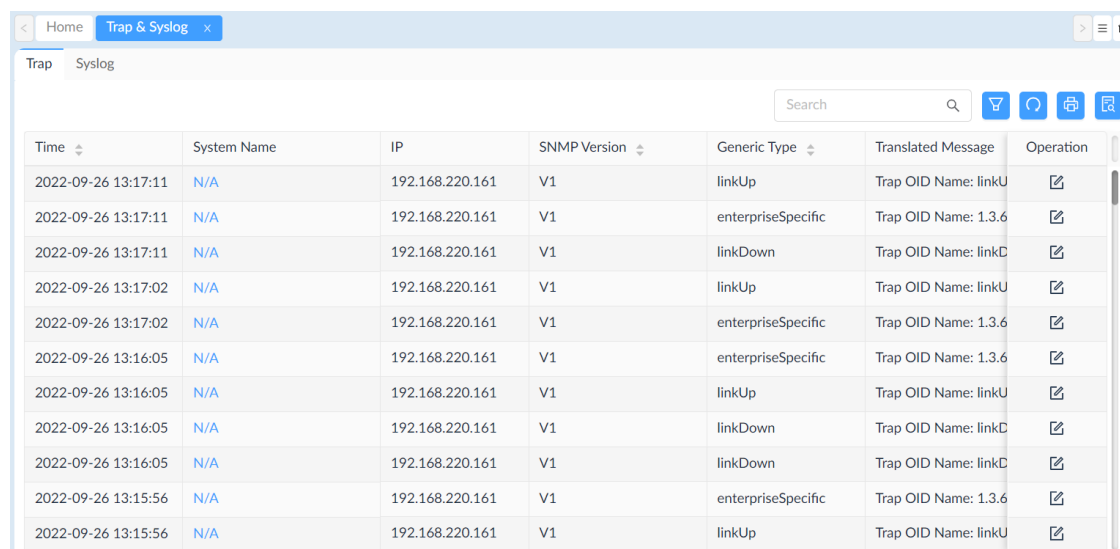

The screenshot shows a web browser window with the 'Trap & Syslog' page. The page has a search bar and several action icons (filter, refresh, print, export). Below the search bar is a table with the following columns: Time, System Name, IP, SNMP Version, Generic Type, Translated Message, and Operation. The table contains 12 rows of trap events, all from the system 'N/A' at IP '192.168.220.161' with SNMP version 'V1'. The events include linkUp, enterpriseSpecific, and linkDown messages with their respective translated messages and edit icons in the Operation column.

Time	System Name	IP	SNMP Version	Generic Type	Translated Message	Operation
2022-09-26 13:17:11	N/A	192.168.220.161	V1	linkUp	Trap OID Name: linkU	
2022-09-26 13:17:11	N/A	192.168.220.161	V1	enterpriseSpecific	Trap OID Name: 1.3.6	
2022-09-26 13:17:11	N/A	192.168.220.161	V1	linkDown	Trap OID Name: linkD	
2022-09-26 13:17:02	N/A	192.168.220.161	V1	linkUp	Trap OID Name: linkU	
2022-09-26 13:17:02	N/A	192.168.220.161	V1	enterpriseSpecific	Trap OID Name: 1.3.6	
2022-09-26 13:16:05	N/A	192.168.220.161	V1	enterpriseSpecific	Trap OID Name: 1.3.6	
2022-09-26 13:16:05	N/A	192.168.220.161	V1	linkUp	Trap OID Name: linkU	
2022-09-26 13:16:05	N/A	192.168.220.161	V1	linkDown	Trap OID Name: linkD	
2022-09-26 13:16:05	N/A	192.168.220.161	V1	linkDown	Trap OID Name: linkD	
2022-09-26 13:15:56	N/A	192.168.220.161	V1	enterpriseSpecific	Trap OID Name: 1.3.6	
2022-09-26 13:15:56	N/A	192.168.220.161	V1	linkUp	Trap OID Name: linkU	

You can perform the following operations on the Trap or Syslog list:

Item	Description
Search	Enter a keyword to filter the Trap or Syslog Editor list.
Edit	For SNMP traps, you can modify their OID description as well as the value description of a binding variable (refer to the below section).
Advanced Query	Select the criteria to filter the events or logs.
Refresh	Click to refresh the table listing.
Export	Export the table in CSV file format.

The translated message is based on the message from the original trap events. You can modify the translation between a trap OID and OID description as well as the translation between binding variable value and value description for OIDs with binding variables by clicking **Edit** under **Operation**. Note the modification here will also be saved on the **Trap Editor** page (go to **Alarm & Notification > Trap & Syslog Editor > Trap Editor**.)

You can also configure alarm rules based on selected trap event with matched trap OID or binding values. Refer to [7.5 Monitor and Alarms](#) for more information.

Click the **Syslog** tab to view syslog list.

Time	System Name	IP	Severity	Message
2023-01-17 16:41:47	Switch-220-225	192.168.220.225	Informational	INFO: STP New Root bridge selected (Instance:0, MAC: 0c:0e:76:8b:bb:81, Priority : 32768)
2023-01-17 16:07:23	Switch-220-225	192.168.220.225	Informational	INFO: STP New Root bridge selected (Instance:0, MAC: 00:18:e7:c2:af:20, Priority : 32768)
2023-01-17 16:00:05	Switch-220-225	192.168.220.225	Informational	INFO: STP New Root bridge selected (Instance:0, MAC: 0c:0e:76:8b:bb:81, Priority : 32768)
2023-01-08 14:00:47	Switch-220-225	192.168.220.225	Notice	NOTICE: Topology changed (Instance:0, eth5/0/50, MAC: 0c:0e:76:8b:bb:81)
2023-01-08 13:59:47	Switch-220-225	192.168.220.225	Notice	NOTICE: Topology changed (Instance:0, eth5/0/50, MAC: 0c:0e:76:8b:bb:81)
2023-01-08 13:59:47	Switch-220-225	192.168.220.225	Notice	NOTICE: Topology changed (Instance:0, eth5/0/50, MAC: 0c:0e:76:8b:bb:81)
2022-12-30 15:52:26	Switch-220-225	192.168.220.225	Notice	NOTICE: Spanning Tree port status change (Instance:0, eth5/0/49) Discarding -> Learning
2022-12-30 15:52:26	Switch-220-225	192.168.220.225	Notice	NOTICE: Spanning Tree port status change (Instance:0, eth5/0/49) Learning -> Forwarding
2022-12-30 15:52:26	Switch-220-225	192.168.220.225	Informational	INFO: Spanning Tree port role change (Instance:0, eth5/0/49) DisabledPort -> DesignatedPort
2022-12-30 15:52:26	Switch-220-225	192.168.220.225	Informational	INFO: Port Ethernet 5/0/49 link up, 1000Mbps FULL duplex
2022-12-30 15:50:16	Switch-220-225	192.168.220.225	Informational	INFO: Spanning Tree port role change (Instance:-2147483648, eth5/0/49) DesignatedPort -> DisabledPort
2022-12-30 15:50:16	Switch-220-225	192.168.220.225	Notice	NOTICE: Spanning Tree port status change (Instance:0, eth5/0/49) Forwarding -> Discarding
2022-12-30 15:50:16	Switch-220-225	192.168.220.225	Informational	INFO: Port Ethernet 5/0/49 link down

The syslog contains the following severity levels from the highest to the lowest.

Severity	Description
Emergency	Indicates that the device is failing to operate normally.
Alert	Indicates that immediate investigation is needed.
Critical	Indicates that the device is in critical condition.
Error	Indicates that an error has been found on the device.
Warning	Indicates a warning condition of the device's operation.
Notice	Indicates a normal but significant condition that needs an operator's attention.
Informational	Indicates a specific condition that is not erroneous but needs to be recorded for reference or troubleshooting purposes.
Debug	Indicates messages for debugging purposes.

You can easily spot a particular log message when interpreting syslog reports by setting a syslog description with associated syslog keywords. Refer to the below [7.4 Syslog Editor](#) and [12 Reports](#) for more information.

7.3. Trap Editor

Traps can alert you to possible errors of the managed devices while syslog records problems of device operation. You can define object identifiers (OIDs) of a trap to help determine the nature of a problem. To view trap messages of all managed devices, go to **Alarm & Notification > Trap & Syslog > Trap**.

To add an OID description entry:

1. Go to **Alarm & Notification > Trap & Syslog Editor**.
2. Click the **Trap Editor** tab. You can add a trap OID or a binding variable OID type.

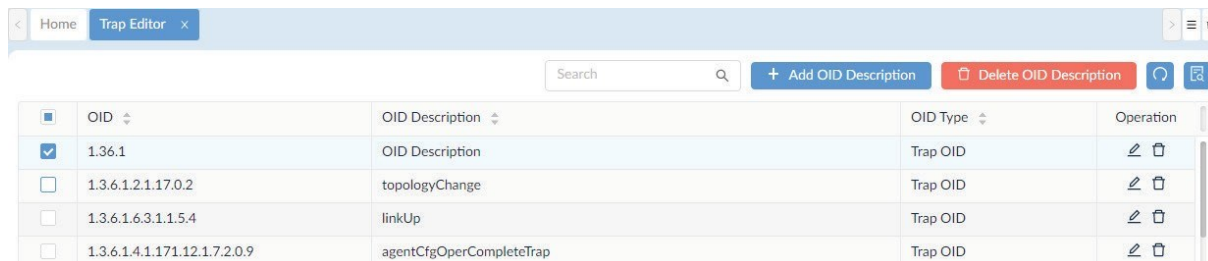

<input type="checkbox"/>	OID	OID Description	OID Type	Operation
<input checked="" type="checkbox"/>	1.36.1	OID Description	Trap OID	
<input type="checkbox"/>	1.3.6.1.2.1.17.0.2	topologyChange	Trap OID	
<input type="checkbox"/>	1.3.6.1.6.3.1.1.5.4	linkUp	Trap OID	
<input type="checkbox"/>	1.3.6.1.4.1.171.12.1.7.2.0.9	agentCfgrOperCompleteTrap	Trap OID	

To add a trap or binding variable OID, click **Add OID Description**. Then enter an OID with a description for both types of OID. For binding variable OIDs, enter variable values with matching descriptions. The entry determines how a trap should be interpreted.

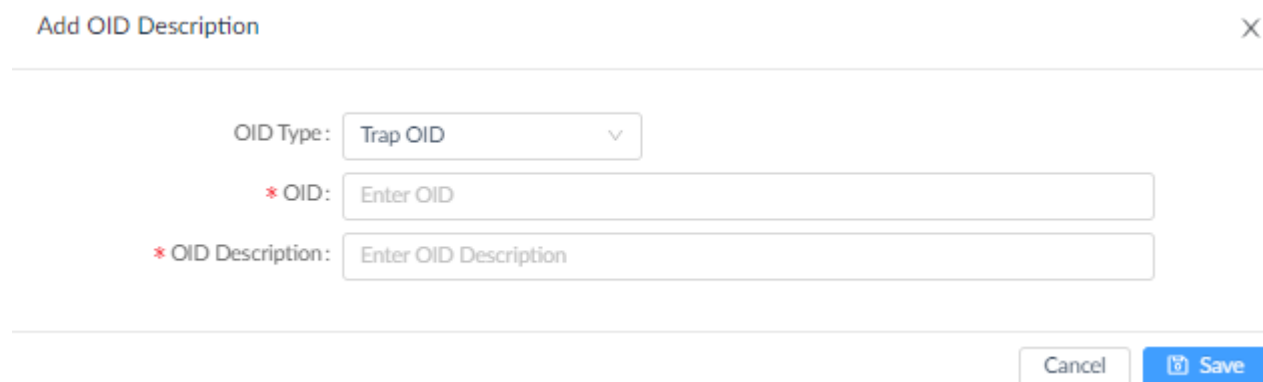

Add OID Description X

OID Type:

* OID:

* OID Description:

To edit an entry, select it and click Edit . The translated message in the Trap list should reflect the changes. You can generate trap reports using the provided report template and the OID description will be the highlighted text to signify trap events. Refer to [12.2.1 Add a Report](#) for more information.

7.4. Syslog Editor

The syslog is used to log device data. It allows you to analyze and help troubleshoot problems in time. Furthermore, you can add a syslog description to help you visualize particular log messages. To generate a Syslog report with the effect provided by Syslog Editor, go to **Reports > General Reports** and select the **Syslog** category under **Device Reports**. (Refer to [12.2 Manage Report Templates](#) for more information.) To view logs of all managed devices, go to **Alarm & Notification > Trap & Syslog > Syslog**.

To obtain the types of syslog messages:

1. Go to **Alarm & Notification > Trap & Syslog Editor**.

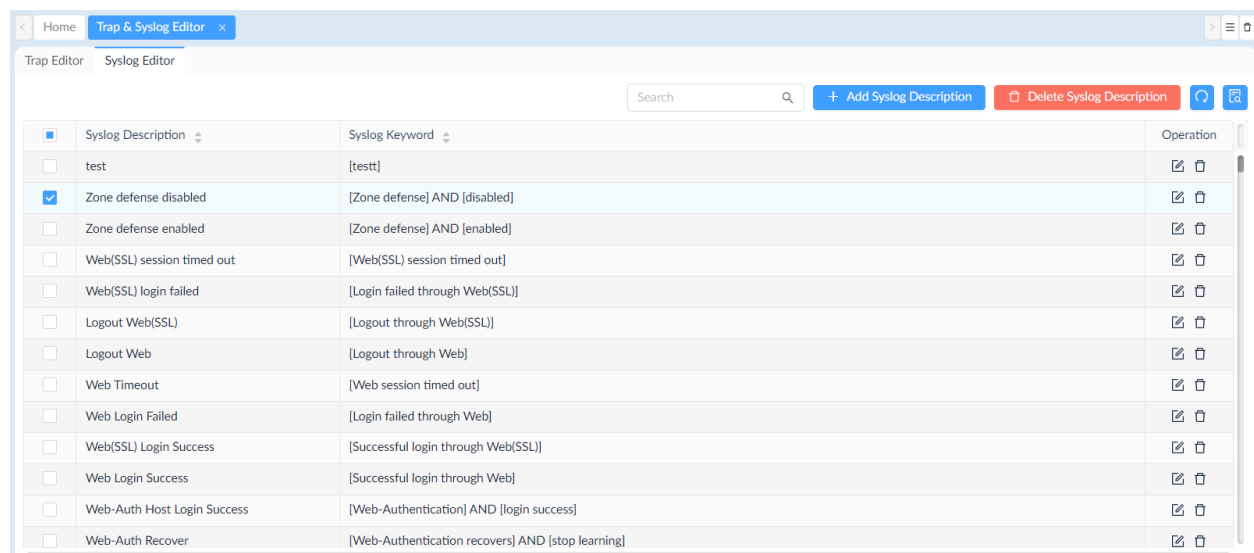

2. Click the **Syslog Editor** tab. You can perform the following operations on the list of Syslog Description:

Item	Description
Search	Enter a keyword to search for a log description entry using syslog description or syslog keyword.
Add Syslog Description	Add a syslog description representing selected log keywords to be displayed as highlight text to signify a condition or operation from log messages. Refer to 12.2.1 Add a Report for more information.
Delete Syslog Description	Click to delete a syslog description entry.
Refresh	Click to refresh the table listing.
Advanced Query	Click to perform advanced search. Enter the criteria to filter the table.
Edit	Click Edit to modify a syslog description.
Delete	Click to delete a syslog description.

You can also configure alarm rules based on the severity of Syslog. In addition, you can set the system to alert you that certain types of messages with matching content have been logged. Refer to [7.5 Monitor and Alarms](#) for more information.

7.5. Monitor and Alarms

7.5.1 Alarm Settings

You can manage monitor and alarm settings and configure conditions to trigger alarms. Alarms can be triggered by CPU or memory utilization and a wide range of system metrics. They can be configured by users or by the system as the defaults.

To view all configured alarms:

1. Go to **Alarm & Notification > Monitor & Alarm Settings**.
2. Click the **Alarm Settings** tab.

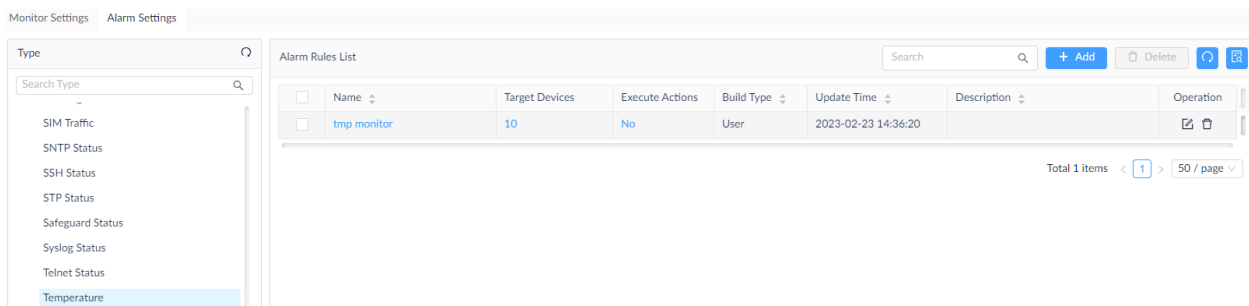

The following system-built categories of device status can be configured for an alarm:

Category	Item	Description
Monitor	Wired Traffic	Alert based on Rx/Tx traffic, error rate, discard rate, and bandwidth utilization
	Authenticated Clients	Alert based on Rx/Tx speed of authenticated clients and client number
	CPU Utilization	Alert based on CPU utilization
	DHCP Server Status	Alert based on DHCP status
	Device Common Information	Alert based on firmware version, hardware version, MAC address, serial number, or total flash capacity.
	Fan	Alert based on fan status or speed
	HTTP Status	Alert based on HTTP status or port number.
	HTTPS Status	Alert based on HTTPS status
	Installed Apps	Alert based on the number of installed apps.
	LACP	Alert based on LACP state
	LLDP	Alert based on LLDP status
	Managed AP WLAN Traffic (packet)	Alert based on WLAN Rx or Tx traffic
	Memory Utilization	Alert based on memory utilization

	Power Status	Alert based on power status
	Private Port	Alert based on the port details of D-Link switches using the private MIB.
	RMON Status	Alert based on RMON status
	Response Time	Alert based on response time (a system-default alarm)
	Running Software	Alert based on the software running on hosts
	SIM Traffic	Alert based on the upload and download traffic on the SIM card
	SNTP Status	Alert based on the SNTP status
	SSH Status	Alert based on the SSH version, status, maximum authentication failed attempts, session key rekeying times, maximum session, connection timeout, or port number
	STP Status	Alert based on STP status
	Safeguard Status	Alert based on Safeguard status
	Syslog Status	Alert based on Syslog status
	Telnet Status	Alert based on telnet status and port
	Temperature	Alert based on the temperature indicators and measurements
	Trap Status	Alert based on the trap status
	Wireless Access Points (number)	Alert based on the number of standalone AP, managed AP, total AP, or rogue AP
	Wireless Error Packets	Alert based on the number of Rx or Tx error packets transmitted wirelessly
	Wireless Traffic (bit)	Alert based on the Rx or Tx traffic (bps)
	Wireless Traffic (packet)	Alert based on the Rx or Tx traffic (pps)
Trap	Cold Start	Alert based on a device coldStart trap
	Warm Start	Alert based on a device warmStart trap
	Link Down	Alert based on a port linkDown trap
	Link Up	Alert based on a linkUp trap
	Authentication Failure	Alert based on an SNMP authentication failure trap
	EGP Neighbor Loss	Alert based on an EGP Neighbor Loss trap
	Enterprise Specific	Alert based on an enterprise-specific trap
Syslog	Syslog	Alert based on a syslog message with matching content
sFlow	sFlow traffic	Alert based on an sFlow traffic packet

From the Alarm Settings menu, you can set rules for different monitor categories or traffic and message types such as Trap, Syslog, and sFlow.

To add an alarm rule:

1. Go to **Alarm & Notification > Monitor & Alarm Settings**. Then select the **Alarm Settings** tab.
2. From the left pane, select a system-defined monitor category (or a customized monitor category) for configuration.
3. Click **+Add** to configure a rule.

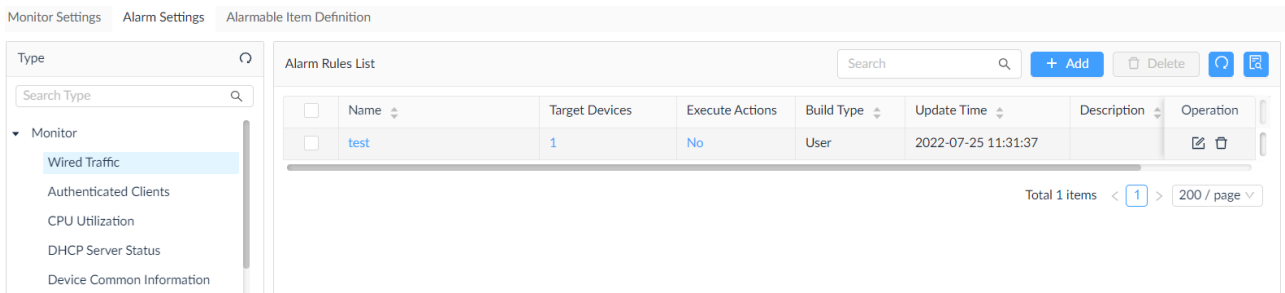

The **Add Alarm Rule** page displays.

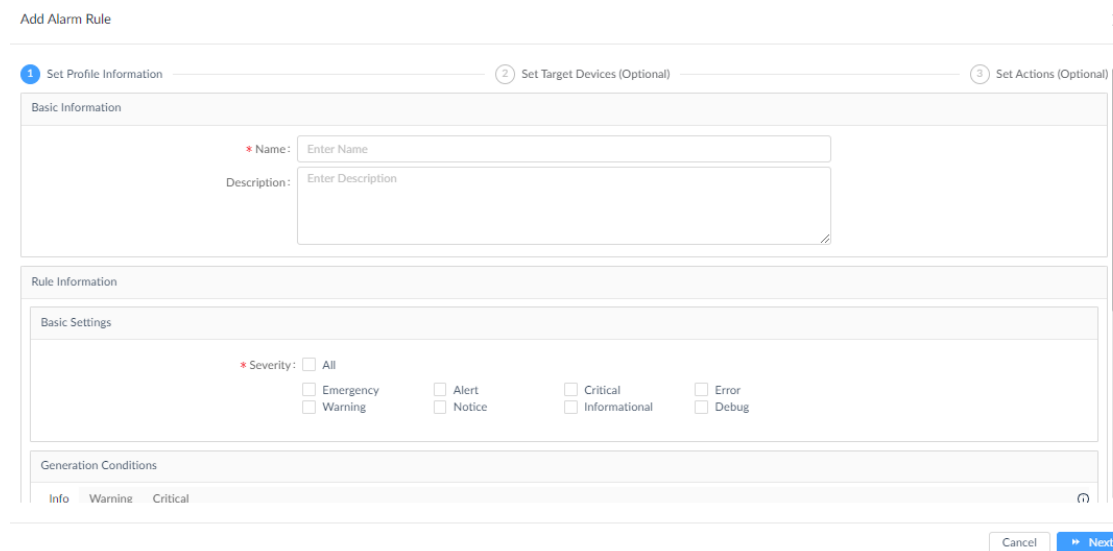

Different rules require different configurations that may involve traffic rate or utilization percentage as well as traffic direction. The following general settings are presented for all alarm rule types:

- Set profile information: enter a name and description for the alarm rule.
- Set alarm generation conditions: set the threshold value for different levels of severity for the alarm: Info, Warning, and Critical. The parameters for settings the threshold value depend on the monitored condition types.
- Set alarm release conditions: set the threshold value for clearing the alarm.
- Set target device/source: set the devices and device interfaces (for the **Wired Traffic** monitoring condition) to be monitored.
- Set alarm criteria (only applicable to the sFlow alarm category): set criteria (e.g. application, DSCP value, IP address, or protocol) along with sFlow interfaces and direction to be monitored.
- Add Inhibition Schedule Settings: select a pre-defined schedule or click **Add Schedule** to add a new schedule. The Schedule prohibits delivery of alarms at the specified time range of a designated weekday or weekdays for the effective duration of dates.
- Set Actions (optional): execute a script. The script can be executed on designated device(s) other than the device configured as the alarm source or on the selected D-View 8 servers. Click **Add actions** at the upper right and click the respective Device or Server Command tab. To execute commands on device(s), configure the credentials and method for logging in to the devices.

Click **Next** or **OK** to continue the rule configuration. Then click **Save** to create the rule and exit the screen.

Note: After an alarm has been configured for the selected devices, you can activate the alarm on a per-device or per-port basis (for the **Wired Traffic** monitoring condition) . Go to **Monitoring > Device View** and click the

System Name link to go to the **Device Information** page. Then select the **Port** or **Alarm** tab to access the port list or alarm settings page. For Port list, you can turn on or off the Alarm Switch for each port. For Alarm settings, turn on or off a specific alarm type.

7.5.2 Monitor Settings

Network monitoring is performed through the Monitor and Alarm settings menu. You can select a specific monitor category to view available configuration settings.

To obtain monitoring conditions:

1. Go to **Alarm & Notification > Monitor & Alarm Settings**.
2. Click the **Monitor Settings** tab.
3. Click a monitor category to view all monitoring settings in that category.

To edit a monitoring condition:

Select a device or multiple devices and adjust the monitoring interval by clicking **Edit Interval**. Depending on the monitored condition, you may edit monitor status or port numbers if they are applicable.

To apply ports settings:

Select a device or multiple devices, click **Batch Select Port** and enter the port range (e.g. 1,3-8,10), and click **Apply**. Then click **Edit Monitoring Status** to enable or disable monitoring on the designated ports.

To stop monitoring:

Select a device or multiple devices and adjust the monitoring status by clicking **Edit Monitoring Status**. Then click ON or OFF to enable or disable monitoring.

Note: Stopping a monitoring condition will cause the associated alarms to be disabled automatically.

7.6. Manage Notifications

The Notification Center displays the notification rules. It allows you to configure rules of trigger conditions and notification recipients and set schedules for notification activation.

To set a notification rule:

1. Go to **Alarm & Notification > Notification Center**.

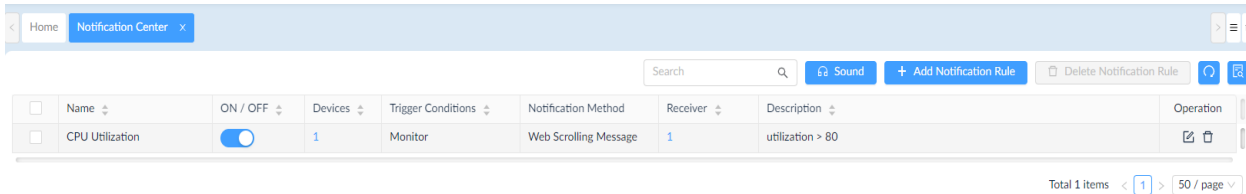

The Notification Center page displays.

The list contains the following information on rule and display control:

Item	Description
Search	Enter a keyword to search for a specific notification name.
Sound	Click to customize a ringtone to sound when a notification is triggered. Different alarm levels can be configure with different built-in ringtones.
Add Notification Rule	Click to define a notification rule.
Delete Notification Rule	Click to remove the notification rule.
Refresh	Click to refresh the table.
Advanced Query	Click to configure an advanced search job. Select the criteria to filter the list: Name, On/Off status, Trigger Conditions, or Notification Method.
Name	The name of the notification rule.
On/OFF	Enable or disable the notification.
Devices	The number of devices to which the rule applies.
Trigger Conditions	The monitored condition type (i.e. monitor, trap, syslog, or wired traffic) to trigger a notification.
Notification Method	The method of notification for the rule (i.e. web scrolling message, email, or execute script).
Receiver	The number of notification recipients. Click on it to display user profile as the recipient of the notification.
Description	A description of the rule.

1. Click **+ Add Notification Rule** to configure a new rule.

The **Notification Management Details** page displays.

Notification Management Details

Basic Information

* Name:

Description:

ON / OFF: ON OFF

Source Devices + Add

System Name	IP	Network	Model Name	Operation
No Data				

Total 0 items < 0 > 200 / page

Trigger Conditions

* Condition Type: Monitor Please choose one or more

* Alarm Level: All Critical Warning Info

Cancel Save

2. Under **Basic Information**, enter a name and description to define the rule.
3. Click **ON/OFF** switch to enable or disable the rule.
4. In **Source Devices**, click **Add** to select target devices. The **Batch Select Devices** page displays.

Batch Select Devices

Resource Tree Search network

- Beijing
- USA
 - RD
- Tokyo
- Taipei
- London
- Paris

Device List Search

<input type="checkbox"/>	System Name	IP	Network	Model Name
<input checked="" type="checkbox"/>	D-Link	172.18.193.253	Marketing	DES-3226STK
<input type="checkbox"/>	N/A	172.18.193.237	Marketing	Other
<input type="checkbox"/>	N/A	172.18.193.235	Marketing	Other
<input type="checkbox"/>	N/A	172.18.193.234	Marketing	Other
<input checked="" type="checkbox"/>	ACC_SW_STAC...	172.18.193.230	Marketing	DES-3028
<input type="checkbox"/>	ACC_SW_DES_...	172.18.193.226	Marketing	DES-3026
<input type="checkbox"/>	LAB_Uni_SW_3...	172.18.193.212	Marketing	DGS-3120-24TC
<input type="checkbox"/>	MAIN_AC1	172.18.193.209	Marketing	DWS-3160-24PC
<input type="checkbox"/>	4433	172.18.193.204	Marketing	DAP-2680
<input type="checkbox"/>	SASACK_SW_3...	172.18.193.199	Marketing	DES-3552
<input type="checkbox"/>	DLINK-WLAN-AP	172.18.193.184	Marketing	DWL-8500AP
<input type="checkbox"/>	N/A	172.18.193.163	Marketing	Other
<input type="checkbox"/>	N/A	172.18.193.161	Marketing	Other

Total 95 items < 1 2 3 4 5 6 7 > 15 / page Go to

Cancel OK

5. Click **OK** to confirm the selection and return to the previous screen.
6. Under the **Trigger Conditions**, click the **Condition Type** drop-down menu to select a trigger condition type.

Trigger Conditions

* Condition Type: Monitor LACP x Response Time x SSH Status x

* Alarm Level: All Critical Warning Info

The following table describes the condition types.

Item	Description
Condition Type	
Monitor	<p>The monitor categories vary depending on the selected device model.</p> <ul style="list-style-type: none"> • CPU Utilization • DHCP Server Status • Device Common Information • Fan • HTTP Status • LACP • LLDP • Memory Utilization • Power Status • Private Port • RMON Status • Response Time • SNMP Status • SSH Status • STP Status • Safeguard Status • Syslog Status • Telnet Status • Temperature • Trap Status • Authenticated Clients • Wireless Traffic • Wireless Error Packets
Trap	<p>Select the corresponding severity level to generate a notification for the configured alarms based on Trap:</p> <ul style="list-style-type: none"> • All: all severity level of alarms will generate a notification. • Critical: critical level of alarms will generate a notification. • Warning: warning level of alarms will generate a notification. • Info: informational level of alarms will generate a notification.
Syslog	<p>Select the corresponding severity level to generate a notification for configured alarms based on Syslog:</p> <ul style="list-style-type: none"> • All: all severity level of alarms will generate a notification. • Critical: critical level of alarms will generate a notification. • Warning: warning level of alarms will generate a notification. • Info: informational level of alarms will generate a notification.
Wired Traffic	<p>Select the corresponding severity level to generate a notification for configured alarms based on Wired Traffic:</p> <ul style="list-style-type: none"> • All: all severity level of alarms will generate a notification. • Critical: critical level of alarms will generate a notification. • Warning: warning level of alarms will generate a notification. • Info: informational level of alarms will generate a notification. <p>For Wired Traffic, select the ports that will be monitored for notification rules. Note that the monitored ports must also be the ports configured in the corresponding alarm rules for the notification to take effect.</p> <p>Note that there must be an alarm set with the corresponding severity level for the notification to take effect.</p>

7. Under **Notification Details**, select the Notification Method.

Item	Description
Notification Method	
Web Scrolling Message	Notifications will appear as toast messages when you are logged in to the D-View 8 web application. Select the Screen Scrolling Setting for the alert: Mute sound or Enable Voice.
Email	Select this option to receive notifications by email. See below steps to add notification receiving administrators.
Execute script	<p>In the Command Line, enter the script to execute.</p> <p>Notes:</p> <ol style="list-style-type: none"> 1. Lines begin with a '#' will be considered as comments and will not be considered as commands. 2. Use '%' before and after the word to label it as a variable. Example: %IP%. 3. The variables' value can be set in the 'Device Attribute' table. 4. Each line must contain no more than one CLI command. 5. Avoid endless CLI commands to prevent deadlock operation. Example: ping 10.0.0.1. 6. Avoid CLI commands that may require special inputs to exit to prevent deadlock operation. Example: show ports. <p>Sample script:</p> <pre>config ssh authmode password enable config ssh server contimeout 120 enable SSH</pre> <p>Sample script with variables:</p> <pre>config fdb aging_time %TimeoutSeconds%</pre> <p>Sample comments:</p> <pre># this is a comment</pre> <p>You can choose to execute a script the source devices (Itself) or devices other than the source devices (Other Devices) when a notification is generated.</p> <p>To execute a script, config the username and password and protocol to log in to the selected devices to which the script will apply.</p> <ul style="list-style-type: none"> • The Acknowledge Alarm after Script Execution parameter can be used to terminate the repetitive execution of the script. For each execution of the script, the alarm will be automatically acknowledged. Enter the total Number of Repetitions (1-100) and Cycle Time (5-1440) minutes. The automatic script execution will stop when the maximum number of repetitions has been reached in the defined cycle time.

8. Under the **Notification Receiving Administrator**, click **Add** to specify users who will receive notifications.
9. The **Select User** page displays. Select administrators to receive notifications from the list or enter criteria (email, username, or user role) to search for a user.

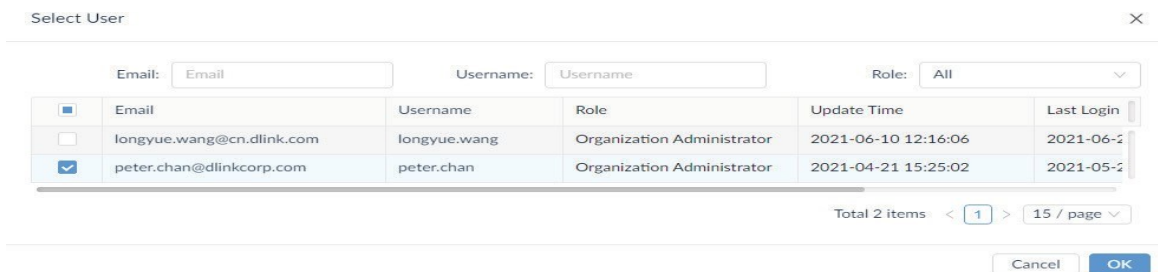

10. Click **OK** to add users to the rule or **Cancel** to return to the previous page.
11. Under **Notification Suspension Period**, click **Add Schedule** to add a new schedule or select a pre-defined schedule whereby notification rule will be inactive. You can add a schedule for a specified time range of a designated weekday or weekdays for the effective duration of dates.
12. Click **Save** to accept the notification rule. Click **Cancel** to return to the previous screen.

After a notification rule is created, you can edit or delete it with the edit and delete functions under **Operation**.

8 Network Architecture

You can view network architecture through hierarchical maps. The following topics are covered in this section:

- View and Manage Network Topology
- Create a Topology View

Note: Please configure the managed devices to **enable LLDP globally in advance** to allow D-View 8 to obtain physical topology information on all devices.



8.1. View and Manage Network Topology

Locating devices within the network can be accomplished through a hierarchical map. Additional information such as device information and status and related performance statistics can also be obtained from the map.

Note: When the license expires, the **Topology Map** page alert you that the system is running under a restriction on the number of nodes with full functionality and encourage you to renew your annual maintenance. To add maintenance licenses, refer to [14.3 Licenses](#).

1. Go to **Monitoring > Topology Map**.
2. Click **Select Topology** to select the network diagram. The System Topology is built automatically whereas the Customized Topology is created by users.

The Topology Map page displays.

Item	Description
Select Topology	Click to open the System Topology or Customized Topology library. Or you can use the Search function to search available maps by entering a keyword.
Create Customized Topology	Create a customized diagram with respect to organization, site, or network.
Toolbar	 <p>Refresh: Refresh the screen display. Device List: Displays the Device View menu for the selected topology. Link List: Displays the Connection View page with the connecting interfaces. Network Overview: (1) Displays the distribution of the devices with respect to model, device type and status. (2) Displays the distribution of the devices with respect to bandwidth and status. Export: Save the map as a PNG file to your local drive. Topology Settings: Change the current topology's information settings and layout style. Also select the information to be displayed alongside the devices. Rediscover: Scan the devices on the map to update the link information. Display Settings/Current Topology Setting: Control what should be displayed for the nodes and links on the map. Control the topology layout and central device. Link Edit: Enable or disable the link editing function. Enable this option and right-click on a link on the map to edit or delete it. Or you can right-click on a node to delete it. Disable this option to create link lines on the map. Add Background: Add a background image to the map. Save: Save the current topology map.</p>
Search	Click to search specific devices.
Control Bar	

	<p>The following is a description of the control bar icons from left to right.</p> <ul style="list-style-type: none"> Zoom in Zoom out Focus on central node Zoom fit
Help	<p>Help menu provides the following operation guidance:</p> <ul style="list-style-type: none"> Topological Legend: the state/status, device type, and bandwidth representation explanation Link Operation: select a link to edit or delete Batch Select Nodes: select multiple nodes

3. From the Topology Map, select a device. When selected, the device will be highlighted.

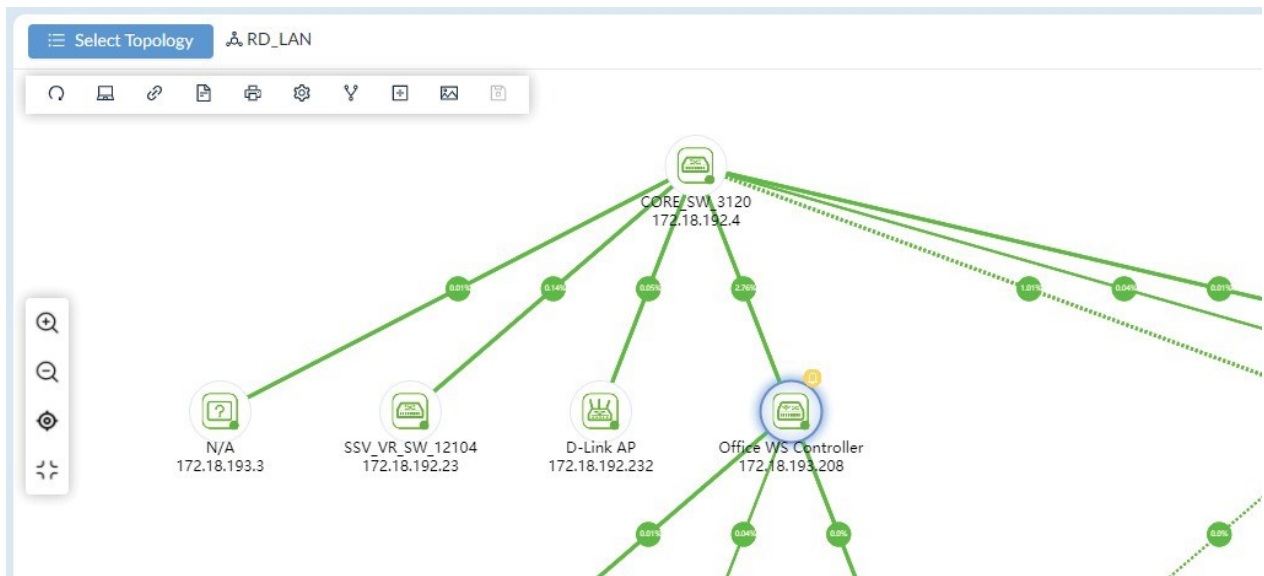

4. Click on a device to display the device's information page in Link Edit mode ().

The screenshot shows the 'Device Information' page for the 'Office WS Controller'. The page is displayed in a modal window over the topology map. The information shown is as follows:

- Name:** Office WS Controller
- Status:** Online
- Network:** Lab
- IP:** 172.18.193.208
- MAC:** 14:D6:4D:60:E6:60
- Type:** Wireless Switch
- Model Name:** DWS-3160-24PC

Below the main information, there are expandable sections for 'Recent 3 Active Alarms', 'Performance', and 'Related Devices'.

5. The Information page provides the following information:

- Device Information: Name, Status, Network, IP Address, MAC Address, Type of the device, and Model Name.
- Recent 3 Active Alarms
- Performance: CPU utilization, availability, and memory utilization
- Related Devices: Connected devices' information
- Related Topology: Other topology from connected devices
- To modify device information, click the Device Name link to open the **Device Information** page.

6. To view details for a link, click on a link to display the Link Information page in Link Edit mode ().

Device: DXS-3610-54S(192.168.110.110) N/A(192.168.110.118)	
Link Type: Multiple	Number of links: 2
> Link Port	
> Link Alarm	

7. The Information page provides the following:

- Link Information: devices that establish the link with link type and number of links
- Link Port: linked ports of the device, bandwidth, utilization and Rx/Tx rate
- Link Alarm: alarms generated for this link activity
- To edit a link, right-click on a link and click **Edit Link**. You can modify the type of link (Normal, LACP, or logical) and the ports of the link. Normal link uses wires and cables for physical data flow whereas logical link shows data flow regardless of the physical connections among the devices in the network. For LACP link, check the Device Information page for LACP support and configuration.

8. You can also use the navigation window at the lower right to focus an area on the map.

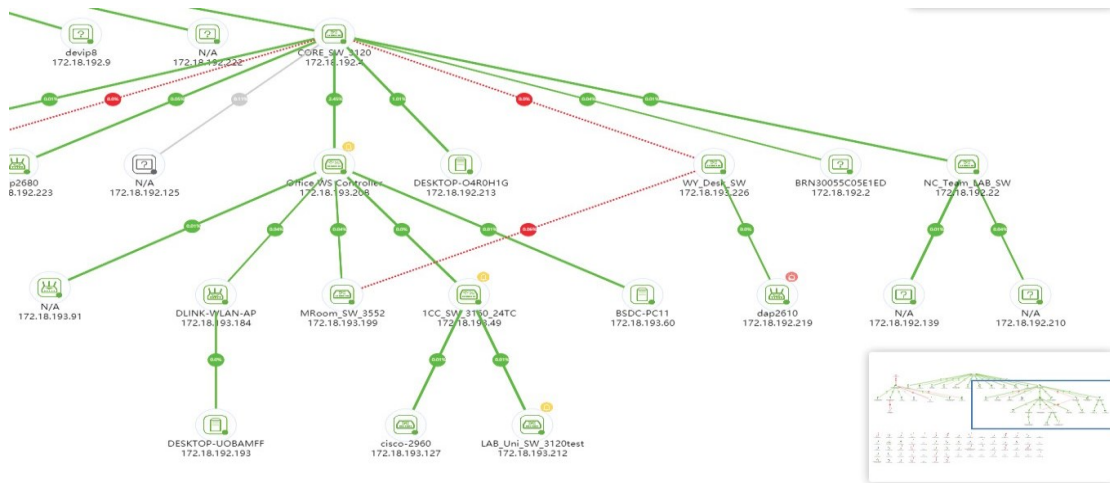

8.2. Create a Topology View

In addition to system-built topologies, you can create your own topology within a network hierarchy.

1. Go to **Monitoring > Topology Map**. The Topology Map page displays.

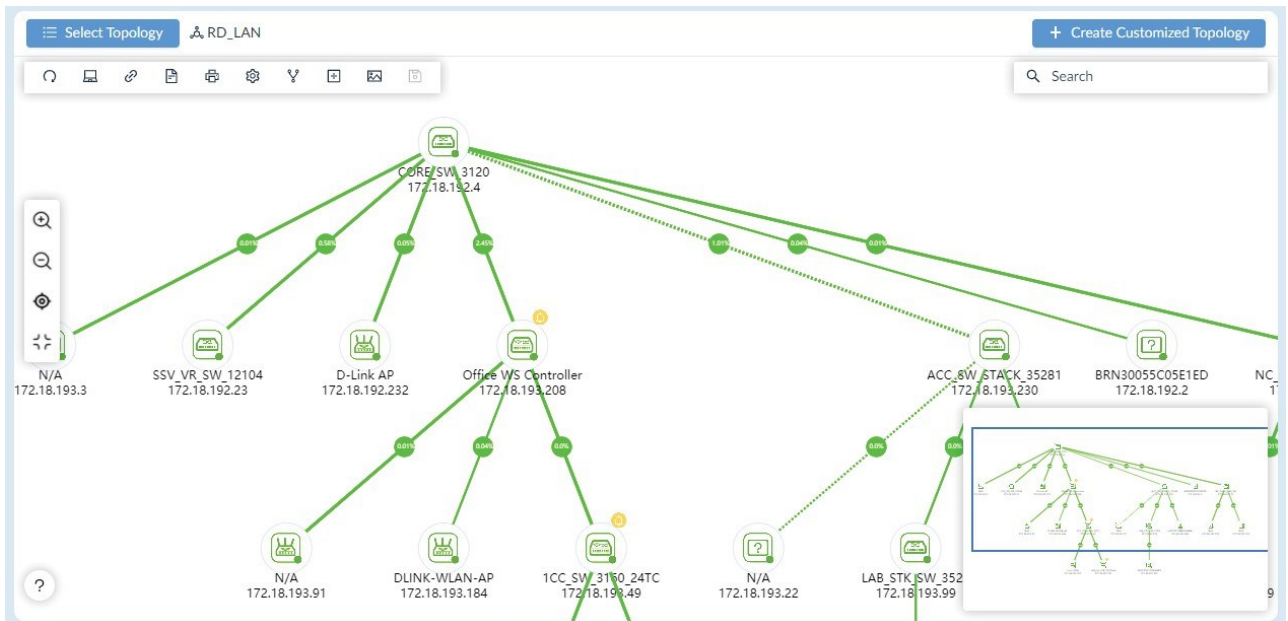

2. Click **Create Customized Topology** at the upper right. The Create Customized Topology page displays.

Create Customized Topology

1 Choose Device 2 Choose Associated Device 3 Topology Information

Topology Level: Organization Site Network

Range: All Devices

Generation Method: Automatic: Select a device and set the number of hops to generate a topology. Manual: Generate a topology for the selected devices.

	Status	System Name	IP	Model Name	Device Type	Network Name	Site
<input type="checkbox"/>	●	DHVNR3WEQSWDFV W	172.18.192.129	WindowsWorkstation	Host	Beijing_Marketing	CS
<input type="checkbox"/>	●	DESKTOP-TMR5E73	172.18.192.146	WindowsWorkstation	Host	Beijing_Marketing	CS
<input type="checkbox"/>	●	MR-MateBookX	172.18.192.135	WindowsWorkstation	Host	Beijing_Marketing	CS
<input type="checkbox"/>	●	LAPTOP-FMRE1AMM	172.18.192.184	WindowsWorkstation	Host	Beijing_Marketing	CS
<input type="checkbox"/>	●	WIN-S823G9M9LGR	172.18.193.51	WindowsServer	Host	Beijing_Marketing	CS
<input type="checkbox"/>	●	localhost	172.18.192.6	Other	Other	Beijing_Marketing	CS
<input type="checkbox"/>	●	BRN30055C05E1ED	172.18.192.2	Other	Other	Beijing_Marketing	CS
<input type="checkbox"/>	●	devip8	172.18.192.9	Other	Other	Beijing_Marketing	CS
<input type="checkbox"/>	●	Switc901tt	172.18.192.22	DES-3200-28	L2 FE Switch	Beijing_Marketing	CS
<input type="checkbox"/>	●	N/A	172.18.192.15	DGS-1210-10	L2 GE Switch	Beijing_Marketing	CS
<input type="checkbox"/>	●	dgs-1210	172.18.192.23	DGS-1210-24	L2 GE Switch	Beijing_Marketing	CS

Search for devices

Next

3. Select the Topology Level to choose devices from: Organization, Site, or Network.
4. Select the method to generate the diagram.

Automatic (default): select a device and set the number of hops to generate the topology.

Manual: generate a topology for the selected devices.

5. For manual, select device(s) to be included in the topology architecture. Or you can search for specific device(s) by entering a keyword in the search field.

6. Click **Next** to proceed.

The **Choose Associated Device** page displays if you selected **Automatic**.

Create Customized Topology ×

Choose Device 2 Choose Associated Device 3 Topology Information



Hops of central device:

System Name	IP	Model Name	Device Type	Network Name	Site
BRN30055C05E1ED	172.18.192.2	Other	Other	Beijing_Marketing	CS

Total 1 items < 1 > 15 / page

← Previous
Next →

7. Click the **Hops of central device** drop-down menu to define the number of hops or devices (2 to 10) of a single link from the central device down to add additional devices in the diagram. This is only available if the Automatic method is selected above.
8. Click **Next** to continue or click **Previous** to return to the previous menu. The **Topology Information** page displays.
9. In the Name field, enter a name for the topology map.
10. In the Description field, enter a description to identify the map.
11. In **Data source of links**, select either **Synchronization with system** or **User-defined** to specify whether the data will be dynamically updated with the system. The user-defined type will not update dynamically with the system when there is any topological change with the nodes and links in the system.
12. Select the type of layout for the map: Star, Tree, Circular, or Grid.
13. Enable or disable sharing of the topology with other administrators so they may also view or modify it.
14. Enable or disable the **Auto** button to control the selection mode of the central device for display as the central device in the topology. ON indicates the system will specify the central device automatically. (The system will select the device having the greatest number of links as the central device.) If OFF is selected, choose a central device manually.
15. Select a central device if you disable the above Auto option.
16. Click **Save** to create the topology map. Click **Previous** to return to the previous menu.

You can modify the information of a customized topology or delete a customized topology. Click **Select Topology** at the upper left, select **Customized Topology**, select the desired topology, then click **Edit**  or **Delete** .

9 Rack Groups and Devices

In heterogeneous networks with lots of different types of devices, organizing device placement is essential and may take a lot of time. This Rack View function assists in viewing and managing such placement at the deployment site.

9.1. Add a Rack Group

Racks are organized by groups. Creating a rack group is required for the subsequent rack and device management.

1. Go to **Monitoring > Rack View** to display the Group List page.

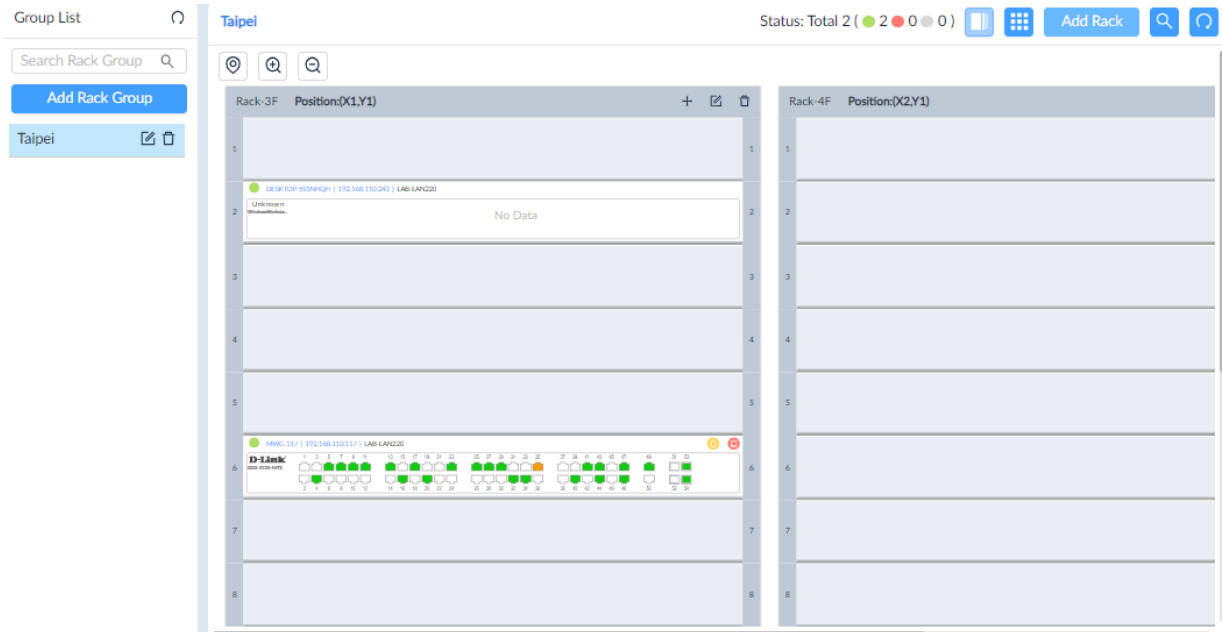

2. Click **Add Rack Group**.

The Add Rack Group page displays.

3. Enter a name and description for the group.
4. Click **Save** to create the group. Or click **Cancel** to return to the previous screen.
5. The group rack page appears. Click **Add Rack** to add more racks to the group. The **Add Rack** page displays.

6. Enter a name to identify this new rack display.
7. Enter the units, a unit of 1 equals 1 device slot space (range: 1 to 999).
8. Enter a description to better identify the rack.
9. Click **Save** to create the rack or click **Cancel** to return to the previous menu. The **Create Rack** page displays.

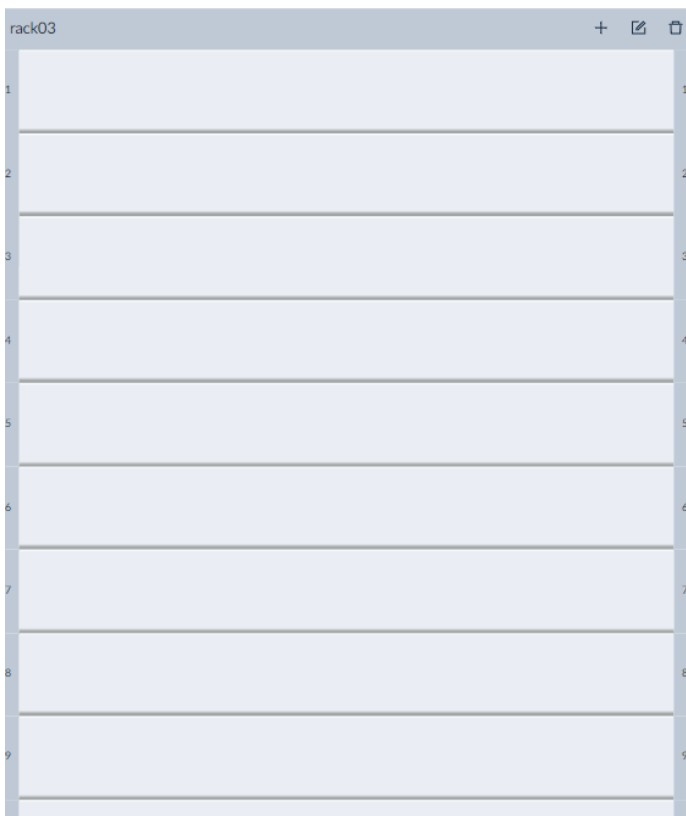

10. Click on a slot to add a device. The Available Devices page displays.
11. Select a device to insert into the slot.
12. Click **Save**.

The selected device is now inserted into the rack location.

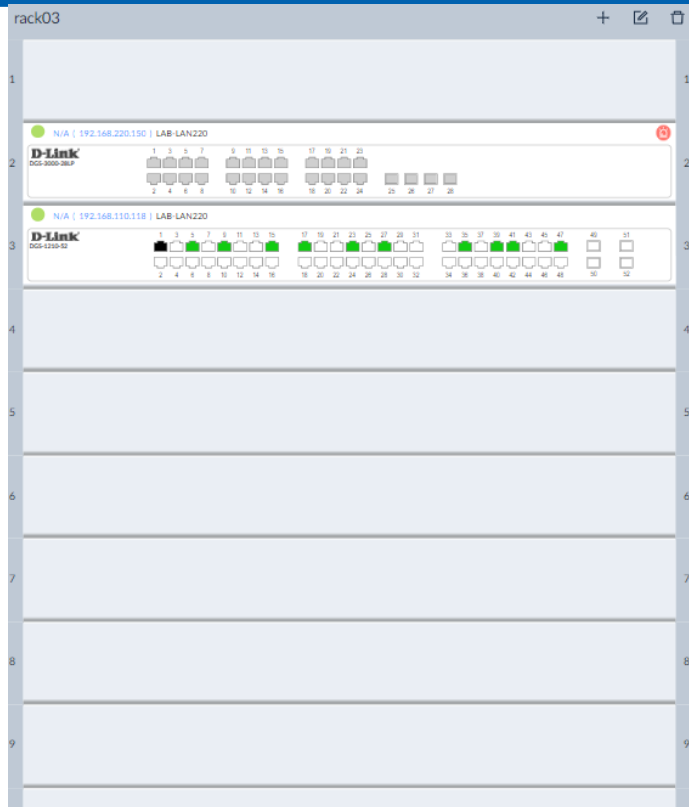

The Rack Group page also offers controls for different views of the rack display:

To adjust the level of the detail on the rack group page:

- Default: click to set the viewing ratio to default
- Zoom in: click to zoom in the viewing area
- Zoom out: click to zoom out the viewing area
- Arrange the racks of a rack group on the group page

To arrange the racks of a rack group on the group page:

Click and hold anywhere on a rack and drag it to a new location.

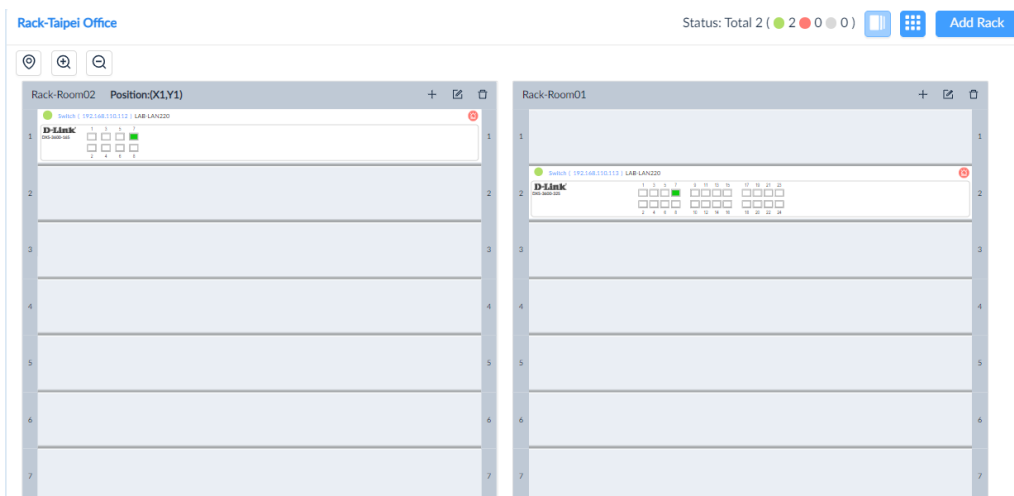

9.2. View and Modify a Rack Group

You can modify and delete existing rack groups.

To modify an existing rack group:

1. Go to **Monitoring > Rack View**.
2. The Group List page displays.
3. Select a rack group.

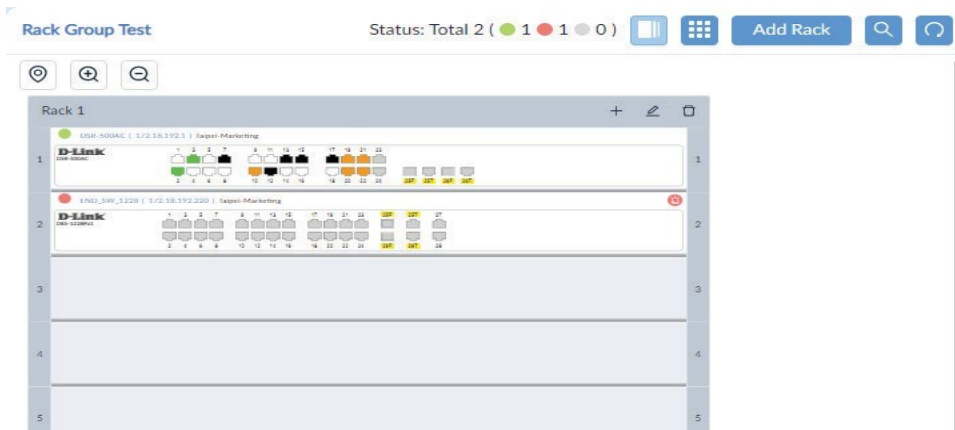

4. To edit the group settings, click **Edit**  in the Group List column.

The Edit Rack Group page displays.

Edit Rack Group
✕

* Name:

Description:

5. To delete the group, click on the **Delete** button in the Group List column. A confirmation pop-up displays.
6. Click **Yes** to confirm.



NOTE: Deleting a rack group will delete all racks in the rack group at the same time.

Likewise, you can modify the racks of a rack group. Refer to the below section.

View and Modify a Rack

You can modify and delete an existing rack(s) from a group.

To modify an existing rack:

1. Go to **Monitoring > Rack View** to display the Group List page. Select an existing group to view the racks of the group.
2. At the top right of a rack display, click **Edit Rack**  to modify the rack information.

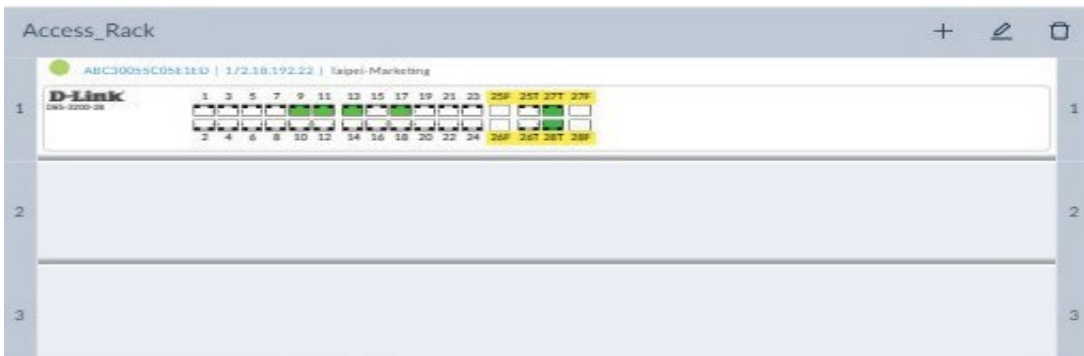

The Edit Rack page displays:

Edit Rack
X

* Name:

* Unit(s): (Range: 1-999)

Description:

3. Click **Save** to accept the new information.

You can also click **Delete** to remove the rack from the group. A confirmation pop-up displays.

Click **Yes** to confirm the deletion.



NOTE: Deleting a rack will delete all devices in the rack at the same time.

Place a Device on a Rack

You can view and change the location of a device on a rack simply by dragging and dropping it to a new slot on the rack. To view an existing device:

1. Go to **Monitoring > Rack View** to display the Group List page.
2. Select an existing group to view the racks of the group.



3. From the rack view, click on a device. The View and Delete icons appear.



4. Click **View** to display the device **Panel Detail** page.

The following is an example of a D-Link DGS-3120 device.

Panel Detail
✕

System Name: **DGS-3120-24-16100** IP: **2.0.0.12** Device Hierarchy: site_sim/Shanghai_Finance

D-Link DWS-3160-24TC

RJ45 10M/100M/1000M 1000M

Active Port

Port	Connect to Port	RX (bps)	TX (bps)	RX (pps)	TX (pps)	Bandwidth
1/1	N/A	0	0	0	0	1000M
1/3	N/A	0	0	0	0	1000M
1/5	N/A	0	0	0	0	1000M
1/7	N/A	0	0	0	0	1000M
1/9	N/A	0	0	0	0	1000M

Total 24 items < 1 > 100 / page

5. Mouse over any of the connected (green) ports to view port details.

Port 1/17

Connect to Port	PC-20210314SZMD(172.18.192.117)-N/A
RX	11.57Kbps/10.2pps
TX	59.68Kbps/22.05pps
Port Type	RJ45 10M/100M
Bandwidth	100M

System Hierarchy: Taipei/Marketing

Port	Connect to Port	RX (bps)	TX (bps)	RX (pps)	TX (pps)	Bandwidth
1/1	DGS-3120-24TC(172.18.192.4)-1/24	0	0	0	0	100M
1/5	ACC_SW_STACK_3528(172.18.193....	0	0	0	0	100M
1/7	N/A(172.18.192.217)-N/A	582.74K	256.87K	70.28	88.11	100M

6. Click on the **IP address** to open the device management interface through one of the following protocols: HTTP, HTTPS, Telnet, or SSH.
7. Click on the **System Name** to open the device's information page.

MWC-117(192.168.110.117)

Summary | Port | Monitor | Monitor Views | Alarm | Trap & Syslog | Management

Device Information

Status: ● Online

IP: [192.168.110.117](#)

Site: LAB

Stack Status: No

Model Name: DGS-3130-54T5

Hardware Version: B1

Total Flash: 90.0MB

System Location:

System Uptime: 77 days, 12 hours, 27 minutes, 6 seconds

Description: D-Link DGS-3130-54T5 System - 48*10/100/1000M + 2*10GBase-T + 4*10G SFP+, 145.2.00.20

Vendor: D-Link

MAC: 0C:0E:76:8B:8B:81

Network: LAN220

Stack Unit: 1

Device Type: L3 GE Switch

Firmware Version: 2.00.020

System Name: MWC-117

System Contact:

System OID: 1.3.6.1.4.1.171.10.154.4.2

Performance Information

CPU Utilization: 42%

Memory Utilization: 36%

Online (Availability) ● Online ● Offline ● Unstable ● Unknown

For more information on the Device Information page, refer to [4.2.2 Modify Device Information](#).
[Modify Device Information](#)

10 sFlow Monitoring

sFlow is only supported in the Enterprise version. The sFlow monitoring technology is designed for high-speed switched networks to aid in network usage visibility. The sFlow agent sends data to D-View 8 and it enables network administrators to monitor and analyze traffic effectively in the following areas:

- Detailed real-time bandwidth usage with respect to applications, protocols, and source and destination addresses
- Traffic flow for all ports
- Issues and abnormal traffic
- Traffic identified as a potential security threats
- Performance optimization information
- Billing and accounting

The sFlow function provides continuous monitoring as well as network performance reporting.

This section includes the following functions for sFlow management:

- Configure sFlow Monitor
- Manage sFlow Monitor
- View and Export sFlow Monitoring Results
- Configure sFlow in Supported Devices

10.1. Configure sFlow Monitor

To configure the sFlow Monitor on an sFlow-enabled device:

1. Go to **Monitoring > Device View**. In the Device View page, click the **Managed** tab and select sFlow from the Switch-All drop-down menu.

	Alarm	System Name	IP	Network	MAC	Model Name	CPU Utilization
<input type="checkbox"/>		BRN30055C05E1ED	172.18.192.2	Marketing	30:05:5C:05:E1:ED	test	
<input type="checkbox"/>		CORE_SW_3120	172.18.192.4	Marketing	34:08:04:C4:F7:EF	DGS-3120-24TC	23%
<input type="checkbox"/>		ABC30055C05E1ED	172.18.192.22	Marketing	00:1E:58:6E:A6:E0	DES-3200-28	21%

The Switch-sFlow devices table displays.

	Status	Alarm	System Name	IP	Network	MAC	Model Name	sFlow V
+			CORE_SW_3120	172.18.192.4	Marketing	34:08:04:C4:F7:EF	DGS-3120-24TC	5.00
+			1CC_SW_3160_24	172.18.193.49	Marketing	14:D6:4D:5E:37:F0	DWS-3160-24TC	V5
+			MAIN_AC1	172.18.193.209	Marketing	14:D6:4D:60:E6:60	DWS-3160-24PC	V5
+			LAB_Uni_SW_3120test	172.18.193.212	Marketing	34:08:04:C4:F7:D6	DGS-3120-24TC	

Total 4 items < 1 > 15 / page

2. Select a desired device by clicking on the System Name link. The Device Information page displays. Click the **Management** tab to view the device's sFlow settings.

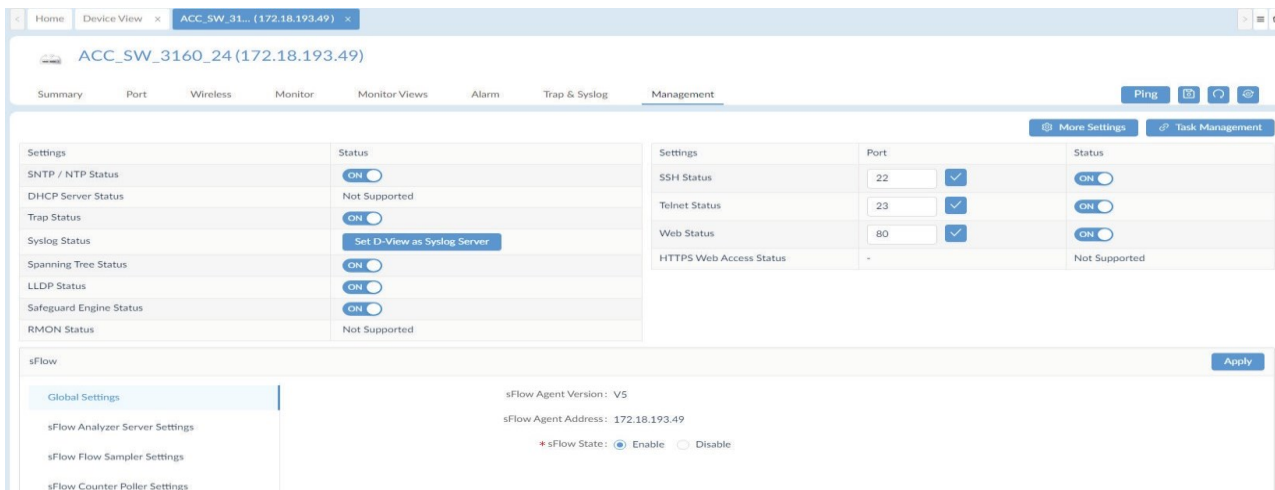

- In the sFlow section, select the **Global Settings** tab.
- Find the sFlow State control and select **Enable** to set the sFlow function.

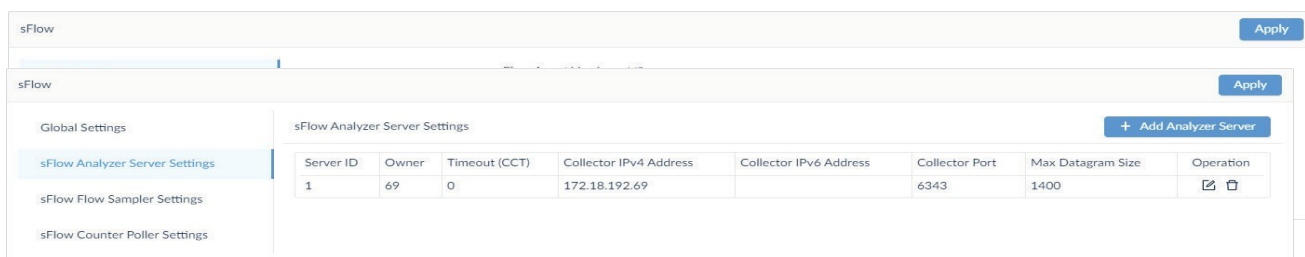

- In the sFlow section, click **sFlow Analyzer Server Settings**. The sFlow Analyzer Server Settings are displayed in the window.

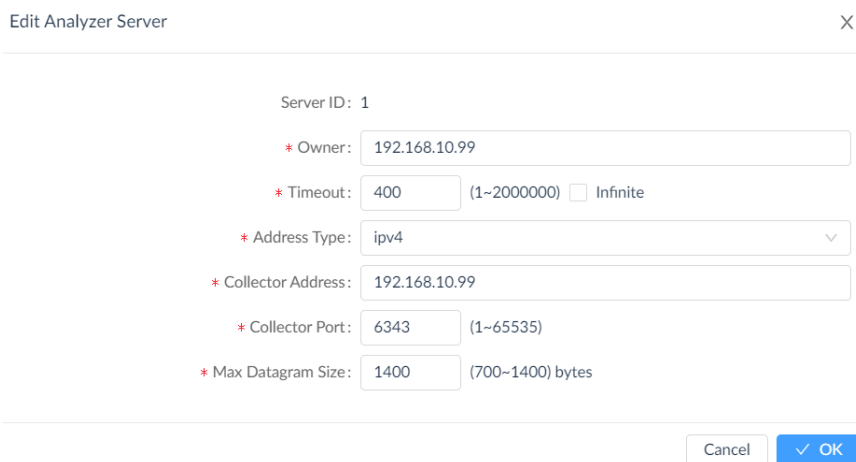

- Click **+Add Analyzer Server** to display the Add Analyzer Server page.

Item	Description
Server ID	Click the indicator to assign an ID to the entry (1 – 4).
Owner	Enter the analyzer name for the device to send the sFlow data to. In general, this setting points to the D-View 8 probe server.
Timeout	Enter the collector timeout (1 ~ 2000000) value that will keep the collector settings valid. Alternatively, click Infinite to disable the timeout setting.
Address Type	Click the drop-down menu to define the IPv4 or IPv6 address type.
Collector IPv4/IPv6 Address	Enter the collector IP address for data collection. In general, this setting points to the D-View 8 probe server IP address.
Collector Port	Enter the port number of the above collector address (1-65535).

Max Datagram Size	Enter the maximum datagram size for the data packet in bytes (300 – 1400).
Cancel	Click Cancel to return to the previous menu without saving the settings.
OK	Click OK to create the sFlow setting.

- Click **sFlow Flow Sampler Settings** to configure the flow packet sampling method.
- Click **+Add Flow Sampler Port**. The Add Flow Sampler Port page displays.

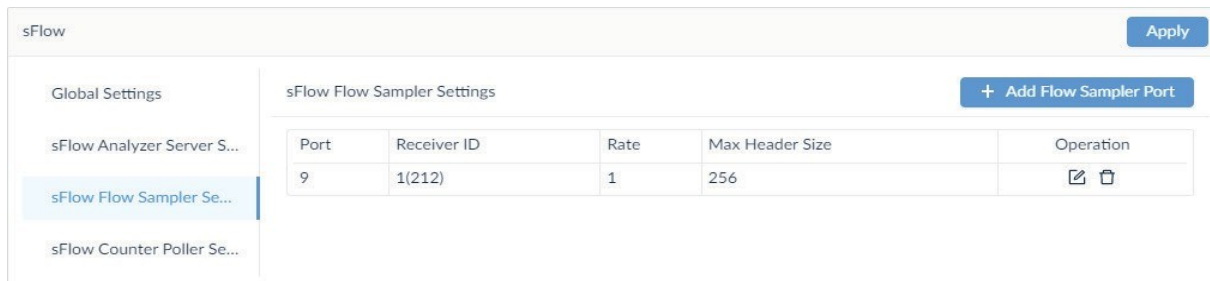

- Enter the following information.

Add Flow Sampler Port X

* Port: 1-52

* Receiver ID:

* RX Rate: (0-65535)

* TX Rate: (0-65535)

* Max Header Size: (18-256)

Item	Description
Port	Enter the port number on the device designated to send out sFlow data.
Instance	Enter an instance number for each sampling port.
Receiver ID	Click the drop-down menu to select a pre-configured analyzer server, see the previous step.
Mode	Select either inbound or outbound traffic.
Rate (RX/TX)	Enter the sampling rate (0-65536).
Max Header Size	Enter the maximum number of bytes (18- 256) to be copied from a sampled packet to an sFlow datagram.
Cancel	Click Cancel to return to the previous menu without saving the settings.
OK	Click OK to create sampler setting.
<p>Note: The settings vary depending on the sFlow support capabilities. Even if the settings relevant for sFlow communication can be configured from the D-View application, sFlow Analyzer is only supported in the Enterprise version (refer to 10.4 sFlow Network Monitor for instructions about sFlow Analyzer.)</p>	

- Click **sFlow Counter Poller Settings** to configure the counter sampling method.
- Click **+Add Counter Poller Port** at the upper right. The **Add Counter Poller Port** page displays.

Add Counter Poller Port

X

* Port: 1-28

* Instance: (1~65535)

* Server ID: ▾

* Polling Interval: (20~120)

Cancel

✓ OK

Enter the following information:

Item	Description
Port	Enter the port number on the device designated to send counter samples
Polling Interval	Click to set the interval for counter polling (0~120) for the time interval between counter poller samples.
Server ID	Click the drop-down menu to select a pre-configured analyzer server, see the previous step.
Cancel	Click Cancel to return to the previous menu without saving the settings.
OK	Click OK to create the counter poller port setting.

12. Click **Apply** at the upper right in the sFlow section to accept the new sFlow configuration.

10.2. Manage sFlow Monitor

To configure the sFlow Monitor settings:

1. Click **Monitoring > Device View**.
2. Click the **Managed** tab and select sFlow from the Switch-All drop-down menu. The Switch-sFlow devices table displays.
3. Select the target device by clicking the System Name. The Device Information page displays.
4. Click the **Management** tab to view the device's sFlow settings.

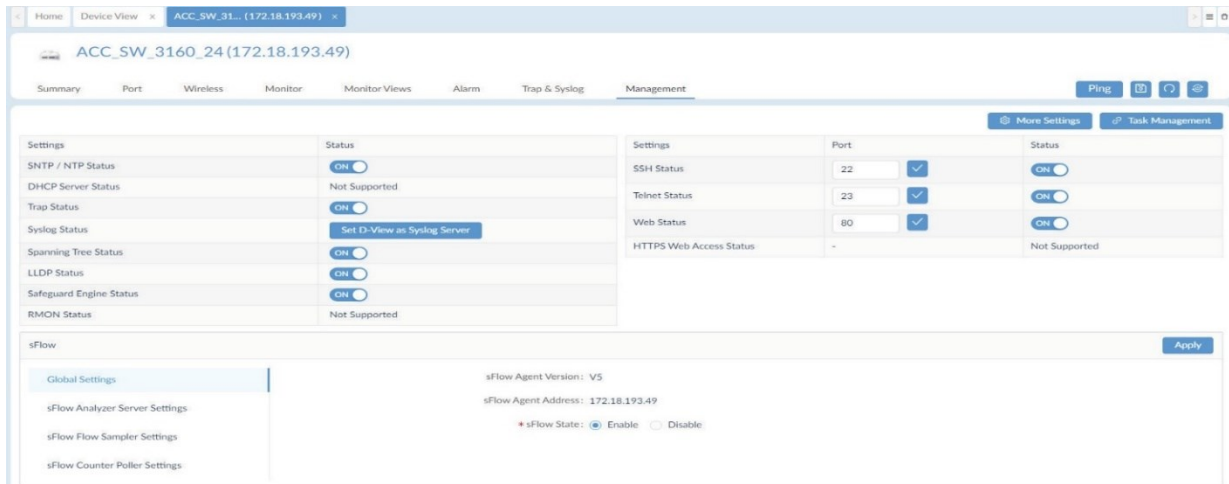

5. Under the sFlow section, configured analyzer servers are listed. For each configured server, you can perform the following:

Edit: allows you to modify the existing settings.

Delete: removes the entry from the list.

The sFlow Flow Sampler Settings and Counter Poller Settings can also be configured by clicking the respective tab.

10.3. Configure sFlow in Supported Devices

D-View 8 makes it easy for you to configure and manage devices that support sFlow. Note that sFlow Analyzer is only supported in Enterprise version.

To configure sFlow using sFlow Analyzer wizard:

1. Go to **Monitoring > sFlow Analyzer**. The sFlow Analyzer overview displays.

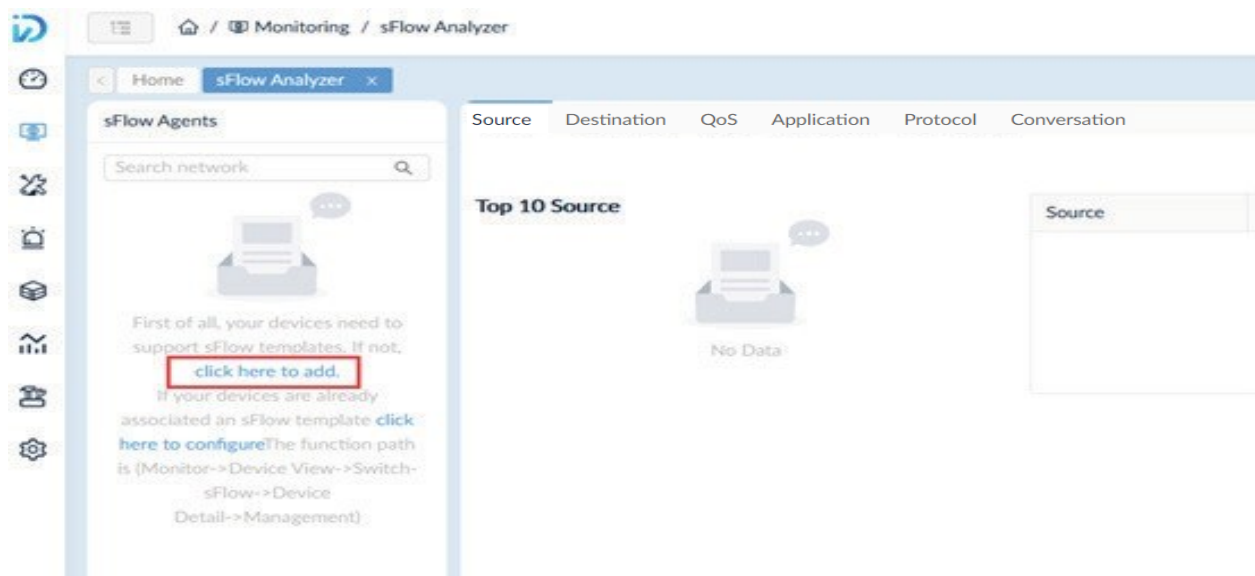

2. In the left pane, click the **Click Here to Add** link to add and configure a device for sFlow.

To configure sFlow using templates:

1. Go to the **Templates > Configuration Template**. Then click the **Configuration Template** tab.

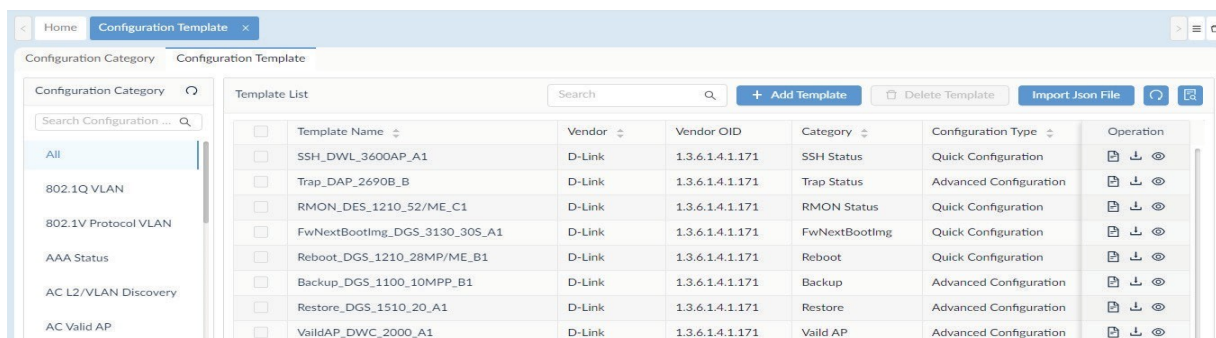

2. Click the **sFlow** category and click **+Add Template** at the upper right. The Template Settings page displays.

From the template settings, you can configure a template to include features such as device layout and basic components such as labels, input fields, buttons, radio buttons, text areas, toggle switches and tables for configuration input control.

Click **Cancel** to discard the changes and **Save** to add the template to the library. You can click **Preview** to view the configuration menu layout.

Once the sFlow configuration template is created, you need to associate it to a related device template to configure the sFlow parameters (Go to **Templates > Device Template**). Refer to the below 11.1 [Generate Device Template](#).

10.4. sFlow Network Monitor

sFlow (sampled flow) utilizes packet sampling to monitor switched networks to provide data for network usage and performance monitoring. Note that sFlow Analyzer is only supported in Enterprise version.

Once configured, the sFlow function will start monitoring and analyzing the network from the collected data using packet sampling or counter sampling.

To configure or view the sFlow monitoring:

1. Go to **Monitoring > sFlow Analyzer**.
2. The supported devices with configured port of the sampled packets will be displayed in the left pane. If there are no available data sources, you need to configure sFlow and enable sFlow sampling on the supported devices first. Refer to [10.1 Configure sFlow Monitor](#) and [10.3 Configure sFlow in Supported Devices](#).

The sFlow Analyzer overview displays. Click a tab to view the related sFlow statistics in one of the following categories:

- Source
- Destination
- QoS
- Application
- Protocol
- Conversation

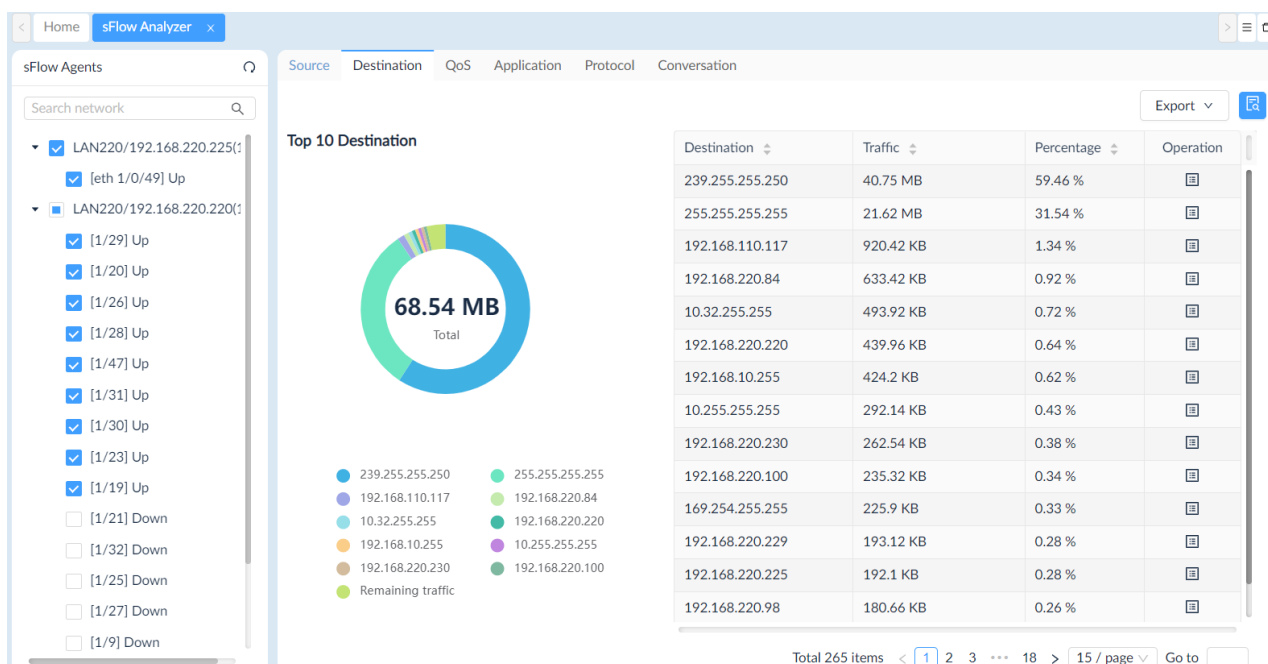

3. Click the **Advanced Query**  at the top right to set filter conditions to display information limited to a time range or any of the following conditions:
 - Specify the counter sampling interval.
 - Select the direction of packet passing a port: **Ingress**, **Egress**, or **Ingress and Egress**.
 - Slide the **Resolve DNS** or **Resolve User** to enable or disable the option.
 - Select the device identifier type: IP or MAC address to be displayed in the report.
 - Select the time range for data displayed.

- Click Search to start the query or Clear to reset the settings.

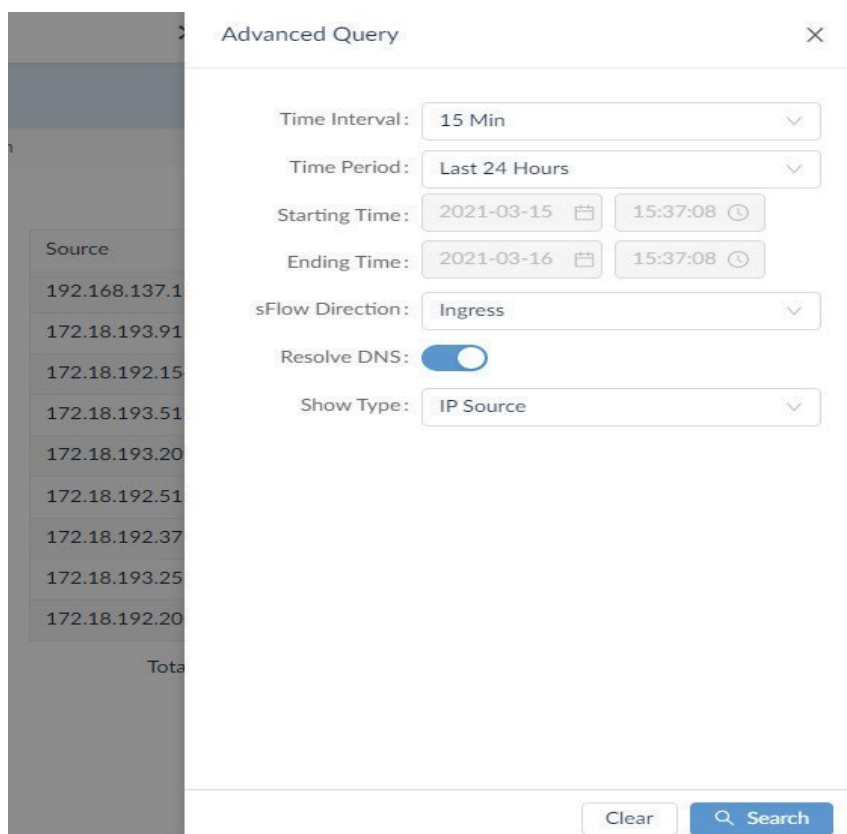

The image shows a screenshot of a web interface with an "Advanced Query" dialog box overlaid on a table. The table on the left has a "Source" column with IP addresses: 192.168.137.1, 172.18.193.91, 172.18.192.15, 172.18.193.51, 172.18.193.20, 172.18.192.51, 172.18.192.37, 172.18.193.25, and 172.18.192.20. The "Advanced Query" dialog box contains the following settings:

- Time Interval: 15 Min
- Time Period: Last 24 Hours
- Starting Time: 2021-03-15 15:37:08
- Ending Time: 2021-03-16 15:37:08
- sFlow Direction: Ingress
- Resolve DNS:
- Show Type: IP Source

At the bottom of the dialog box, there are two buttons: "Clear" and "Search".

10.5. View and Export sFlow Monitoring Results

After specifying the conditions of sFlow information, with traffic transmitting through the monitoring sources, the results of sFlow can be obtained and analyzed. Note that sFlow Analyzer is only supported in Enterprise version.

The following information can be polled and displayed:

- **Source:** Display the source device. By default, the application displays information about the top 10 sources. Note that IP addresses or MAC addresses can be interpreted with configured aliases (go to **System > Basic Settings > sFlow Settings > IP Alias Mapping** or **System > Basic Settings > sFlow Settings > MAC Address Mapping**.)
- **Destination:** Display the destination device. By default, the application displays information about the top 10 destinations. You can also choose to display the destination by its IP address or MAC address. Note that MAC addresses can be interpreted with aliases (go to **System > Basic Settings > sFlow Settings > IP Alias Mapping** or **System > Basic Settings > sFlow Settings > MAC Address Mapping**.)
- **QoS:** Display the top 10 QoS. The DSCP is defined in sFlow Settings (go to **System > Basic Settings > sFlow Settings** and choose the **DSCP Mapping** tab.)
- **Application:** Display the application usage. It displays information about the top 10 applications. For mapping between an application and an alias, go to **System > Basic Settings > sFlow Settings > Application Mapping**.
- **Protocol:** Display the network protocol usage.
- **Conversation:** Display the conversation between devices.

To view the results of sFlow monitoring:

1. Go to **Monitoring > sFlow Analyzer**. The sFlow Analyzer page displays.

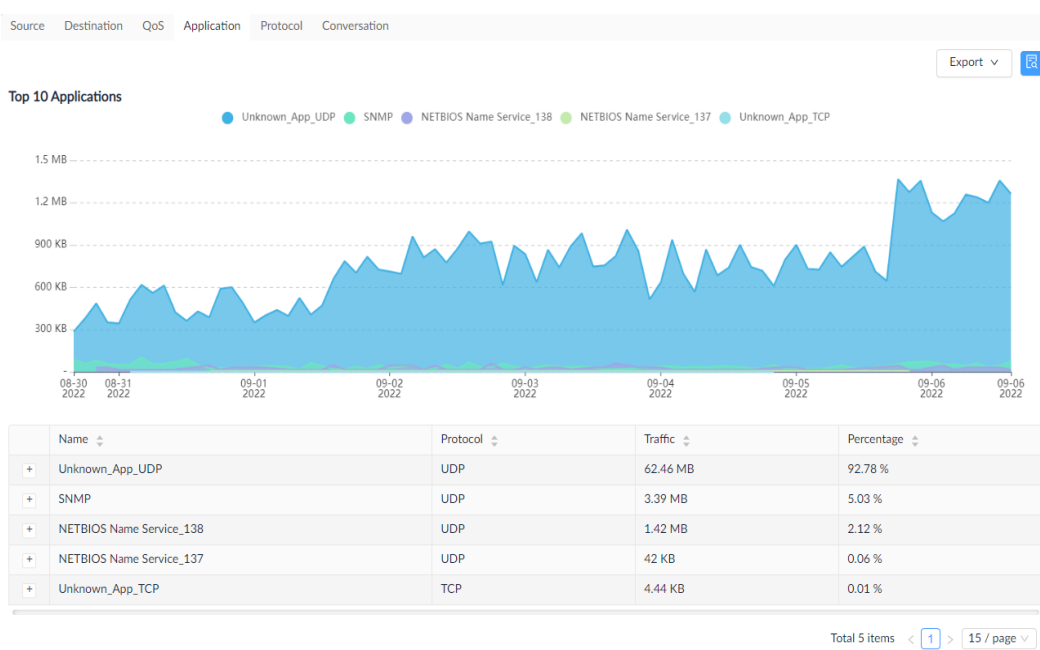

2. Select the corresponding tab to display related sFlow data in that category.
3. At the top right, click the **Export** menu and select from the following file types to export the displayed data.

The data is saved to the default download folder of your browser.

11 Templates

Templates are designed for quick setup of device monitoring and configuration tasks and to ensure consistent configuration among devices of the desired model. In addition to monitoring and configuration tasks, they are also efficient for device provisioning.

11.1 Generate Device Templates

Device Templates are useful in batch provisioning and configuration as well as monitoring.

To generate a device template:

1. Go to **Templates > Device Template**. Then Click **Add Device Template** in the upper right corner.
2. Enter the following information:

Item	Description
Model Name	Enter the desired model for configuration
Device Type	Select the device type from the drop-down menu. Or click New at the right to add a new device type. For more information about device type, go to Templates > Device Support .
Vendor Name	Select the vendor with the vendor OID from the drop-down menu. Or click New at the right to add a new vendor. For more information about vendor, go to Templates > Device Support .
SOID	Enter the device's system OID. You can also click Search at the right to find the specific device SOID using device IP and other SNMP connection parameters.
Hardware Version	Enter the hardware version of the device
Extended Information	Use this menu to add more properties to the device.

If you would like to associate a panel template, monitor template or configuration template to the device template, use the following procedure:

Click **Associate Panel Template** to associate a panel template to the model. You can customize a panel template to add to the system. For more information about panel template, refer to the below section [11.3 Generate Panel Template](#).

Click **Associate Monitor Template** to add a monitor template to the model. You can customize a monitor category and template to add to the system. For more information about monitor template, refer to the below section [11.4 Generate Monitor Template](#). Once a monitoring template is associated with a model, you can control its monitoring status or edit the polling interval. Refer to the above section [7.5.2 Monitor settings](#).

Click the **Configuration** tab to add a configuration template to the model. You can customize a configuration template to add to the system. For more information about configuration template, refer to the below section [11.5 Generate Configuration Template](#). Once a configuration template is associated with a model, it can then be used for batch configuration. Refer to [6.1.Create Configuration and Profiles](#) and [4.5.2 Batch Configuration](#).

Note: Some of the system-built templates that have been employed as system-defaults on managed devices are still undergoing the verification process and may not work correctly; please visit the D-View website (<https://dview.dlink.com/supportedModel>) to obtain the latest list of supported models.

11.2 Manage Device Vendor and Device Type

Vendors and device types are key device properties. They are used for many configuration items and search criteria.

To add a new vendor:

1. Go to **Templates > Device Support > Vendor**. Then click **+ Add Vendor** in the upper right corner.
2. Enter the following information:

Item	Description
Vendor Name	Enter a vendor name for configuration.
Vendor OID	Enter the corresponding OID (object identifier) for the vendor.

To add a new device type:

1. Go to **Templates > Device Support > Device Type**. Then click **+ Add Device Type** in the upper right corner.
2. Enter the following information:

Item	Description
Device Type Name	Enter a name for the new device type.
Device Category	Select the category from the device category list. To add a new device category, go to the Device Category tab.
Description	Enter a description for this new device type.

You can also modify or delete a vendor or device type after it is created. Select the **Edit** or **Delete** button under the **Operation** column.

11.3 Generate Panel Templates

Panel templates are used for displaying the front panel which might include the ports and connectors as well as the vendor logo for easy identification.

To generate a panel template:

1. Go to **Templates > Panel Template**. Then click **Add Template** at the top right.
2. Enter the following information:



Item	Description
Template Name	Enter a name for the template.
Description	Enter a brief description for the template.
Vendor Logo	Upload a picture as the logo image for the panel. Note the file must be in JPG or PNG with size less than 2 MB.
Panel Height	Select the panel height:1 or 2 U.
Panel Width	Select the width of the panel: full, 2/3 or customized width (an decimal between 0 and 1)
Port Numbering Rule	Select the rule for numbering the ports: vertical or horizontal.
Port Starting Number	Enter the start number for the ports.
Port Start ifIndex	Enter the start number for port's interface index.

To add ports to the panel, select the specific port appearance and drag and drop it on the designated port.

To label a port, click on a port and enter a name for Port Name.

To group/ungroup the ports, select **Group/Ungroup** from the **Draw a box to** drop-down menu, then circle the ports to group them together as a unit. Repeat this step to make multiple units of ports of the front panel.

3. Click **Save** to create the port layout for the panel template.

To edit a user-defined template, click **Edit**  under **Operation**. To generate a new template by modifying an existing template, click **Copy**  under **Operation**. You can modify all of the configurable items when editing a template; note that the template will be automatically named with a "-copy" suffix, which is also modifiable.

11.4 Generate Monitor Templates

Monitor templates are useful for configuring monitoring functions. You need to add a monitor category first before creating a monitor template. To add a monitor category:

1. Go to **Templates > Monitor Template**. Then select the **Monitor Category** tab.
2. Click **+Add Category** at the upper right.
3. Enter the following information:

Item	Description
Category Name	Enter a name for configuration.
Units	Select the unit for configuration.
Protocol	Select the protocol for configuration: SNMP, HTTPs, or WMI.
Line Chart	Enable or disable the line chart function which will display the monitoring results in graphic representation. Open the Device Information page (go to Monitoring > Device View and click the System Name link of a desired device) and select Monitor > Customized Monitor to view the added monitoring results.
Description	Enter a brief description for the category.
Data Source Definition	Click Add to define a name with value type for each data type.



Click **Save** to create the monitor category.

To add a monitor template:

1. Go to **Templates > Monitor Template** and select the **Monitor Template** tab. Select the desired category from the Monitor Category pane at the left. Then Click **Add Monitor Template** in the upper right corner.
2. Enter the following information:

Item	Description
Template Name	Enter a name for the template.
Monitor Category	Select the desired category for configuration.
Vendor Name	Select the vendor with the vendor OID from the drop-down menu. Or click New at the right to add a new vendor. For more information about vendor, refer to Templates > Device Support .
Monitoring Interval	Select the polling interval for monitoring: 60, 300, 600, 1800, and 7200. The default is 60 seconds.
Description	Enter a brief description for this template.
Data Source Definition	Click Add to define a name with value type for the specific data object obtained from the monitored devices.
Script	Enter a script to process the value of the added data source for the monitor template in Groovy.

3. Click **Save** to create the monitor template.

To edit a user-defined template, click **Edit**  under **Operation**. To generate a new template by modifying an existing template, click **Copy**  under **Operation**. You can modify all of the configurable items when editing a template; note that the template will be automatically named with a “-copy” suffix, which is also modifiable.

Once a template is created, you can associate it to a device model. It can then be configured for monitoring a device with the preset system metrics, go to **Templates > Device Template** and **Alarm & Notification >**

Monitor & Alarm Settings. You can also enable or disable a monitor function on a per-device basis; go to **Monitoring > Device View** and select the **Device Information** page via the **System Name** link. Then click the **Monitor tab** then click the **Monitoring Settings** button. (Refer to [4.2.2 Modify Device Information](#)).

11.5 Generate Configuration Templates

Configuration templates are useful for consistent device configuration management. A list of available configuration categories that serve as the framework for configuration templates has been provided.

To view all configuration categories:

1. Go to **Templates > Configuration Template**. Then select the **Configuration Category** tab.
2. A list of configuration categories for different configuration purposes is displayed:

Category Name	Description
v2_firmware_upgrade	v2. Upgrade firmware of devices. Required to comply with the built-in traits.
v2_backup	v2. Backup the configuration files of devices. Required to comply with the built-in traits.
v2_restore	v2. Restore the configuration files of devices.
v2_reboot	v2. Reboot devices. Required to comply with the built-in traits.
v2_save	v2. Save the running configuration to the bootup configuration. Required to comply with the built-in traits.
v2_sFlow	v2. Configure the sFlow related features of devices. Required to comply with the built-in traits.
Notes:	
<ol style="list-style-type: none"> 1. Click View under Operation and select the Category Traits drop-down menu (only available for the above listed categories) on the View Configuration Category page. The traits differ in the required SNMP objects or components for successful configuration operation. It is necessary that these required SNMP objects of different trait categories being tested and verified with an SNMP tool before adding a configuration template to the desired model. If a device cannot meet the SNMP verification requirement of a selected trait, then the particular configuration category cannot be added successfully to this model. 2. The configuration categories prefixed by v2 allow you to add respective configuration templates manually to managed devices when needed; all other system-built templates can be added manually for batch configuration with scheduled tasks (refer to 4.5 Manage Multiple Networks with Batch Configuration). 	

3. Click **View** under **Operation** to view the pre-defined template for the configuration category. The required SNMP object names (or component names) and their value types as well as the layout view are displayed.

Note: The configuration categories prefixed by v2 allow you to add respective configuration templates manually to managed devices when needed. For devices that are already associated with these types of configuration templates (i.e. Backup, Firmware_Upgrade, Reboot, Save, and Restore) do not need to add the updated v2 version of these configuration templates; nor can they dissociate from system-built templates.

4. Click **+ Add Template** to add a new template under this category. You can also add a template by going to the **Configuration Template** tab (as instructed below). The template design page for the configuration category appears. First, choose the Category Traits to show the required SNMP objects or components for successful configuration operation. Then select the value type and enter the value if it is not a user input element.
5. Click **Save**.
6. Select the **Configuration Template** tab. Click **View** under **Operation** to view the configured template for the specific configuration category.

To add a configuration template:



1. Go to **Templates > Configuration Template**. Then select the **Configuration Template** tab.
2. Select the desired category from the Configuration Category pane at the left. Then Click **Add Template** at the upper right.
3. Enter the following information:

Item	Description
Name	Enter a name for the template.
Configuration Category	It shows the selected category for configuration.
Vendor	Select the vendor with the vendor OID from the drop-down menu.
Category Traits	Select the trait to display the configuration procedure and requirements in Applicable Features and the final layout view and required SNMP objects in UI Appearance and Template Component . It will also display devices that have successfully implemented this specific trait in Reference Device .
Protocol	It shows the protocol for configuration: SNMP.
Description	Enter a brief description for this template.
UI Appearance	The template design page at the bottom allows you to configure the component settings such as SNMP objects, which requires you to enter the OID and the associated value type.





Note: The configuration categories prefixed by v2: v2_Backup, v2_Firmware__Upgrade, v2_Reboot, v2_Restore, V2_Save and v2_sFlow can only be implemented successfully if the specific functionality has been configured and tested using an SNMP tool with SNMP commands for validity. Devices that are already associated with these types of configuration templates (i.e. Backup, Firmware_Upgrade, Reboot, Save, and Restore) do not need to add the updated v2 version; nor can they dissociate from any system-built templates.

Note: The above template creation only applies to configuration categories prefixed by v2. To create a configuration template without the v2 prefix for batch configuration which can perform automatically with defined scheduled tasks (refer to [4.5 Manage Multiple Networks with Batch Configuration](#)).

4. Click **Save** to create the configuration template.

To edit a user-defined template, click **Edit**  under **Operation**. To generate a new template by modifying an existing template, click **Copy**  under **Operation**. You can modify all of the configurable items when editing a template; note that the template will be automatically named with a “-copy” suffix, which is also modifiable.

Once a template is created, you need to associate it to a device model (go to **Templates > Device Template**). It can then be used for configuration changes and settings (go to **Monitoring > Device View** and select the **Device Information** page via the **System Name** link of the desired model. Then click the **Management** tab. You should be able to see the following configuration sections in the Management tab:

Configuration Item	Description
Save to Device 	Provided via the v2_save template to save the running configuration to the bootup configuration with various configuration mechanism: devices that need to specify the address for both the running and startup configuration, as well as devices that support two configuration files but with different MIB nodes for saving the configuration.
Reboot 	Provided via the v2_reboot template to reboot the device.
Firmware Upgrade section and Firmware Upload button 	Provided via the v2_firmware_upgrade template: devices that have one or two images and require different procedure for replacing the images for boot-up and devices that can reboot automatically afterwards.
Configuration File Backup /Restore section  	Provided via the v2_backup and v2_restore template: devices that have 1 or 2 configuration (or restoration) files with or without requiring a specific file name and devices require different commands for file backup or restoration via TFTP.
sFlow section	Provided via the v2_sFlow template that supports various sFlow configuration: sFlow collector with only IPv4 address type, sFlow collector with both Ipv4 and IPv6 address types, sFlow collector with both address type selection (IPv4/IPv6) and address, and

	configuration with no global on/off setting.
--	--

Refer to 4.2.2 Modify Device Information for more information about these functions provided in the Device Information page.
--

12 Reports

Reports are available as either built-in templates or customized ones. They can be generated once only or repeatedly according to a recurrence pattern.

12.1 Generate Scheduled Reports and My Reports

Scheduled reports can be generated through existing report templates. You can also create time-based reports to designate a date and time for a recurrent schedule.

To generate a scheduled report:

1. Go to **Reports > General Reports** to display the General Reports page.

In order to create a scheduled report, an existing report must be present. See the below **Add a Report** section for further information.

2. Select a specific category from the reports list: Device Reports, Wired Interface Reports, Wireless Reports, or Advanced Reports.

The below example uses Wired Traffic category for demonstration.

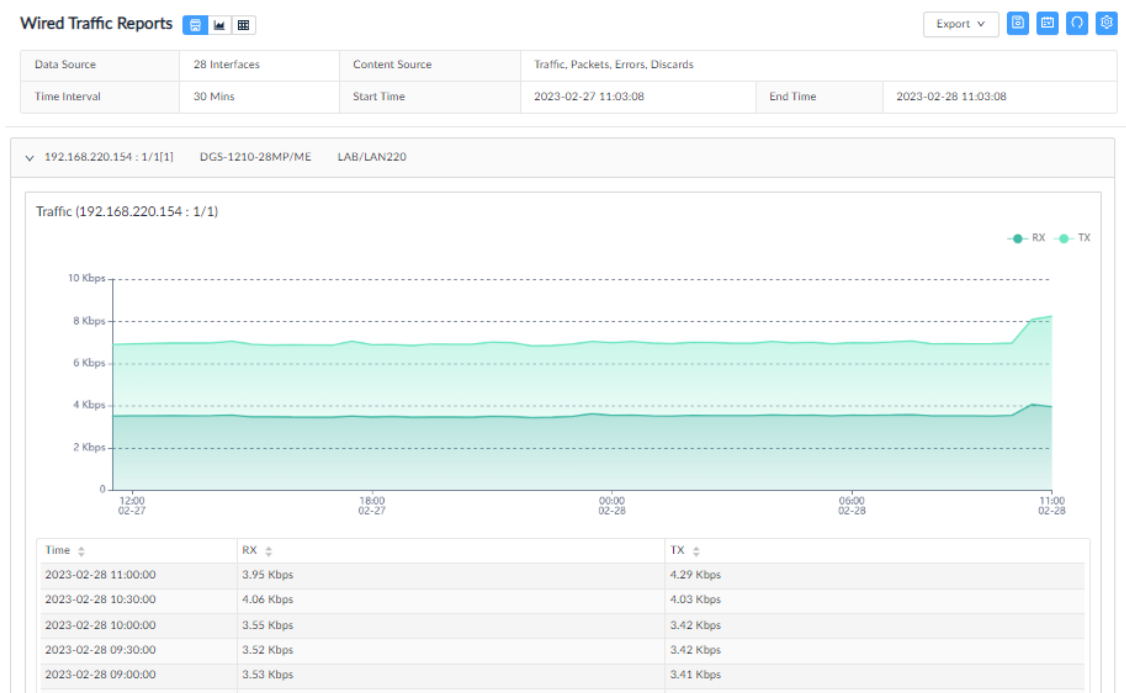

3. At the top right, click **Upgrade to Scheduled Reports**.

The **Upgrade to Scheduled Reports** page displays.

Upgrade to Scheduled Reports [Close]

Considering system performance, each user can create up to 500 reports. If the limit is exceeded, the system will delete the extra reports according to the FIFO rules. 57 reports created, 443 remain.

* Report Name:

Description:

Schedule Type: One Time Recurrent

* Specify Generation Time: [Calendar]

[Cancel] [OK]



NOTE: A maximum of 500 reports per user can be created to maintain optimal system performance. When the maximum is reached, older reports will be deleted.

4. Enter the required information:

- Report Name: enter a name for the report
- Description: enter a description to identify the report
- Schedule Type: select the scheduling method for the report, One Time or Recurrent.

For recurrent schedule, select a pre-defined schedule from the Schedule list or click Add Schedule to define a new schedule by selecting the frequency and effective duration to create reports:

Specific Days: Executes the report task a single time or multiple times for a single day at a specified date(s)/time(s). Choose times for a day and specify dates.

Daily: Executes the report task at a specified time or different times of the day. Choose daily interval between executions: 1 to execute the task every day, 2 to execute the task every other day, and so on.

Weekly: Executes the report task at a specified time or different times of a designated weekday or weekdays. Choose weekly interval between executions: 1 to execute the task on the specified weekday every week, 2 to execute the job every other week, and so on.

Monthly: Executes the report task at a specified time or different times on designated day or days of the month. Specify a month or months: Jan to Dec and the days of the month.

5. Click **OK** to configure the scheduled report or click **Cancel** to return to the previous menu.

Select **Scheduled Reports** under the Reports menu to view the added report. If the report is defined as One Time, it will be listed under the **One Time** tab. If it is recurrent, click the **Recurrent** tab to view the report.

One Time Recurrent

You can create up to 500 reports. 1 reports already created, 499 remain.

Report Name	Report Category	Content Source	Time Created	Generation Time	Result	Operation
my-schedule	Wired Throughput Top N	RX, TX	2023-02-28 09:44:26	2023-03-02 10:44:10	Waiting for generation	

Total 1 items < 1 > 50 / page

If **My Reports** is selected, the **Save to My Reports** page displays. For My Reports, enter a name and description to save it as My Reports.

To view the My Reports listing, select **Reports > My Reports**.

12.2 Manage Report Templates

The D-View 8 provides built-in report templates for the supported devices to accommodate a variety of monitoring and reporting cases.

The following table shows the menu of the default templates along with the types of reports available.

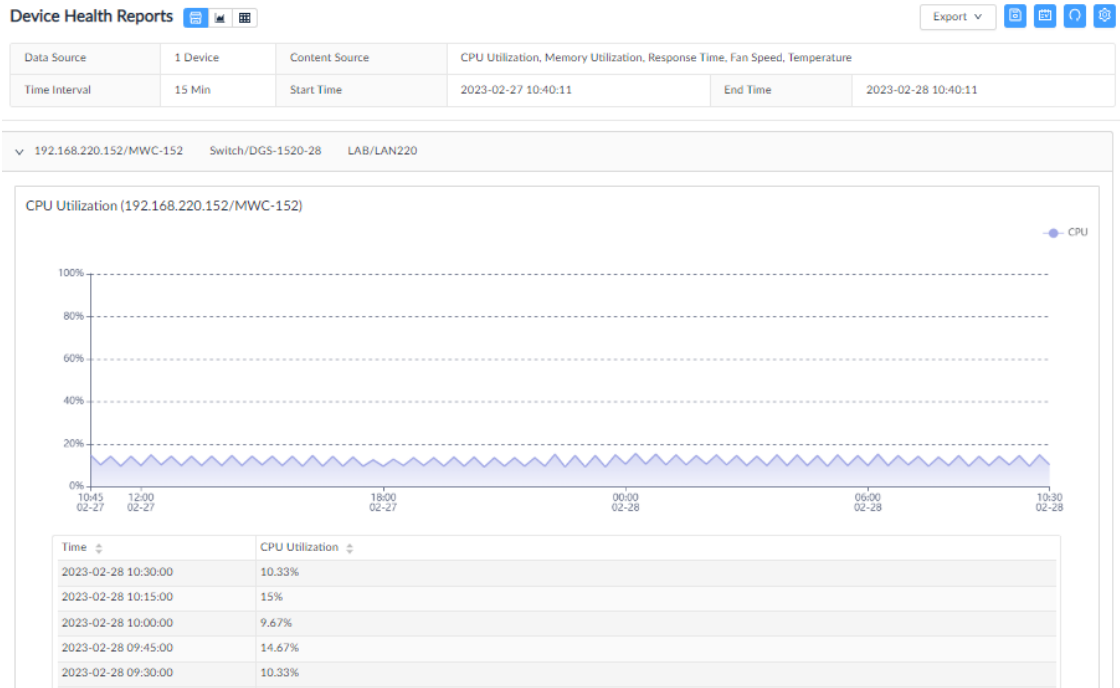

Report	Type	Category
General Reports	Device Reports	Device Health: CPU Utilization, Memory Utilization, Response Time, Fan Speed, and Temperature. Trap: trap event reports Syslog: syslog message reports Device Top N: shows the top 10 device statistics of the selected devices with respect to the following performance indicators: CPU Utilization, Memory Utilization, Response Time, Tx/Rx traffic, Trap and Syslog messages.
	Wired Interface Reports	Wired Traffic: shows statistics of Rx and Tx traffic for all interfaces of the selected devices.
		Wired Throughput Top N: shows the Rx/Tx traffic statistics of the top 10 device ports of the selected devices
	Wireless Reports	Wireless Client Count: shows the number of wireless clients of the selected wireless devices.
Wireless Traffic: shows the wireless traffic of the selected wireless devices.		
	Advanced Reports	Inventory: shows the distribution of the selected devices with respect to device category and model.
Scheduled Reports	One Time Reports	An automatic report generated at a specified time.
	Recurrent Reports	An automatic report generated repeatedly

		at specified times.
My Reports	Customized Reports	A saved snapshot of the selected report from General Reports.

The following demonstrates how to generate a Syslog report using the provided template:

1. Click **HERE** on the page to configure a new report.
2. Select devices from the device list. Note that the managed devices must have D-View configured as a Syslog Server for D-View to collect logs (go to **Monitoring > Device View** and select the **System Name** link to open the Device Information page. Then click the **Management** tab to find the Trap and Syslog status switch).
3. Configure duration by clicking the drop-down menu to determine the timespan of the report: last hour, last 6/12/24 hours, today, yesterday, last 7 days, this week, last week, last 30 days, this month, last month, or customized. For customized, select the Start/End date and time.
4. Click **Save** to display the generated report. Or click Reset to clear setting entered.
5. The buttons next to **Syslog Reports** control the representation of the report: show chart or table or both
 
6. The **Add Syslog Description** button at the top right can be configured to represent a selected syslog message using descriptive text in the chart along with the number of occurrence and severity level. Hoover over a defined syslog description to display related information.
7. To add a syslog description, click **Add Syslog Description**. Enter a description that will be displayed as highlight text associated with matching keywords of the logs to signify a particular logged event. Then click **Save**. The new description entry will also be listed in **Alarm & Notification > Trap & Syslog Editor > Syslog Editor**.
8. The following shows the display of the syslog report using Syslog Description. Note that the larger the text, the higher the occurrence of the defined system log.

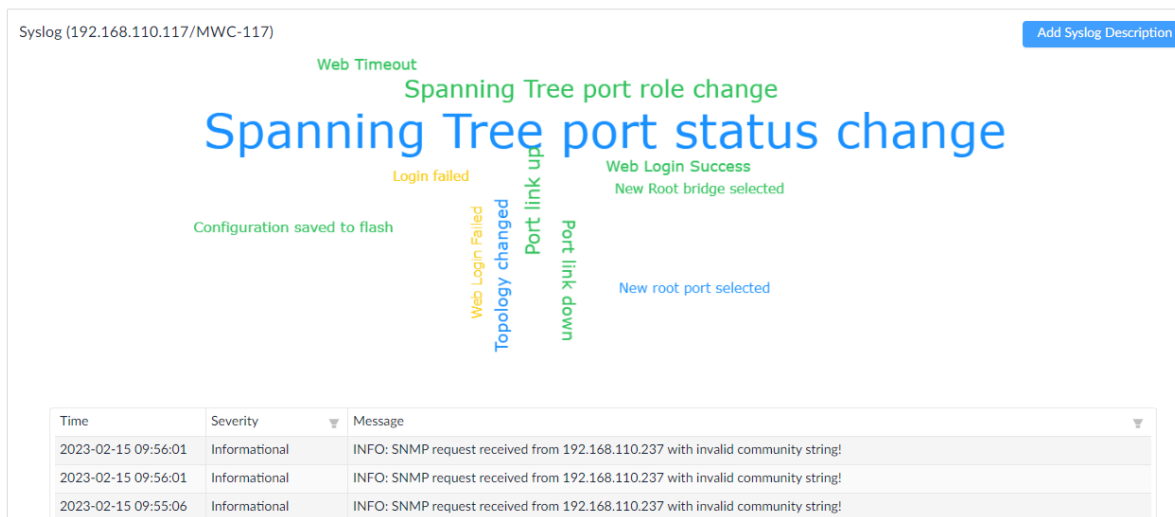

The Trap report also displays highlight text of OID description to signify trap events. Refer to **7.3 Trap Editor** for more information.

12.2.1. Add a Report

There are numerous templates for different reporting and summary purposes. By selecting a template, you can easily generate reports to help you maintain an effective network.

To select a report template or modify an existing one:

1. Go to **Reports > General Reports** to display the General Reports page.
2. Select a specific category from the reports list.

The following demonstration uses the Device Health Reports.

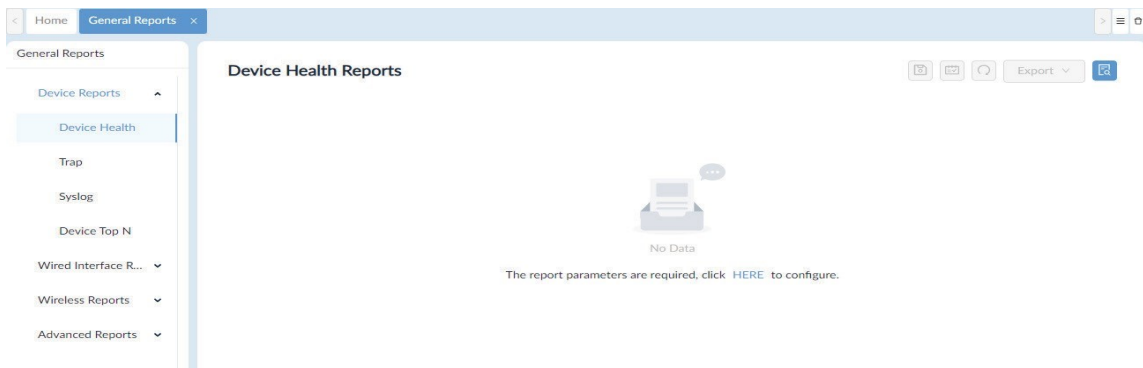

3. Click **HERE** to configure report settings.

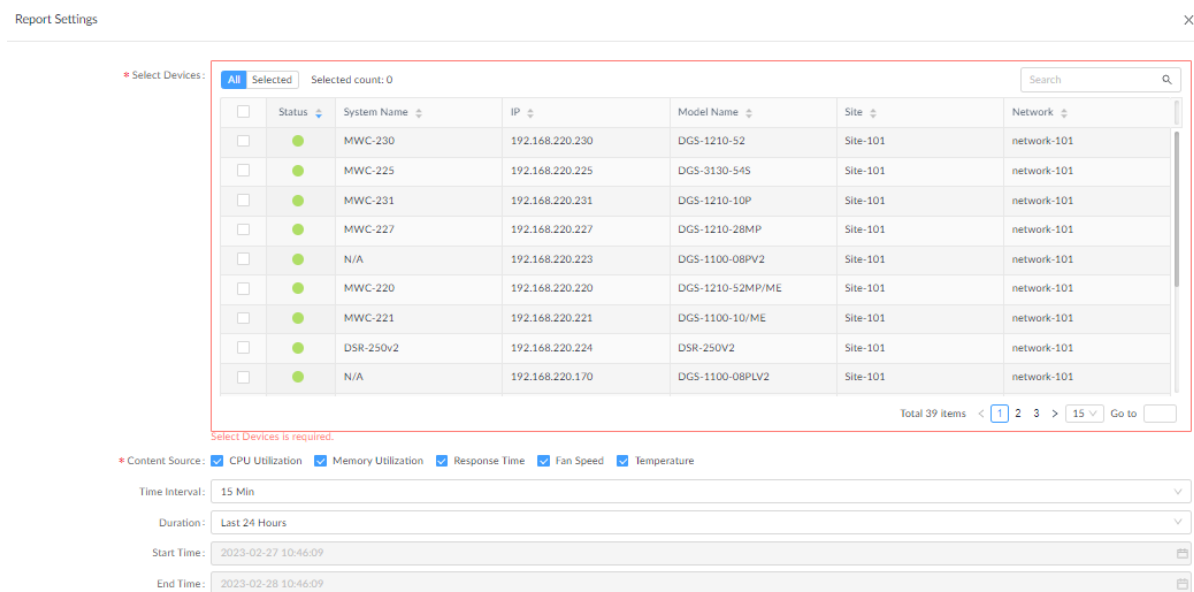

The Report Settings page displays.

4. Configure the following:

Item	Description
Select Devices	Scroll through the list to select devices or use the Search field to filter the list by System Name, IP, Model Name, Site or Network. Up to 15 devices can be selected for a single report in this category.
Content Source	Click to select the type of report data: CPU Utilization, Memory Utilization, Response Time, Fan Speed, or Temperature.
Time Interval	Select the interval for the data: 15 min, 2 hours, 8 hours, or 1 day
Duration	Click the drop-down menu to determine the timespan of the report: last hour, last 6/12/24 hours, today, yesterday, last 7 days, this week, last week, last 30 days, this month, last month, or customized.

Start Time	Set the starting date if customized duration is selected.
End Time	Set the ending date if customized duration is selected.
Note: The configurable settings vary depending on the type of report.	

5. Click **Save** to create the report or click **Reset** to clear settings entered.

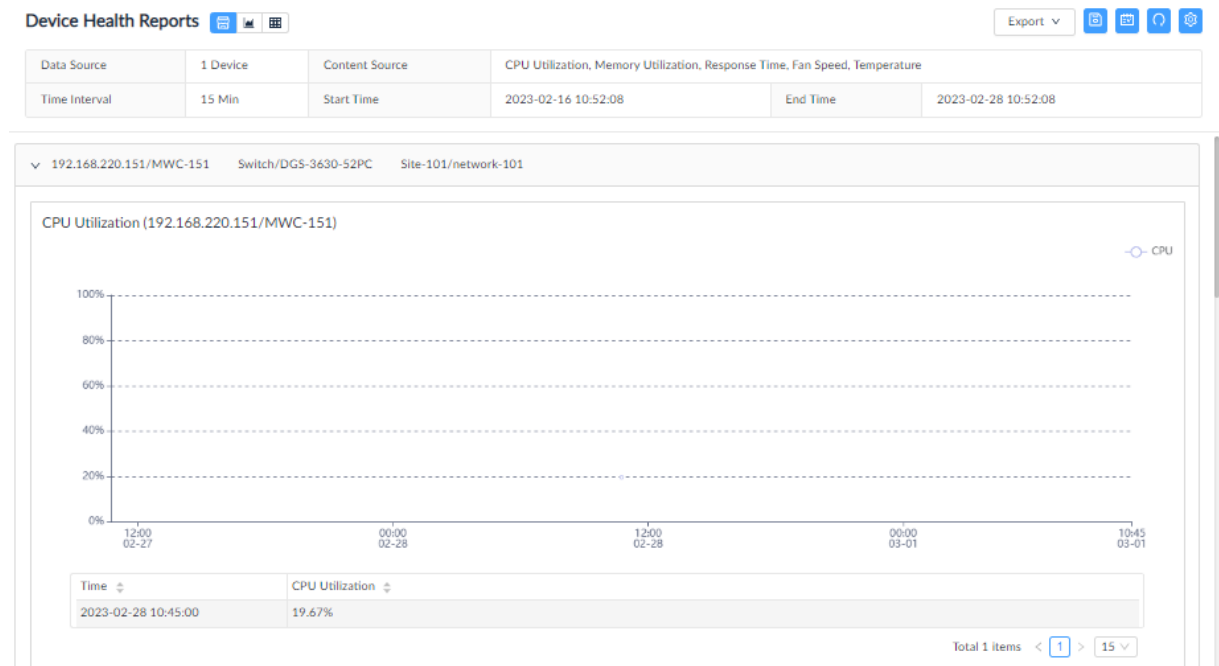

You can then view the report data in the default format, chart, or table by using the control buttons



12.2.2. Modify a Report

A report can be removed without deleting the template. However, the data generated by the report is deleted. We recommend that you save the reports using the Export function before deleting them.

To delete or modify an existing report:

1. Go to **Reports > General Reports** to display the General Reports page.
2. Select a specific category from the reports list: Device Reports, Wired Interface Reports, Wireless Reports, or Advanced Reports.



3. For demonstration, the Device Health category is selected, and the existing report also displays.

- Click **Report Settings** at the top right. The Report Setting page displays.

Report Settings ×

* Select Interfaces: All Selected Selected count: 28 Search

<input type="checkbox"/>	Status	IP	Interfaces	Model Name	Site	Network
<input type="checkbox"/>	●	192.168.220.148	0 / 28	DES-1210-28	LAB	LAN220
<input type="checkbox"/>	●	192.168.220.160	0 / 28	DGS-1210-28XS/ME	LAB	LAN220
<input type="checkbox"/>	●	192.168.110.221	0 / 0	DXS-3400-245C	LAB	LAN220
<input type="checkbox"/>	●	192.168.220.227	0 / 28	DGS-1210-28MP	LAB	LAN220
<input type="checkbox"/>	●	192.168.220.225	0 / 0	DGS-3130-54S	LAB	LAN220
<input type="checkbox"/>	●	192.168.220.228	0 / 28	DGS-1210-28P	LAB	LAN220
<input type="checkbox"/>	●	192.168.220.167	0 / 52	DES-1210-52/ME	LAB	LAN220
<input type="checkbox"/>	●	192.168.220.158	0 / 28	DGS-3630-28PC	LAB	LAN220
<input type="checkbox"/>	●	192.168.220.154	0 / 28	DGS-3630-28TC	LAB	LAN220

Total 47 items < 1 > 50 / page

* Content Source: Traffic Packets Errors Discards

Time Interval: 30 Mins

Duration: Last 24 Hours

Start Time: 2023-02-27 11:07:51

End Time: 2023-02-28 11:07:51

- To modify the current report, re-configure the settings and click **Save**.
- To clear all settings, click **Reset**. The report and the data will be removed from the **General Reports** page.

12.3 View and Remove Reports

All reports can be viewed for the period they are retained. Reports can also be removed.

To remove a Scheduled Report:

1. Click **Scheduled Reports** to view the list of scheduled reports.
2. Select the One Time or Recurrent tab.
3. Under **Operation**, click the **View report** or **Delete this report** to view or remove the report.

To view or remove a saved report from My Report:

1. Click **My Reports** to view all reports saved in this type.
2. Under **Operation**, click the **View report** or **Delete this report** to view or remove the report.

13 Users and Security Profiles

The system lets you manage users efficiently with profiles that define a set of function rights on the system.

This section covers the following topics:

- Profile Role Types
- Authentication Credentials
- Add a Profile

In addition to limiting the ability of users with function rights, you can also assign privileges that restrict access to a site or network (refer to [13.3 Add a User Profile](#)).

13.1 Profile Role Types

The D-View 8 has the following built-in user roles:

- Super Administrator: The user can perform all functions including licensing and system upgrade.
- Organization Administrator: The user can perform all administrative functions, including the management of users and security profiles within an organization.
- Site Administrator: The user can perform administrative functions within a site.
- Network Administrator: The user can perform all administrative functions within a network.

Function	Super Administrator	Organization Administrator	Site Administrator	Network Administrator
Dashboard				
Analysis				
Overview	Read and Write	Read and Write	Read and Write	Read Only
Switch	Read and Write	Read and Write	Read and Write	Read Only
Wireless	Read and Write	Read and Write	Read and Write	Read Only
Host	Read and Write	Read and Write	Read and Write	Read Only
sFlow	Read and Write	Read and Write	Read and Write	Read Only
PoE	Read and Write	Read and Write	Read and Write	Read Only
Customized Dashboard	Read and Write	Read and Write	Read and Write	Read Only
Monitoring				
Network Discovery	Read and Write	Read and Write	Read Only	Read Only
Device View	Read and Write	Read and Write	Read and Write	Read and Write
Interface View	Read and Write	Read and Write	Read and Write	Read and Write
Topology Map	Read and Write	Read and Write	Read and Write	Read Only
Connection View	Read and Write	Read and Write	Read and Write	Read and Write
Rack View	Read and Write	Read and Write	Read and Write	Read Only
sFlow Analyser	Read and Write	Read and Write	Read and Write	Read and Write
Device Group	Read and Write	Read and Write	Read and Write	Read and Write
Configuration				
Batch Configuration				
Quick Configuration	Read and Write	Read and Write	Read and Write	Read and Write
Advanced Configuration	Read and Write	Read and Write	Read and Write	Read and Write
Task Management				
Current Task	Read and Write	Read and Write	Read and Write	Read and Write
Historical Task	Read and Write	Read and Write	Read and Write	Read and Write
Firmware Management	Read and Write	Read and Write	Read and Write	Read and Write

Configuration Management				
Backup	Read and Write	Read and Write	Read and Write	Read and Write
Restore	Read and Write	Read and Write	Read and Write	Read and Write
File Management	Read and Write	Read and Write	Read and Write	Read and Write
Alarm & Notification				
Alarm				
Active Alarms	Read and Write	Read and Write	Read and Write	Read and Write
Historical Alarms	Read and Write	Read and Write	Read and Write	Read and Write
Trap & Syslog				
Trap	Read and Write	Read and Write	Read and Write	Read Only
Syslog	Read and Write	Read and Write	Read and Write	Read and Write
Trap Editor	Read and Write	Read and Write	Read and Write	Read Only
Syslog Editor	Read and Write	Read and Write	Read and Write	Read Only
Monitor & Alarm Settings				
Alarm Settings	Read and Write	Read and Write	Read and Write	Read and Write
Monitor Settings	Read and Write	Read and Write	Read and Write	Read and Write
Notification Center	Read and Write	Read and Write	Not Available	Not Available
Templates				
Device template	Read and Write	Read and Write	Not Available	Not Available
Device Support				
Vendor	Read and Write	Read and Write	Not Available	Not Available
Device Category	Read and Write	Read and Write	Not Available	Not Available
Device Type	Read and Write	Read and Write	Not Available	Not Available
Panel Template	Read and Write	Read and Write	Not Available	Not Available
Monitor Template				
Monitor Category	Read and Write	Read and Write	Not Available	Not Available
Monitor Template	Read and Write	Read and Write	Not Available	Not Available
Configuration Template				
Config Category	Read Only	Read Only	Not Available	Not Available
Config Template	Read and Write	Read and Write	Not Available	Not Available
Reports				
General Reports	Read and Write	Read and Write	Read and Write	Read and Write
Schedule Reports	Read and Write	Read and Write	Read and Write	Read and Write
My Reports	Read and Write	Read and Write	Read and Write	Read and Write
Tools				
MIB Browser	Read and Write	Read and Write	Read Only	Read Only
MIB Compiler	Read and Write	Read and Write	Not Available	Not Available
ICMP Ping	Read and Write	Read and Write	Read and Write	Read and Write
SNMP Test	Read and Write	Read and Write	Read and Write	Read and Write
Trace Route	Read and Write	Read and Write	Read and Write	Read and Write
CLI	Read and Write	Read and Write	Read and Write	Read and Write
File Comparison	Read and Write	Read and Write	Read and Write	Read and Write
System				
Basic Settings				
Organization	Read and Write	Read and Write	Not Available	Not Available
Mail Server Settings	Read and Write	Read and Write	Not Available	Not Available
Forward Trap	Read and Write	Read and Write	Not Available	Not Available
Forward Syslog	Read and Write	Read and Write	Not Available	Not Available
REST API	Read and Write	Read and Write	Read and Write	Read and Write
Credentials	Read and Write	Read and Write	Not Available	Not Available
sFlow Settings	Read and Write	Read and Write	Not Available	Not Available
System Preferences	Read and Write	Read and Write	Read and Write	Read and Write
User Management				
Users	Read and Write	Read and Write	Read Only	Not Available
Role Privileges	Read and Write	Read and Write	Not Available	Not Available

AD Server	Read and Write	Read and Write	Not Available	Not Available
Scheduling	Read and Write	Read and Write	Read Only	Read Only
Server Management				
Probe	Read and Write	Read and Write	Not Available	Not Available
Core Server	Read and Write	Read and Write	Not Available	Not Available
Web Server	Read and Write	Read and Write	Not Available	Not Available
D-View 8 Logs				
User Operation Log	Read Only	Read Only	Read Only	Read Only
System Log	Read Only	Read Only	Read Only	Read Only
Device Maintenance Log	Read Only	Read Only	Read Only	Read Only
D-View 7 Upgrade	Read and Write	Not Available	Not Available	Not Available
About	Read and Write	Read Only	Read Only	Read Only

13.2 Authentication

13.2.1. Join an AD Server

You can join the D-View 8 system to an AD domain. When you join an AD server, you will need the following:

- Domain name
- Domain controller address

1. Go to **System > User Management** to display the User Management page.

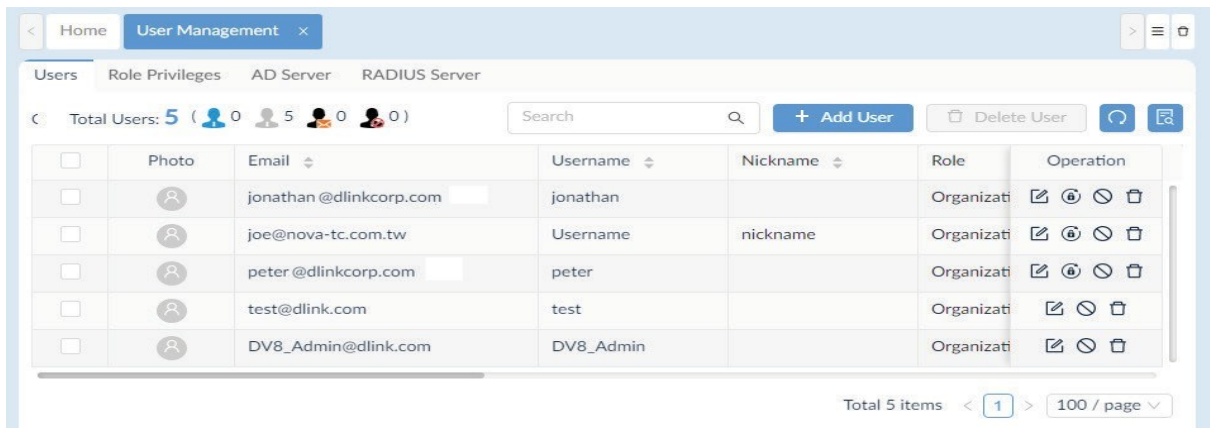

2. Click the AD Server tab. Then click **+Add AD Server**.

3. In the **Add AD Server** page, enter the domain name and controller information of the AD server.

4. Click **Save** to accept the settings or click **Cancel** to return to the previous screen.

To delete or modify a specific entry, you can use the Search or Advanced Query function to filter the list. Then click the **Edit** or **Delete** button under **Operation**.

13.3 Add a User Profile

The D-View 8 uses role-based access control. To obtain the function rights of each role, go to **System > User Management** and select the **Role Privileges** tab. Users are created and managed using a profile. A user profile consists of username, password and privileges associated with the designated role.

To add a user profile:

1. Go to **System > User Management** to display the User Management page.

	Photo	Email	Username	Nickname	Role	Operation
<input type="checkbox"/>		jonathan@dlinkcorp.com	jonathan		Organizati	
<input type="checkbox"/>		joe@nova-tc.com.tw	Username	nickname	Organizati	
<input type="checkbox"/>		peter@dlinkcorp.com	peter		Organizati	
<input type="checkbox"/>		test@dlink.com	test		Organizati	
<input type="checkbox"/>		DV8_Admin@dlink.com	DV8_Admin		Organizati	

2. Click **+Add User**.

3. Click the icon to browse and upload a JPG / PNG file to use it for the profile image.



4. Enter the following information:

Item	Description
Authentication type	Select one of the authentication methods: local or AD server.
Email	Enter the profile email.
Username	Enter the username for the profile.
Password	The password must be at least 6 alphanumeric characters consisting of both numbers and letters. Symbols are also permitted.
Retype Password	Enter the same password to authenticate.
Role	Select the profile's security role.
Nickname (optional)	Enter a descriptive nickname.
Location (optional)	Enter the location of the profile.
Telephone (optional)	Enter the phone number of the profile, optional.
Description (optional)	Enter a description to identify the profile.
Privilege	For each Role type, select an organization, site, or network that the user can access with read-only or both read and write access rights. A read-only access right permits an authorized user to obtain information of the assets under a network hierarchy. It does not permit modification of configurations. Note that the Privilege here controls the access to a network or a site whereas the user roles group together a set of rights to perform system operations. Refer to 13.1 Profile Role Types .



5. Click **Save** to create the profile or click **Cancel** to return to the previous menu.

Once a profile is created, the system will send a verification email to the specified email address for account verification.

Once a user account is created, you can perform the following to modify its profile:

- Edit  : modify the profile information
- Send Activation Email  : send an account invitation email with activation link.
- Activate: activate this user account. To activate a user account, click the Edit button to enter the Edit User

page, then click the Activated button . If you do not configure an SMTP server in **Mail Server Settings** (go to **System > Basic Settings > Mail Server Settings**), you can use this function to activate a user account instead of email verification.

- Reset Password : generate a new password for the profile. The new password will be sent to the profile's email. The Reset Password function is only available after a user account has been enabled.
- Disable : deactivate this user account. The Disable function is only available after a user has been enabled.
- Delete : remove this user account.

14 System Settings

You can configure global settings to be used for system-wide management and communication in the following areas:

- Organization
- Mail Server Settings
- Forward Trap
- Forward Syslog
- REST API
- SNMP/WMI/Telnet Credentials
- sFlow Settings
- System Preferences

14.1 Configure Global Settings

Set Up Organization

The organization information is located under the Basic Settings menu. You can define the time zone, location, and name in the basic settings. The Organization information is required for Network Discovery and subsequent display of network architecture.

To set up organization information:

1. Go to **System > Basic Settings**.

Organization | Mail Server Settings | Forward Trap | Forward Syslog | REST API | Credentials | sFlow Settings | System Preferences

* Organization Name:

Customized Logo: 
Click to upload or drag an image here (must be smaller than 2 MB and either a PNG or JPEG).

* Country/Region:

* Core Server Time Zone:

2. Define the following information:

Item	Description
Organization Name	Enter the name to define the organization.
Customized Logo	Select an image to upload, which must be less than 2 MB in JPEG or PNG format.
Country/Region	Select the location of the organization.
Time Zone	Select the time zone corresponding to the specified location.

3. Click **Save**.

Set Up Mail Server

Setting up a mail server is required for email notifications. To set up mail server information:

1. Go to **System > Basic Settings** to display the Organization page.
2. Click the **Mail Server Settings** tab to display the Mail Server Settings.

Organization Mail Server Settings Forward Trap Forward Syslog REST API Credentials sFlow Settings System Preferences

D-View 8 URL

* D-View 8 URL

Mail Server

* SMTP Host:

* Port: (1 to 65535)

* Sender Email Address:

* Sender:

Security Type:

Encoding Type:

Authentication:

* Username:

* Password:

Test Mail Server

3. Enter the following information:

Item	Description
D-View 8 URL	The URL will be used for email verification link and appear in the password reset emails.
SMTP Host	Enter the SMTP server address.
Port	Enter the port number of the SMTP server.
Sender Email Address	Enter the email address of the sender of the outgoing email.
Sender	Enter the sender's name of the outgoing email.
Security Type	Select the security protocol for the domain, None or SSL.
Encoding Type	Select the type of transfer encoding (UTF8 or ASCII) for SMTP communication.
Authentication	Select whether the SMTP server requires authentication. And enter the following information if authentication is used.
Username	Enter a username authorized to access the SMTP server.
Password	Enter a password for the username.

4. Click **Save**.

Once a mail server is configured, test the settings with the **Test Mail Server** function.

5. In the email address field, enter an email address to which the test email will be sent.
6. Click **Send Test Mail**.
7. Check the email account if the test email has been received.
8. If the email was not received, correct the mail server settings accordingly.

Set Up Forward Trap

D-View 8 provides SNMP trap forwarding with the Forward Trap function. The function allows you to forward traps to a specified server destination.

To configure Forward Trap:

1. Go to **System > Basic Settings**.
2. Click the **Forward Trap** tab to display the Forward Trap page.

Destination Host	Destination Port	Operation
192.168.10.210	161	

Total 1 items < 1 > 200 / page v

3. Click **Add Destination Host**. Then enter the destination host (IPv4 or IPv6 address) and port to define the trap destination.
4. Click **Save**.

Set Up Forward Syslog

You can configure the system to send syslog messages to an external syslog server.

To configure Forward Syslog:

1. Go to **System > Basic Settings**.
2. Click the **Forward Syslog** tab to display the Forward Syslog page.

Destination Host	Destination Port	Operation
1.1.1.12	2343	

Total 1 items < 1 > 200 / page v

- Click **Add Destination Host**. Then enter the destination host (IPv4 or IPv6 address) and port to define the syslog destination.

Add Destination Host
X

Destination Host:

Destination Port:

- Click **Save**.

Generate REST API Key

REST API is only supported in the Enterprise version. REST API authentication uses HTTPS as the transport protocol for all REST API access. The authentication is required for third-party applications to access through APIs.

To configure REST API:

- Go to **System > Basic Settings**.
- Click the **REST API** tab to display the API Key.

API Key Name	Created By	Time Created	API Key	Operation
tttt	mag	2022-10-18 16:47:02	⊗ ⊕ 🗑
test	mag	2022-09-22 09:40:24	⊗ ⊕ 🗑

Total 2 items < 1 > 200 / page

- Click **Add API Key**. Then enter a name to identify the API key.

Add API Key
X

* API Key Name:

* API Key:

- Click **Regenerate Key** to create a new key.
- Click **Save**.

Set Up Credentials

Set Up SNMP Credentials

The SNMP credentials manages access to SNMP-compatible devices. Storing the credentials is useful for when the system is scanning network devices in Network Discovery (go to **Monitoring > Network Discovery**). Refer to [4.1 Network Discovery](#) for more information about Network Discovery.

To configure SNMP credentials:

1. Go to **System > Basic Settings** to display the Organization page.
2. Click the **Credentials** tab and select **SNMP Credentials** from the left pane.

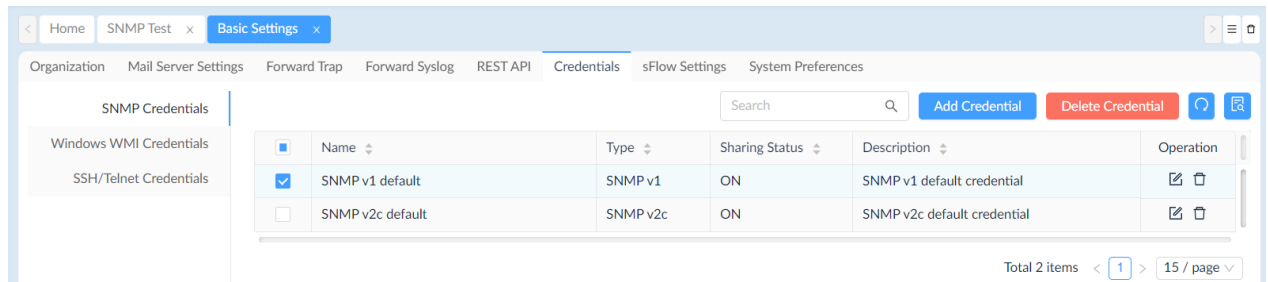

3. Click **Add Credential**.

Add Credential
✕

SNMP Protocol Version: SNMP v1 SNMP v2c SNMP v3

* Name:

* Port:

* Timeout [s]:

* Retransmit:

* Read Community: [🔗](#)

Write Community: [🔗](#)

* Non-Repeaters:

* Max-Repetitions:

Description:

Cancel
Save

4. Select the SNMP version of the credential: SNMP v1, SNMP v2c, or SNMP v3. By default, D-View 8 uses SNMP v2c.

For SNMP v1:

- Enter a name and port for SNMP.
- Enter the timeout period in seconds (default: 4).
- Enter the number of retries (default: 3)
- Enter the read credential string (default: public).
- Enter the write credential string (default: private).
- Enter a description to help identify the profile (optional).
- Enable or disable **Sharing Status** to let other administrators with authorized role to view and edit this SNMP setting.

For SNMP v2c:

- Enter a name and port for SNMP.
- Enter the timeout period in seconds (default: 4).
- Enter the number of retries (default: 3)
- Enter the read credential string.
- Enter the write credential string.
- Enter the number of objects that can return in a single get-next instance (default: 0).
- Enter the number of Get Next operations to be performed on each variable (default: 10).
- Enter a description to help identify the profile (optional).
- Enable or disable **Sharing Status** to let other administrators with authorized role to view and edit this SNMP setting.

For SNMPv3:

- Enter a name and port for SNMP.
- Enter the timeout period in seconds (default: 4).
- Enter the number of retries (default: 3)
- Enter the number of objects that can return in a single get-next instance (default: 0).
- Enter the number of Get Next operations to be performed on each variable (default: 10).
- Enter the Context Name (optional), which is used as the identifier for a named subset of the object instances.
- Select the Security Level:
 - authPriv: authentication and privacy (default).
 - authNoPriv: authentication, no privacy.
 - noAuthNoPriv: no authentication, no privacy.
- Select the Auth Protocol if authentication is used:
 - MD5 (MD5 message-digest algorithm): produces a 128-bit hash value to authenticate users.
 - SHA (Secure Hash Algorithm): produces a 160-bit has value to authenticate users.
- Enter the Authentication Password to be used with the Authentication Protocol.
- Select the Privacy Protocol if privacy is used:
 - DES (Data Encryption Standard) or AES (Advanced Encryption Standard) for data encryption.
- Enter the Privacy Password to be used with the Privacy Protocol.
- Enter a description to help identify the profile (optional).

6. Enable or disable **Sharing Status** to share the credentials with other administrators with authorized role.

7. Click **Save**.

Set Up Windows WMI Credentials

Windows Management Instrumentation (WMI) is used in Microsoft Windows systems to help retrieve information on a remote system and it requires appropriate permissions. Storing the credentials is useful when discovering network devices in Network Discovery (go to **Monitoring > Network Discovery**).

Enter the following to add a WMI credential profile:

Add Credential
✕

* Name:

Domain Name:

* Username:

* Password: 🗨

Description: ↵

Sharing Status ⓘ: OFF

Name: Enter a name for this profile.

Domain Name: Enter the windows domain name.

Username: Enter the username with the Windows system administrator privilege or a user account with permissions to access WMI data.

Password: Enter a password for the above user account.

Description: Enter a description to help identify this profile.

Sharing Status: Select whether other administrators with authorized role in the organization can view or modify this profile.

Set Up SSH/Telnet Credentials

SSH and Telnet allows remote administration of a D-View 8 server and it requires configuration of communication port and access privileges.

Note: This function is not applicable in this release and will be fixed in the future release.

Enter the following to add an SSH/Telnet credential profile:

Add Credential
X

* Name:

* Protocol: v

* Port:

* Username:

Password: 👁

* Timeout [s]:

* Login Prompt:

* Password Prompt:

* Command Prompt: Or

Description:

Name: Enter a name for the profile.

Protocol: select the communication protocol for remote management: SSH or Telnet.

Port: select the associate port for the above protocol.

Username/Password: Enter the username and password that will be required to access the server.

Timeout: enter the session timeout value.

Login Prompt: enter the prompt to be displayed for login.

Password Prompt: enter the prompt to be displayed at the command line for entering password.

Command Prompt: Enter the prompt to be displayed at the command line for entering command.

Description: Enter a description to identify this profile.

Sharing Status: Select whether other administrators with authorized role in your organization can view or modify this profile.

Set Up sFlow Settings

Effective management of applications and the network resources is one of the benefits of adopting the sFlow standard through D-View 8. These settings will help you observe traffic from sampled packets matched with the mapped applications or DSCP names in sFlow Analyzer (go to **Monitoring > sFlow Analyzer**). Note that the configuration of application mappings for sFlow Analyzer is only supported in Enterprise version.

To view and configure sFlow Settings:

1. Go to **System > Basic Settings**.
2. Click the **sFlow Settings** tab to display the sFlow Settings page.

Application Name	Port Number	Protocol	IP Address	Operation
wlyttest	161	UDP	All	
Memcached	11211	TCP	All	
netwall	533	UDP	All	
unixtime	519	UDP	All	
ntalk	518	UDP	All	
talk	517	UDP	All	
RIP	520	UDP	All	
sFlow	6343	UDP	All	
Syslog	514	UDP	All	
QQ	4000	TCP	All	
Web Proxy Service	8080	TCP	All	
Oracle	1521	TCP	All	
network blackjack	1025	UDP	All	
Internet Key Exchange(IKE)	500	UDP	All	
Common Internet File System(CIFS)	445	UDP	All	

Total 160 items < 1 2 3 4 5 ... 11 > 15 / page Go to

From sFlow Settings, the following mapping options are available:

- Application Mapping
- DSCP Mapping
- IP Alias Mapping
- MAC Address Mapping

Application Mapping

To add an application to be identified properly from the collected data:

1. Go to **System > Basic Settings**.
2. Click the **sFlow Settings** tab to display the sFlow Settings page.
3. Click the **Application Mapping** tab.

Application Name	Port Number	Protocol	IP Address	Operation
wlyttest	161	UDP	All	
Memcached	11211	TCP	All	
netwall	533	UDP	All	
unixtime	519	UDP	All	
ntalk	518	UDP	All	
talk	517	UDP	All	
RIP	520	UDP	All	
sFlow	6343	UDP	All	
Syslog	514	UDP	All	
QQ	4000	TCP	All	
Web Proxy Service	8080	TCP	All	
Oracle	1521	TCP	All	
network blackjack	1025	UDP	All	
Internet Key Exchange(IKE)	500	UDP	All	
Common Internet File System(CIFS)	445	UDP	All	

Total 160 items < 1 2 3 4 5 ... 11 > 15 / page Go to

4. Click **Add Mapping** at the upper right. Then enter the application name and its associated port.

Add Mapping X

* Application Name:

* Port Number:

* Protocol:

* IP Address: All IP Address Subnet IP Range

Cancel Save

5. In the **Protocol/Port Number** field, click the drop-down menu to select TCP or UDP and enter port number for the protocol.
6. In the **IP Address** field, select All, IP Address, Subnet, or IP Range to specify the address range in the flow data.
7. Click **Save** to create the application mapping rule or **Cancel** to return to the previous menu.

DSCP Mapping

To view defined DSCP (Differentiated Services Code Point) sFlow mapping used for QoS:

1. Go to **System > Basic Settings**.
2. Click the **sFlow Settings** tab to display the sFlow Settings page.
3. Click the **DSCP Mapping** tab to obtain DSCP names and its mapped values.

DSCP Name	Binary Points	Decimal Points	IP Precedence
AF11	001010	10	1
AF12	001100	12	1
AF13	001110	14	1
AF21	010010	18	2
AF22	010100	20	2
AF23	010110	22	2
AF31	011010	26	3
AF32	011100	28	3
AF33	011110	30	3
AF41	100010	34	4
AF42	100100	36	4
AF43	100110	38	4
CS1	001000	8	1
CS2	010000	16	2
CS3	011000	24	3

Total 21 items < 1 2 > 15 / page Go to

IP Alias Mapping

To add an IP address to be identified with the defined name from the collected data::

1. Go to **System > Basic Settings**.
2. Click the **sFlow Settings** tab to display the sFlow Settings page.
3. Click the **IP Alias Mapping** tab to display the IP Alias Mapping page.

IP Alias	IP Address	Operation
123	10.90.90.199	

Total 1 items < 1 > 200 / page

4. Click **Add Mapping** at the upper right.
5. Enter the IP Alias and IP address to define the mapping of an alias and IP address for flow data.
6. Click **Save** to create the IP address mapping rule or **Cancel** to return to the previous menu.

Add Mapping [X]

* IP Alias:

* IP Address:

MAC Address Mapping

To add a MAC address to be identified with the defined name from the collected data:

1. Go to **System > Basic Settings**.
2. Click the **sFlow Settings** tab to display the sFlow Settings page.

Application Name	Port Number	Protocol	IP Address	Operation
wlytest	161	UDP	All	
Memcached	11211	TCP	All	
netwall	533	UDP	All	
unixtime	519	UDP	All	
ntalk	518	UDP	All	
talk	517	UDP	All	
RIP	520	UDP	All	
sFlow	6343	UDP	All	
Syslog	514	UDP	All	
QQ	4000	TCP	All	
Web Proxy Service	8080	TCP	All	
Oracle	1521	TCP	All	
network blackjack	1025	UDP	All	
Internet Key Exchange(IKE)	500	UDP	All	
Common Internet File System(CIFS)	445	UDP	All	

Total 160 items < 1 2 3 4 5 ... 11 > 15 / page Go to

3. Click the **MAC Address Mapping** tab.

Organization Mail Server Settings Forward Trap Forward Syslog REST API Credentials sFlow Settings System Preferences

Application Mapping DSCP Mapping IP Alias Mapping MAC Address Mapping

Alias	MAC Address	Description	Operation
MAC-port01	3C:F0:11:3E:6C:9F	MAC-mapping 01	

Total 1 items < 1 > 200 / page

4. Click **Add Mapping** at the upper right.

Add Mapping X

* Alias:

* MAC Address:

Description:

5. Enter Alias and MAC address to define the mapping of an alias and a MAC address.
6. Click **Save** to create the MAC Address mapping rule or **Cancel** to return to the previous menu.

Set Up System Preferences

Theme settings for the overall layout of the interface are configured through System Preferences. You can configure Table and Theme settings to set specific page styles.

To configure System Preferences:

1. Go to **System > Basic Settings**.
2. Click the **System Preferences** tab to display the System Preferences page.

Organization Mail Server Settings Forward Trap Forward Syslog REST API Credentials sFlow Settings System Preferences

Table Settings

Number of single page displays:

Table size:

Show tips when the table settings are modified

Theme Settings

Page style and theme:

3. Click the drop-down menu to select the number of single page display (rows) for all tables in D-View 8: 15 (default), 50, 100, or 200.
4. From the table size selector, set the size for all the tables in D-View 8: Large, Middle (default), or Small.
5. Enable the option: Show tips when the table settings are modified so that users will be notified of table setting changes via toast messages.

In **Theme Settings**, select a defined theme to apply to the interface. You can select a dark or light background or dark side pane with light background.

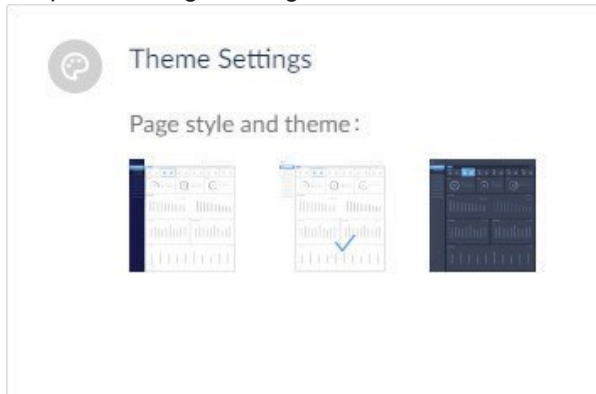

To reset to the original settings, click the **Reset** button. All table and theme settings will be restored to the default.

14.2 Scheduling

The scheduling function helps automate several functions periodically according to a defined recurrent frequency in the designated time span.

There are two types of scheduling options: Recurrent and Time-Range. The recurrent schedule can be assigned to network discovery, tasks, configuration backup and restore, and scheduled reports, whereas the time-range schedule can be assigned to alarm settings and notification rules.

To set a recurrent schedule:

1. Go to **System > Scheduling** and select the **Recurrent Schedule List** tab.
2. Click **Add Schedule** at the upper right. Then enter the following information:

Add Schedule
✕

Schedule Information

* Schedule Name:

Core Server Time Zone: (GMT+03:30) Tehran ▼

Description:

Sharing Status: OFF

Schedule Settings

Repeats: Daily ▼

* Recurs Every: Day(s)

* Time: 🕒 +

Duration

* Date: ~ 📅

Cancel Save

Item	Description
Schedule Information	
Schedule Name	Enter a name for the schedule.
Core Server Time Zone	Select the time zone. (It can already be set in the Organization tab.)
Description	Enter a brief description for the schedule.
Sharing Status	Enable sharing to let other administrators with the authorized role to modify or view this schedule.
Schedule Settings	
Repeats	Select the frequency: Daily, Weekly, Monthly, or Specific Days.
Recurs Every	<p>Specific Days: Schedule a single time or multiple times at a specified date(s)/time(s). Selecting multiple times will enable execution of the same task at different times for each date.</p> <p>Daily: Schedule a specified time of the day. Then choose daily interval between executions: 1 to execute the task every day, 2 to execute the task every other day, and so on.</p> <p>Weekly: Schedule a specified time of a designated weekday or weekdays. Then choose weekly interval between executions: 1 to execute the task every week, 2 to execute the job every other week, and so on.</p> <p>Monthly: Schedule a specified time on day(s) of the selected month(s): specify a month or months: Jan to Dec and the days of the month.</p> <p>Specific Days: Schedule a specified time and date(s).</p>
Time	Select the time (24-hour clock): hh:mm for the schedule. Selecting multiple times will enable execution of the same task at different times of the same day.

Duration	Select the start and end dates to designate the effective time span.
----------	--

To set a time-range schedule:

1. Go to **System > Scheduling** and select the **Time Range Schedule List** tab.
2. Click **Add Schedule** at the upper right. Then enter the following information:

Add Schedule
X

Schedule Information

Schedule Name:

Core Server Time Zone: (GMT+03:30) Tehran ▼

Description:

Sharing Status: OFF

Range

* Weekdays: All

Mon Tues Wed Thur

Fri Sat Sun

* Time: To (HH:MM)

Duration

* Date: ~

Cancel Save

Item	Description
Schedule Information	
Schedule Name	Enter a name for the schedule.
Core Server Time Zone	Select the time zone. (It can already be set in the Organization tab.)
Description	Enter a brief description for the schedule.
Sharing Status	Enable sharing to let other administrators with the authorized role to modify or view this schedule.
Range	
Weekdays	Select all weekdays or a specific weekday(s).
Time (range)	Select the start and end time (24-hour clock): hh:mm for the schedule.
Duration	Select the start and end dates to designate the effective time span.

14.3 Licenses

Product registration and license expiration information can be obtained in the **About** page.

Note: Only Super Administrators can view the License page.

To obtain product information:

Go to **System > About**.

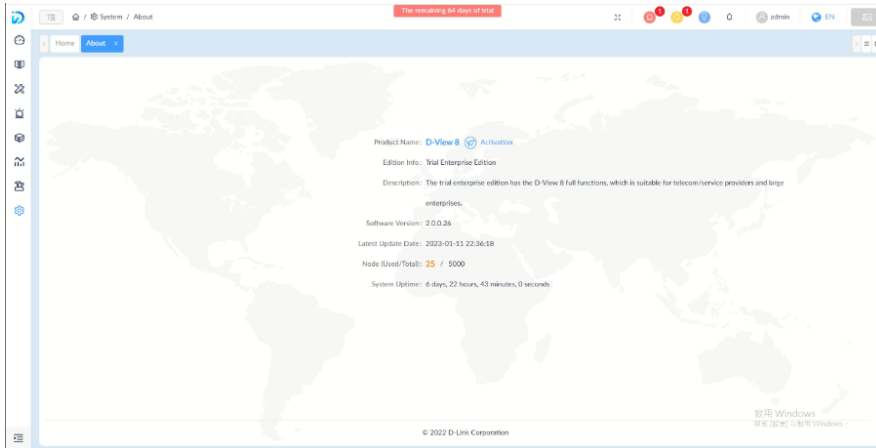

Product and software information is displayed:

Product Name	D-View 8, which indicates the name of the product.
Edition Info	The Standard or Enterprise Edition.
Description	A brief description of the product.
Software Version	The version of the current system software.
Latest Update Date	The date that the system was last updated.
Node (Used/Total)	The number of currently managed nodes/the total nodes allowed
System Uptime	The total number of days, hours, minutes and seconds that the system has been up and running.

The system will prompt you to activate your product with a valid license after the 3-month trial period.

To add a product key:

1. Click the **Activation** link next to D-View 8 displayed as the product name on the **About** page. And you will be directed to the login page to start the product activation process.
2. The **Add License** screen appears. Choose one of the following methods:

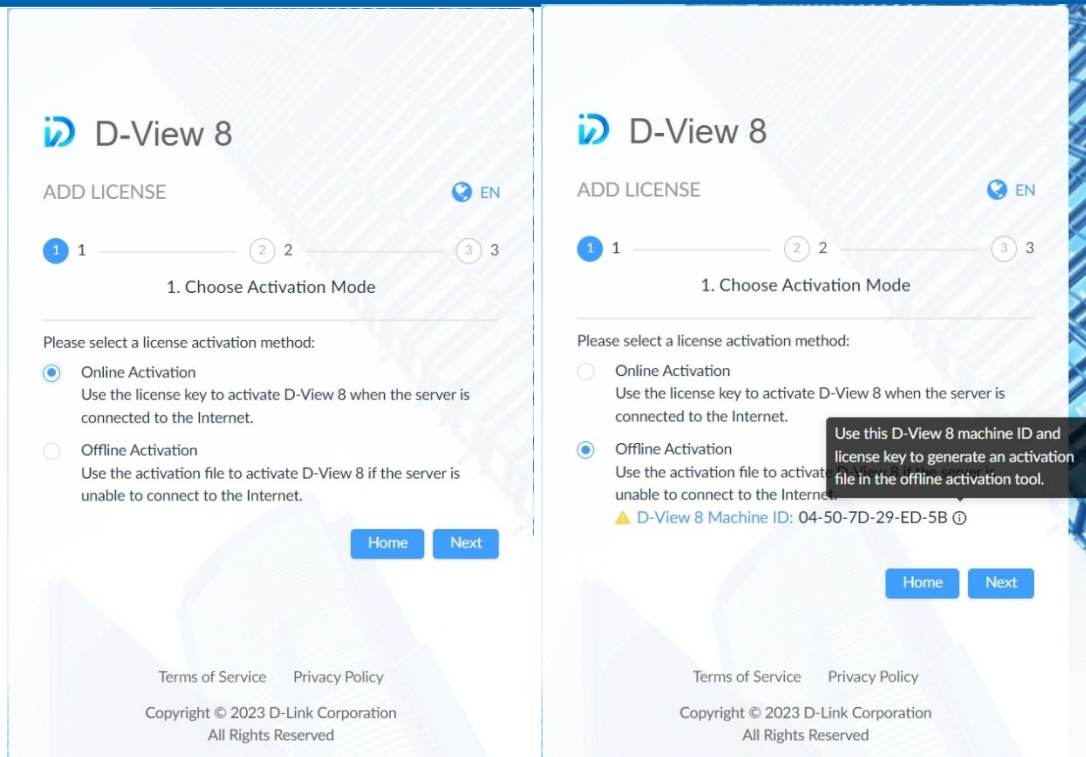

- **Online Activation:** Use a license key to activate D-View 8. The server must be connected to the Internet. Click **Next** to continue and follow the on-screen procedure to complete the process. This method allows you to enter a license key obtained from your sales representative.
- **Offline Activation:** Use an activation file to activate D-View 8. The server does not have to be connected to the Internet. This method allows you to upload an activation file generated from an activation tool.

The offline activation requires the use of an activation tool. Double-click on the executable file to start the program. Select **Standard/Enterprise License** from the License Type drop-down list. Enter the **License Key** (obtained from your sales representative) and the Machine ID of the D-View 8 server for **Bound Machine ID** (the license key associates itself with the server's Machine ID), then click **Browse** to locate the output directory for the activation file. Click **Generate** to generate an activation file.

3. Click Next to continue and follow the instructions on the website to finish the registration process.

To obtain product licenses information:

1. Click the **Maintenance License** link.

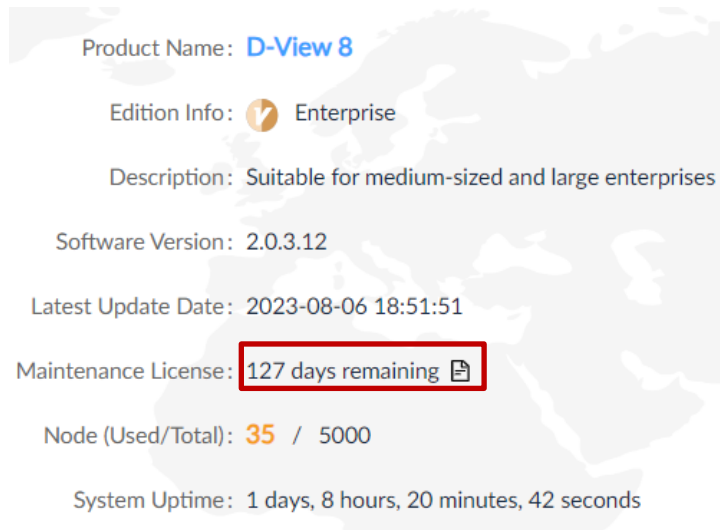

2. The details of product and maintenance licenses are displayed:

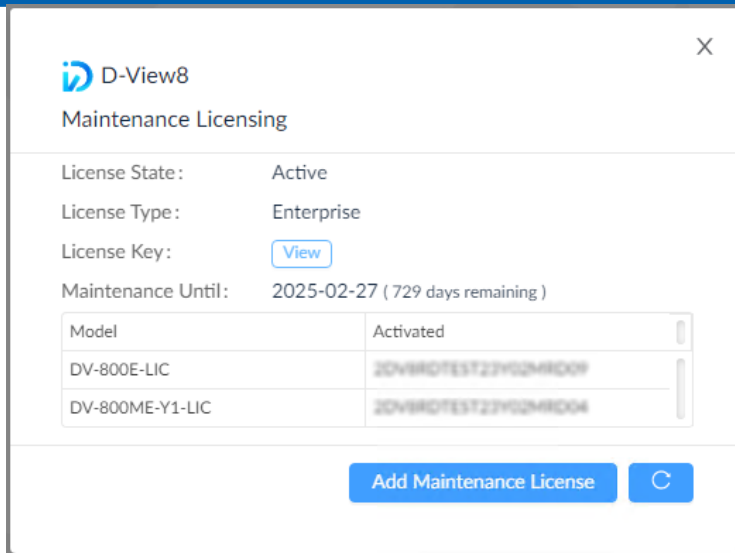

Item	Description
License State	Displays active or inactive status of the product license
License Type	The Standard or Enterprise license type.
License Key	Click to view the license keys purchased.
Maintenance Until	The number of days before the license expires. This can be an aggregated number of days of all licenses purchased.

The system will prompt you to buy a new maintenance license after the 1st year of product activation.

To add a maintenance license:

1. Click **Add Maintenance license**. And you will be directed to the login page to start the license purchasing process:
2. The **Add Annual License** screen appears. Choose one of the following methods:

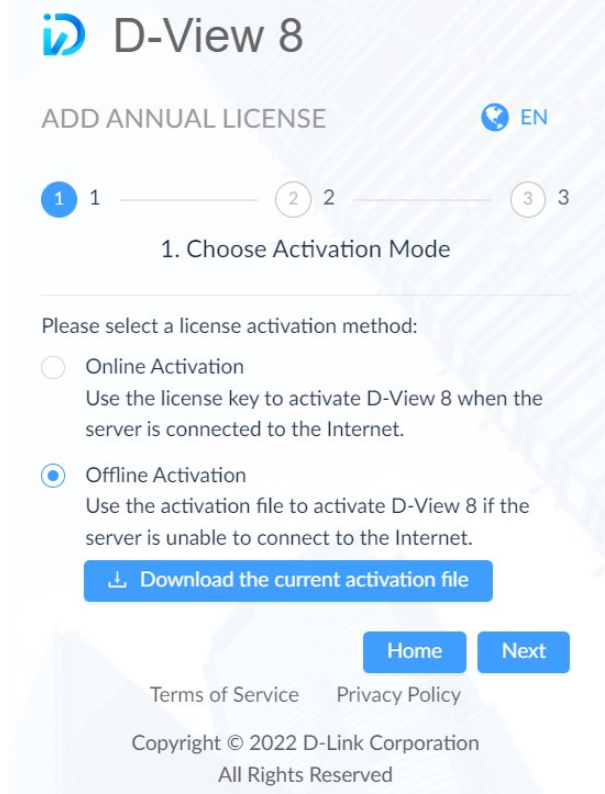

- **Online Activation:** Use a license key to reactivate D-View 8 with maintenance service. The server must be connected to the Internet. Click **Next** to continue and follow the on-screen procedure to complete the process. This method allows you to enter a license key obtained from your sales representative.

- **Offline Activation:** Use an activation file to reactivate D-View 8 with maintenance service. The server does not have to be connected to the Internet. Click **Download the current activation file** to download the activation file to generate a reactivation file.

The offline reactivation requires the use of an activation tool. Double-click on the executable file to start the program. Select **Annual Maintenance License** from the License Type drop-down list. Enter the **License Key** obtained from your sales representative and click **Browse** to locate the current AC file downloaded from the above step. Then click **Generate** to generate a new activation file.

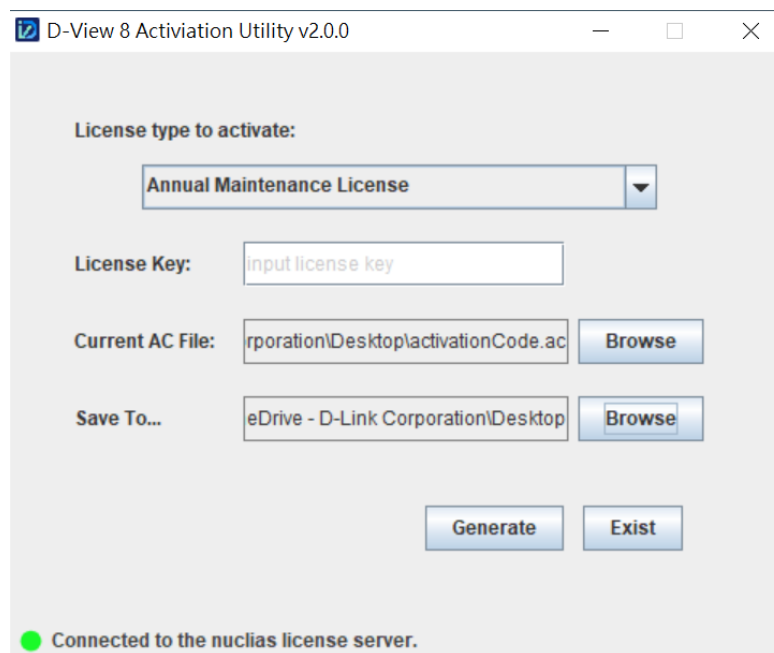

3. Click Next to continue and follow the instructions on the website to finish the registration process.

Note: When the maintenance license is about to expire, the system will inform you of the soon-to-expired license 30 days before the expiration date.

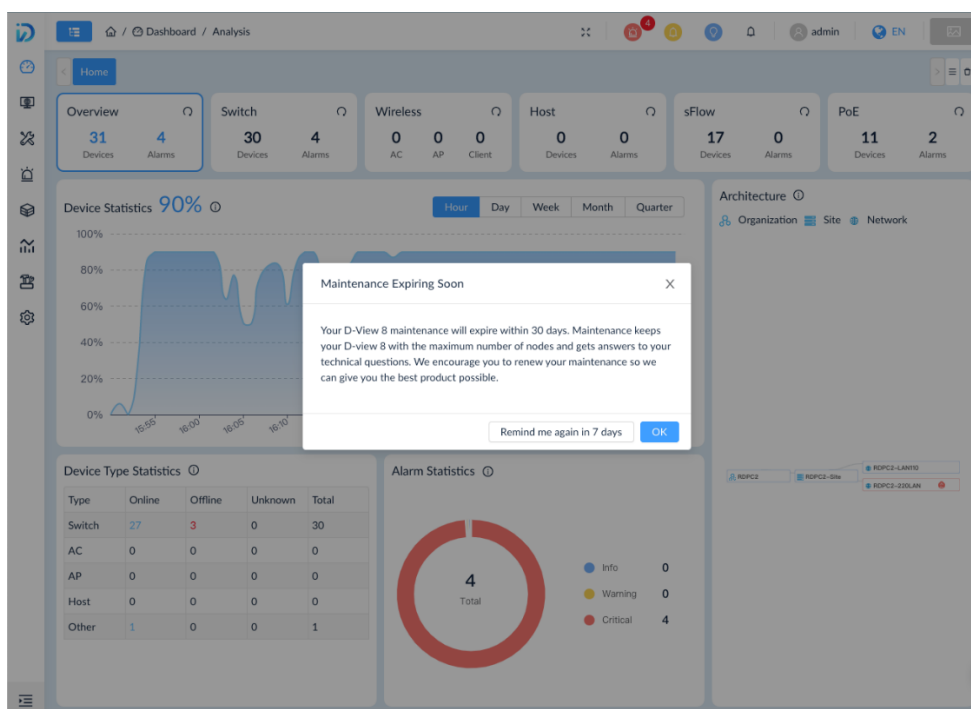

You can opt to be reminded again 7 days before the expiration date. The system will notify you at the appropriate time as shown in the following screen. You can then choose to be reminded again 3 days before the expiration date.

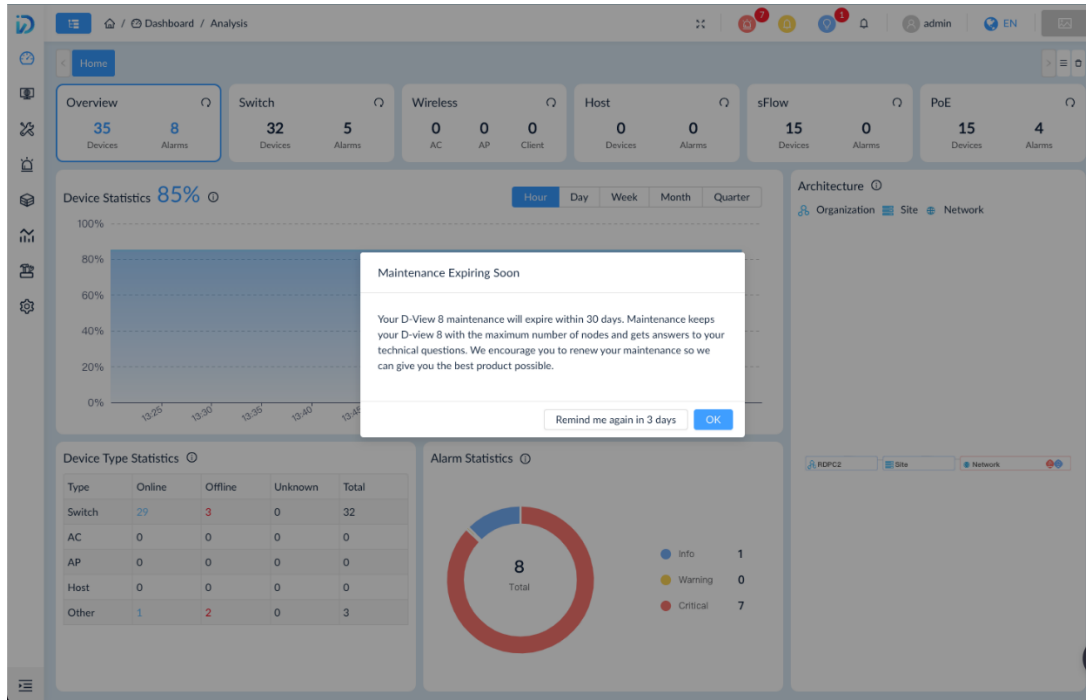

When the maintenance license expired, the system will alert you and the following pages of the D-View 8 web application will display alert messages: **Dashboard > Analysis, Monitoring > Device View, Monitoring > Topology Map, Configuration > Batch Configuration, Configuration > Firmware Management, and Configuration > Configuration Management.**

14.4 View D-View 8 Logs

The D-View 8 Log page displays different types of logs. The User Operation Log tab displays logs related to management operations and tasks performed by users. The System Log displays logs related to activities related to system services and probe agents. The Device Maintenance Log displays logs related to operations performed by users on the managed devices. Logs can be used to analyze device health and troubleshoot network connectivity as well as exam network security. Note that the D-View 8 logs are different from the device syslog, which are logs generated by managed devices (go to **Alarm & Notification > Trap & Syslog**).

Note: You can only view logs pertaining to the activities under your authorized level of network hierarchy.

To view user operation logs, go to **System > D-View 8 Log**. Click the **User Operation Log** tab. The log entries contain the following information:

Item	Description
Log Time	The timestamp of the user activity.
Terminal Type	The device and interface used to connect with the D-View 8 server.
User	Username
Operation Object	The object/menu category that the user operated on.
Detail	The detailed activity of the operation.

To view system logs, go to **System > D-View 8 Log**. Click the **System Log** tab. The log entries contain the following information:

Item	Description
Log Time	The timestamp of the system activity.
Log Type	A brief description of server activity.
Server	The affected server and IP address.
Detail	The detailed information of the server activity.

To view device maintenance logs, go to **System > D-View 8 Log**. Click the **Device Maintenance Log** tab. The log entries contain the following information:

Item	Description
Log Time	The timestamp of the device operation activity.
Result	The result of the device operation.
Configuration Type	The configuration category of the operation.
Function	The detailed information of the configuration.
System Name	The system name of the device.
Model Name	The model name of the device.
IP	The IP address of the device.
User	The username of the operator.
Site	The network site of the device.
Network	The network of the device.

You can filter these logs by time or activity. To create a filter, click **Advanced Query** at the top right. It allows you to specify the activity with timestamp of the log, function, configuration type, system name, IP address, username, etc. After the displayed records are refined according to the desired criteria, you can export it as a csv file.

15 Tools

The D-View 8 has added management effectiveness of your network by offering convenient tools. These tools help troubleshoot network bottlenecks by providing transmission data and responses from nodes where the packets pass.

15.1 MIB Browser

The MIB browser allows you to retrieve SNMP information from supported devices. By polling SNMP-enabled devices, you can obtain device information in readable format with the OID search function. Note that MIB Browser is only supported in Enterprise version.

To select a MIB object and collect SNMP data:

1. Go to **Tools > MIB Browser** to display the MIB Browser page.

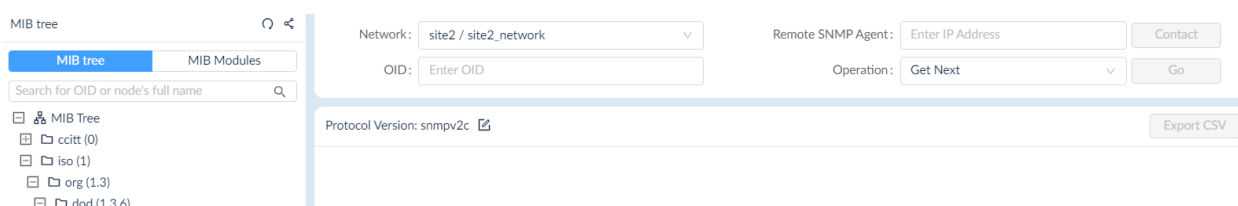

2. Enter SNMP connection parameters:
 - Click the drop-down menu to select the network.
 - Select from the list of managed devices or enter a remote SNMP agent address.
3. Click **Contact** to initiate a connection with a remote SNMP agent.
4. In the MIB tree pane, search for a specific OID by using one of the following methods:
 - Click the MIB tree tab, which contains MIB modules and objects in the hierarchical name space structure, to select a specific object or search for an OID or a node name.
 - Click MIB Modules to select a specific MIB module and node entry or use the search function to search for a MIB module. You can upload and compile your MIB file if it is not in the list (go to **Tools > MIB Compiler**).
 - Click the drop-down menu to select an SNMP function:
 - Get (request) to retrieve a value
 - Get Next (request) to retrieve variables sequentially in a table
 - Get Bulk (request) to fill the response with up to the max-repetition number defined for Get Next requests
 - Walk to perform a sequence of SNMP Get Next operation
 - Table View for tabular objects
 - Instance View to display multiple related object instances
 - Set to set a value for an OID.
5. Click **Go** to start searching the specified object.

After a successful connection, the details for the objects will be displayed.

6. You can download the MIB data to a folder on your desktop in CSV file format. Click **Export CSV** to download.

The SNMP credentials for accessing an OID information can be modified by clicking the SNMP Protocol Preference Edit button  at the top of the result pane.

SNMP Protocol PreferenceX

SNMP Protocol Version: SNMP v1 SNMP v2c SNMP v3

* Port:

* Timeout [s]:

* Retransmit:

Read Community: 

Write Community: 

* Non-Repeaters:

* Max-Repetitions:

15.2 MIB Compiler Tool

The MIB Compiler Tool is only supported in the Enterprise version. The compiler extends the management capability to any SNMP-capable devices. It allows you to add SNMP objects to be discovered and queried in the MIB tree. The MIB Compiler only works with standard or proprietary MIBs but does not accept malformed MIBs.

The compiled MIB module can then be loaded and managed in the MIB browser.

Add MIB Files

You can upload MIB files into the MIB browser.

To add MIB files:

1. Go to **Tools > MIB Compiler**.



The screenshot shows the 'Compiled Modules' page in the MIB Compiler tool. It features a search bar, a refresh button, a download button, and a 'Compile Selected Items' button. Below these is a table with the following data:

Module Identity	File Name	Dependencies	Update Time	Operation
DLINKPV2-DEVICE-INFORMATION-MIB	DLINKPV2-DEVICE-INFORMATION-MIB.mib	SNMPV2-SMI,SNMPV2-TC,SNMPV2-CONF,INET-AD...	2023-04-21 10:59:26	[Refresh] [Delete]
DLINKPV2-POE-MIB	DLINKPV2-POE-MIB.mib	SNMPV2-CONF,SNMPV2-SMI,SNMPV2-TC,INET-AD...	2023-04-21 10:59:26	[Refresh] [Delete]
DLINKPV2-LLDP-EXT-MIB	DLINKPV2-LLDP-EXT-MIB.mib	SNMPV2-SMI,SNMPV2-CONF,SNMPV2-TC,SNMP-F...	2023-04-21 10:59:26	[Refresh] [Delete]

At the bottom right, it indicates 'Total 3 items' and '100 / page'.

2. On the **Compile Page** tab, click Upload MIB files  to select a file(s) to upload.
3. The Upload MIB files page displays. Click **Select Files** to upload MIB files or click **Select Directory** to select all the files under the selected folder.

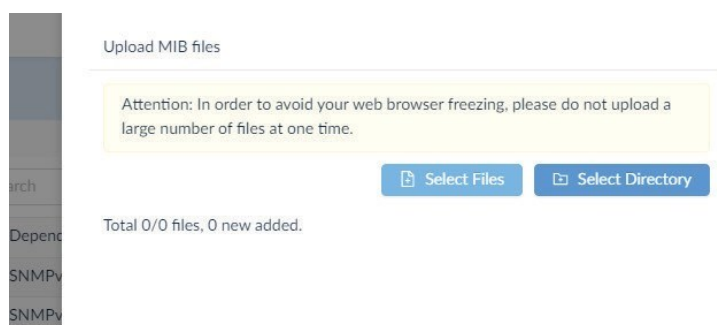

4. The selection is detailed to show the upload status.

Compile MIB Files

You can compile MIB files in the uploaded list to make them available in the MIB browser.

To compile MIB files:

1. Go to **Tools > MIB Compiler** to display the MIB **Compile Page**.
2. In the Compile Page, select a file from the list and click **Compile Selected Items**.

The status of the MIB file will also be updated.

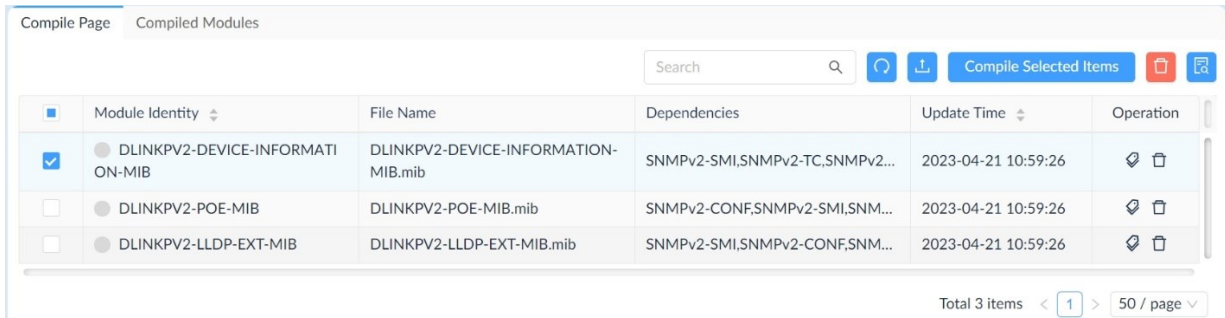

<input type="checkbox"/>	Module Identity	File Name	Dependencies	Update Time	Operation
<input checked="" type="checkbox"/>	<input type="radio"/> DLINKPV2-DEVICE-INFORMATION-MIB	DLINKPV2-DEVICE-INFORMATION-MIB.mib	SNMPv2-SMI,SNMPv2-TC,SNMPv2...	2023-04-21 10:59:26	
<input type="checkbox"/>	<input type="radio"/> DLINKPV2-POE-MIB	DLINKPV2-POE-MIB.mib	SNMPv2-CONF,SNMPv2-SMI,SNM...	2023-04-21 10:59:26	
<input type="checkbox"/>	<input type="radio"/> DLINKPV2-LLDP-EXT-MIB	DLINKPV2-LLDP-EXT-MIB.mib	SNMPv2-SMI,SNMPv2-CONF,SNM...	2023-04-21 10:59:26	

Total 3 items < 1 > 50 / page

If a MIB is successfully compiled, it will be listed under **Compiled Modules** and can be accessed in the **MIB Browser**.

15.3 Perform an ICMP Ping

You can use Ping to diagnose the connectivity between two network devices.

To test a device with the Ping command:

1. Go to **Tools > ICMP Ping** to display the ICMP Ping page.

The screenshot shows the ICMP Ping tool interface. On the left, the configuration pane is set to: Device Hierarchy: site_sim, Shanghai_Finance; IP Address/Host Name: 172.18.190.95; Ping Times: 5. A 'Ping' button is visible. On the right, the 'Ping Result' section shows a line graph with five data points, all at 0ms, indicating a failure. Below the graph is a table titled 'Ping 172.18.190.95' with the following data:

Times	Roundrip(ms)	IP Address/Host Name
1	Time Out	172.18.190.95
2	Time Out	172.18.190.95
3	Time Out	172.18.190.95
4	Time Out	172.18.190.95
5	Time Out	172.18.190.95

2. In the ICMP Ping pane, enter the following information to initiate a ping test:
 - Device Hierarchy: click the drop-down menu to select site and network.
 - Enter the destination host.
 - Enter the number of times (1 to 10) to perform the ping test. The default is 5.
 - Enter the packet size (in bytes) for the echo request messages. The default is 32.
3. Click **Ping** to initiate the test.

The Ping Result will be displayed on the right:

The screenshot shows the ICMP Ping tool interface with a successful test. Configuration: Device Hierarchy: site2, test; IP/Host Name: 192.168.10.210; Ping Times: 5; Ping Packet Size: 32. The 'Ping' button is highlighted. The 'Ping Result' section shows a line graph with five data points, all at 1ms. Below the graph is a table titled 'Ping 192.168.10.210' with the following data:

Times	Packet Size	Roundtrip (ms)	IP/Host Name
1	32	3	192.168.10.210
2	32	1	192.168.10.210
3	32	1	192.168.10.210
4	32	1	192.168.10.210
5	32	1	192.168.10.210

15.4 Perform an SNMP Test

SNMP lets administrators monitor discovered devices, allowing them to solve network problems and identify system health issues. For SNMP Version 1 (SNMPv1), SNMP Version 2c (SNMPv2c) test, you need to specify an SNMP community string. For SNMP Version 3 (SNMPv3), you need to specify username and authentication and encryption (or privacy) settings.

To test a device with SNMP communication:

1. Go to **Tools > SNMP Test** to display the SNMP Parameters page.

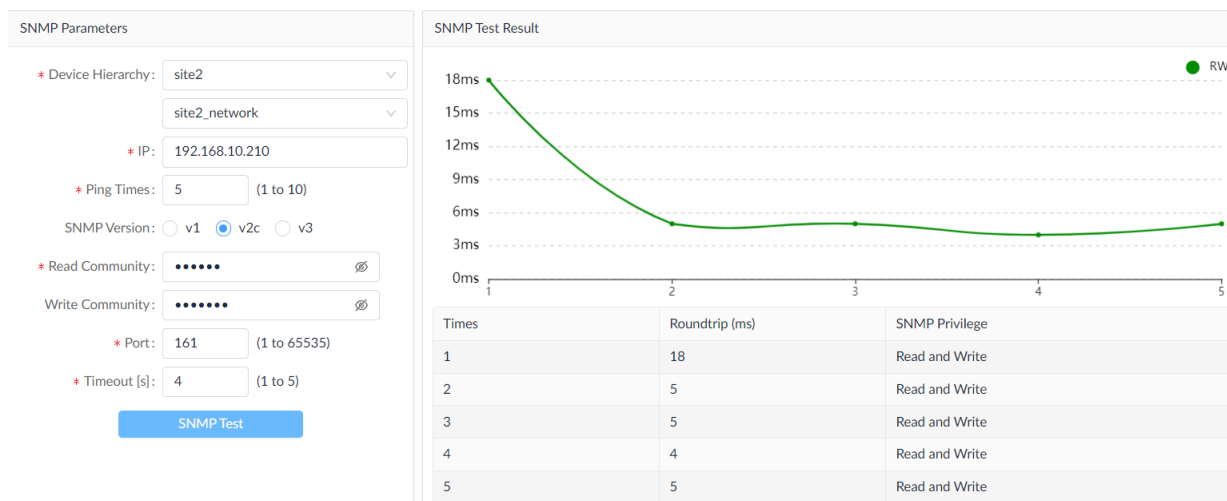

2. From the SNMP Parameters column, enter the following information to initiate an SNMP trap test:

Item	Description
Device Hierarchy	Click the drop-down menu to select the site and network of the device for SNMP test.
IP	Enter the device's IP address.
Ping Times	Enter the number of times (1 to 10) to perform the ping test.
SNMP Version	Select the SNMP version: v1, v2c, or v3.
Non-Repeaters (for v3 only)	Enter the number of objects that can return in a single get-next instance.
Max-Repetitions (for v3 only)	Enter the number of Get Next operations to be performed on each variable.
Username (for v3 only)	Enter the username for SNMP v3 requirement.
Context Name (for v3 only)	Enter the context name for SNMP v3 if it is used. It defines a named subset of the object instances in the MIB with access control.
Security Level (for v3 only)	Select whether authentication and privacy will be required and select the method accordingly. If authentication is used, enter the appropriate authentication parameters: protocol (MD5 or SHA) and password. If privacy is used, enter the appropriate privacy parameters (DES or AES) and password.
Read Community (for v1 and v2c only)	Specify the read community string.
Write Community (for v1 and v2c only)	Specify the write community string.
Port	Enter the Port number of the target device (1 to 65535, default: 161).
Timeout(s)	Enter the timeout (1 to 5, default: 4) value in seconds.
SNMP Test	Click SNMP Test to initiate the test.

3. Click **SNMP Test** to initiate the test.

The SNMP Test Result will be displayed:

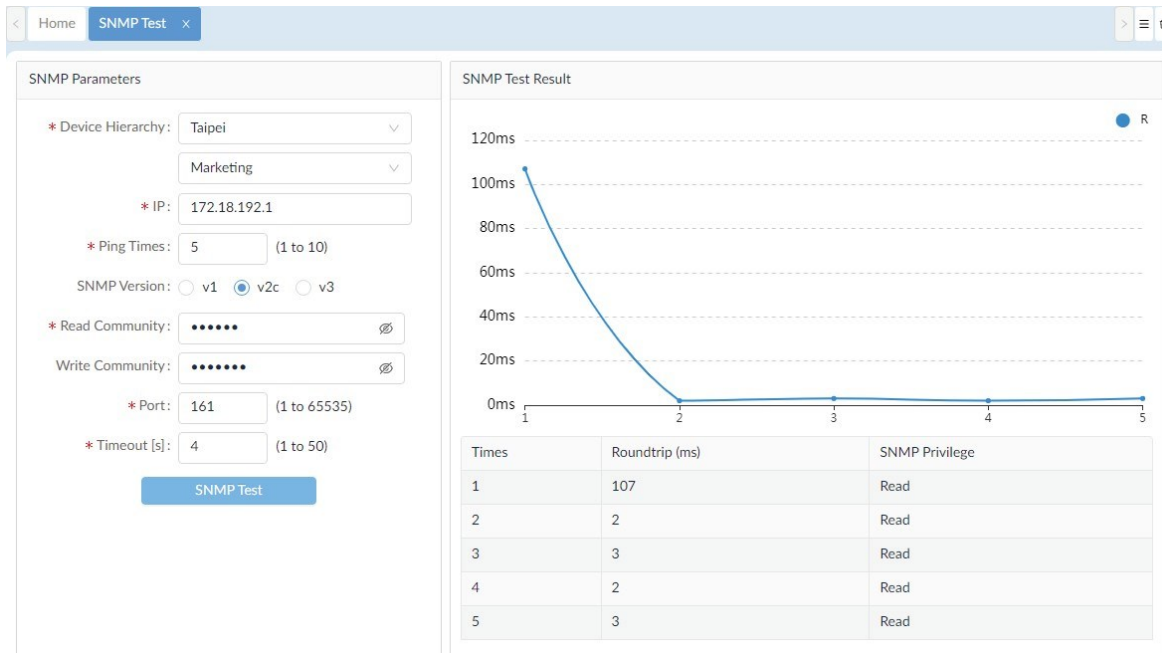

15.5 Perform a Trace Route Test

Trace route test diagnoses the path from one device to another.

To test a device by sending a trace route request:

1. Go to **Tools >Trace Route** to display the Trace Route page.

The screenshot shows the 'Trace Route' page in a web interface. On the left, there is a configuration panel with the following fields:

- Device Hierarchy:** 'Site' and 'Network' dropdown menus.
- IP/Host Name:** A text input field with the placeholder 'Enter IP or Host Name.'
- Maximum Hops:** A numeric input field set to '3' with a range '(1 to 15)'.
- A blue 'Trace' button with a refresh icon.

On the right, the 'Route Result' section is empty, displaying a 'No Data' message with a printer icon and a speech bubble.

2. In the Trace Route pane, enter the following information to initiate a trace route test:
 - Device Hierarchy: click the drop-down menu to select site and network.
 - Enter the destination host.
 - Enter the maximum number of routers that a trace route packet can pass (1 to 15).
3. Click **Trace** to initiate the test.
4. The Route Result displays as follows:

The screenshot shows the 'Trace Route' page after a successful test. The configuration panel on the left is updated with:

- Device Hierarchy:** 'Taipei' and 'Marketing' selected in the dropdowns.
- IP/Host Name:** '172.18.192.1' entered in the text field.
- Maximum Hops:** '10' entered in the numeric field.

The 'Route Result' section now displays a green server icon with the text '172.18.192.1 Roundtrip (ms): 1 ms'.

Below the icon is a table showing the trace route results:

Hops	Roundtrip (ms)	IP
1	1	172.18.192.1

15.6 Configure Network Management from CLI

The D-View 8 interface is designed with access through command line interface for network configuration and management.

To add a new session:

1. Go to **Tools > CLI** to display the Session List page.
2. In the Session List pane, click **Add New Session**.



3. The Add New Session page displays.

Add New Session
✕

* Session Name:

* Site: ▾

* Network: ▾

IP/Host Name:

Protocol: ▾

* Port:

Username:

Password:

4. Enter the following information to configure a CLI connection:

Item	Description
Session Name	Enter a name to define the CLI connection.
Site	Click the drop-down menu to select the desired site.
Network	Click the drop-down menu to select the desired network.
IP/Host Name	Enter the IP address or host name of the device to connect to.
Protocol	Click the drop-down menu to select the access protocol (SSH/Telnet).
Port	Enter the port number for the respective service (Telnet or SSH).
Username	Enter a username with authority to access the device.

Password	Enter the password of the user account.
Cancel	Click to Cancel the session entry.
Connect	Click Connect to start the session.

5. Click **Connect** to start the connection. Click **Cancel** to cancel the connection request. The CLI Connection will be listed in the Session and open in the connection pane.

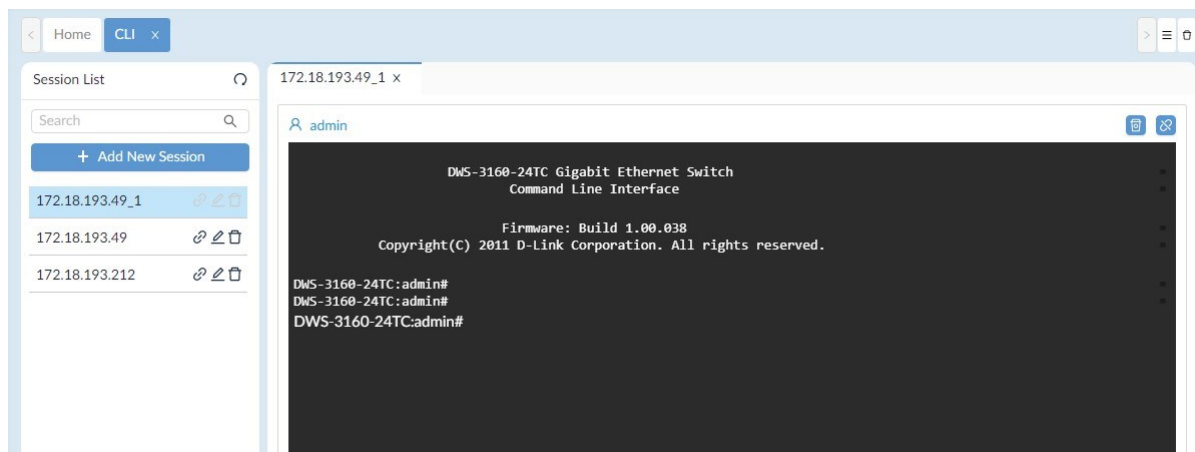

6. For each connection setting, you can modify or remove it from the connection list, click on the available options.



- Connect: initiate a connection
- Edit: modify the settings
- Delete: remove the entry from the list

15.7 Compare Configuration Files

The File Comparison tool provides the function to compare two configuration files. Only text-based files can be compared.

To compare two files:

1. Go to **Tools > File Comparison**.

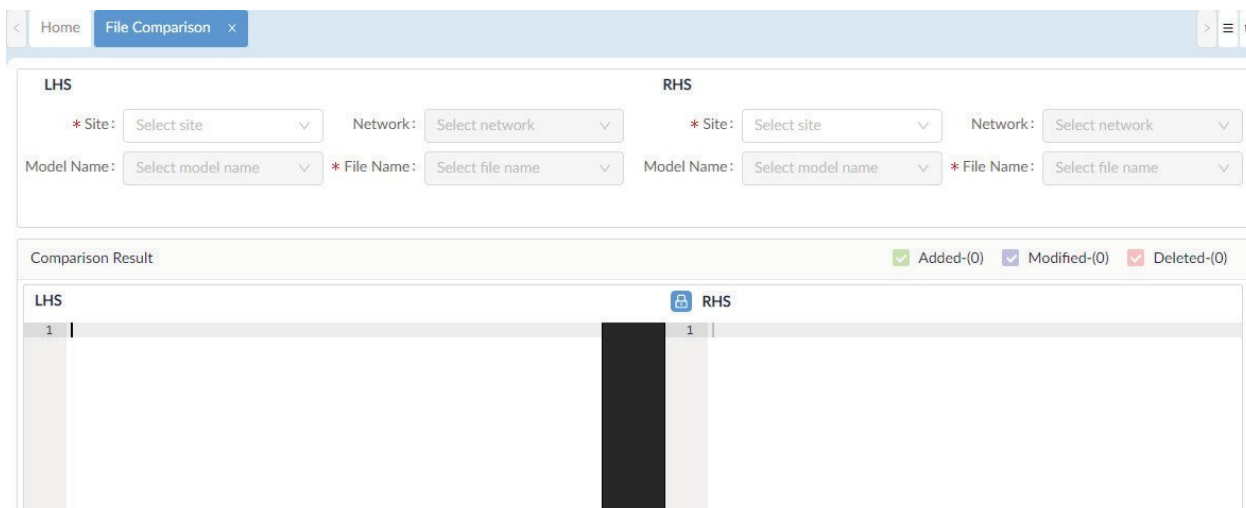

2. Select two configuration files by specifying the device's site, network and device model to start comparing.

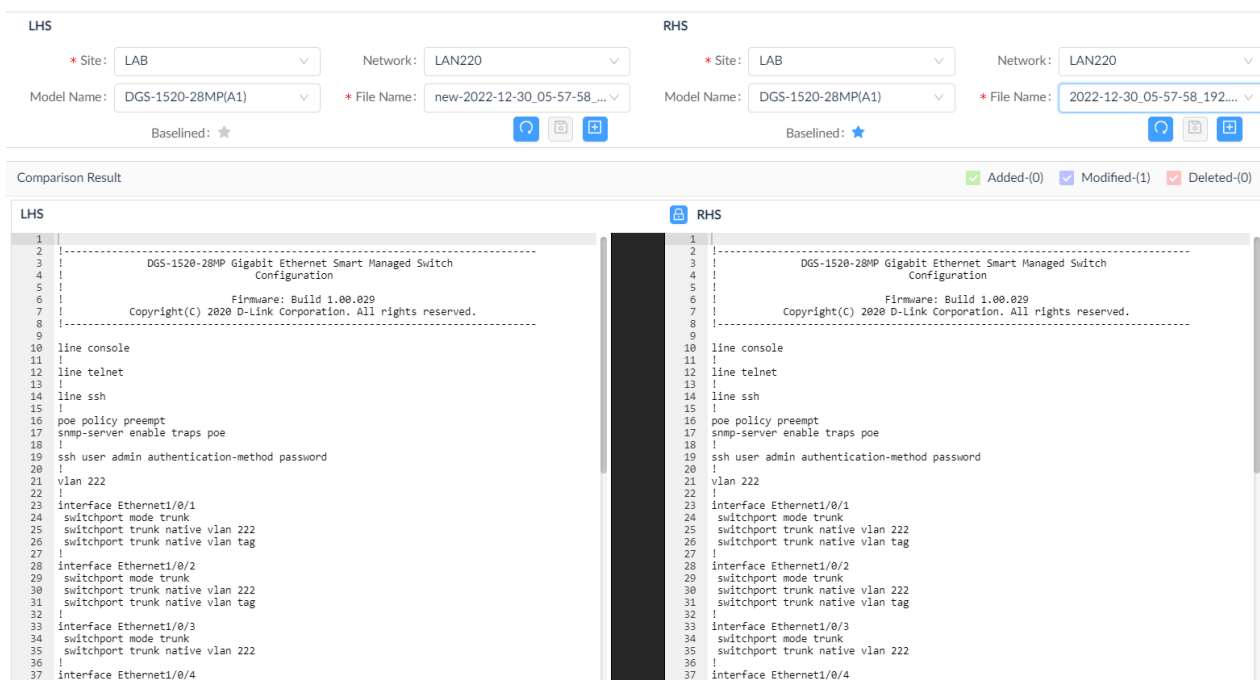

3. The comparison result will be shown with the difference: added text in green, modified text in purple, and deleted text in red.
4. You can directly modify the file and save it as a new configuration file to upload to the server. Go to **Configuration > File Management** for the list of all uploaded configuration and firmware files.
5. The **Restore to Device** function allows you to schedule a restoration job using the currently displayed file. Go to **Configuration > Configuration Management > Restore** for the list of all restoration jobs.

Appendix A: Deployment with Five-server Topology

The D-View 8 can be deployed in server cluster in three-server or five-server topology. This section illustrates the structure and the deployment procedure of the 5-server topology.

Structure

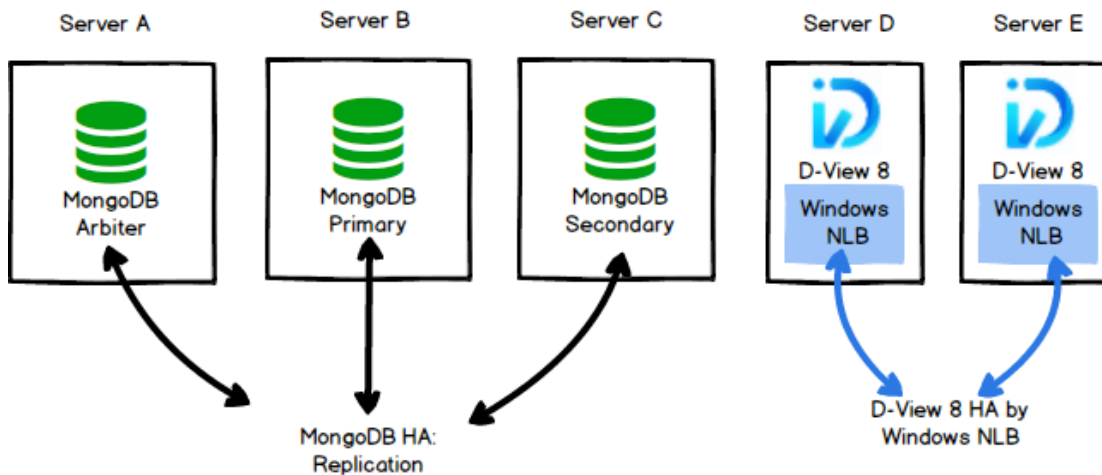

Preparation for five-server deployment:

When planning for server cluster deployment, you must first set up 5 Windows servers with the following system configuration:

- SERVER A
 - OS: Windows 10, Windows Server 2016/ Windows Server 2019
 - MongoDB
 - IP Address: 192.168.1.205
 - Replica set role: arbiter

- SERVER B
 - OS: Windows 10, Windows Server 2016/ Windows Server 2019
 - MongoDB
 - IP Address: 192.168.1.203
 - Replica set Role: primary

- SERVER C
 - OS: Windows 10, Windows Server 2016/ Windows Server 2019
 - MongoDB

IP Address: 192.168.1.204

Replica set Role: secondary

- SERVER D

OS: Windows Server 2016/ Windows Server 2019

D-View 8

IP Address: 192.168.1.201

NLB enabled with virtual IP: 192.168.1.200

- SERVER E

OS: Windows Server 2016/ Windows Server 2019

D-View 8

IP Address: 192.168.1.202

NLB enabled with virtual IP: 192.168.1.200

Data Redundancy Support on the MongoDB Server Cluster

This section details the steps to install the required MongoDB databases and enable data redundancy in the database cluster.

MongoDB Cluster Installation

To install MongoDB in the database cluster:

1. Obtain the D-View 8 MongoDB installation package (e.g. D-View 8 MongoDB_1.0.0.70_Installation.exe).
2. Install the package on three servers, A, B, and C.
3. On the Connection Configuration page, select **Replication** in the MongoDB Type drop-down menu.
4. Enter the MongoDB port number for server communication.

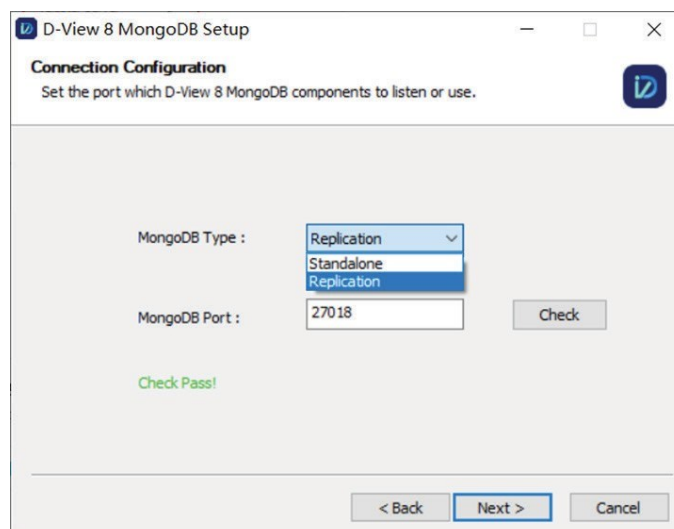

5. Click **Check** to test the setting. If it is configured correctly, a **Check Pass!** notification displays. If the test fails,

verify the port setting and try again.

- Click **Next** to continue and the installation should start.

D-View 8 Installation

Use the following procedure to install D-View 8 on additional servers (e.g. server D & E) other than the database servers and connect them to the MongoDB cluster.

Perform the following procedure to install D-View 8 on server D and E.

Installation on server D

- Obtain the installation package (e.g. D-View 8_1.0.0.70_Installation.exe).
- Install the package.
- In the Port Configuration page, select **Replication** in the MongoDB Type menu.
- In the Server IP field, enter the host server's IP address. As for our example, 192.168.1.201.
- For port settings, enter the port number required for web access, core communication, and probe communication: 17300, 17500, and 17600.
- Click **Check** to test the settings. If configured correctly, a **Check Pass!** notification displays. If the test fails, verify the port settings and try again.
- Click **Next** to continue

D-View 8 1.0.0.70 Setup

Port Configuration
Set the ports which D-View 8 components to listen.

D-View 8 will listen the following ports. Click Next to continue.

MongoDB Type : Replication

Server IP: 192.168.1.201 Check Pass!

Web Port: 17300 Check Pass!

Core Port: 17500 Check Pass!

Probe Port: 17600 Check Pass!

< Back

- The MongoDB Database Configuration page displays. Enter IP addresses and port number for the database servers designated with the respective Replica Roles. Click Check to test the settings. If configured correctly, a **Check Pass!** notification displays. If the test fails, verify the port settings and try again.

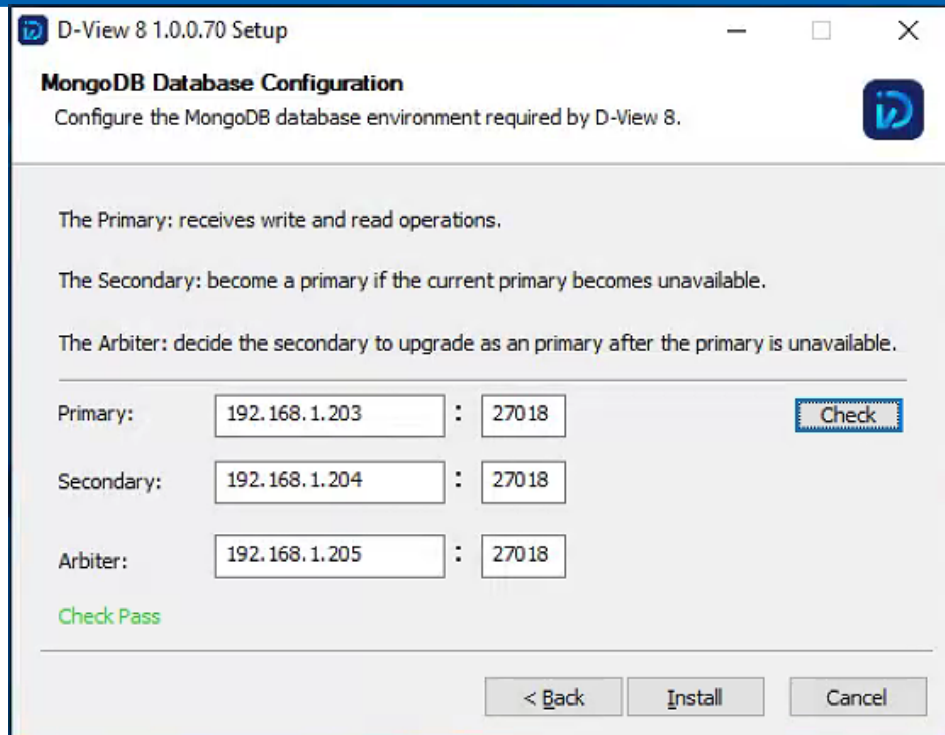

13. Click **Install** to continue.
14. Once the installation completes, click **Finish** to close the Setup Wizard.
15. The D-View 8 Server can be accessed from a web browser on the server.

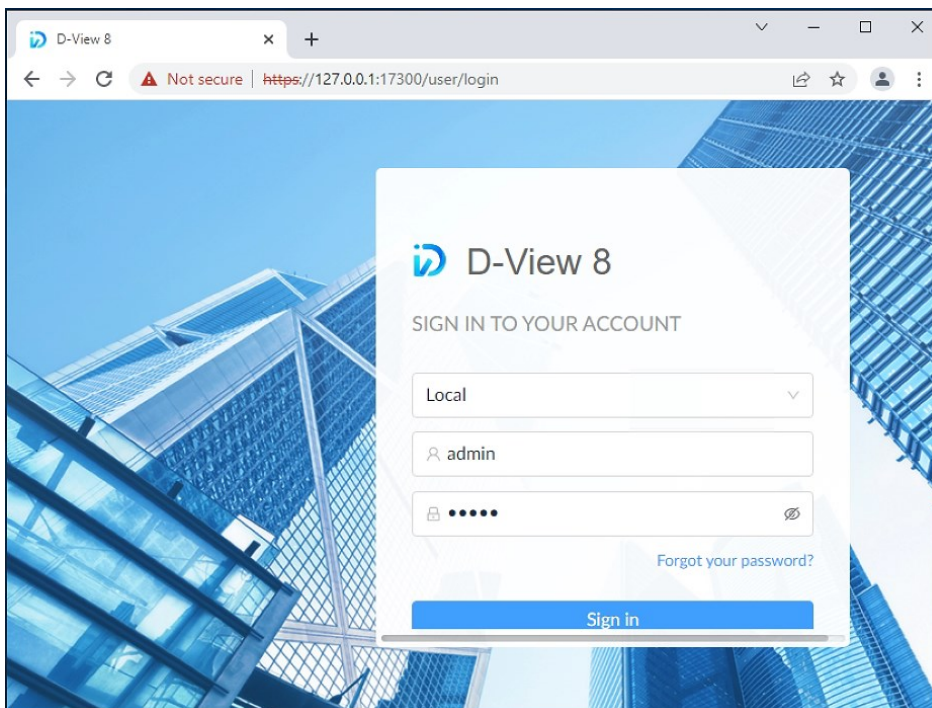

Installation on server E

1. Start the Installation package.
2. In the Port Configuration page, select **Replication** in the MongoDB Type menu.
3. In the Server IP field, enter the host server's IP address. As for our example, 192.168.1.202.
4. For port settings, enter the port number required for web access, core communication, and probe communication: 17300, 17500, and 17600.
5. Click **Check** to test the settings. If configured correctly, a **Check Pass!** notification displays. If the test fails, verify the port settings and try again.
6. Click **Next** to continue

D-View 8 1.0.0.70 Setup

Port Configuration
Set the ports which D-View 8 components to listen.

D-View 8 will listen the following ports. Click Next to continue.

MongoDB Type : Replication

Server IP: 192.168.1.202 Check Pass!

Web Port: 17300 Check Pass!

Core Port: 17500 Check Pass!

Probe Port: 17600 Check Pass!

< Back

9. The MongoDB Database Configuration page displays. Enter IP addresses and port number for the database servers designated with the respective Replica Roles. Click Check to test the settings. If configured correctly, a **Check Pass!** notification displays. If the test fails, verify the port settings and try again.

D-View 8 1.0.0.70 Setup

MongoDB Database Configuration
Configure the MongoDB database environment required by D-View 8.

The Primary: receives write and read operations.

The Secondary: become a primary if the current primary becomes unavailable.

The Arbiter: decide the secondary to upgrade as an primary after the primary is unavailable.

Primary: 192.168.1.203 : 27018

Secondary: 192.168.1.204 : 27018

Arbiter: 192.168.1.205 : 27018

Check Pass

< Back Cancel

10. After the installation, the D-View 8 Server can be accessed from a web browser on the server.

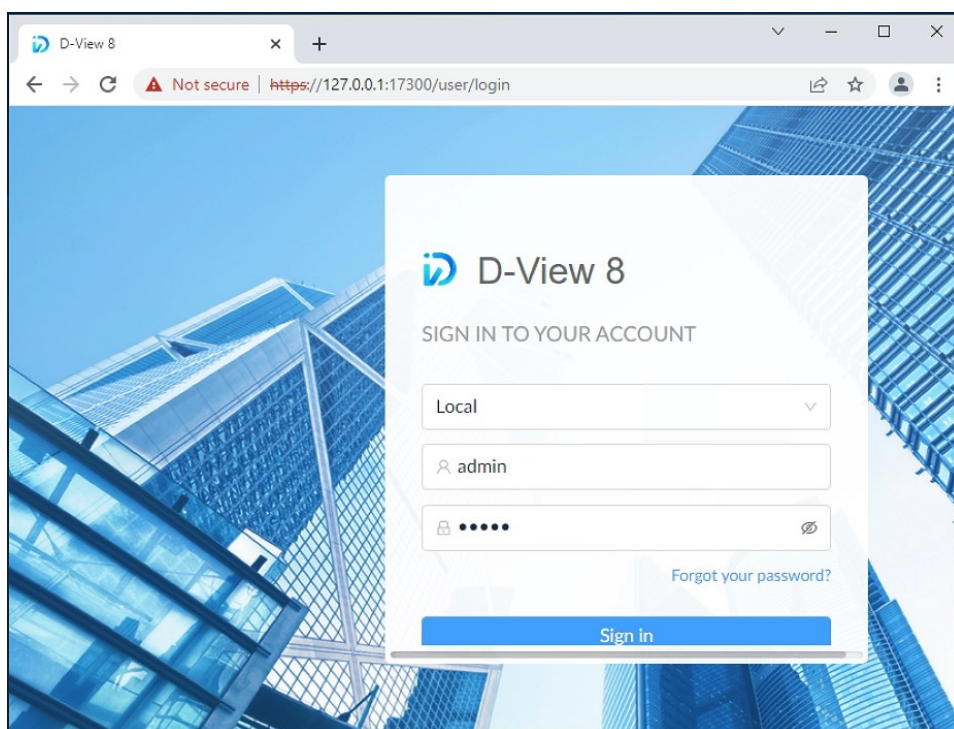

Network Load Balancing Setup on D-View 8 Servers

Server load balancing is supported on D-View 8. At least two Windows servers on the same subnet will be required to configure load balancing. For our deployment demonstration of five-server topology, use the following procedure to set up NLB on D-View 8 servers.

To set up NLB on server D & E:

1. Install the Network Load Balancing service on both server D & E.

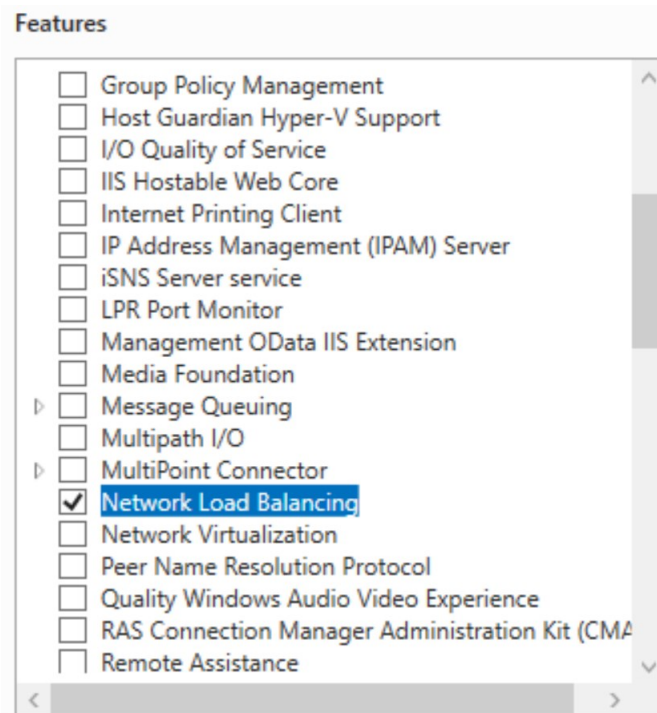

2. Start Network Load Balancing Manager on both servers. Then use the following procedure to configure them individually.

Configuration on server D

3. In NLB Manager, click **Cluster > New** to create a new cluster.

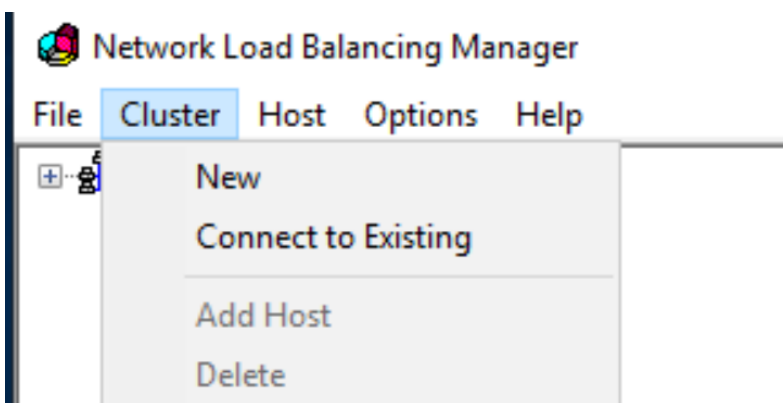

- In the Host field, enter the IP address of SERVER D: 192.168.1.201 and click the **Connect** button.

New Cluster : Connect

Connect to one host that is to be part of the new cluster and select the cluster interface

Host:

Connection status
Connected

Interfaces available for configuring a new cluster

Interface name	Interface IP
Ethernet0	192.168.1.201

< Back

- Click **Next** to continue. The New Cluster: Host Parameters page displays.

New Cluster : Host Parameters

Priority (unique host identifier):

Dedicated IP addresses

IP address	Subnet mask
192.168.1.201	255.255.255.0

Add... Edit... Remove

Initial host state
Default state:

Retain suspended state after computer restarts

< Back

- Click **Next** to continue. The New Cluster: Cluster IP Addresses page displays.
- Click **Add** to enter the cluster IP address.

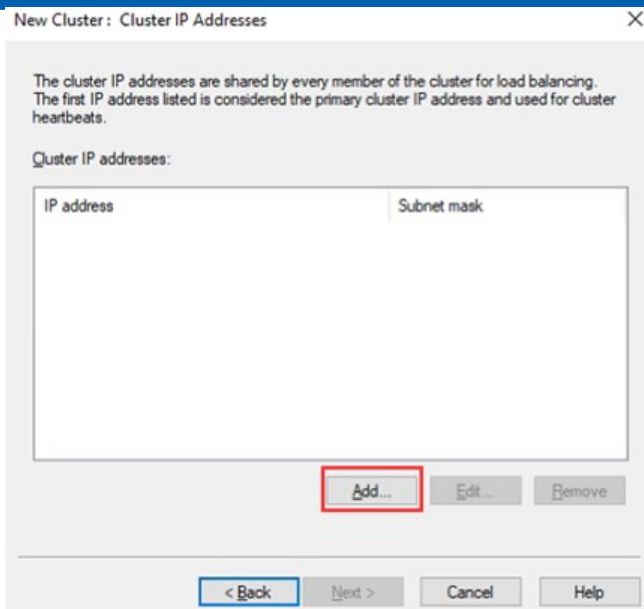

8. Enter a virtual IP and subnet mask that will be used as the Cluster IP and netmask. Then click **OK** to continue.

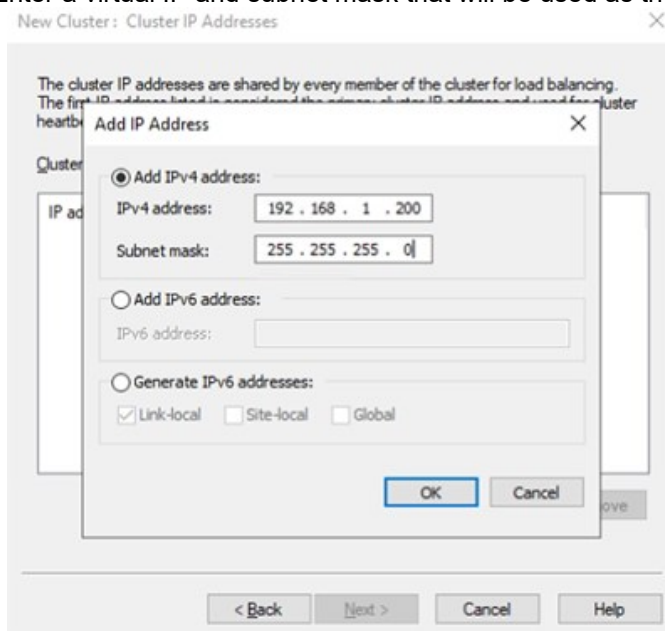

9. Select **Multicast** for **Cluster Operation Mode** for optimal performance.

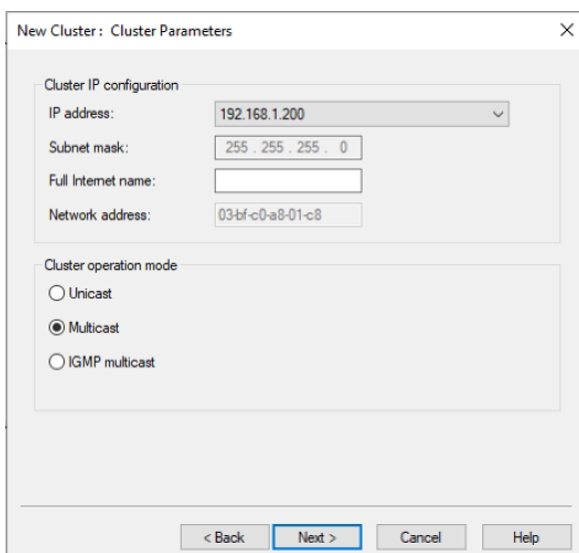

10. Click **Next** to continue. The Port Rules page displays.

New Cluster: Port Rules X

Defined port rules:

Cluster IP address	Start	End	Prot...	Mode	Priority	Load	Affinity
All	0	65535	Both	Multiple	-	-	Single

Port rule description

TCP and UDP traffic directed to any cluster IP address that arrives on ports 0 through 65535 is balanced across multiple members of the cluster according to the load weight of each member. Client IP addresses are used to assign client connections to a specific cluster host.

11. Select the defined port rule and click **Edit**. The Add/Edit Port Rule page displays.

Add/Edit Port Rule X

Cluster IP address

or All

Port range

From: To:

Protocols

TCP UDP Both

Filtering mode

Multiple host Affinity: None Single Network

Timeout (in minutes):

Single host

Disable this port range

12. In the Filtering mode section, Select **Multiple host** for **Filtering mode** and **None** for **Affinity**. Then click **OK** to continue.

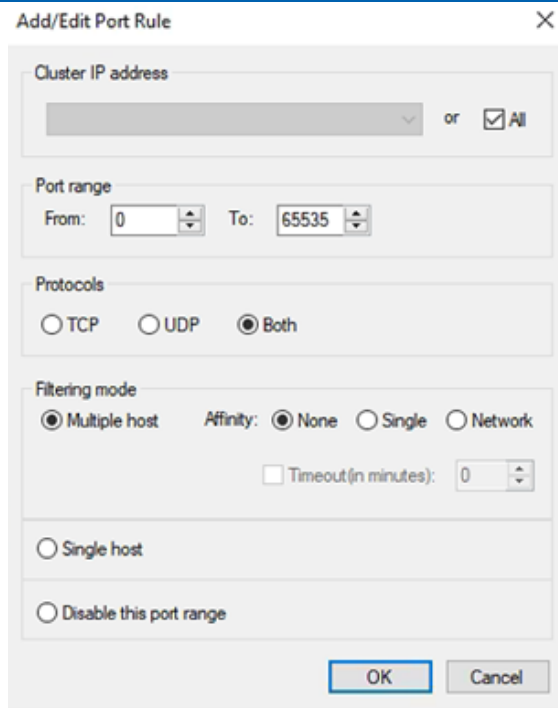

13. An NLB cluster will be created as shown below.

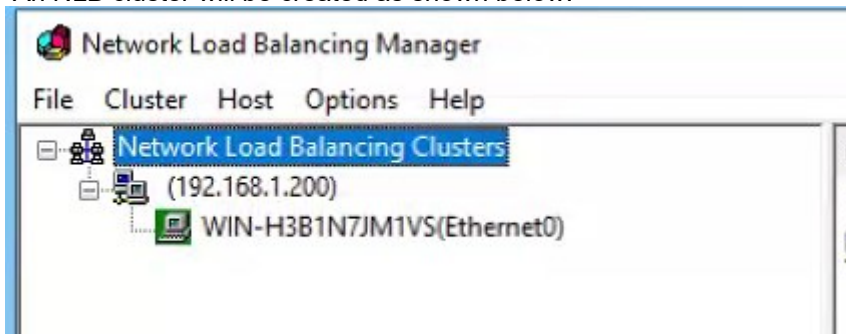

14. Add SERVER E to this cluster: Right-click the cluster node and click **Add Host To Cluster**.

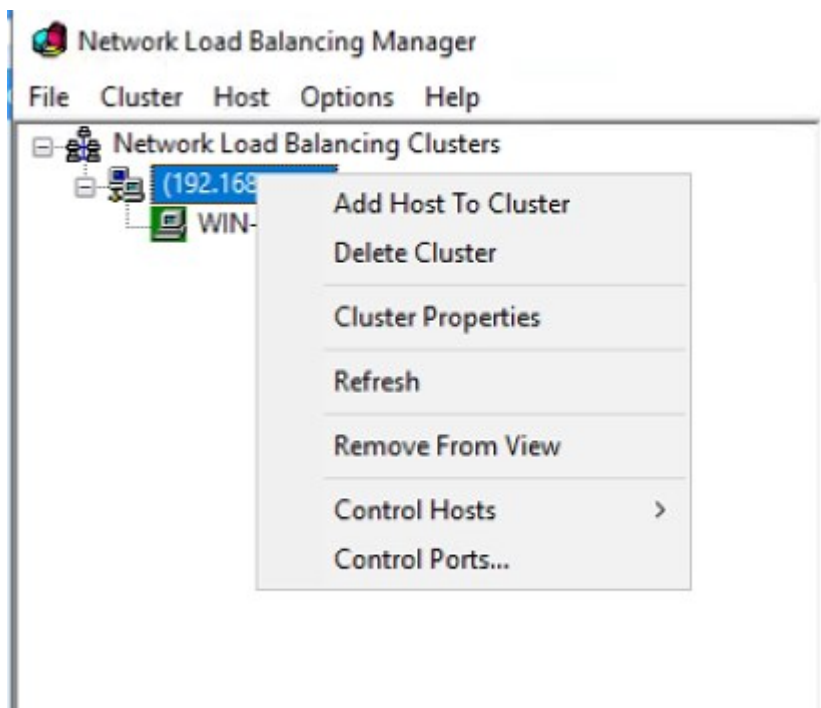

15. Input the SERVER E's IP address: 192.168.1.202, then click **Connect**.

The screenshot shows a dialog box titled "Add Host to Cluster: Connect". It contains the following elements:

- A text box for "Host:" containing "192.168.1.202" and a "Connect" button.
- A "Connection status" section showing "Connected".
- A section titled "Interfaces available for configuring the cluster" containing a table:

Interface name	Interface IP
Ethernet0	192.168.1.202

At the bottom of the dialog are four buttons: "< Back", "Next >", "Cancel", and "Help". The "Next >" button is highlighted with a blue border.

16. Click **Next** to continue.

The screenshot shows a dialog box titled "Add Host to Cluster: Host Parameters". It contains the following elements:

- A "Priority (unique host identifier):" dropdown menu set to "2".
- A "Dedicated IP addresses" section containing a table:

IP address	Subnet mask
192.168.1.202	255.255.255.0

Below the table are three buttons: "Add...", "Edit...", and "Remove".

- An "Initial host state" section containing a "Default state:" dropdown menu set to "Started" and an unchecked checkbox labeled "Retain suspended state after computer restarts".

At the bottom of the dialog are four buttons: "< Back", "Next >", "Cancel", and "Help". The "Next >" button is highlighted with a blue border.

17. Click **Finish** to close the screen.

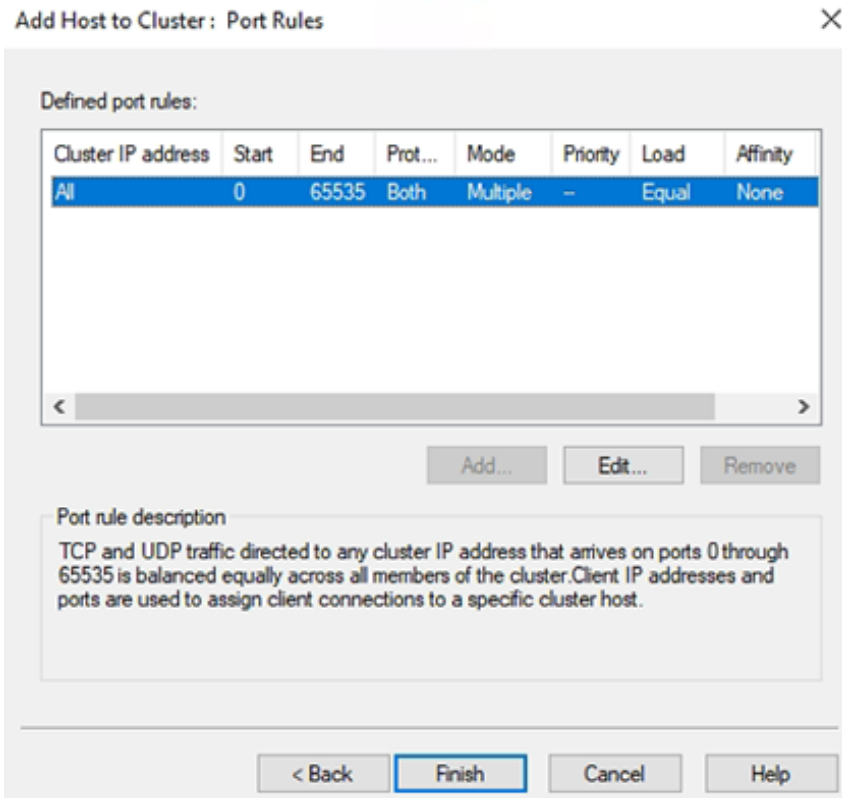

18. Open the Network Load Balancing Manager. Now a cluster containing both server D and E was created. And the D-View 8 can be accessed with the cluster IP.

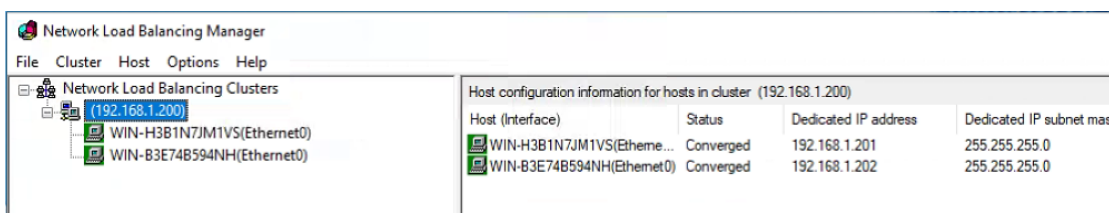

And the D-View 8 can be accessed with the cluster IP.

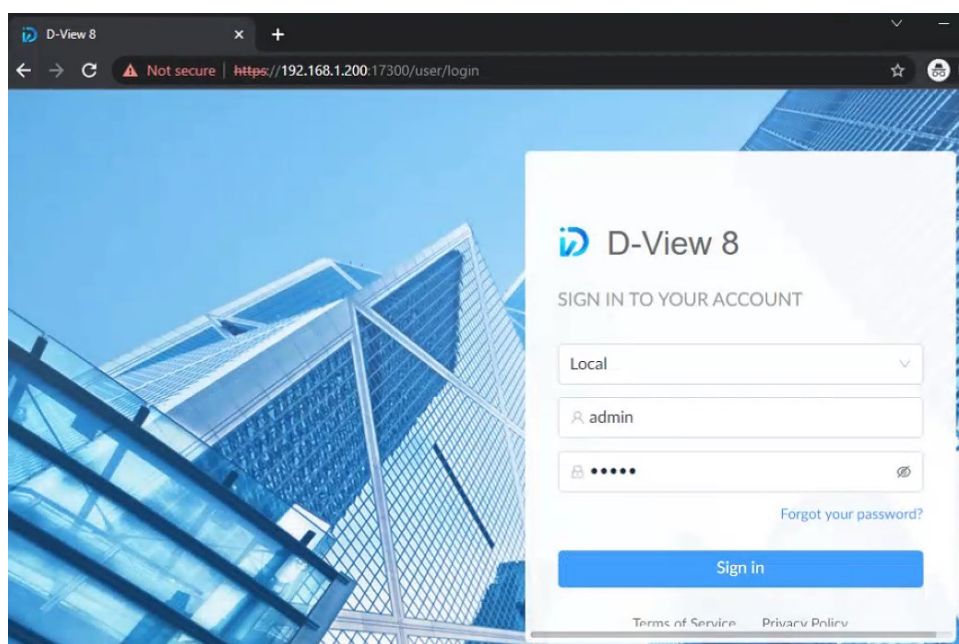

- On SERVER E

You can also manage the NLB cluster on server E by configuring NLB with the Network Load Balancing Manager.

1. Go to **Cluster > Connect to Existing**.

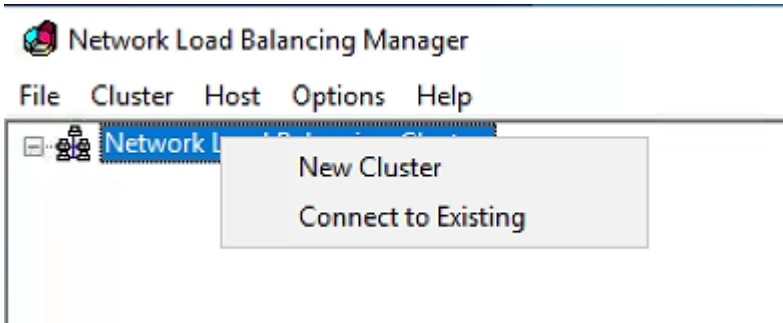

2. Enter the NLB cluster IP: 192.168.1.200, then click **Connect**.

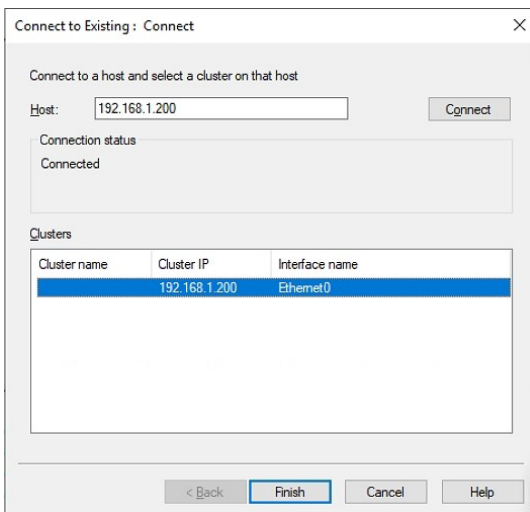

3. The NLB cluster will also be shown on server E.

