



Wireless Controller User Manual

DWC-1000

Version 4.00



BUSINESS WIRELESS SOLUTION

Preface

D-Link reserves the right to revise this publication and to make changes in the content hereof without obligation to notify any person or organization of such revisions or changes. Information in this document may become obsolete as our services and websites develop and change.

Manual Revisions

Revision	Date	Description
4.00	November 03, 2016	• DWC-1000 revision C1 with firmware 4.5.0.1

Trademarks/Copyright Notice

D-Link and the D-Link logo are trademarks or registered trademarks of D-Link Corporation or its subsidiaries in the United States or other countries. All other company or product names mentioned herein are trademarks or registered trademarks of their respective companies.

© 2016 D-Link Corporation, All Rights Reserved

This publication, including all photographs, illustrations and software, is protected under international copyright laws, with all rights reserved. Neither this manual, nor any of the material contained herein, may be reproduced without written consent of the author.

Limitations of Liability

UNDER NO CIRCUMSTANCES SHALL D-LINK OR ITS SUPPLIERS BE LIABLE FOR DAMAGES OF ANY CHARACTER (E.G. DAMAGES FOR LOSS OF PROFIT, SOFTWARE RESTORATION, WORK STOPPAGE, LOSS OF SAVED DATA OR ANY OTHER COMMERCIAL DAMAGES OR LOSSES) RESULTING FROM THE APPLICATION OR IMPROPER USE OF THE D-LINK PRODUCT OR FAILURE OF THE PRODUCT, EVEN IF D-LINK IS INFORMED OF THE POSSIBILITY OF SUCH DAMAGES. FURTHERMORE, D-LINK WILL NOT BE LIABLE FOR THIRD-PARTY CLAIMS AGAINST CUSTOMER FOR LOSSES OR DAMAGES. D-LINK WILL IN NO EVENT BE LIABLE FOR ANY DAMAGES IN EXCESS OF THE AMOUNT D-LINK RECEIVED FROM THE END-USER FOR THE PRODUCT.

Safety Instructions

Use the following safety guidelines to ensure your own personal safety and to help protect your system from potential damage.

Safety Cautions

To reduce the risk of physical injury, electrical shock, fire, and damage to the equipment, observe the following precautions:

- Observe and follow service markings.
 - Do not service any product except as explained in your system documentation.
 - Opening or removing covers that are marked with the triangular symbol with a lightning bolt may expose you to electrical shock.
 - Only a trained service technician should service components inside these compartments.
- If any of the following conditions occur, unplug the product from the electrical outlet and replace the part or contact your trained service provider:
 - The power cable, extension cable, or plug is damaged.
 - An object has fallen into the product.
 - The product has been exposed to water.
 - The product has been dropped or damaged.
 - The product does not operate correctly when you follow the operating instructions.
- Keep your system away from radiators and heat sources. Also, do not block cooling vents.
- Do not spill food or liquids on your system components, and never operate the product in a wet environment. If the system gets wet, see the appropriate section in your troubleshooting guide or contact your trained service provider.
- Do not push any objects into the openings of your system. Doing so can cause fire or electric shock by shorting out interior components.
- Use the product only with approved equipment.
- Allow the product to cool before removing covers or touching internal components.
- Operate the product only from the type of external power source indicated on the electrical ratings label. If you are not sure of the type of power source required, consult your service provider or local power company.
- Also, be sure that attached devices are electrically rated to operate with the power available in your location.
- Use only approved power cable(s). If you have not been provided with a power cable for your system or for any AC powered option intended for your system, purchase a power cable that is approved for use in your country. The power cable must be rated for the product and for the voltage and current marked on the product's electrical ratings label. The voltage and current rating of the cable should be greater than the ratings marked on the product.
- To help prevent electric shock, plug the system and peripheral power cables into properly grounded electrical outlets.
- These cables are equipped with three-prong plugs to help ensure proper grounding. Do not use adapter plugs or remove the grounding prong from a cable. If you must use an extension cable, use a 3-wire cable with properly grounded plugs.
- Observe extension cable and power strip ratings. Make sure that the total ampere rating of all products plugged into the extension cable or power strip does not exceed 80 percent of the ampere ratings limit for the extension cable or power strip.
- To help protect your system from sudden, transient increases and decreases in electrical power, use a surge suppressor, line conditioner, or uninterruptible power supply (UPS).
- Position system cables and power cables carefully; route cables so that they cannot be stepped on or

tripped over. Be sure that nothing rests on any cables.

- Do not modify power cables or plugs. Consult a licensed electrician or your power company for site modifications.
- Always follow your local/national wiring rules.
- When connecting or disconnecting power to hot-pluggable power supplies, if offered with your system, observe the following guidelines:
 - Install the power supply before connecting the power cable to the power supply.
 - Unplug the power cable before removing the power supply.
 - If the system has multiple sources of power, disconnect power from the system by unplugging all power cables from the power supplies.
- Move products with care; ensure that all casters and/or stabilizers are firmly connected to the system. Avoid sudden stops and uneven surfaces.

Protecting Against Electrostatic Discharge

Static electricity can harm delicate components inside your system. To prevent static damage, discharge static electricity from your body before you touch any of the electronic components, such as the microprocessor. You can do so by periodically touching an unpainted metal surface on the chassis.

You can also take the following steps to prevent damage from electrostatic discharge (ESD):

1. When unpacking a static-sensitive component from its shipping carton, do not remove the component from the antistatic packing material until you are ready to install the component in your system. Just before unwrapping the antistatic packaging, be sure to discharge static electricity from your body.
2. When transporting a sensitive component, first place it in an antistatic container or package.
3. Handle all sensitive components in a static-safe area. If possible, use antistatic floor pads, workbench pads, and an antistatic grounding strap.

Power Usage

This device is an Energy Related Product (ErP) with High Network Availability (HiNA), and in case packets are not being transmitted for up to 60 seconds, it automatically switches to a power-saving Network Standby mode. It can also be turned off through a power switch to save energy when it is not needed.

Network Standby: 7.1232 watts

Switched Off: 0.0743 watts

EU Battery & WEEE Directives Disposal and Recycling

This product may contain a battery. For recycling or to dispose of batteries, please follow the battery manufacturer's instructions, and local/national disposal and recycling regulations. For more information, please refer to the warranty guide.

Table of Contents

Preface	2
Manual Revisions.....	2
Trademarks.....	2
Safety Instructions.....	2
Safety Cautions.....	2
Protecting Against Electrostatic Discharge.....	4
Product Overview	14
Introduction.....	14
Features and Benefits.....	16
Package Contents.....	17
Required Tools and Information.....	17
Front Panel.....	18
Rear Panel.....	18
Installation	19
Unpacking.....	19
Selecting a Location.....	19
Rack Mount.....	20
Connecting the Wireless Controller.....	21
Basic Configuration	22
Log in to the Web Management Interface.....	23
Web Management Interface Layout.....	25
Standard Web Management Interface Features.....	26
Basic Configuration Procedures.....	27
Step #1: Enable DHCP Server (Optional).....	28
Step #2: Configure Country Code.....	29
Step #3: Select APs to be Managed.....	30
Step #4: Change the SSID and Set Up Security.....	32
Step #5: Select MAC Authentication Mode.....	37
Step #6: Confirm Access Point Profile is Associated.....	39
Step #7: Configure Captive Portal Settings.....	40
Step #8: Use SSID with RADIUS Sever as Authenticator.....	48
Step #9: Configure Guest Management.....	49
Where to Go from Here.....	56
Advanced WLAN Configuration	57

WLAN General Settings.....	58
Channel Plan and Power Settings	61
Configure Channel Plan	61
Configure Power Settings	63
WIDS.....	65
Configure AP WIDS Settings.....	65
Configure Client WIDS Settings	68
ACL	70
IP ACL.....	70
IP ACL Rules.....	71
IP ACL Configuration Example	74
MAC ACL.....	78
MAC ACL Rules	79
MAC ACL Configuration Example.....	81
DiffServ	86
DiffServ Class	86
DiffServ Policy	88
DiffServ Policy Class Definition	89
Distributed Tunnel	92
WLAN Visualization.....	93
Upload Images	93
Deleting Images	93
Launch	94
AP Discovery Methods	95
L2/ VLAN Discovery	95
Configure L2/ VLAN Discovery.....	96
L3/ IP Discovery	97
Configure L3/ IP Discovery.....	97
Managed APs.....	98
Add a Valid AP	98
Add a AP from Discovered AP List	100
Manual Change Channel and Power of Managed AP.....	101
Configure AP Debug Mode	102
Configure AP Provisioning.....	103
AP Profiles	105
Configure AP Profile Radio	107
Configure AP Profile SSID.....	113
Configure AP Profile QoS.....	114
SSID Profiles.....	118
Configure SSID Profiles	118
Wireless Distribution System (WDS).....	122

Configure WDS Managed AP Group	124
Configure WDS Managed AP	125
Configure WDS AP Link.....	127
Peer Group.....	128
Configure Peer Group.....	128
Synchronize Peer Group	129
AP Firmware Download	131
AP Firmware Status.....	133
Advanced Network Configuration	135
IP Mode.....	136
LAN Configuration	137
IPv4 LAN Settings.....	137
DHCP Address Pool	140
IPv6 LAN Settings.....	141
IPv6 Address Pools.....	143
IPv6 Router Advertisement	145
IPv6 Advertisement Prefixes	147
LAN DHCP Reserved IPs	149
IP/MAC Binding.....	150
IGMP Setup.....	151
UPnP Setup.....	152
Configure Jumbo Frames.....	154
Internet (IPv4).....	155
Option 1 Settings	155
Option 2/DMZ Settings.....	158
IPv6 Option 1/2 Settings	159
Option Mode	161
Single Option Port.....	161
Auto-Rollover using Option Port	162
Load Balancing	163
Round Robin.....	164
Spillover	165
Routing	166
NAT or Classical	166
Transparent.....	167
IP Aliasing.....	168
DMZ DHCP Reserved IPs.....	169
Dynamic DNS.....	170
VLANs	171

VLAN Settings.....	171
Editing VLANs.....	173
Deleting VLANs.....	173
MultiVLAN Subnets.....	174
Port VLANs.....	176
Routing	177
Configure IPv4 Static Routing.....	177
Configure IPv6 Static Routing.....	179
Editing/Deleting Static Routes	180
RIP	181
OSPF.....	182
OSPFv3 (IPv6).....	184
6 to 4 Tunneling (IPv6).....	186
ISATAP Tunnels (IPv6).....	187
Protocol Binding.....	188
Securing Your Network	189
Client Management.....	190
Viewing/Adding Wireless Known Clients	190
Editing/Deleting Clients	192
Group Management.....	193
Adding User Groups.....	193
Editing User Groups.....	195
Deleting User Groups.....	196
Configuring Login Policies.....	197
Configuring Browser Policies	198
Configuring IP Policies	199
User Management	200
Adding Users Manually	200
Importing Users	201
Editing Users	203
Deleting Users	204
Hotspot	205
Captive Portal Front Desk.....	206
Guest Account Usage Management	207
Payment Gateway.....	211
Login Profiles	213
Customize the Captive Portal Login Page	213
Customize the SLA of the Captive Portal.....	216
Upload a Custom Profile.....	217
RADIUS Accounting Global Setting.....	218

External Authentication.....	219
Configure RADIUS Server	219
Configure RADIUS Accounting.....	221
Configure POP3 Server.....	222
Configure POP3 Trusted CA.....	223
Configure LDAP Server.....	224
Configure Active Directory Server	226
Configure NT Domain Server	227
Facebook Wi-Fi	228
Email Configuration	230
Web Content Filter	231
Static Filtering	231
Approved URLs	232
Blocked Keywords.....	233
Dynamic Filtering.....	234
Firewall	236
Firewall Rules	236
Schedules.....	238
Blocked Clients.....	240
Custom Services	241
ALGs	242
SMTP ALGs	243
Mail Filtering.....	244
VPN Passthrough.....	245
Dynamic Port Forwarding.....	246
Application Rules.....	246
Attack Checks	248
VPN	250
IPSec VPN	251
Policies	251
Tunnel Mode.....	255
Split DNS Names.....	256
DHCP Range.....	257
Certificates.....	258
Trusted Certificates	258
Active Self Certificates	259
Self Certificate Requests	260
Easy VPN Setup	261
PPTP VPN	262
Server	262
Client.....	263
PPTP Active Users List.....	264

L2TP VPN	265
Server	265
L2TP Active Users List	266
SSL VPN	267
Server Policies	267
Portal Layouts.....	269
Resources	271
Add New Resource.....	271
Port Forwarding	273
Client.....	274
Client Routes.....	275
Open VPN	276
Settings.....	276
Server.....	276
Client.....	278
Access Server Client.....	280
Local Networks.....	281
Remote Networks	282
Authentication	283
Status and Statistics	284
Viewing Statistic and Utilization	285
Manage Dashboard	287
System Information	289
Viewing System Status.....	289
Viewing USB Status	290
Network Information	291
Viewing DHCP Clients.....	291
Viewing Captive Portal Sessions.....	292
Viewing Active Sessions	293
Viewing VPN Sessions.....	294
Viewing Traffic on Interfaces.....	295
IPv6 Tunnels Status	297
Wireless Information	298
Viewing Controller Status and Statistics.....	298
Controller Associated Clients	299
Distributed Tunnel	300
Peer Controller Receive Status.....	301
Peer Controller Sent Status	303
Viewing Access Point Information	304
Global Status.....	304
All APs	306
Managed.....	307

Peer Managed.....	309
Authentication Failed.....	310
RF Scan	311
De-Authentication Attacks	312
Hardware Capability.....	314
Associated Clients	316
Global Status.....	316
Associated Clients	317
Ad Hoc Clients	321
Detected Clients	322
Viewing Radius Accounting Server Statistics.....	324
Viewing Cluster Information	325
Viewing WDS Group Status	326
WDS Group AP Status	327
Viewing WDS AP Status.....	329
Viewing WDS Link Status	330
Viewing WDS Link Statistics.....	331
ACL & DiffServ Status.....	332
IP ACL.....	332
IP ACL Rules.....	332
MAC ACL.....	333
MAC ACL Rules	333
DiffServ Class	334
DiffServ Policy	334
DiffServ Policy Attribute	335
Maintenance	336
Administration	337
System Setting	337
System Date and Time	337
Session Settings.....	338
USB Share Ports	338
Package Manager.....	340
Activating Licenses.....	342
Localization	343
Management	345
Remote Management	345
Power Saving Settings.....	347
SNMP	348
Configure SNMP v3 User List.....	348
Configure SNMP Trap List	349
Configure SNMP Access Control List	350
Configure SNMP System Info	351

Configure Wireless SNMP Info.....	351
Firmware.....	354
Backup Configuration Settings.....	354
Restoring Configuration Settings.....	355
Soft Reboot	356
Restoring Factory Default Settings	356
Rebooting the Wireless Controller	357
Upgrading Firmware.....	358
Wireless Controller Firmware Upgrade.....	358
Using the Command Line Interface.....	360
Wizard.....	361
WLAN Wizard	361
Internet Connection Wizard	362
VPN Wizard	364
Troubleshooting	365
LED Troubleshooting	366
Power LED is OFF.....	366
LAN Port LEDs Not ON.....	366
Web Management Interface	366
Unable to Save Configuration Changes.....	367
Unable to Access Internet.....	367
Using the Reset Button to Restore Default Settings.....	368
Problems with Date and Time	368
Discovery Problems with Access Points.....	368
Connection Problems.....	369
Ping to Test LAN Connectivity	369
Network Performance and Rogue Access Point Detection.....	370
Using Diagnostic Tools on the Wireless Controller	371
Ping an IP Address	371
Using Traceroute	372
Performing DNS Lookups.....	373
Capturing Log Packets	374
Conducting a System Check.....	375
Generating DBGLOGs	375
Log Settings	376
Defining What to Log.....	376
Tracking Traffic/Routing Logs.....	378
IPv4	378
IPv6	378
System Logging	380
Remote Logging	381
Email.....	381

Syslog Server Configuration	383
All Logs	384
Current Logs	384
Appendix A - Basic Planning Worksheet.....	385
Appendix B - Factory Default Settings.....	388
Appendix C - Glossary	389

Product Overview

Introduction

D-Link Wireless Controller (DWC), DWC-1000, is a full-featured wireless LAN controller designed for small network environment. The centralized control function contains various access point management functions, such as fast-roaming, inter-subnet roaming, automatic channel and power adjustment, self-healing etc. The advanced wireless security function, including rogue AP detection, captive portal, wireless intrusion detection system (WIDS), offers a strong wireless network protection avoiding attacks from hackers. After license upgrade optimal network security is provided via features such as virtual private network (VPN) tunnels, IP Security (IPSec), Point-to-Point Tunneling Protocol (PPTP), Layer 2 Tunneling Protocol (L2TP), and Secure Sockets Layer (SSL). Empower your road warriors with clientless remote access anywhere and anytime using SSL VPN tunnels.

There are three types of licenses available to activate increased functionality for the DWC. These licenses are not activated by default.

1. **VPN license** upgrade enables the following features: ISP Connection types (PPPoE, PPTP, L2TP, NAT/Transparent mode), Option2/DMZ port, IP Aliasing, Dynamic Routing (RIP), VPN (PPTP client/server, L2TP client /server , SSLVPN, OpenVPN) , Dynamic DNS, Website Filter, Application Rules, Firewall Rules, UPNP, IGMP proxy, and ALG/SMTP-ALG
2. **AP6 license** upgrades the number of APs controller can manage. You can upgrade up to 3 AP licenses. By default DWC-1000 can manage up to 6 AP's. You increase the number by 6 upon each AP license.
3. **WCF License** is a powerful dynamic web filtering function that can be used in many places. It is ideal for companies that want to ensure that employees aren't wasting time online, schools that want to prevent their students from viewing questionable online material, or libraries and small businesses like coffee stores that want to limit customers from accessing certain sites on their network. You can filter up to 32 categories of websites in total, such as pornography, gambling, online shopping, and many others. You can easily block or unblock these categories in just a few clicks. The dynamic WCF also has a logging feature. Whenever a user tries to access a website that is blocked, or the time stamp of login/logout, the corresponding event will be logged.

Using the wireless controller and the access points with which it is associated lets you:

- Discover and configure D-Link access points on the WLAN
- Optimize wireless access point performance with centralized RF management, security, Quality of Service (QoS), and other configuration features
- Streamline security configuration tasks and set up guest access
- Monitor network status and statistics
- Perform maintenance tasks and firmware updates for the wireless management system and for D-Link access points on your wireless network
- Conduct troubleshooting procedures

Configuration is performed using configuration profiles. A configuration profile allows a wireless controller to distribute a set of radio, Service Set Identifier (SSID), and QoS parameters to the access points associated with that profile.

The wireless controller comes with one profile predefined. You can use this profile as is, edit it to suit your requirements, or create new configuration profiles as necessary. For example:

- An office building may have one configuration profile for access points located in one area of a facility (such as a general work area) and a different profile for access points in another area of the facility (for example, in the Human Resources department).
- A shopping mall may need several configuration profiles if several businesses share a WLAN, but each business has its own network.
- Large networks that need different policies per building or department could have access points configured for security policies for each building and department (for example, one for guests, one for management, one for sales, and so on).

Features and Benefits

The DWC-1000 Wireless Controller is intended for campuses, branch offices, and small-to-medium businesses. In a stacked configuration with the appropriate licenses, a wireless controller can support up to 96 access points. The wireless controller allows you to manage your wireless network from a central point, implement security and QoS features centrally, configure a guest access captive portal, and support Voice over Wi-Fi.

Scalable Architecture with Stacking and Redundancy

- Supports for 6 access points on a single wireless controller with no additional license.
- Purchased license packs (DWC-1000-AP6-LIC) in increments of 6 access points which allows for support of up to 24 access points on a single wireless controller.
- Up to 96 access point in a clustering group network.
- Maximum of 4 wireless controllers allows for up to 96 access points in a single network.
- Supports IEEE 802.11a, 802.11b, 802.11g, 802.11n, and 802.11ac protocols.

Centralized Management and Configuration

- Auto-discovery of access points in L2 and L3 domains.
- Single point of management for the entire wireless network.
- Simplified profile-based configuration.
- DHCP server for dynamic IP address provisioning.
- Configurable management VLAN.
- Real-time monitoring of access points and associated client stations.
- System alarms and statistics reports on managed access points for managing, controlling, and optimizing network performance.

Security

- Identity-based security authentication with an external RADIUS server or an internal authentication server.
- Rogue access point detection, classification, and mitigation.
- Guest access and captive portal access.
- Purchasable license pack (DWC-1000-VPN) enables VPN, router, and firewall functionality via two Gigabit Ethernet Option ports.
- Purchasable license pack (DWC-1000-WCF) enables one year dynamic web content filtering to maintain a safe and productive work or study environment. The wireless controller must upgrade VPN license (DWC-1000-VPN) first before enable this license.

After the site survey is complete, use the collected data to set up an RF plan using the Basic Planning Worksheet in Appendix A.

After you complete the Basic Planning Worksheet, select a location for the wireless controller. The ideal location should:

- Be flat and clean, with no dust, water, moisture, or exposure to direct sunlight or vibrations.
- Be fairly cool and dry, and does not exceed 104° F (40° C).
- Not be prone to variations in temperature and humidity, or close to strong magnetic fields or a device that generates electric noise.
- Not place the wireless controller next to, on top of, or below any device that generates heat or will block the free flow of air through the wireless controller's ventilation slots. Leave at least 3 feet (91.4 cm) clear on both sides and rear of the controller.
- Allow you to reach the wireless controller and all cables attached to it.
- Have a working AC power outlet that is not controlled by a wall switch that can accidentally remove power to the outlet.

Package Contents

Each wireless controller package contains the following items:

- One D-Link DWC-1000 Wireless Controller
- One power adapter
- One RJ-45 to DB-9 console cable
- One 3-foot Ethernet Category 5 UTP/straight-through cable
- One Reference CD-ROM containing product documentation in PDF format
- Two rack-mounting brackets
- Quick Installation Guide

Required Tools and Information

You will need the following additional items to install your wireless controller:

- D-Link DWL-2600AP, DWL-3600AP, DWL-3610AP, DWL-6600AP, DWL-6700AP, DWL-8600AP, DWL-6610AP, DWL-8710AP, and/or DWL-8610AP access points.
- A computer with a supported web browser for configuration:
 - Microsoft Internet Explorer 9.0 or higher
 - Mozilla Firefox 20 or higher
 - Apple Safari 5.0 or higher (Windows)
 - Apple Safari 5.0 or higher (iOS)
 - Google Chrome 25 or higher
 - Opera 12.0 or higher

Front Panel



1	Power LED	A solid green light indicates a good connect to a power source. This LED will be orange during boot up.
2	USB Ports	Two Universal Serial Bus (USB) 2.0 ports are provided for connecting USB flash drives, hard drives, and printers. A solid LED indicates the USB device is attached. This LED will blink during data transmission.
3	LAN Ports (1-4)	Four Gigabit Ethernet ports labeled 1 through 4 let you connect Ethernet devices such as computers, switches, and network storage (NAS) devices. Each port has an Activity LED (left) and Link LED (right).
4	Option Ports (1-2)	Two Gigabit Ethernet ports labeled Option let you connect the wireless controller to a backbone (requires DWC-1000-VPN-LIC License Pack upgrade). Each port has an Activity LED (left) and Link LED (right).
5	Console Port	The RJ-45 console cable lets you connect a PC to access the wireless controller's command-line interface.

Rear Panel

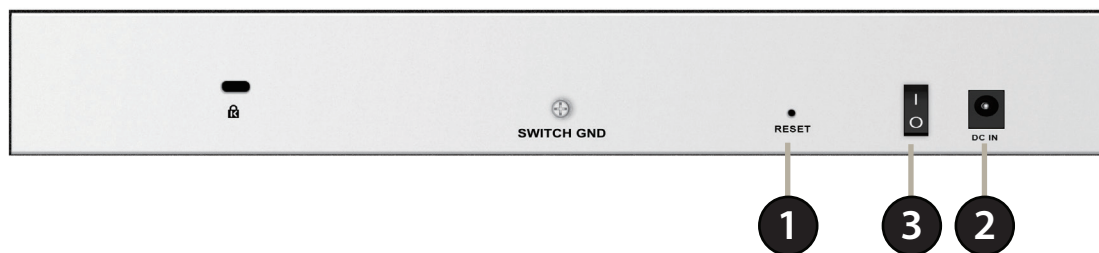

1	Reset Button	Press and hold for 10 seconds to reset the switch back to the factory default settings.
2	Power Port	Connect the supplied power cord to a power outlet or surge protector.
3	On/Off Switch	Press to turn the wireless controller on and off.

Installation

A DWC-1000 wireless controller system consists of one or more wireless controllers and a collection of DWL-2600AP, DWL-3600AP, DWL-3610AP, DWL-6600AP, DWL-6700AP, DWL-8600AP, DWL-6610AP, DWL-8710AP, and/or DWL-8610AP access points that are organized into groups based on location or network access. This section describes how to unpack and install the wireless controller system.

Unpacking

Follow these steps to unpack the wireless controller and prepare it for operation:

1. Open the shipping container and carefully remove the contents.
2. Return all packing materials to the shipping container and save it.
3. Confirm that all items listed under section "Package Contents" on page 17 are included in the shipment. Check each item for damage. If any item is damaged or missing, notify your authorized D-Link representative.

Selecting a Location

Selecting the proper location for the wireless controller is essential for its successful operation. To ensure optimum performance, D-Link recommends that you perform a site survey. A site survey should enable you to:

- Identify how Wi-Fi coverage should be provided.
- Determine access point placement locations, and identify areas with weak signal or dead spots that require additional access points.
- Determine areas of heavier usage that might require dense access point coverage.
- Determine the indoor propagation of RF signals.
- Identify potential RF obstructions and interference sources.
- Run a spectrum analysis of channels of the site to ascertain current RF behavior, and detect both 802.11 and non-802.11 noise.
- Run an access point-to-client connectivity test to determine maximum throughput achievable on the client.

After the site survey is complete, use the collected data to set up an RF plan using the Basic Planning Worksheet in Appendix A. After you complete the Basic Planning Worksheet, select a location for the wireless controller. The ideal location should:

- Be flat and clean, with no dust, water, moisture, or exposure to direct sunlight or vibrations.
- Be fairly cool and dry, and does not exceed 104° F (40° C).
- Not be prone to variations in temperature and humidity, or close to strong magnetic fields or a device that generates electric noise.
- Not place the wireless controller next to, on top of, or below any device that generates heat or will block the free flow of air through the wireless controller's ventilation slots. Leave at least 3 feet (91.4 cm) clear on both sides and rear of the controller.
- Allow you to reach the wireless controller and all cables attached to it.
- Have a working AC power outlet that is not controlled by a wall switch that can accidentally remove power to the outlet.

Rack Mount

The wireless controller can be mounted in a standard 19-inch equipment rack.

1. Attach the mounting brackets to each side of the chassis and secure them with the supplied screws.

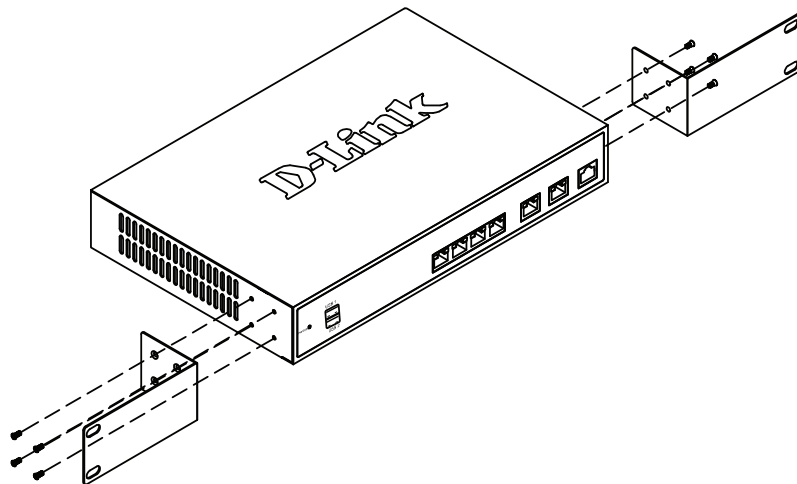

2. Use the screws provided with the equipment rack to mount the wireless controller into the rack.

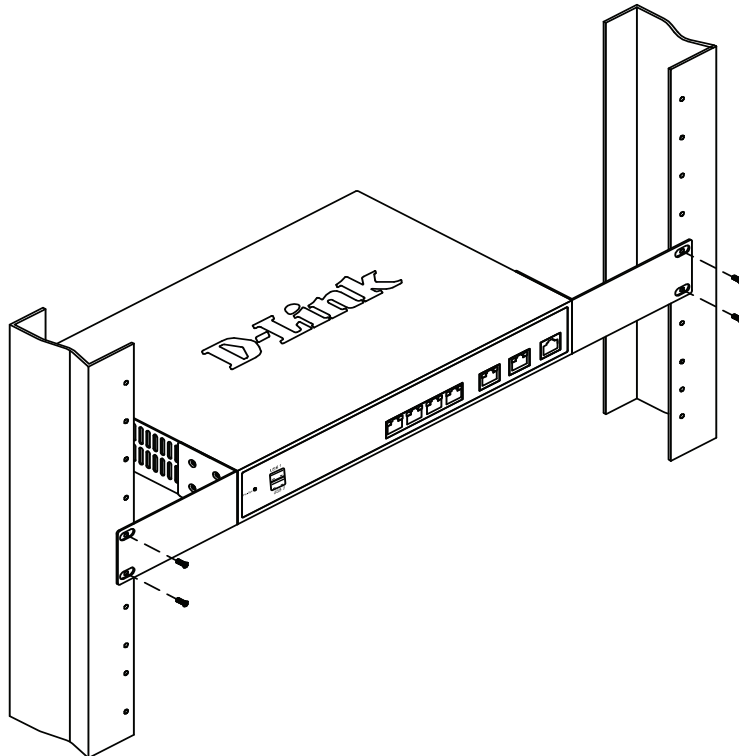

Connecting the Wireless Controller

To install the wireless controller, perform the following procedure:

1. Install the controller and access points according to the instructions in their documentation.
2. Connect one end of an Ethernet LAN cable to one of the ports labeled LAN (1-4) on the front of the wireless controller. Connect the other end of the cable to an available RJ-45 port on a switch in the LAN network segment.
3. Connect one of the wireless controller ports labeled LAN (1-4) to the network or directly to a PC.

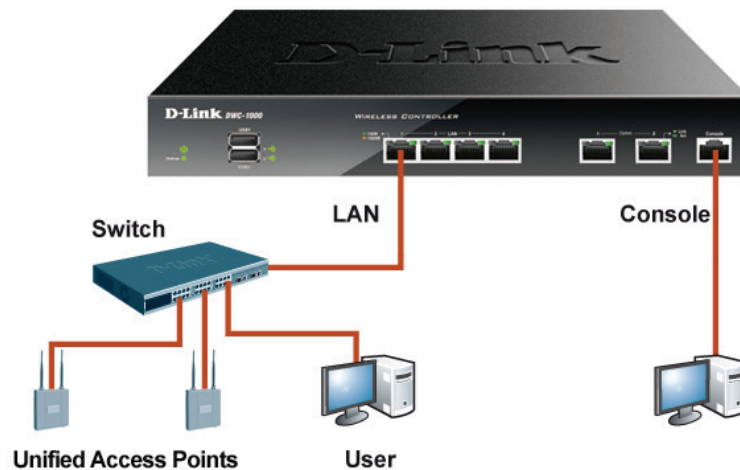

4. If you purchased a VPN/Firewall/Router License Pack, use the Option1 and Option2 ports on the front of the wireless controller as follows:
 - Option1 = WAN port for connecting to a cable or DSL modem.
 - Option2 = WAN or DMZ port for dual WAN connections or internal server farm purposes. If used as a DMZ port, the port's IP address must be different than the IP address of the wireless controller's LAN interface.
5. Using the supplied power cord, connect the wireless controller to a working AC outlet.
6. The Power LED will illuminate orange during boot up. The LED will turn green once the wireless controller has booted.

Basic Configuration

After you install the wireless controller, perform the basic configuration instructions described in this section which includes:

- “Log in to the Web Management Interface” on page 23
- “Web Management Interface Layout” on page 25
- “Standard Web Management Interface Features” on page 26
- “Basic Configuration Procedures” on page 27

Using the information in this chapter, you can perform the basic information and get your wireless controller up and running in a short period of time.

Log in to the Web Management Interface

Configuration procedures using the wireless controller's web management interface are performed using one of the following supported web browsers:

- Microsoft Internet Explorer 9.0 or higher
- Mozilla Firefox 20 or higher
- Apple Safari 5.0 or higher (Windows)
- Apple Safari 5.0 or higher (iOS)
- Google Chrome 25 or higher
- Opera 12.0 or higher

Before you perform the following procedure:

- Configure your PC running the web browser to use an IP address on the 192.168.10.x network, with a subnet mask of 255.255.255.0.
- Configure your web browser to accept cookies, prompt for pop-ups, and allow sites to run JavaScript.
- Upgrade the firmware for your wireless controller (see section "Upgrading Firmware").
- Upgrade the firmware for your access points after you upgrade the wireless controller firmware (refer to the documentation for your access points).

To log in to the web management interface:

1. Launch a web browser on the PC.
2. In the address field of your web browser, type the IP address for the wireless controller web management interface. The default IP address is **http://192.168.10.1**. A login prompt will appear. If the login prompt does not appear, see section "Web Management Interface" on page 366.

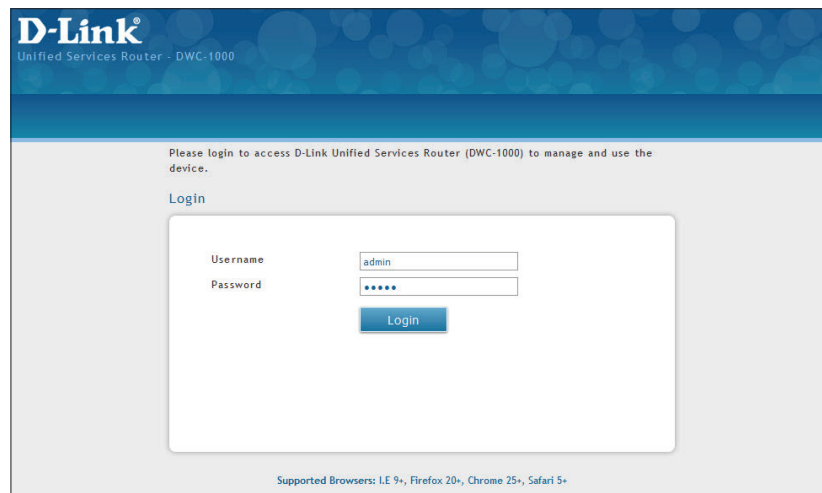

3. If you are logging in for the first time, the default user name is **admin** and the default password is **admin**. Both the user name and password are case-sensitive.

Note: We recommend that you change the password to a new, more secure password (see section "Editing Users" on page 203) and record it in Appendix A.

- Click **Login**. The web management interface opens with the System Status page. This page displays general, LAN, and WLAN status information. You can return to this page at any time by clicking **Status > Dashboard**.

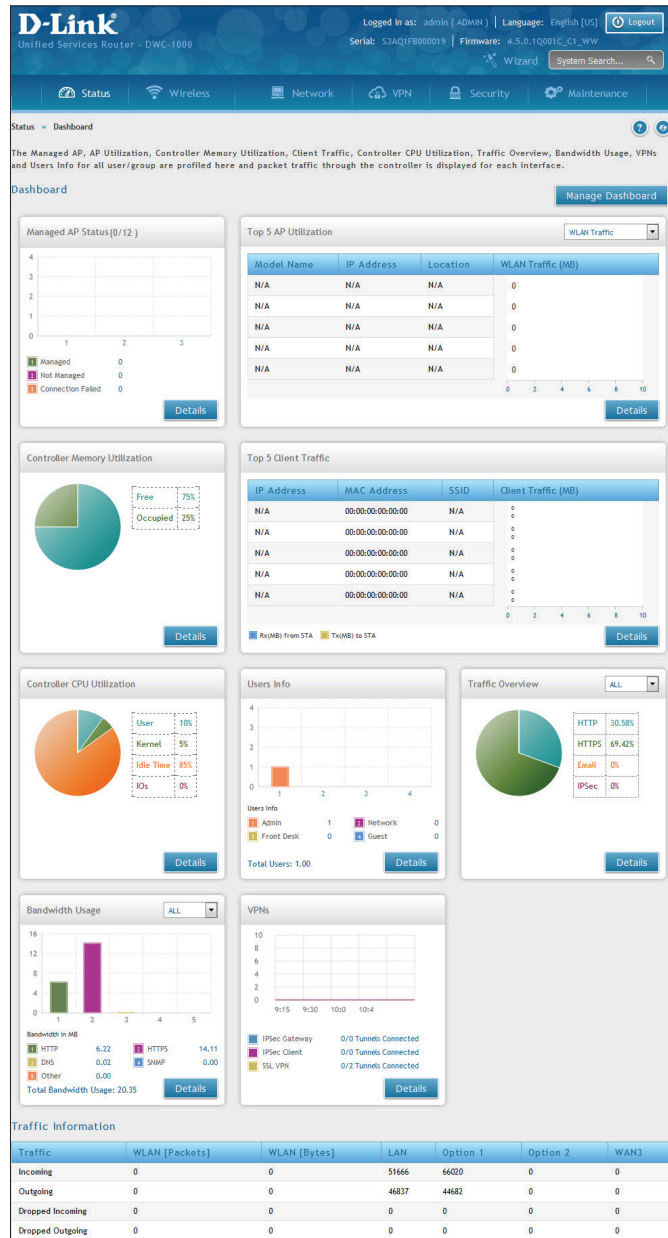

- To log out of the web management interface, click **Logout**, present at the top-right corner of the page in the System Menu area.

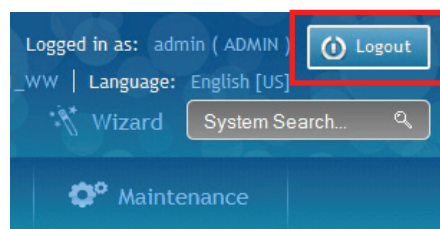

Web Management Interface Layout

A web management interface screen can include the following components:

- **1st level:** Main navigation menu tab. The main navigation menu tabs appear across the top of the web management interface. These tabs provide access to all configuration menus and remain constant.
- **2nd level:** Main navigation submenu tab. The main navigation submenu tabs appear on drop-down menus when you move your mouse over the main navigation menu tabs.
- **3rd level:** Middle menu tabs. Some pages have menu tabs below the main navigation menu tab which lead to other pages when you click on them.
- **4th level:** Workspace. The workspace shows the parameters associated with the selected menu and submenu.
- **Action buttons:** Action buttons change the configuration or allow you to make changes to the configuration. Common action buttons are:
 - **Save:** Saves all configuration changes made on the current screen. Saved settings are retained when the wireless controller is powered off or rebooted, while unsaved configuration changes are lost.
 - **Cancel:** Resets options on the current screen to the last-applied or last-saved settings.
 - **Add:** Adds a new item to the current screen.
 - **Right-click:** Right-clicking list table items allow you to do more action for the existing items.
 - **Edit:** Modify the configuration of this item.
 - **Delete:** Deletes the selected item.
 - **Move:** Moves the selected item to a specific position.
 - **Enable:** Enables this item.
 - **Disable:** Disables this item.
 - **Apply:** To apply changes to the existing configuration.
 - **Copy:** Copy the configuration value of this item and create a new item.
 - **Manage:** Manage the discovered access point.
 - **View Information:** The information would vary depending on the items.

Standard Web Management Interface Features

There are several standard features in the web management interface.



The Help feature has explanations for the various functions and settings on the interface. Click on the question mark icon to bring up the Help menu. It is always located near the top right corner of the screen.



System Search allows you to search for a function or feature by typing in a word into the search box. The search box is always located near the top-right corner of the screen.

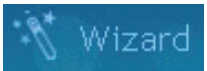

The Wizard feature provides a number of helpful guides to common configuration task such as setting up the device, connecting to the internet, configuring wired and wireless networking, setting security options, and creating new users. Click on the Wizard wand icon to open the wizard. It is always located near the top right corner of the screen, on the left of the System Search box.



Refresh allows you to refresh the interface in order for changes to take effect immediately. Click on the refresh icon near the top-right corner of the screen, to the right of the Help icon.



Logout allows you to log out of the interface securely. Click on the Logout icon at the top-right corner of the screen.

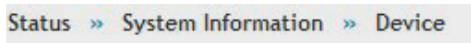

Menu Navigation Route - Displays the menu route for the current page.



Displays the number of items on the table in one page. The system can list 10, 25, 50, 100 entries in one page.



First/ Previous/ Next/ Last (on table)

Information would be shown in multiple pages. Use First/ Previous/ Next/ Last to switch pages. The page change function is always located near the bottom right corner of the table



Search bar (on table)

Table content search allows you to search information in the table by typing in a word into the search box. The search box is always located near the top right corner of the table.



Ranking/sort (on table)

Rank/sort the relative order of value and information on the table by clicking table header.

Basic Configuration Procedures

To perform common basic configuration procedures, follow the steps below:

- "Step #1: Enable DHCP Server (Optional)" on page 28
- "Step #2: Configure Country Code" on page 29
- "Step #3: Select APs to be Managed" on page 30
- "Step #4: Change the SSID and Set Up Security" on page 32
- "Step #5: Select MAC Authentication Mode" on page 37
- "Step #6: Confirm Access Point Profile is Associated" on page 39
- "Step #7: Configure Captive Portal Settings" on page 40
- "Step #8: Use SSID with RADIUS Sever as Authenticator" on page 48
- "Step #9: Configure Guest Management" on page 49

Step #1: Enable DHCP Server (Optional)

By default, Dynamic Host Configuration Protocol (DHCP) is disabled on the wireless controller. If you are not configuring your access points with static IP addresses, set up a DHCP server, or DHCP server relay on the network. If desired, perform the following procedure to configure your wireless controller to act as a DHCP server.

1. Click **Network > LAN > LAN Settings**. The LAN Settings page will appear.

The screenshot shows the D-Link Unified Services Router (DWC-1000) LAN Settings page. The page is titled "LAN Settings" and includes a description: "The LAN Configuration page allows you to configure the LAN interface of the router including default behaviour for ping on LAN interfaces, the DHCP Server which runs on it and Changes here affect all devices connected to the router's LAN switch and also wireless LAN clients. Note that a change to the LAN IP address will require all LAN hosts to be in the same subnet and use the new address to access this GUI." The configuration fields are as follows:

- LAN Ping:** Allow Ping from LAN (ON)
- IP Address Setup:** IP Address (192.168.10.1), Subnet Mask (255.255.255.0)
- DHCP Setup:** DHCP Mode (DHCP Server), Default Gateway (192.168.10.1), Domain Name (DLink), Lease Time (24 [Range: 1 - 262800] Hours)
- Configure DNS / WINS:** (ON)
- Primary DNS Server:** (Empty field)
- Secondary DNS Server:** (Empty field)
- WINS Server:** (Empty field)

2. Under *IP Address Setup*, change the IP Address and Subnet Mask to values used within your network. Record the settings; you will refer to them later in this procedure.
3. Click **Save**.
4. Wait for 60 seconds, and then relaunch your web browser.
5. In the web browser's address field, enter the new IP address you recorded in step 2.
6. Click **Network > LAN > LAN Settings**.
7. In the LAN Settings page, change *DHCP Mode* to **DHCP Server**. This will bring up several new fields below the DHCP Mode.
8. Complete the fields given below and click **Save**.

Field	Description
Default Gateway	Enter the IP address of the gateway for your LAN.
Domain Name	Enter the domain name.
Lease Time	Enter the lease time of the assigned IP addresses.
Configure DNS/ WINS	Turn this on to enter the IP address of the DNS or WINS server.
Primary DNS Server	If configured Domain Name System (DNS) servers are available on the LAN, enter the IP address of the primary DNS server.
Secondary DNS Server	If configured domain name system (DNS) servers are available on the LAN, enter the IP address of the secondary DNS server.
WINS Server	If Windows Internet Name Service (DNS) servers are available on the LAN, enter the IP address of the WINS server.

Step #2: Configure Country Code

Each country has its regulation for the radio usage. Use the following procedure to select the country where the wireless networks are.

1. Click **Wireless > General**. The General Setting page will appear.
2. At the bottom, select the *Current Country Code* from the drop-down menu and click **Save**.

The screenshot shows the D-Link Unified Services Router (DWC-1000) configuration interface. The user is logged in as 'admin (ADMIN)' and the language is set to 'English [US]'. The page title is 'Wireless > General'. The main content area is titled 'General Setting' and contains various configuration options for WLAN Global Setup, AP Validation, and Mutual Authentication. The 'Country Configuration' section at the bottom is highlighted with a red box, showing the 'Current Country Code' dropdown menu set to 'US - United States'. Below this section are 'Save' and 'Cancel' buttons.

Section	Parameter	Value	Range/Default
WLAN Global Setup	IP Address	192.168.10.1	
	Peer Group ID	1	[Default: 1, Range: 1 - 255]
	Client Roam Timeout	30	[Range: 1 - 120] Seconds
	Ad Hoc Client Status Timeout	24	[Range: 0 - 168] Hours
	AP Failure Status Timeout	24	[Range: 0 - 168] Hours
	Client MAC Authentication Mode	White-list	White-list / Black-List
	RF Scan Status Timeout	24	[Range: 0 - 168] Hours
	Detected Clients Status Timeout	24	[Range: 0 - 168] Hours
	Tunnel IP MTU Size	1500	1500 / 1520
	Cluster Priority	1	[Range: 0 - 255]
	Detected Clients Delete	OFF	
	Detected Clients Delete Timeout	10	[Range: 10 - 999] Minutes
	AP Client QoS	OFF	
	Radius Authentication Server	Default-RADIUS-Server	
	Radius Authentication Server Status	Configured	
Radius Accounting Server	Default-RADIUS-Server		
Radius Accounting Server Status	Configured		
Global Accounting Mode	OFF		
AP Validation	AP MAC Validation	Local	Local / Radius
	Require Authentication Passphrase	OFF	
	Manage AP with Previous Release Code	OFF	
Mutual Authentication	Controller Provisioning Mode	ON	
	Network Mutual Authentication Mode	OFF	
	Unmanaged AP Reprovisioning Mode	ON	
Country Configuration	Current Country Code	US - United States	

Step #3: Select APs to be Managed

The wireless controller automatically discovers managed and unmanaged access points on the WLAN that are in the same IP subnet. Use the following procedure to select the access points that the wireless controller will manage.

1. Click **Wireless > Access Point > Discovered AP List**. The Discovered AP List page will appear with a list of access points that the wireless controller has discovered.

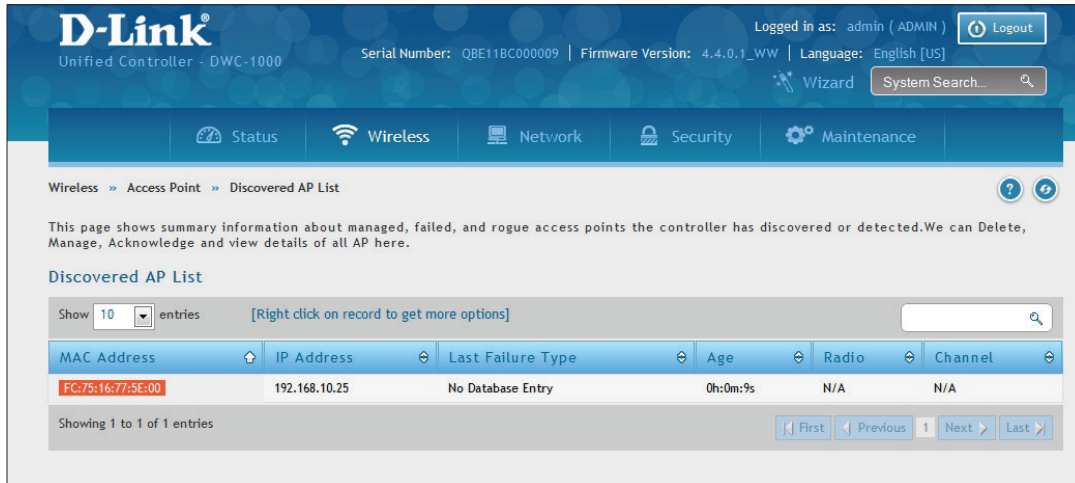

2. Under *Discovered AP List*, right-click on the access point you want the wireless controller to manage and select **Manage**.

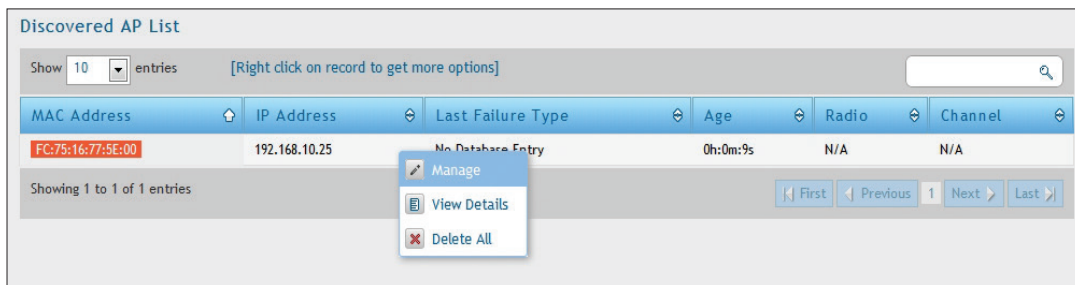

3. Complete the fields in the *Manage AP* page (refer to the next page) and click **Save**. When the confirmation appears, click **OK**.

Field	Description
MAC Address	MAC address of the access point.
AP Mode	Select standalone, managed, or rogue. Selecting standalone will require you to fill in the fields below from Location to Expected Wired Network Mode. <ul style="list-style-type: none"> • Standalone • Managed = Access point profile configuration has been applied to the access point and the access point is operating in the managed mode. • Rogue = Access point has not tried to contact the wireless controller and the access point's MAC address is not in the Valid AP database.
Location	Optional field to identify location of the access point being managed.
Expected SSID	If AP Mode = Standalone, the SSID that the access point should be set to is displayed. This is for reference only.
Expected Channel	If AP Mode = Standalone, the channel to be used for wireless communication is displayed. This is for reference only.
Expected WDS Mode	If AP Mode = Standalone, the WDS (Wireless Distributed System) mode to be used if you intend to use WDS. This is for reference only.
Expected Security Mode	If AP Mode = Standalone, the security mode to be used is displayed. This is for reference only.
Expected Wired Network Mode	If AP Mode = Standalone, select whether wired networking is going to be allowed. This is for reference only.
Authentication	If AP Mode = Managed, turn on to require a password for authentication.
Profile	If AP Mode = Managed, select a profile to apply for AP configuration.
Radio	If AP Mode = Managed, this is Wireless radio mode that the access point is using is displayed. The fields below appear after you have selected Managed AP Mode.
Channel	If AP Mode = Managed, this is operating channel for the radio.
Power	If AP Mode = Managed, this is percentage of power to use for the radio.

4. Repeat steps 2 and 3 for each additional access point you want the wireless controller to manage.

Step #4: Change the SSID and Set Up Security

You can configure up to 50 separate networks on the wireless controller and apply them across multiple radio and virtual access point interfaces. By default, 16 networks are pre-configured and applied in order to the access points on each radio. In this procedure, you will edit one of the pre-configured networks and change its SSID and security settings to suit your requirements.

1. Click **Wireless > Access Point > AP Profile > AP Profile SSID**. The following page will appear with a list of the wireless networks configured on the wireless controller.

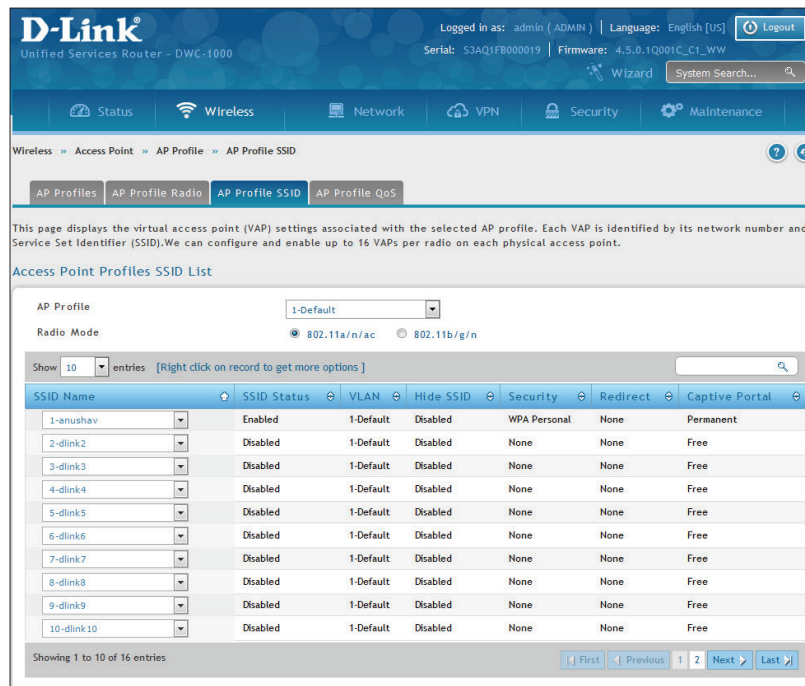

The screenshot shows the 'AP Profile SSID' configuration page in the D-Link web interface. The page title is 'D-Link Unified Services Router - DWC-1000'. The user is logged in as 'admin (ADMIN)'. The page displays the 'Access Point Profiles SSID List' for the '1-Default' AP profile. The table below shows the configuration for 10 SSIDs.

SSID Name	SSID Status	VLAN	Hide SSID	Security	Redirect	Captive Portal
1-anushav	Enabled	1-Default	Disabled	WPA Personal	None	Permanent
2-dlink2	Disabled	1-Default	Disabled	None	None	Free
3-dlink3	Disabled	1-Default	Disabled	None	None	Free
4-dlink4	Disabled	1-Default	Disabled	None	None	Free
5-dlink5	Disabled	1-Default	Disabled	None	None	Free
6-dlink6	Disabled	1-Default	Disabled	None	None	Free
7-dlink7	Disabled	1-Default	Disabled	None	None	Free
8-dlink8	Disabled	1-Default	Disabled	None	None	Free
9-dlink9	Disabled	1-Default	Disabled	None	None	Free
10-dlink10	Disabled	1-Default	Disabled	None	None	Free

2. Under the *SSID Status* column, select an SSID, right-click the selected SSID, and click **Edit**. The following page will appear.

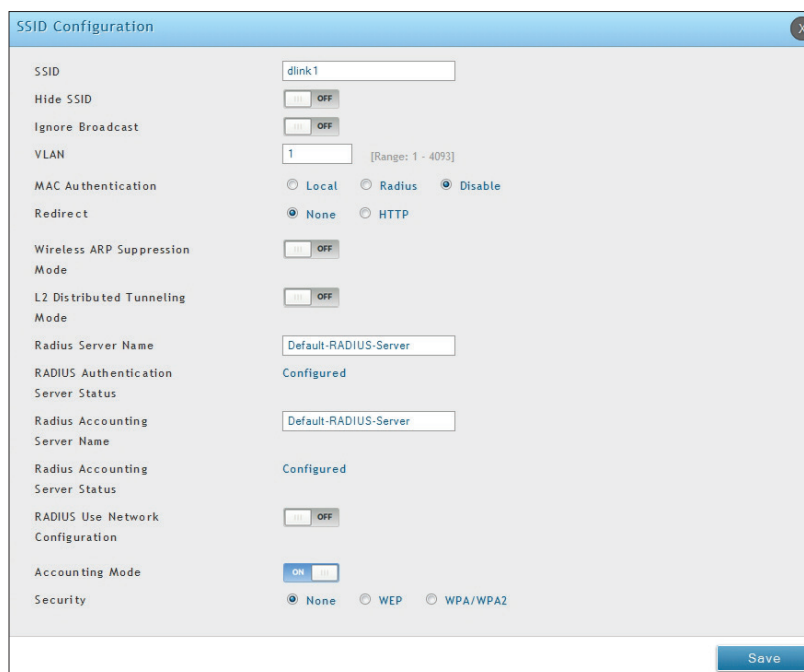

The screenshot shows the 'SSID Configuration' dialog box. The configuration options are as follows:

- SSID: dlink1
- Hide SSID: OFF
- Ignore Broadcast: OFF
- VLAN: 1 [Range: 1 - 4093]
- MAC Authentication: Local, Radius, **Disable**
- Redirect: **None**, HTTP
- Wireless ARP Suppression Mode: OFF
- L2 Distributed Tunneling Mode: OFF
- Radius Server Name: Default-RADIUS-Server
- RADIUS Authentication Server Status: Configured
- Radius Accounting Server Name: Default-RADIUS-Server
- Radius Accounting Server Status: Configured
- RADIUS Use Network Configuration: OFF
- Accounting Mode: **ON**, OFF
- Security: **None**, WEP, WPA/WPA2

3. Complete the Security fields on the SSID Profile Configuration page.

Field	Description
SSID	Enter the case-sensitive name of the wireless network. Be sure the SSID is same for all the devices in your wireless network.
VLAN	Enter a VLAN ID. Be sure this VLAN ID had been created on the VLAN Setting page (Network > VLAN > VLAN Setting).
Security	The default access point profile does not use any security mechanism. To protect your network, we recommend you select a security mechanism to prevent unauthorized wireless clients from gaining access to your network. Choices are: <ul style="list-style-type: none"> • None = no security mechanism is used. • WEP = enable WEP security. Complete the fields in Table 3-1. • WPA/WPA2 = enable WPA/WPA2 security. Complete the fields in Table 3-2.

Table 3-1 WEP Page Settings

Field	Description
Security	<ul style="list-style-type: none"> • Static WEP = uses static key management. You manually configure the same keys to encrypt data on both the wireless client and the access point. Dynamic WEP (WEP IEEE 802.1x) uses dynamically generated keys to encrypt client-to- access point traffic. Dynamic WEP is more secure than Static WEP, but you need a RADIUS server to manage the keys. • WEP IEEE 802.1X = screen refreshes, and there are no more fields to configure. The access point uses the global RADIUS server or the RADIUS server you specified for the wireless network.
Authentication	<p>Select the authentication type. Choices are:</p> <ul style="list-style-type: none"> • Open System = any wireless station can request authentication. The station that needs to authenticate with another wireless station sends an authentication management frame that contains the identity of the sending station. The receiving station returns a frame that indicates whether it recognizes the sending station. • Shared Key = each wireless station is assumed to have received a secret shared key over a secure channel that is independent from the 802.11 wireless network communications channel.
WEP Key Type	<p>Select the key type. Choices are:</p> <ul style="list-style-type: none"> • ASCII = upper- and lower-case alphabetic letters, numeric digits, and special symbols such as @ and #. • HEX = digits 0 to 9 and letters A to F.
WEP Key Length (bits)	<p>Select the length of the WEP key. Choices are:</p> <ul style="list-style-type: none"> • 64 = 64 bits • 128 = 128 bits
Tx	Transfer Key Index, indicates the WEP key that the access point uses to encrypt the data it transmits. To select a transfer key, click the button in front of the key number and the field where you enter the key.
WEP Keys	<p>You can specify four WEP keys. In each text box, enter a string of characters for each of the RC4 WEP keys shared with the stations using the access point. Use the same number of characters for each key. The number of keys you enter depends on the WEP Key Type and WEP Key Length selections. The following list shows the number of keys to enter in the field:</p> <ul style="list-style-type: none"> • 64 bit = ASCII: 5 characters; Hex: 10 characters • 128 bit = ASCII: 13 characters; Hex: 26 characters <p>Each client station must be configured to use one of these WEP keys in the same slot as specified here.</p>

Table 3-2 WPA/WPA2 Page Settings

Field	Description
Security	<p>If you select WPA for Security, the following two additional security options are displayed.</p> <ul style="list-style-type: none"> • WPA Personal = uses static key management. You manually configure the same keys to encrypt data on both the wireless client and access point. WPA Enterprise uses a RADIUS server and dynamically generated keys to encrypt client-to- access point traffic. WPA Enterprise is more secure than WPA Personal, but you need a RADIUS server to manage the keys. • WPA Enterprise = more secure than WPA Personal, but you need a RADIUS server to manage the keys. If you click this option, the screen refreshes and the WPA Key Type and WPA Key fields are hidden. The access point uses the global RADIUS server or the RADIUS server you specified for the wireless network.
WPA Versions	<p>Select the types of client stations you want to support. Choices are:</p> <p>WPA = if all client stations on the network support the original WPA but none supports WPA2, then select WPA.</p> <p>WPA2 = if all client stations on the network support WPA2, use WPA2, which provides the best security per the IEEE 802.11i standard.</p> <p>WPA and WPA2 = if you have a mix of clients that support WPA2 or WPA, select both the boxes. This lets both WPA and WPA2 client stations associate and authenticate, but uses the more robust WPA2 for clients who support it. This WPA configuration allows more interoperability, at the expense of some security.</p>
WPA Ciphers	<p>Select the cipher suite you want to use. Choices are:</p> <ul style="list-style-type: none"> • TKIP • CCMP (AES) • TKIP and CCMP (AES) <p>Both TKIP and AES clients can associate with the access point. WPA clients must have a valid TKIP key or AES-CCMP key to associate with the access point.</p> <p>Note: 802.11n clients cannot use the TKIP cipher. If you enable TKIP only, 802.11 clients cannot authenticate with the network.</p>
WPA Key Type	<p>Enter a WPA key type.</p> <p>Range: ASCII, including upper- and lower-case alphabetic letters, numeric digits, and special symbols such as @ and #</p>
WPA Key	<p>Enter the shared secret key for WPA Personal.</p> <p>Range: 8 – 62 characters, including upper- and lower-case alphabetic letters, numeric digits, and special symbols such as @ and #</p>
Bcast Key Refresh Rate (seconds)	<p>Enter a value to set the interval at which the broadcast (group) key is refreshed for clients associated to this VAP.</p> <p>Range: 0 - 86400 seconds (0 = broadcast key is not refreshed)</p>
Pre-Authentication	<p>If Security= WPA Enterprise, turn on to enable pre-authentication.</p>
Pre-Authentication Limit	<p>If Security= WPA Enterprise, the Pre-Authentication Limit field will appear below for you to enter a value between 0 and 192.</p>
Key Caching Hold Time	<p>If Security= WPA Enterprise, enter the amount of minutes a PMK will be held by the AP. This applies to Pairwise Master Keys (PMKs) generated by RADIUS, those that come from pre-authentication, and those that are forwarded to the AP. Note that this time limit can be overridden by RADIUS if the RADIUS server returns a longer time in the Session-Timeout attribute for a particular user. The valid values of this are from 1 – 1440 minutes. If you do not enter a value, APs will not forward the PMK for the wireless client to other APs in case the client roams to another AP.</p>
Session Key Refresh Rate	<p>If Security= WPA Enterprise, enter a value to set the interval at which the AP will refresh session (unicast) keys for each client associated to the VAP.</p> <p>The valid range is 0-86400 seconds. A value of 0 indicates that the broadcast key is not refreshed.</p>

- To add a new SSID, go to **Wireless > Access Point > SSID Profile** and click the **Add New SSID Profile** button.

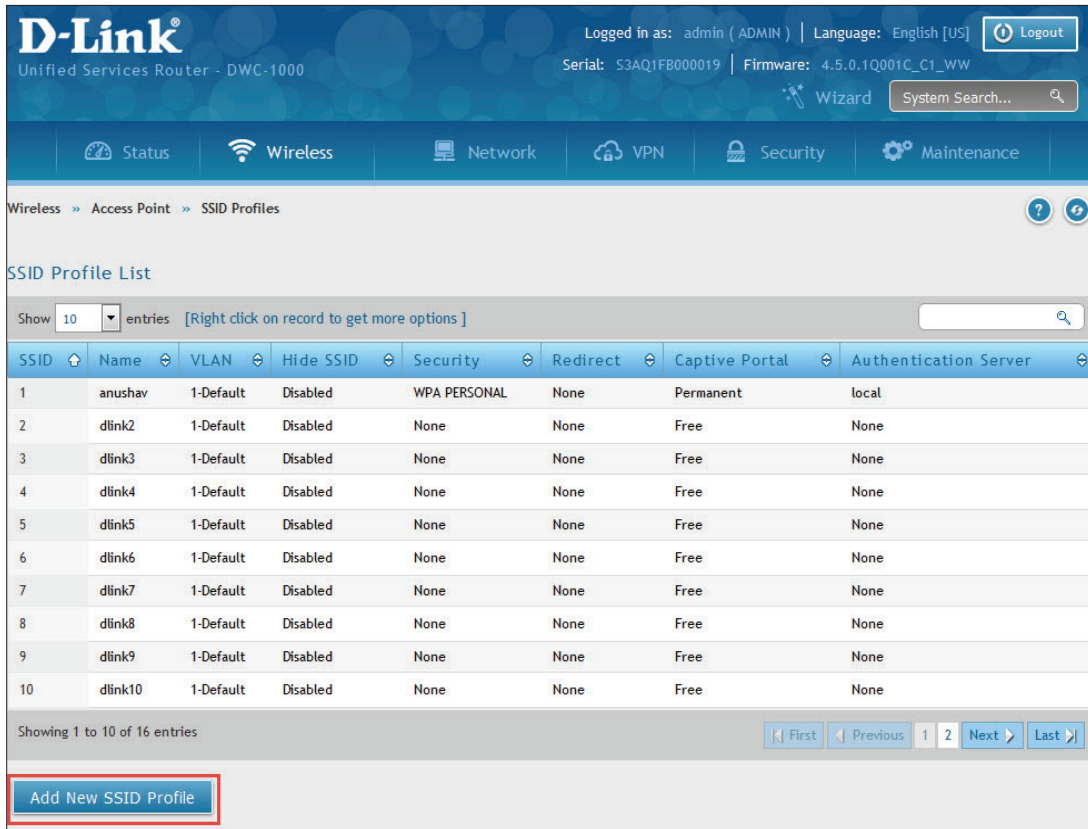

- Fill in the fields below and click **Save**.

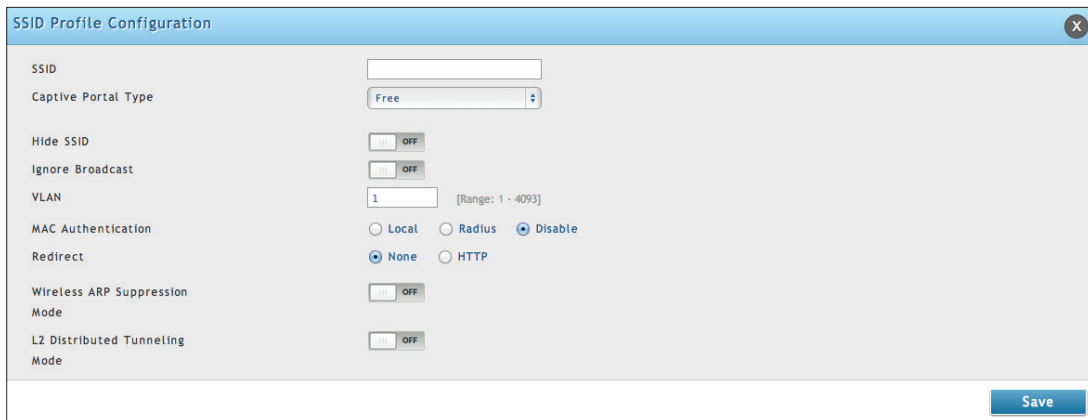

- Click **Wireless > Access Point > AP Profiles**. Click on the **AP Profile SSID** tab on the middle menu. The Access Point Profiles SSID List will appear.

The screenshot shows the D-Link Unified Services Router (DWC-1000) web interface. The user is logged in as 'admin (ADMIN)' and the language is set to 'English [US]'. The page title is 'Wireless > Access Point > AP Profile > AP Profile SSID'. The 'AP Profile SSID' tab is selected. Below the navigation tabs, there is a description: 'This page displays the virtual access point (VAP) settings associated with the selected AP profile. Each VAP is identified by its network number and Service Set Identifier (SSID). We can configure and enable up to 16 VAPs per radio on each physical access point.' The 'Access Point Profiles SSID List' section shows a dropdown for 'AP Profile' set to '1-Default' and 'Radio Mode' set to '802.11a/n/ac'. A table lists 10 SSID entries. The first entry, '1-anushav', is 'Enabled' with 'WPA Personal' security. The other 9 entries are 'Disabled' with 'None' security. The table has columns for SSID Name, SSID Status, VLAN, Hide SSID, Security, Redirect, and Captive Portal. At the bottom, it shows 'Showing 1 to 10 of 16 entries' and navigation buttons for 'First', 'Previous', '1', '2', 'Next', and 'Last'.

SSID Name	SSID Status	VLAN	Hide SSID	Security	Redirect	Captive Portal
1-anushav	Enabled	1-Default	Disabled	WPA Personal	None	Permanent
2-dlink2	Disabled	1-Default	Disabled	None	None	Free
3-dlink3	Disabled	1-Default	Disabled	None	None	Free
4-dlink4	Disabled	1-Default	Disabled	None	None	Free
5-dlink5	Disabled	1-Default	Disabled	None	None	Free
6-dlink6	Disabled	1-Default	Disabled	None	None	Free
7-dlink7	Disabled	1-Default	Disabled	None	None	Free
8-dlink8	Disabled	1-Default	Disabled	None	None	Free
9-dlink9	Disabled	1-Default	Disabled	None	None	Free
10-dlink10	Disabled	1-Default	Disabled	None	None	Free

- Select the SSID you wish to edit from the AP Profile drop-down menu.
- Click the radio button next to the Radio Mode you prefer.
- Select the SSID you wish to configure on the radio from SSID Name drop-down menu or right-click the SSID network you want to enable, and click **Enable** on the AP Profile SSID List.

Note: SSID ID 1 is always enabled. If you do not want to have the first SSID enabled, you must create a new SSID to be able to swap another SSID in the first slot.

Step #5: Select MAC Authentication Mode

MAC authentication is useful in networks that operate in Open mode to grant and deny access to clients with specific MAC addresses. MAC Authentication can also be used in conjunction with 802.1X security methods, in which case MAC Authentication is done prior to 802.1X authentication. To enable MAC authentication, wireless clients must first be authenticated by the Unified Access Point (UAP) in order to connect to the network.

The wireless controller provides two MAC Authentication Mode, the white-list or the black-list.

White-list: Select this option to grant access to any wireless clients with MAC addresses that are specified in the MAC Authentication database or RADIUS server, and are not explicitly denied access. If the MAC address is not in the database, then the access will be denied to the client.

Black-list: Select this option to deny access to any wireless clients with MAC addresses that are specified in the MAC Authentication database or RADIUS server, and are not explicitly granted access. If the MAC address is not in the database, then the access will be granted to the client.

1. Click **Wireless > General**.
2. Next to *Client MAC Authentication Mode*, select **Black-list** or **White-list**. Click **Save**.

The screenshot shows the D-Link Unified Controller web interface. The top navigation bar includes 'Status', 'Wireless', 'Network', 'Security', and 'Maintenance'. The 'Wireless > General' page is displayed, showing various configuration options for the WLAN Global Setup. The 'Client MAC Authentication Mode' section is highlighted with a red box, showing two radio buttons: 'White-list' (selected) and 'Black-list'. Other visible settings include IP Address (192.168.10.1), Peer Group ID (1), Client Roam Timeout (30), Ad Hoc Client Status Timeout (24), AP Failure Status Timeout (24), RF Scan Status Timeout (24), Detected Clients Status Timeout (24), Tunnel IP MTU Size (1500), Cluster Priority (1), AP Client QoS (OFF), Radius Authentication Server (Default-RADIUS-Server), Radius Authentication Server Status (Configured), Radius Accounting Server (Default-RADIUS-Server), Radius Accounting Server Status (Configured), Global Accounting Mode (OFF), AP Validation (Local), Require Authentication Passphrase (OFF), Manage AP with Previous Release Code (OFF), and Country Code (US - United States). 'Save' and 'Cancel' buttons are at the bottom.

3. Click **Security > Authentication > User Database > MAC Authentication**. The MAC Authentication setting page will appear. The *List Type* will display what your selection was in Step 2.

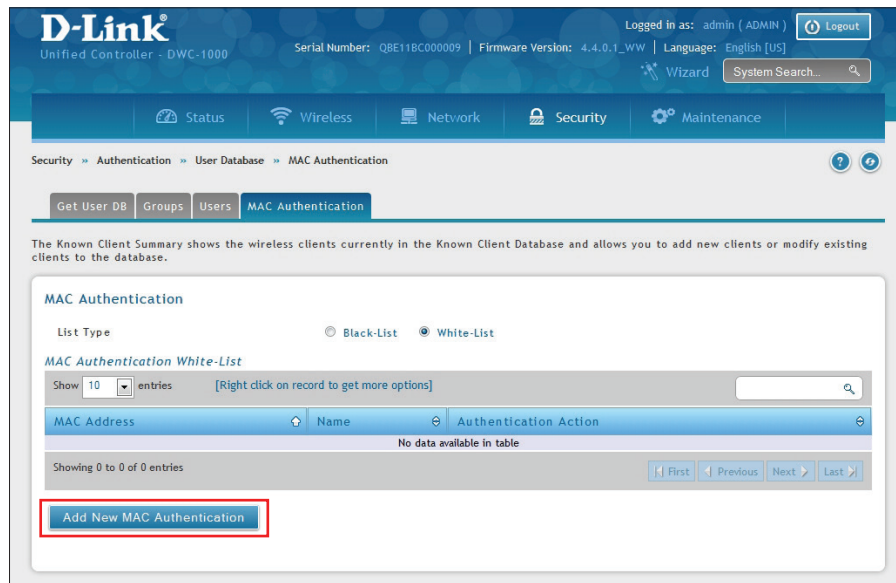

4. Click **Add New MAC Authentication**. Fill in the client's MAC address, name and authentication action, and then click **Save**.

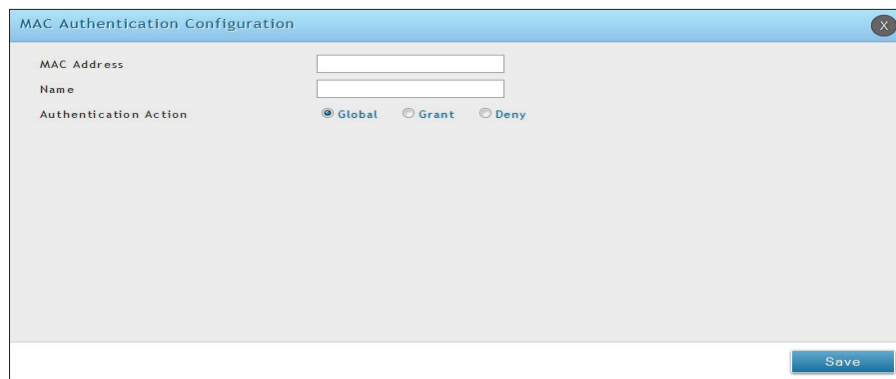

5. Click **Wireless > Access Point > SSID Profiles**.
6. Select an SSID by right-clicking on it and click **Edit**. The following page will appear. Select **Local**, and click **Save**.

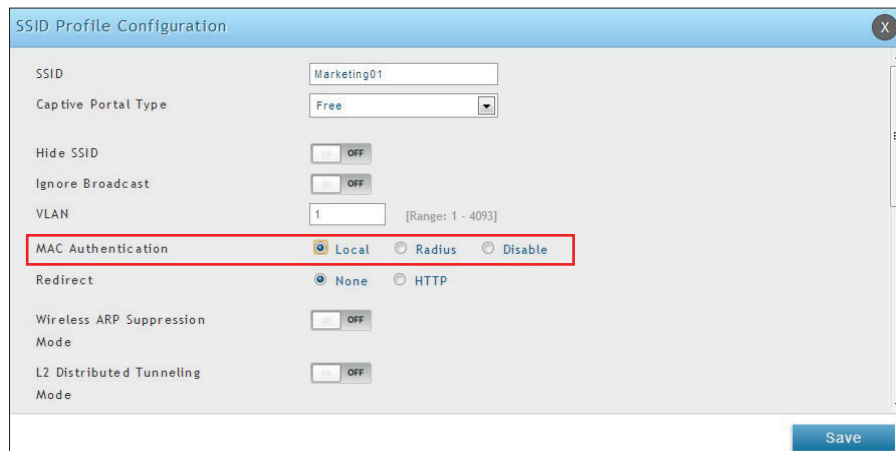



Step #6: Confirm Access Point Profile is Associated

Use the following procedure to confirm that the access point profile is associated with the wireless controller.

Note: Each time you change configuration settings, perform this procedure to apply the changes to the access point.

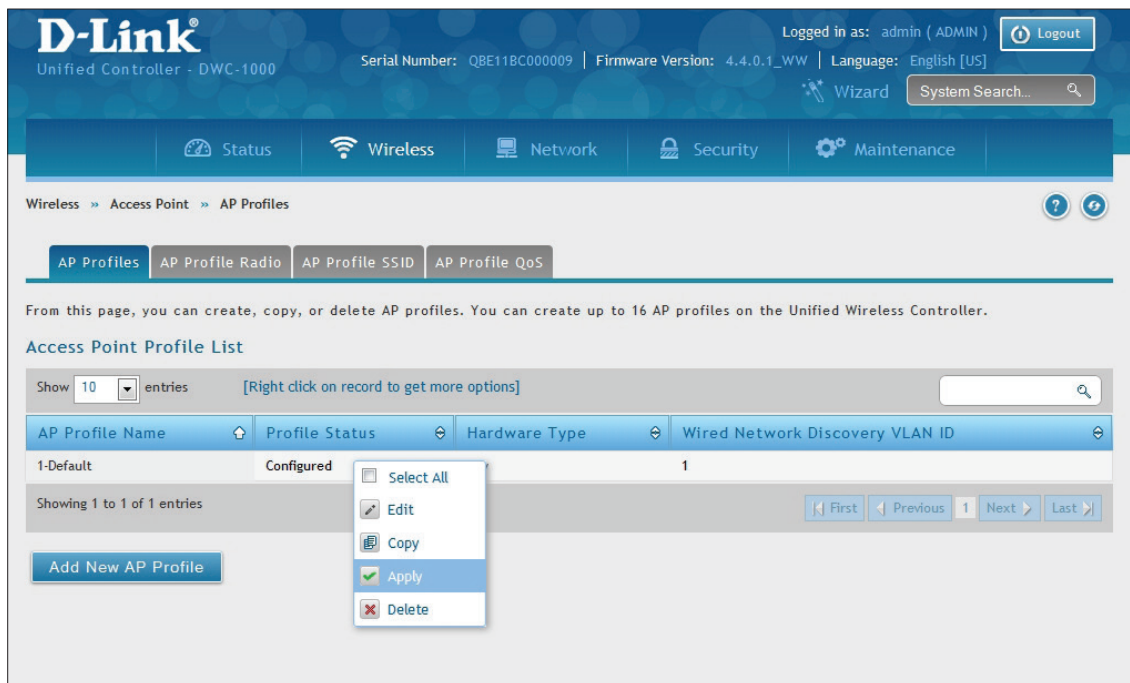
1. Go to **Wireless > Access Point > AP Profile**.



2. Under *Access Point Profile List*, right-click the AP profile you want to update, and click **Apply**.
3. Wait for 30 seconds, and then click the refresh icon  to verify that the profile is associated. Your associated access point is configured and ready to authenticate wireless users.

Step #7: Configure Captive Portal Settings

Configuring the wireless controller's captive portal settings with local database is a 4-step process:

1. Create a captive portal group
 - a. Go to **Security > Authentication > User Database > Groups**. The Groups List page will appear.

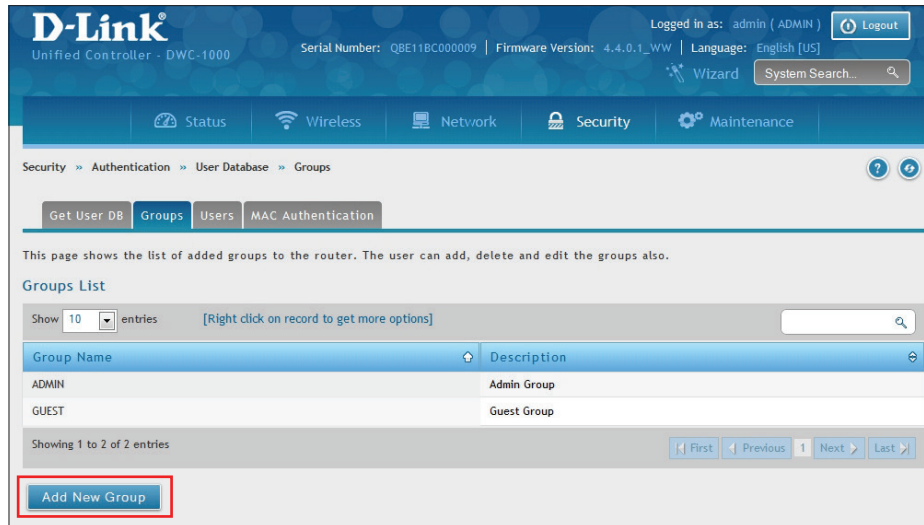

- b. Click **Add New Group**. The Group Configuration page will appear.

- c. Complete the fields given in the table below, and click **Save**.

Field	Description
Group Name	Enter a name for the group.
Description	Enter a description of the group.
Captive Portal User	Enable (toggle to ON) this option under <i>User Type</i> .

2. Add captive portal users

- a. Go to **Security > Authentication > User Database > Users**. The Users List will appear.

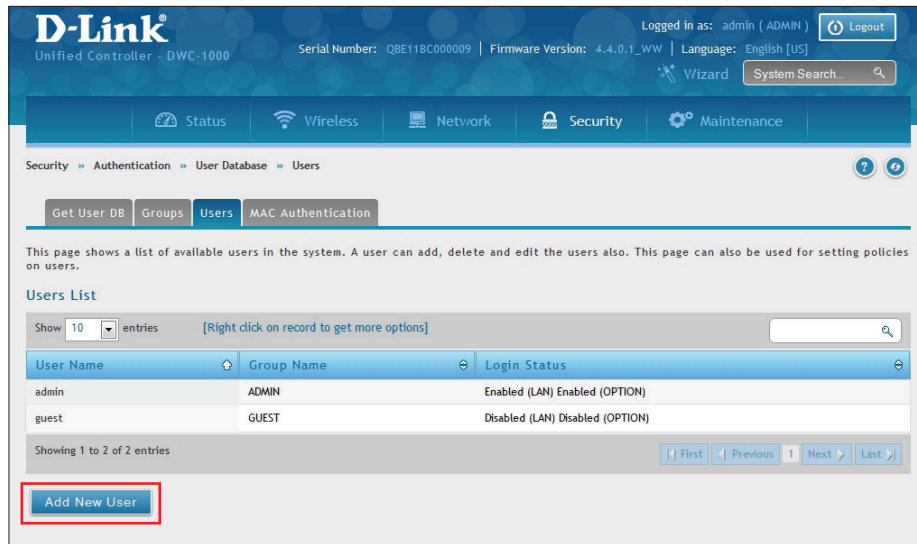

- b. Click **Add New User**. The User Configuration page will appear.

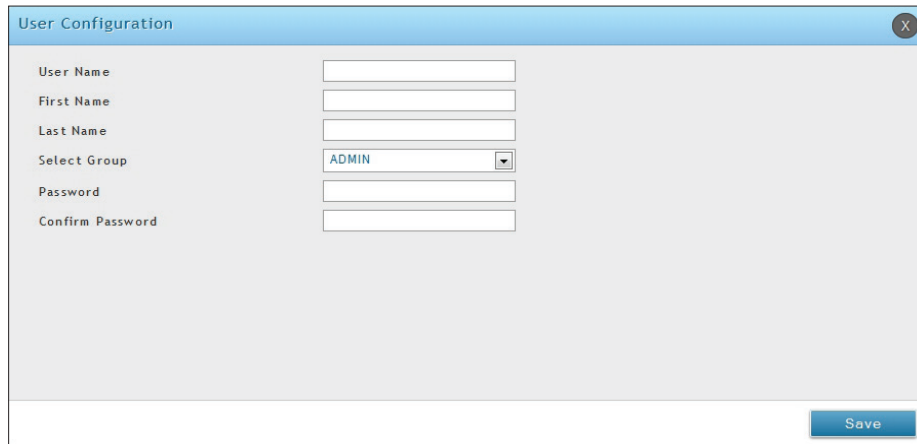

c. Complete the fields in the table below and click **Save**.

Field	Description
User Name	Enter a unique name for this user. The name should allow you to easily identify this user from others you may add.
First Name	Enter the first name of the user. This is useful when the authentication domain is an external server, such as RADIUS.
Last Name	Enter the last name of the user. This is useful when the authentication domain is an external server, such as RADIUS.
Select Group	Select the captive portal group to which this user will belong.
Edit Password	This is the option for administrator to enable/ disable "change Password" link in Captive Portal page.
Password	Enter a case-sensitive password that the user must specify before gaining access to the Internet. For security, each typed password character is masked with a dot (•).
Confirm Password	Enter the same case-sensitive password entered in the Password field. For security, each typed password character is masked with a dot (•).

3. Associate the captive portal group to an SSID Profile
 - a. Click **Wireless > Access Point > SSID Profiles**.

The screenshot shows the D-Link Unified Controller web interface. The top navigation bar includes Status, Wireless, Network, Security, and Maintenance. The breadcrumb trail is Wireless > Access Point > SSID Profiles. Below the breadcrumb, there is a description: "This page shows all the wireless SSID configured on the controller. The first 16 SSID's are created by default. You can modify the default SSID, but we cannot delete them. You can add and configure up to 16 additional SSID for a total of 32 wireless SSID." Below this is the "SSID Profile List" table.

SSID	Name	VLAN ID	Hide SSID	Security	Redirect	Captive Portal	Authentication Server
1	dlink1	1-Default	Disabled	None	None	Free	None
2	dlink2	1-Default	Disabled	None	None	Free	None
3	dlink3	1-Default	Disabled	None	None	Free	None
4	dlink4	1-Default	Disabled	None	None	Free	None
5	dlink5	1-Default	Disabled	None	None	Free	None
6	dlink6	1-Default	Disabled	None	None	Free	None
7	dlink7	1-Default	Disabled	None	None	Free	None
8	dlink8	1-Default	Disabled	None	None	Free	None
9	dlink9	1-Default	Disabled	None	None	Free	None
10	dlink10	1-Default	Disabled	None	None	Free	None

Below the table, there is a "Showing 1 to 10 of 16 entries" indicator and navigation buttons (First, Previous, 1, 2, Next, Last). An "Add New SSID Profile" button is located at the bottom left.

- b. Under the SSID column, right click the selected SSID that will use the Captive Portal function and click **Edit**. The following page will appear.

The screenshot shows the "SSID Profile Configuration" dialog box. The SSID field is set to "dlink1". The Captive Portal Type dropdown menu is open, showing options: Free (selected), SLA, Permanent User, Temporary User, and Billing User. The VLAN ID field is set to "1" with a range of [1 - 4093]. The MAC Authentication radio buttons are Local, Radius, and Disable (selected). The Redirect radio buttons are None (selected) and HTTP. The Wireless ARP Suppression Mode and L2 Distributed Tunneling Mode are both set to OFF. A "Save" button is located at the bottom right.

- c. Select a user type from the drop-down menu next to *Captive Portal Type*. Choosing **Free** will allow immediate access through the Captive Portal; choosing **SLA** will require the end user to agree to a service level agreement before being allowed access. Choosing **Permanent User** will allow for selecting an authentication method such as local user database, RADIUS, LDAP, or POP3. Choosing **Temporary User** or **Billing User** the authentication method is local user database.

In this case, the user account in the local database is a permanent user account. Select **Permanent User** on *Captive Portal Type* and select **Local User Database** on *Authentication Server*.

- d. Select the customized login page from the *Login Profile Name* drop-down menu.
- e. Click **Save**.

The captive portal is now associated to the selected SSID. To test your configuration from a client, connect to the captive portal SSID to log in to the captive portal. Enter an IP address on the captive portal network to see the controller redirect request to the captive portal page.

If the authentication database is using the RADIUS server, on step c above choose **Permanent User** on *Captive Portal Type* and select **RADIUS Server** on *Authentication Server*.

4. Customize the captive portal login page.

- a. Go to **Security > Authentication > Login Profiles**. The Login Profiles page will appear.

The screenshot shows the D-Link Unified Controller web interface. The top navigation bar includes the D-Link logo, 'Unified Controller - DWC-1000', and system information: 'Serial Number: QBE11BC000009', 'Firmware Version: 4.4.0.1_WW', and 'Language: English [US]'. The user is logged in as 'admin (ADMIN)' with a 'Logout' button. The main navigation menu includes 'Status', 'Wireless', 'Network', 'Security', and 'Maintenance'. The current page is 'Security > Authentication > Login Profiles'. Below the navigation, there are tabs for 'Login Profiles', 'SLA', and 'Custom CP Profiles'. A descriptive text states: 'The table lists all the available Login Profiles in the system. This Login page is used for authentication on Captive Portal enabled interfaces.' The 'Login Profiles List' section shows a table with columns for 'Profile Name', 'Browser Title', and 'Status'. There are two entries: 'default' and 'default2', both with 'D-link Wireless Controller' as the browser title and 'Not In Use' as the status. The table has a search bar and pagination controls showing 'Showing 1 to 2 of 2 entries'. An 'Add New Login Profile' button is located at the bottom left of the table area.

Profile Name	Browser Title	Status
default	D-link Wireless Controller	Not In Use
default2	D-link Wireless Controller	Not In Use

- b. Under the *Login Profiles List*, click **Add New Login Profile** to add a new profile or right-click an existing profile and click **Edit** to edit the profile. The Login Profile Configuration page will appear.

Login Profile Configuration
✕

General Details

Profile Name

Browser Title

Background Image Color

Page Background Image

Default [Add](#) [Add](#) [Add](#) [Add](#) [Add](#) [Add](#)

Header Details

Background Image Color

Header Background Image

Default [Add](#) [Add](#) [Add](#) [Add](#) [Add](#) [Add](#)

[Add](#) [Add](#) [Add](#) [Add](#) [Add](#) [Add](#)

Header Caption

Caption Font

Font Size

Font Color

Login Details

Login Section Title

Welcome Message

Error Message

Footer Details

Change Footer Content

Footer Content

Footer Font Color

External Payment Gateway

Enable External Payment Gateway

Session Title 1

Message

Session Title 2

Success Message

Session Title 3

Failure Message

Enable Billing Profiles

Profile Name	Billing Status	Description	Status
No data available in table			

Service Disclaimer Text

Payment Server

- c. Complete the fields in the table below and click **Save**. The message *Operation Succeeded* will appear.

Field	Description
General Details	
Profile Name	Enter a name for this captive portal profile. The name should allow you to differentiate this captive profile from others you may set up.
Browser Title	Enter the text that will appear in the title of the browser during the captive portal session.
Background	Select whether the login page displayed during the captive portal session will show an image or color. Choices are: <ul style="list-style-type: none"> • Image = displays an image as the background on the page. Use the Page Background Image field to select a background image. • Color = sets the background color on the page. Select the color from the drop-down menu
Page Background Image	If you set <i>Background</i> to Image , upload the image file by clicking Add > Browse . Select an image, click Open and then click the Upload button. The maximum size of the image is 100 kb.
Page Background Color	If you set <i>Background</i> to Color , select the background color of the page that will appear during the captive portal session from the drop-down menu.
Custom Color	If you choose Custom on Page Background Color, enter the HTML color code.
Header Details	
Background	Select whether the login page displayed during the captive portal session will show an image or color. Choices are: <ul style="list-style-type: none"> • Image = show image on the page. Use the Header Background Color field to select a background color. The maximum size of the image is 100 kb. • Color = show background color on the page. Use the radio buttons to select an image.
Header Background Image	If you set <i>Background</i> to Image , upload the image file by clicking Add > Browse . Select an image, click Open and then click the Upload button. The maximum size of the image is 100 kb.
Header Background Color	If you set <i>Background</i> to Color , select the header color from the drop-down menu.
Custom Color	If you choose Custom on Page Background Color, you can choose particular color by filling in the HTML color code.
Header Caption	Enter the text that appears in the header of the login page during the captive portal session.
Caption Font	Select the font for the header text.
Font Size	Select the font size for the header text.
Font Color	Select the font color for the header text.

Field	Description
Login Details	
Login Section Title	Enter the text that appears in the title of the login box when the user logs in to the captive portal session. This field is optional.
Welcome Message	Enter the welcome message that appears when users log in to the captive session successfully. This field is optional.
Error Message	Enter the error message that appears when users fail to log in to the captive session successfully. This field is optional.
Footer Details	
Change Footer Content	Enables or disables changes to the footer content on the login page.
Footer Content	If Change Footer Content is checked, enter the text that appears in the footer.
Footer Font Color	If Change Footer Font Color is checked, select the color of the text that appears in the footer.

- d. Under *Login Profiles List*, right-click the profile and click **Show Preview** to view the profile you just configured. Confirm that the appearance of the login page suits your requirements. If not, repeat steps 4b and 4c as necessary.

Step #8: Use SSID with RADIUS Sever as Authenticator

To use SSID with RADIUS authentication, perform the following procedure.

1. Go to **Security > Authentication > External Auth Server > RADIUS Server** page.

The screenshot shows the 'RADIUS Server Configuration' page. At the top, there are navigation tabs: Status, Wireless, Network, VPN, Security, and Maintenance. Below these, the breadcrumb path is 'Security > Authentication > External Auth Server > RADIUS Server'. There are also sub-tabs: RADIUS Server (selected), RADIUS Accounting, POP3 Server, POP3 Trusted CA, LDAP Server, AD Server, and NT Domain.

The main content area contains a descriptive paragraph: 'This page configures the RADIUS servers to be used for authentication. A RADIUS server maintains a database of user accounts used in larger environments. If a RADIUS server is configured in the LAN, it can be used for authenticating users that want to connect to the wireless network provided by this device. If the first/primary RADIUS server is not accessible at any time, then the device will attempt to contact the secondary RADIUS server for user authentication.'

Below the text is the 'Radius Server Configuration' section. It features a 'Server Check' button labeled 'Server Checking'. The configuration is organized into three identical blocks, each representing a RADIUS server:

- Server 1:** Authentication Server 1 IP Address: 192.168.1.2; Authentication Port: 1812; Secret: [masked]; Timeout: 1; Retries: 2.
- Server 2:** Authentication Server 2 IP Address: 192.168.1.3; Authentication Port: 1812; Secret: [masked]; Timeout: 1; Retries: 2.
- Server 3:** Authentication Server 3 IP Address: 192.168.1.4; Authentication Port: 1812; Secret: [masked]; Timeout: 1; Retries: 2.

At the bottom of the configuration area are 'Save' and 'Cancel' buttons.

2. Complete the fields given below and click **Save**. Your access point will be configured to use RADIUS authentication server.
3. Click **Server Checking** to test the connection between the DWC-1000 and your RADIUS server.

Field	Description
Server Checking	Click to test the connection between the controller and your RADIUS server.
Authentication Server IP Address	IP address of your RADIUS authentication server.
Authentication Port	RADIUS authentication port number to send RADIUS messages.
Secret	Enter the secret key that allows the device to log into the configured RADIUS server. It must match the secret on RADIUS server.
Timeout	Set the timeout in seconds. The controller should wait for a response from the RADIUS server.
Retries	The number of tries the controller will make to the RADIUS server before giving up.

Step #9: Configure Guest Management

The wireless controller can generate temporary guest accounts from the front desk manage accounts. To configure guest management, perform the following procedure.

1. Create a front desk group.
 - a. Go to **Security > Authentication > User Database > Groups**. The Groups List page will appear.
 - b. Click **Add New Group**. The Group Configuration page will appear.
 - c. Fill in the group name and description, and select **Front Desk** as the *User Type*.

The screenshot shows a 'Group Configuration' dialog box with the following fields and options:

- Group Name: [Empty text box]
- Description: [Empty text box]
- User Type:
 - Admin
 - Network
 - Front Desk
 - Guest
- Idle Timeout: [10] [Default: 10, Range: 1 - 999] Minutes
- Save button at the bottom right.

2. Add front desk users.
 - a. Go to **Security > Authentication > User Database > Users**. The Users List will appear.
 - b. Click **Add New User**. The User Configuration page will appear.
 - c. Complete the fields and select the front desk group you created in the previous step on Selected Group.

The screenshot shows a 'User Configuration' dialog box with the following fields and options:

- User Name: [jlee]
- First Name: [john]
- Last Name: [lee]
- Select Group: [FD1] (dropdown menu)
- Password: [Masked with dots]
- Confirm Password: [Masked with dots]
- Save button at the bottom right.

3. Create a billing profile.
 - a. Go to **Security > Authentication > Billing Profile**. Click **Add New Billing Profile**.
 - b. The billing profile settings include four milestones by timeline:

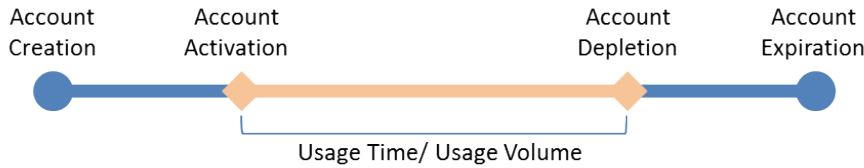

- Account Creation: the temporary account is generated by front desk account in the local database.
- Account Activation: the temporary account is activated and it is valid for use.
- Account Depletion: the temporary account is running out of the usage time or usage volume.
- Account Expiration: the temporary account is expired no matter usage time/ volume running out or not, and it is removed from the local database.

Below are five most common types of billing profiles:

- I. The temporary account usage time is limited by duration. The account has the expiration time. The account is valid while the account is created.

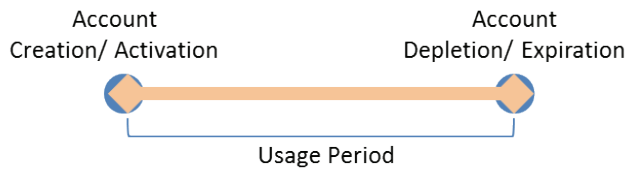

This billing profile is suitable for the scenario in Hotel. The temporary account is created and valid while customers check-in.

- II. The temporary account usage time is limited by duration. The account has the expiration time. The account is valid while the account first logs in.

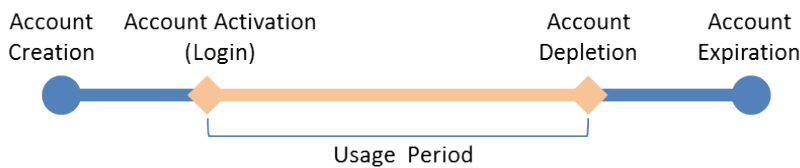

This billing profile is suitable for the scenario in Coffee Shop, Airport, etc. The customer can use wireless internet service for a period of time counting from first time logs in.

III. The temporary account is valid with specific date and time. The account has the expiration time.

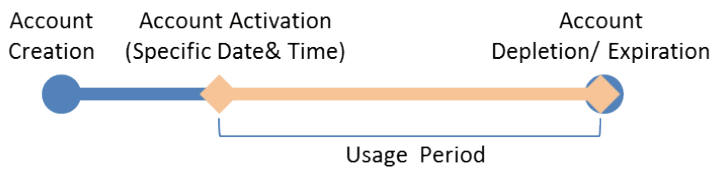

This billing profile is suitable for the scenario in Press Conference. The organizer generates accounts before the event and deliver the account information to the participator in advance, if necessary. The temporary account would be only valid from specific date and time.

IV. The temporary account has limited time usage. The account doesn't have the expiration time until the usage is run out.

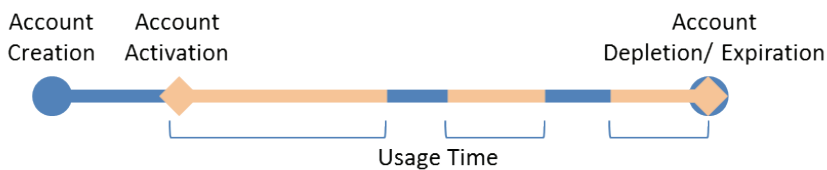

This billing profile is suitable for the scenario in Hotspot. The service provider charge the wireless service based on usage time. This account allows multiple devices log in at the same time.

V. The temporary account has limited usage traffic. The account doesn't have the expiration time until the usage is run out.

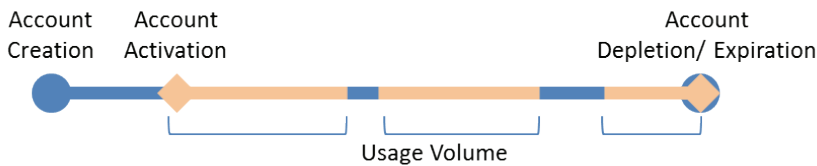

This billing profile is suitable for a Hotspot scenario. The service provider charge the wireless service based on usage volume.

c. Complete the fields given below:

The screenshot shows a web-based configuration window titled 'Captive Portal Billing Profile Configuration'. It contains several sections:

- Profile Details:** Includes text input fields for 'Profile Name' and 'Profile Description'.
- Allow Multiple Login:** A checkbox currently set to 'OFF'.
- Allow Customized account on Front Desk:** A checkbox currently set to 'OFF'.
- Allow batch generation on Front Desk:** A checkbox currently set to 'OFF'.
- Session Idle Timeout:** A text input field with a dropdown menu set to 'Hour' and a note '[Default: 10, Range: 1 - 60] Minutes'.
- Show alert message on login page while rest of usage time/traffic under:** A text input field.
- Basic Limit by Duration:** A checkbox currently set to 'OFF'.
- Basic limit by usage:** A checkbox currently set to 'OFF'.
- Maximum Usage Time:** A checkbox currently set to 'OFF'.
- Maximum Usage Traffic:** A checkbox currently set to 'OFF'.
- Unit Price:** A checkbox currently set to 'OFF'.
- Set Price:** A text input field.

 A 'Save' button is located at the bottom right of the window.

Field	Description
Profile Details	
Profile Name	Each profile will be having a profile Name to identify itself.
Profile Description	This is the description of the profile
Allow Multiple Login	Checking this option will allow multiple users to use same captive portal login credentials created for this profile to login simultaneously.
Allow Customized Account on Front Desk	Checking this option enables the front desk user to give customized account name to the captive portal users being created on this profile.
Allow Batch Generation on Front Desk	Checking this option enables the front desk user to generate a batch of temporary captive portal users at one click.
Session Idle Timeout	Idle timeout for CP users generated for this profile.
Show Alert Message on Login Page while Rest of Usage Time/Traffic Under	Enter a value here in Hours/Days/MB/GB to get an alert message when the usage time/traffic left reaches the desired limit. By default if 0 is entered, it implies no alert message is required.
Basic Limit by Duration	
Valid with Begin and End Time	Limitations on the basis of duration
Valid Begin	If you enable <i>Valid with Begin and End Time</i> , there are 3 types of limiting user access by duration: <ol style="list-style-type: none"> 1. Start While Account Created: Activate account when user is created 2. Start While Account Login: Activate account when user first login using his credentials. 3. Begin From: Activate account from the respective date
Start While Account Created	If you select <i>Start While Account Created</i> , enter a value in Hours/Days to set duration of usage time.
Start While Account Login	If you select <i>Start While Account Login</i> , enter a value in Hours/Days to set duration of usage time.
Begin From	If you choose <i>Begin From</i> , select a specific time and date for the account to become valid.
End to	If you choose <i>Begin From</i> , select a specific time and date for the account to get expired.
Allow Front Desk to Modify Duration	If you enable <i>Valid with Begin and End Time</i> , checking this option enables the front desk user to modify duration limits.
Basic Limit by Usage	
Maximum Usage Time	Maximum time for which the user can stay login before his account expires.
Maximum Usage Traffic	Maximum traffic that the user can use before his account expires. Only inbound traffic shall be considered towards bandwidth usage.
Allow Front Desk to Modify Usage	If you enable <i>Maximum Usage Time</i> or <i>Maximum Usage Traffic</i> , checking this option enables the front desk user to modify usage limits.

4. Select an Interface for the guest captive portal.
 - a. Click **Wireless > Access Point > SSID Profiles**. The SSID Profile List page will appear.
 - b. Under the SSID column, right click the selected SSID that will use the Captive Portal function and click **Edit**.
 - c. Select a Captive Portal Type from the drop-down menu.
 - d. Click **Save**.

Note: Apply AP Profile from Wireless > Access Point > AP Profiles if the SSID have been associated with a used AP Profile to change the configuration.
5. Generate guest accounts.
 - a. Log in the Front Desk page by entering http://<ip_address>/frontdesk (e.g., http://192.168.10.1/frontdesk). Enter the username and password of the user you created in a "Front Desk" group.

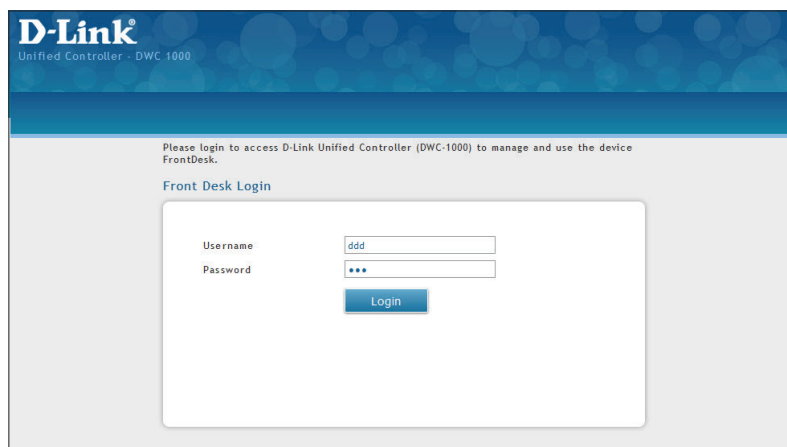

- b. This will open a billing desk page as shown in the figure below. Modify the usage if you want. Click **Generate**.

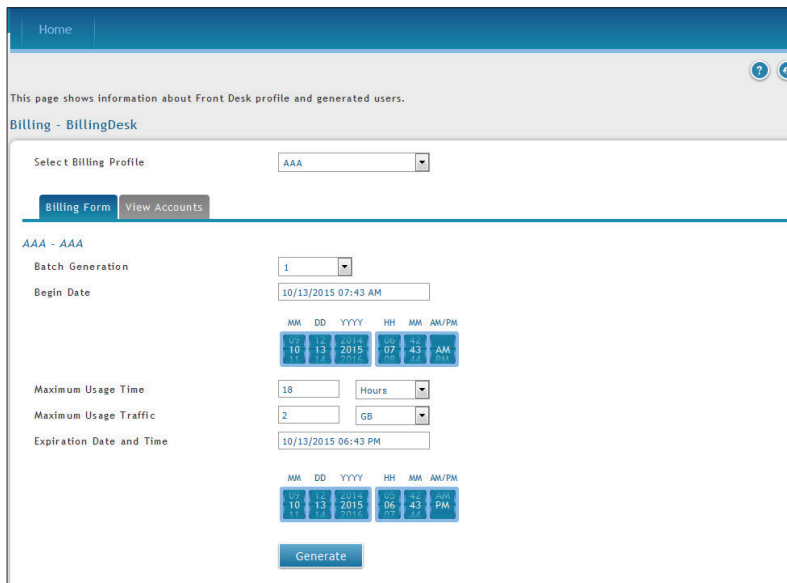

c. Click **Print Ticket**.

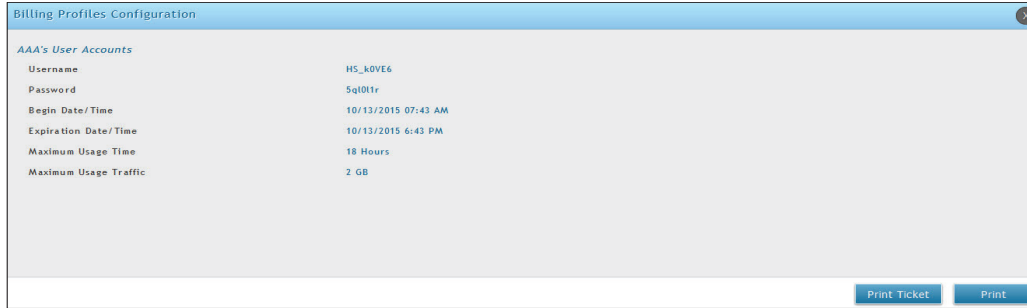

d. This creates the following ticket for the customer. Only one user account can be created at a time.

Internet			
Network:	dlink1	Password:	5q101r
Username:	HS_k0VE6	Begin:	10/13/2015 07:43
Begin:	10/13/2015 07:43	Expire:	10/13/2015 18:43
Max Time:	18 Hours	Traffic:	2 GB
10/13/2015 06:45			

e. The **Print** button will provide a print out of the Billing Profile Configuration page .

6. Monitor user account status.

a. Monitor temporary account status and extend account usage duration or volume. Click **View Account** for reviewing generated temporary status.

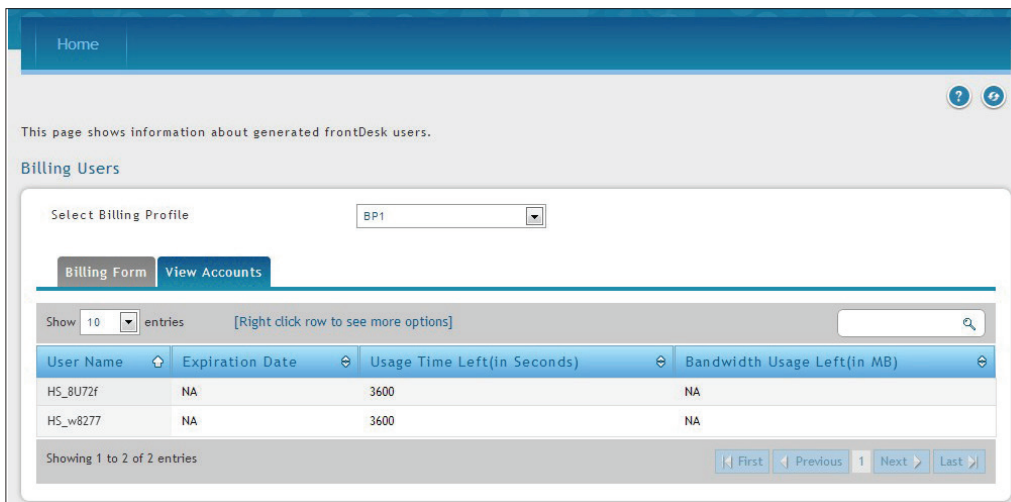

- b. Select an account and right-click **View Details** to view more information.

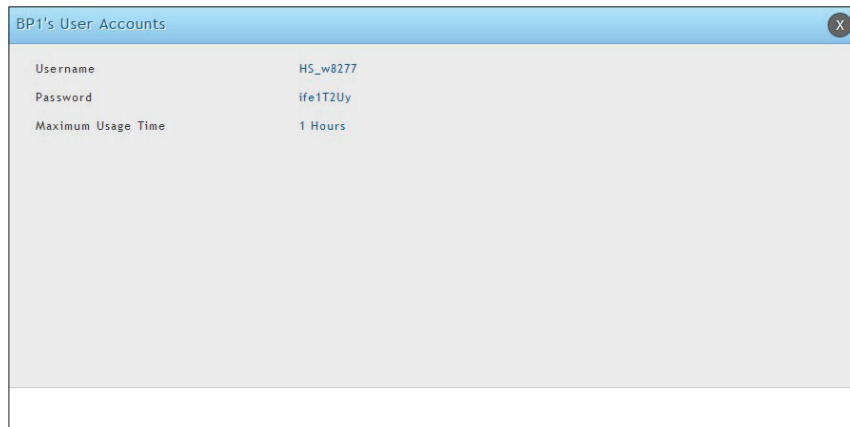

- 7. Extend user account usage.
 - a. Select an account and right-click **Extend Session**. Manually change the usage time/traffic.

Note: Make sure that **Allow Front Desk to Modify Usage** is turned ON in the "Captive Portal Billing Profile Configuration" page.

- b. Click **Save**.

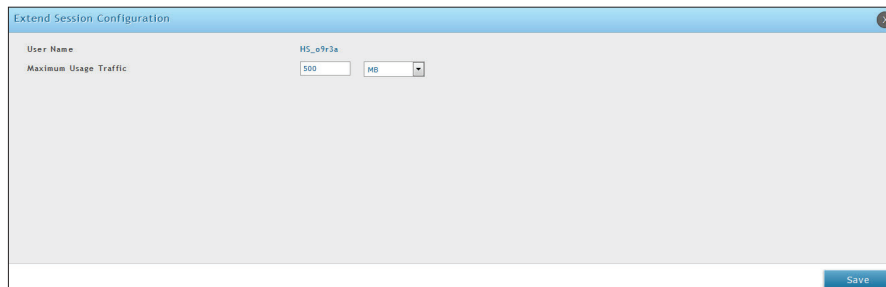

Where to Go from Here

After installing the basic configuration procedures, the wireless controller is ready for operation using the factory default settings in Appendix B. These settings should be suitable for most users and most situations.

The wireless controller also provides advanced configuration settings for users who want to take advantage of the more advanced features of the wireless controller. The following sections list the wireless controller's advanced settings. Users who do not understand these features should not attempt to reconfigure their wireless controller, unless advised to do so by the technical support staff.

Advanced WLAN Configuration

While the basic configuration described in the previous chapter is satisfactory for most of the users, large wireless networks or a complex setup may require the wireless controller's advanced configuration settings to be configured.

This chapter covers the following commonly used advanced wireless configuration settings.

- "WLAN General Settings" on page 58
- "Channel Plan and Power Settings" on page 61
- "WIDS" on page 65
- "ACL" on page 70
- "DiffServ" on page 86
- "Distributed Tunnel" on page 92
- "WLAN Visualization" on page 93
- "AP Discovery Methods" on page 95
- "Managed APs" on page 98
- "AP Profiles" on page 105
- "SSID Profiles" on page 118
- "Wireless Distribution System (WDS)" on page 122
- "Peer Group" on page 128
- "AP Firmware Download" on page 131

Note: *The procedures in this chapter should only be performed by expert users who understand networking concepts and terminology.*

WLAN General Settings

The WLAN General Configuration page contains the global configuration settings for all managed APs and the wireless controller including WLAN Global Setup, AP Validation, and Country Configuration.

Path: Wireless > General

To configure the WLAN general settings:

1. Click **Wireless > General**. The WLAN General Settings page will appear.

The screenshot shows the D-Link Unified Controller web interface. The top navigation bar includes 'Status', 'Wireless', 'Network', 'Security', and 'Maintenance'. The 'Wireless' menu is selected, and the 'General' sub-menu is active. The page title is 'WLAN General Setup' and it includes a 'Save' and 'Cancel' button at the bottom.

WLAN Global Setup

WLAN Controller Operational Status	<input checked="" type="checkbox"/> ON
IP Address	192.168.10.1
Peer Group ID	<input type="text" value="1"/> [Default: 1, Range: 1 - 255]
Client Roam Timeout	<input type="text" value="30"/> [Range: 1 - 120] Seconds
Ad Hoc Client Status Timeout	<input type="text" value="24"/> [Range: 0 - 168] Hours
AP Failure Status Timeout	<input type="text" value="24"/> [Range: 0 - 168] Hours
Client MAC Authentication Mode	<input checked="" type="radio"/> White-list <input type="radio"/> Black-list
RF Scan Status Timeout	<input type="text" value="24"/> [Range: 0 - 168] Hours
Detected Clients Status Timeout	<input type="text" value="24"/> [Range: 0 - 168] Hours
Tunnel IP MTU Size	<input checked="" type="radio"/> 1500 <input type="radio"/> 1520
Cluster Priority	<input type="text" value="1"/> [Range: 0 - 255]
AP Client QoS	<input type="checkbox"/> OFF
Radius Authentication Server	<input type="text" value="Default-RADIUS-Server"/>
Radius Authentication Server Status	Configured
Radius Accounting Server	<input type="text" value="Default-RADIUS-Server"/>
Radius Accounting Server Status	Configured
Global Accounting Mode	<input type="checkbox"/> OFF

AP Validation

AP MAC Validation	<input checked="" type="radio"/> Local <input type="radio"/> Radius
Require Authentication Passphrase	<input type="checkbox"/> OFF
Manage AP with Previous Release Code	<input type="checkbox"/> OFF

Country Configuration

Country Code	<input type="text" value="US - United States"/>
--------------	---

Buttons: Save, Cancel

2. Complete the fields given in the table on the next page.
3. Click **Save**.

Field	Description
WLAN Global Setup	
WLAN Controller Operational Status	Toggle to ON to enable WLAN Controller functionality on the system. Clear the option to administratively disable the WLAN controller. If you clear the option, all peer controllers and APs that are associated with this controller are disassociated.
IP Address	Displays the current IP address of the wireless controller.
Peer Group ID	In order to support larger networks, you can configure wireless controllers as peers, with up to eight controllers in a cluster (peer group). Peer controllers share some information about APs and allow L3 roaming among them. Peers are grouped according to the group ID.
Client Roam Timeout	This value determines how long to keep an entry in the Associated Client Status list after a client has disassociated. Each entry in the status list shows an age, and when the age reaches the value you configure in the timeout field, the entry is deleted.
Ad Hoc Client Status Timeout	This value determines how long to keep an entry in the Ad Hoc Client Status list. Each entry in the status list shows an age, and when the age reaches the value you configure in the timeout field, the entry is deleted.
AP Failure Status Timeout	This value determines how long to keep an entry in the AP Failure Client Status list. Each entry in the status list shows an age, and when the age reaches the value you configure in the timeout field, the entry is deleted.
Client MAC Authentication mode	Select either White-list or Black-list .
RF Scan Status Timeout	This value determines how long to keep an entry in the RF Scan Status list. Each entry in the status list shows an age, and when the age reaches the value you configure in the timeout field, the entry is deleted.
Detected Clients Status Timeout	This value determines how long to keep an entry in the Detected Client Status list. Each entry in the status list shows an age, and when the age reaches the value you configure in the timeout field, the entry is deleted.
Tunnel IP MTU Size	Select the maximum size of an IP packet handled by the network. The MTU is enforced only on tunneled VAPs. When IP packets are tunneled between the APs and the wireless controller, the packet size is increased by 20 bytes during transit. This means that the clients configured for 1500 byte IP MTU size may exceed the maximum MTU size of existing network infrastructure which is set up to switch and route 1518 (1522-tagged) byte frames. If you increase the tunnel IP MTU size, you must also increase the physical MTU of the ports on which the traffic flows. Note: If any of the following conditions are true, you do not need to increase the tunnel IP MTU size: <ul style="list-style-type: none"> • The wireless network does not use L3 tunneling. • The tunneling mode is used only for voice traffic, which typically has small packets. • The tunneling mode is used only for TCP based protocols, such as HTTP. This is because the AP automatically reduces the maximum segment size for all TCP connections to fit within the tunnel.
Cluster Priority	Specify the priority of this controller for the Cluster Controller election. The wireless controller with highest priority in a cluster becomes the Cluster Controller. If the priority is the same for all wireless controllers, then the wireless controller with lowest IP address becomes the Cluster Controller. A priority of 0 means that the wireless controller cannot become the Cluster Controller. The highest possible priority is 255.
AP Client QoS	Enable or disable the client QoS feature. If AP Client QoS is disabled, the Client QoS configuration remains in place, but any ACLs or DiffServ policies applied to wireless traffic are not enforced. The Client QoS feature extends the primary QoS capabilities of the wireless controller to the wireless domain. More specifically, access control lists (ACLs) and differentiated service (DiffServ) policies are applied to wireless clients associated to the AP.

Field	Description
RADIUS Authentication Server	Enter the name of the RADIUS server used for AP and client authentications. The name can contain up to 32 alphanumeric characters. Spaces, underscores, and dashes are also permitted. The controller acts as the RADIUS client and performs all RADIUS transactions on behalf of the APs and wireless clients.
RADIUS Authentication Server Status	Indicates whether the RADIUS authentication server is configured.
Global Accounting Mode	Select to enable RADIUS accounting for wireless clients.
AP Validation	
AP MAC Validation	<p>For a wireless controller to manage an AP, you must add the MAC address of the AP to the Valid AP database, which can be kept locally on the controller or in an external RADIUS server. When the controller discovers an AP that is not managed by another wireless controller, it looks up the MAC address of the AP in the Valid AP database. If it finds the MAC address in the database, the controller validates the AP and assumes management.</p> <p>Select the database to use for AP validation. Choices are:</p> <ul style="list-style-type: none"> • Local: Add the MAC address of each AP to the local Valid AP database. • RADIUS: Configure the MAC address of each AP in an external RADIUS server.
Require Authentication Passphrase	<p>Select this option to require APs to be authenticated before they can associate with the controller. If you select this option, you must configure the passphrase on the AP while it is in standalone mode as well as in the Valid AP database. To configure the passphrase on a standalone AP, log onto the AP Administration Web UI and go to the Managed Access Point page, or log onto the AP CLI and use the set managed-ap pass-phrase command.</p> <p>To configure the passphrase for an AP in the local Valid AP database, click the Valid AP page from the Basic Setup page. Then, click the MAC address of the AP and enter the passphrase in the Authentication Password field. If you enable authentication, it takes place immediately after the controller validates the AP.</p>
Manage AP with Previous Release Code	Discovers and manages APs with the older firmware.
Country Configuration	
Country Code	Select the country code that represents the country where your controller and APs operate. When you click Save, a pop-up message asks you to confirm the change. Wireless regulations vary from country to country. Make sure you select the correct country code so that your WLAN system complies with the regulations in your country.

Channel Plan and Power Settings

The wireless controller software contains a channel plan algorithm that automatically determines which RF channels each AP should use to minimize RF interference. When you enable the channel plan algorithm, the wireless controller periodically evaluates the operational channel on every AP it manages and changes the channel if the current channel is noisy.

Configure Channel Plan

Path: Wireless > General > Channel Algorithm

To configure Channel Algorithm setting:

1. Go to **Wireless > General > Channel Algorithm > Channel Setting** page. The Channel Setting page will appear.

The screenshot displays the D-Link Unified Controller web interface. At the top, it shows the D-Link logo, the device name 'Unified Controller - DWC-1000', and system information including 'Serial Number: QBE11BC000009', 'Firmware Version: 4.4.0.1_WW', and 'Language: English [US]'. A 'Logout' button is visible in the top right. Below the header is a navigation menu with tabs for 'Status', 'Wireless', 'Network', 'Security', and 'Maintenance'. The 'Wireless' tab is selected, and the breadcrumb path is 'Wireless >> General >> Channel Algorithm >> Channel Algorithm 5 GHz'. There are also help and refresh icons. Below the breadcrumb is a sub-menu with 'Channel Setting', 'Manual Channel Plan', and 'Channel Plan History'. The 'Channel Setting' tab is active. A descriptive text states: 'Through this page we can configure AP frequency related parameters for 5 GHz radio channel.' Below this are two tabs: '5 GHz' (selected) and '2.4 GHz'. The main content area is titled 'RF Channel 5 GHz Settings' and contains the following configuration options:

Radio	5 GHz (802.11 a/n)	
Channel Plan Mode	<input checked="" type="radio"/> Manual <input type="radio"/> Interval <input type="radio"/> Fixed Time	
Ignore Unmanaged Aps	<input type="checkbox"/> ON <input type="checkbox"/> OFF	
Channel Change Threshold	<input type="text" value="-82"/>	[Default: -82, Range: -99 to -1]
Managed AP CH Conflict Threshold	<input type="text" value="-56"/>	[Default: -56, Range: -99 to -1]

At the bottom of the settings area are 'Save' and 'Cancel' buttons.

2. Each AP is dual-band capable of operating in the 2.4GHz and 5GHz frequencies. The 802.11a/n and 802.11b/g/n modes use different channel plans. Before you configure channel plan settings, select the mode to configure. Click either the **5GHz** or **2.4GHz** tab.

3. Select **Channel Plan Mode**. There are three type of modes:
 - **Manual** - With the manual channel plan mode, you control and initiate the calculation and assignment of the channel plan. You must manually run the channel plan algorithm and apply the channel plan to the APs.
 - **Interval** - In the interval channel plan mode, the controller periodically calculates and applies the channel plan. You can configure the interval to be from every 6 to every 24 hours. The interval period begins when you click **Save**.
 - **Fixed Time** - If you select the fixed time channel plan mode, you specify the time for the channel plan and channel assignment. In this mode the plan is applied once every 24 hours at the specified time.
4. **Channel Plan Interval**: If you select the Interval channel plan mode, you can specify the frequency at which the channel plan calculation and assignment occurs. The interval time is in hours, and you can specify an interval that ranges between every 6 hours to every 24 hours.
5. **Channel Plan Fixed Time**: If you select the Fixed Time channel plan mode, you can specify the time at which the channel plan calculation and assignment occurs. The channel plan calculation will occur once every 24 hours at the time you specify.
6. **Ignore Unmanaged APs**: This function indicates whether the controller should pay attention only to APs managed by the cluster, or all detected APs when deciding the channel for the radio. The setting is enabled by default.
7. **Channel Change Threshold**: Configure the detected neighbor signal strength that triggers the channel plan to re-evaluate the current operation channel. If the operating channel detects neighbor APs operating on the same channel with signal below this threshold, then the AP does not try to select a new channel for the radio. The default value for this threshold is -82dBm. The range is -99dBm to -1dBm.
8. **Managed AP CH Conflict Threshold**: This is the threshold, in dBm, below which managed APs that have a conflicting channel compared to the Channel Plan will have their channel updated. Once the controller channel interference calculation is done, AP will prepare to change the radio to the less interference channel.
9. **Manual Channel Plan**: If you select Manual, click on the Manual Channel Plan tab. Here you can apply and start the channel algorithm on selected access points.
10. **Channel Plan History**: This field shows whether the controller is using the automatic channel adjustment algorithm on the AP 2.4GHz and 5GHz radio.

Configure Power Settings

Path: Wireless > General > Power Algorithm

You can set the power of the AP radio frequency transmission in the AP profile, the local database or in the RADIUS server. The power level in the AP profile is the default level for the AP, and the power will not be adjusted below the value in the AP profile. The settings in the local database and RADIUS server always override power set in the profile setting. If you manually set the power, the level is fixed and the AP will not use the automatic power adjustment algorithm.

To configure Channel Algorithm setting:

1. Click **Wireless > General > Power Algorithm > Power Setting** tab.

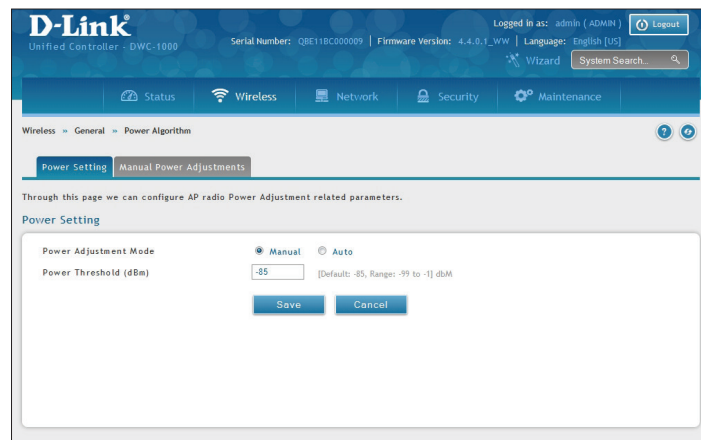

2. You can configure the power as a percentage of maximum power, where the maximum power is the minimum of power level allowed for the channel by the regulatory domain or the hardware capability. Select **Manual** or **Auto** Mode.
3. Enter the power change threshold. The default value is -85dBm. The power changes are initiated only if the neighbor radio hears the transmitting radio with the signal strength equal or above the threshold. The signal detected below the threshold is ignored.
4. If you select **Manual**, click on the **Manual Power Adjustments** tab. Here you can apply and start the power algorithm on selected access points.

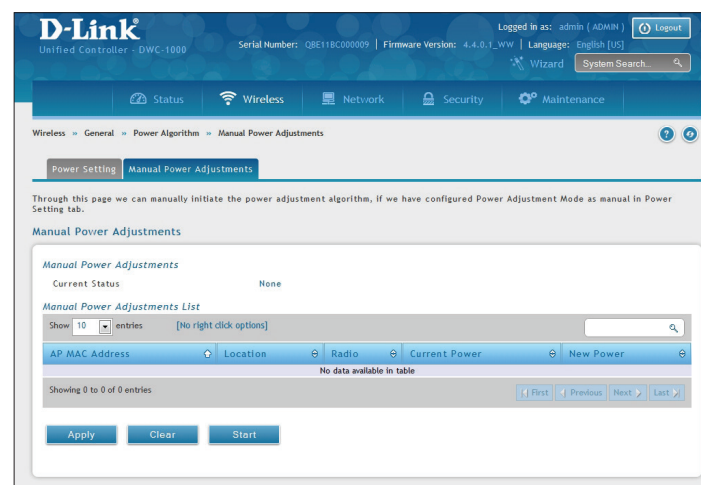

5. Fill-in the fields given in the table below.

Field	Description
Manual Power Adjustments	
Current Status	Shows the Current Status of the plan, which is one of the following states: <ul style="list-style-type: none"> • None: The power adjustment algorithm has not been manually running since the last controller reboot. • Algorithm In Progress: The power adjustment algorithm is running. • Algorithm Complete: The power adjustment algorithm has finished running. A table displays to indicate proposed power adjustments. Each entry shows the AP along with the current and new power levels. • Apply In Progress: The controller is adjusting the power levels that the APs use. • Apply Complete: The algorithm and power adjustment are complete.
Manual Power Adjustments List	
AP MAC address	Identifies the AP MAC address.
Location	Identifies the location of the AP, which is set in the Valid AP database.
Radio Interface	Identifies the radio.
Current Power	Shows the earlier power level for the AP.
New Power	Shows the proposed power level for the AP.

WIDS

The Wireless Intrusion Detection System (WIDS) helps to detect intrusion attempts into the wireless network and take automatic actions to protect the network.

Configure AP WIDS Settings

Path: Wireless > General > WIDS > AP WIDS Security

The WIDS AP Configuration page allows you to activate or deactivate various threat detection tests and set threat detection thresholds in order to help detect rogue APs on the wireless network. These changes can be done without disrupting network connectivity. Since some of the work is done by access points, the controller needs to send messages to the APs to modify its WIDS operational properties.

Note: The classification settings on the WIDS AP Configuration page are part of the global configuration on the controller and must be manually pushed to other controllers in order to synchronize that configuration.

Many of the tests are focused on identifying APs that are advertising managed SSIDs, but are not in fact managed APs. Detecting such an AP means that a network is either miss-configured or that a hacker set up a honeypot AP in the attempt to collect passwords or other secure information.

Although operational mode radios can detect most threats, the sentry radios detect the threats faster, especially when a potential rogue is operating on a different channel from any of the managed AP radios. The number of deployed sentry radios should be sufficient to provide coverage by one sentry radio in every geographical location within the network. A denser sentry deployment may be desirable in order to improve rogue or interferer signal triangulation.

To configure WIDS AP:

1. Go to **Wireless > General > WIDS > AP WIDS Security** tab.

D-Link Unified Controller - DWC-1000
 Serial Number: QB11BC000009 | Firmware Version: 4.4.0.1_WW | Language: English [US]
 Logged in as: admin (ADMIN) | Logout

Wireless > General > WIDS > AP WIDS Security

AP WIDS Security | AP WIDS Client Security

Through this page we can activate or deactivate various threat detection tests and set threat detection thresholds in order to help detect rogue APs on the wireless network. These changes can be done without disrupting network connectivity. Since some of the work is done by access points, the controller needs to send messages to the APs to modify its WIDS operational properties.

AP WIDS Security

Administrator Configured Rogue AP	Enabled
Managed SSID from an Unknown AP	<input type="checkbox"/>
Managed SSID from a Fake Managed AP	<input type="checkbox"/>
AP without a SSID	<input type="checkbox"/>
Fake Managed AP on an Invalid Channel	<input type="checkbox"/>
Managed SSID Detected with Incorrect Security	<input type="checkbox"/>
Invalid SSID from a Managed AP	<input type="checkbox"/>
AP is Operating on an Illegal Channel	<input type="checkbox"/>
Standalone AP with Unexpected Configuration	<input type="checkbox"/>
Unexpected WIDS Device Detected on Network	<input type="checkbox"/>
Unmanaged AP Detected on Wired Network	<input type="checkbox"/>
Rogue Detected Trap Interval	<input type="text" value="300"/> [Range: 60 - 3600, 0 - Disable] Seconds
Wired Network Detection Interval	<input type="text" value="60"/> [Range: 1 - 3600, 0 - Disable] Seconds
AP De-Authentication Attack	<input type="checkbox"/> OFF

Save Cancel

2. Enable or disable the security options as desired (refer to the table below) and click **Save**.

Field	Description
Administrator Configured Rogue AP	If the source MAC address is in the valid-AP database on the controller or on the RADIUS server, and the AP type is marked as Rogue, then the AP state is Rogue.
Managed SSID from an Unknown AP	This test checks whether an unknown AP is using the managed network SSID. A hacker may set up an AP with managed SSID to fool users into associating with the AP and revealing password and other secure information. Administrators with large networks who are using multiple clusters should either use different network names in each cluster or disable this test. Otherwise, if an AP in the first cluster detects APs in the second cluster transmitting the same SSID as APs in the first cluster then these APs are reported as rogues.
Managed SSID from a Fake Managed AP	A hacker may set up an AP with the same MAC address as one of the managed APs and configure it to send one of the managed SSIDs. This test checks for a vendor field in the beacons which is always transmitted by managed APs. If the vendor field is not present, then the AP is identified as a fake AP.
AP without a SSID	SSID is an optional field in beacon frames. To avoid detection a hacker may set up an AP with the managed network SSID, but disable SSID transmission in the beacon frames. The AP would still send probe responses to clients that send probe requests for the managed SSID fooling the clients into associating with the hacker's AP. This test detects and flags APs that transmit beacons without the SSID field. The test is automatically disabled if any of the radios in the profiles are configured not to send SSID field, which is not recommended because it does not provide any real security and disables this test.
Fake Managed AP on an Invalid Channel	This test detects rogue APs that transmit beacons from the source MAC address of one of the managed APs, but on different channel from which the AP is supposed to be operating.
Managed SSID Detected with Incorrect Security	During RF Scan, the AP examines beacon frames received from other APs and determines whether the detected AP is advertising an open network, WEP, or WPA. If the SSID reported in the RF Scan is one of the managed networks and its configured security does not match the detected security, then this test marks the AP as rogue.
Invalid SSID from a Managed AP	This test checks whether a known managed AP is sending an unexpected SSID. The SSID reported in the RF Scan is compared to the list of all configured SSIDs that are used by the profile assigned to the managed AP. If the detected SSID doesn't match any configured SSID, then the AP is marked as rogue.
AP is Operating on an Illegal Channel	The purpose of this test is to detect hackers or incorrectly configured devices that are operating on channels that are not legal in the country where the wireless system is set up. Note: <i>In order for the wireless system to detect this threat, the wireless network must contain one or more radios that operate in sentry mode.</i>
Standalone AP with Unexpected Configuration	If the AP is classified as a known standalone AP, then the controller checks whether the AP is operating with the expected configuration parameters. You configure the expected parameters for the standalone AP in the local or RADIUS Valid AP database. This test may detect network wrong configuration as well as potential intrusion attempts. The following parameters are checked: <ul style="list-style-type: none"> • Channel Number • SSID • Security Mode • WDS Mode • Presence on a wired network

Field	Description
Unexpected WDS Device Detected on Network	If the AP is classified as a Managed or Unknown AP, and wireless distribution system (WDS) traffic is detected on the AP, then the AP is considered to be Rogue. Only stand-alone APs that are explicitly allowed to operate in WDS mode are not reported as rogues by this test.
Unmanaged AP Detected on Wired Network	This test checks whether the AP is detected on the wired network. If the AP state is Unknown, then the test changes the AP state to Rogue. The flag indicating whether AP is detected on the wired network, is reported as part of the RF Scan report. If AP is managed and is detected on the network, then the controller simply reports this fact and doesn't change the AP state to Rogue. In order for the wireless system to detect this threat, the wireless network must contain one or more radios that operate in sentry mode.
Rogue Detected Trap Interval	Specify the interval, in seconds, between transmissions of the SNMP trap telling the administrator that rogue APs are present in the RF Scan database. If you set the value to 0, the trap is never sent.
Wired Network Detection Interval	Specify the number of seconds that the AP waits before starting a new wired network detection cycle. If you set the value to 0, wired network detection is disabled.
AP De-Authentication Attack	Enable or disable the AP de-authentication attack. The wireless controller can protect against rogue APs by sending de-authentication messages to the rogue AP. The de-authentication attack feature must be globally enabled in order for the wireless system to do this function. Make sure that no legitimate APs are classified as rogues before enabling the attack feature. This feature is disabled by default.

Configure Client WIDS Settings

Path: **Wireless** > **General** > **WIDS** > **AP WIDS Client Security**

The Wireless Intrusion Detection System (WIDS) can help detect intrusion attempts into the wireless network and take automatic actions to protect the network. The settings you configure on the WIDS Client Configuration page help determine whether a detected client is classified as a rogue. Clients classified as rogues are considered to be a threat to network security.

Note: *The classification settings on the WIDS Client Configuration page are part of the global configuration on the controller and must be manually pushed to other controllers in order to synchronize that configuration.*

As part of the general association and authentication process, wireless clients send 802.11 management messages to APs. The WIDS feature tracks the following types of management messages that each detected client sends:

- Probe Requests
- 802.11 Authentication Requests
- 802.11 De-Authentication Requests

In order to help determine whether a client is posing a threat to the network by flooding the network with management traffic, the system keeps track of the number of times the AP received each message type and the highest message rate detected in a single RF Scan report. On the WIDS Client Configuration page, you can set thresholds for each type of message sent, and the APs monitor whether any clients exceed those thresholds or tests.

To configure WIDS Client:

1. Go to **Wireless** > **General** > **WIDS** > **AP WIDS Client Security** tab.

The screenshot shows the D-Link Unified Controller web interface. The top navigation bar includes 'Status', 'Wireless', 'Network', 'Security', and 'Maintenance'. The breadcrumb trail is 'Wireless > General > WIDS > AP WIDS Client Security'. The page title is 'AP WIDS Client Security'. Below the title, there is a note: 'The settings we configure on the WIDS Client Configuration page help determine whether a detected client is classified as a rogue. Clients classified as rogues are considered to be a threat to network security.' The configuration options are as follows:

Setting	Value	Range
Not Present in OUI Database Test	<input type="checkbox"/> OFF	
Not Present in Known Client Database Test	<input type="checkbox"/> OFF	
Configured Authentication Rate Test	<input checked="" type="checkbox"/> ON	
Configured Probe Requests Rate Test	<input checked="" type="checkbox"/> ON	
Configured De-Authentication Requests Rate Test	<input checked="" type="checkbox"/> ON	
Maximum Authentication Failures Test	<input checked="" type="checkbox"/> ON	
Authentication with Unknown AP Test	<input type="checkbox"/> OFF	
Client Threat Mitigation	<input type="checkbox"/> OFF	
Known Client Database Lookup Method	<input checked="" type="checkbox"/> ON	
Known Client Database Radius Server Name	Default-RADIUS-Server	
Rogue Detected Trap Interval	300	[Range: 60 - 3600, 0 - Disable] Seconds
De-Authentication Requests Threshold Interval	60	[Range: 1 - 3600] Seconds
De-Authentication Requests Threshold Value	10	[Range: 1 - 99999]
Authentication Requests Threshold Interval	60	[Range: 1 - 3600] Seconds
Authentication Requests Threshold Value	10	[Range: 1 - 99999]
Probe Requests Threshold Interval	60	[Range: 1 - 3600] Seconds
Probe Requests Threshold Value	120	[Range: 1 - 99999]
Authentication Failure Threshold Value	5	[Range: 1 - 99999]

At the bottom of the configuration area, there are 'Save' and 'Cancel' buttons.

2. Enable or disable the security options as desired (refer to the table below), and click **Save**.

Field	Description
Not Present in OUI Database Test	This test checks whether the MAC address of the client is from a registered manufacturer identified in the OUI database.
Not Present in Known Client Database Test	This test checks whether the client, which is identified by its MAC address, is listed in the Known Client Database and is allowed access to the AP either through the Authentication Action of Grant or through the White List global action. If the client is in the Known Client Database and has an action of Deny, or if the action is Global Action and it is globally set to Black List, the client fails this test.
Configured Authentication Rate Test	This test checks whether the client has exceeded the configured rate for transmitting 802.11 authentication requests.
Configured Probe Requests Rate Test	This test checks whether the client has exceeded the configured rate for transmitting probe requests.
Configured De-Authentication Requests Rate Test	This test checks whether the client has exceeded the configured rate for transmitting de-authentication requests.
Maximum Authentication Failures Test	This test checks whether the client has exceeded the maximum number of failed authentications.
Authentication with Unknown AP Test	This test checks whether a client in the Known Client database is authenticated with an unknown AP.
Client Threat Mitigation	Select enable to send de-authentication messages to clients that are in the Known Clients database but are associated with unknown APs. The Authentication with Unknown AP Test must also be enabled in order for the mitigation to take place. Select disable to allow clients in the Known Clients database to remain authenticated with an unknown AP.
Known Client Database Lookup Method	When the controller detects a client on the network, it performs a lookup in the Known Client database. Specify whether the controller should use the local or RADIUS database for these lookups.
Known Client Database Radius Server Name	If the known client database lookup method is RADIUS, this field specifies the RADIUS server name.
Rogue Detected Trap Interval	Specify the interval, in seconds, between transmissions of the SNMP trap telling the administrator that rogue APs are present in the RF Scan database. If you set the value to 0, the trap is never sent.
De-Authentication Requests Threshold Interval	Specify the number of seconds an AP should spend counting the de-authentication messages sent by wireless clients.
De-Authentication Requests Threshold Value	If the controller receives more than specified messages during the threshold interval the test triggers.
Authentication Requests Threshold Interval	Specify the number of seconds an AP should spend counting the authentication messages sent by wireless clients.
Authentication Requests Threshold Value	If the controller receives more than specified messages during the threshold interval the test triggers.
Probe Requests Threshold Interval	Specify the number of seconds an AP should spend counting the probe messages sent by wireless clients.
Probe Requests Threshold Value	Specify the number of probe requests a wireless client is allowed to send during the threshold interval before the event is reported as a threat.
Authentication Failure Threshold Value	Specify the number of 802.1X authentication failures a client is allowed to have before the event is reported as a threat.

ACL

Access Control Lists (ACLs) ensure that only authorized users have access to specific resources while blocking off any unwarranted attempts to reach network resources. ACLs are used to provide traffic flow control, restrict contents of routing updates, decide which types of traffic are forwarded or blocked, and above all, provide security for the network.

IP ACL

Path: **Wireless** > **ACL** > **IP ACL**

IP Access control Lists (ACLs) allow the network managers to define classification actions and rules for specific ports. ACLs are composed of rules that consist of the filters that determine traffic classifications. An IP ACL consists of a set of rules which are matched sequentially against a packet. When a packet meets the match criteria of a rule, the specified rule action (Permit/Deny) is taken and the additional rules are not checked for a match. Rules for the IP ACL are specified/created using the IP ACL Rule Configuration menu.

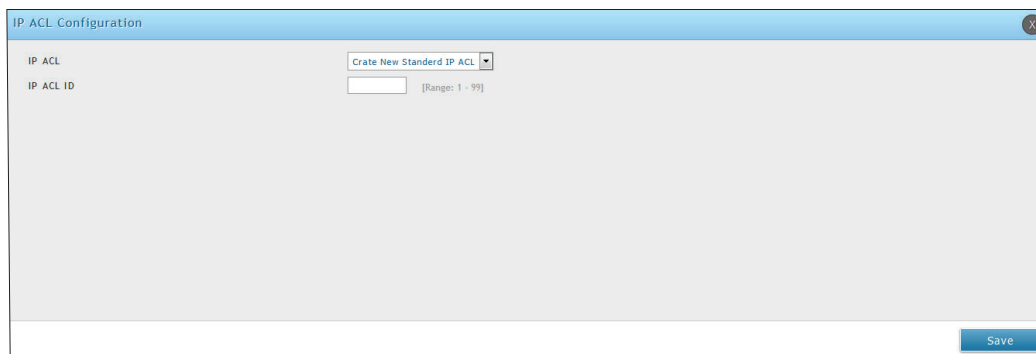
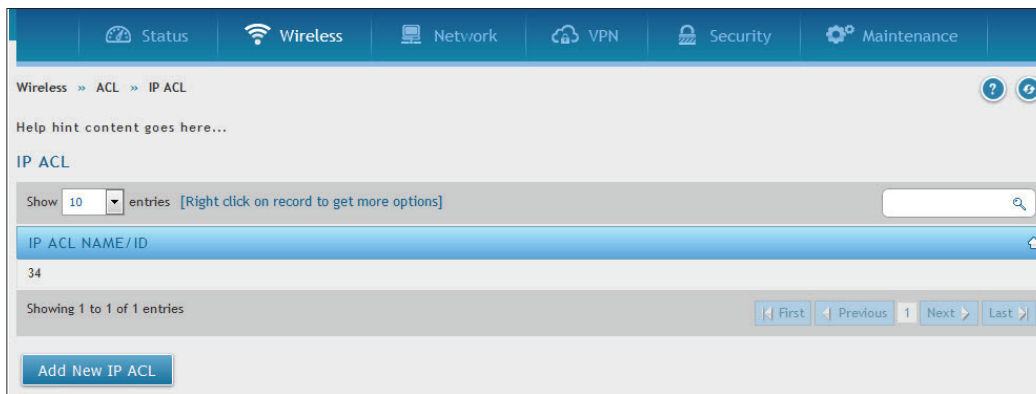

To configure IP ACL:

1. Go to **Wireless** > **ACL** > **IP ACL** page.
2. Click **Add New IP ACL**, fill-in the fields (refer to the table below), and click **Save**.

Field	Description
IP ACL	Select a type of ACL to create, or select an existing ACL to delete from the dropdown menu. You can create the following types of IP ACLs: <ul style="list-style-type: none"> Standard IP ACL: Allows you to permit or deny traffic from a source IP address. Extended IP ACL: Allows you to permit or deny specific types of layer 3 or layer 4 traffic from a source IP address to a destination IP address. This types of ACL provides more granularity and filtering capabilities than the standard IP ACL. Named IP ACL: Allows you to create an Extended IP ACL that is identified by a name rather than a number. These ACLs have the same capabilities as Extended IP ACLs with respect to match criteria and actions supported.
IP ACL ID	Enter an ID number for the ACL to configure. This field appears if you select Create Standard IP ACL or Create Extended IP ACL from the IP ACL dropdown menu. For a Standard IP ACL, the acceptable ID values are 1-99. From an Extended IP ACL, the acceptable ID values are 101-199.
IP ACL Name	This field appears if you select Create New Named IP ACL from IP ACL dropdown menu. Specify an IP ACL Name string which includes only alphanumeric characters. The name must start with an alphanumeric character. This field will display the name of the currently selected IP ACL if the ACL has already been created.

IP ACL Rules

Path: **Wireless > ACL > IP ACL Rules**

This opens IP ACL Rule Configuration page. Use this page to configure the rules for the IP Access Control Lists. The fields present on this page depend on whether you select a standard, extended, or named IP ACL from the IP ACL field, and whether the rule action is permit or deny. A Standard/Extended IP ACL must first be selected to configure rules. The rule identification, and the 'Action' and 'Match Every' parameters must be specified next. If 'Match Every' is set to False, more options will be present from which the match criteria can be configured.

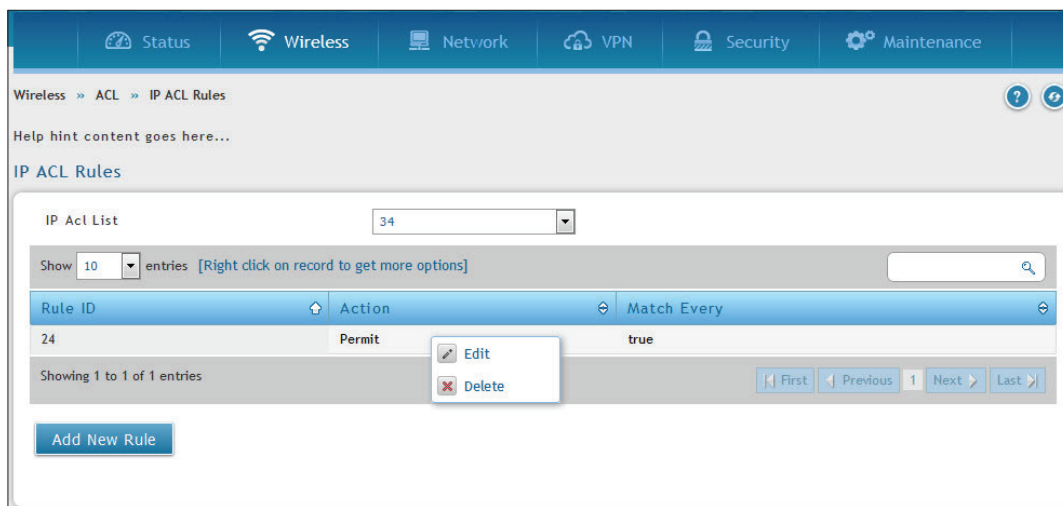

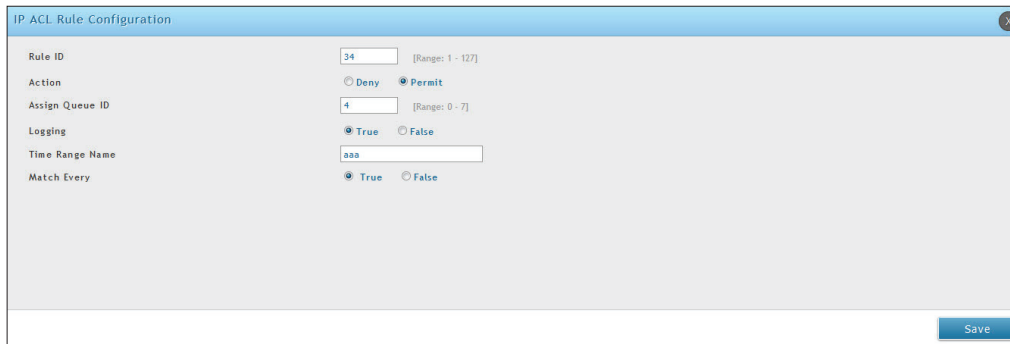

To configure IP ACL Rules:

1. Go to **Wireless > ACL > IP ACL Rules** page.
2. Click **Add New Rule**, fill-in the fields (refer to the table below), and click **Save**.

Field	Description
Rule ID	This field is available only if you select Add New Rule to configure a new ACL Rule. Enter a new Rule ID which is a whole number in the range from 1-127 that will be used to identify the rule.
Action	Select the ACL forwarding action. Select the desired action from the following two options: <ul style="list-style-type: none"> • Permit: Forward the packets which meet the ACL criteria. • Deny: Drops the packets which meet the ACL criteria.
Assign Queue ID	This field is visible only if the Action is Permit . Use this field to specify the hardware egress queue identifier used to handle all packets matching this ACL Rule. Enter an identifying queue number (0 to 7) in the appropriate field.
Logging	When set to True, logging is enabled for this ACL rule (subject to resource availability in the device).
Match Every	Requires a packet to match the criteria of this ACL. Select True or False from the options. True signifies that all packets will match the selected IP ACL and Rule and will be either permitted or denied. Match Every is exclusive to the other filtering rules, so if Match Every is True, the other rules do not appear on the screen. To configure specific Match Criteria for the rule, remove the rule and re-create it, or reconfigure 'Match Every' to False for the other match criteria to be visible.
Protocol Keyword	Specify that a packet's IP protocol is a match condition for the selected IP ACL rule. The possible values are ICMP, IGMP, IP, TCP, and UDP. Either the "Protocol Number" field or the "Protocol Keyword" field can be used to specify an IP protocol value as a match criteria.
Protocol Number	Specify that a packet's IP protocol is a match condition for the selected IP ACL rule and identify the protocol by number. The protocol value is a standard value and is interpreted as an integer from 0 to 255. Either the "Protocol Number" field or the "Protocol Keyword" field can be used to specify an IP protocol value as a match criteria.
Source IP Address	Requires a packet's source port IP address listed here. Enter an IP Address in the appropriate field using dotted-decimal notation. The address you enter is compared with a packet's source IP address.

Field	Description
Source IP Wildcard Mask	Specifies the source IP address wildcard mask. Wildcard masks determine which bits are used and which bits are ignored. A wildcard mask of 255.255.255.255 indicates that no bit is important. A wildcard of 0.0.0.0 indicates that all the bits are important. Wildcard masking for ACLs operates differently from a subnet mask. With a subnet mask, the mask has ones (1's) in the bit positions that are used for the network address, and has zeros (0's) for the bit positions that are not used. In contrast, a wildcard mask has (0's) in a bit position that must be checked. A '1' in a bit position of the ACL mask indicates that the corresponding bit can be ignored. This field is required when you configure a source IP address.
Source L4 Port	Requires a packet's TCP/UDP source port to match the port listed here. Complete one of the following fields: <ul style="list-style-type: none"> • Source L4 Keyword: Select the desired L4 keyword from a list of source ports on which the rule can be based. If you select a keyword other than Other, the screen refreshes and the Source L4 Port Number field disappears. • Source L4 Port Number: If the source L4 keyword is Other, enter a user-defined Port ID by which the packets are matched to the rule.
Destination IP Address	Requires a packet's destination port IP address to match the address listed here. Enter an IP address in the appropriate field. The address you entered is compared to the packet's destination IP address.
Destination IP Wildcard Mask	Specify the IP wildcard mask to be used with the Destination IP Address value.
Destination L4 Port	Requires a packet's TCP/UDP destination port to match the port listed here. Complete one of the following fields: <ul style="list-style-type: none"> • Destination L4 Keyword: Select the desired L4 keyword from a list of destination ports on which the rule can be based. If you select a keyword other than Other, the screen refreshes and the Destination L4 Port Number field disappears. • Destination L4 Port Number: If the destination L4 keyword is Other, enter a user-defined Port ID by which the packets are matched to the rule. The valid range is 0 to 65535.
Service Type	Select one of the following three Match conditions for the extended IP ACL rule. These are the alternative ways of specifying a match condition for the same Service Type field in the IP header, however each uses a different user notation. After a selection is made, the appropriate value can be specified: <ul style="list-style-type: none"> • IP DSCP: This field matches the packet DSCP value to the rule. Specify the IP DiffServe Code Point (DSCP) field. The DSCP is defined as the high-order six bits of the Service Type octet in the IP header. This is an optional configuration. Enter an integer from 0 to 63. The IP DSCP is selected by selecting one of the DSCP keyword values from the menu. If a value is to be selected by specifying its numeric value, then select the 'Other' in the menu and a field 'IP DSCP Value' will appear where you can enter the numeric value of the DSCP. • IP Precedence: The IP Precedence field in a packet is defined as the high-order three bits of the Service Type octet in the IP header. This is an optional configuration. This field matches the packet IP Precedence value to the rule when checked. Enter the IP Precedence value, an integer from 0 to 7, to match. Either the DSCP value or the IP Precedence value is used to match packets to ACLs. • IP TOS Bits: The IP TOS field in a packet is defined as all eight bits of the Service Type octet in the IP header. Matches on the Type of Service bits in the IP header when checked. • TOS Bits: This value is a hexadecimal number from 00 to FF. Requires the bits in a packet's TOS field to match the two-digit hexadecimal number entered here.

Field	Description
	<ul style="list-style-type: none"> • TOS Mask: This value is a hexadecimal number from 00 to FF. Specifies the bit positions that are used for comparison against the IP TOS field in a packet.

IP ACL Configuration Example

Example: To block ICMP traffic between the two wireless clients, say STA1 (Station 1) and STA2 (Station 2).

The topology for the above configuration is given below:

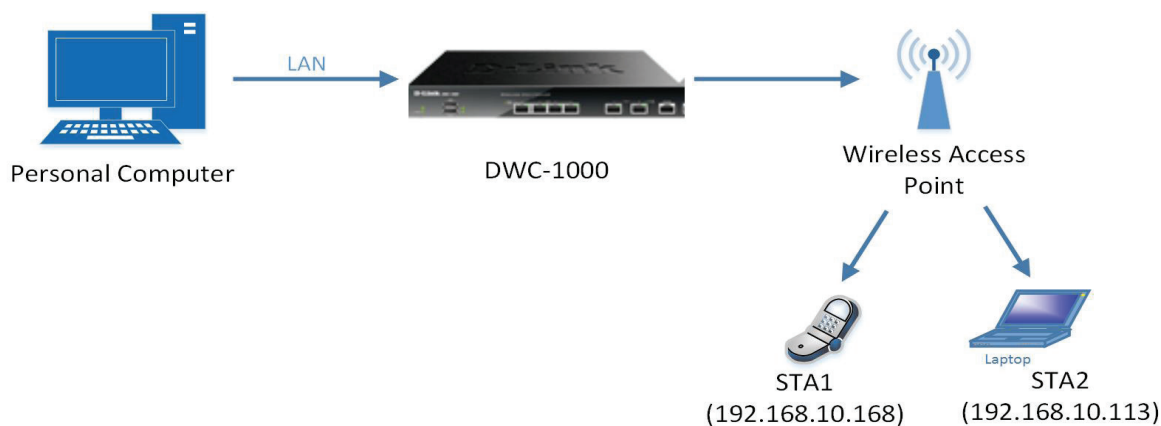

Follow the steps given below:

1. Go to **Wireless > ACL > IP ACL** page, and click **Add New IP ACL**.
2. Select IP ACL as **Create New Extended IP ACL** from the drop-down menu.
3. Enter **IP ACL ID**.

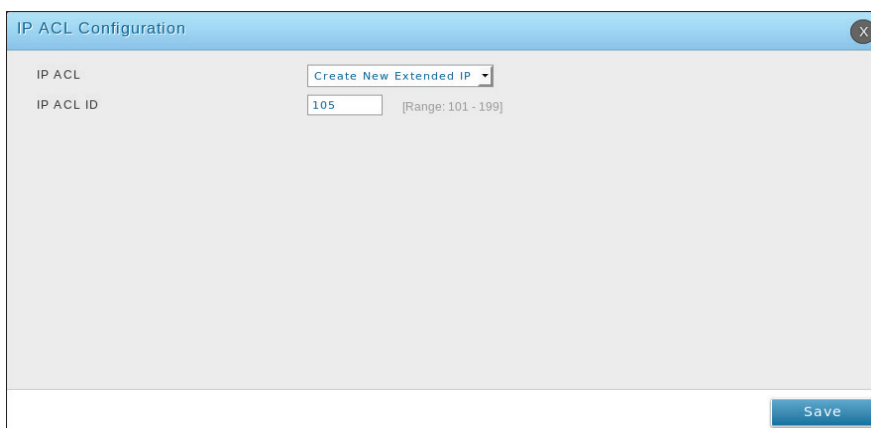

4. Go to **Wireless > ACL > IP ACL Rules** page, select the IP ACL ID from the IP ACL drop down list.
5. Click **Add New Rule** to add an IP ACL Rule, i.e. rule 1, to block the ICMP traffic from STA1 and STA2.

IP ACL Rule Configuration

Rule ID: 1

Action: Deny Permit

Logging: True False

Match Every: True False

Protocol: ICMP

Source IP Address: 192.168.10.168

Source IP wildcard mask: 0.0.0.0

Source L4 Port: None

Destination IP Address: 192.168.10.113

Destination IP wildcard mask: 0.0.0.0

Destination L4 Port: None

Save

6. Repeat step 5 to add another rule to block the ICMP traffic from STA2 to STA1.

IP ACL Rule Configuration

Rule ID: 2 [Range: 1 - 10]

Action: Deny Permit

Logging: True False

Match Every: True False

Protocol: ICMP

Source IP Address: 192.168.10.113

Source IP wildcard mask: 0.0.0.0

Source L4 Port: None

Destination IP Address: 192.168.10.168

Destination IP wildcard mask: 0.0.0.0

Destination L4 Port: None

Save

7. After configuring all the rules, add one permit rule. Adding a permit rule is mandatory to allow all other types of traffic to flow between the source and destination, as in an AP, there is an implicit “deny all” rule at the end of ACL.

IP ACL Rule Configuration

Rule ID: 3 [Range: 1 - 10]

Action: Deny Permit

Assign Queue ID: 2 [Range: 0 - 7]

Logging: True False

Match Every: True False

Save

8. Go to **Wireless > General** page, and enable **AP Client QoS**.

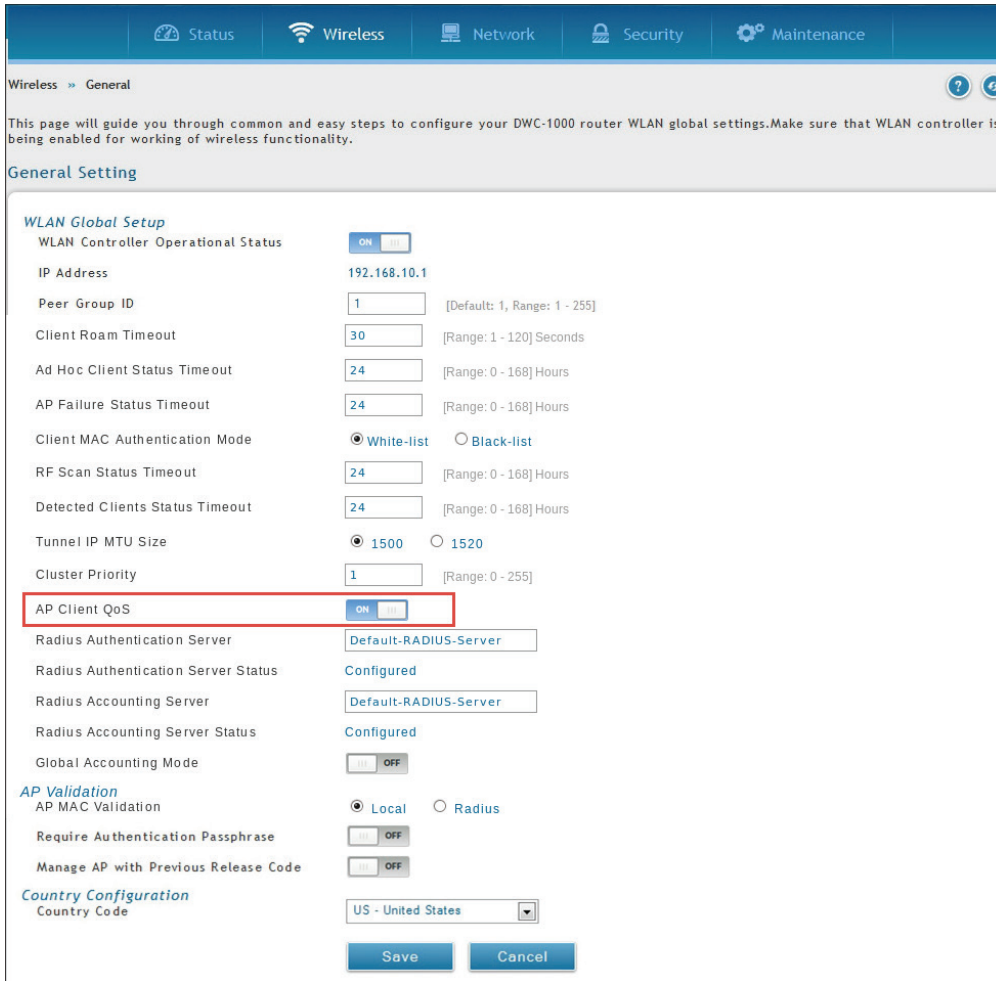

9. Go to **Wireless > Access Point > AP Profiles > AP Profile SSID** page, right click any of the configured SSID, and click **Edit**. For the selected SSID, enable the Client QoS and select the configured ACL for **Client QoS Access Control Down** and **Client QoS Access Control Up**.

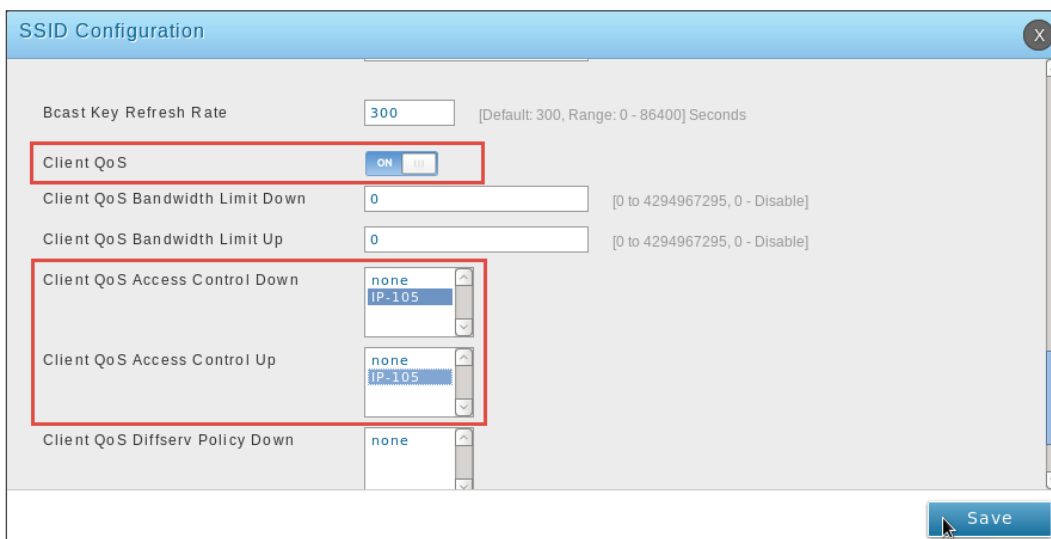

10. Now, go to **Wireless > Access Point > AP Profiles** page, right click the AP Profile and click **Apply** to push the configuration to the AP.

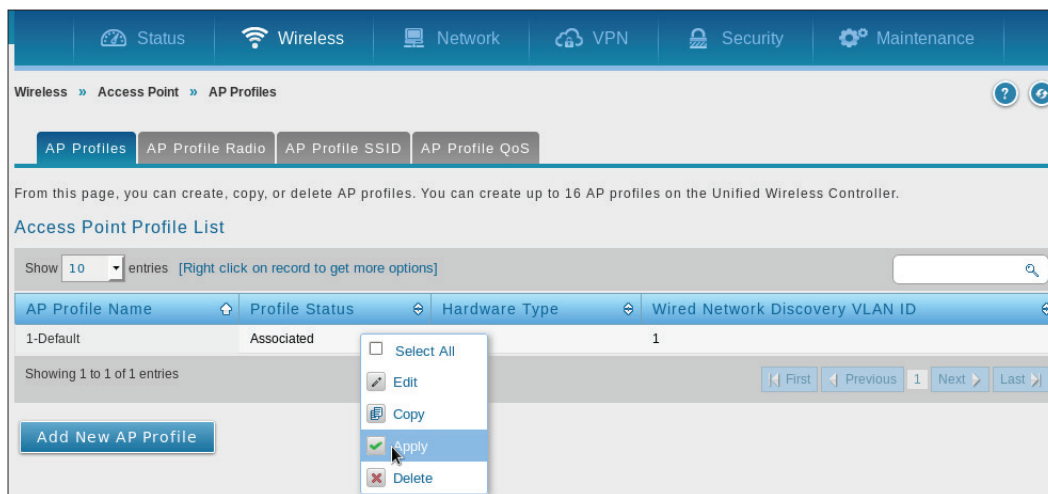

11. To test the configuration, connect two wireless clients (STA1, STA2) and try to ping the STA2 from STA1 and vice-versa. You will observe that the ACL will block the ICMP traffic between the two stations.

MAC ACL

Path: **Wireless > ACL > MAC ACL**

A MAC ACL consists of a set of rules which are matched sequentially against a packet. When a packet meets the match criteria of a rule, the specified rule action (Permit/Deny) is taken and the additional rules are not checked for a match. Rules for the MAC ACL are specified/created using the MAC ACL Rule Configuration menu.

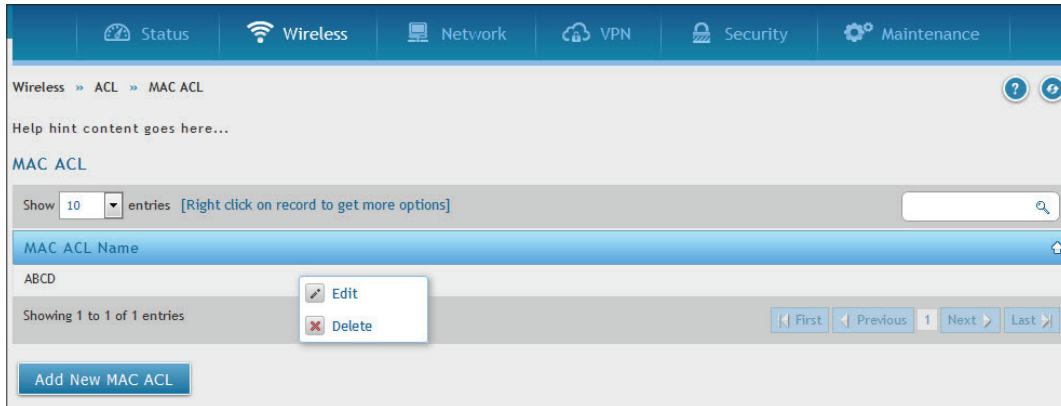

To configure MAC ACL:

- Go to **Wireless > ACL > MAC ACL** page.
- Click **Add New MAC ACL**.

The MAC ACL Configuration page allows the user to define a MAC Based ACL.

- **MAC ACL Name:** Enter a name for the MAC ACL. The name string may include alphabetic, numeric, dash, underscore, or space characters only. The name must start with an alphabetic character. This field displays the name of the currently selected MAC ACL if the ACL has already been created.

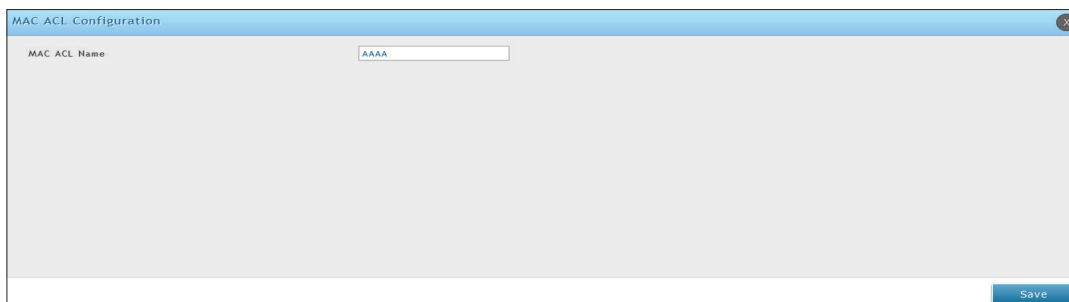

MAC ACL Rules

Path: **Wireless > ACL > MAC ACL Rules**

You can configure the rules for the MAC Access Control Lists created using the MAC Access Control List Configuration page. The fields on this page varies depending on the current step in the rule configuration process.

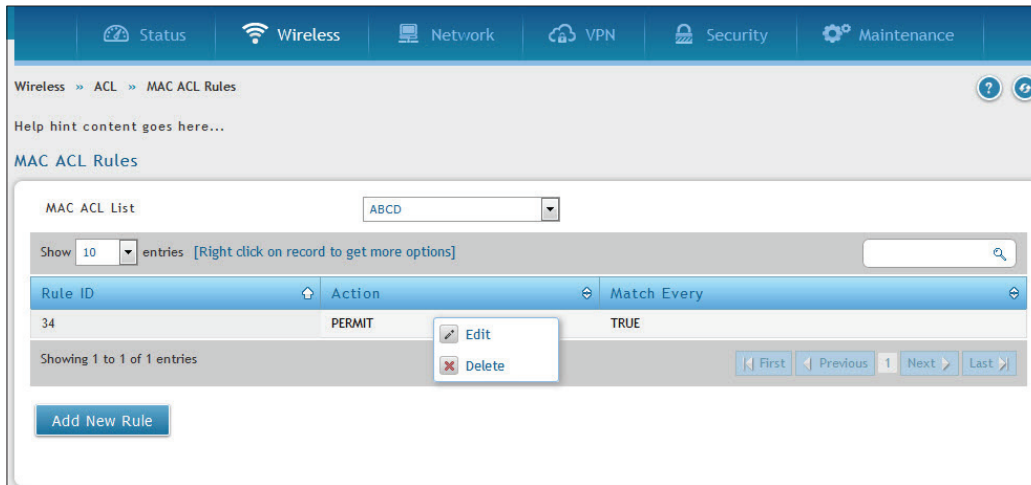

Use the MAC ACL Rule Configuration page to define rules for MAC based ACLs. The access list definition includes rules that specify whether traffic matching the criteria is forwarded normally or discarded. A default “deny all” rule is the last rule of every list. The fields available on the configuration page depend on whether the rule action is permit or deny, and whether you select Create Rule or an existing rule from the **Rule** field.

To configure MAC ACL Rule:

1. Go to **Wireless > ACL > MAC ACL Rules** page.
2. Click **Add New Rule**.
3. Fill-in the fields (refer to the below table), and click **Save**.

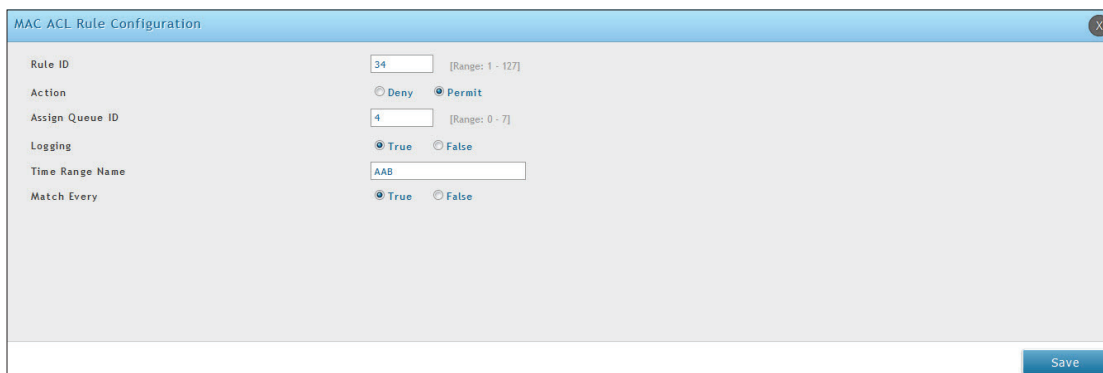

Field	Description
Rule ID	This field is available only if you select Add New Rule to configure a new ACL Rule. Enter a new Rule ID which is a whole number in the range from 1-127 that will be used to identify the rule.
Action	Select the ACL forwarding action. Select the desired action from the following two options: <ul style="list-style-type: none"> • Permit: Forward the packets which meet the ACL criteria. • Deny: Drops the packets which meet the ACL criteria.

Field	Description
Assign Queue ID	This field is visible only if the Action is Permit. Use this field to specify the hardware egress queue identifier used to handle all the packets matching this ACL Rule. Enter an identifying queue number (0 to 7) in the appropriate field.
Logging	When set to True, logging is enabled for this ACL rule (subject to resource availability in the device).
Match Every	Requires a packet to match the criteria of this ACL. Select True or False from the options. Match Every is exclusive to the other filtering rules, so if Match Every is True, the other rules do not appear on the screen. False indicates that it is not mandatory for every packet to match the selected ACL Rule.
CoS	Specifies the 802.1p user priority to compare against an Ethernet frame. Requires a packet's class of service (CoS) to match the CoS value listed here. Enter a CoS value between 0 to 7 to apply this criteria.
Source MAC	Requires a packet's source port MAC address to match the address listed here. Enter a MAC address in the appropriate field. The valid format is xx:xx:xx:xx:xx:xx.
Source MAC Mask	If desired, enter the MAC mask for the source MAC address to match. Use F's and zeros in the MAC mask, which is in a wildcard format. An F means that the bit is not checked, and a zero in a bit position means that the data must equal the value given for that bit. The valid format is xx:xx:xx:xx:xx:xx.
Destination MAC Address	Requires an Ethernet frame's destination port MAC address to match the address listed here. Enter a MAC address in the appropriate field. The valid format is xx:xx:xx:xx:xx:xx.
Destination MAC Mask	If desired, enter the MAC Mask associated with the Destination MAC to match. The MAC address mask specifies which bits in the destination MAC to compare against an Ethernet frame. Use F's and zeros in the MAC mask, which is in a wildcard format. An F means that the bit is not checked, and a zero in a bit position means that the data must equal the value given for that bit. For example, if the MAC address is aa:bb:cc:dd:ee:ff, and the mask is 00:00:ff:ff:ff:ff, all MAC addresses with aa:bb:xx:xx:xx:xx result in a match (where x is any hexadecimal number).
Ethertype Key	Requires a packet's EtherType to match the EtherType you select. Select the EtherType value from the dropdown menu. If you select User Value, you can enter a custom EtherType value.
Custom Value	This field appears only if you select User Value from the EtherType dropdown list. The value you enter specifies a customized EtherType to compare against an Ethernet frame. The valid range of values is (0x0600 to 0xFFFF).

MAC ACL Configuration Example

Example: To block the traffic between the two wireless clients, STA1 (station 1) and STA2 (station 2) using the MAC ACL.

The topology required for this configuration is as follows:

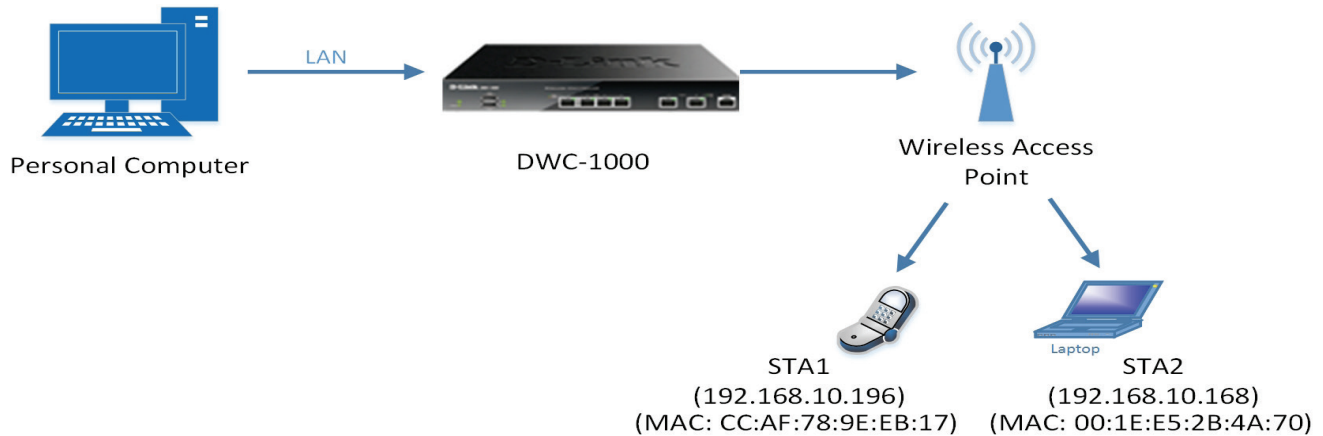

Follow the following steps:

1. Go to **Wireless > ACL > MAC ACL** page, and click **Add New MAC ACL**.

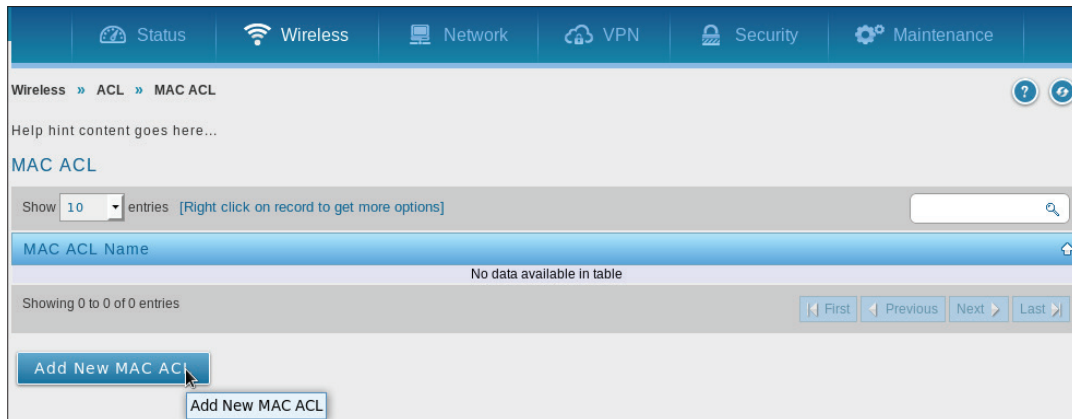

2. Enter a MAC ACL Name, and click **Save**.

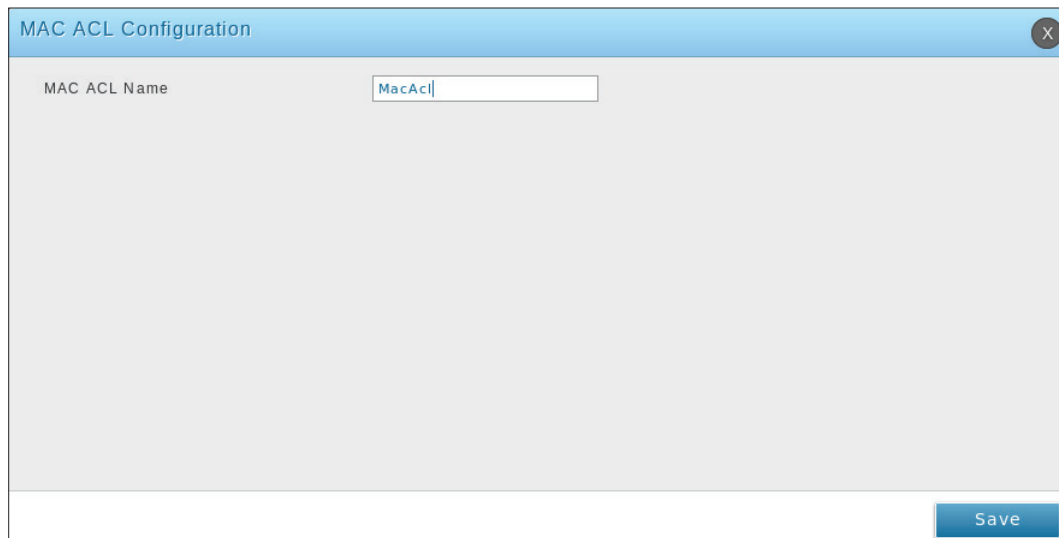

3. Follow the following path to open the MAC ACL Rules page, **Wireless > ACL > MAC ACL Rules**.
4. Select the MAC ACL name from the MAC ACL List drop-down menu, and click **Add New Rule** (Rule 1) to block the traffic from STA1 to STA2.

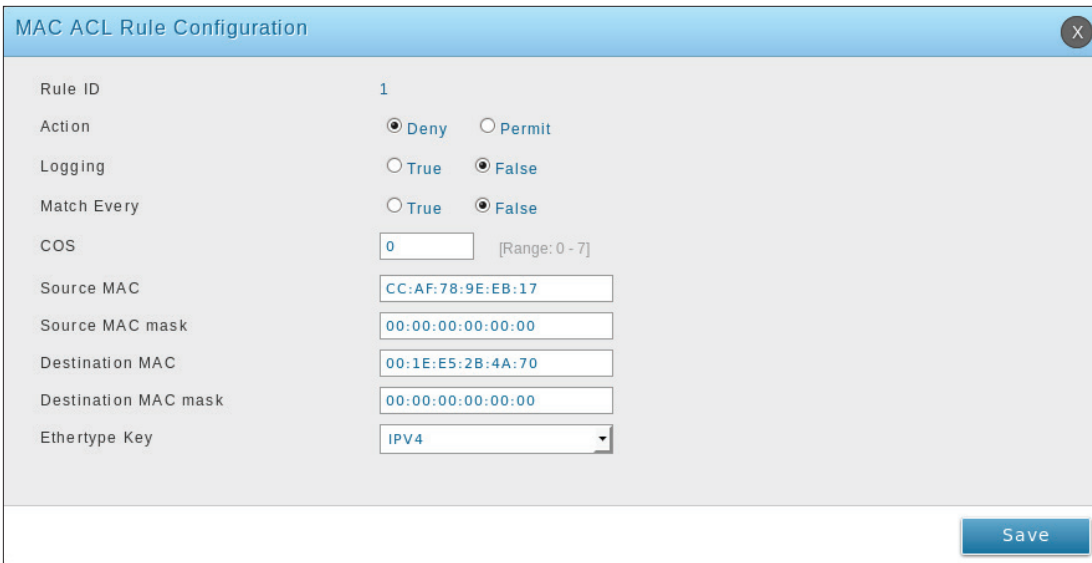
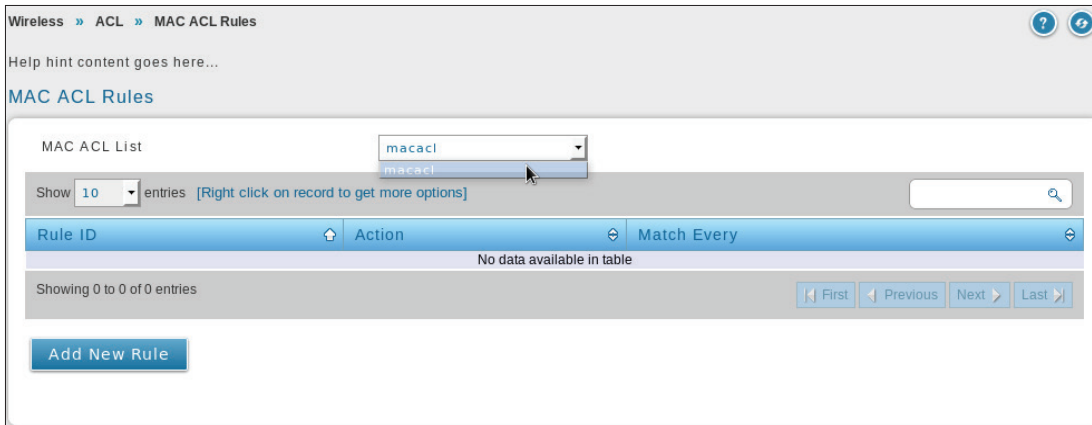

5. Add Rule 2 to block the traffic from STA2 to STA1.

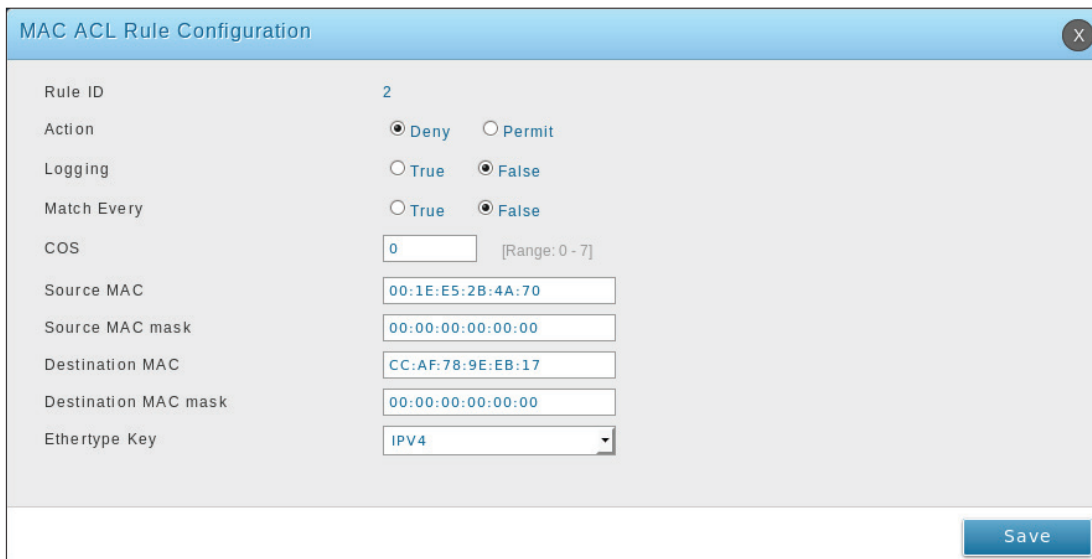

- After saving all the rules, add one permit rule. This is mandatory to allow all other types of traffic to flow between the source and destination, as in an AP, there is an implicit “deny all” rule at the end of ACL.

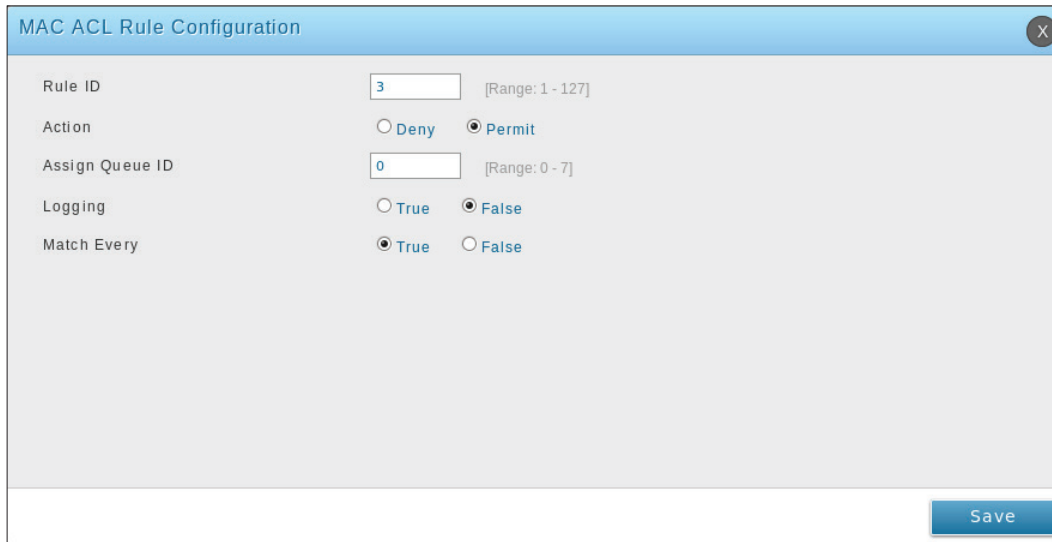

The image shows a 'MAC ACL Rule Configuration' dialog box with the following fields and options:

- Rule ID: 3 [Range: 1 - 127]
- Action: Deny Permit
- Assign Queue ID: 0 [Range: 0 - 7]
- Logging: True False
- Match Every: True False

A 'Save' button is located at the bottom right of the dialog.

- Now, go to **Wireless > General** page, and enable **AP client QoS**.

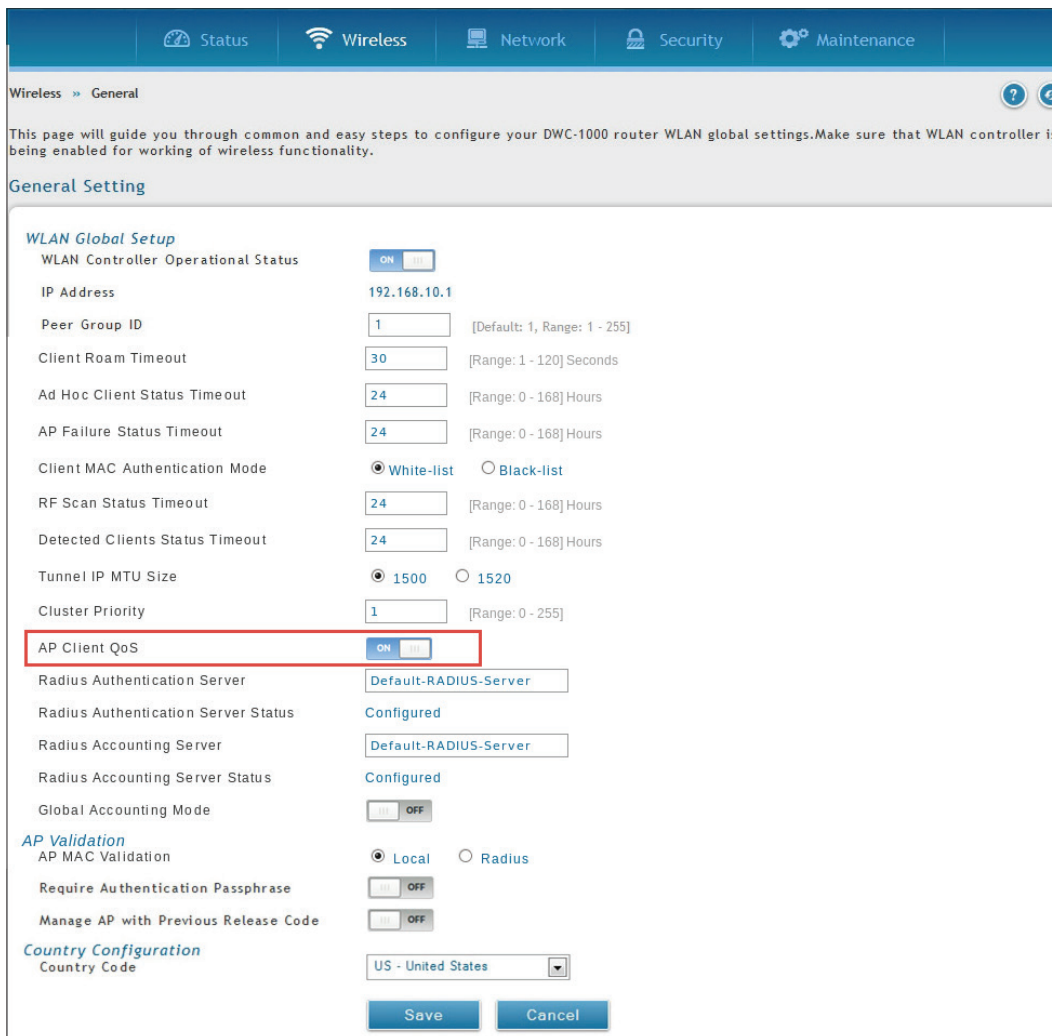

The image shows the 'Wireless > General' configuration page. The 'AP Client QoS' option is highlighted with a red box and is currently set to 'ON'.

WLAN Global Setup

- WLAN Controller Operational Status: ON
- IP Address: 192.168.10.1
- Peer Group ID: 1 [Default: 1, Range: 1 - 255]
- Client Roam Timeout: 30 [Range: 1 - 120] Seconds
- Ad Hoc Client Status Timeout: 24 [Range: 0 - 168] Hours
- AP Failure Status Timeout: 24 [Range: 0 - 168] Hours
- Client MAC Authentication Mode: White-list Black-list
- RF Scan Status Timeout: 24 [Range: 0 - 168] Hours
- Detected Clients Status Timeout: 24 [Range: 0 - 168] Hours
- Tunnel IP MTU Size: 1500 1520
- Cluster Priority: 1 [Range: 0 - 255]
- AP Client QoS: ON**
- Radius Authentication Server: Default-RADIUS-Server
- Radius Authentication Server Status: Configured
- Radius Accounting Server: Default-RADIUS-Server
- Radius Accounting Server Status: Configured
- Global Accounting Mode: OFF

AP Validation

- AP MAC Validation: Local Radius
- Require Authentication Passphrase: OFF
- Manage AP with Previous Release Code: OFF

Country Configuration

- Country Code: US - United States

'Save' and 'Cancel' buttons are at the bottom.

- Go to **Wireless > Access Point > AP Profiles > AP Profile SSID** page, right click any of the SSIDs (say *1-dlink1*), and click **Edit**.

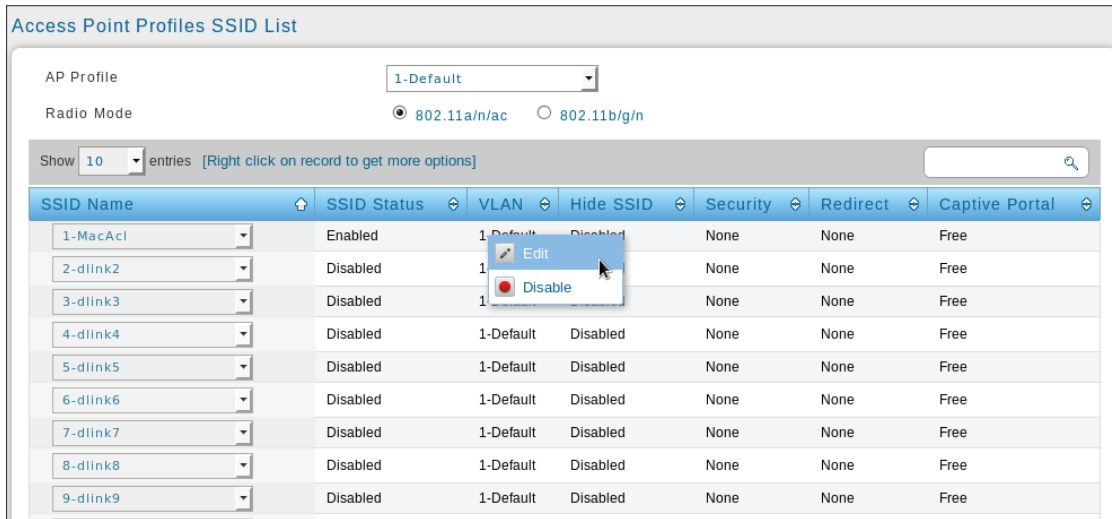

- Enable the **Client QoS** option, and select the configured MAC ACL for **Client QoS Access Control Down** and **Client QoS Access Control Up**.

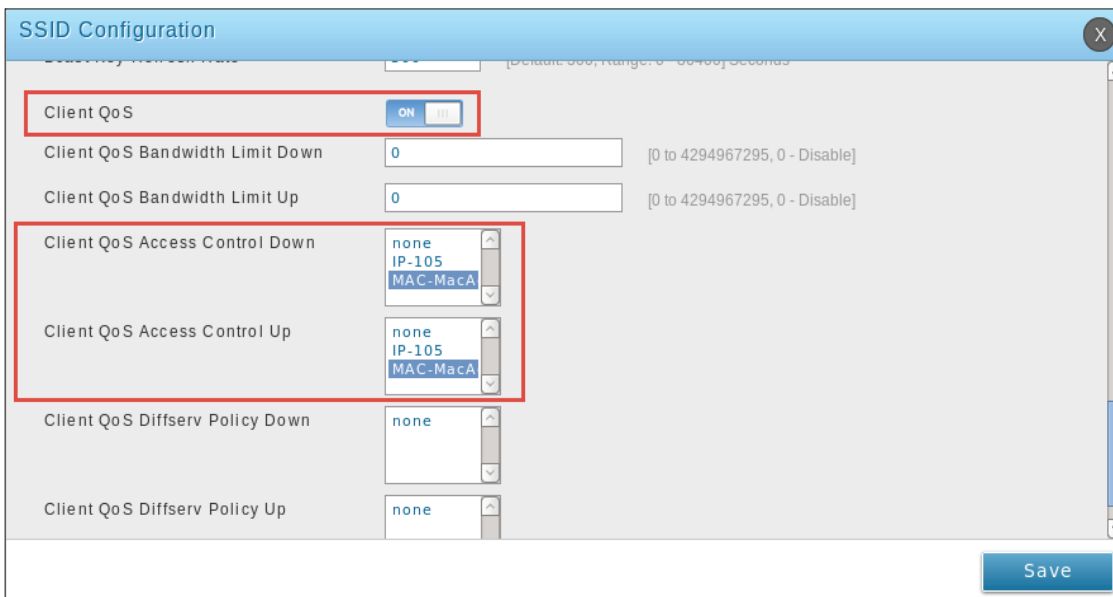

- Go to **Wireless > Access Point > AP Profiles** page, and to push the configuration to AP, right click the AP Profile, and click **Apply**.

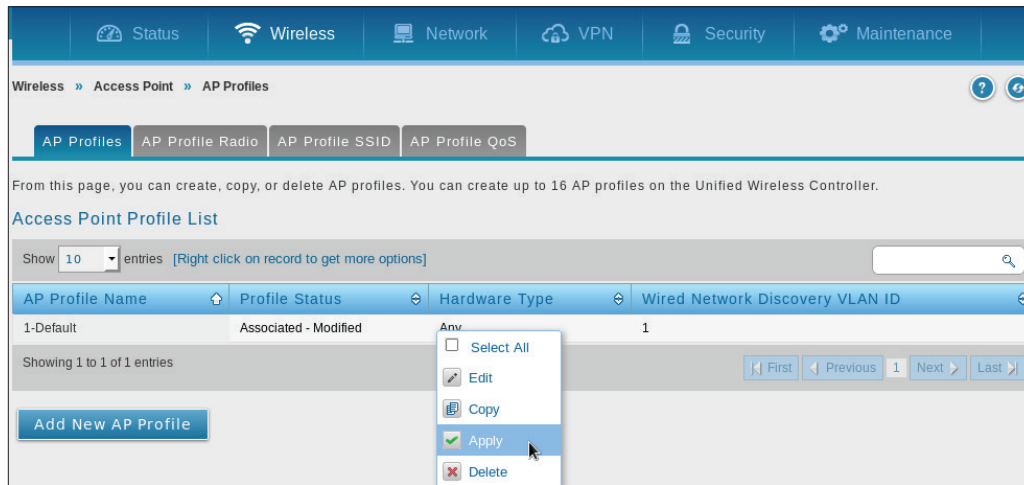

11. To test the MAC ACL configuration, connect two wireless clients (STA1, STA2) and try to ping/HTTP STA2 from STA1 and vice-versa. You will observe that the ACL will block the traffic between the two stations.

DiffServ

The QoS feature contains Differentiated Services (DiffServ) support that allows traffic to be classified into streams and given certain QoS treatment in accordance with defined per-hop behaviors. To use DiffServ for QoS, the web pages accessible from the Differentiated Services menu first be used to define the following categories and their criteria:

1. Class: Create class and define class criteria
2. Policy: Create policies, associate classes with policies, and define policy statements.
3. Service: Add a policy to an inbound interface.

Packets are classified and processed based on the defined criteria. The classification criteria is defined by a class. The processing is defined by a policy's attributes. Policy attributes may be defined on a per-class instance basis, and it is these attributes that are applied when a match occurs. A policy can contain multiple classes. When the policy is active, the actions taken depend on which class matches the packet.

Packet processing begins by testing the class match criteria for a packet. A policy is applied to a packet when a class match within that policy is found.

DiffServ Class

Path: **Wireless > DiffServ > DiffServ Class**

DiffServ Class and Class Configuration pages are used to add a new DiffServ Class name, or to rename or delete an existing class. This feature allows the user to define the criteria to associate with a DiffServ Class. As packets are received, these DiffServ Class is used to prioritize packets.

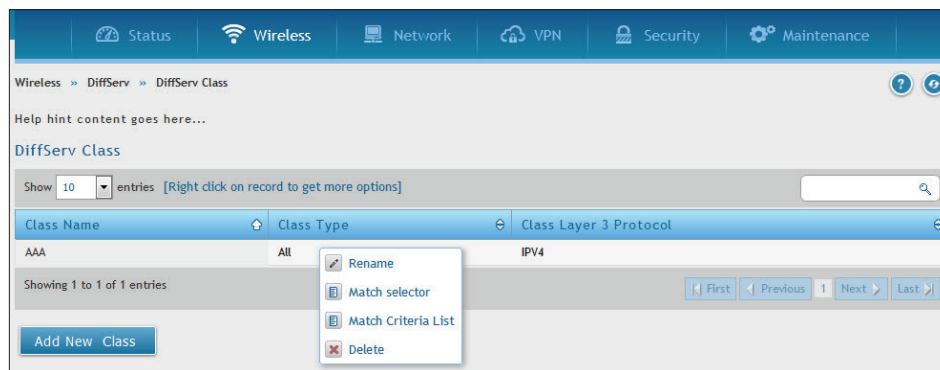

The fields available on the Class Configuration page depend on whether you create a new class or configure a class that has already been created.

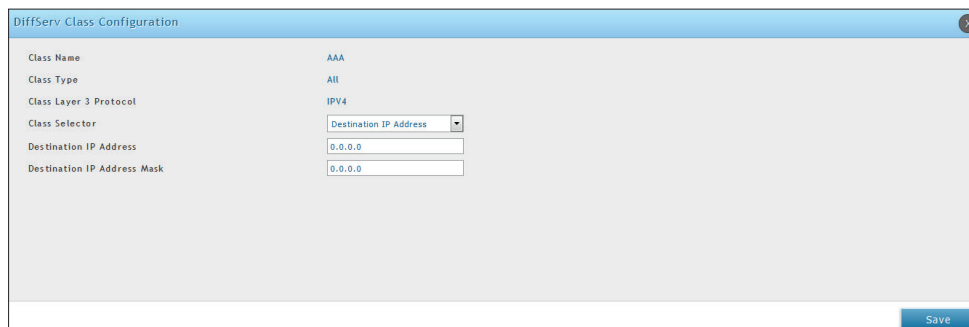

To configure the DiffServ Class Configuration, refer to the table below:

Field	Description
Class Name	Enter a class name. To create a new class, select the class type. To rename an existing class, click Rename after you enter the class name.
Class Type	Lists all of the class types. Currently, the hardware supports only the Class Type value All , which means all the various match criteria defined for the class should be satisfied for a packet match. All signifies the logical AND of all the match criteria.
Class Match Selector (IPv4)	<p>The menu lists all match criteria you can add to a specified class. To configure the criteria, select a match criteria from the list, and then click Add Match Criteria. The screen changes to the criteria configuration page for that class. The match criteria and configurable fields are as follows:</p> <ul style="list-style-type: none"> • Destination IP Address: Requires a packet's destination IP address to match the address listed here. In the IP Address field, enter a valid destination IP address in dotted decimal format. In the IP Mask field, enter a valid subnet mask to determine the significant bits in the IP address. Note that this is not a wildcard mask. • Destination Layer 4 Port: Requires a packet's TCP/UDP destination port to match the port you select. Select the desired L4 keyword from the list on which the rule can be based. If you select Other, the screen refreshes and a Port ID field appears. Enter a user-defined Port ID by which packets are matched to the rule. The valid range is 0-65535. • Any: All packets are considered to match the specified class and no additional input information is needed. • IP DSCP: Matches the packet's DSCP to the class criteria's when selected. Select the DSCP type from the menu or enter a DSCP value to match. If you select Other, enter a custom value in the DSCP Value field that appears. The valid range is 0-63. • IP Precedence: Matches the packet's IP Precedence value to the class criteria's. Enter a value in the range of 0-7. • IP TOS: Matches the packet's Type of Service bits in the IP header to the class criteria's when selected and a value is entered. In the TOS Bits field, enter a two-digit hexadecimal number to match the bits in a packet's TOS field. In the TOS Mask field, specify the bit positions that are used for comparison against the IP TOS field in a packet. • Protocol: Requires a packet's layer 4 protocol to match the protocol you select. If you select Other, enter a protocol number in the field that appears. The valid range is 0-255. • Reference Class: Selects a class to start referencing for criteria. If the specified class references another class, the Reference Class match criterion disappears from the match list to prevent you adding another class reference, since a specified class can reference at most one other class of the same type. • Source IP Address: Requires a packet's source port IP address to match the address listed here. In the IP Address field, enter a valid source IP address in dotted decimal format. In the IP Mask field, enter a valid subnet mask to determine the significant bits in the IP address. Note that this is not a wildcard mask. • Source L4 Port: Requires a packet's TCP/UDP source port to match the port you select. Select the desired L4 keyword from the list on which the rule can be based. If you select Other, the screen refreshes and a Port ID field appears. Enter a user-defined Port ID by which the packets are matched to the rule. The valid range is 0-65535.

DiffServ Policy

Path: **Wireless** > **DiffServ** > **DiffServ Policy**

The DiffServ Policy Configuration page is used to associate a collection of classes with one or more policy statements.

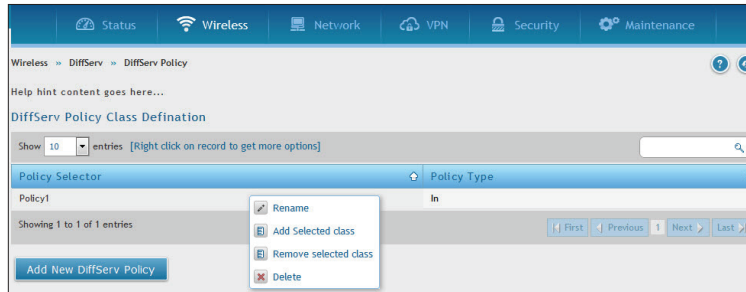

To configure the DiffServ Policy:

- Go to **Wireless** > **DiffServ** > **DiffServ Policy** page.
- Click **Add New DiffServ Policy**.
- Fill-in the details (refer the table given below).

Field	Description
Policy Selector	To create a new policy, click Add New DiffServ Policy; another page appears to facilitate creation of a new policy. To change a policy name or to modify the class list members, select the policy name from the menu and click Rename .
Policy Name	Enter a name to associate with the class(es). The name is case-sensitive alphanumeric string from 1-31 characters uniquely identifying a policy. To modify the name of the existing policy, select it and click Rename; enter a new name in the Policy Name field, and then click Save .
Policy Type	The available policy type is <i>In</i> , which indicates that the type is specific to inbound traffic.

- Click **Add Selected Class** to select a class from the available class list. The menu lists all existing DiffServ class names. The list is automatically updated as a new class is added or removed from the policy. To associate a DiffServ class with a policy, select the name of the class from the list, and then click **Add Selected Class**.

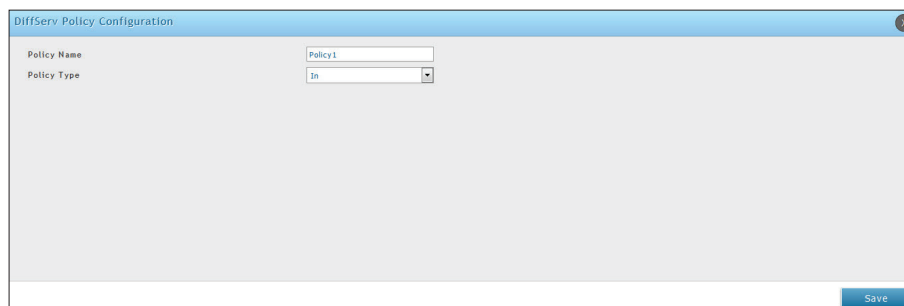

DiffServ Policy Class Definition

Path: **Wireless** > **DiffServ** > **DiffServ Policy Class Definition**

The Policy Class Definition is used to associate a class to a policy and to define attributes for that policy-class instance.

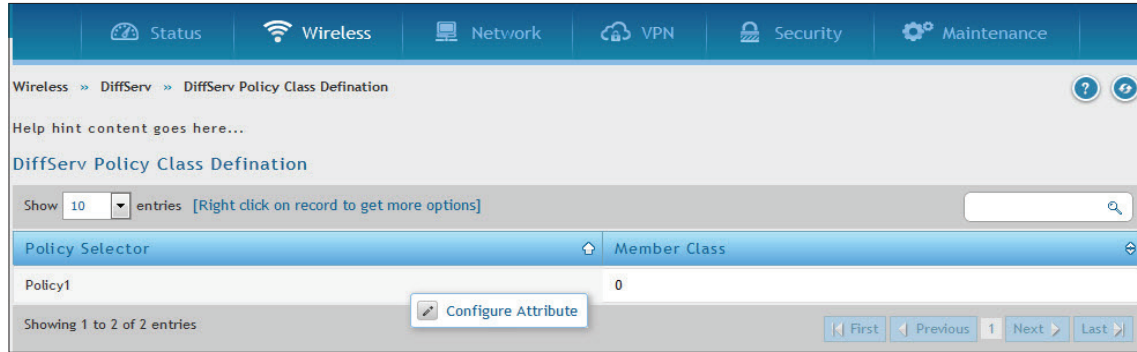

The fields present on this page are as follows:

- **Policy Selector:** Select the policy to associate with a member class from the menu.
- **Policy Type:** The read-only field shows the type of policy.
- **Member Class List:** Select the member class to associate with this policy name from the menu.

Right click any of the Policy Selectors and click **Configure Attribute**. This opens a page of DiffServ Policy Class Definition Configuration.

To configure DiffServ Policy Class Definition Configuration, fill-in the fields (refer to the table below).

Field	Description
Policy Selector	Select the policy to associate with the member class from the menu.
Policy Type	The read-only field shows the type of policy.
Member Class List	Select the member class to associate with this policy name from the menu.

Field	Description
<p>Policy Attribute Selector</p>	<p>The menu lists all the attributes supported for this type of policy, from which one can be selected. To configure the attributes, select an attribute from the list. The screen changes to the attribute configuration page for that attribute. After you configure the attribute, click Save to apply the criteria to the class and return to the Policy Class Definition page. The attributes and configurable fields are as follows:</p> <ul style="list-style-type: none"> • Assign Queue: Assigns the packets of this policy-class to a queue. Enter an integer from 0-7 in the Queue Id Value field. • Drop Packets: Select this field to drop packets for this policy-class. There are no fields to configure. Once you select Drop, click Save, and the attribute is added to the policy. • Mark CoS: Enter the specified Class of Service queue number to mark all packets for the associated traffic stream with the specified class of service value in the priority field of the 802.1p header (the only tag in a single tagged packet or the first or outer 802.1q tag of a double VLAN tagged packet). If the packet does not already contain this header, one is inserted. The CoS value is an integer from 0 to 7. • Mark IP DSCP: Use this attribute to mark all packets for the associated traffic stream with IP DSCP value you choose from the menu. • Mark IP Precedence: Use this attribute to mark all packets for the associated traffic stream with the IP Precedence value you enter in the IP Precedence Value field. • Police Simple: Use this attribute to establish the traffic policing style for the specified class. The simple form of the police command uses a single data rate and burst size, resulting in two outcomes: conform and violate. The conforming data rate is specified in kilobits-per-second (Kbps) and is an integer from 1 to 4294967295. The conforming burst size is specified in kilobytes (KB) and is an integer from 1 to 128. The Police Simple attribute configuration page has the following configurable fields: <ul style="list-style-type: none"> • Color Mode: Color Aware mode requires the existence of one or more color classes that are valid for use with this policy instance. A valid color class contains a single, non-excluded match criterion for one of the following fields (provided the field does not conflict with the classifier of the policy instance itself): <ul style="list-style-type: none"> - IP DSCP - IP Precedence • Conform Action Selector: It determines what happens to packets that are considered conforming. Select one of the following actions: <ul style="list-style-type: none"> - Send: (default) These packets are presented unmodified by DiffServ to the system forwarding element. - Drop: These packets are immediately dropped. - Mark CoS: These packets are marked by DiffServ with the specified CoS value before being presented to the system forwarding element. This selection requires that the Mark CoS value field be set. - Mark IP DSCP: These packets are marked by DiffServ with the specified DSCP value before being presented to the system forwarding element. This selection requires that the DSCP value field be set. - Mark IP Precedence: These packets are marked by DiffServ with the specified IP Precedence value before being presented to the system forwarding element. This selection requires that the Mark IP Precedence value field be set. • Violate Action: It determines what happens to the packets that are considered non-conforming. The available actions are: Drop, Mark CoS, Mark IP DSCP, Mark IP Precedence and Send.

Field	Description
Violate Action	<p>It determines what happens to packets that are considered non-conforming (above the police rate). Select one of the following actions:</p> <ul style="list-style-type: none">• Drop: These packets are immediately dropped.• Mark CoS: These packets are marked by DiffServ with the specified CoS value before being presented to the system forwarding element. This selection requires that the Mark CoS value field be set.• Mark IP DSCP: These packets are marked by DiffServ with the specified DSCP value before being presented to the system forwarding element. This selection requires that the DSCP value field be set.• Mark IP Precedence: These packets are marked by DiffServ with the specified IP Precedence value before being presented to the system forwarding element. This selection requires that the Mark IP Precedence value field be set.• Send: (default) These packets are presented unmodified by DiffServ to the system forwarding element.

Distributed Tunnel

The Distributed Tunneling mode, also known as AP-AP tunneling mode, is used to support L3 roaming for wireless clients without forwarding any data traffic to the wireless controller.

In the AP-AP tunneling mode, when a client first associates with an AP in the wireless system, the AP forwards its data using the VLAN forwarding mode. The AP to which the client initially associates is the Home AP. The AP to which the client roams is the Association AP.

When a client roams to another AP in a different subnet the Association AP tunnels all traffic from the client to the Home AP using a CAPWAP L2 tunnel. The Home AP injects the traffic received over the tunnel into the wired network. If a client roams to another AP in the same subnet then the tunnel is not created, and the new AP becomes the Home AP for the client.

Path: Wireless > General > Distributed Tunnels

1. Click **Wireless > General > Distributed Tunnels**.

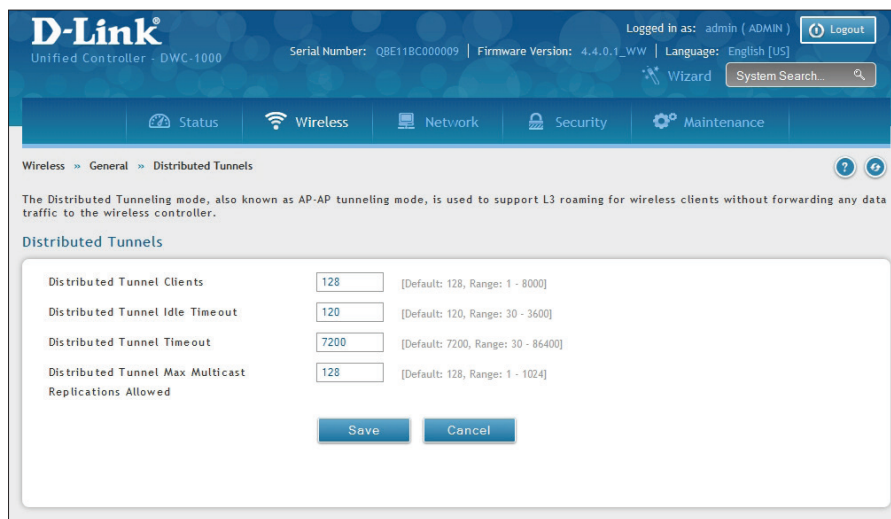

The screenshot shows the D-Link Unified Controller web interface. The top navigation bar includes 'Status', 'Wireless', 'Network', 'Security', and 'Maintenance'. The 'Wireless' section is expanded to show 'General' and 'Distributed Tunnels'. The 'Distributed Tunnels' page contains the following configuration fields:

Setting	Value	Default / Range
Distributed Tunnel Clients	128	[Default: 128, Range: 1 - 8000]
Distributed Tunnel Idle Timeout	120	[Default: 120, Range: 30 - 3600]
Distributed Tunnel Timeout	7200	[Default: 7200, Range: 30 - 86400]
Distributed Tunnel Max Multicast Replications Allowed	128	[Default: 128, Range: 1 - 1024]

Buttons for 'Save' and 'Cancel' are located at the bottom of the configuration area.

2. Configure the following settings:

- **Distributed Tunnel Clients** - Specify the maximum number of distributed tunneling clients that can roam away from the Home AP at the same time.
- **Distributed Tunnel Idle Timeout** - Specify the number of seconds of no activity by the client before the tunnel to that client is terminated and the client is forced to change its IP address.
- **Distributed Tunnel Timeout** - Specify the number of seconds before the tunnel to the roamed client is terminated and the client is forced to change its IP address.
- **Distributed Tunnel Max Multicast Replications Allowed** - Specify the maximum number of tunnels to which a multicast frame is copied on the Home AP.

3. Click **Save**.

WLAN Visualization

WLAN Visualization is a tool that provides a graphical representation of the wireless network through a Web browser. The WLAN Visualization graph does not have a background image of its own, and so the administrator can upload a static graphic image that provides the wireless topology of the APs and controllers in the wireless network.

Upload Images

Path: Wireless > General > WLAN Visualization

User can upload one or more images, such as your office floor plan, to provide customized information for the WLAN Visualization feature. Images file formats that are recommended to upload should be in one of the following formats:

- GIF (Graphics Interchange Format)
- JPG (Joint Photographic Experts Group)

It is also recommended that you do not use color images since the WLAN components might not show up well. Once user uploads an image file and save the running configuration, the image remains on the controller and you can assign it to an existing graph using the WLAN Deployment application.

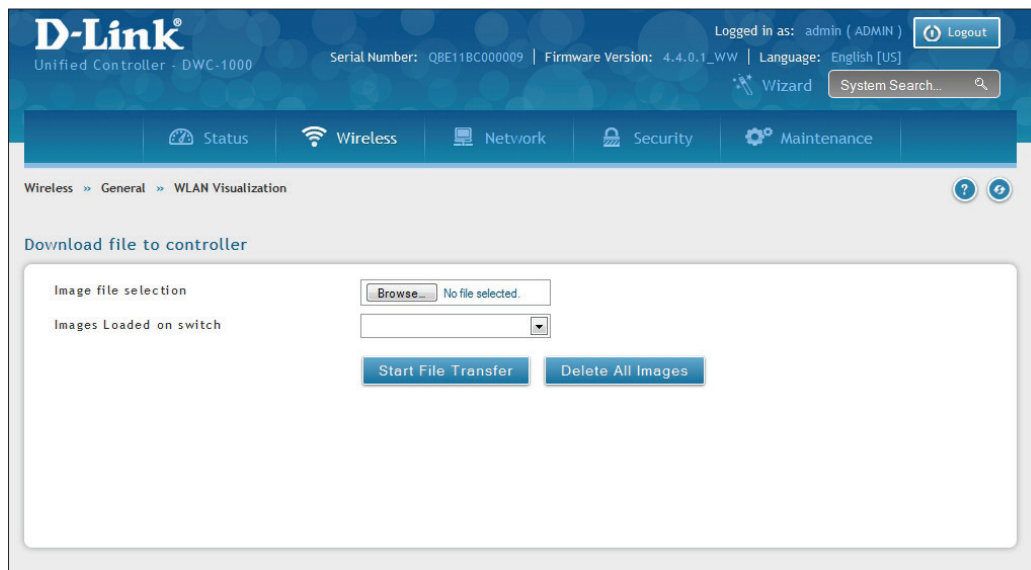

Deleting Images

This option is available only if images are already loaded onto the controller. To delete all images loaded onto the controller, click **Delete All Images**. Deleting background images is not recommended. However, if the user deletes the images, the user has to refresh the WLAN Visualization tool after deleting images.

Launch

Path: Wireless > General > WLAN Deployment

To launch the WLAN Visualization tool, click **Wireless > General > WLAN Deployment**. This opens a new browser window and starts the Java applet that allows the AP and WLAN controller network to be presented as a topology diagram (with or without a custom background image).

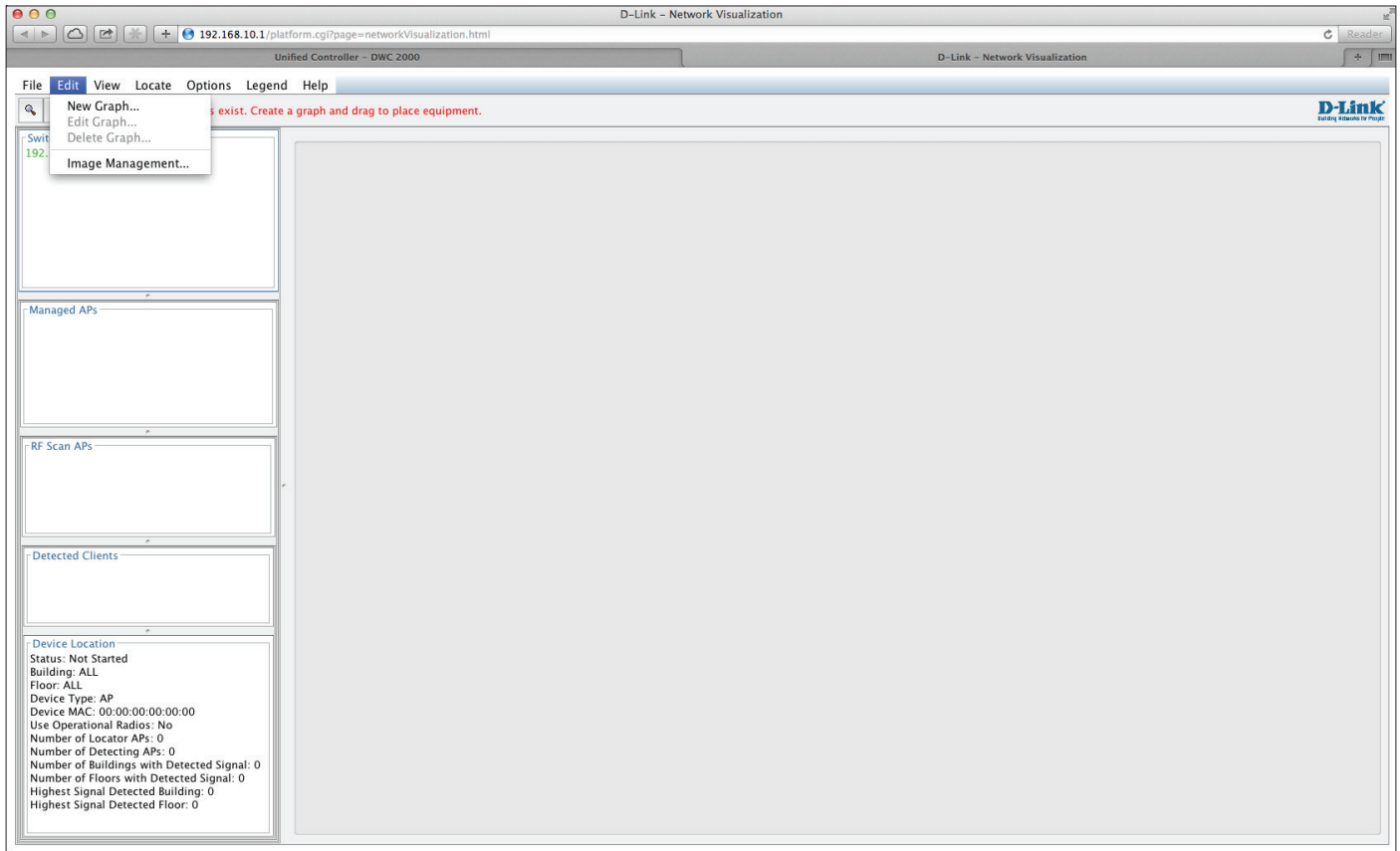

AP Discovery Methods

The wireless controller and AP can use the following methods to discover each other:

- L2 Discovery
- IP Address of AP configured in the wireless controller
- IP Address of the wireless controller configured in the AP

L2/ VLAN Discovery

When the AP and the wireless controller are directly connected or in the same layer 2 broadcast domain and use the default VLAN settings, the wireless controller automatically discovers the AP through its broadcast of a L2 discovery message. The L2 discovery works automatically when the devices are directly connected or connected by using a layer 2 bridge. You can enable the discovery protocol of up to 16 VLANs.

By default, VLAN 1 is enabled on the AP, and VLAN 1 is enabled for discovery on the wireless controller. If the wireless controller and AP are in the same Layer 2 multicast domain, you might not need to take any action to enable AP discovery. The wireless controller also uses L2/VLAN discovery to find peer controllers within the L2 multicast domain.

The APs process the discovery message only when it comes in on the management VLAN. The APs do not forward the L2 discovery messages onto the wireless media.

From the wireless controller, you can check the discovery status of APs and peer controllers. To view information about whether the controller discovered any APs, navigate to the **Wireless > Access Point > Discovered AP List** page. The color of MAC address of the Discovered AP List indicating the AP is:

- Green = Managed AP
- Red = Connected Fail AP or AP (D-Link UAP) which is not in local or RADIUS Valid AP Database
- Gray = Unknown AP or Rogue AP
- Orange = Managed AP by peer controller

The screenshot shows the D-Link Unified Controller web interface. The top navigation bar includes 'Status', 'Wireless', 'Network', 'Security', and 'Maintenance'. The current page is 'Wireless > Access Point > Discovered AP List'. Below the navigation, there is a table titled 'Discovered AP List' with the following data:

MAC Address	IP Address	Last Failure Type	Age	Radio	Channel
FC:75:16:77:5E:00	192.168.10.25	No Database Entry	0h:0m:9s	N/A	N/A

The table also includes a search bar and pagination controls at the bottom, showing 'Showing 1 to 1 of 1 entries'.

Configure L2/ VLAN Discovery

Path: Wireless > Access Point > AP Poll List

1. Click **Wireless > Access Point > AP Poll List > VLAN Discovery** tab.

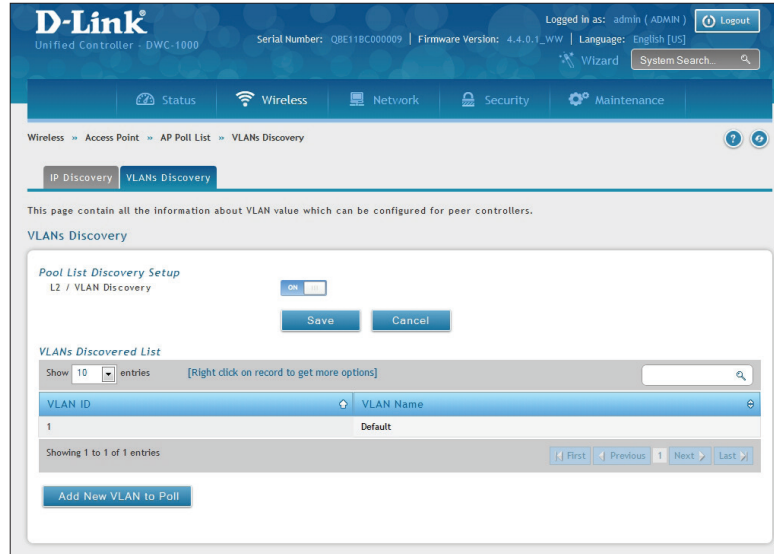

2. Switch *L2/VLAN Discovery* to **ON** and click **Save**.
3. Click **Add New VLAN to Poll**. Enter a VLAN number.

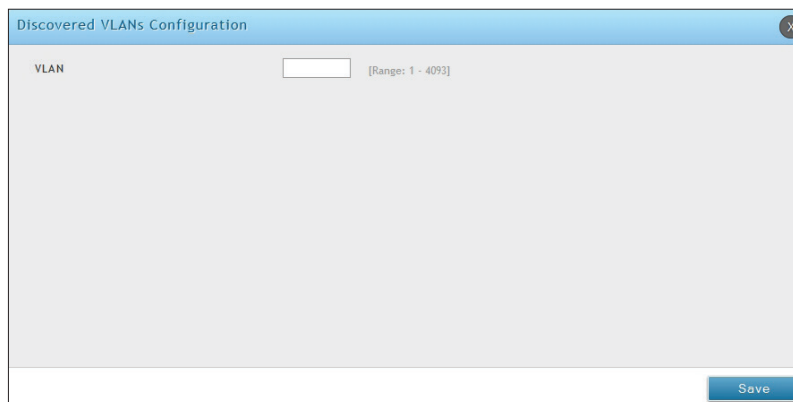

4. Click **Save**.

L3/ IP Discovery

You can configure up to 256 IP addresses in the wireless controller for potential peer controllers and APs. The wireless controller sends association invitations to all IP addresses in this list. If the device accepts the invitation and is successfully validated by the controller, the controller and the AP or peer wireless controller are associated.

This discovery method mechanism is useful for peer wireless controller discovery and AP discovery when the devices are in different IP subnets. In fact, for a wireless controller to recognize a peer that is not on the same subnet, you must configure the IP addresses of each controller in the peer's L3 discovery list.

Configure L3/ IP Discovery

Path: Wireless > Access Point > AP Poll List

1. Click **Wireless > Access Point > AP Poll List > IP Discovery** tab.

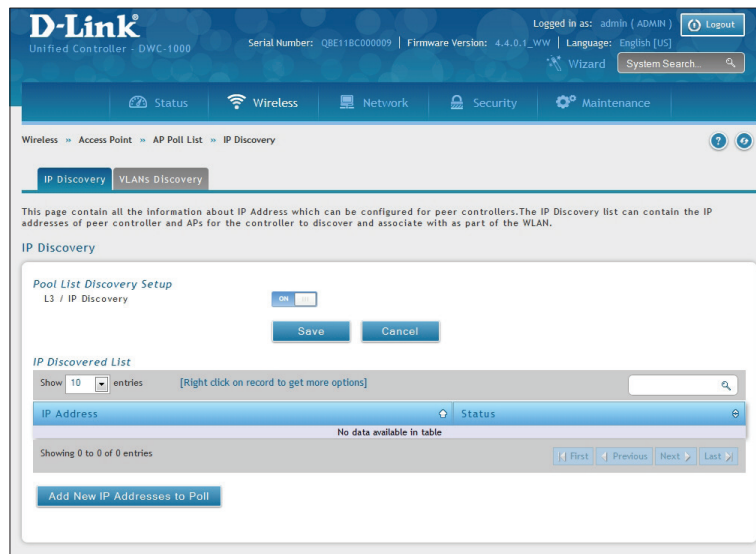

2. Switch *L3/ IP Discovery* to **On** and click **Save**.
3. Click **Add New IP Addresses to Poll**. Enter the IP range.

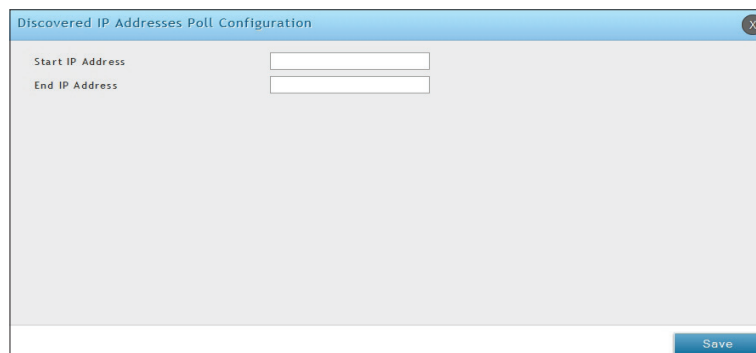

4. Click **Save**.
5. Navigate to **Wireless > Access Point > Discovered AP List**. Check the discovered AP via L3/ IP discovery.

Managed APs

The managed AP information stores in controller local database. You can add/delete, change power/channel, or change the AP profile individually.

The Wireless Global Configuration page contains a field to select whether to use a local or RADIUS database for AP Validation. The Valid Access Point List page contains information about APs configured in the local database. If the AP Validation is set to RADIUS, information about the APs to be managed by the controller must be added to the external RADIUS database.

Add a Valid AP

1. Click **Wireless > Access Point > Managed APs List > Valid AP** tab.

The screenshot shows the D-Link Unified Services Router (DWC-1000) web interface. The user is logged in as 'admin (ADMIN)' and the language is set to 'English [US]'. The page title is 'Valid APs List' under the 'Wireless > Access Point > Managed APs List' navigation path. The page contains a table with the following data:

MAC Address	Location	AP Mode	Profile
12:23:45:12:47:02	c	Managed	1-Default
78:54:2E:34:46:00	g	Rogue	None

Below the table, there are pagination controls showing 'Showing 1 to 2 of 2 entries' and buttons for 'First', 'Previous', '1', 'Next', and 'Last'. A button labeled 'Add New Valid AP' is located at the bottom left of the table area.

2. Click **Add New Valid AP**.
3. Complete the fields on the next page and click **Save**.

Note: To add or delete an AP from the valid AP list, right-click the access point and select **Edit** or **Delete**.

Managed Mode

Standalone Mode

Rogue Mode

Field	Description
MAC Address	MAC address of the access point.
AP Mode	Select standalone, managed, or rogue. Selecting standalone or managed will require you to fill out the fields (refer to the next page). <ul style="list-style-type: none"> Standalone Managed = access point profile configuration has been applied to the access point and the access point operating in managed mode. Rogue = access point has not tried to contact the wireless controller and the access point's MAC address is not in the Valid AP database.
Location	Optional field to identify location of the access point being managed.
Expected SSID	If AP Mode= Standalone, the SSID that the access point should be set to. This is for reference only.
Expected Channel	If AP Mode= Standalone, the channel to be used for wireless communication. This is for reference only.
Expected WDS Mode	If AP Mode= Standalone, the WDS (Wireless Distributed System) link is used to let APs communicate with each other without wires. This is for reference only.
Expected Security Mode	If AP Mode= Standalone, the security mode is to be used. This is for reference only.
Expected Wired Network Mode	If AP Mode= Standalone, select whether wired networking is going to be allowed. This is for reference only.
Authentication Password	If AP Mode= Managed, turn on to require a password for authentication.
Profile	If AP Mode= Managed, select a profile to apply for AP configuration.
Radio	If AP Mode= Managed, this is Wireless radio mode that the access point is using. The fields below appear after you have selected Managed AP Mode.
Channel	If AP Mode= Managed, this is an operating channel for the radio.
Power	If AP Mode= Managed, this is a percentage of power to use for the radio.

Add a AP from Discovered AP List

Path: Wireless > Access Point > Discovered AP List

1. Click **Wireless > Access Point > Discovered AP List**.

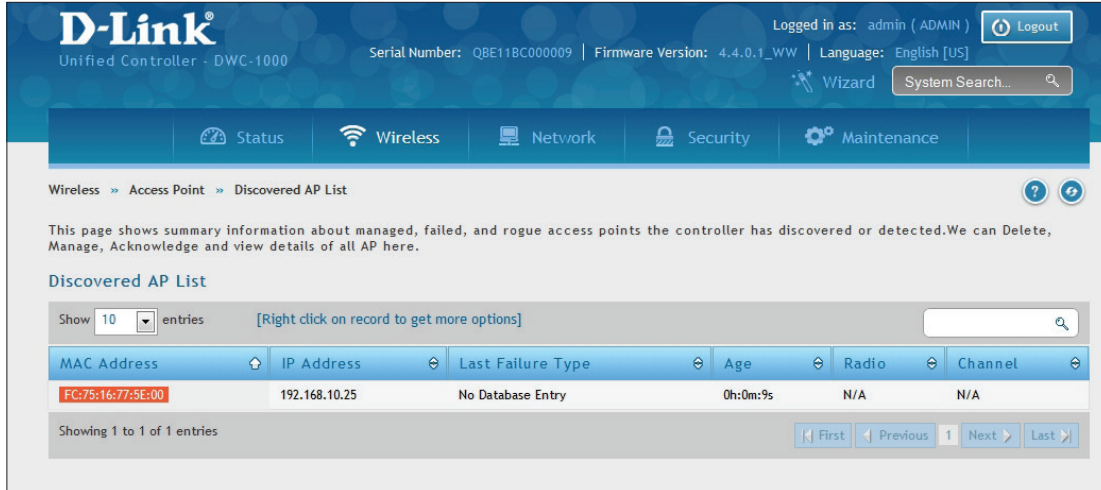

The screenshot shows the D-Link Unified Controller interface. The top navigation bar includes the D-Link logo, "Unified Controller - DWC-1000", and system information: "Serial Number: QBE11BC000009", "Firmware Version: 4.4.0.1_WW", and "Language: English [US]". A "Logout" button is in the top right. Below the navigation bar are tabs for "Status", "Wireless", "Network", "Security", and "Maintenance". The "Wireless" tab is active, and the breadcrumb path "Wireless > Access Point > Discovered AP List" is shown. A description states: "This page shows summary information about managed, failed, and rogue access points the controller has discovered or detected. We can Delete, Manage, Acknowledge and view details of all AP here." Below this is the "Discovered AP List" section, which includes a "Show 10 entries" dropdown and a search box. A table with the following columns is displayed: "MAC Address", "IP Address", "Last Failure Type", "Age", "Radio", and "Channel". One entry is shown with MAC Address "FC:75:16:77:5E:00", IP Address "192.168.10.25", Last Failure Type "No Database Entry", Age "0h:0m:9s", Radio "N/A", and Channel "N/A". The table footer indicates "Showing 1 to 1 of 1 entries" and includes navigation buttons for "First", "Previous", "1", "Next", and "Last".

2. Right-click an AP and select **Manage**.
3. Select an AP Mode and Profile (refer to the previous page), and then click **Save**.

Manual Change Channel and Power of Managed AP

Path: Wireless > Access Point > Managed APs List > Managed APs

From the Managed AP page, you can also manually change the RF channel and power for each radio on an AP. The manual power and channel changes override the settings configured in the AP profile (including automatic channel selection) and take effect immediately. The manual channel and power assignments are not retained when the AP is reset or if the profile is reapplied to the AP, such as when the AP disassociates and re-associates with the controller.

1. Click **Wireless > Access Point > Managed APs List > Managed APs** tab.

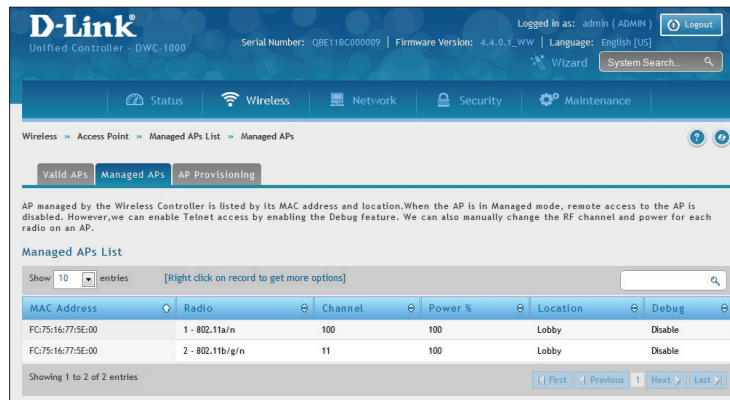

2. Right-click on one of the entries, and select **Channel and Power**.

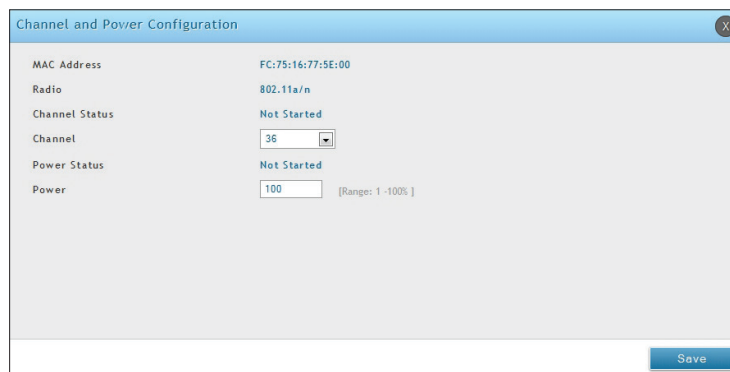

3. Select the channel as your desired. The available channels depend on the radio mode and country in which the APs operate. The manual channel change overrides the channel configured in the AP profile and is not retained when the AP reboots or when the AP profile is reapplied.
4. Change the power as your desired. You can set a new power level for the AP. The manual power change overrides the power setting configured in the AP profile and is not retained when the AP reboots or when the AP profile is reapplied.
5. Click **Save**.

Configure AP Debug Mode

Path: Wireless > Access Point > Managed APs List > Managed APs

When the AP is in Managed mode, remote access to the AP is disabled. However, you can enable Telnet access by enabling the Debug feature on the Managed APs page.

1. Click **Wireless > Access Point > Managed APs List > Managed APs** tab
2. Right-click on one of the entries and select **Debug**.

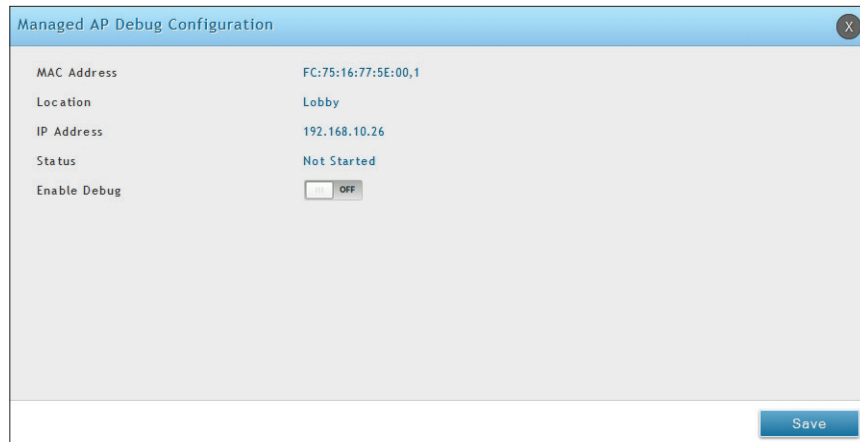

3. Toggle *Enable Debug* to **On**.
4. Click **Save**.

Configure AP Provisioning

Path: Wireless > Access Point > Managed AP List > AP Provisioning

The AP Provisioning feature helps you to add new APs to an existing switch cluster. With AP Provisioning, you can configure the access points with parameters that are needed to connect to the wireless network.

Use AP Provisioning to connect devices to a network enabled for mutual authentication (Wireless > Peer Group > Peer Configuration). If a network is not enabled for mutual authentication, the APs can be attached to the network by properly configuring the local Valid AP database or RADIUS AP database and discovery options. The provisioning feature can optionally be used on networks not enabled for mutual authentication to simplify AP attachment to the cluster.

Use the AP Provisioning page to view detailed provisioning information about an AP and use Edit by right-click to specify the IP address of the primary or backup switch that provides provisioning information for the AP.

1. Go to **Wireless > Access Point > Managed AP List > AP Provisioning** page.

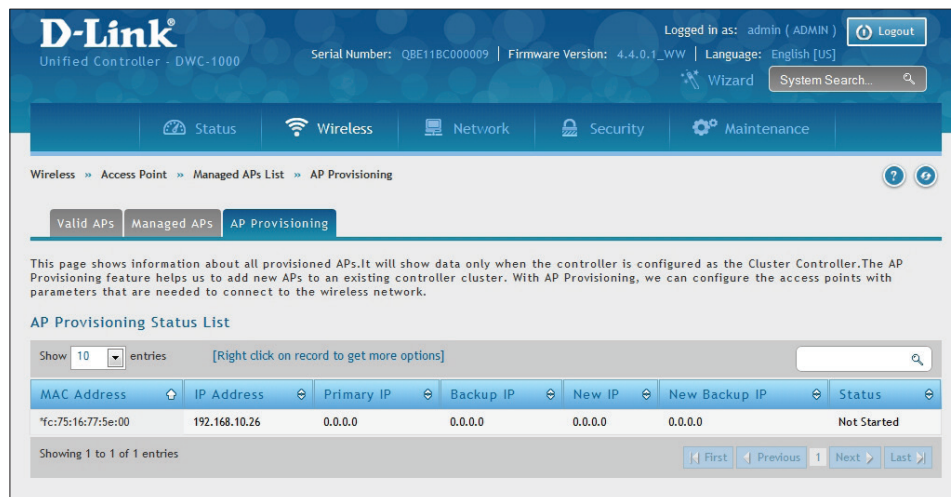

The screenshot shows the D-Link Unified Controller web interface. The breadcrumb path is Wireless > Access Point > Managed APs List > AP Provisioning. The page title is 'AP Provisioning Status List'. Below the title, there is a table with the following data:

MAC Address	IP Address	Primary IP	Backup IP	New IP	New Backup IP	Status
fc:75:16:77:5e:00	192.168.10.26	0.0.0.0	0.0.0.0	0.0.0.0	0.0.0.0	Not Started

The table shows 1 entry. The status is 'Not Started'. The page also includes a search bar and navigation buttons (First, Previous, Next, Last).

2. Right-click a managed AP from the status list and select **Edit**.

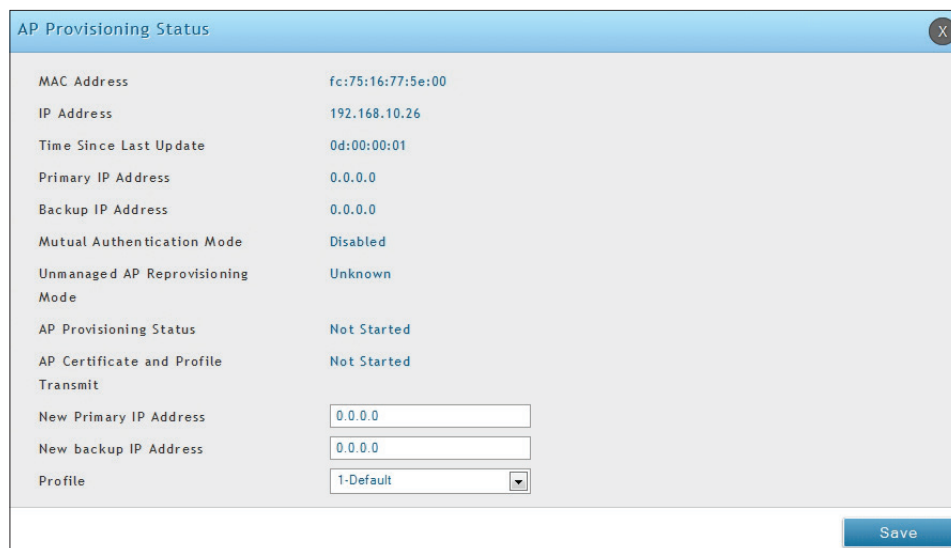

The screenshot shows the 'AP Provisioning Status' dialog box. The dialog displays the following configuration details:

- MAC Address: fc:75:16:77:5e:00
- IP Address: 192.168.10.26
- Time Since Last Update: 0d:00:00:01
- Primary IP Address: 0.0.0.0
- Backup IP Address: 0.0.0.0
- Mutual Authentication Mode: Disabled
- Unmanaged AP Reprovisioning Mode: Unknown
- AP Provisioning Status: Not Started
- AP Certificate and Profile Transmit: Not Started
- New Primary IP Address: 0.0.0.0
- New backup IP Address: 0.0.0.0
- Profile: 1-Default

The dialog includes a 'Save' button at the bottom right.

3. Enter the new primary address, new backup address, and AP Profile.
4. Click **Save**.

Field	Description
MAC Address	MAC address of the access point.
IP Address	IP address of the access point.
Time Since Last Update	Time since any information has been received from this access point.
Primary IP Address	The IP address of the primary provisioned switch as reported by the AP.
Backup IP Address	The IP address of the backup provisioned switch as reported by the AP.
Mutual Authentication Mode	Shows whether the Mutual Authentication mode is currently enabled.
Unmanaged AP Reprovisioning Mode	The configured re-provisioning mode in the AP, which is one of the following: <ul style="list-style-type: none"> • Enable - The AP can be reprovisioned when it is not managed. • Disable - The AP cannot be reprovisioned when it is not managed.
AP Provisioning Status	Status of the most recently issued AP provisioning command, which is one of the following: <ul style="list-style-type: none"> • Not Started - Provisioning has not been done for this AP. • Success - Provisioning finished successfully for this wireless controller. The AP Provisioning Status Table should reflect the latest provisioning configuration. • In Progress - Provisioning is executing for this AP. • Invalid Switch IP Address - Either primary or backup wireless controller IP address is not in the cluster or the mutual authentication mode is enabled and the primary wireless controller IP address is not specified. • Provisioning Rejected - AP is not managed and is configured not to accept provisioning data in unmanaged mode. • Timed Out - The last provisioning request timed out.
AP Certificate and Profile Transmit Status	Status of the last AP profile and X.509 Certificate distribution to the Primary and Backup switches. This status is changed as a result of the AP provisioning command. The X.509 certificate is sent to the primary and backup switches only if mutual authentication is enabled. The status is one of the following: <ul style="list-style-type: none"> • Not Started - No information for this AP has been sent to the primary and backup switch. • Success - AP Profile and X.509 Certificate is sent to Primary and Backup Switches. • Failed - The primary or backup switch wasn't in the cluster when this switch attempted to send the information.
New Primary IP Address	Enter the IP address of the wireless controller that should manage the AP.
New Backup IP Address	Enter the IP address of switch to which the AP should try to connect, if it is unable to connect to the primary wireless controller.
Profile	Select an AP profile you want to use.

AP Profiles

Access point Profile configuration profiles is a useful feature for large wireless networks with APs that serve a variety of different users. You can create multiple AP profiles on the wireless controller to customize APs based on location, function, or other criteria. Profiles are like templates, and once you create an AP profile, you can apply that profile to any AP that the wireless controller manages. For each AP profile, you can configure the following features:

- Profile Settings (Name, Hardware Type ID, Wired Network Discovery VLAN ID)
- Radio Settings
- SSID Settings
- QoS Configuration

Path: Wireless > Access Point > AP Profiles > AP Profiles

1. Click **Wireless > Access Point > AP Profiles > AP Profiles** tab.

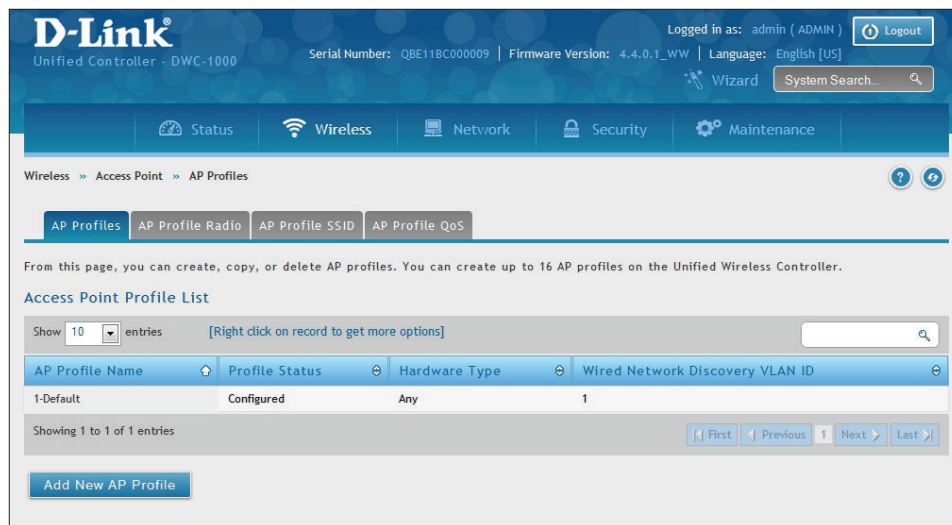

2. Click **Add New AP Profile**.

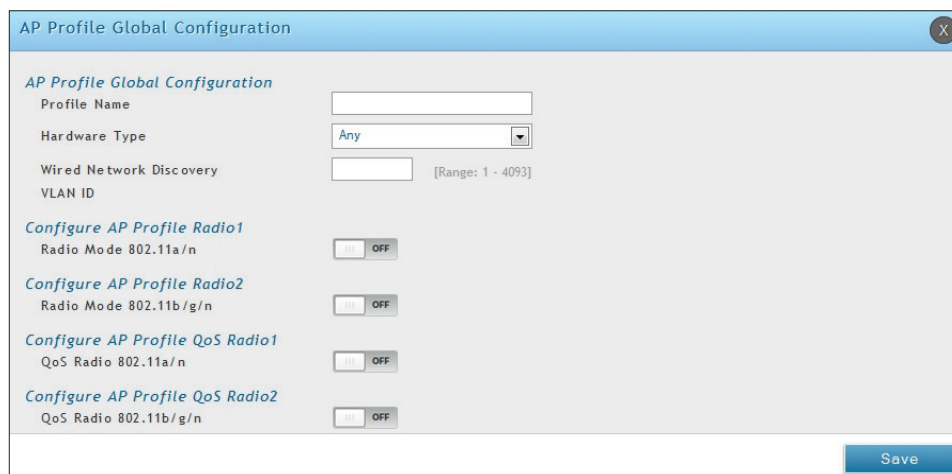

3. Complete the fields in the table below, and click **Save**.

Field	Description
AP Profile Global Configuration	
Profile Name	Identifies the name of the configured profile.
Hardware Type	<p>Hardware type for the APs that use this profile. The hardware type is determined, in part, by the number of radios the AP supports (single or dual) and the IEEE 802.11 modes that the radio supports (a/b/g or a/b/g/n). The available options are:</p> <ul style="list-style-type: none"> • Any • DWL-8600AP Dual Radio a/b/g/n • DWL-3600AP Single Radio b/g/n • DWL-3610AP Single Radio a/b/g/n/ac • DWL-6600AP Dual Radio a/b/g/n • DWL-2600AP Single Radio b/g/n • DWL-8610AP Dual Radio a/b/g/n/ac • DWL-6610AP Dual Radio a/b/g/n/ac • DWL-6700AP Dual Radio a/b/g/n • DWL-8710AP Dual Radio a/b/g/n/ac
Wired network Discovery VLAN ID	LAN ID that the controller uses to send tracer packets in order to detect APs connected to the wired network.
Configure AP Profile Radio 1	
Radio Mode 802.11a/n	In a new AP Profile, you can edit the radio 802.11a/n from here. You can also edit it from AP Profile Radio.
Configure AP Profile Radio 2	
Radio Mode 802.11b/g/n	In a new AP Profile, you can edit the radio 802.11b/g/n from here. You can also edit it from AP Profile Radio.
Configure AP Profile QoS Radio 1	
QoS Radio Mode 802.11a/n	In a new AP Profile, you can edit the QoS on radio 802.11a/n from here. You can also edit it from AP Profile Radio.
Configure AP Profile QoS Radio 2	
QoS Radio Mode 802.11b/g/n	In a new AP Profile, you can edit the QoS on radio 802.11b/g/n from here. You can also edit it from AP Profile Radio.

Configure AP Profile Radio

Path: Wireless > Access Point > AP Profile > AP Profile Radio

To accommodate a broad range of wireless clients and wireless network requirements, the AP can support up to two radios. By default, Radio 1 operates in the IEEE 802.11a/n mode, and Radio 2 operates in the IEEE 802.11b/g/n mode. The difference between these modes is the frequency in which they operate. IEEE 802.11b/g/n operates in 2.4 GHz frequency, and IEEE 802.11a/n operates in 5 GHz frequency of the radio spectrum.

1. Click **Wireless > Access Point > AP Profiles > AP Profile Radio** tab.

The screenshot shows the D-Link Unified Controller interface. The breadcrumb path is Wireless > Access Point > AP Profiles > AP Profile Radio. The page title is 'AP Profile Radio'. Below the title, there is a note: 'This page contains several parameters that are not available for the default. AP Profile. AP can support up to two radios. By default, Radio 1 operates in the IEEE 802.11b/g/n mode, and Radio 2 operates in the IEEE 802.11a/n mode. The difference between these modes is the frequency in which they operate. IEEE 802.11b/g/n operates in the 2.4 GHz frequency, and IEEE 802.11a/n operates in the 5 GHz frequency of the radio spectrum.' Below the note is a table titled 'Access Point Profiles Radio List'.

AP Profile Name	Radio Mode	Status	Sentry Mode	Initial Power	Minimum Power	Max. Clients	Support Channels
1-Default	802.11a/n	On	Disabled	100%	100%	200	36,44,52,60,100,108,132,140,149,157
1-Default	802.11b/g/n	On	Disabled	100%	20%	200	1,2,3,4,5,6,7,8,9,10,11
2-BYOD	802.11a/n	On	Disabled	100%	100%	200	36,44,52,60,100,108,132,140,149,157
2-BYOD	802.11b/g/n	On	Disabled	100%	20%	200	1,2,3,4,5,6,7,8,9,10,11

2. Right-click the radio you want to change, and click **Edit**.

The screenshot shows the 'AP Profile Radio Configuration' dialog box. The 'AP Profile' is '2-BYOD' and the 'Radio Mode' is '1-802.11a/n'. The configuration is divided into several sections:

- Radio Configuration:** State (On), Radio Scheduler (Scheduler Off), RTS Threshold (2347), Load Balancing (Off), Maximum Clients (200), RF Scan Other Channels (On), RF Scan Interval (60), RF Scan Duration (10).
- Mode:** IEEE 802.11a (Selected), IEEE 802.11a/n, IEEE 802.11n/ac, 5GHz IEEE 802.11n.
- DTIM Period:** 10
- Beacon Interval:** 100
- Automatic Channel:** On
- Automatic Power:** On
- Initial Power:** 100
- Minimum Power:** 100
- APSD Mode:** On
- Frag Threshold:** 2346
- Short Retries:** 7
- Long Retries:** 4
- Rate Limiting:** Off
- Transmit Lifetime:** 512
- Receive Lifetime:** 512
- Station Isolation:** Off
- Channel Bandwidth:** 20 MHz, 40 MHz (Selected)
- Primary Channel:** Upper, Lower (Selected)
- Protection:** Auto (Selected), Off
- Short Guard Interval:** On
- Space Time Block Code:** On
- Radio Resource Management:** On
- No ACK:** Off
- Force Roaming:** Off
- Multicast Tx Rate (Mbps):** Auto
- Channels:** Auto Eligible Channels (36, 44, 52, 60), Basic Rate Set (Mbps) (6, 9, 12, 18), Supported Rate Set (Mbps) (6, 9, 12, 18).

3. Complete the fields in the table below and click **Save**.

Field	Description
AP Profile	The name of AP Profile
Radio Mode	The radio mode. 802.11a/n or 802.b/g/n
Radio Configuration	
State	Specify whether you want the radio to be on or off by clicking On or Off. If you turn off a radio, the AP sends disassociation frames to all the wireless clients it is currently supporting, so that the radio can be gracefully shutdown and the clients can start the association process with other available APs. ON= Radio ON OFF= Radio OFF
Radio Scheduler	Select a configured schedule or select Scheduler Off .
RTS Threshold	Specify a Request to Send (RTS) Threshold value between 0 and 2347. The RTS threshold indicates the number of octets in an MPDU, below which an RTS/CTS handshake is not performed. Changing the RTS threshold can help control traffic flow through the AP, especially one with a lot of clients. If you specify a low threshold value, RTS packets will be sent more frequently. This will consume more bandwidth and reduce the throughput of the packet. On the other hand, sending more RTS packets can help the network recover from interference or collisions which might occur on a busy network, or on a network experiencing electromagnetic interference.
Load Balancing	If you enable load balancing, you can control the amount of traffic that is allowed on the AP.
Load Utilization	If Load Balancing is set to ON, this field allows you to set a threshold for the percentage of network bandwidth utilization allowed on the radio. Once the level you specify is reached, the AP stops accepting new client associations. Enter a percentage of utilization from 1 to 100.
Maximum Clients	Specify the maximum number of stations allowed to associate with this access point at any one time. You can enter a value between 0 and 200.
RF Scan Other Channels	The access point can perform RF scans to collect information about other wireless devices within range and then report this information to the wireless controller. If RF Scan Other Channels is set to ON, the radio periodically moves away from the operational channel to scan other channels. Enabling this mode causes the radio to interrupt user traffic, which may be noticeable with voice connections. When the Scan Other Channels= OFF is cleared, the AP scans only the operating channel.
RF Scan Duration	This field controls the amount of time the radio spends scanning the other channel (in milliseconds) during an RF scan.

Field	Description
RF Scan Sentry	<p>Select this option to allow the radio to operate in sentry mode. When the RF Scan Sentry option= ON, the radio primarily performs dedicated RF scanning. The radio passively listens for beacons and traffic exchange between clients and other access points, but does not accept connections from wireless clients.</p> <p>In sentry mode, all VAPs are disabled. Networks that deploy sentry APs or radios can detect devices on the network quicker and perform more thorough security analysis. In this mode, the radio switches from one channel to the next. The length of time spent on each channel is controlled by the scan duration. The default scan duration is 10 milliseconds.</p>
RF Scan Interval	<p>This field controls the length of time between channel changes during the RF Scan.</p>
RF Scan Sentry Channels	<p>The radio can scan channels in the radio frequency used by the 802.11b/g band (2.4 GHz), the 802.11a band (5 GHz), or both bands. Select the channel band for the radio to scan.</p> <p>Note: <i>The band selection applies only to radios in sentry mode and is dependent upon the capabilities of the radio.</i></p>
Mode	<p>The Mode defines the Physical Layer (PHY) standard the radio uses. Select one of the following modes for each radio interface:</p> <ul style="list-style-type: none"> • IEEE 802.11a is a PHY standard that specifies operating in the 5 GHz U-NII band using orthogonal frequency division multiplexing (OFDM). It supports data rates ranging from 6 to 54 Mbps. • IEEE 802.11b/g operates in the 2.4 GHz ISM band. IEEE 802.11b is an enhancement of the initial 802.11 PHY to include 5.5 Mbps and 11 Mbps data rates. It uses direct sequence spread spectrum (DSSS) or frequency hopping spread spectrum (FHSS) as well as complementary code keying (CCK) to provide the higher data rates. It supports data rates ranging from 1 to 11 Mbps. IEEE 802.11g is a higher speed extension (up to 54 Mbps) to the 802.11b PHY. It uses orthogonal frequency division multiplexing (OFDM). It supports data rates ranging from 1 to 54 Mbps. • IEEE 802.11a/n operates in the 5 GHz ISM band and includes support for both 802.11a and 802.11n devices. IEEE 802.11n is an extension of the 802.11 standard that includes multiple-input multiple-output (MIMO) technology. IEEE 802.11n supports data ranges of up to 248 Mbps and nearly twice the indoor range of 802.11 b, 802.11g, and 802.11a. • IEEE 802.11b/g/n operates in the 2.4 GHz ISM band and includes support for 802.11b, 802.11g, and 802.11n devices. • 5 GHz IEEE 802.11n is the recommended mode for networks with 802.11n devices that operate in the 5 GHz frequency that do not need to support 802.11a or 802.11b/g devices. IEEE 802.11n can achieve a higher throughput when it does not need to be compatible with legacy devices (802.11b/g or 802.11a). • 2.4 GHz IEEE 802.11n is the recommended mode for networks with 802.11n devices that operate in the 2.4 GHz frequency that do not need to support 802.11a or 802.11b/g devices. IEEE 802.11n can achieve a higher throughput when it does not need to be compatible with legacy devices (802.11b/g or 802.11a). • IEEE 802.11n/ac operates in 5GHz ISM band and includes support both 11n and 11ac devices.

Field	Description
DTIM Period	<p>The Delivery Traffic Information Map (DTIM) message is an element included in some Beacon frames. It indicates which client stations, currently sleeping in low-power mode, have data buffered on the access point awaiting pick-up.</p> <p>The DTIM period you specify indicates how often the clients served by this access point should check for buffered data still on the AP awaiting pickup.</p> <p>Specify a DTIM period within the given range (1–255).</p> <p>The measurement is in beacons. For example, if you set this field to 1, clients will check for buffered data on the AP at every beacon. If you set this field to 10, clients will check on every 10th beacon.</p>
Beacon Interval	<p>Beacon frames are transmitted by an access point at regular intervals to announce the existence of the wireless network. The default behavior is to send a beacon frame once every 100 milliseconds (or 10 per second). The Beacon Interval value is set in milliseconds. Enter a value from 20 to 2000.</p>
Automatic Channel	<p>The channel defines the portion of the radio spectrum that the radio uses for transmitting and receiving. The range of channels and the default channel are determined by the Mode of the radio interface. When the AP boots, the AP scans the RF area for occupied channels and selects a channel from the available non-interfering or clear channels. However, channel conditions can change during operation.</p> <p>Enabling the Automatic Channel makes APs assigned to this profile eligible for auto-channel selection. You can automatically or manually run the auto-channel selection algorithm to allow the controller to adjust the channel on APs as WLAN conditions change.</p> <p>By default, the global auto-channel mode is set to manual. To enable the automatic channel selection mode, go to the AP Management > RF Management page and select Fixed or Interval for the Channel Plan mode. You can also run the automatic channel selection algorithm manually from the Manual Channel Plan page.</p> <p>Note: If you assign a static channel to an AP in the Valid AP database or on the Advanced AP Management page, the AP will not participate in the auto-channel selection.</p>
Automatic Power	<p>The power level affects how far an AP broadcasts its RF signal. If the power level is too low, wireless clients will not detect the signal or experience poor WLAN performance. If the power level is too high, the RF signal might interfere with other APs within range.</p> <p>Automatic power uses a proprietary algorithm to automatically adjust the RF signal to broadcast far enough to reach wireless clients, but not so far that it interferes with RF signals broadcast by other APs. The power level algorithm increases or decreases the power level in 10% increments based on presence or absence of packet retransmission errors.</p>
Initial Power	<p>The automatic power algorithm will not reduce the power below the number you set in the default power field. By default, the power level is 100%. Therefore, even if you enable the automatic power, the power of the RF signal will not decrease. The power level is a percentage of the maximum transmission power for the RF signal.</p>
APSD Mode	<p>Toggle to ON to enable Automatic Power Save Delivery (APSD), which is a power management method. APSD is recommended if VoIP phones access the network through the AP.</p>
Frag Threshold	<p>The fragmentation threshold limits the size of packets transmitted over the network. Acceptable values are even numbers from 256-2345. Packets that are under the configured size are not fragmented. A value of 2346 means that packets are not fragmented.</p>
Short Retries	<p>The value in this field indicates the maximum number of transmission attempts on frame sizes less than or equal to the RTS Threshold. The range is 1-255.</p>
Long Retries	<p>The value in this field indicates the maximum number of transmission attempts on frame sizes greater than the RTS Threshold. The range is 1-255.</p>

Field	Description
Rate Limiting	<p>Enabling multicast and broadcast rate limiting can improve overall network performance by limiting the number of packets transmitted across the network. This feature is disabled by default.</p> <p>Note: <i>The available rate limit values are very low for most environments, so enabling this feature is not recommended.</i></p> <ul style="list-style-type: none"> • <i>To enable Multicast and Broadcast Rate Limiting, switch ON.</i> • <i>To disable Multicast and Broadcast Rate Disabled, switch OFF.</i>
Rate Limit	<p>Enter the rate limit you want to set for multicast and broadcast traffic. The limit should be greater than 1, but less than 50 packets per second. Any traffic that falls below this rate limit will always conform to and be transmitted to the appropriate destination. The default and maximum rate limit setting is 50 packets per second. This field is disabled if Rate Limiting is disabled.</p>
Rate Limit Burst	<p>Setting a rate limit burst determines how much traffic bursts can be before all traffic exceeds the rate limit. This burst limit allows intermittent bursts of traffic on a network above the set rate limit.</p> <p>The default and maximum rate limit burst setting is 75 packets per second. This field is disabled if Rate Limiting is disabled.</p>
Transmit Lifetime	<p>Shows the number of milliseconds to wait before terminating attempts to transmit the MSDU after the initial transmission.</p>
Receive Lifetime	<p>Shows the number of milliseconds to wait before terminating attempts to reassemble the MMPDU or MSDU after the initial reception of a fragmented MMPDU or MSDU.</p>
Station Isolation	<p>When this option is selected, the AP blocks communication between wireless clients. It still allows data traffic between its wireless clients and wired devices on the network, but not among wireless clients. This feature is disabled by default.</p>
Channel Bandwidth	<p>The 802.11n specification allows the use of a 40-MHz-wide channel in addition to the legacy 20-MHz channel available with other modes. The 40-MHz channel enables higher data rates but leaves fewer channels available for use by other 2.4 GHz and 5 GHz devices. The 40-MHz option is enabled by default for 802.11a/n modes and 20 MHz for 802.11b/g/n modes. You can use this setting to restrict the use of the channel bandwidth to a 20-MHz channel.</p>
Primary Channel	<p>This setting is editable only when a channel is selected and the channel bandwidth is set to 40 MHz. A 40-MHz channel can be considered to consist of two 20-MHz channels that are contiguous in the frequency domain. These two 20-MHz channels are often referred to as the Primary and Secondary channels. The Primary Channel is used for 802.11n clients that support only a 20-MHz channel bandwidth and for legacy clients. Use this setting to set the Primary Channel as the upper or lower 20-MHz channel in the 40-MHz band.</p>
Protection	<p>The protection feature contains rules to guarantee that 802.11 transmissions do not cause interference with legacy stations or applications. By default, these protection mechanisms are enabled (Auto). With protection enabled, protection mechanisms will be invoked if legacy devices are within range of the AP. You can disable (Off) these protection mechanisms; however, when 802.11n protection is off, legacy clients or APs within range can be affected by 802.11n transmissions. 802.11 protection is also available when the mode is 802.11b/g. When protection is enabled in this mode, it protects 802.11b clients and APs from 802.11g transmissions.</p>

Field	Description
Short Guard Interval	<p>The guard interval is the dead time, in nanoseconds, between OFDM symbols. The guard interval prevents Inter-Symbol and Inter-Carrier Interference (ISI, ICI). The 802.11n mode allows for a reduction in this guard interval from the a and g definition of 800 nanoseconds to 400 nanoseconds. Reducing the guard interval can yield a 10% improvement in data throughput.</p> <p>Select one of the following options:</p> <ul style="list-style-type: none"> • ON= The AP transmits data using a 400 ns guard Interval when communicating with clients that also support the 400 ns guard interval. • OFF= The AP transmits data using an 800 ns guard interval.
Space Time Block Code	<p>Space Time Block Coding (STBC) is an 802.11n technique intended to improve the reliability of data transmissions. The data stream is transmitted on multiple antennas so the receiving system has a better chance of detecting at least one of the data streams.</p> <p>Select one of the following options:</p> <ul style="list-style-type: none"> • ON=The AP transmits the same data stream on multiple antennas at the same time. • OFF=The AP does not transmits the same data on multiple antennas.
Radio Resource Management	<p>Radio Resource Measurement (RRM) mode requires the Wireless System to send additional information in beacons, probe responses, and association responses. Enable or disable the support for radio resource measurement feature in the AP profile. The feature is set independently for each radio and is enabled by default.</p>
No Ack	<p>Select Enable to specify that the AP should not acknowledge frames with QoSNoAck as the service class value.</p>
Force Roaming	<p>Select Enable to detect and disconnect wireless clients based on the client RSSI. If the client RSSI falls below the roaming threshold value, the client will be disassociated. The association attempts will be monitored, and if its RSSI is found below the threshold value in 3 consecutive attempts, the client is disconnected. If still the client tries association for the 4th time, the association will be logged and allowed to connect.</p>
Force Roaming Threshold	<p>This value indicates the RSSI reference value which is to be compared with the client RSSI for Force Roaming feature.</p>
Multicast Tx Rate (Mbps)	<p>Select the 802.11 rate at which the radio transmits multicast frames. The rate is in Mbps. The lowest rate in the 5 GHz band is 6 Mbps.</p>
Channel	
Auto Eligible Channels	<p>This field displays the channels that are supported for the radio mode currently selected on the page and for the country configured on the General Settings page. Press Ctrl to select multiple channels.</p>
Basic Rate Set (Mbps)	<p>These numbers indicate the data rates that all stations associating with the AP must support.</p>
Supported Rate Set (Mbps)	<p>These numbers indicate rates that the access point supports. You can select multiple rates. The AP automatically chooses the most efficient rate based on factors like error rates and distance of client stations from the AP.</p>

Configure AP Profile SSID

Path: Wireless > Access Point > AP Profiles > AP Profile SSID

The AP Profile SSID List page displays the virtual access point (VAP) settings associated with the selected AP profile. Each VAP is identified by its network number and Service Set Identifier (SSID). You can configure and enable up to 16 VAPs per radio on each physical access point.

1. Click **Wireless > Access Point > AP Profiles > AP Profiles SSID** tab.

The screenshot shows the D-Link web interface for configuring AP Profile SSID. The page title is "Access Point Profiles SSID List". It features a navigation menu with tabs for "AP Profiles", "AP Profile Radio", "AP Profile SSID", and "AP Profile QoS". The "AP Profile SSID" tab is selected. Below the navigation, there is a description: "This page displays the virtual access point (VAP) settings associated with the selected AP profile. Each VAP is identified by its network number and Service Set Identifier (SSID). We can configure and enable up to 16 VAPs per radio on each physical access point." The "Access Point Profiles SSID List" section includes a dropdown for "AP Profile" (set to "1-Default") and radio mode options "802.11a/n/ac" (selected) and "802.11b/g/n". A table lists 10 SSID entries with columns for SSID Name, SSID Status, VLAN, Hide SSID, Security, Redirect, and Captive Portal. The first entry, "1-anushav", is enabled, while the others are disabled. A pagination bar at the bottom shows "Showing 1 to 10 of 16 entries" and navigation buttons for "First", "Previous", "1", "2", "Next", and "Last".

SSID Name	SSID Status	VLAN	Hide SSID	Security	Redirect	Captive Portal
1-anushav	Enabled	1-Default	Disabled	WPA Personal	None	Permanent
2-dlink2	Disabled	1-Default	Disabled	None	None	Free
3-dlink3	Disabled	1-Default	Disabled	None	None	Free
4-dlink4	Disabled	1-Default	Disabled	None	None	Free
5-dlink5	Disabled	1-Default	Disabled	None	None	Free
6-dlink6	Disabled	1-Default	Disabled	None	None	Free
7-dlink7	Disabled	1-Default	Disabled	None	None	Free
8-dlink8	Disabled	1-Default	Disabled	None	None	Free
9-dlink9	Disabled	1-Default	Disabled	None	None	Free
10-dlink10	Disabled	1-Default	Disabled	None	None	Free

2. Select the AP Profile from the drop-down menu.
3. Select the Radio Mode.
4. Select the SSID name from the drop-down menu.
5. Enable/disable the SSID by right-clicking **Enable** or **Disable**.

Note: SSID ID 1 is always enabled. If you do not want to have the first SSID enabled, you must create a new SSID to be able to swap another SSID in the first slot.

Configure AP Profile QoS

Path: Wireless > Access Point > AP Profiles > AP Profile QoS

Quality of Service (QoS) provides you with the ability to specify parameters on multiple queues for increased throughput and better performance of differentiated wireless traffic like Voice-over-IP (VoIP), other types of audio, video, and streaming media as well as traditional IP data over the wireless controller.

Configuring Quality of Service (QoS) on the wireless controller consists of setting parameters on existing queues for different types of wireless traffic, and effectively specifying minimum and maximum wait times (through Contention Windows) for transmission. The settings described here apply to data transmission behavior on the access point only, not to that of the client stations.

AP Enhanced Distributed Channel Access (EDCA) Parameters affect traffic flowing from the access point to the client station. Station Enhanced Distributed Channel Access (EDCA) Parameters affect traffic flowing from the client station to the access point.

You can specify custom QoS settings, or you can select a template that configures the AP profile with pre-defined settings that are optimized for data traffic or voice traffic.

1. Click **Wireless > Access Point > AP Profiles > AP Profiles QoS** tab.

The screenshot shows the D-Link Unified Services Router (DWC-1000) web interface. The user is logged in as 'admin (ADMIN)' and the language is set to 'English [US]'. The page title is 'D-Link Unified Services Router - DWC-1000'. The breadcrumb navigation is 'Wireless > Access Point > AP Profile > AP Profile QoS'. The page contains a description of QoS and a table titled 'Access Point Profiles QoS List'.

AP Profile Name	Radio Mode	Template
1-Default	1-802.11 a/n/ac	Custom
1-Default	2-802.11b/g/n	Custom

Showing 1 to 2 of 2 entries

2. Right-click an AP Profile, and select **Edit**.

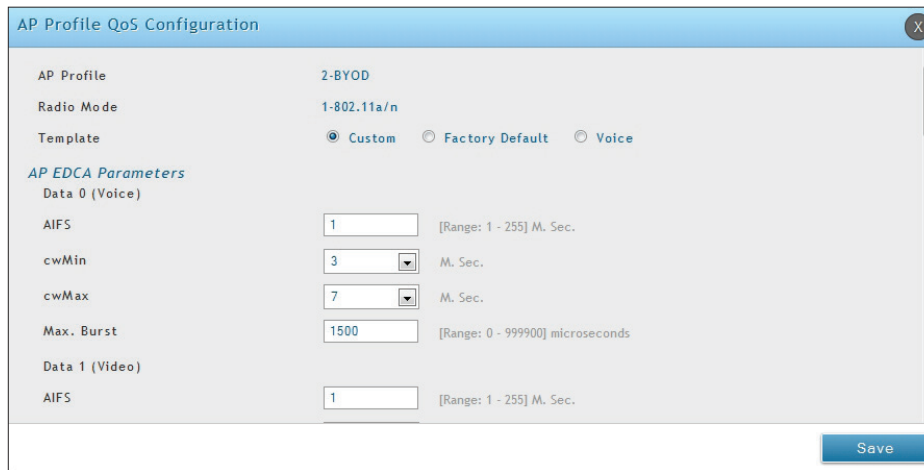

3. Complete the fields below and click **Save**.

Field	Description
AP Profile	The name of AP Profile
Radio Mode	The radio mode. 802.11a/n or 802.b/g/n
Template	Select the QoS template to apply to the AP profile. If you select Custom , you can change the AP and station parameters. If you select Voice or Factory Default , the wireless controller will use the pre-defined settings for the respective template.
AP EDCA Parameters	
Queue	Queues are defined for different types of data transmitted from AP-to-station: <ul style="list-style-type: none"> • Data 0 (Voice)—High priority queue, minimum delay. Time-sensitive data such as VoIP and streaming media are automatically sent to this queue. • Data 1 (Video)—High priority queue, minimum delay. Time-sensitive video data is automatically sent to this queue. • Data 2 (best effort)—Medium priority queue, medium throughput and delay. Most traditional IP data is sent to this queue. • Data 3 (Background)—Lowest priority queue, high throughput. Bulk data that requires maximum throughput and is not time-sensitive is sent to this queue (FTP data, for example).
AIFS (Inter-Frame Space)	The Arbitration Inter-Frame Spacing (AIFS) specifies a wait time for data frames. The wait time is measured in slots. Valid values for AIFS are 1 through 255.
cwMin (Minimum Contention Window)	This parameter is input to the algorithm that determines the initial random backoff wait time (window) for retry of a transmission. The value specified here in the Minimum Contention Window is the upper limit (in milliseconds) of a range from which the initial random backoff wait time is determined. The first random number generated will be a number between 0 and the number specified here. If the first random backoff wait time expires before the data frame is sent, a retry counter is incremented and the random backoff value (window) is doubled. Doubling will continue until the size of the random backoff value reaches the number defined in the Maximum Contention Window. Valid values for the cwmin are 1, 3, 7, 15, 31, 63, 127, 255, 511, or 1024. The value for cwmin must be lower than the value for cwmax.

Field	Description
cwMan (Maximum Contention Window)	<p>The value specified here in the Maximum Contention Window is the upper limit (in milliseconds) for the doubling of the random backoff value. This doubling continues until either the data frame is sent or the Maximum Contention Window size is reached. Once the Maximum Contention Window size is reached, retries will continue until a maximum number of retries allowed is reached.</p> <p>Valid values for the cwmax are 1, 3, 7, 15, 31, 63, 127, 255, 511, or 1024. The value for cwmax must be higher than the value for cwmin.</p>
Max. Burst	<p>AP EDCA Parameter Only (The Max. Burst Length applies only to traffic flowing from the access point to the client station.) This value specifies (in milliseconds) the Maximum Burst Length allowed for packet bursts on the wireless network. A packet burst is a collection of multiple frames transmitted without header information. The decreased overhead results in higher throughput and better performance. Valid values for maximum burst length are 0 through 999.</p>
General Parameters	
WMM Mode	<p>Wi-Fi MultiMedia (WMM) is enabled by default. With WMM enabled, QoS prioritization and coordination of wireless medium access is on. With WMM enabled, QoS settings on the D-Link controller control downstream traffic flowing from the access point to client station (AP EDCA parameters) and the upstream traffic flowing from the station to the access point (station EDCA parameters).</p> <p>Disabling WMM deactivates QoS control of station EDCA parameters on upstream traffic flowing from the station to the access point. With WMM disabled, you can still set some parameters on the downstream traffic flowing from the access point to the client station (AP EDCA parameters).</p> <p>To disable WMM extensions, switch OFF. To enable WMM extensions, switch ON.</p>
Station EDCA Parameters	
Queue	<p>Queues are defined for different types of data transmitted from station-to-AP:</p> <ul style="list-style-type: none"> • Data 0 (Voice)—Highest priority queue, minimum delay. Time-sensitive data such as VoIP and streaming media are automatically sent to this queue. • Data 1 (Video)—Highest priority queue, minimum delay. Time-sensitive video data is automatically sent to this queue. • Data 2 (best effort)—Medium priority queue, medium throughput and delay. Most traditional IP data is sent to this queue. • Data 3 (Background)—Lowest priority queue, high throughput. Bulk data that requires maximum throughput and is not time-sensitive is sent to this queue (FTP data, for example).
AIFS (Inter-Frame Space)	<p>The Arbitration Inter-Frame Spacing (AIFS) specifies a wait time for data frames. The wait time is measured in slots. Valid values for AIFS are 1 through 255.</p>
cwMin (Minimum Contention Window)	<p>This parameter is used by the algorithm that determines the initial random backoff wait time (window) for data transmission during a period of contention.</p> <p>The value specified in the Minimum Contention Window is the upper limit (in milliseconds) of a range from which the initial random backoff wait time is determined.</p> <p>The first random number generated will be a number between 0 and the number specified here.</p> <p>If the first random backoff wait time expires before the data frame is sent, a retry counter is incremented and the random backoff value (window) is doubled. Doubling will continue until the size of the random backoff value reaches the number defined in the Maximum Contention Window.</p>

Field	Description
cwMan (Maximum Contention Window)	The value specified in the Maximum Contention Window is the upper limit (in milliseconds) for the doubling of the random backoff value. This doubling continues until either the data frame is sent or the Maximum Contention Window size is reached. Once the Maximum Contention Window size is reached, retries will continue until a maximum number of retries allowed is reached.
TXOP Limit	Station EDCA Parameter Only (The TXOP Limit applies only to traffic flowing from the client station to the access point.) The Transmission Opportunity (TXOP) is an interval of time when a WME client station has the right to initiate transmissions onto the wireless medium (WM). This value specifies (in milliseconds) the Transmission Opportunity (TXOP) for client stations; that is, the interval of time when a WMM client station has the right to initiate transmissions on the wireless network.

SSID Profiles

The SSID Profile list shows all the wireless networks configured on the controller. The first 16 networks are created by default. You can modify the default networks, but you cannot delete them. You can add and configure up to 16 additional networks for a total of 50 wireless networks. Multiple networks can have the same SSID.

Configure SSID Profiles

Path: Wireless > Access Point > SSID Profiles

1. Click **Wireless > Access Point > SSID Profiles**.

Wireless » Access Point » SSID Profiles

SSID Profile List

Show 10 entries [Right click on record to get more options]

SSID	Name	VLAN	Hide SSID	Security	Redirect	Captive Portal	Authentication Server
1	anushav	1-Default	Disabled	WPA PERSONAL	None	Permanent	local
2	dlink2	1-Default	Disabled	None	None	Free	None
3	dlink3	1-Default	Disabled	None	None	Free	None
4	dlink4	1-Default	Disabled	None	None	Free	None
5	dlink5	1-Default	Disabled	None	None	Free	None
6	dlink6	1-Default	Disabled	None	None	Free	None
7	dlink7	1-Default	Disabled	None	None	Free	None
8	dlink8	1-Default	Disabled	None	None	Free	None
9	dlink9	1-Default	Disabled	None	None	Free	None
10	dlink10	1-Default	Disabled	None	None	Free	None

Showing 1 to 10 of 16 entries

First Previous 1 2 Next Last

Add New SSID Profile

2. To edit an existing SSID, right-click it and select **Edit**. To create a new SSID Profile, click the **Add New SSID Profile** button.

Note: SSID ID 1 is always enabled. If you do not want to have the first SSID enabled, you must create a new SSID to be able to swap another SSID in the first slot.

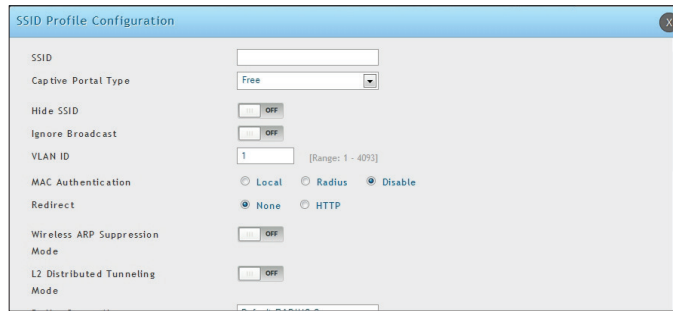

3. Complete the fields in the table below and click **Save**.

Field	Description
SSID	Enter a name of your wireless network. Be sure SSID is the same for all device in your wireless network and is case-sensitive.
Captive Portal Type	<p>Captive Portal type is selected per SSID basis. There are four types of access on a SSID:</p> <ul style="list-style-type: none"> • Free: No authentication is required for users connected to this SSID if this option is selected. • SLA (Service Level Agreement): If this is selected, users connected to this SSID needs to accept Service Level Agreement before accessing anything outside this SSID. • Permanent User: When this option is selected users need to get authenticated before accessing data outside this SSID. Only permanent Captive Portal users can login from this SSID. • Temporary User: When this option is selected users need to get authenticated before accessing data outside this SSID. Only temporary Captive Portal users created by frontdesk user can login from this SSID. • Billing User: When this option is selected users need to get authenticated before accessing data outside this SSID. The temporary Captive Portal billing users created via online wireless service purchasing. The wireless service packages are defined in Login Profile.
Authentication Server	<p>If Captive Portal Type = Permanent User, select the authentication server. All users that log in to the captive portal for this SSID are authenticated through the selected server. The available authentication servers are Local User Databass, Radius Server, LDAP Server, or POP3.</p>
Authentication Type	<p>If Captive Portal Type = Permanent User and Authentication Server = RADIUS server, select the authentication type: PAP, CHAP, MSCHAP, or MSCHAPV2.</p>
Login Profile Name	<p>If Captive Portal Type = Permanent User or Temporary User, select the Login Profile. Any of the available profiles can be used for this SSID.</p>
Hide SSID	<p>You can hide the SSID broadcast to discourage stations from automatically discovering your access point(s). When the broadcast SSID of the AP is hidden, the SSID name is not displayed in the list of available SSID on a client station. Instead, the client must have the exact SSID name configured in the supplicant before it is able to connect.</p> <p>Disabling the broadcast SSID is sufficient to prevent clients from accidentally connecting to your network, but it will not prevent even the simplest of attempts by a hacker to connect or monitor unencrypted traffic.</p> <p>ON = SSID is hidden OFF = SSID is broadcasted</p>

Field	Description
Ignore Broadcast	If a wireless client broadcasts probe requests to all available SSIDs, this option controls whether the AP will respond to the probe request. ON = Prohibits the AP from responding to client probe requests. OFF = Allow the AP to respond to client probe requests.
VLAN ID	Enter a VLAN ID. Be sure this VLAN ID has been created (Network > VLAN > VLAN Setting)
MAC Authentication	If enabled, wireless clients must be authenticated by the AP in order to connect to the network. To use MAC authentication, configure the client MAC addresses in one of the databases: Local or RADIUS. In the database, set a default action to either accept or deny that client or use the global action configured. MAC authentication is useful in networks that operate in Open mode to grant or deny access to clients with specific MAC addresses. MAC Authentication can also be used in conjunction with 802.1X security methods, in which the MAC Authentication is done prior to the 802.1X authentication.
Authentication Type	If Captive Portal Type = Permanent User and Authentication Server = RADIUS server, select the authentication type: PAP, CHAP, MSCHAP, or MSCHAPV2.
Redirect	Select the HTTP option in the <i>Redirect</i> field to redirect wireless clients to a custom Web page. When redirect mode is enabled, the user will be redirected to the URL you specify after the wireless client associates with an AP and the user opens a web browser to access the Internet. The custom Web page must be located on an external web server and might contain information such as the company logo and network usage policy. Note: <i>The wireless client is redirected to the external Web server only once while it associated with the AP.</i> Redirect functionality allows you to implement captive portal functionality; a captive portal is often used at Wi-Fi hotspots to provide branding for the hotspot provider and/or display a legal disclaimer, which the user can click-through to access the Internet. HTTP=HTTP Redirect is enabled None=HTTP Redirect is disabled
Redirect URL	If Redirect = HTTP, enter the URL where all initial HTTP accesses should be redirected to. This field is accessible only when HTTP is selected as the redirect type.
Wireless ARP Suppression Mode	Enable the mode to allow APs to reduce the number of broadcasted ARP requests on the wireless interfaces. Reducing broadcasts helps conserve power on the wireless clients. The wireless clients that use power-save mode must wake up and use more power when they detect broadcast frames. Note: <i>Enabling this feature slightly degrades AP packet forwarding performance due to extra packet filtering to find DHCP packets and extra processing for ARP request and reply packets. Networks that do not use IPv4 should not enable this feature.</i>
L2 Distributed Tunneling Mode	The distributed L2 tunneling mode supports L3 roaming for wireless clients without forwarding any data traffic to the Unified Wireless controller. Use the menu to enable or disable the mode. L2 tunneling is recommended when the Unified Wireless controller does not support hardware forwarding acceleration or hardware-based L2 tunnels. Note: 1 - <i>When there is only one controller managing all APs and that controller goes down, all APs shut down their radios and the tunnel is terminated. After the controller recovers and the AP becomes managed again, the client that was previously tunneling traffic will re-associate and obtain an IP address on the network where it's currently located. This IP address will be different from the IP address it was using when it was tunneling, and the traffic will not be tunneled.</i> 2 - <i>If the network has peer controllers and the tunnel is established between the APs managed by the peer controller, when a controller managing the home AP fails, the controller managing the association AP detects the failure and terminates the tunnel. At this point the client is disassociated. When the client re-associates, it obtains a new IP address.</i> 3 - <i>If the controller managing the association AP fails, the scenario is the same as in item 1 above. The AP takes down all the radios and the clients disassociate.</i>

Field	Description
RADIUS Authentication Server Status	Indicates whether the RADIUS authentication server is configured for the VAP.
Security	<p>The default access point profile does not use any security mechanism. To protect your network, we recommend you select a security mechanism to prevent unauthorized wireless clients from gaining access to your network. Choices are:</p> <ul style="list-style-type: none">• None = No security mechanism is used.• WEP = Enable WEP security. Complete the options in Table 3-1.• WPA/WPA2 = Enable WPA/WPA2 security. Complete the options in Table 3-2.

Wireless Distribution System (WDS)

The Wireless Distribution System (WDS) - Managed AP feature allows you to add managed APs to the cluster using over-the-air WDS links through other managed APs. This capability is critical in providing a seamless experience for roaming clients and for managing multiple wireless networks. It can also simplify the network infrastructure by reducing the amount of cabling required. With WDS, APs may be located outdoors where wired connection to the data network is unavailable, or in remote buildings that are not connected to the main campus with a wired network.

The WDS AP group consists of two types of APs: root APs and satellite APs. A root AP acts as a bridge or repeater on the wireless medium and communicates with the controller via the wired link. A satellite AP communicates with the controller via a WDS link to the root AP. The WDS links are secured using WPA2 Personal authentication and AES encryption. When the AP is in Managed mode, remote access to the AP is disabled. However, you can enable Telnet access by enabling the Debug feature on the Managed AP List Settings page.

Support for the WDS-managed AP feature within the Unified Wired and Wireless Access System includes the following:

- The wireless system can contain up to 12 WDS-managed AP groups.
- Each WDS-managed AP group can contain up to four APs.
- An AP can be a member of only one WDS AP group.
- Each satellite AP can have only one WDS link on the satellite APs. This means that a satellite AP must be connected to a root AP. A satellite AP cannot be connected to another satellite AP.

By default, an AP is configured as a root AP. For an AP to be attached to the Wireless System as a satellite AP, configure the following settings on the AP while it is in stand-alone mode:

- Satellite AP mode. This setting enables the satellite AP to discover and establish WDS link with the root AP. By default, the WDS Managed Mode is Root AP.
- Password for WPA2 Personal authentication used to establish the WDS links. Only the satellite APs need this configuration. The root APs get the password from the controller when they become managed.
- Static Channel. The APs on each end of a WDS link must use the same radio and channel to communicate. Configure the satellite AP to use a static channel. For a root AP, set the static channel when you add the AP to the Valid AP database on the controller.
- Optionally, to allow the Ethernet port on a satellite AP to provide wired access to the LAN, you must set the WDS Managed Ethernet Port to Enabled. It is disabled by default.

To configure a WDS managed group and its links, use the following general steps:

1. Configure the satellite APs by connecting to the AP management interface while the AP is in stand-alone mode. Set the WDS Managed Mode to Satellite AP and configure the WDS Group Password.
2. From the controller CLI or web-based interface, create a WDS group.
3. Configure the WDS group password. The password you configure on the controller should be the same as the password you configure on each satellite AP.
4. Add the MAC address of each AP to the WDS group.
5. Configure the WDS links by specifying the MAC address and radio of the AP on each end of the link.

Keep the following considerations in mind when you configure and manage a WDS group:

- Make sure the radios that participate in the WDS link use the same channel. Use one of the following methods to control the channel:
 - When you configure the satellite AP in stand-alone mode, use the Radio page to set a static channel.
 - When you configure the AP in the Valid AP database, specify the channel that the radio must use. By default, the channel is set to Auto.
 - On the Radio page for the AP profile, select only one channel in the list of Auto Eligible channels. By default, multiple channels are enabled.
- D-Link recommends that satellite APs do not have wired connectivity to the wireless controller.
- A configuration push to WDS APs may take up to three minutes to complete.

Configure WDS Managed AP Group

Path: Wireless > Access Point > WDS Groups > WDS Groups

1. Go to **Wireless > Access Point > WDS Groups** page.

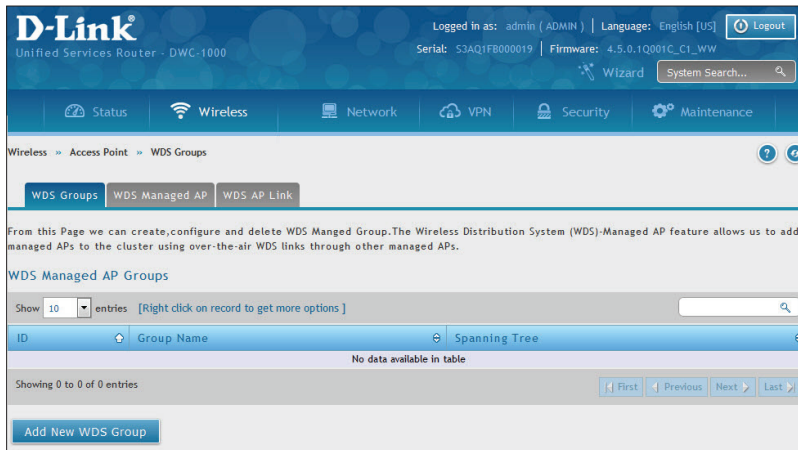

2. Click **Add New WDS Group**.

3. Complete the fields given in the table, and click **Save**.

Field	Description
WDS Group Name	A descriptive name of the WDS AP group, which can contain up to 32 characters.
Spanning Tree	Specifies whether to enable spanning tree on all APs in this WDS AP group. Spanning tree must be enabled if there are any potential loops in the network. For example if a satellite AP has links to two root APs then spanning tree must be enabled. Note: The spanning tree protocol running on the APs interacts with the spanning tree protocol running on the edge switches to which the APs are connected.
Edit Password	Password used for securing WPA2-Personal security on the WDS Link. Range: 8 – 63 ASCII characters. To create or change the password, select the Edit checkbox and type a password in the available field. This password must match the passwords set on the satellite APs in this group. By default, the password is AP-Group-n, where n is the AP group ID.

Configure WDS Managed AP

Path: Wireless > Access Point > WDS Groups > WDS Managed AP

After you create a WDS-Managed AP group, use the WDS Managed AP Configuration page to view the APs that are members of the group, add new members, and change STP Priority values for existing members

1. Click **Wireless > Access Point > WDS Groups > WDS Managed AP** tab.

WDS Managed AP Configuration

This Page allows you to view the APs that are members of the group, add new members, and change STP Priority values for existing members. After you create a WDS-Managed AP group, use the WDS Managed AP Configuration page to view the APs that are members of the group, add new members, and change STP Priority values for existing members.

WDS Managed AP List

Show 10 entries [Right click on record to get more options]

ID	AP MAC	AP Hardware Type	STP Priority
No data available in table			

Showing 0 to 0 of 0 entries

First Previous Next Last

Add New WDS Managed AP

2. Click **Add New WDS Manage AP**.

WDS Managed AP Configuration

WDS Managed Group Id

Valid AP MAC Address

Hardware Type String

WDS AP MAC Address

STP Priority [Length: 0 - 64]

Save

3. Complete the fields in the table below and click **Save**.

Field	Description
WDS Managed Group ID	Select the ID associated with the group to configure.
Valid AP MAC Address	MAC Address of the AP.
Hardware Type String	Select the AP from the drop-down menu.
WDS AP MAC Address	Enter the WDS AP MAC address.
STP Priority	<p>Spanning Tree Priority for this AP. The STP priority is used only when spanning tree mode is enabled.</p> <p>The STP priority determines which AP is selected as the root of the spanning tree and which AP has preference over another AP when multiple equal cost paths exist in the topology. The lower value for the spanning tree priority means that the AP is more likely to be used for bridging data into the campus network. You should assign a lower priority to the APs connected to the wired network than to the satellite APs.</p> <p>The range is 0 – 64.</p>

Configure WDS AP Link

Path: Wireless > Access Point > WDS Groups > WDS AP Link

After you create a WDS-Managed AP group, use the WDS AP Link Configuration page to configure the WDS links between the APs that are members of the group.

1. Click **Wireless > Access Point > WDS Groups > WDS AP Link** tab.



2. Click **Add New WDS AP Link**.

3. Complete the fields in the table below and click **Save**.

Field	Description
WDS Managed Group ID	Select the ID associated with the group to configure.
Source AP MAC Address	MAC Address of the source AP. Note: The WDS links are bidirectional. The terms Source and Destination simply help to differentiate between the WDS link endpoints.
Source AP Radio	The radio number of the WDS link endpoint on the source AP.
Destination AP MAC Address	The MAC address of the destination AP in the group.
Destination AP Radio	The radio number of the WDS link endpoint on the destination AP.
Link Cost	Spanning Tree Path cost for the WDS link. The range is 0–64. When multiple alternate paths are defined in the WDS group, the link cost is used to indicate which links are the primary links and which links are the secondary links. The spanning tree selects the path with the lowest link cost.

Peer Group

The Peer Group Configuration feature allows you to send a variety of configuration information from one wireless controller to all other wireless controllers. In addition to keeping the wireless controller synchronized, this function allows you to manage all wireless controllers in the cluster from one controller.

Configure Peer Group

Path: Wireless > Peer Group > Peer Configuration

You can copy portions of the wireless controller configuration from one controller to another controller in the cluster. The Peer Group Configuration Enable/Disable page allows you to select which parts of the configuration to copy to one or more peer wireless controllers in the group.

You can make changes to a configuration that has been sent to one or more peer controllers, and you can make changes to a configuration received from a peer controller. No changes automatically propagate from one controller to the cluster; you must manually initiate a request on one controller in order to copy any configuration to its peers.

1. Click **Wireless > Peer Group > Peer Configuration**.

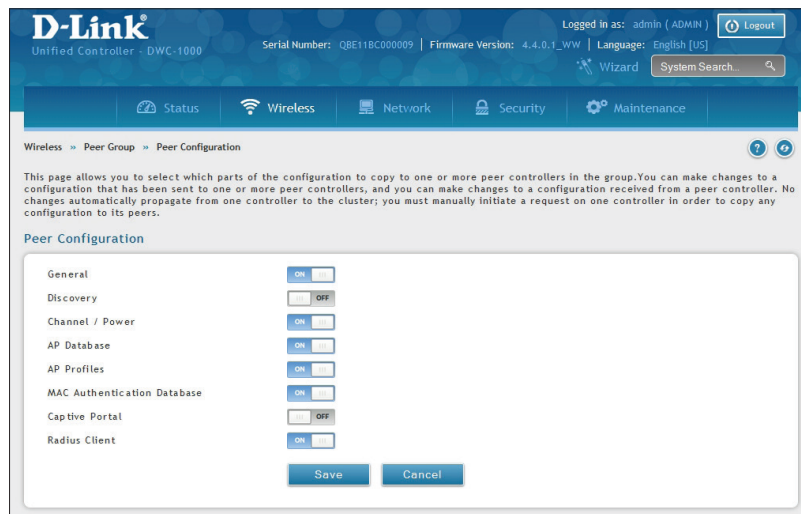

2. Toggle each option to **On** or **Off**, and then click **Save**. Refer to the table below and on the next page.

Field	Description
General	Enable this field to include the basic and advanced global settings in the configuration that the controller pushes to its peers. The configuration does not include the controller IP address since that is a unique setting.
Discovery	Enable this field to include the L2 and L3 discovery information, including the VLAN list and IP list, in the configuration that the controller pushes to its peers.
Channel / Power	Enable this field to include the RF management information in the configuration that the controller pushes to its peers.
AP Database	Enable this field to include the AP Database (Valid AP) in the configuration that the controller pushes to its peers.

Field	Description
AP Profiles	Enable this field to include all the AP profiles in the configuration that the controller pushes to its peers. The AP profile includes the general AP settings, such as the hardware type, Radio settings, SSID Profiles, and QoS settings.
MAC Authentication Database	Enable this field to include the MAC Authentication Database in the configuration that the controller pushes to its peers.
Captive Portal	Enable this field to include the Captive Portal information in the configuration that the controller pushes to its peers.
RADIUS Client	Enable this field to include the Client RADIUS information in the configuration that the controller pushes to its peers.
Unmanaged AP Re-provisioning Mode	Enable to allow access points to accept provisioning information when not managed by a controller.

Synchronize Peer Group

Path: Wireless > Peer Group > Peer Status

Synchronize the settings among the peer group.

1. Click **Wireless > Peer Group > Peer Status**. Peer Status List will appear.

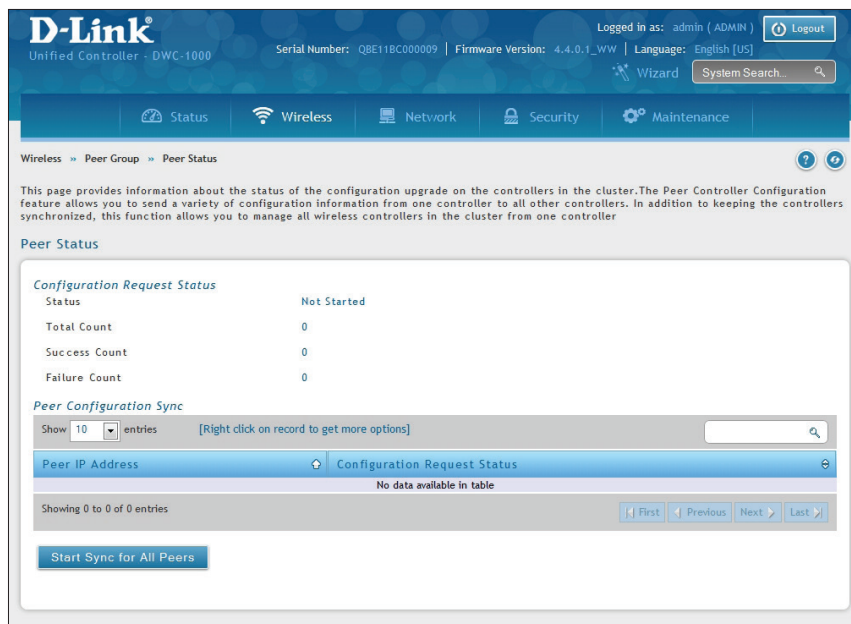

2. Click **Start Sync for All Peers** to synchronize the settings to all controllers, or synchronize one of the peer group by right-clicking **Start Sync**.
3. The fields available on the Peer Status page are give in the table on the next page.

Field	Description
Configuration Request Status	
Status	Indicates the global status for a configuration push operation to one or more peer controllers. The status can be one of the following: <ul style="list-style-type: none">• Not Started• Receiving Configuration• Saving Configuration• Success• Failure Invalid Code Version• Failure Invalid Hardware Version• Failure Invalid Configuration
Total Count	Indicates the number of peer controllers included at the time a configuration download request is started, the value is 1 if a download request is for a single controller.
Success Count	Indicates the total number of peer controllers that have successfully completed a configuration download.
Failure Count	Indicates the total number of peer controllers that have failed to complete a configuration download.
Peer Configuration Sync	
Peer IP Address	Lists the IP address of each controller in the cluster and indicates the configuration request status of that controller.
Configuration Request Status	It shows the configuration request status for the respective Peer IP Address.

AP Firmware Download

The Wireless Controller can upgrade software on the APs that it manages. The Cluster Controller can update code on APs managed by peer wireless controllers.

Path: Maintenance > Firmware > AP Firmware Download

1. Click **Maintenance > Firmware > AP Firmware Download > AP Firmware Download** tab.

The screenshot displays the D-Link Unified Controller web interface. The top navigation bar includes 'Status', 'Wireless', 'Network', 'Security', and 'Maintenance'. The 'Maintenance' tab is active, and the breadcrumb path is 'Maintenance > Firmware > AP Firmware Download'. The 'AP Firmware Download' tab is selected. The main content area contains a form for configuring the firmware download process. The form includes fields for 'Server Address', 'File Path', and 'File Name' for three different AP models: D-Link 8600 AP Radios, D-Link 3600/6600 AP Radios, and D-Link 2600 AP Radios. There is also a 'Group Size' field set to 6 and an 'Image Download Type' dropdown menu set to 'All Images'. A list of managed APs is shown, with the first one selected: 'fc:75:16:77:5e:00-192.168.10.26 - Lobby'. 'Save' and 'Start' buttons are located at the bottom of the form.

2. Complete the fields (refer to the table on the next page) and then select the AP(s) you want to upgrade. Use CTRL + click to select multiple APs.
3. Click **Save** to begin the upgrade process.

Field	Description
Server Address	Enter the IP address of the host where the upgrade file is located. The host must have a TFTP server installed and running.
File Path	Enter the file path on the TFTP server where the software is located. You may enter up to 96 characters.
File Name	Enter the name of the upgrade file. You may enter up to 32 characters, and the file extension .tar must be included.
Group Size	When you upgrade multiple APs, each AP contacts the TFTP server to download the upgrade file. To prevent the TFTP server from being overloaded, you can limit the number of APs to be upgraded at a time. In the Group Size field, enter the number of APs that can be upgraded at the same time. When one group completes the upgrade, the next group begins the process.
Image Download Type	Type of the image to be downloaded, which can be one of the following: <ul style="list-style-type: none"> • All Images • DWL-8600AP • DWL-3600AP/ DWL-6600AP • DWL-2600AP • DWL-8610AP <p>Note: To download all images, make sure you specify the file path and file name for both images in the appropriate File Path and File Name fields.</p>
Managed AP	The list shows all the APs that the controller manages. If the controller is the Cluster Controller, then the list shows the APs managed by all controllers in the cluster. Each AP is identified by its MAC address, IP address, and Location in the <MAC - IP - Location> format. To upgrade a single AP, select the AP MAC address from the drop down list. To upgrade all APs, select All from the top of the list. If All is selected, the Group Size field will limit the number of simultaneous AP upgrades in order not to overwhelm the TFTP server. To select multiple APs to upgrade, CTRL + click the APs to upgrade. Note: D-Link recommends that you upgrade all managed APs at the same time.

AP Firmware Status

Path: Maintenance > Firmware > AP Firmware Download > AP Firmware Status

After the download begins, the AP Firmware Status tab will display information about the upgrade. Refer to the table below:

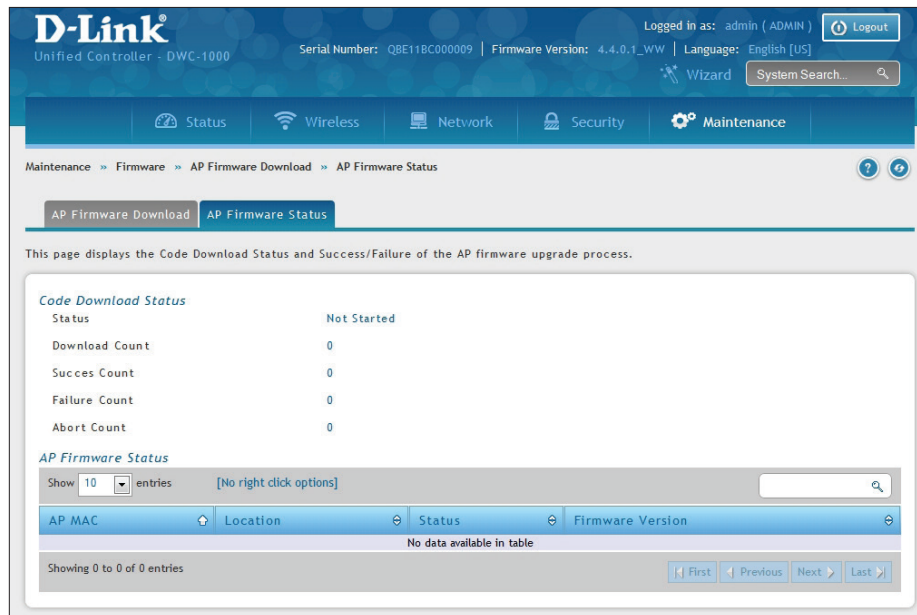

Field	Description
Code Download Status	
Status (Global)	The status of the upgrade process for all APs: <ul style="list-style-type: none"> Not Started: The wireless controller has not started the download process. Requested: A request to download AP software has been made, but the controller has not done any downloads. Code Transfer in Progress: A download is in progress. Failure: Download failed on all APs. Aborted: Download was aborted before the AP loaded code from the TFTP server. NVRAM-Update-in-Progress: Download completed successfully. The reset command has been sent to the AP. Success: All APs are connected to the wireless controller.
Download Count	The number of managed APs to download software in the current download request. If you selected All for the managed APs to upgrade, the download count shows the number of managed APs at the time the download request was started. The value is 1 if only one AP is being updated.
Success Count	The number of APs that have successfully downloaded the new code. This value starts with 0 at the beginning of the download and increases by one for every AP that successfully downloaded the code.
Failure Count	The number of APs that failed to download the new code starting at 0 and incrementing with each failure.
Abort Count	The number of APs for which the download was aborted, starting at 0 and incrementing each aborted download.

AP Firmware Status	
Status (per-AP)	<p>A table also appears and lists each AP, its download status, and the software version it is downloading. The status for an individual AP can have one of the following values:</p> <ul style="list-style-type: none"> • Requested: A download is planned for this AP, but the AP is not in the current download group, so it hasn't been told to start the download yet. • Code-Transfer-In-Progress: The AP has been told to download the code. • Failure: The AP reported a failing code download. • Aborted: The download was aborted before the AP loaded code from the TFTP server. • Waiting-For-APs-To-Download: A download finished on this AP, and it is waiting for other APs to finish download. Reset command is not sent to the AP in this state. • NVRAM-Update-In-Progress: Download completed successfully. The reset command sent to the AP. • Timed-Out: The AP did not reconnect to the controller in the fixed time interval.
AP MAC	The managed AP MAC address.
Location	The location of the managed AP.
Status	Refer to Status (per-AP) above.
Firmware Version	The current firmware version of the managed AP.

Advanced Network Configuration

While the basic configuration described in the previous chapter is satisfactory for most users, large wireless networks or a complex setup may require the wireless controller's advanced configuration settings to be configured.

This chapter covers the following commonly used advanced configuration settings.

- "IP Mode" on page 136
- "IPv4 LAN Settings" on page 137
- "IPv6 LAN Settings" on page 141
- "VLANs" on page 171
- "Configure IPv4 Static Routing" on page 177
- "Configure IPv6 Static Routing" on page 179

Note: *The procedures in this chapter should only be performed by expert users who understand networking concepts and terminology.*

IP Mode

Path: Network > IPv6 > IP Mode

This page allows user to configure the IP protocol version to be used on the controller. In order to support IPv6 on the LAN, you must set the controller to be in IPv4 / IPv6 mode. This mode will allow IPv4 nodes to communicate with IPv6 devices through this controller.

1. Go to **Network > IPv6 > IP Mode**.

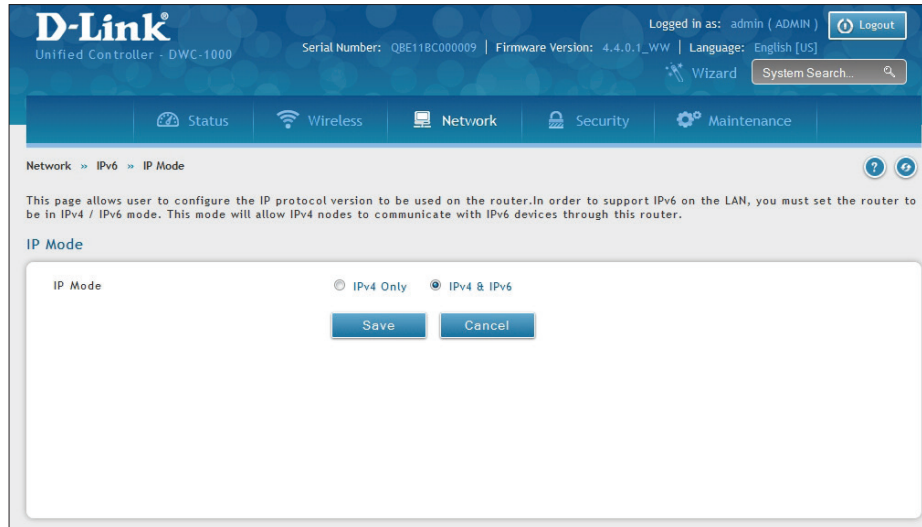

2. Next to *IP Mode*, select either **IPv4 only** or **IPv4 & IPv6**.
3. Click **Save**.

LAN Configuration

IPv4 LAN Settings

Path: Network > LAN > LAN Settings

By default, the controller function the “Dynamic Configuration Protocol (DHCP)” mode is set to **None**. The DHCP mode can be set as DHCP server or DHCP relay. When DHCP server mode is set as DHCP server, the controller functions as DHCP server for assigning IP address leases to host on WLAN or LAN network. With DHCP, PCs and other LAN devices can be assigned IP addresses as well as addresses for DNS servers, Windows Internet Name Service (WINS) servers, and the default gateway. With the DHCP server enabled the controller’s IP address serves as the gateway address for LAN and WLAN clients. The PCs in the LAN are assigned IP addresses from a pool of addresses specified in this procedure. Each pool address is tested before it is assigned to avoid duplicate addresses on the LAN.

For most applications, the default DHCP and TCP/IP settings are satisfactory. If you want another PC on your network to be the DHCP server or if you are manually configuring the network settings of all of your PCs, set the DHCP mode to ‘none’. DHCP relay can be used to forward DHCP lease information from another LAN device that is the network’s DHCP server; this is particularly useful for wireless clients.

Instead of using a DNS server, you can use a Windows Internet Naming Service (WINS) server. A WINS server is the equivalent of a DNS server but uses the NetBIOS protocol to resolve host names. The controller includes the WINS server IP address in the DHCP configuration when acknowledging a DHCP request from a DHCP client.

You can also enable DNS proxy for the LAN. When this is enabled, the controller will act as a proxy for all DNS requests and communicates with the ISP’s DNS servers. When disabled, all DHCP clients receive the DNS IP addresses of the ISP.

1. Click **Network > LAN > LAN Settings**.

The screenshot shows the D-Link Unified Controller (DWC-1000) LAN Settings page. The page is titled "LAN Settings" and contains the following sections:

- IP Address Setup:** IP Address: 192.168.10.1, Subnet Mask: 255.255.255.0
- DHCP Setup:** DHCP Mode: None, Domain Name: DLink
- Default Route:** Enable Default Route: off, SNAT: off
- DNS Host Name Mapping:** A table with columns for Host Name and IP Address.
- LAN Proxy:** Activate DNS Proxy: off
- DHCP Address Pool:** A section for managing DHCP address pools, currently showing "No data available in table".

2. Complete the fields in the table below and click **Save**.

Field	Description
IP Address Setup	
IP Address	LAN interface IP address of the wireless controller.
Subnet Mask	The factory default: 255.255.255.0.
DHCP Setup	
DHCP Mode	<p>There are three DHCP modes to choose from:</p> <ul style="list-style-type: none"> • None: the controller's DHCP server is disabled for the LAN. • DHCP Server: With this option the controller assigns an IP address within the specified range plus additional specified information to any LAN device that requests DHCP served addresses. • DHCP Relay: With this option enabled, DHCP clients on the LAN can receive IP address leases and corresponding information from a DHCP server on a different subnet. Specify the Relay Gateway, and when LAN clients make a DHCP request it will be passed along to the server accessible via the Relay Gateway IP address.
Domain Name	Enter a domain name for LAN configuration.
Lease Time	If DHCP mode = DHCP Server, enter the duration (in hours) for which the IP addresses will be leased to clients.
Configure DNS/WINS	Toggle it to ON to enable the DNS/WINS.
Primary DNS Server	Enter the primary DNS Server IP.
Secondary DNS Server	Enter the secondary DNS Server IP.
WINS Server	Enter the WINS server IP (optional). The Windows Internet Naming Service is equivalent to the DNS Server but uses NetBIOS protocol to resolve the hostnames. If the network consists only of Windows based computers and you would like to use a WINS server for name resolution, enter the IP address in the DHCP configuration when acknowledging a DHCP request from a DHCP client.
Default Gateway	If DHCP mode = DHCP Server: Enter the default gateway for the DHCP server mode.
Gateway	If DHCP mode= DHCP Relay. Enter the relay gateway address.
DNS Host Name Mapping	
Host Name	Enter a DNS host name.
IP Address	Enter the IP address assigned to the DNS host name. The DNS Host Name Mapping is used to assign a specific IP address to a domain name. We can use this domain name instead of IP address to access that particular host.

Field	Description
LAN Proxy	
Activate DNS Proxy	Enable or disable DNS proxy on this LAN. When this feature is enabled, the controller will act as a proxy for all DNS requests and communicate with the ISP's DNS servers (as configured in the Option settings page). All DHCP clients will receive the Primary/Secondary DNS IP along with the IP where the DNS Proxy is running, i.e. the box's LAN IP. All DHCP clients will receive the DNS IP addresses of the ISP excluding the DNS Proxy IP address when it is disabled. The feature is particularly useful in Auto Rollover mode. For example, if the DNS servers for each connection are different, a link failure may render the DNS servers inaccessible. However, when the DNS proxy is enabled, then the clients can make requests to the controller and in turn, sends those requests to the DNS servers of the active connection.
DHCP Address Pool	
Pool ID	Displays a unique numeric value.
Start IP	Displays Start IP address of the LAN DHCP Pool.
End IP	Displays End IP address of the LAN DHCP Pool.

DHCP Address Pool

Path: Network > LAN > LAN Settings

Upon enabling DHCP, you can define a set of IP ranges (referred to as “pools”). Each LAN on the controller can be sub-divided into 8 pools. The subnet and network of each pool must be within that of the LAN, configured on the LAN Settings page. Most importantly, pool IP address must not overlap on another.

New LAN DHCP clients will be assigned IP addresses starting with the “Start” IP address in the first pool in the list of pools. Clients will continue to receive sequential IP addresses until the “End” IP address of the first pool. Then, if further pools are configured, the next LAN client to join the domain of this controller will receive the “Start” IP address of the second configured pool, and so on.

1. Go to **Network > LAN > LAN Settings** page.
2. Click **Add New Pool**.

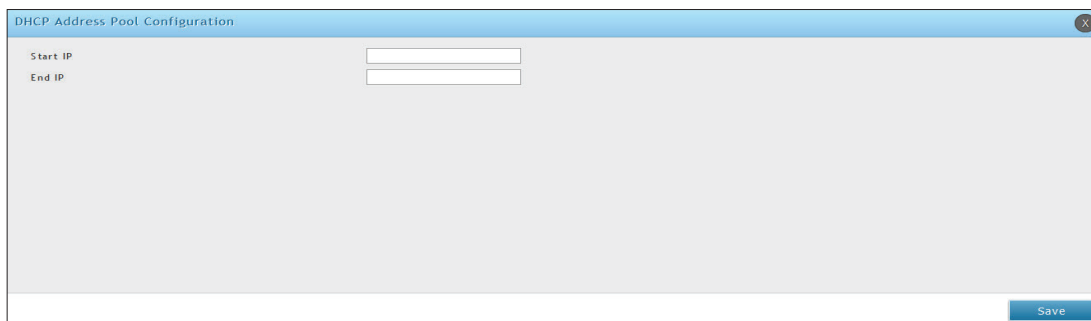

The image shows a screenshot of a web-based configuration window titled "DHCP Address Pool Configuration". The window has a light blue header bar with the title and a close button (X) in the top right corner. The main content area is light gray and contains two input fields. The first field is labeled "Start IP" and the second is labeled "End IP". Both fields are currently empty. At the bottom right of the window, there is a blue button labeled "Save".

3. Fill-in the following details:

- **Start IP:** Displays Start IP address of the LAN DHCP Pool.
- **End IP:** Displays End IP address of the LAN DHCP Pool.

IPv6 LAN Settings

Path: Network > IPv6 > LAN Settings > IPv6 LAN Settings

In IPv6 mode, the LAN DHCP server is disabled by default (similar to IPv4 mode). The DHCPv6 server will serve IPv6 addresses from configured address pools with the IPv6 Prefix Length assigned to the LAN.

The default IPv6 LAN address for the controller is fec0::1. You can change this 128 bit IPv6 address based on your network requirements. The other field that defines the LAN settings for the controller is the prefix length. The IPv6 network (subnet) is identified by the initial bits of the address called the prefix. By default, this is 64 bits long. All hosts in the network have common initial bits for their IPv6 address; the number of common initial bits in the network's addresses is set by the prefix length field.

1. Go to **Network > IPv6 > LAN Settings > IPv6 LAN Settings** tab.

The screenshot shows the D-Link Unified Controller web interface. The top navigation bar includes 'Status', 'Wireless', 'Network', 'Security', and 'Maintenance'. The breadcrumb trail is 'Network > IPv6 > LAN Settings > IPv6 LAN Settings'. The main content area is titled 'IPv6 LAN Settings' and contains a form with the following fields:

- LAN TCP/IP Setup**
 - IPv6 Address:
 - IPv6 Prefix Length: [Range: 0 - 128]
- DHCPv6 Status**
 - Status: OFF

Buttons for 'Save' and 'Cancel' are located at the bottom of the form.

2. Complete the fields in the table below and on the next page.
3. Click **Save**.

Field	Description
LAN TCP/IP Setup	
IPv6 Address	The Wireless Controller's LAN IPv6 address.
IPv6 Prefix Length	The IPv6 network (subnet) is identified by the initial bits of the address called the prefix. All hosts in the network have the identical initial bits for their IPv6 address; the number of common initial bits in the networks addresses are set by the prefix length field.

Field	Description
DHCPv6	
Status	Toggle On to enable DHCPv6. It is disabled in default.
If DHCPv6 is Enabled (ON)	
Mode	<p>There are two ways to obtain an appropriate address for the gateway. You must select one of the following:</p> <ul style="list-style-type: none"> • Stateless Address Auto Configuration: This option will use router advertisement for address assignment. The IPv6 RADVD protocol will be enabled to advertise this controller as a DHCPv6 client. • Stateful Address Auto Configuration: Select this option to request an IPv6 address from any available DHCPv6 servers available on the ISP.
Domain Name	Name of the domain (Optional) for this DHCPv6 server.
Server Preference	This is used by the stateless DHCP to indicate the preference level of this DHCP server. DHCPv6 clients will pick up the DHCPv6 server which has highest preference value. The preference value must be a decimal integer and be between 0 and 255 (inclusive).
DNS Servers	<p>Select one of the following options for DNS servers for the DHCPv6 clients</p> <ul style="list-style-type: none"> • Use DNS Proxy: On button to enable DNS proxy on this LAN, or Off this button to disable this proxy. When this feature is enabled, the controller will act as a proxy for all DNS requests and communicate with the ISP's DNS servers (as configured in the Option settings page) • Use DNS from ISP: This option allows the ISP to define the DNS servers (primary/secondary) for the LAN DHCP client • Use below: if selected, the below configured Primary and Secondary DNS servers are used for DHCPv6 clients.
Primary DNS Server	Enter the primary DNS server address.
Secondary DNS Server	Enter the secondary DNS server address.
Lease/Rebind Time	Duration (in seconds) for which IP addresses will be leased to clients.
Prefix Delegation	On/Off button for Enable/Disable Prefix Delegation.

IPv6 Address Pools

Path: Network > IPv6 > LAN Settings > IPv6 Address Pools

This feature allows you to define the IPv6 delegation prefix for a range of IP addresses to be served by the gateway's DHCPv6 server. Using a delegation prefix, you can automate the process of informing other networking equipment on the LAN of DHCP information specific for the assigned prefix.

1. Go to **Network > IPv6 > LAN Settings > IPv6 Address Pools** tab.

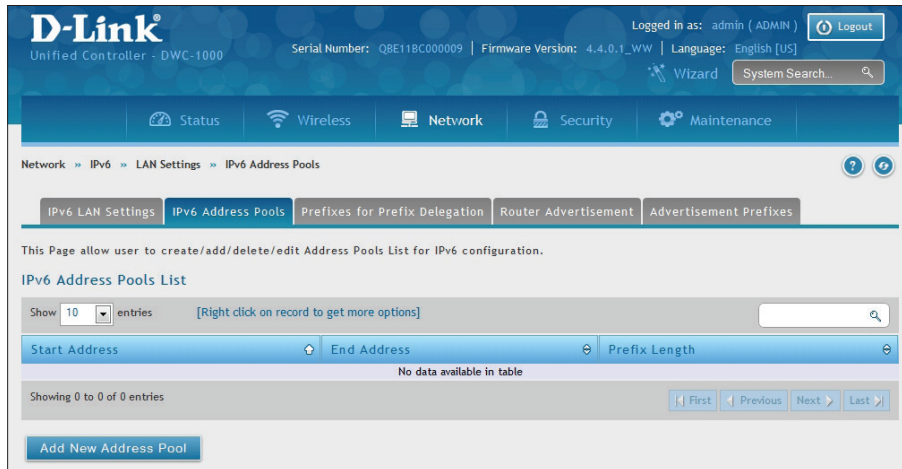

2. Click **Add New Address Pool**.

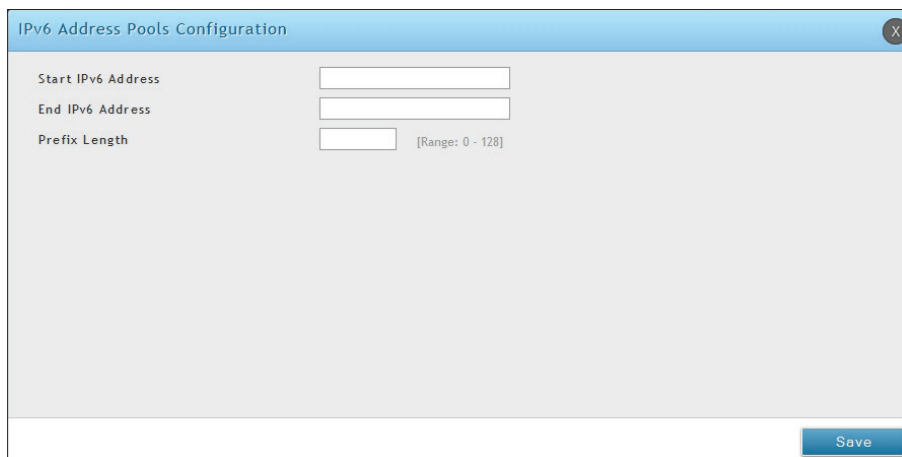
The screenshot shows the 'IPv6 Address Pools Configuration' dialog box. It has a title bar with a close button (X). The dialog contains three input fields: 'Start IPv6 Address', 'End IPv6 Address', and 'Prefix Length'. The 'Prefix Length' field has a range indicator '[Range: 0 - 128]'. At the bottom right of the dialog is a 'Save' button.

3. Enter a starting IPv6 address, end IPv6 address, and the prefix length.
4. Click **Save**.

5. Go to **Network > IPv6 > LAN Settings > Prefixes for Prefix Delegation** tab.

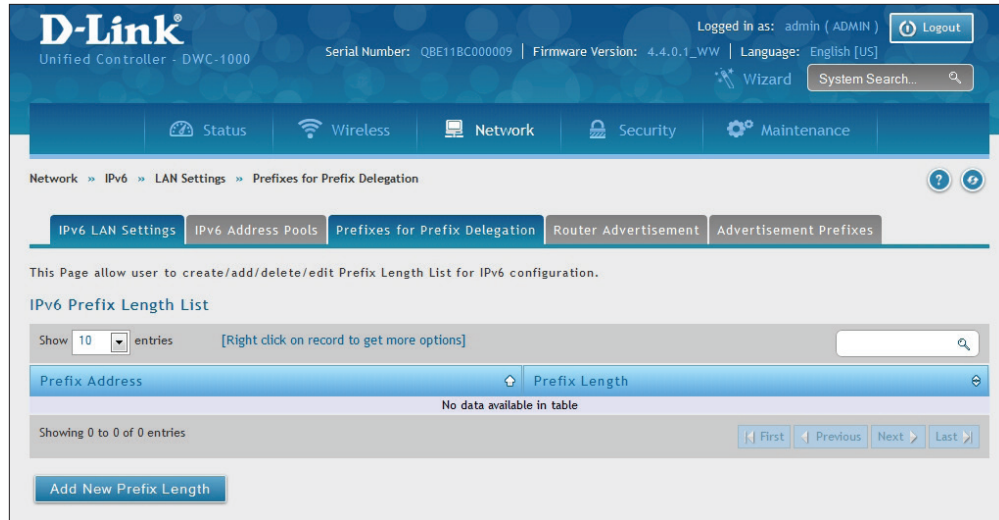

6. Click **Add New Prefix Length**.

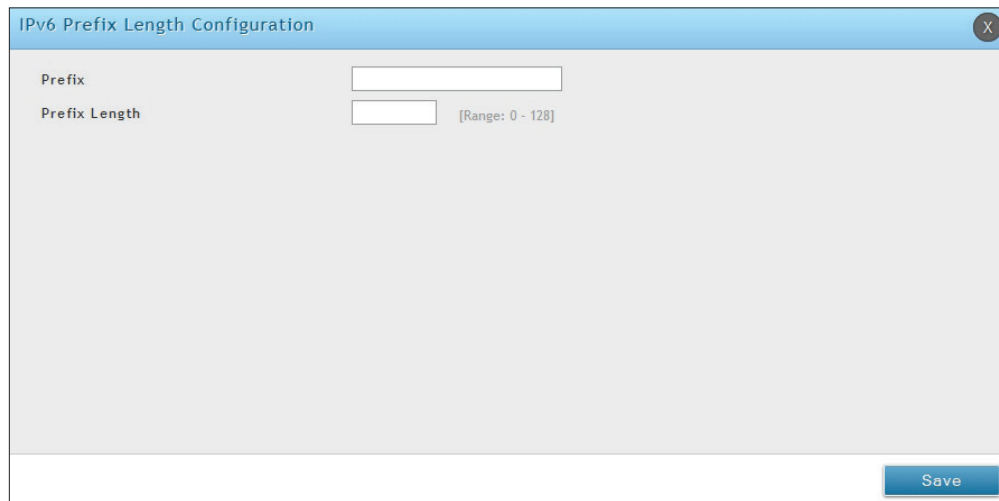

7. Enter the IPv6 Prefix and Prefix Length. Click **Save**.

IPv6 Router Advertisement

Path: Network > IPv6 > LAN Settings > Router Advertisement

Router Advertisements are analogous to IPv4 DHCP assignments for LAN clients. So, the controller will assign an IP address and supporting network information to devices that are configured to accept such details. Router Advertisement is required in an IPv6 network is required for stateless auto configuration of the IPv6 LAN. By configuring the Router Advertisement Daemon on this controller, the DWC will listen on the LAN for controller solicitations and respond to these LAN hosts with router advisements.

1. Go to **Network > IPv6 > LAN Settings > Router Advertisement** tab.

The screenshot displays the D-Link Unified Controller web interface. At the top, it shows the user is logged in as 'admin (ADMIN)' and provides system information like 'Serial Number: QBE11BC000009' and 'Firmware Version: 4.4.0.1_WW'. The navigation menu includes 'Status', 'Wireless', 'Network', 'Security', and 'Maintenance'. The current path is 'Network > IPv6 > LAN Settings > Router Advertisement'. Below the navigation, there are tabs for 'IPv6 LAN Settings', 'IPv6 Address Pools', 'Prefixes for Prefix Delegation', 'Router Advertisement', and 'Advertisement Prefixes'. The 'Router Advertisement' tab is active. A descriptive paragraph explains that this page allows configuring the Router Advertisement Daemon (RADVD) related configurations. The configuration section, titled 'Router Advertisement Daemon Setup', includes the following fields:

- Status:** A toggle switch set to 'ON'.
- Advertise Mode:** Radio buttons for 'Unsolicited Multicast' (selected) and 'Unicast Only'.
- Advertise Interval:** A text input field with the value '30' and a range of '10 - 1800'.
- RA Flags:**
 - Managed:** A toggle switch set to 'OFF'.
 - Other:** A toggle switch set to 'ON'.
- Router Preference:** Radio buttons for 'Low', 'Medium', and 'High' (selected).
- MTU:** A text input field with the value '1500' and a range of '1280 - 1500'.
- Router Lifetime:** A text input field with the value '3600' and the unit 'Seconds'.

At the bottom of the configuration section are 'Save' and 'Cancel' buttons.

2. Complete the fields from the table on the next page.
3. Click **Save**.

Field	Description
Status	Enable or disable the RADVD process here to allow stateless auto configuration of the IPv6 LAN network.
Advertise Mode	Two Advertise Modes: <ul style="list-style-type: none">• Unsolicited Multicast: Select to send router advertisements (RA's) to all the interfaces belonging to the multicast group.• Unicast Only: This option restricts advertisements to well known IPv6 addresses only (RA's are sent to the interface belonging to the known address only).
Advertise Interval	If Advertise Mode = Unsolicited Multicast, this sets the maximum advertise interval. The advertise interval used when RADVD is enabled is a random value between Minimum Router Advertisement Interval and Maximum Router Advertisement Interval. The minimum router advertisement interval is 1/3 of this configured value, and the default is 30 seconds.
RA Flags	The router advertisements (RA's) can be sent with one or both of these flags: Managed and Other . Choose Managed to use the administered /stateful protocol for address auto configuration. If the Other flag is selected, the host uses administered/stateful protocol for non-address auto configuration.
Router Preference	Choose between Low/Medium/High for the preference associated with the RADVD process of the controller. This feature is useful if there are other RADVD enabled devices on the LAN. The default is high.
MTU	This is used in RA's to ensure all nodes on the network use the same MTU value in the cases where the LAN MTU is not well known. The default is 1500
Router Lifetime	The lifetime in seconds of the route. The default is 3600 seconds.

IPv6 Advertisement Prefixes

Path: Network > IPv6 > LAN Setting > Advertisement Prefixes

The router advertisements configured with advertisement prefixes allow this controller to inform hosts how to perform stateless address auto configuration. Router advertisements contain a list of subnet prefixes that allow the controller to determine neighbors and whether the host is on the same link as the controller.

1. Go to **Network > IPv6 > LAN Settings > Advertisement Prefixes** tab.

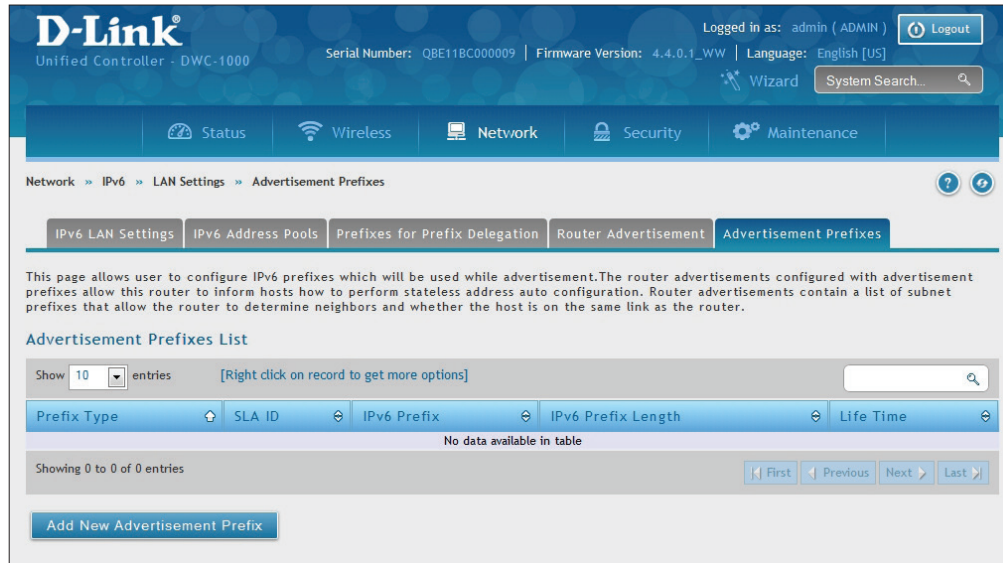

2. Click **Add New Advertisement Prefixes**.

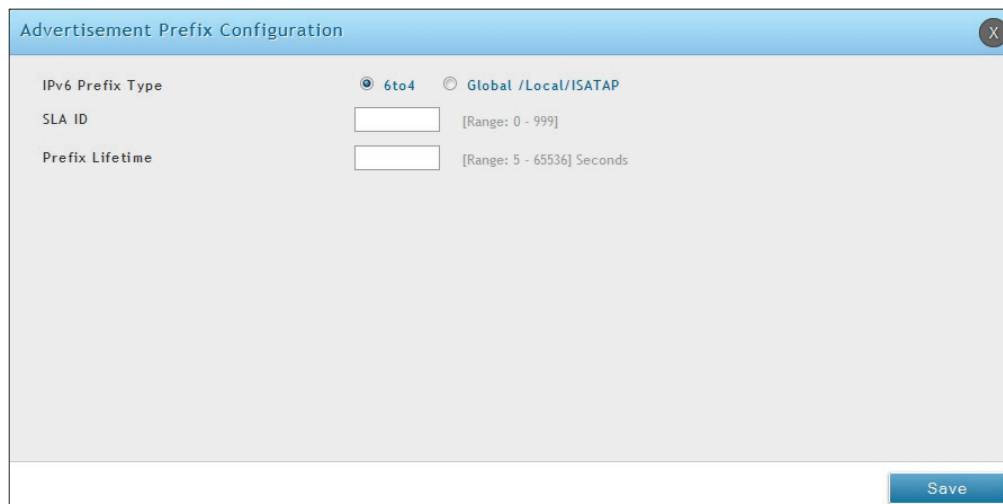

3. Complete the fields from the table below.
4. Click **Save**.

Field	Description
IPv6 Prefix Type	Select the prefix type as 6to4 or Global/Local/ISATAP.
SLA ID	If IPv6 Prefix Type= 6to4, the SLA ID (Site-Level Aggregation Identifier) in the 6to4 address prefix is set to the interface ID of the interface on which the advertisements are sent.
IPv6 Prefix	If IPv6 Prefix Type= Global / Local / SATAP, defines the IPv6 network address.
IPv6 Prefix Length	If IPv6 Prefix Type= Global/ Local/ SATAP, and this is a numeric value that indicates the number of contiguous, higher order bits of the address that make up the network portion of the address.
Prefix Lifetime	The length of time over which the requesting controller is allowed to use the prefix.

LAN DHCP Reserved IPs

Path: Network > LAN > LAN DHCP Reserved IPs

The controller's DHCP server can assign TCP/IP configurations to computers in the LAN explicitly by adding client's network interface hardware address and the IP address to be assigned to that client in DHCP server's database. Whenever DHCP server receives a request from the client, hardware address of that client is compared with the hardware address list present in the database, if an IP address is already assigned to that computer or device in the database, the customized IP address is configured, otherwise an IP address is assigned to the client automatically from the DHCP pool.

1. Click **Network > LAN > LAN DHCP Reserved IPs**.

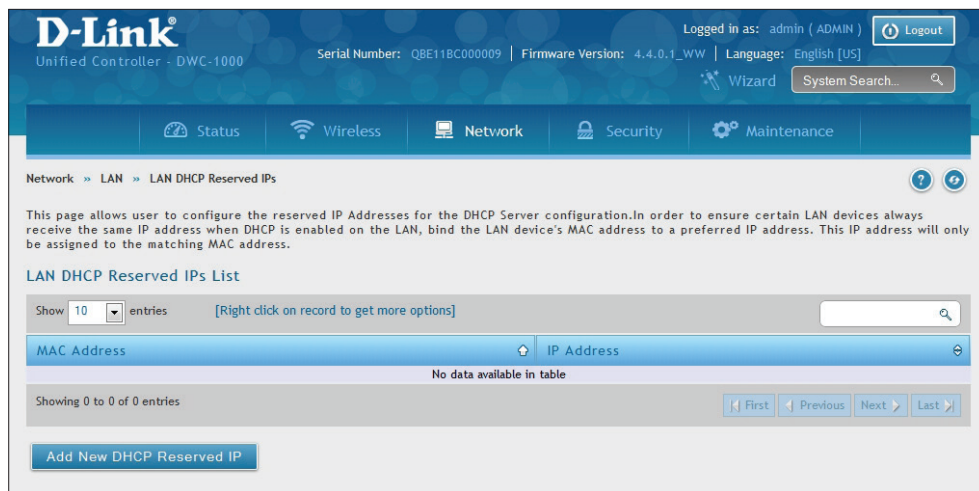

2. Click **Add New DHCP Reserved IP**.

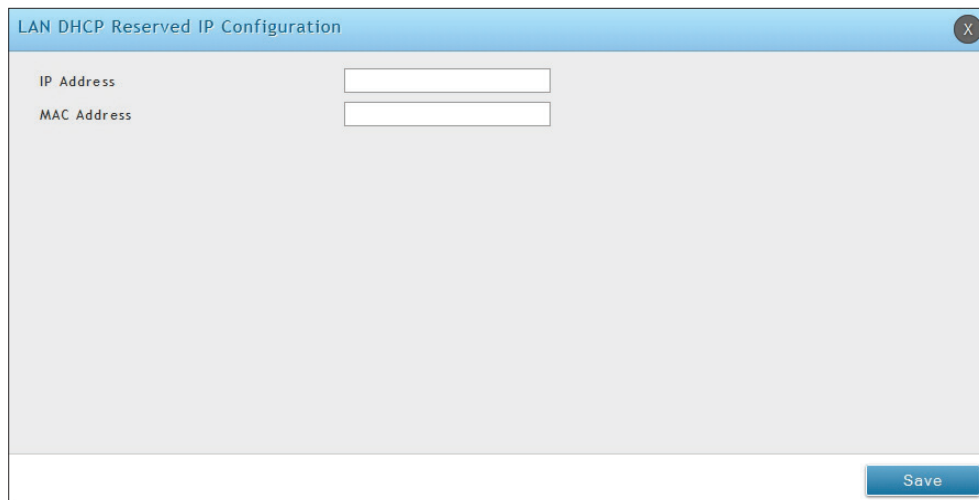

3. Enter the IP address you want to reserve and the MAC Address of the client you want to assign the IP address to.
4. Click **Save**

IP/MAC Binding

Path: Network > LAN > IP/MAC Binding

Another available security measure is to only allow outbound traffic (from the LAN to option) when the LAN node has an IP address matching the MAC address bound to it. This is IP/MAC Binding, and by enforcing the gateway to validate the source traffic's IP address with the unique MAC Address of the configured LAN node, you can ensure that the traffic from that the IP address is not spoofed. In the event of a violation (i.e., the traffic's source IP address doesn't match up with the expected MAC address having the same IP address) the packets will be dropped and can be logged for diagnosis.

1. Click **Network > LAN > IP/MAC Binding**.

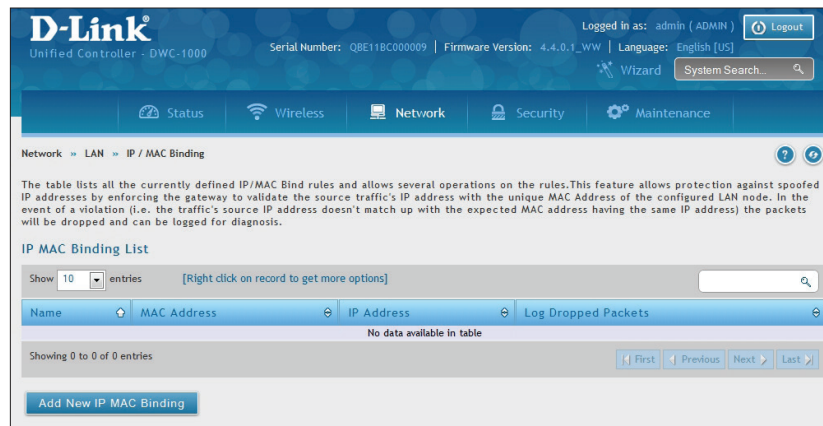

2. Click **Add New IP/MAC Binding** to create a new entry.

3. Enter a name, MAC address, IP address and select whether to turn dropped packet logging on or off. Click **Save**.

IGMP Setup

Note: This feature is only available when the DCS-1000-VPN license is activated.

Path: Network > LAN > IGMP Setup

IGMP snooping (IGMP Proxy) allows the controller to 'listen' in on IGMP network traffic. This, then allows the controller to filter multicast traffic and direct it only to hosts that need this stream. This is helpful when there is a lot of multicast traffic on the network where all LAN hosts do not need to receive this multicast traffic.

To enable IGMP Proxy:

1. Click **Network > LAN > IGMP Setup**.
2. Toggle *IGMP Proxy* to **On**.
3. Click **Save**.

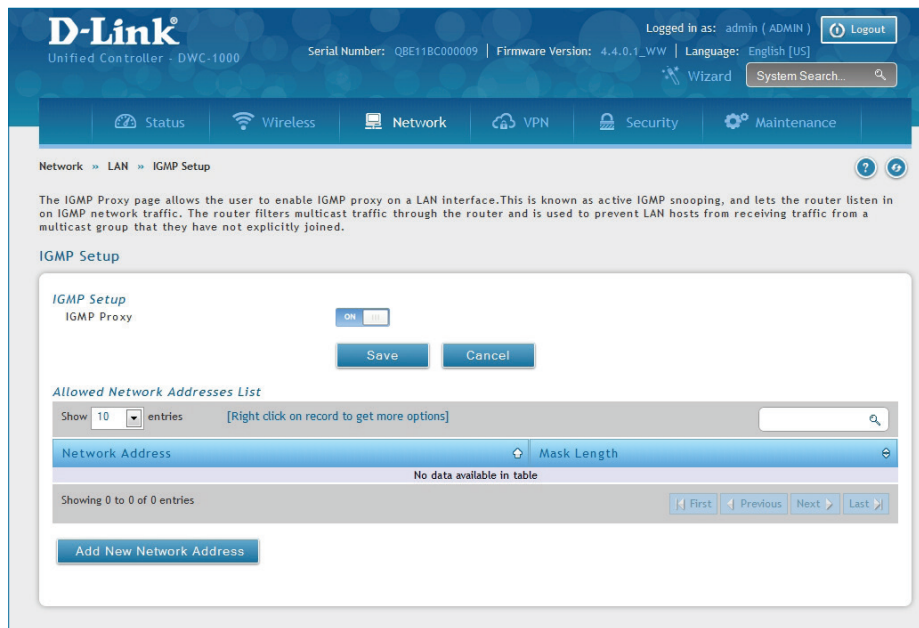

4. Click **Add new Network Address**. Enter a network address and mask length.
5. Click **Save**.

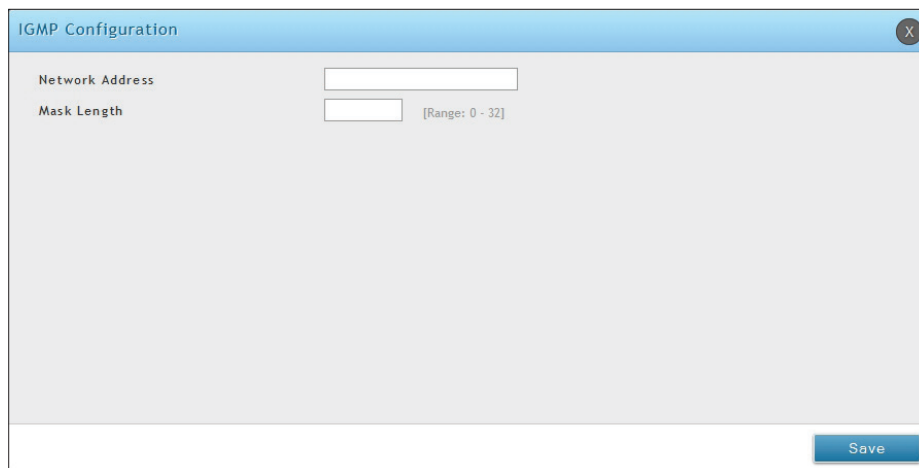

UPnP Setup

Note: This feature is available only when the DCS-1000-VPN license is activated.

Path: Network > LAN > UPnP

Universal Plug and Play (UPnP) is a feature that allows the controller to discover devices on the network that can communicate with the controller and allow for auto-configuration. If a network device is detected by UPnP, the controller can open internal or external ports for the traffic protocol required by that network device. If disabled, the controller will not allow for automatic device configuration and you may have to manually open/forward ports to allow applications to work.

To configure the UPnP settings:

1. Click **Network > LAN > UPnP**.
2. Toggle *Activate UPnP* to **On**.
3. Select a LAN from the *LAN Segment* drop-down menu.
4. Enter a value for *Advertisement Period*. This is the frequency that the controller broadcasts UPnP information over the network. A large value will minimize the network traffic but cause delays in identifying new UPnP devices to the network.
5. Enter a value for *Advertisement Time to Live*. This is the number of steps a packet is allowed to propagate before being discarded. Small values will limit the UPnP broadcast range. A default of 4 is typical for networks with a few number of switches.
6. Click **Save**.
7. Your entry will be displayed in the UPnP Port Map List. To edit or delete, right-click an entry and select the action from the menu. Repeat steps 3-6 to add multiple entries.

D-Link
Unified Controller - DWC-1000

Logged in as: admin (ADMIN) Logout
Serial Number: QBE11BC000009 | Firmware Version: 4.4.0.1_WW | Language: English [US]
Wizard System Search...

Status Wireless Network VPN Security Maintenance

Network > LAN > UPnP

UPnP (Universal Plug and Play) is a feature that allows for automatic discovery of devices that can communicate with this security appliance. UPnP is useful for auto-configuring application rules, where internal/external ports for the traffic protocol required by a detected network device are opened without user intervention. The UPnP Port Map Table has the details of UPnP devices that respond to the router's advertisements, and thereby don't require corresponding application (port forwarding) rules to be configured.

UPnP

UPnP Setup

Activate UPnP ON

LAN Segment LAN VLAN IDs List

Advertisement Period [Range: 1 - 86400] Seconds

Advertisement Time To Live [Range: 1 - 255] Hops

Save Cancel

UPnP Port Map List

Show 10 entries [No right click options]

Active	IP Address	Protocol	Internal Port	External Port
No data available in table				

Showing 0 to 0 of 0 entries

First Previous Next Last

The *UPnP Port map List* has the details of UPnP devices that respond to the router's advertisements. The following information is displayed for each detected device:

- **Active:** A yes/no indicating whether the port of the UPnP device that established a connection is currently active.
- **IP Address:** The IP address of the UPnP device detected by this controller.
- **Protocol:** The network protocol (i.e. HTTP, FTP, etc.) used by the DWC.
- **Int. Port (Internal Port):** The internal ports opened by UPnP (if any).
- **Ext. Port (External Port):** The external ports opened by UPnP (if any).
- **Click Refresh** to refresh the port map table and search for any new UPnP devices.

Configure Jumbo Frames

Path: Network > LAN > Jumbo Frame

Jumbo frames are Ethernet frames with more than 1500 bytes of payload. When this option is enabled, the LAN devices can exchange information at Jumbo frames rate.

1. Click **Network > LAN > Jumbo Frame**.

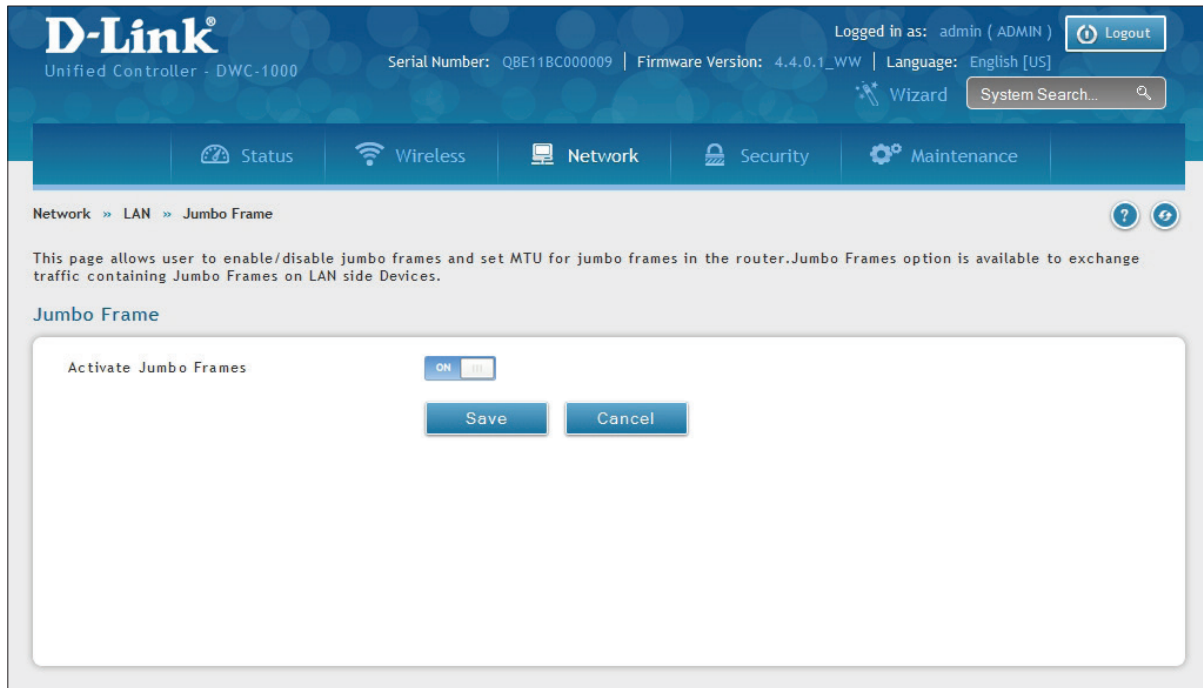

2. Toggle Activate Jumbo Frames to **On**.
3. Click **Save**.

Internet (IPv4) Option 1 Settings

Path: Network > Internet (IPv4)> Option 1 Settings

The wireless controller has two Option ports that can be used to establish a connection to the Internet or another network subnet. By default, Option1 is enabled and works as a LAN interface but with a dependent MAC address, and Option 2 is disabled. With a VPN license (DWC-1000-VPN/ DWC-1000-VPN-LIC), the controller turn into Option ports. You can set ISP connection type and NAT/Transparent mode features.

1. Click **Network > Internet (IPv4) > Option 1 Settings**.

The screenshot displays the 'Option 1 Settings' page for IPv4. The navigation bar at the top includes 'Status', 'Wireless', 'Network', 'VPN', 'Security', and 'Maintenance'. The breadcrumb path is 'Network >> Internet (IPv4) >> Option 1 Settings'. A help icon and a refresh icon are visible in the top right corner. Below the breadcrumb, a note states: 'This page allows you to set up your Internet connection. Ensure that you have the Internet connection information such as the IP Addresses, Account Information etc. This information is usually provided by your ISP or network administrator.'

The main content area is titled 'IPv4 Option 1 Settings' and contains the following sections:

- Option 1 Setup**: 'Connection Type' is set to 'Static IP' (dropdown menu).
- Static IP**: 'IP Address' is '0.0.0.0', 'IP Subnet Mask' is '0.0.0.0', and 'Gateway IP Address' is '0.0.0.0'.
- Domain Name System (DNS) Servers**: 'Primary DNS Server' is '0.0.0.0' and 'Secondary DNS Server' is '0.0.0.0'.
- MAC Address**: 'MAC Address Source' has three radio buttons: 'Use Default MAC' (selected), 'Clone your PC's MAC', and 'Use this MAC'.
- Port Setup**: 'MTU Size' has two radio buttons: 'Default' (selected) and 'Custom'. 'Port Speed' is set to 'Auto Sense' (dropdown menu).

At the bottom of the form are 'Save' and 'Cancel' buttons.

2. Select your connection type and complete the fields from the next page.
3. Click **Save**.

Field	Description
Connection Type	Select the type of your Internet connection (Static, Dynamic, PPPoE, PPTP, L2TP, Japanese PPPoE, Russian PPPoE, Russian PPTP, or Russian L2TP).
Dynamic	
Host Name (optional)	Specify the host-name option to send to the DHCP server. The host-name string only contains the client's host name prefix, to which the server will append the DDNS domain name or domain-name options, if any, to derive the fully qualified domain name of the client
Static	
IP Address	Enter the static address that your ISP assigned to you. This address will identify the controller to your ISP.
IP Subnet Mask	Enter the subnet mask.
Gateway IP Address	Enter the default gateway IP address.
PPPoE/Japanese PPPoE/Russian PPPoE	
Address Mode	Select either Dynamic IP or Static IP .
IP Address/Subnet Mask	If you selected Static, enter the IP address and subnet mask supplied to you by your ISP.
User Name	Enter your PPPoE user name.
Password	Enter your PPPoE password.
Service	Use this field if you need to distinguish two servers using the same Username and Password combination. With PPP, as you can't specify servers using IP address, you can specify the particular server to connect to using this field.
Authentication Type	Select the type of Authentication to use (Auto-Negotiate, PAP, CHAP, MS-CHAP, or MS-CHAPv2).
Reconnect Mode	Select one of the following options: <ul style="list-style-type: none"> • Always On: The connection is always on. • On Demand: The connection is automatically ended if it is idle for a specified number of minutes. Enter the number of minutes in the Maximum Idle Time field. This feature is useful if your ISP charges you based on the amount of time that you are connected.
PPTP/Russian PPTP	
Address Mode	Select either Dynamic IP or Static IP .
Server Address	Enter the IP address or the domain name of the PPTP server.
User Name	Enter your PPTP user name.
Password	Enter your PPTP password.
MPPE Encryption	Toggle ON if your ISP supports MPPE Encryption.
Split Tunnel	Enabling split tunnel will prevent you from adding a Gateway IP address and instead you need to add specific routes to route LAN traffic.
Reconnect Mode	Select one of the following options: <ul style="list-style-type: none"> • Always On: The connection is always on. • On Demand: The connection is automatically ended if it is idle for a specified number of minutes. Enter the number of minutes in the Maximum Idle Time field. This feature is useful if your ISP charges you based on the amount of time that you are connected.
L2TP/Russian L2TP	
Address Mode	Select either Dynamic IP or Static IP .
Server Address	Enter the IP address or the domain name of the L2TP server.
User Name	Enter your PPTP user name.
Password	Enter your PPTP password.
Secret	Enter the secret phrase to log into the server.
Split Tunnel	Enabling split tunnel will prevent you from adding a Gateway IP address and instead you need to add specific routes to route LAN traffic.

Reconnect Mode	Select one of the following options: <ul style="list-style-type: none"> • Always On: The connection is always on. • On Demand: The connection is automatically ended if it is idle for a specified number of minutes. Enter the number of minutes in the Maximum Idle Time field. This feature is useful if your ISP charges you based on the amount of time that you are connected.
Field	Description
DNS Servers	
DNS Server Source	Select one of the following options: <ul style="list-style-type: none"> • Get Dynamically from ISP: Select this option if your ISP did not assign a static DNS IP address. • Use These DNS Servers: Select this option if your ISP assigned a static DNS IP address for you to use. Also complete the fields below.
Primary DNS Server	Enter the primary DNS server.
Secondary DNS Server	Enter the secondary DNS server.
MAC Address	
MAC Address Source	Select Use Default MAC unless your ISP requires MAC authentication and another MAC address has been previously registered with your ISP. In that case, choose one of the following options: <ul style="list-style-type: none"> • Clone your PC's MAC Address: Select this option to assign the MAC address of the computer that you are using to configure the controller. • Use this MAC Address: Select this option if your ISP assigned a MAC address for you to use. Also complete the fields below.
MAC Address	Enter a MAC address in the following format: XX:XX:XX:XX:XX:XX where X is a number from 0 to 9 (inclusive) or an alphabetical letter between A and F (inclusive).
Port Setup	
MTU Size	The MTU (Maximum Transmit Unit) is the size of the largest packet that can be sent over the network. The standard MTU value for Ethernet networks is usually 1500 Bytes and for PPPoE/PPTP connections, it is 1492 Bytes. For all I2tp connections, it is 1460 Bytes.
Custom MTU Size	Enter a specific MTU size.
Port Speed	The Ethernet port speed can be manually set or specified depending on your Option1/Option 2 requirements.

Option 2/DMZ Settings

Path: Network > Internet (IPv4) > Option 2 / DMZ Setting

The wireless controller allows an Option port to be configured as a secondary Ethernet port or dedicated Demilitarized Zone (DMZ) port. A DMZ allows one IP address (computer) to be exposed to the Internet for activities such as Internet gaming and video conferencing.

If you want to set up the Option 2 port to connect to the Internet, select **Option** as the *Configurable Port* and refer to the Option 1 Port Settings on the previous three pages.

Configuring DMZ settings is a 2-step process:

1. Configure the wireless controller port to act as a DMZ, and
2. Configure the DMZ settings for the port

To configure a port to operate as a DMZ:

1. Go to **Network > Internet (IPv4) > Option 2 / DMZ Setting**.

DMZ cannot be configured when option mode is not single option port (option1)

This page allows you to set up your Internet connection. Ensure that you have the Internet connection information such as the IP Addresses, Account Information etc. This information is usually provided by your ISP or network administrator.

IPv4 Option2 / DMZ Setting

Configurable Port Setup

Configurable Port Option DMZ

DMZ IP Address

IP Address

Subnet Mask

DHCP for DMZ

DHCP Mode None DHCP Server DHCP Relay

2. Next to *Configurable Port*, select **DMZ**.
3. Enter the IP address and the subnet mask of the computer/device you want to configure DMZ to.
4. Under *DHCP for DMZ*, select either **None**, **DHCP Server** (and enter the primary and secondary DNS Server addresses), or **DHCP Relay**.
5. Click **Save**.

IPv6 Option 1/2 Settings

Path: Network > IPv6 > Option 1 Settings or Option 2 Settings

For IPv6 Option (WAN) connections, this controller can have a static IPv6 address or receive connection information when configured as a DHCPv6 client. In the case where the ISP assigns you a fixed address to access the internet, the static configuration settings must be completed. In addition to the IPv6 address assigned to your controller, the IPv6 prefix length defined by the ISP is needed. The default IPv6 Gateway address is the server at the ISP that this controller will connect to for accessing the internet. The primary and secondary DNS servers on the ISP's IPv6 network are used for resolving internet addresses, and these are provided along with the static IP address and prefix length from the ISP.

When the ISP allows you to obtain the Option (WAN) IP settings via DHCP, you need to provide details for the DHCPv6 client configuration. The DHCPv6 client on the gateway can be either stateless or stateful. If a stateful client is selected, the gateway will connect to the ISP's DHCPv6 server for a leased address. For stateless DHCP there need not be a DHCPv6 server available at the ISP, rather ICMPv6 discover messages will originate from this gateway and will be used for auto configuration. A third option to specify the IP address and prefix length of a preferred DHCPv6 server is available as well.

1. Go to **Network > IPv6 > Option 1 Settings** or **Option 2 Settings**.

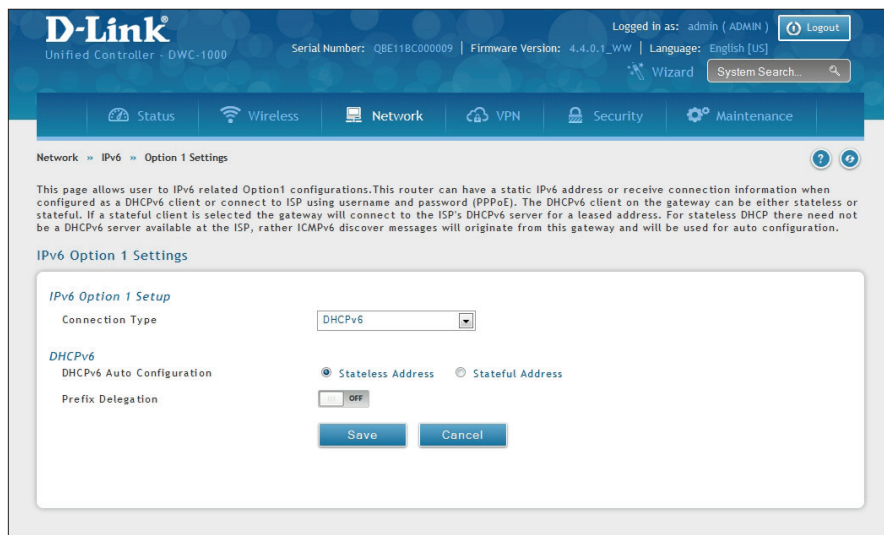

2. Select your connection type (DHCPv6, PPPoE, or Static) and complete the fields from the next page.
3. Click **Save**.

Field	Description
Connection Type	Select the type of your IPv6 Internet connection (DHCPv6, Static, or PPPoE).
DHCPv6	
DHCPv6 Auto Configuration	Select one of the following: <ul style="list-style-type: none"> • Stateless Address Auto Configuration: this option will use router advertisement for address assignment. The IPv6 RADVD protocol will be enabled to advertise this controller as a DHCPv6 client. • Stateful Address Auto Configuration: select this option to request an IPv6 address from any available DHCPv6 servers available on the ISP.
Prefix Delegation	Toggle to ON to request router advertisement prefix from any available DHCPv6 servers available from your ISP, the obtained prefix is updated to the advertised prefixes on the LAN side.
Static	
IPv6 Address	Enter the static IPv6 address that your ISP assigned to you. This address will identify the router to your ISP.
IPv6 Prefix Length	The IPv6 network (subnet) is identified by the initial bits of the address called the prefix. All hosts in the network have the identical initial bits for their IPv6 address; the number of common initial bits in the networks addresses is set by the prefix length field.
Default IPv6 Gateway	IPv6 address of the ISPs gateway. This is usually provided by the ISP or your network administrator.
DNS Server(s)	Enter the primary and secondary DNS server IP address(es).
PPPoE	
User Name	Enter your PPPoE user name.
Password	Enter your PPPoE password.
Service	Use this field if you need to distinguish two servers using the same Username and Password combination. With PPP, as you can't specify servers using IP address, you can specify the particular server to connect to using this field.
Authentication Type	Select the type of Authentication to use (Auto-Negotiate, PAP, CHAP, MS-CHAP, or MS-CHAPv2).
DHCPv6 Options	The mode of Dhcpv6 client that will start in this mode : disable dhcpv6/stateless dhcpv6/stateful dhcpv6/stateless dhcpv6 with prefix delegation.
DNS Server(s)	Enter the primary and secondary DNS server IP address(es).

Option Mode

Path: Network > Internet (IPv4) > Option Mode

This controller supports multiple Internet (Option) links. This allows you to take advantage of failover and load balancing features to ensure certain internet dependent services are prioritized in the event of unstable Option connectivity on one of the ports.

To use Auto Failover or Load Balancing, Option link failure detection must be configured. This involves accessing DNS servers on the internet or ping to an internet address (user defined). If required, you can configure the number of retry attempts when the link seems to be disconnected or the threshold of failures that determines if an Option port is down.

Single Option Port

If you do not want to use Auto Failover or Load Balancing, select **Single Option Port** from the *Option Mode* drop-down menu, and select the Option port you want to set. Click **Save**.

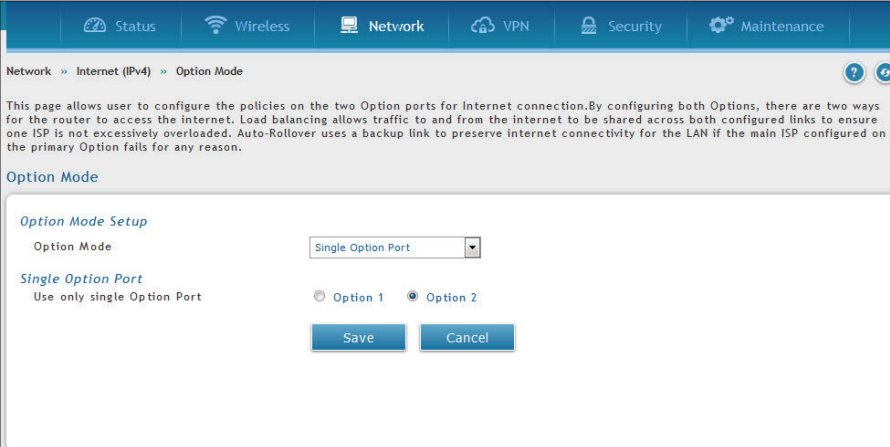

The screenshot shows the web interface for configuring the router's Option Mode. The navigation bar at the top includes Status, Wireless, Network, VPN, Security, and Maintenance. The breadcrumb trail is Network > Internet (IPv4) > Option Mode. A descriptive paragraph explains that this page allows configuring policies for two Option ports for Internet connection, mentioning load balancing and auto-rollover. The main configuration area is titled 'Option Mode' and contains two sections: 'Option Mode Setup' with a dropdown menu set to 'Single Option Port', and 'Single Option Port' with radio buttons for 'Option 1' and 'Option 2', where 'Option 2' is selected. 'Save' and 'Cancel' buttons are at the bottom.

Auto-Rollover using Option Port

In this mode one of your Option ports is assigned as the primary Internet link for all Internet traffic and the secondary Option port is used for redundancy in case the primary link goes down for any reason. Both Option ports (primary and secondary) must be configured to connect to the respective ISP's before enabling this feature. The secondary Option port will remain unconnected until a failure is detected on the primary link (either port can be assigned as the primary). In the event of a failure on the primary port, all Internet traffic will be rolled over to the backup port. When configured in Auto-Failover mode, the link status of the primary Option port is checked at regular intervals as defined by the failure detection settings.

1. Click **Network > Internet (IPv4) > Option Mode**.

The screenshot shows the 'Option Mode' configuration page. The 'Option Mode Setup' section has a dropdown menu for 'Option Mode' set to 'Auto-Rollover Using Option Port'. Below this, the 'Auto-Rollover using Option Port' section has radio buttons for 'Option 1' (selected) and 'Option 2'. The 'DNS Lookup Method' section has radio buttons for 'Option DNS Servers' (selected), 'DNS Servers', and 'Ping These IP Addresses'. The 'Retry Interval' is a text input field with '30' and a tooltip '[Default: 30, Range: 5 - 999] Seconds'. The 'Failover After' is a text input field with '4' and a tooltip '[Default: 4, Range: 2 - 999] Failures'. There are 'Save' and 'Cancel' buttons at the bottom.

2. Complete the fields from the table below, and click **Save**.

Field	Description
Option Mode	Select Auto-Rollover Using Option Port from the drop-down menu.
Use Primary Option Port	Select which Option port is the primary.
Use Secondary Option Port	Select which port to use if the primary port fails.
DNS Lookup Method	<ul style="list-style-type: none"> • Option DNS Servers: DNS Lookup of the DNS Servers of the primary link is used to detect primary Option connectivity. • DNS Servers: DNS Lookup of the custom DNS Servers can be specified to check the connectivity of the primary link. • Ping these IP addresses: These IP's will be pinged at regular intervals to check the connectivity of the primary link.
Option 1/Option 2	Enter the DNS server or IP address to ping.
Retry Interval	Enter the time in seconds to initiate the Option health check. Default is every 30 seconds. The number tells the controller how often it should run the above configured failure detection method.
Failover After	Enter the number of failures before the controller initiates the failover process.

Load Balancing

Path: Network > Internet (IPv4) > Option Mode

This feature allows you to use multiple Option links (and presumably multiple ISP's) simultaneously. After configuring more than one Option port, the load balancing option is available to carry traffic over more than one link. Protocol bindings are used to segregate and assign services over one Option port in order to manage internet flow. The configured failure detection method is used at regular intervals on all configured Option ports when in Load Balancing mode.

This controller currently supports three algorithms for Load Balancing:

Round Robin: This algorithm is particularly useful when the connection speed of one Option port greatly differs from another. In this case you can define protocol bindings to route low-latency services (such as VOIP) over the higher-speed link and let low-volume background traffic (such as SMTP) go over the lower speed link. Protocol binding is explained in next section.

Spillover: If Spillover method is selected, the primary Option acts as a dedicated link until a defined bandwidth threshold are reached. After this, the secondary Option will be used for new connections. Inbound connections on the secondary Option are permitted with this mode, as the spillover logic governs outbound connections moving from the primary to secondary Option. You can configure spillover mode by using following options:

- **Load Tolerance:** It is the percentage of bandwidth after which the controller switches to secondary Option.
- **Max Bandwidth:** This sets the maximum bandwidth tolerable by the primary Option for outbound traffic.

If the link bandwidth of outbound traffic goes above the load tolerance value of max bandwidth, the controller will spillover the next connections to secondary Option.

For example, if the maximum bandwidth of primary Option is 1Kbps and the load tolerance is set to 70. Now every time a new connection is established the bandwidth increases. After a certain number of connections say bandwidth reached 70% of 1Kbps, the new outbound connections will be spilled over to secondary Option. The maximum value of load tolerance is 80% and the minimum is 20%.

Load balancing is particularly useful when the connection speed of one Option port greatly differs from another. In this case you can define protocol bindings to route low-latency services (such as VOIP) over the higher-speed link and let low-volume background traffic (such as SMTP) go over the lower speed link.

Round Robin

1. Click **Network > Internet (IPv4) > Option Mode**.

Network » Internet (IPv4) » Option Mode

This page allows user to configure the policies on the two Option ports for Internet connection. By configuring both Options, there are two ways for the router to access the internet. Load balancing allows traffic to and from the internet to be shared across both configured links to ensure one ISP is not excessively overloaded. Auto-Rollover uses a backup link to preserve internet connectivity for the LAN if the main ISP configured on the primary Option fails for any reason.

Option Mode

Option Mode Setup

Option Mode:

Load Balancing Setup

Load Balancing: Round Robin Spillover Mode

DNS Lookup Method: None Option DNS Servers DNS Servers Ping These IP Addresses

Spillover Configuration Setup

Load Tolerance: [Default: 80, Range: 20 - 80]

Max Bandwidth: [Default: 8192, Range: 512 - 8192]

2. Complete the fields from the table below and click **Save**.

Field	Description
Option Mode	Select Load Balancing from the drop-down menu.
Load Balancing	Select Round Robin .
DNS Lookup Method	<ul style="list-style-type: none"> • Option DNS Servers: DNS Lookup of the DNS Servers of the primary link is used to detect primary Option connectivity. • DNS Servers: DNS Lookup of the custom DNS Servers can be specified to check the connectivity of the primary link. • Ping these IP addresses: These IP's will be pinged at regular intervals to check the connectivity of the primary link. • Retry Interval is: The number tells the controller how often it should run the above configured failure detection method. • Failover after: This sets the number of retries after which failover is initiated.
Save	Click save to activate your settings.

Spillover

1. Click **Network > Internet (IPv4) > Option Mode**.

Network » Internet (IPv4) » Option Mode

This page allows user to configure the policies on the two Option ports for Internet connection. By configuring both Options, there are two ways for the router to access the internet. Load balancing allows traffic to and from the internet to be shared across both configured links to ensure one ISP is not excessively overloaded. Auto-Rollover uses a backup link to preserve internet connectivity for the LAN if the main ISP configured on the primary Option fails for any reason.

Option Mode

Option Mode Setup

Option Mode: Load Balancing

Load Balancing Setup

Load Balancing: Round Robin Spillover Mode

DNS Lookup Method: None Option DNS Servers DNS Servers Ping These IP Addresses

Spillover Configuration Setup

Load Tolerance: 80 [Default: 80, Range: 20 - 80]

Max Bandwidth: 8192 [Default: 8192, Range: 512 - 8192]

Save Cancel

2. Complete the fields from the table below and click **Save**.

Field	Description
Option Mode	Select Load Balancing from the drop-down menu.
Load Balance	Select Spillover Mode .
DNS Lookup Mode	<ul style="list-style-type: none"> • Option DNS Servers: DNS Lookup of the DNS Servers of the primary link is used to detect primary Option connectivity. • DNS Servers: DNS Lookup of the custom DNS Servers can be specified to check the connectivity of the primary link. • Ping these IP addresses: These IP's will be pinged at regular intervals to check the connectivity of the primary link.
Retry Interval is	Enter the time in seconds to initiate the DNS Lookup Mode. Default is every 30 seconds. The number tells the controller how often it should run the above configured failure detection method.
Failover After	Enter the number of failures before the controller initiates the failover process.
Load Tolerance	Enter the percentage of bandwidth after which the controller switches to the secondary Option.
Max Bandwidth	This sets the maximum bandwidth tolerable by the primary Option for outbound traffic.
Save	Click save to activate your settings.

Routing

Routing between the LAN and Option will impact the way this controller handles traffic received on any of its physical interfaces. The routing mode of the gateway is core to the behavior of the traffic flow between the secure LAN and the internet.

NAT or Classical

Path: Network > Internet (IPv4) > Routing

With classical routing, devices on the LAN can be directly accessed from the internet with their public IP addresses (assuming appropriate firewall settings are configured). If your ISP has assigned an IP address for each of the computers/devices that you use, select **Classical**.

NAT is a technique which allows several computers and devices on your local network to share an Internet connection. The computers on the LAN use a “private” IP address range while the Option port on the controller is configured with a single “public” IP address. Along with connection sharing, NAT also hides internal IP addresses from the computers on the Internet. NAT is required if your ISP has assigned only one IP address to you. The computers/devices that connect through the controller will need to be assigned IP addresses from a private subnet.

1. Click **Network > Internet (IPv4) > Routing**.

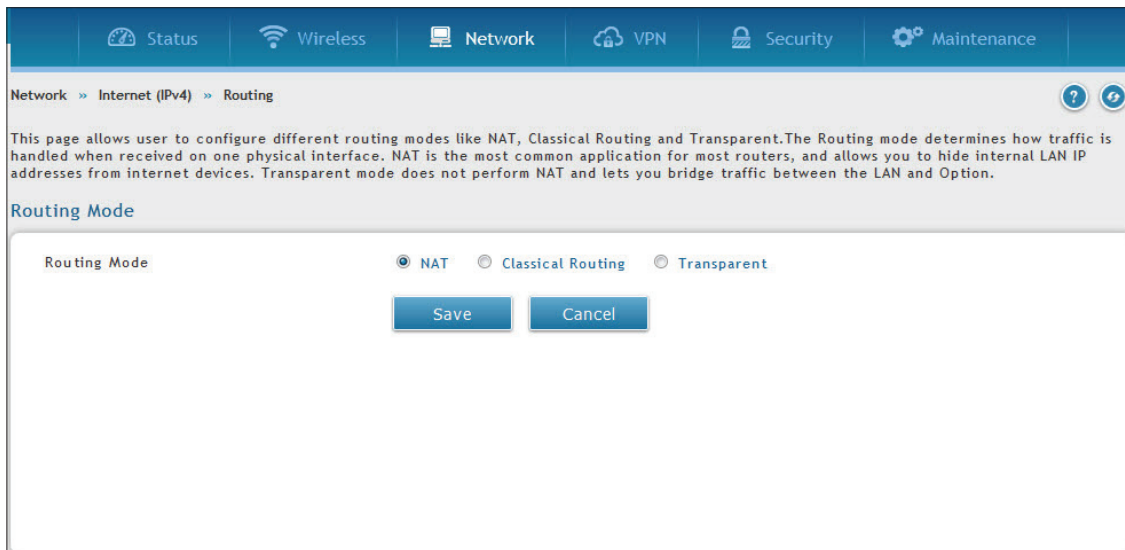

2. Complete the fields from the table below, and click **Save**.

Field	Description
Routing Mode	Select NAT or Classical .
Save	Click to save and activate your settings.

Transparent

When Transparent Routing Mode is enabled, NAT is not performed on traffic between the LAN and Option interfaces. Broadcast and multicast packets that arrive on the LAN interface are switched to the Option and vice versa, if they do not get filtered by firewall or VPN policies. To maintain the LAN and Option in the same broadcast domain select **Transparent** mode, which allows bridging of traffic from LAN to Option and vice versa, except for controller-terminated traffic and other management traffic.

Note: NAT routing has a feature called "NAT Hair-pinning" that allows internal network users on the LAN and DMZ to access internal servers (e.g., an internal FTP server) using their externally-known domain name. This is also referred to as "NAT loopback" since LAN generated traffic is redirected through the firewall to reach LAN servers by their external name.

1. Click **Network > Internet (IPv4) > Routing**.

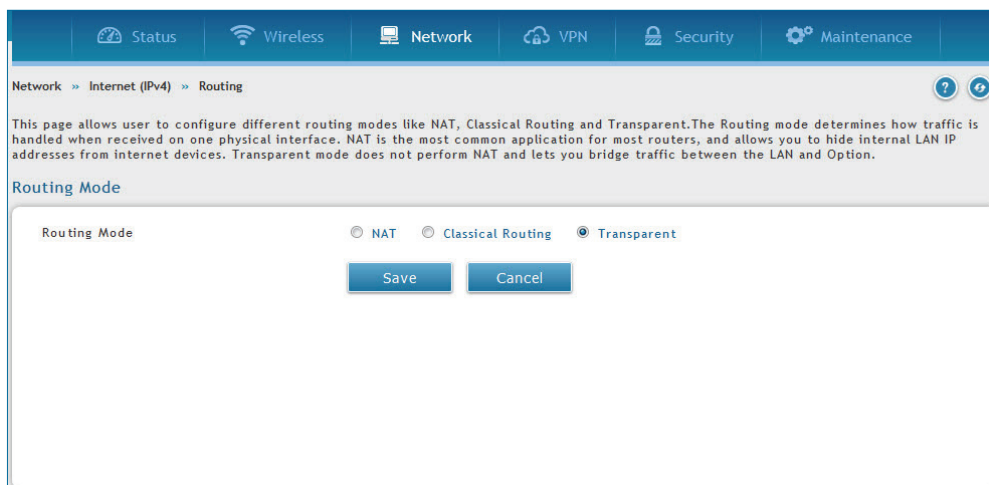

2. Complete the fields from the table below and click **Save**.

Field	Description
Routing Mode	Select Transparent .
Save	Click save to activate your settings.

IP Aliasing

Path: Network > Internet (IPv4) > IP Aliasing

A single Option Ethernet port can be accessed via multiple IP addresses by adding an alias to the port. This is done by configuring an IP Alias address. To edit or delete any existing aliases, right-click the alias and select either **Edit** or **Delete**.

To create a new alias:

1. Click **Network > Internet (IPv4) > IP Aliasing**.

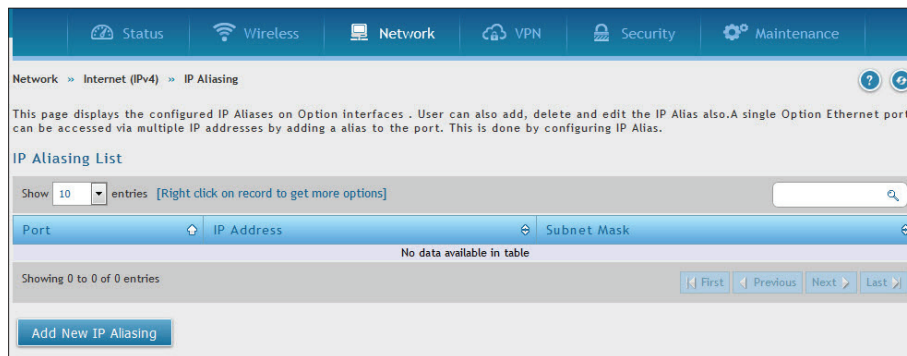

2. Click **Add New IP Aliasing**.
3. Enter the following information, and click **Save**.

Field	Description
Interface	Select either Option1 or Option2 .
IP Address	Enter an alias IP address for the Option interface you selected.
Subnet Mask	Enter a subnet mask for the Option interface you selected.
Save	Click save to activate your settings.

DMZ DHCP Reserved IPs

The controller's DHCP server can assign IP settings to your DMZ clients on your network by adding a client's MAC address and the IP address to be assigned. Whenever the controller receives a request from a client, the MAC address of that client is compared with the MAC address list present in the database. If an IP address is already assigned to that computer or device in the database, the customized IP address is configured, otherwise an IP address is assigned to the client automatically from the DMZ DHCP pool.

To create DHCP reservations:

1. Click **Network > Internet (IPv4) > DMZ DHCP Reserved IPs**.

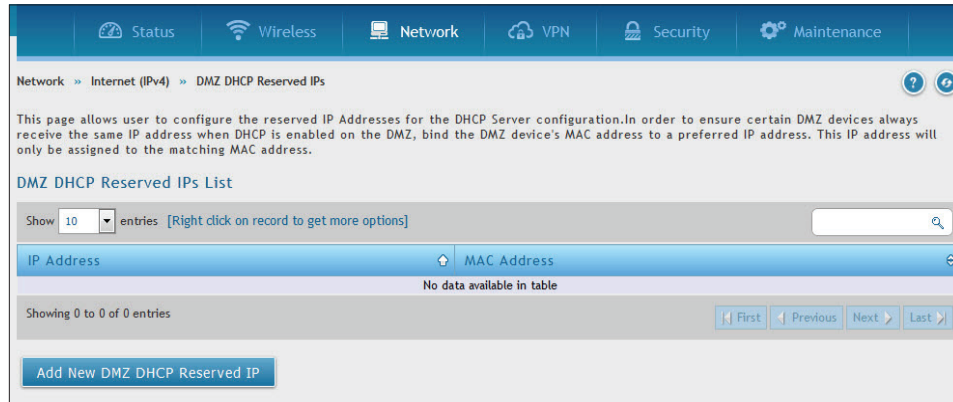

2. Click **Add New DMZ DHCP Reserved IP**.
3. Enter the following information, and click **Save**.

Field	Description
IP Address	Enter the IP address you want to assign to this device. Note that this IP address must be in the same range as the starting/ending IP address under DHCP Settings.
MAC Address	Enter the MAC address of this device (xx:xx:xx:xx:xx:xx format).
Save	Click Save to save your reservation.

Dynamic DNS

Path: Network > Internet (IPv4) > Dynamic DNS

Dynamic DNS (DDNS) is an Internet service that allows controllers with varying public IP addresses to be located using Internet domain names. To use DDNS, you must setup an account with a DDNS provider such as DynDNS.org, D-Link DDNS, or Oray.net.

Each configured Option port can have a different DDNS service if required. Once configured, the controller will update DDNS services changes in the Option IP address so that features that are dependent on accessing the controller's Option via FQDN will be directed to the correct IP address. When you set up an account with a DDNS service, the host and domain name, username, password and wildcard support will be provided by the account provider.

To configure DDNS:

1. Click **Network > Internet (IPv4) > Dynamic DNS**
2. Click the tab on top to select an Option port to which you want to configure DDNS.
3. Next to *Dynamic DNS Service Type*, select your DDNS service.

Dynamic DNS (DDNS) is an Internet service that allows routers with varying public IP addresses to be located using Internet domain names. To use DDNS, you must setup an account with a DDNS provider such as DynDNS.com, DlinkDDNS.com or Oray.net.

Dynamic DNS Option2 Settings

Option Mode
Current Option Mode: use only single option port option2

Option 2
Dynamic DNS Service Type: DynDNS ORAY DLINKDDNS None

Domain Name:

User Name:

Password:

Status:

Allow Wildcards:

Update Periodically: 30 Days

4. Enter the following information, and click **Save**. The information below is for DynDNS. Other services will have similar fields.

Field	Description
User Name	Enter your DDNS user name.
Domain Name	Enter the domain name.
Password	Enter your DDNS password.
Status	Displays the current connection status.
Allow Wildcards	Toggle to ON to allow wildcards.
Update Periodically	Toggle to ON to set a forced update.
Save	Click Save to save your reservation.

VLANs

A Virtual Local Area Network (VLAN) is a logical segment in a switched network. It allows independent logical networks to be created within a single physical network. VLANs separate devices into different broadcast domains and Layer 3 subnets. Devices within a VLAN can communicate without routing. The primary use of VLANs is to split large switched networks, which are large broadcast domains.

The wireless controller provides VLAN functionality for assigning unique VLAN IDs to LAN ports so that traffic to and from that physical port can be isolated from the general LAN. VLAN filtering is particularly useful to limit broadcast packets of a device in a large network.

VLAN Settings

Path: Network > VLAN > VLAN Settings

You can create VLANs on the VLAN Settings page. After you create VLANs, you can use the same page to view, edit, and delete VLANs.

To create a VLAN:

1. Go to **Network > VLAN > VLAN Settings**.

The screenshot displays the D-Link Unified Services Router (DWC-1000) web interface. The top navigation bar includes 'Status', 'Wireless', 'Network', 'VPN', 'Security', and 'Maintenance'. The current page is 'VLAN Settings' under 'Network > VLAN'. The page title is 'VLAN Configuration'. Below the title, there is a 'VLAN List' section with a table showing three VLAN entries. Below the table is an 'Add New VLAN' button. The 'VLAN DHCP Pools' section shows a table with one entry for Pool ID 1, with Start IP 192.168.10.100 and End IP 192.168.10.254. Below this table is an 'Add New Pool' button.

VLAN List

Name	VLAN ID	VLAN Type	IP Address	Subnet Mask	Captive Portal	Authentication Server
2	2	VLAN (L3)	192.168.2.1	255.255.255.0	Temporary	radius
AA	45	VLAN (without IP interface)	NA	NA	NA	NA
Default	1	VLAN (L3)	192.168.10.1	255.255.255.0	Free	None

Showing 1 to 3 of 3 entries

VLAN DHCP Pools

Pool ID	Start IP	End IP
1	192.168.10.100	192.168.10.254

Showing 1 to 1 of 1 entries

2. Click **Add New VLAN**. The following page will appear.

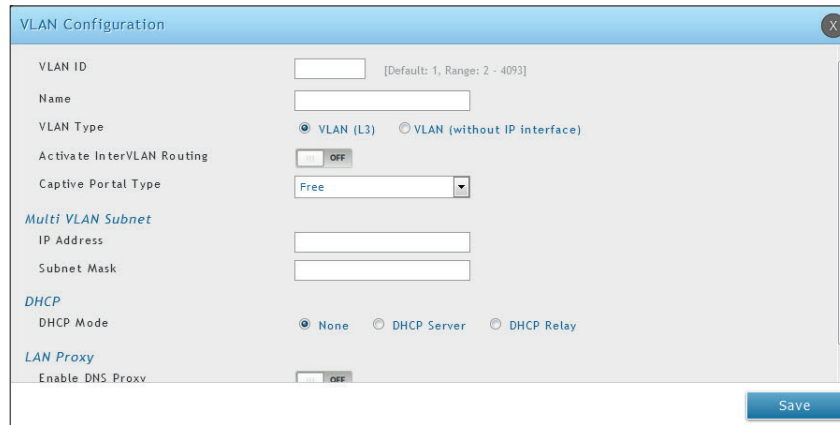

3. Complete the fields in the table below, and click **Save**. The fields vary with the type of the captive portal.

Field	Description
VLAN ID	Enter a unique ID to this VLAN (2 - 4093).
Name	Enter a unique name for this VLAN. The name should allow you to easily identify this VLAN from others you may add.
VLAN Type	Allows you to select the type of VLAN that you would like to create. If VLAN (L3) is selected, VLAN will be associated with the L3 network. If VLAN (without IP interface) is selected, a VLAN is created in switch but none of the L3 network associated with it.
Activate InterVLAN Routing	Allows or denies communication between VLAN networks. Choices are: <ul style="list-style-type: none"> • Enable = allows communications between different VLANs. • Disable= denies communications between different VLANs.
Captive Portal Type	Select the type of captive portal from free, SLA, Permanent User, Temporary User, or Billing User.
Authentication Server	Select the type of authentication server to authenticate captive portal for permanent, temporary, or billing users. It shows the available authentication servers among which one can be selected for this VLAN. All users login into the captive portal for this VLAN, are authenticated through the selected server. This option appears only if Captive Portal Type is selected as Permanent user. List of available authentication servers are: <ol style="list-style-type: none"> 1. Local User Database 2. Radius Server 3. LDAP Server 4. POP3
Authentication Type	This field is available only if Radius Server is selected as an Authentication Server. Available authentication types are PAP/CHAP/MSCHAP/MSCHAPV2.
Login Profile Name	Select a captive portal from the drop-down menu. Click Create a Profile to create a new profile.
IP Address	Enter an IP address for the Multi-VLAN subnet.
Subnet Mask	Enter the subnet mask for the Multi-VLAN subnet.
DHCP Mode	Select whether to enable DHCP Server or DHCP Relay.
LAN Proxy	Click to enable DNS proxy.

Editing VLANs

Path: Network > VLAN > VLAN Settings

To edit a VLAN:

1. Go to **Network > VLAN > VLAN Settings**.
2. Under VLAN List, right-click the VLAN you want to edit and click **Edit**. The following page will appear.
3. Edit the fields given in the table on the previous page and click **Save**.

VLAN Configuration

VLAN ID	1
Name	Default
Activate InterVLAN Routing	<input type="checkbox"/> ON
Captive Portal Type	Free
Multi VLAN Subnet	
IP Address	192.168.10.1
Subnet Mask	255.255.255.0
DHCP	
DHCP Mode	<input checked="" type="radio"/> None <input type="radio"/> DHCP Server <input type="radio"/> DHCP Relay
LAN Proxy	
Enable DNS Proxy	<input type="checkbox"/> ON

Save

Deleting VLANs

Path: Network > VLAN > VLAN Settings

If you do not need a VLAN, you can delete it.

Note: A precautionary message does not appear before you delete a VLAN. Therefore, be sure you do not need a VLAN before you delete it.

To delete a VLAN:

1. Go to **Network > VLAN > VLAN Settings**.
2. In the VLAN List, right-click the VLAN you want to delete and click **Delete**. (Or right-click on a VLAN and click **Select All**, then **Delete** to delete all VLANs.) The selected VLAN(s) will be deleted.

MultiVLAN Subnets

Path: Network > VLAN > VLAN Settings

Each VLAN can be assigned a unique IP address and subnet mask for the virtually isolated network. Unless you enable inter-VLAN routing for the VLAN, the VLAN subnet determines the network address on the LAN that can communicate with the devices that correspond to the VLAN.

To view and edit the available multi-VLAN subnets:

1. Go to **Network > VLAN > VLAN Settings**.

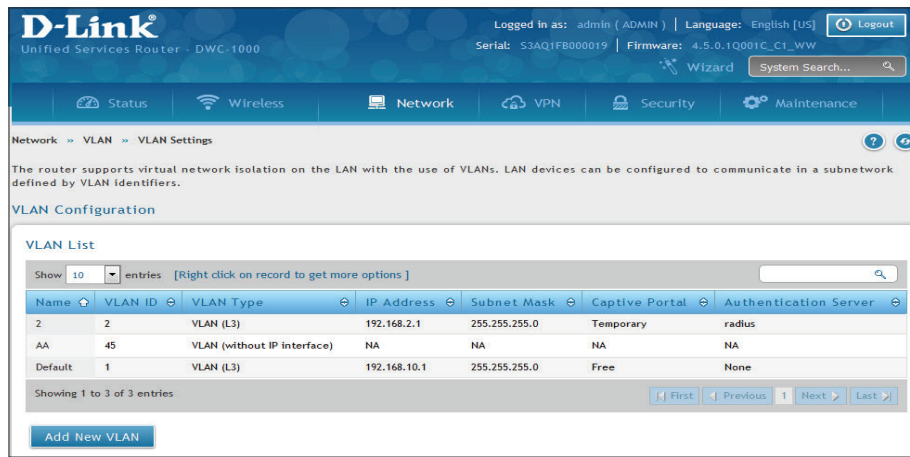

2. To edit a multi-subnet VLAN, right-click the VLAN and click **Edit**.

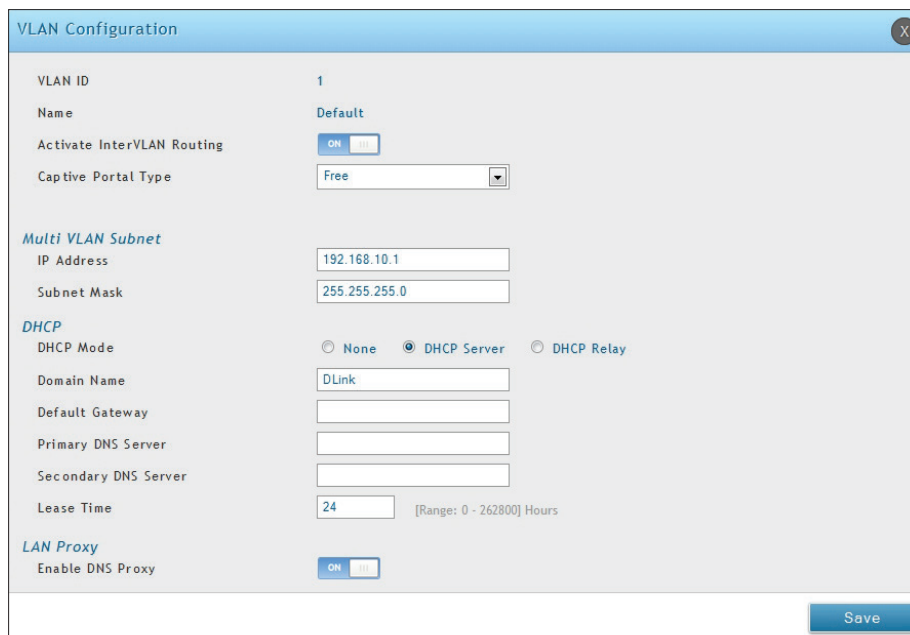

2. Edit the settings as desired (refer to the table below) and click **Save**.

Field	Description
MultiVLAN Subnet	
IP Address	Edit the IP address for the Multi-VLAN subnet.
Subnet Mask	Edit the subnet mask for the Multi-VLAN subnet.
DHCP	
DHCP Mode	<p>Select a DHCP mode for the VLAN. Choices are:</p> <ul style="list-style-type: none"> • None: Select this setting if the computers on the LAN are configured with static IP addresses or are configured to use another DHCP server. The remaining fields become unavailable. • DHCP Server: Select this setting to use the wireless controller as a DHCP server. Complete the remaining settings on the page. • DHCP Relay: If you select this setting, you need to enter the relay gateway information.
Domain Name	Enter the domain name for the VLAN.
Default Gateway	(Optional) Enter the IP address of the gateway for your LAN.
Primary DNS Server	(Optional) If configured domain name system (DNS) servers are available on the VLAN, enter the IP address of the primary DNS server.
Secondary DNS Server	(Optional) If configured domain name system (DNS) servers are available on the VLAN, enter the IP address of the secondary DNS server.
Lease Time	Enter a time interval, in hours that a DHCP client can use the IP address that it receives from the DHCP server. When the lease time is about to expire, the client sends a request to the DHCP server to get a new lease.
Relay Gateway	Enter the gateway address. This is the only configuration parameter required in this section when DHCP Mode = DHCP Relay.
LAN Proxy	
Enable DNS Proxy	<p>Enables or disables DNS proxy on this LAN. The feature is particularly useful in Auto Rollover mode. For example, if the DNS servers for each connection are different, a link failure can render the DNS servers inaccessible. However, when the DNS proxy is enabled, clients can make requests to the wireless controller and the controller, in turn, sends those requests to the DNS servers of the active connection. Choices are:</p> <ul style="list-style-type: none"> • Enabled - The wireless controller acts as a proxy for all DNS requests and communicates with the ISP's DNS servers (as configured in the Option settings page). All DHCP clients receive the primary and secondary DNS IP addresses, along with the IP address where the DNS proxy is running (i.e., the wireless controller's LAN IP). • Disabled - All DHCP clients receive the DNS IP addresses of the ISP, excluding the DNS proxy IP address.

Port VLANs

Path: Network > VLAN > Port VLAN

After you enable the wireless controller's VLAN function, use the Port VLAN page to configure the ports participating in the VLAN.

1. Go to **Network > VLAN > Port VLAN**.

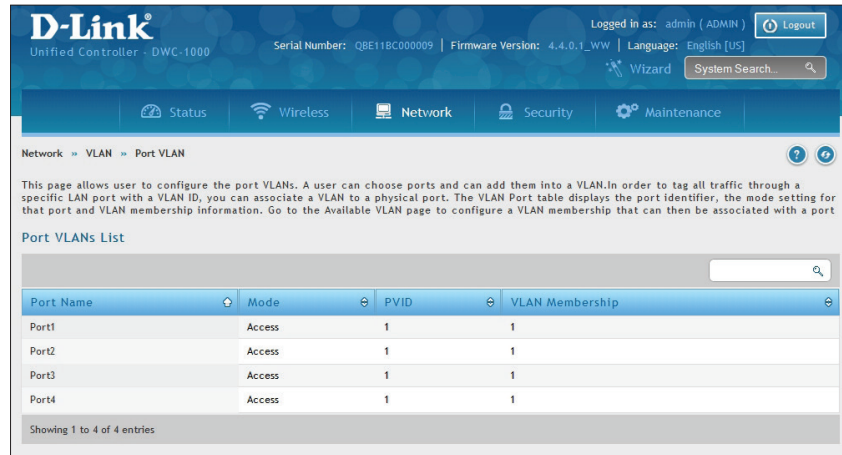

2. Select the port, right-click the selected port, and click **Edit**.

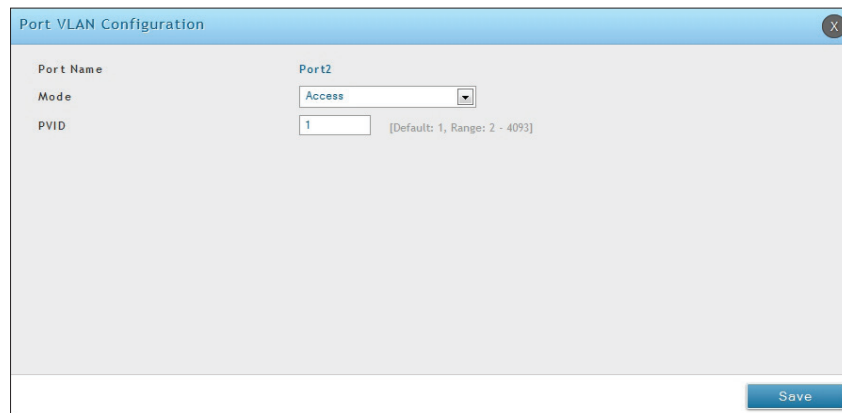

3. Change Mode and PVID. There are four modes:

- **Access:** Select to isolate this port from other VLANs. All data going into and out of the port is untagged. Traffic through a port in access mode looks like any other Ethernet frame.
- **General:** Select to allow the port to become a member of a user selectable set of VLANs. The port sends and receives data that is tagged or untagged with a VLAN ID. If the data into the port is untagged, it is assigned the defined PVID. All tagged data sent out of the port with the same PVID will be untagged.
- **Trunk:** Select to multiplex traffic for multiple VLANs over the same physical link. All data going into and out of the port is tagged. Untagged coming into the port is not forwarded, except for the default VLAN with PVID=1, which is untagged.

4. Select the **VLAN Membership**. When the port is in General or Trunk mode, the traffic can be routed from this port VLAN to others in the VLAN Membership list.

5. Click **Save**.

Routing

A static route tells network devices about an exact, fixed (hard-coded) destination. Static routes can work well with small networks. There are two kinds of static routing: Static Route and Protocol-Binding. The Static Route uses IP address to determine the next hop, whereas Protocol-Binding use protocol. Configuring your wireless controller for static routing allows data transfers between it and a routing device without using dynamic routing protocols.

Configure IPv4 Static Routing

Path: Network > Routing > Static Routes

To add a static route:

1. Click **Network > Routing > Static Routes**.

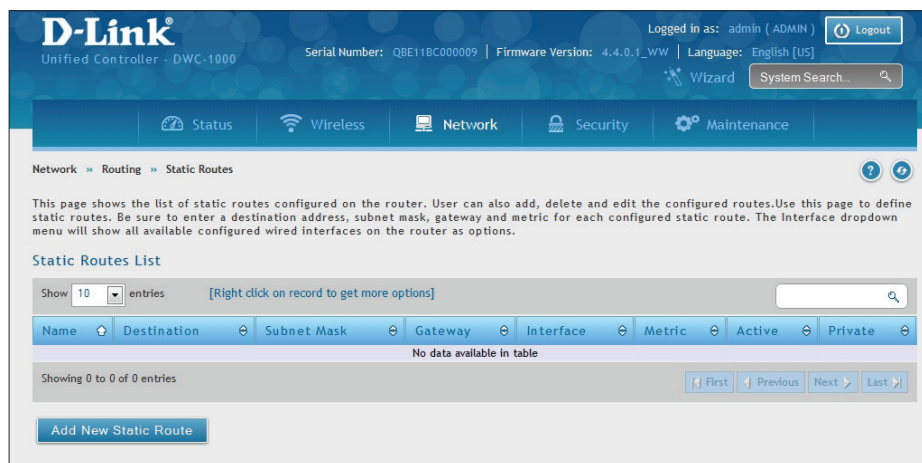

2. Click **Add New Static Route**. The Static Route Configuration page will appear.

3. Complete the fields given in the table on the next page, and click **Save**.

Field	Description
Route Name	Enter a unique name for this static route. The name should allow you to easily identify this static route from others you may add.
Active	Activates or deactivates the status route. Choices are: <ul style="list-style-type: none">• ON = activate static route.• OFF = deactivate static route.
Private	Designates the static route as private. Choices are: <ul style="list-style-type: none">• ON = static route is private.• OFF = static route is not private.
Destination IP Address	Enter the IP address of the static route's destination.
IP Subnet Mask	Enter the subnet mask of the static route.
Interface	Select the wireless controller interface that will interface to the static route. Choices are: <ul style="list-style-type: none">• Option 1/ Option 2: The wireless controller's Option port will interface to the static route.• LAN > VLAN: The wireless controller's LAN or VLAN port will interface to the static route.• DMZ: The port configured for DMZ will interface to the static route.
Gateway IP Address	Enter the IP address of the gateway router, which is the next hop address for the wireless controller.
Metric	Enter the administrative distance of the route. The range is 2 to 15.

Configure IPv6 Static Routing

Path: Network > IPv6 > Static Routing

Manually adding static routes to this device allows you to define the path selection of traffic from one interface to another. There is no communication between this controller and other devices to account for changes in the path; once configured the static route will be active and effective until the network changes.

The List of Static Routes displays all routes that have been added manually by an administrator and allows several operations on the static routes. The List of IPv4 Static Routes and List of IPv6 Static Routes share the same fields (with one exception):

To configure IPv6 Static Routing:

1. Go to **Network > IPv6 > Static Routing** page.

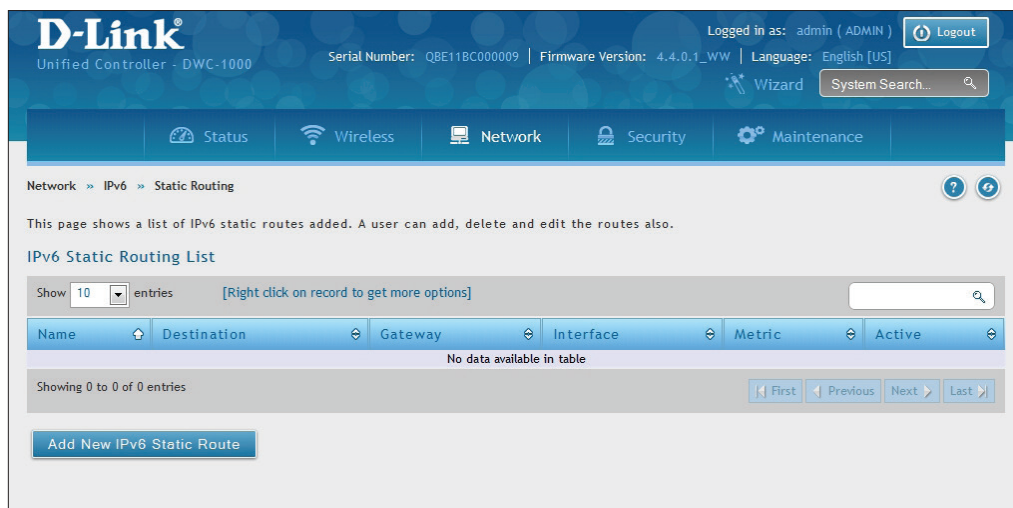

2. Click **Add New IPv6 Static Route**.

The screenshot shows the 'IPv6 Static Routing Configuration' dialog box. It contains the following fields and controls:

- Route Name: Text input field.
- Active: Toggle switch, currently set to OFF.
- IPv6 Destination: Text input field.
- IPv6 Prefix Length: Text input field with a range of 0 - 128.
- Interface: Dropdown menu, currently showing Option1.
- IPv6 Gateway: Text input field.
- Metric: Text input field with a range of 2 - 15.
- Save: Button at the bottom right.

3. Complete the fields given in the table below, and click **Save**.

Field	Description
Route Name	Enter a unique name for this static route. The name should allow you to easily identify this static route from others you may add.
Active	Activates or deactivates the status route. Choices are: <ul style="list-style-type: none"> • ON = activate static route. • OFF = deactivate static route.
Private	Designates the static route as private. Choices are: <ul style="list-style-type: none"> • ON = static route is private. • OFF = static route is not private.
IPv6 Destination	The wireless controller will lead to this destination host or IP address.
IPv6 Prefix Length	The number of prefix bits in the IPv6 address that define the subnet.
Interface	Select the wireless controller interface that will interface to the static route. Choices are: <ul style="list-style-type: none"> • Option 1/ Option 2 = the wireless controller's Option port will interface to the static route. • LAN = the wireless controller's LAN or VLAN port will interface to the static route. • Sit0 Tunnel
IPv6 Gateway	IP Address of the gateway through which the destination host or network can be reached.
Metric	Determines the priority of the route. If multiple routes to the same destination exist, the route with the lowest metric is chosen.

Editing/Deleting Static Routes

After you add static routes, you can edit it if you need to change settings. To edit a static route, right-click the static route you want to edit, and click **Edit**.

To delete a static route, right-click the static route you want to remove, and click **Delete**.

RIP

Path: Network > Routing > RIP

Dynamic routing using the Routing Information Protocol (RIP) is an Interior Gateway Protocol (IGP) that is common in LANs. With RIP, this controller can exchange routing information with other supported routers/controllers in the LAN and allow for dynamic adjustment of routing tables in order to adapt to modifications in the LAN without interrupting traffic flow.

To configure RIP:

1. Click **Network > Routing > RIP**.

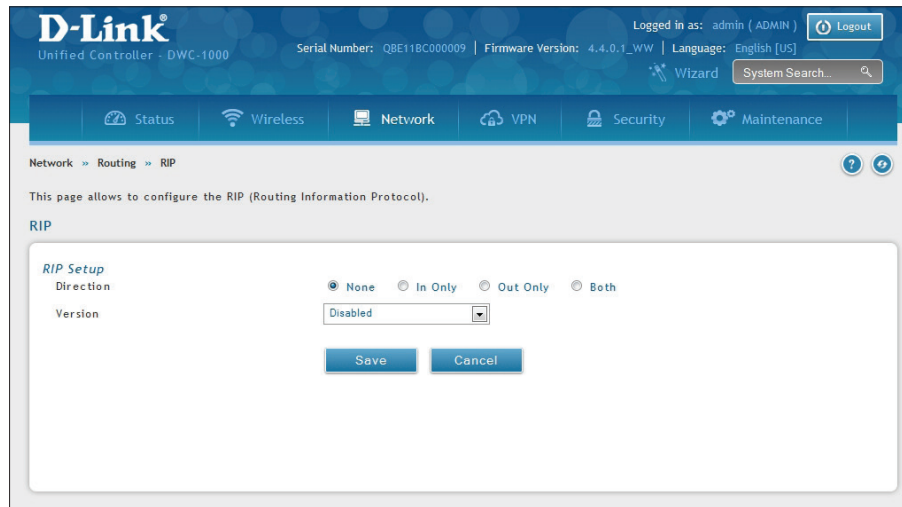

2. Complete the fields in the table below and click **Save**.

Field	Description
Direction	<p>The RIP direction will define how this controller sends and receives RIP packets. Select one of the following:</p> <ul style="list-style-type: none"> • Both: The controller both broadcasts its routing table and also processes RIP information received from other controllers. This is the recommended setting in order to fully utilize RIP capabilities. • Out Only: The controller broadcasts its routing table periodically but does not accept RIP information from other controllers. • In Only: The controller accepts RIP information from other controllers, but does not broadcast its routing table. • None: The controller neither broadcasts its route table nor does it accept any RIP packets from other controllers. This effectively disables RIP.
Version	<p>The RIP version is dependent on the RIP support of other routing devices in the LAN.</p> <ul style="list-style-type: none"> • Disabled: This is the setting when RIP is disabled. • RIP-1: A class-based routing version that does not include subnet information. This is the most commonly supported version. • RIP-2: Includes all the functionality of RIPv1 plus it supports subnet information. Though the data is sent in RIP-2 format for both RIP-2B and RIP-2M, the mode in which packets are sent is different. RIP-2B broadcasts data in the entire subnet, while RIP-2M sends data to multicast addresses. <p>Note: If RIP-2B or RIP-2M is the selected version, authentication between this controller and other controllers (configured with the same RIP version) is required. MD5 authentication is used in a first/second key exchange process. The authentication key validity lifetimes are configurable to ensure that the routing information exchange is with current and supported controllers detected on the LAN.</p>
Save	Click Save to save your settings.

OSPF

Path: Network > Routing > OSPF

OSPF is an interior gateway protocol that routes Internet Protocol (IP) packets solely within a single routing domain. It gathers link state information from available controllers and constructs a topology map of the network.

OSPF version 2 is a routing protocol which described in RFC2328 - OSPF Version 2. OSPF is IGP (Interior Gateway Protocols). OSPF is widely used in large networks such as ISP backbone and enterprise networks.

To configure OSPF:

1. Click **Network > Routing > OSPF**.

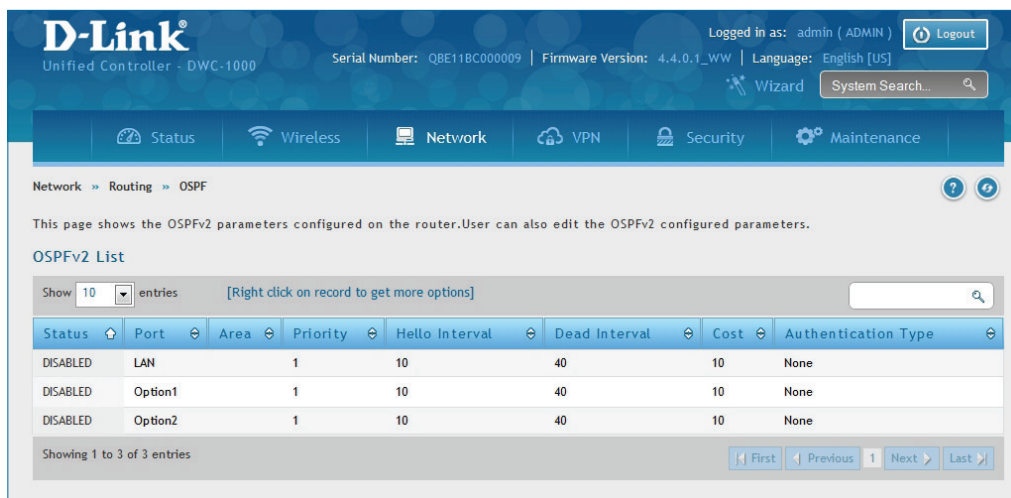

The screenshot shows the D-Link Unified Controller web interface. The top navigation bar includes Status, Wireless, Network, VPN, Security, and Maintenance. The current page is 'Network > Routing > OSPF'. Below the navigation, there is a description: 'This page shows the OSPFv2 parameters configured on the router. User can also edit the OSPFv2 configured parameters.' The main content area is titled 'OSPFv2 List' and features a table with the following data:

Status	Port	Area	Priority	Hello Interval	Dead Interval	Cost	Authentication Type
DISABLED	LAN		1	10	40	10	None
DISABLED	Option1		1	10	40	10	None
DISABLED	Option2		1	10	40	10	None

At the bottom of the table, it says 'Showing 1 to 3 of 3 entries' and includes navigation buttons for First, Previous, Next, and Last.

2. Right-click the port you want to edit (LAN/Option1/Option2), and click **Edit**.
3. Complete the fields given in the table on the next page, and click **Save**.

Field	Description
OSPFv2 Enable	Toggle ON to enable OSPF.
Interface	Displays the physical network interface on which OSPFv2 is Enabled/Disabled.
Area	Enter the area to which the interface belongs. Two controllers having a common segment; their interfaces have to belong to the same area on that segment. The interfaces should belong to the same subnet and have similar mask.
Priority	Helps to determine the OSPFv2 designated controller for a network. The controller with the highest priority will be more eligible to become Designated Controller. Setting the value to 0 makes the controller ineligible to become Designated Controller. The default value is 1. Lower the value means higher the priority.
Hello Interval	The number of seconds for Hello Interval timer value. Enter the number in seconds that the Hello packet will be sent. This value must be the same for all controllers attached to a common network. The default value is 10 seconds.
Dead Interval	The number of seconds that a device's hello packets must not have been seen before its neighbors declare the OSPF controller down. This value must be the same for all controllers attached to a common network. The default value is 40 seconds. OSPF requires these intervals to be exactly the same between two neighbors. If any of these intervals are different, these controllers will not become neighbors on a particular segment.
Cost	Enter the cost of sending a packet on an OSPFv2 interface.
Authentication Type	Select one of the following authentication types: <ul style="list-style-type: none"> • None: The interface does not authenticate OSPF packets. • Simple: OSPF packets are authenticated using simple text key. • MD5: The interface authenticates OSPF packets with MD5 authentication.
Md5 Key ID	If MD5 authentication is selected, enter the MD5 key ID.
Md5 Authentication Key	If MD5 authentication is selected, enter the MD5 authentication key.
Save	Click Save to save your settings.

OSPFv3 (IPv6)

Path: Network > IPv6 > OSPFv3

OSPF (Open Shortest Path First) is an interior gateway protocol that routes Internet Protocol (IP) packets solely within a single routing domain. It gathers link state information from available controllers and constructs a topology map of the network.

OSPFv3 supports IPv6. To enable an OSPFv3 process on a controller, you need to enable the OSPFv3 process globally, assign the OSPFv3 process a controller ID, and enable the OSPFv3 process on related interfaces.

To configure OSPFv3:

1. Click **Network > IPv6 > OSPFv3**.

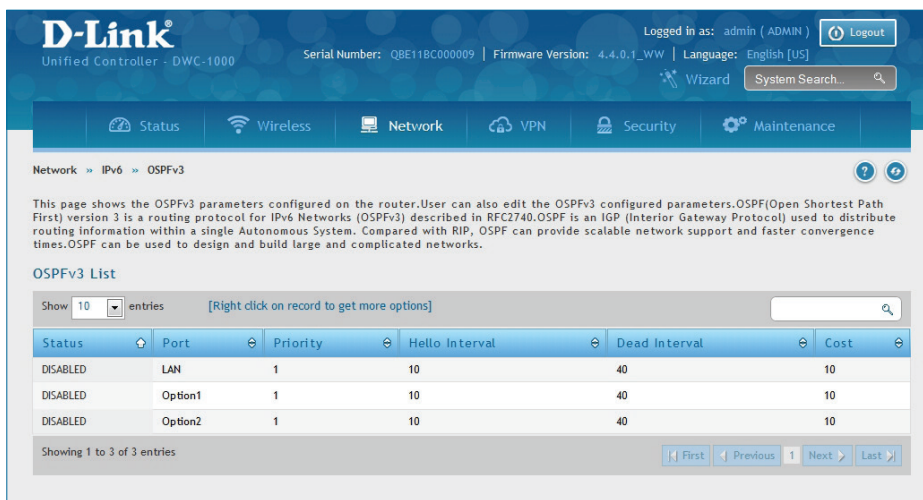

Network > IPv6 > OSPFv3

This page shows the OSPFv3 parameters configured on the router. User can also edit the OSPFv3 configured parameters. OSPF (Open Shortest Path First) version 3 is a routing protocol for IPv6 Networks (OSPFv3) described in RFC2740. OSPF is an IGP (Interior Gateway Protocol) used to distribute routing information within a single Autonomous System. Compared with RIP, OSPF can provide scalable network support and faster convergence times. OSPF can be used to design and build large and complicated networks.

OSPFv3 List

Show 10 entries [Right click on record to get more options]

Status	Port	Priority	Hello Interval	Dead Interval	Cost
DISABLED	LAN	1	10	40	10
DISABLED	Option1	1	10	40	10
DISABLED	Option2	1	10	40	10

Showing 1 to 3 of 3 entries

First Previous 1 Next Last

2. Right-click the port you want to edit (LAN/Option1/Option2), and click **Edit**.
3. Complete the fields in the table on the next page, and click **Save**.

Field	Description
OSPFv3 Enable	Toggle ON to enable OSPFv3.
Interface	Displays the physical network interface on which OSPFv3 is Enabled/Disabled.
Priority	Helps to determine the OSPFv3 designated controller for a network. The controller with the highest priority will be more eligible to become Designated Controller. Setting the value to 0 makes the controller ineligible to become Designated Controller. The default value is 1. Lower the value means higher the priority.
Hello Interval	The number of seconds for Hello Interval timer value. Enter the number in seconds that the Hello packet will be sent. This value must be the same for all controllers attached to a common network. The default value is 10 seconds.
Dead Interval	The number of seconds that a device's hello packets must not have been seen before its neighbors declare the OSPF controller down. This value must be the same for all controllers attached to a common network. The default value is 40 seconds. OSPF requires these intervals to be exactly the same between two neighbors. If any of these intervals are different, these controllers will not become neighbors on a particular segment.
Cost	Enter the cost of sending a packet on an OSPFv3 interface.
Save	Click Save to save your settings.

6 to 4 Tunneling (IPv6)

Path: Network > IPv6 > 6 to 4 Tunneling

6to4 is an Internet transition mechanism for migrating from IPv4 to IPv6, a system that allows IPv6 packets to be transmitted over an IPv4 network. When enabled, traffic from an IPv6 LAN to be sent over an IPv4 Option to reach a remote IPv6 network.

To enable 6 to 4 Tunneling:

1. Click **Network > IPv6 > 6 to 4 Tunneling**.

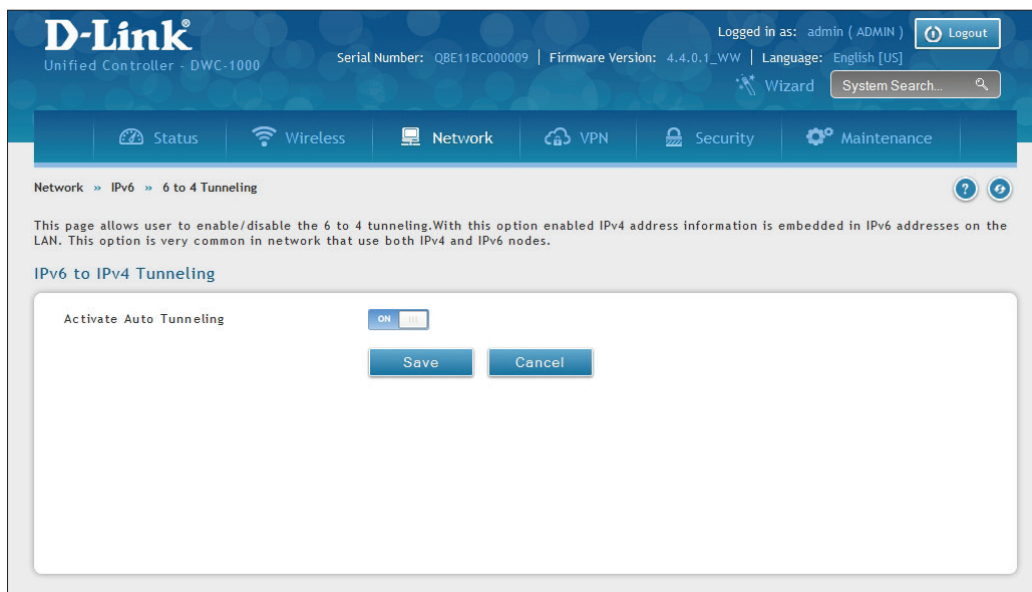

2. Toggle *Activate Auto Tunneling* to **On** and click **Save**.

ISATAP Tunnels (IPv6)

Path: Network > IPv6 > ISATAP Tunnels

ISATAP (Intra-Site Automatic Tunnel Addressing Protocol) is an IPv6 transition mechanism meant to transmit IPv6 packets between dual-stack nodes on top of an IPv4 network. ISATAP specifies an IPv6-IPv4 compatibility address format as well as a means for site border router discovery. ISATAP also specifies the operation of IPv6 over a specific link layer - that being IPv4 used as a link layer for IPv6.

To configure ISATAP Tunnels:

1. Click **Network > IPv6 > ISATAP Tunnels**.

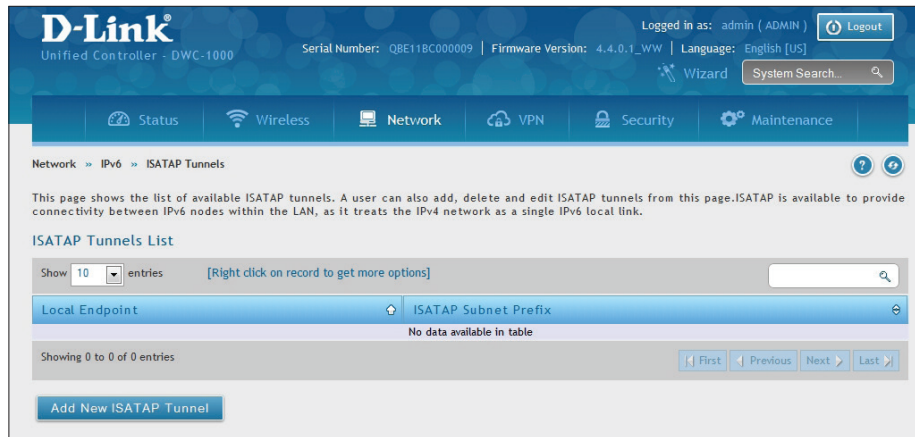

2. Click **Network > IPv6 > ISATAP Tunnels**. Complete the fields

Field	Description
ISATAP Subnet Prefix	This is the 64-bit subnet prefix that is assigned to the logical ISATAP subnet for this intranet. This can be obtained from your ISP or internet registry, or derived from RFC 4193.
End Point Address	This is the endpoint address for the tunnel that starts with this controller. The endpoint can be the LAN interface (assuming the LAN is an IPv4 network), or a specific LAN IPv4 address.
IPv4 Address	If you selected LAN IPv4 Address, then enter the end point address.
Save	Click Save to save your settings.

Protocol Binding

Path: Network > Routing > Protocol Binding

Protocol bindings are useful when the Load Balancing feature is in use. Selecting from a list of configured services or any of the user-defined services, the type of traffic can be assigned to go over only one of the available Option ports. For increased flexibility the source network or machines can be specified as well as the destination network or machines. For example, the VOIP traffic for a set of LAN IP addresses can be assigned to one Option and any VOIP traffic from the remaining IP addresses can be assigned to the other Option link. Protocol bindings are only applicable when load balancing mode is enabled and more than one Option port is configured.

To add, edit, or delete a protocol binding entry:

1. Click **Network > Routing > Protocol Binding**.

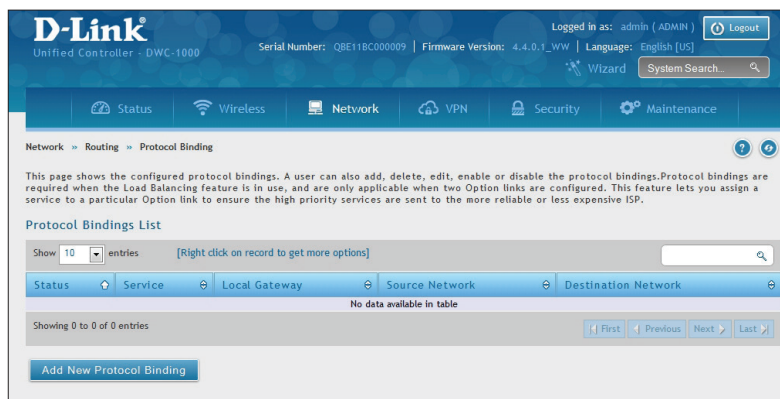

2. Right-click a current entry and select **Edit** or **Delete**. To add a new entry, click **Add New Protocol Binding**.
3. Complete the fields in the table below and click **Save**.

Field	Description
Service	Select a service from the drop-down menu.
Local Gateway	Select an Option interface.
Source Network	Select the source network: Any , Single Address , or Address Range . If Single Address or Address Range is selected, enter the IP address or IP range.
Destination Network	Select the destination network: Any , Single Address , or Address Range . If Single Address or Address Range is selected, enter the IP address or IP range.
Save	Click Save to save your settings.

Securing Your Network

The wireless controller supports a number of features for securing your network. This chapter describes the following commonly used security features:

- “Client Management” on page 190
- “Group Management” on page 193
- “User Management” on page 200
- “Hotspot” on page 205
- “Captive Portal Front Desk” on page 206
- “Guest Account Usage Management” on page 207
- “External Authentication” on page 219
- “Blocked Clients” on page 240
- “WIDS” on page 65

Note: *The procedures in this chapter should only be performed by expert users who understand networking concepts and terminology.*

Client Management

Using the MAC Authentication page, you can view wireless clients in the MAC Authentication database. The database contains wireless client MAC addresses and names. The database is used to retrieve descriptive client names from the RADIUS server and implement MAC authentication.

The page also lets you add, edit, and delete clients.

Viewing/Adding Wireless Known Clients

Path: Security > Authentication > User Database > MAC Authentication

To view wireless known clients:

1. Go to **Security > Authentication > User Database**.
2. Click on the **MAC Authentication** tab in the middle menu. The MAC Authentication page will appear displaying a list of the wireless clients in the MAC Authentication database.

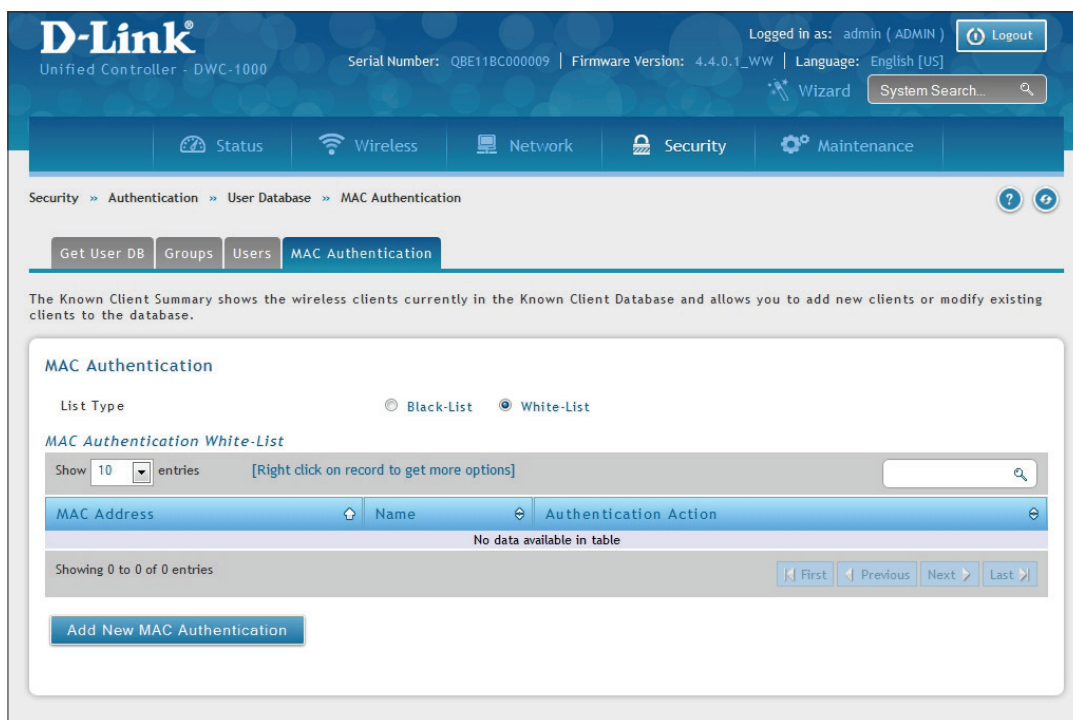

3. Next to *List Type* the current global setting is displayed.

MAC authentication is a feature that grants or denies a client access to the network on the basis of the List type (white-list or black-list) of the client's MAC address. MAC Authentication is enable at the network level. The network configuration also defines whether MAC addresses are looked up on the local database or on the RADIUS server.

4. Click **Add New MAC Authentication**. The MAC Authentication Configuration page will appear.

5. Complete the fields in the table below and click **Save**.

Field	Description
MAC Address	Enter the MAC address for the known client.
Name	Enter the name of the known client. The name should allow you to differentiate this known client from others you may add.
Authentication Action	<p>When MAC authentication is enabled on the network, this field shows the action to be taken on a wireless client. The following options are available.</p> <ul style="list-style-type: none"> • Grant: Allow the client with the specified MAC address to access the network. • Deny: Prohibit the client with the specified MAC address from accessing the network. • Global Action: Use the global white-list or black-list action configured on the Advanced Global Configuration page to determine how to handle the client.

Editing/Deleting Clients

Path: Security > Authentication > User Database > MAC Authentication

After you add clients, you can edit or delete it if you need to change settings.

To edit or delete a client:

1. Go to **Security > Authentication > User Database > MAC Authentication**.
2. Under *MAC Authentication List*, right-click the client and select either **Edit** or **Delete**.
3. Change the desired settings (refer to the table on the previous page).
4. Click **Save**.

Group Management

A user group is a collection of users who share the same privileges. The following section describes how to add user groups. After you add a user group, you can configure its login policies, policies for browsers, and policies by IP. You can also edit user groups when changes are required, and delete the user groups that you do not need.

Adding User Groups

Path: Security > Authentication > User Database > Groups

When you add a user group, you assign:

- A name that identifies the user group
- An optional user group description
- At least one privilege (or “user type”)
- An idle timeout value

After you define user groups, you can use the procedure under “User Management” on page 200 to populate the groups with users.

To add a user group:

1. Go to **Security > Authentication > User Database > Groups**.

The screenshot displays the D-Link Unified Controller web interface. The top navigation bar includes the D-Link logo, system information (Serial Number: QBE11BC000009, Firmware Version: 4.4.0.1_WW, Language: English [US]), and a Logout button. The main navigation menu has tabs for Status, Wireless, Network, Security, and Maintenance. The breadcrumb path is Security > Authentication > User Database > Groups. Below the breadcrumb, there are tabs for Get User DB, Groups (selected), Users, and MAC Authentication. A message states: "This page shows the list of added groups to the router. The user can add, delete and edit the groups also." The "Groups List" section shows a table with 2 entries. The table has columns for Group Name and Description. The entries are ADMIN (Admin Group) and GUEST (Guest Group). Below the table, it says "Showing 1 to 2 of 2 entries" and includes navigation buttons (First, Previous, 1, Next, Last). An "Add New Group" button is located at the bottom left of the table area.

Group Name	Description
ADMIN	Admin Group
GUEST	Guest Group

2. Click **Add New Group**. The Group Configuration pop-up page will appear.

3. Complete the fields in the table below and click **Save**.

Field	Description
Group Configuration	
Group Name	Enter a unique name for this group. The name should allow you to easily identify this group from others you may add.
Description	Enter a description for this user group.
User Type	
Admin	Click this to grant all users in this group super-user privileges. By default, there is one admin user. The group types for Admin users are: <ul style="list-style-type: none"> Captive Portal User - The users of the group having Captive Portal privilege will have permissions to access the Internet/Networks through Captive Portal authentication.
Network	Selecting Network enables an extra option, by default the group types for Network users are: <ul style="list-style-type: none"> Captive Portal User - The users of the group having Captive Portal privilege will have permissions to access the Internet/Networks through Captive Portal authentication.
Front Desk	The users of the group having Front Desk User privilege will have permissions to create temporary users who can access Internet/Network by using Hotspot.
Guest	The users of the group having Guest User privilege will only have view only permissions. Such users cannot configure the device.
Idle Timeout	Enter the number of minutes of inactivity that must occur before the users in this user group are logged out of their web management session automatically. Entering an Idle Timeout value of 0 (zero) means never log out.

Editing User Groups

Path: Security > Authentication > User Database > Groups

There may be times when you need to edit a user group. For example, you might want to change the privileges for the user group or idle timeout.

To edit a user group:

1. Go to **Security > Authentication > User Database > Groups**. The Groups List page will appear.
2. Right-click the user group you want to edit, and click **Edit**. The Group Configuration pop-up page will appear.

Group Configuration

Group Name: Employee

Description: Employees

User Type

User Type: Admin Network Front Desk Guest

SSLVPN User: OFF

Captive Portal User: ON

Idle Timeout: 10 [Default: 10, Range: 1 - 999] Minutes

Save

3. Complete the fields in the previous page, and click **Save**.

Deleting User Groups

Path: Security > Authentication > User Database > Groups

If you no longer need a user group, you can delete it. Before you delete a user group, you must delete all users in it (see “Editing/Deleting Clients” on page 192).

Note: A precautionary message does not appear before you delete a user group. Therefore, be sure you do not need a user group before you delete it.

To delete a user group:

1. Go to **Security > Authentication > User Database > Groups**. The Groups page will appear.
2. Right-click on the user group you want to delete and click **Delete**. To delete all groups, click **Select All** and then **Delete**.

The screenshot shows the D-Link Unified Controller web interface. The top navigation bar includes the D-Link logo, system information (Serial Number, Firmware Version, Language), and a Logout button. The main navigation menu has tabs for Status, Wireless, Network, Security, and Maintenance. The breadcrumb trail is Security > Authentication > User Database > Groups. Below the breadcrumb, there are tabs for Get User DB, Groups, Users, and MAC Authentication. The main content area displays a message: "This page shows the list of added groups to the router. The user can add, delete and edit the groups also." Below this is the "Groups List" section, which includes a search bar and a table of groups. A context menu is open over the table, showing options for Select All, Edit, and Delete. The table lists four groups: ADMIN (Admin Group), Employee (Employees), FrontDesk (frontdeskusers), and GUEST (Guest Group). At the bottom of the table, there are navigation buttons for First, Previous, 1, Next, and Last. An "Add New Group" button is located at the bottom left of the table area.

Group Name	Description
ADMIN	Admin Group
Employee	Employees
FrontDesk	frontdeskusers
GUEST	Guest Group

Configuring Login Policies

Path: Security > Authentication > User Database > Groups

Using the following procedure, you can grant or deny a user group login access to the web management interface.

1. Click **Security > Authentication > User Database > Groups**. The Groups page will appear.
2. Check the box next to a user group.
3. Click the **Add Login Policies** button. The Login Policies Configuration page will appear.

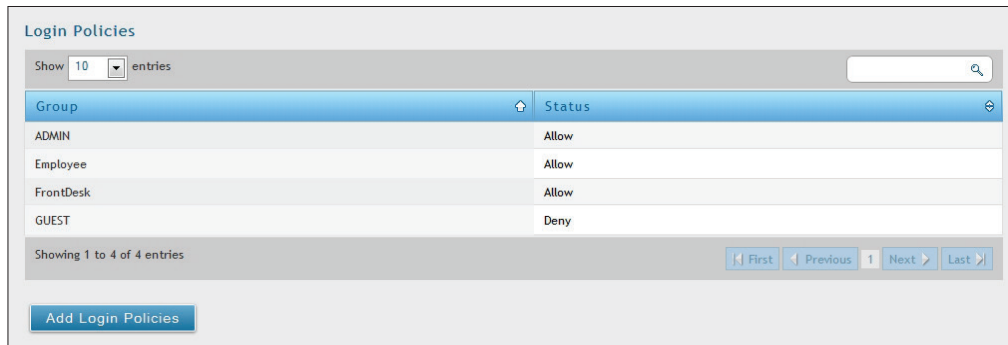

4. Complete the fields from the table below and click **Save Settings**.

Field	Description
Group Name	Name of the group.
Disable Login	Grants or denies login access to the web management interface for all users in this user group. Choices are: <ul style="list-style-type: none"> • On: Disable login access. • Off: Enable login access.
Deny login from Option Interface	Grants or denies login access from the wireless controller's Option port. Choices are: <ul style="list-style-type: none"> • On: Disable login access. • Off: Enable login access.

Configuring Browser Policies

Path: Security > Authentication > User Database > Groups

The following procedure describes how to configure browser-specific policies for user groups. Using this procedure, you can allow or deny the users in a user group from using particular web browsers to log in to the wireless controllers' web management interface.

1. Click **Security > Authentication > User Database > Groups**.
2. Click the **Add Browser Policies** button.

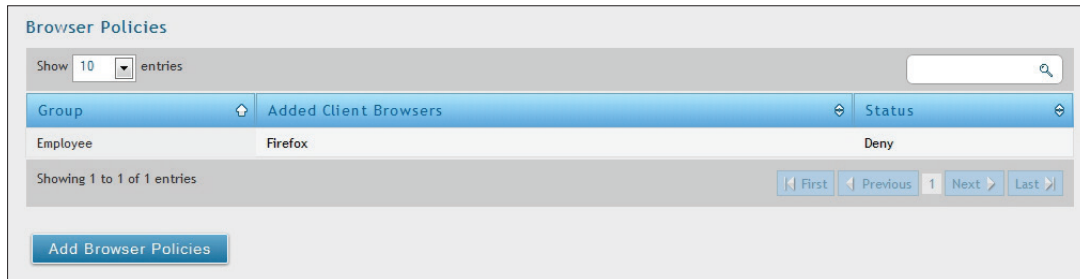

3. Select a group and a browser from the drop-down menus and click **Add**. The selected browser will appear in the Defined Browsers area.

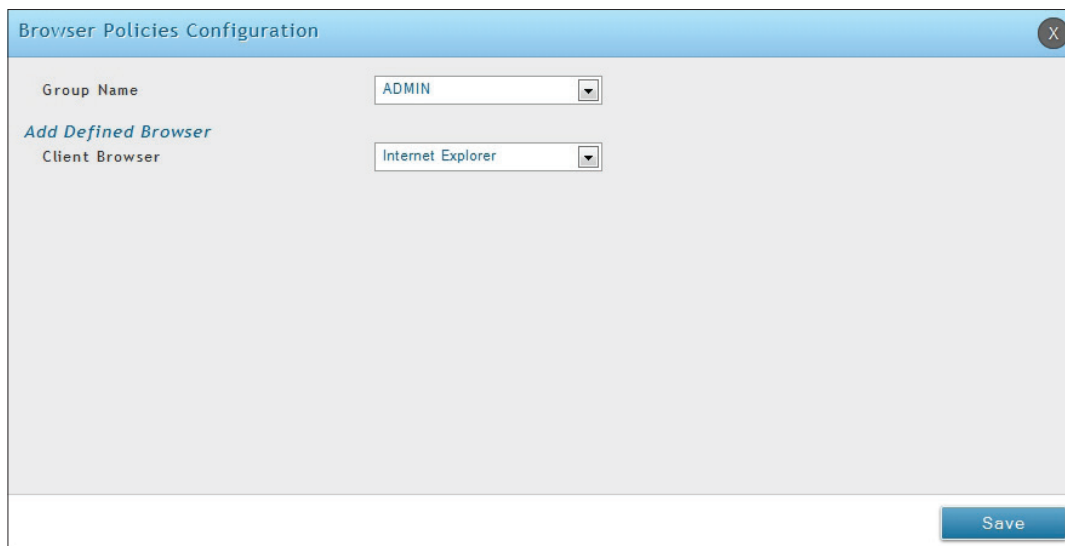

Field	Description
Group Name	Select the group name from the drop-down menu.
Client Browser	Select a web browser from the drop-down menu.

4. Right-click your entry from the list, and select **Allow** or **Deny**.

Configuring IP Policies

Path: Security > Authentication > User Database > Groups

The following procedure describes how to configure IP-specific policies for user groups. Using this procedure, you can allow or deny the users in a user group to log in to the wireless controllers' web management interface from a particular network or IP address.

1. Click **Security > Authentication > User Database > Groups** tab.
2. Click the **Add IP Policies** button. The IP Policies Configuration page will appear.

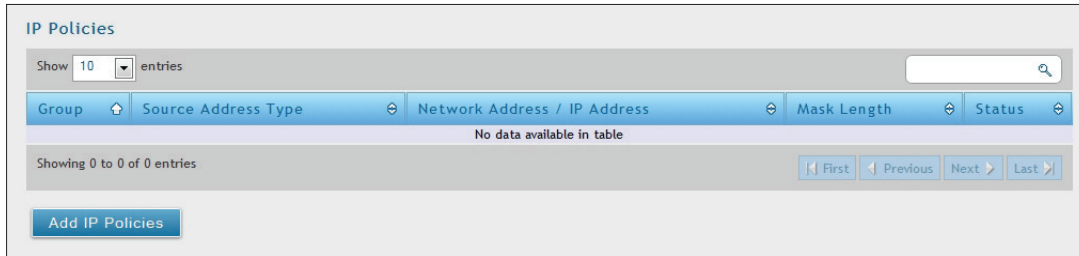

3. Complete the fields given in the table below, and click **Save**. The address you defined will appear in the Defined Addresses area.

Field	Description
Group Name	Select a group name from the drop-down menu.
Source Address Type	Choices are: <ul style="list-style-type: none"> • IP Address = specifies a particular IP address. • IP Network = specifies an entire IP network.
Network Address/IP Address	Enter the network or IP address.
Mask Length	Enter a subnet mask.

User Management

After you add user groups, you can add users to the user groups. Users can be added individually, or they can be imported from a comma-separated-value (CSV) formatted file.

After you add users, you can edit them when changes are required and delete users when you no longer need them.

Adding Users Manually

Path: Security > Authentication > User Database > Users

One way of adding users is to add users individually.

1. Go to **Security > Authentication > User Database > Users** tab.

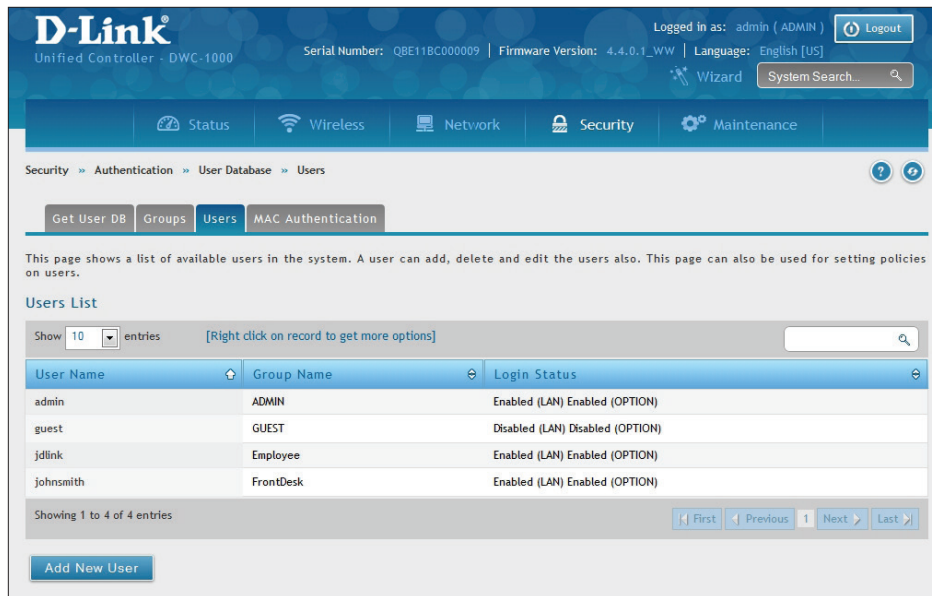

2. Click **Add New User**. The User Configuration pop-up page will appear.

The screenshot shows the 'User Configuration' pop-up page. It contains the following form fields:

- User Name:
- First Name:
- Last Name:
- Select Group: (dropdown menu)
- Password:
- Confirm Password:

A 'Save' button is located at the bottom right of the form.

3. Complete the fields in the table below and click **Save**.

Field	Description
User Name	Enter a unique name for this user. The name should allow you to easily identify this user from others you may add.
First Name	Enter the first name of the user.
Last Name	Enter the last name of the user.
Select Group	Select the captive portal group to which this user will belong.
Password	Enter a case-sensitive login password that the user must specify at the login prompt to access the web management interface. For security, each typed password character is masked with a dot (•).
Confirm Password	Enter the same case-sensitive password entered in the Password field. For security, each typed password character is masked with a dot (•).
Enable Password Change	If the group user type is Captive Portal, enable password change allowing user to change password if needed.
MultiLogin	If the group user type is Captive Portal, enable MultiLogin allowing user using the same username/ password login via multiple devices at the same time.

Importing Users

Path: Security > Authentication > User Database > Get User DB

A faster alternative to adding individual users is to import users from a file in comma separated value (*.CSV) format. The advantage of this feature is to allow a large number of users to be added to the system with one operation, and the same file can be uploaded to multiple DWC devices as needed. Once uploaded, the specific users in the local user database can be modified via the GUI as needed.

Steps to upload User DB:

1. Go to **Security > Authentication > User Database > Get User DB** page.

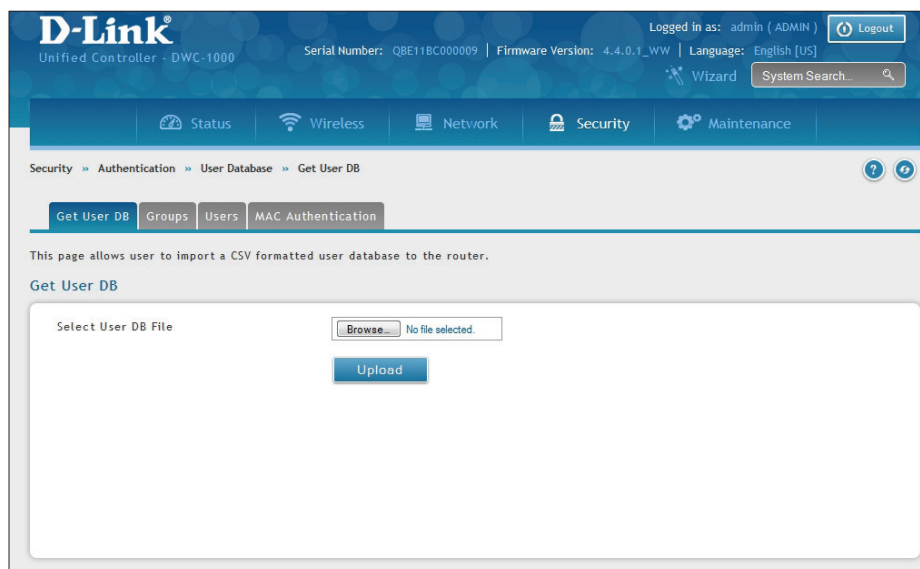

2. Click the **Browse** button.
3. In the *Choose File* dialog box, navigate to the location of the CSV file, and then select the file.
4. Click **Open**, and then click **Upload**.

The user may only add system users using the CSV file upload mechanism. Before adding users to different groups, the groups must be created using GUI. Also, edit and delete operations on users can be more conveniently handled through the GUI as it is much easier to select a particular user for edit/delete. This mechanism of .csv file upload is more convenient than GUI only for adding a large number of users, where users could be added at one go rather than one at a time through the GUI.

The following parameters must be used to define the User database CSV file.

1. Create an empty text file with a *.csv extension.
2. Each line in the file corresponds to a single user entry.
3. Formatting rules:
 - a) All the fields must be enclosed within double quotes.
 - b) Consecutive fields are separated by commas.
 - c) There should be no leading or trailing spaces in a line.
 - d) There should be no spaces between fields.

Each line in the CSV user database file should follow the following format:

"UserName","FirstName","LastName","GroupName","MultiLogin","Enable password change","Password"

The above sample has fields that can assume the following values:

- **Username** (text field): Name of the user and identifier in the DWC's database, and so it must be unique in the local user database.
- **FirstName** (text field): This is a user detail and need not be unique.
- **LastName** (text field): This is a user detail and need not be unique.
- **GroupName** (text field): The group that is associated with this user.
- **Password** (text field): The password to assign for this username.
- **MultiLogin** (Boolean value): With this enabled ("1"), then multiple users can share a single username and password.

Example:

1. The following Groups have already been created in the GUI:
 - a. "l2tp" with L2TP VPN capability.
 - b. "pptp" with PPTP VPN capability.
 - c. "cp" with Captive Portal capability.
2. Here are the compatible CSV files:
 - a. "test","te","st","pptp","0","0","test"
 - b. "test1","tes","st1","l2tp","0","0","test1"
 - c. "test2","ee","ff","ADMIN","0","0","test2"
 - d. "test3","dd","gg","GUEST","1","0","test3"
 - e. "test4","qq","ss","cp","1","1","test4"

Note:

- The Group for a corresponding user ("GroupName" in the CSV) must be created via the GUI, in advance of the User Database CSV upload action.
- None of the above fields can be left empty or NULL in the User Database CSV.

Editing Users

Path: Security > Authentication > User Database > Users

There may be times when you need to edit a user. For example, you might want to change the user's login password or idle timeout.

To edit a user:

1. Click **Security > Authentication > User Database > Users** tab. The Users List page will appear.
2. Right-click on the user you want to edit, and click **Edit**.

3. Complete the fields given in the table below, and click **Save**.

Field	Description
User Name	Enter a unique name for this user. The name should allow you to easily identify this user from others you may add.
First Name	Enter the first name of the user.
Last Name	Enter the last name of the user.
Select Group	Select the group to which this user will belong.
Edit Password	Toggle this option to enter the password to be used by this user to log in to the web management interface.
Current Logged in Administrator Password	Enter the current case-sensitive login password. For security, each typed password character is masked with a dot (•).
New Password	Enter the new case-sensitive login password. For security, each typed password character is masked with a dot (•). Record the new password in Appendix A.
Confirm Password	Enter the new password again.

Deleting Users

Path: Security > Authentication > User Database > Users

If you no longer need a user, you can delete that user.

Note: A precautionary message does not appear before you delete a user. Therefore, be sure that the specific user is not needed before you delete it.

To delete a user:

1. Click **Security > Authentication > User Database > Users** tab. The Users List page will appear.
2. Right-click on the user you want to delete, and click **Delete**. To delete all the users, click **Select All** and then **Delete**.

Hotspot

Hotspot support is a feature that offers Internet access over a wireless local area network (WLAN) through the use of a controller connected to a link to an Internet service provider. Hotspots typically use Wi-Fi to offer clients internet service via approval through the captive portal.

The typical Hotspot application is an administrator at a front desk or reception granting temporary user accounts for internet access through a captive portal. This portal will have an SLA and associated billing profile. Whenever the front desk admin creates new temporary user accounts, the admin will have to push these temporary accounts to the peer controller manually via the DWC GUI.

However in a clustering setup, temporary users created in one controller will be pushed automatically to the peer controller. The billing profiles associated with that user will have to be pushed manually to the peer controllers in advance. This will allow the auto-synchronization of temporary users to take place between peer controllers.

Example:

- In a hotel, the controller administrator creates a set of billing and captive portal profiles and pushes them from the DWC controller to all peer controllers.
- The front desk administrator creates temporary accounts for a new guest.
- The temporary accounts will be pushed automatically to all peer controllers so that guests can have access to the portal and be authenticated for internet access from any floor, any peer controller.

The front desk administrator has the ability to create 256 temporary users. Each peer controller can manage 1024 total temporary users. For the auto-synchronization to work, it is a requirement that each controller in the cluster have synchronized time settings, to enable time-based billing or accounting for the user.

Note: *Accounting is on a per-controller basis. This means that a temporary user authenticated on one controller will not have its usage statistics shared among controllers in the event that the same user credentials are used to authenticate via another peer or cluster controller.*

Captive Portal Front Desk

The Front Desk user has the ability to create temporary user accounts for internet access through the Captive Portal. This user does not have full administrative privileges, but instead will be able to create a user based on pre-defined billing profiles.

All created Billing Profiles are available for display on the Front Desk user's admin page. From this page, create a new temporary user ID and associate a pre-defined Billing Profile to this user. The Front Desk user will be able to leverage the features like batch user generation, customized account names, or modifying usage limits for these temporary CP users if the admin has enabled the Billing Profile with this support.

The section "Captive Portals SSID Setup" outlines how to associate an SSID for Captive Portal authentication. For users given access by the Front Desk, the Captive Portal Type needs to be a temporary user. This will allow for the usage limits to have control on the amount or duration of internet access.

The last step to leverage this feature is to create a Front Desk group and assign a user to this group (i.e. username = HotelAdmin). The Front Desk user (HotelAdmin) will be allowed to access the appliance's management interface via the following URL: <Controller_LAN_IP>/frontdesk. With the defined login credentials, the Front Desk user can now create and customize temporary accounts for internet access through the selected Billing Profile.

Note:

- *The entered URL of <Controller_LAN_IP>/frontdesk will redirect to <Controller_LAN_IP>/platform.cgi?page=billingDeskLogin.htm. I.e. if the LAN IP address is the default 192.168.10.1, then the Front Desk user's entry of 192.168.10.1/frontdesk" in their browser's URL will redirect to http://192.168.10.1/platform.cgi?page=billingDeskLogin.htm.*
- *Opening the Front Desk page from the same browser as the current admin session will not auto-redirect to the correct page.*

Guest Account Usage Management

Guest account is generated by the wireless controller. Set the relative billing profiles to control guest internet usage.

The billing profile settings include 4 milestones by timeline:

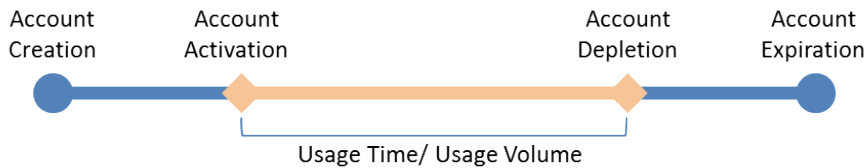

- Account Creation: the temporary account is generated by front desk account in the local database.
- Account Activation: the temporary account is activated and it is valid for use.
- Account Depletion: the temporary account is run out usage time or usage volume.
- Account Expiration: the temporary account is expired no matter usage time/ volume running out or not, and it is removed from the local database.

The billing profile can be various depending on how to put the value in the settings. Below are five most comment types of billing profiles:

1. The temporary account usage time is limited by duration. The account has the expiration time. The account is valid while the account is created.

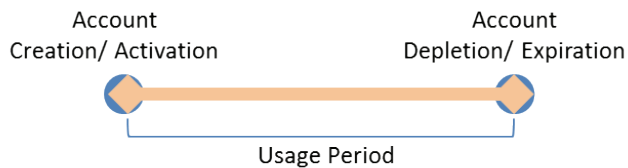

This billing profile is suitable for the scenario in Hotel. The temporary account is created and valid while customers check-in.

- The temporary account usage time is limited by duration. The account has the expiration time. The account is valid while the account first logs in.

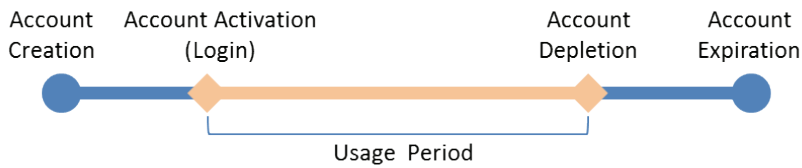

This billing profile is suitable for the scenario in Coffee Shop, Airport, etc. The customer can use wireless internet service for a period of time counting from first time logs in.

- The temporary account is valid with specific date and time. The account has the expiration time.

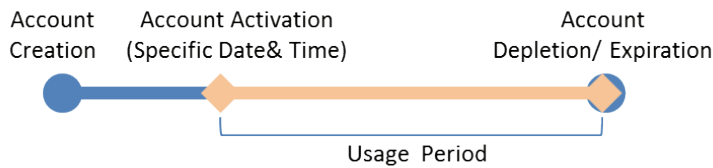

This billing profile is suitable for the scenario in Press Conference. The organizer generates accounts before the event and delivery account information to participator in advanced if necessary. The temporary account would be only valid from specific date and time.

- The temporary account has limited time usage. The account doesn't have the expiration time until the usage is run out.

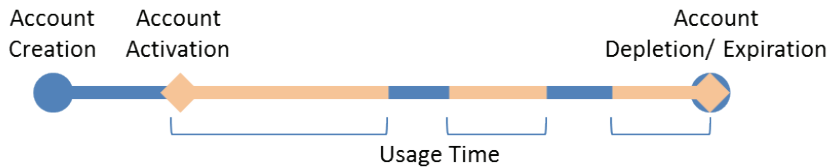

This billing profile is suitable for the scenario in Hotspot. The service provider charge the wireless service based on usage time. This account allows multiple devices log in at the same time.

- The temporary account has limited usage traffic. The account doesn't have the expiration time until the usage is run out.

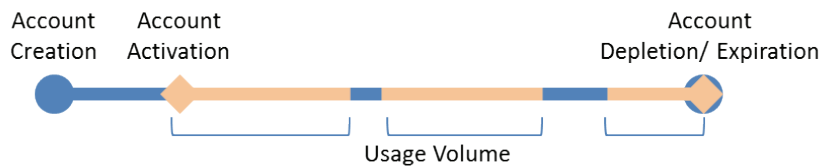

This billing profile is suitable for a Hotspot scenario. The service provider charge the wireless service based on usage volume.

1. Click **Security > Authentication > Billing Profile**.

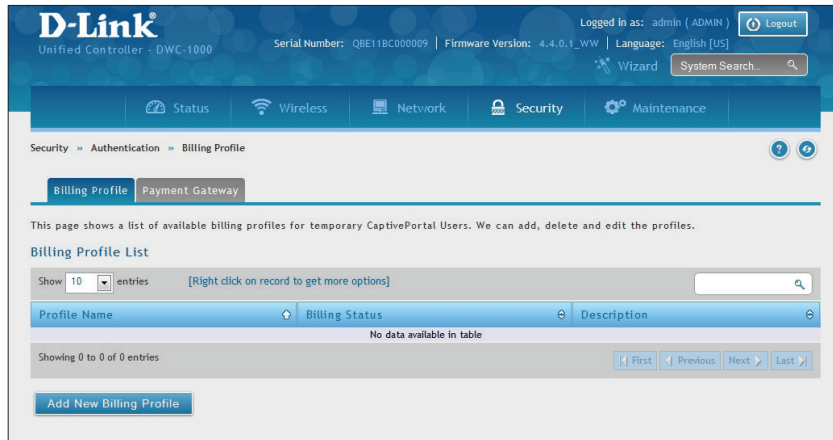

2. Click **Add New Billing Profile**.

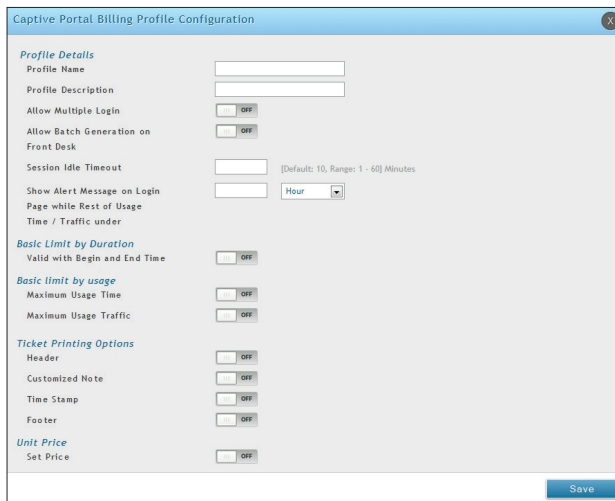

3. Complete the fields in the table below and click **Save**.

Field	Description
Profile Details	
Profile Name	Enter a name for this profile.
Profile Description	Enter a description for this profile.
Allow Multiple Login	Checking this option will allow multiple users to use the same captive portal login credentials created for this profile to login simultaneously.
Allow Batch Generation on Front Desk	Checking this option enables front desk user to generate a batch of temporary captive portal users at one click.
Session Idle Timeout	Idle timeout for CP users generated for this profile.
Show Alert Message on Login Page while Rest of Usage Time/ Traffic Under	Enter a value here in Hours/Days/MB/GB to get an alert message when usage time/ traffic left reaches the desired limit. By default if 0 is entered it implies no alert message is required.

Field	Description
Basic Limit by Duration	
Valid with Begin and End Time	Limitations on Duration basis
Valid Begin	There are 3 types of limiting user access by duration: <ul style="list-style-type: none"> • Start While Account Created: Activate account when user is created • Start While Account Login: Activate account when user first login using his credentials. • Begin From: Activate account from this date
Allow frontdesk to modify duration	Enabling this option enables frontdesk user to modify duration limits.
Basic Limit by Usage	
Maximum Usage Time	Maximum time user can stay logged in before their account expires.
Maximum Usage Traffic	Maximum traffic user can use before his account expires. Only inbound traffic shall be considered towards bandwidth usage.
Allow frontdesk to modify duration	Enabling this option enables frontdesk user to modify usage limits.
Ticket Pricing Options	
Header	Enable this option to set a header value for ticket.
Customized Note	Enable this option to display extra details on ticket like location.
Time Stamp	Enable this option to show the current time on tickets.
Footer	Enable this option to set a value for ticket footer like service provider name.
Unit Price	
Set Price	Enable the option to set the price for this billing profile. The price will be shown on the Captive Portal which is set the Captive Portal Type as Billing User
Price	Enter a price.
Monetary Unit	Select the Monetary Unit from drop down menu. The available options are from the Currency setting on Payment Gateway.

Payment Gateway

Path: Security > Authentication > Billing Profile > Payment Gateway

A payment gateway is an e-commerce application service provider service that authorizes payment and money transfers to be made through the Internet. Configure payment gateway settings to allow user online purchasing wireless service from Captive Portal.

1. Click **Security > Authentication > Billing Profile > Payment Gateway** tab.

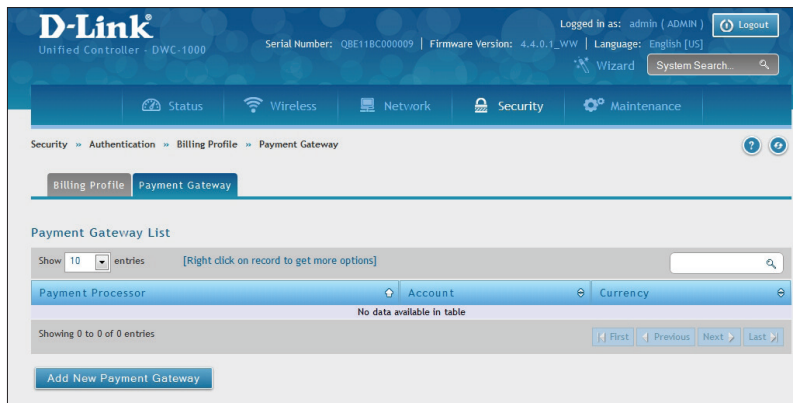

2. Click **Add New Payment Gateway**. Select either Paypal (below) or Authorize.net (refer to the next page)

3. Complete the fields in the table below and click **Save**.

Field	Description
Payment Processor	Select the payment agent (Paypal).
Paypal	
Payment Receiver Email ID	Enter your Paypal account email used for receiving payments.
API Username	Enter the API username of the Paypal Premier/Business/Website Payment Pro account.
API Password	Enter the API password of the Paypal account.
API Signature	Enter the API signature of the Paypal Premier/Business/Website Payment Pro account.
APP ID	Enter the APP ID which Paypal provided to you.
Currency	Select the currency type.

Field	Description
Payment Processor	Select the payment agent (Authorize.net).
Paypal	
Login ID	Enter the API account ID used for receiving payments.
Transaction Key	Enter your transaction key.
MD5 Hash	Enter your MD5 Hash value.
Transaction Server	Live is selected.
Transaction Mode	Select Live or Test .
Currency	Select the currency type.

Login Profiles

When a wireless client connects to the SSIDs of access point or VLANs, the user sees a login page. The Login Profile and SLA page allows you to customize the appearance of that page with specific text and images. The wireless controller supports multiple login and SLA pages. Associate login page or SLAs on SSIDs or VLANs separately.

Customize the Captive Portal Login Page

Path: Security > Authentication > Login Profiles > Login Profiles

1. Go to **Security > Authentication > Login Profiles > Login Profiles** tab.

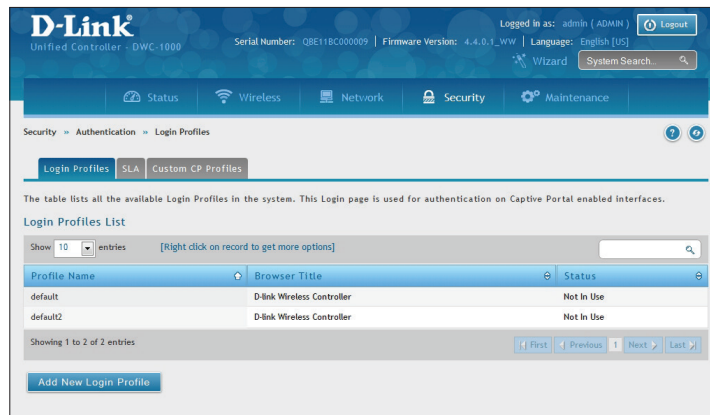

2. Click **Add New Login Profile**.

General Details

Profile Name:

Browser Title:

Background: Image Color

Page Background Image:

Default:

Header Details

Background: Image Color

Header Background Image:

Default:

Header Caption

Caption Font:

Caption Font:

Font Size:

Font Color:

Login Details

Login Section Title:

Welcome Message:

Error Message:

Footer Details

Change Footer Content:

Footer Content:

Footer Font Color:

External Payment Gateway

Enable External Payment Gateway:

Session Title 1:

Message:

Session Title 2:

Success Message:

Session Title 3:

Failure Message:

Enable Billing Profiles

Profile Name	Billing Status	Description	Status
No data available in table			

Service Disclaimer Text:

Payment Server:

3. Complete the fields in the table on the next page and click **Save**.

Field	Description
General Details	
Profile Name	Enter a name for this captive portal profile. The name should allow you to differentiate this captive profile from others you may set up.
Browser Title	Enter the text that will appear in the title of the browser during the captive portal session.
Background	Select whether the login page displayed during the captive portal session will show an image or color. Choices are: <ul style="list-style-type: none"> • Image = displays an image as the background on the page. Use the Page Background Image field to select a background image. • Color = sets the background color on the page. Select the color from the drop-down menu
Page Background Image	If you set <i>Background</i> to Image , upload the image file by clicking Add > Browse . Select an image, click Open and then click the Upload button. The maximum size of the image is 100 kb.
Page Background Upload	Choose the file you want to upload.
Page Background Color	If you set <i>Background</i> to Color , select the background color of the page that will appear during the captive portal session from the drop-down menu.
Custom Color	If you choose Custom on Page Background Color, enter the HTML color code.
Header Details	
Background	Select whether the login page displayed during the captive portal session will show an image or color. Choices are: <ul style="list-style-type: none"> • Image = show image on the page. Use the Header Background Color field to select a background color. The maximum size of the image is 100 kb. • Color = show background color on the page. Use the radio buttons to select an image.
Header Background Image	If you set <i>Background</i> to Image , upload the image file by clicking Add > Browse . Select an image, click Open and then click the Upload button. The maximum size of the image is 100 kb.
Header Background Upload	Choose the file you want to upload.
Header Background Color	If you set <i>Background</i> to Color , select the header color from the drop-down menu.
Custom Color	If you choose Custom on Page Background Color, you can choose particular color by filling in the HTML color code.
Header Caption	Enter the text that appears in the header of the login page during the captive portal session.
Caption Font	Select the font for the header text.
Font Size	Select the font size for the header text.
Font Color	Select the font color for the header text.

Field	Description
Login Details	
Login Section Title	Enter the text that appears in the title of the login box when the user logs in to the captive portal session. This field is optional.
Welcome Message	Enter the welcome message that appears when users log in to the captive session successfully. This field is optional.
Error Message	Enter the error message that appears when users fail to log in to the captive session successfully. This field is optional.
Footer Details	
Change Footer Content	Enables or disables changes to the footer content on the login page.
Footer Content	If Change Footer Content is checked, enter the text that appears in the footer.
Footer Font Color	If Change Footer Content is checked, select the color of the text that appears in the footer.
External Payment Gateway	
Enable External Payment Gateway	Enables or disables external payment gateway and online wireless service purchasing from on the login page.
Session Title 1	Enter the text that appears in the title of the online purchasing login box when the user logs in to the captive portal session.
Message	Enter the text appears in the online purchasing login box when the user logs in to the captive portal session.
Session Title 2	Enter the text that appears in the title of the message box while online purchasing is complete.
Success Message	Enter the text that appears in the message box while online purchasing is complete.
Session Title 3	Enter the text that appears in the title of the message box while online purchasing is fail.
Failure Message	Enter the text that appears in the message box while online purchasing is fail.
Enable Billing Profile	Select the billing profile which will be shown on the login page. The table only listed the billing profiles which are set Unit Price. Enable the billing profile by switch ON on STATUS.
Service Disclaimer Text	Enter the service disclaimer text which is shown before user select and purchase wireless service.
Payment Server	Select the payment received account and its payment agent.

Customize the SLA of the Captive Portal

Path: Security > Authentication > Login Profiles > SLA

1. Go to **Security > Authentication > Login Profiles > SLA** tab.

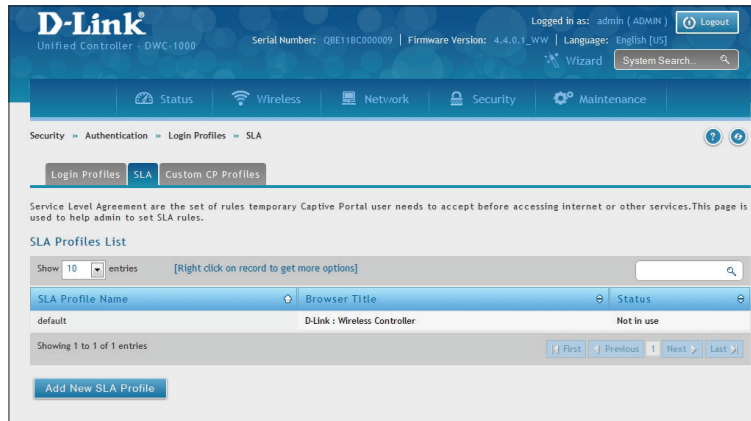

2. Click **Add New SLA Profile**.

3. Complete the fields in the table below and click **Save**

Field	Description
SLA Profile Name	Enter a name for this SLA profile. The name should allow you to differentiate this SLA from others you may set up.
Browser Title	Enter the text that will appear in the title of the browser during the captive portal session.
Term of Service Rule	Shows the set of rules on Captive Portal which is set for temporary and SLA type users. The user needs to accept before accessing internet.

Upload a Custom Profile

Path: Security > Authentication > Login Profiles > Custom CP Profile

1. Go to **Security > Authentication > Login Profiles > Custom CP Profiles** tab.
2. Click **Browse** and select a saved profile. Click **Save**.

The screenshot displays the D-Link Unified Controller web interface. At the top, the D-Link logo and 'Unified Controller - DWC-1000' are visible. The user is logged in as 'admin (ADMIN)' with a 'Logout' button. System information includes 'Serial Number: QBE11BC000009', 'Firmware Version: 4.4.0.1_WW', and 'Language: English [US]'. A 'Wizard' icon and a 'System Search...' field are also present. The main navigation bar includes 'Status', 'Wireless', 'Network', 'Security', and 'Maintenance'. A blue banner indicates 'No Custom Profile is uploaded!'. Below this, the 'Custom CP Profiles' tab is selected. The 'Upload Custom CP Profile' section contains a 'Browse Custom CP file' label, a 'Browse...' button (with 'No file selected.' text), and a 'Save' button. The 'Custom Profiles List' section shows a table with columns 'Custom Profile Name' and 'Status', and a single row containing 'No Custom Profile'.

Custom Profile Name	Status
No Custom Profile	

RADIUS Accounting Global Setting

Path: Security > Authentication > RADIUS Accounting Global Setting

This page is used to view and configure various global parameters for the RADIUS Accounting server configured on the system. Use Accounting Mode to enable/disable accounting globally for configured SSID's.

To configure the global settings:

1. Go to **Security > Authentication > RADIUS Accounting Global Setting** tab.

The screenshot shows the 'RADIUS Accounting Global Setting' configuration page. At the top, there is a navigation bar with tabs for Status, Wireless, Network, VPN, Security, and Maintenance. Below the navigation bar, the breadcrumb path is 'Security >> Authentication >> External Auth Server >> Radius Accounting Global Setting'. A descriptive paragraph states: 'This page is used to view and configure various global parameters for the RADIUS Accounting server configured on the system. Use Accounting Mode to enable/disable accounting globally for configured SSID's.' The main configuration area is titled 'Radius Accounting Global Configuration' and contains three settings: 'Accounting Mode' with a toggle set to 'ON', 'Accounting Interim Update Mode' with a toggle set to 'ON', and 'Radius Accounting Interim Interval' with a text input field containing '350' and a range indicator '[Range: 300 - 3600] Seconds'. At the bottom of the configuration area are 'Save' and 'Cancel' buttons.

2. Complete the information from the table below and click **Save**.

Field	Description
Accounting Mode	Toggle to ON to enable the RADIUS accounting mode. By default it is disabled.
Accounting Interim Update Mode	Toggle to ON to send Radius Accounting (Interim-Update) based on Interim Interval Period. By default this mode is disabled.
Radius Accounting Interim Interval	The interim Interval at which Radius Accounting (Interim-Update) packets should be sent by the controller. The value should be in the range 300 - 3600. By default, it is not configured.
Save	Saves the settings.

External Authentication

The local user database present in the controller itself is typically used for granting management access for the GUI or CLI. External authentication servers are typically more secure, and can be used for allowing wireless AP connections, authenticating IPSec endpoints, and even allowing access via a Captive Portal on the VLAN. This section describes the available authentication servers on the controller, and also the configuration requirements. In all cases, the "Server Checking" button is used to verify connectivity to the configured server(s).

Configure RADIUS Server

Path: Security > Authentication > External Auth Server > RADIUS Server

Enterprise Mode for wireless security uses a RADIUS Server for WPA and/or WPA2 security. A RADIUS server must be configured and accessible by the controller to authenticate wireless client connections to an AP enabled with a profile that uses RADIUS authentication.

- The Authentication IP Address is required to identify the server. A secondary RADIUS server provides redundancy in the event that the primary server cannot be reached by the controller when needed.
- Authentication Port - The port for the RADIUS server connection
- Secret - Enter the shared secret that allows this controller to log into the specified RADIUS server(s). This key must match the shared secret on the RADIUS Server.
- The Timeout and Retries fields are used to either move to a secondary server if the primary cannot be reached, or to give up the RADIUS authentication attempt if communication with the server is not possible.

To configure RADIUS Server:

1. Go to **Security > Authentication > External Auth Server > RADIUS Server** tab.

The screenshot displays the D-Link Unified Controller web interface. The top navigation bar shows 'Security > Authentication > External Auth Server > RADIUS Server'. Below this, there are tabs for 'Radius Server', 'Radius Accounting', 'POP3 Server', 'POP3 Trusted CA', 'LDAP Server', 'AD Server', and 'NT Domain'. The main content area is titled 'Radius Server Configuration' and contains a 'Server Check' section with a 'Server Checking' button. The configuration fields are as follows:

Field	Value	Range
Authentication Server 1 IP Address	192.168.1.2	
Authentication Port	1812	[Range: 0 - 65535]
Secret	*****	
Timeout	1	[Range: 1 - 999] Seconds
Retries	2	[Range: 1 - 9] Seconds
Authentication Server 2 IP Address	192.168.1.3	
Authentication Port	1812	[Range: 0 - 65535]
Secret	*****	
Timeout	1	[Range: 1 - 999]
Retries	2	[Range: 1 - 9]
Authentication Server 3 IP Address	192.168.1.4	
Authentication Port	1812	[Range: 0 - 65535]
Secret	*****	
Timeout	1	[Range: 1 - 999]
Retries	2	[Range: 1 - 9]

At the bottom of the configuration area, there are 'Save' and 'Cancel' buttons.

2. Complete the RADIUS server information from the table below and click **Save**.

Field	Description
Authentication Server	IP address of the RADIUS authentication server.
Authentication Port	RADIUS authentication server port to send RADIUS messages.
Secret	Secret key that allows the device to log into the configured RADIUS server. It must match the secret on the RADIUS server.
Timeout	Set the amount of time in seconds, the controller should wait for a response from the RADIUS server.
Retries	This determines the number of tries the controller will make to the RADIUS server before giving up.

Configure RADIUS Accounting

Path: Security > Authentication > External Auth Server > RADIUS Server

You can configure the state of the specified RADIUS accounting service here.

To configure RADIUS Server:

1. Go to **Security > Authentication > External Auth Server > RADIUS Accounting** tab.

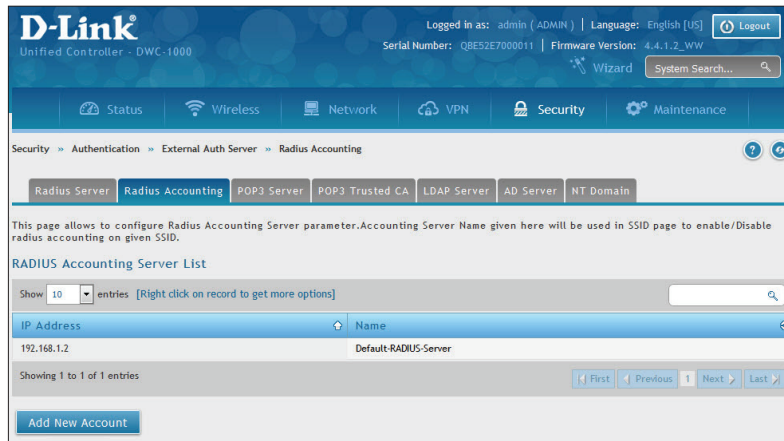

2. Click **Add New Account**. Complete the information from the table below and click **Save**.

RADIUS Accounting Server Configuration

Accounting Server IP Address:

Accounting Server Name:

Port: [Range: 1 - 65535] Seconds

Secret:

Field	Description
Accounting Server IP Address	IP address of the RADIUS accounting server.
Accounting Server Name	Enter a name for the server.
Port	Enter the port to use.
Secret	Secret key that allows the device to log into the configured RADIUS server.

Configure POP3 Server

Path: Security > Authentication > External Auth Server > POP3 Server

POP3 is an application layer protocol most commonly used for e-mail over a TCP/IP connection. The authentication server can be used with SSL encryption over port 995 to send encrypted traffic to the POP3 server. The POP3 server's certificate is verified by a user-uploaded CA certificate. If SSL encryption is not used, port 110 will be used for the POP3 authentication traffic.

The wireless controller acts only as a POP3 client to authenticate a user by contacting an external POP3 server. This authentication option is available for IPSec, PPTP/L2TP Server and Captive Portal users. Note that POP3 for PPTP / L2TP servers is supported only with PAP and not with CHAP / MSCHAP / MSCHAPv2 encryption.

To configure your POP3 Server:

1. Go to **Security > Authentication > External Auth Server > POP3 Server** tab.

The screenshot shows the 'POP3 Server Configuration' page in the D-Link Unified Controller. The page has a blue header with the D-Link logo and navigation tabs for Status, Wireless, Network, VPN, Security, and Maintenance. The breadcrumb path is Security > Authentication > External Auth Server > POP3 Server. Below the breadcrumb are tabs for RADIUS Server, RADIUS Accounting, POP3 Server (selected), POP3 Trusted CA, LDAP Server, AD Server, and NT Domain. The main content area is titled 'POP3 Server Configuration' and contains the following fields:

- Server Check:** A button labeled 'Server Checking'.
- Authentication Server1 (Primary):** An empty text input field.
- Authentication Port:** A text input field containing '110' with a default value of 110 and a range of 1 - 65535.
- SSL Enable:** A toggle switch set to 'OFF'.
- Authentication Server2 (Secondary):** An empty text input field, marked as 'Optional'.
- Authentication Port:** A text input field containing '110' with a default value of 110 and a range of 1 - 65535.
- SSL Enable:** A toggle switch set to 'OFF'.
- Authentication Server3:** An empty text input field, marked as 'Optional'.
- Authentication Port:** A text input field containing '110' with a default value of 110 and a range of 1 - 65535.
- SSL Enable:** A toggle switch set to 'OFF'.
- Timeout:** An empty text input field, marked as '(Second)'.
- Retries:** An empty text input field.

At the bottom of the form are 'Save' and 'Cancel' buttons.

2. Complete the fields in the table below and click **Save**.

Field	Description
Authentication Server	IP address of the POP3 authentication server.
Authentication Port	RADIUS authentication server port to send POP3 messages.
SSL Enable	Enable SSL support for POP3. If this option is enabled, it is mandatory to select a certificate authority for it.
CA File	Certificate Authority to verify POP3 server's certificate.
Timeout	Set the amount of time in seconds, the controller should wait for a response from the POP3 server.
Retries	This determines the number of tries the controller will make to the POP3 server before giving up.

Configure POP3 Trusted CA

Path: Security > Authentication > External Auth Server > POP3 Trusted CA

A CA file is used as part of the POP3 negotiation to verify the configured authentication server identity. Each of the three configured servers can have a unique CA used for authentication.

1. Go to **Security > Authentication > External Auth Server > POP3 Trusted CA** tab.

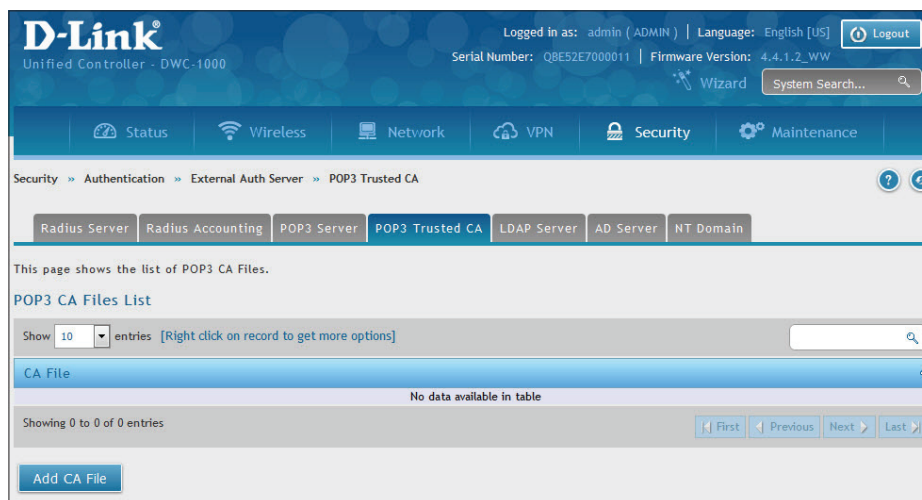

2. Click **Add CA File** to add a CA file.

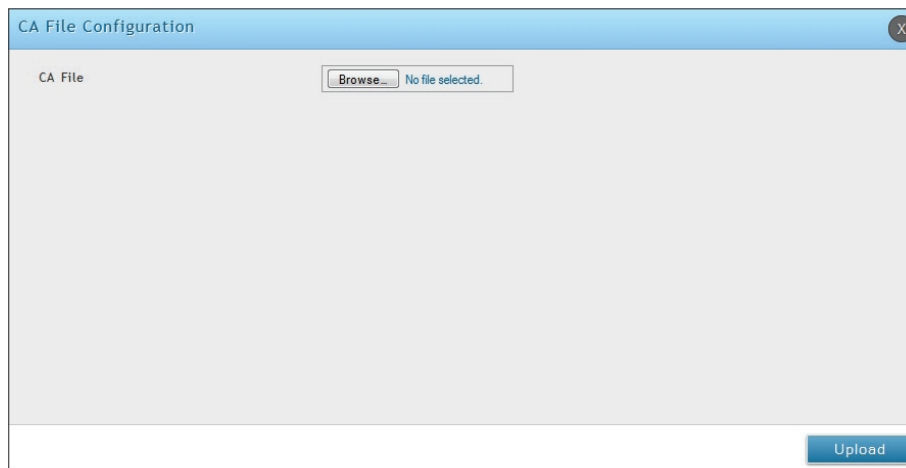

3. Click **Browse** to select a CA file. Once selected, click **Save**.

Configure LDAP Server

Path: Security > Authentication > External Auth Server > LDAP Server

The LDAP authentication method uses LDAP to exchange authentication credentials between the controller and external server. The LDAP server maintains a large database of users in a directory structure, so users with the same username but belonging to different groups can be authenticated since the user information is stored in a hierarchal manner. Note that configuring a LDAP server on Windows or Linux servers is considerably less complex than setting up NT Domain or Active Directory servers for user authentication.

The details configured on the controller will be passed for authenticating the controller and its hosts. The LDAP attributes, domain name (DN), and in some cases the administrator account & password are key fields in allowing the LDAP server to authenticate the controller.

To configure your LDAP Server:

1. Go to **Security > Authentication > External Auth Server > LDAP Server** tab.

The screenshot shows the D-Link Unified Services Router configuration interface. The breadcrumb path is Security > Authentication > External Auth Server > LDAP Server. The page title is "LDAP Server" and it includes a "Server Checking" button. Below this are fields for LDAP Attribute 1 through 4 (all optional), Timeout (10 seconds), Retries (2), and Idle Timeout (10 seconds). At the bottom, there is a "LDAP Server List" table with 3 entries and an "Add New LDAP Server" button.

Name	IP Address
Default-LDAP-Server1	192.168.1.1
Default-LDAP-Server2	192.168.1.2
Default-LDAP-Server3	192.168.1.3

2. Complete the fields given in the table on the next page, and click **Save**.

Field	Description
LDAP Server Settings	
Server Check	Checks status of configured servers, it checks whether servers are up or not.
LDAP Attribute 1-4	These are attributes related to LDAP users configured in LDAP server. These may include attributes like SAM account name, Associated domain name etc. These can be used to distinguish between different users having same user name.
LDAP Base DN	LDAP authentication requires the base domain name; contact your administrator for the Base DN to use LDAP authentication for this domain.
Timeout	Set the amount of time in seconds, the controller should wait for a response from the LDAP server.
Retries	This determines the number of tries the controller will make to the LDAP server before giving up.
Administrator Account	Admin account in LDAP server that will be used when LDAP authentication is required for PPTP/L2TP connection.
Password	Enter the admin password.
LDAP Server List	
Name	Displays the names of the LDAP Servers.
IP Address	The IP address of the respective LDAP Server is also displayed.

Configure Active Directory Server

Path: Security > Authentication > External Auth Server > AD Server

Active Directory authentication is an enhanced version of NT Domain authentication. The Kerberos protocol is leveraged for authentication of users, who are grouped in Organizational Units (OUs). In particular the Active Directory server can support more than a million users given its structure while the NT Domain server is limited to thousands.

The configured Authentication Servers and Active Directory domain(s) are used to validate the user with the directory of users on the external Windows based server. This authentication option is common for SSL VPN client users and is also useful for IPSec / PPTP / L2TP client authentication.

To configure your AD Server:

1. Go to **Security > Authentication > External Auth Server > AD Server** tab.

The screenshot shows the D-Link Unified Controller web interface. The top navigation bar includes Status, Wireless, Network, VPN, Security, and Maintenance. The current path is Security > Authentication > External Auth Server > AD Server. The 'AD Server' tab is selected. The page title is 'Active Directory Configuration'. Below the title, there is a 'Server Check' section with a 'Server Checking' button. The configuration fields are as follows:

Field	Description
Authentication Server 1	IP address of the AD authentication server.
Authentication Server 2	Optional
Authentication Server 3	Optional
Active Directory Domain	Since Active Directory is the chosen authentication type, you must enter the Active Directory domain name in this field. Users that are registered in the Active Directory database can now access the SSL VPN portal by using their Active Directory username and password.
Second Active Directory Domain	Optional
Third Active Directory Domain	Optional
Timeout	Set the amount of time in seconds that the controller should wait for a response from the AD server. (Range: 1 - 999) Seconds
Retries	This determines the number of tries the controller will make to the AD server before giving up. (Range: 1 - 9)

Buttons for 'Save' and 'Cancel' are located at the bottom of the configuration area.

2. Complete the AD server information from the table below and click **Save**.

Field	Description
Authentication Server	IP address of the AD authentication server.
Active Directory Domain	Since Active Directory is the chosen authentication type, you must enter the Active Directory domain name in this field. Users that are registered in the Active Directory database can now access the SSL VPN portal by using their Active Directory username and password.
Timeout	Set the amount of time in seconds that the controller should wait for a response from the AD server.
Retries	This determines the number of tries the controller will make to the AD server before giving up.

Configure NT Domain Server

Path: Security > Authentication > External Auth Server > NT Domain

The NT Domain server allows users and hosts to authenticate themselves via a pre-configured Workgroup field. Typically Windows or Samba servers are used to manage the domain of authentication for the centralized directory of authorized users.

To configure your NT Domain Server:

1. Go to **Security > Authentication > External Auth Server > NT Domain** page.

The screenshot shows the D-Link Unified Controller web interface. The top navigation bar includes Status, Wireless, Network, VPN, Security, and Maintenance. The breadcrumb trail is Security > Authentication > External Auth Server > NT Domain. The configuration page is titled "NT Domain Configuration" and contains the following fields:

- Server Check:** A button labeled "Server Checking".
- Authentication Server 1:** A text input field.
- Authentication Server 2:** A text input field with "Optional" to its right.
- Authentication Server 3:** A text input field with "Optional" to its right.
- Workgroup:** A text input field.
- Second Workgroup:** A text input field with "Optional" to its right.
- Third Workgroup:** A text input field with "Optional" to its right.
- Timeout:** A text input field with "[Range: 1 - 999] Seconds" to its right.
- Retries:** A text input field containing the value "2" with "[Range: 1 - 9] Seconds" to its right.

At the bottom of the form are "Save" and "Cancel" buttons.

2. Complete the NT Domain server information from the table below and click **Save**.

Field	Description
Authentication Server	Enter the IP address of the NT Domain server.
Workgroup	Enter the Workgroup for the Authentication Server.
Timeout	Set the amount of time in seconds that the controller should wait for a response from the NT Domain server.
Retries	This determines the number of tries the controller will make to the NT Domain server before giving up.

Facebook Wi-Fi

Path: Security > Authentication > Facebook WiFi

Facebook Wi-Fi is a feature that turns your business into a Wi-Fi hotspot by allowing the user to access free Wi-Fi simply by checking in to his/her business page on Facebook. Facebook WiFi authentication uses the Facebook service to authenticate the users by defining some requirements on the gateway.

To use this feature, the user is expected to have created a page for the business which can be selected after login to Facebook and the controller should be registered with Facebook so that the users can be directed to your facebook page when accessing the network.

To configure:

1. Go to **Security > Authentication > Facebook WiFi**.

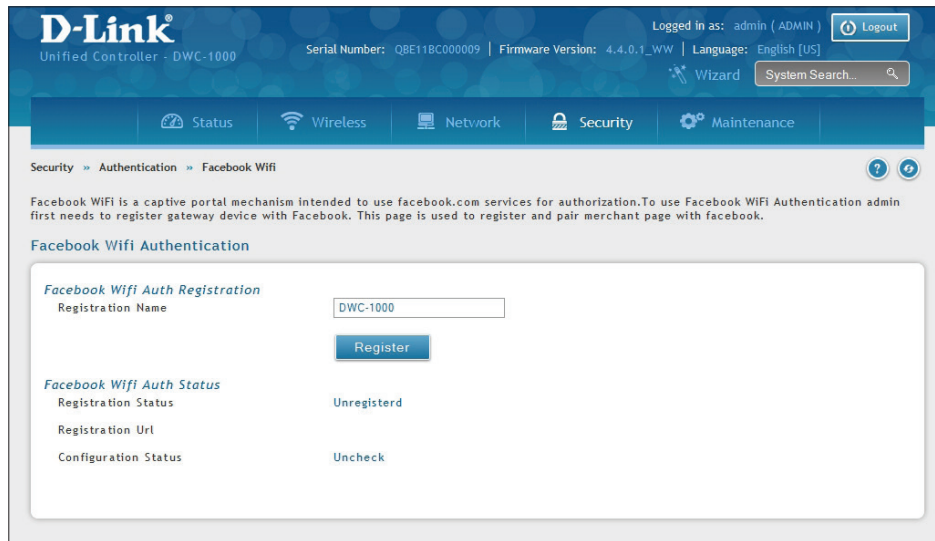

2. Enter the Registration Name, and then click **Register**.

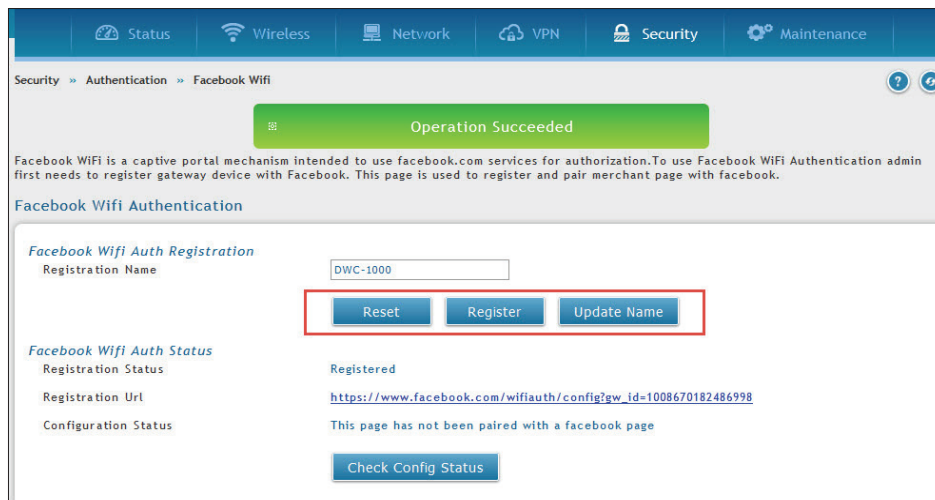

3. Once the device is registered, the screen shown above appears.

4. The information about the fields present on the screen are given in the table below.

Field	Description
Facebook WiFi Auth Registration	
Registration Name	Enter the name you want to register. The default is DWC-1000.
Reset	Resets the Facebook WiFi registration.
Register	This is used to register gateway device with Facebook.
Update Name	Registers gateway device with a new name.
Facebook WiFi Auth Status	
Registration Status	Displays whether the controller is registered with Facebook or not.
Registration URL	Once the controller are registered, you must pair your merchant page with the Registration Url.
Configuration Status	Displays whether the controller is paired with the merchant page or not.
Check Config Status	Checks pairing of the gateway device with the merchant page.

Email Configuration

Path: Security > Authentication > Email Configuration

Using this feature of email configuration, the user is allowed to configure the SMTP server to email the captive portal user credentials from the controller.

To configure:

1. Go to **Security > Authentication > Email Configuration**.

The screenshot shows the 'Email Configuration' page in the D-Link DWC-1000 web interface. The page title is 'Email Configuration' and it includes a breadcrumb trail: 'Security >> Authentication >> Email Configuration'. A description states: 'This page allows user to configure the SMTP Server to email the captive portal user credentials from the controller.' The configuration fields are:

- E-Mail Server Address:** A text input field.
- SMTP Port:** A text input field with a range indicator '[Range: 1 - 65535]'.
- Return E-Mail Address:** A text input field.
- Authentication with SMTP:** Three radio button options: 'None' (selected), 'Plain Login', and 'CRAM-MD5'.
- Respond to Identd from SMTP:** A toggle switch currently set to 'ON'.

At the bottom of the form are two buttons: 'Save' and 'Cancel'.

2. Fill-in the fields shown in the table below.

Field	Description
E-mail Server Address	Enter the IP address or Internet Name of an SMTP server. The controller will connect to this server to send captive portal user credentials.
SMTP Port	Enter the SMTP port of the e-mail server.
Return E-mail address	Type the e-mail address where the replies from the SMTP server are to be sent (required for failure messages).
Authentication with SMTP	If the SMTP server requires authentication before accepting connections, select either Login Plain or CRAM-MD5 and enter the User Name and Password to be used for authentication. To disable authentication, select None .
Respond to Identd from SMTP	Toggle it ON to configure the controller to respond to an IDENT request from the SMTP server.
Save	Saves the settings.

Web Content Filter

The controller offers some standard web filtering options to allow you to easily create internet access policies between the secure LAN and insecure WAN. Instead of creating policies based on the type of traffic (as is the case when using firewall rules), web-based content itself can be used to determine if traffic is allowed or dropped.

Static Filtering

Path: Security > Web Content Filter > Static Filtering

Content filtering must be enabled to configure and use the subsequent features (list of Trusted Domains, filtering on Blocked Keywords, etc.). Proxy servers, which can be used to circumvent certain firewall rules and thus a potential security gap, can be blocked for all LAN devices. Java applets can be prevented from being downloaded from internet sites, and similarly the gateway can prevent ActiveX controls from being downloaded via Internet Explorer. For added security cookies, which typically contain session information, can be blocked as well for all devices on the private network.

To configure:

1. Go to **Security > Web Content Filter > Static Filtering**.

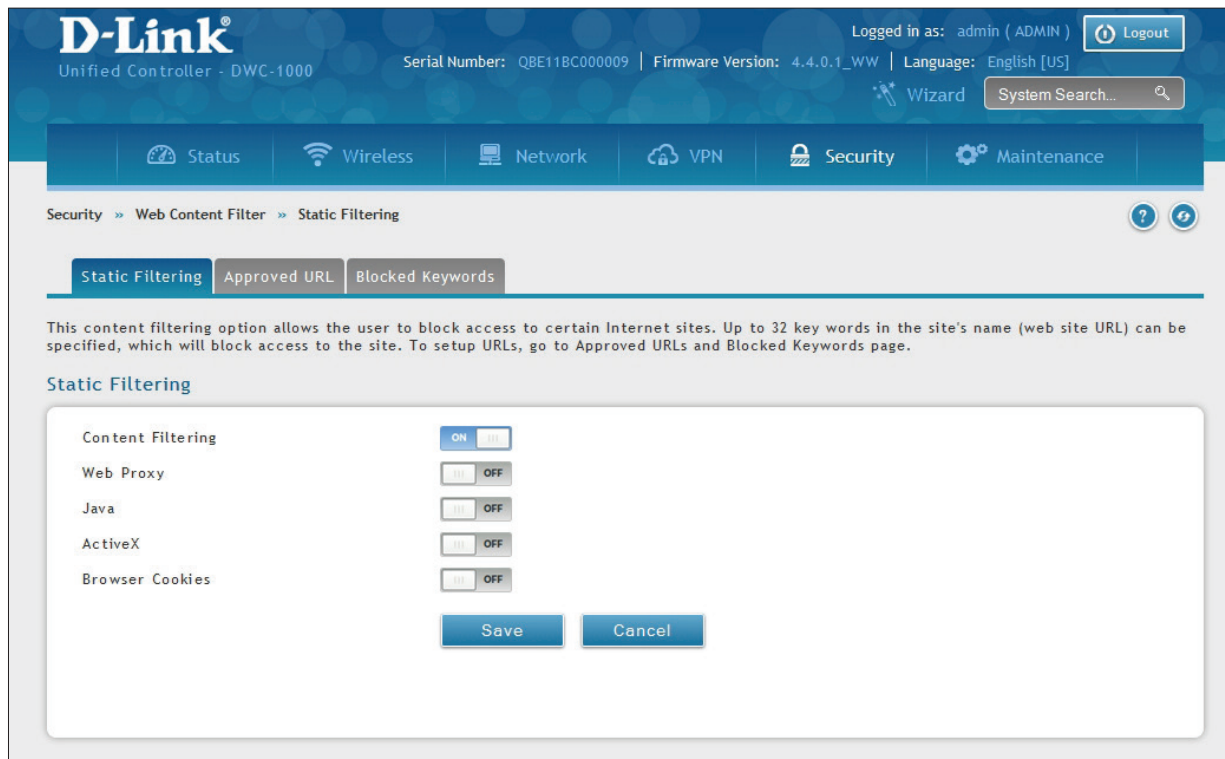

2. Toggle which service you want to filter to **On** and click **Save**.

Approved URLs

Path: Security > Web Content Filter > Static Filtering > Approved URL

The approved URL list is an acceptance list for all URL domain names. Domains added to this list are allowed in any form. For example, if the domain "dlink" is added to this list then all of the following URL's are permitted access from the LAN: www.dlink.com, support.dlink.com, etc.

Importing/exporting from a text or CSV file is also supported.

To specify approved URLs:

1. Go to **Security > Web Content Filter > Static Filtering > Approved URL** tab.

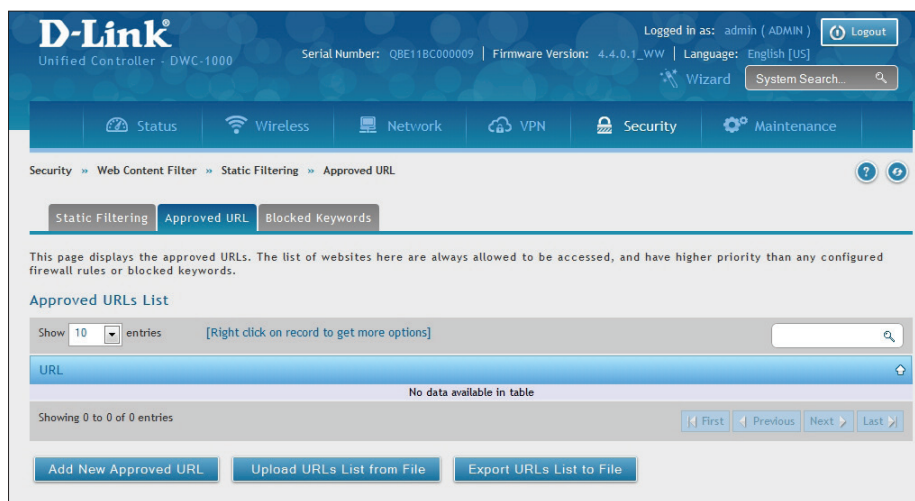

2. To import a list from a text/CSV file, click **Upload URLs List from File**. If you want to export the current list, click **Export URLs List to File**. To add a new URL, click **Add New Approved URL**.

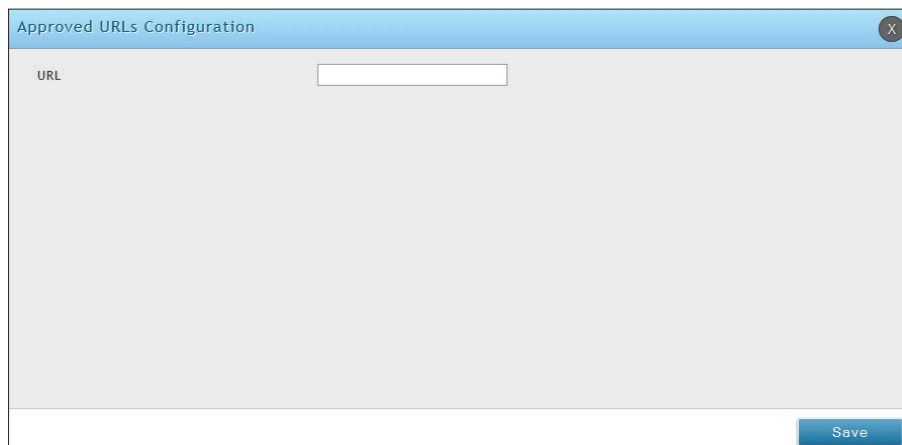

3. Enter a URL and click **Save**.

Blocked Keywords

Path: Security > Web Content Filter > Static Filtering > Blocked Keywords

Keyword blocking allows you to block all website URL's or site content that contains the keywords in the configured list. This is lower priority than the Approved URL List; i.e. if a blocked keyword is present in a site allowed by a trusted domain in the Approved URL List, then access to that site will be allowed. Import/export from a text or CSV file is also supported.

To add/import/export URLs to the approved list:

1. Click **Security > Web Content Filter > Static Filtering > Blocked Keywords** tab.

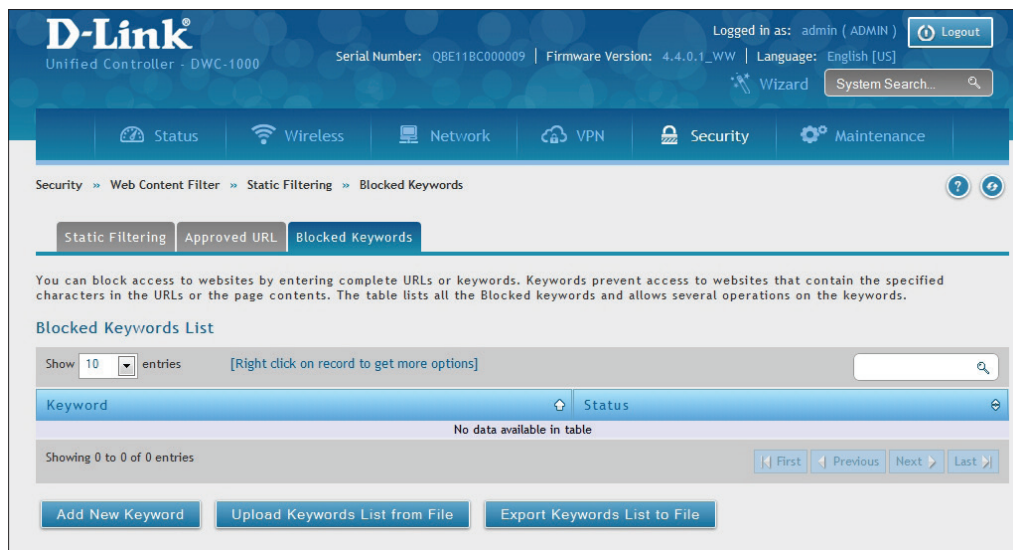

2. To import a list from a text/CSV file, click **Upload Keywords List from File**. If you want to export the current list, click **Export Keywords List to File**. To add a new URL, click **Add New Keyword**.

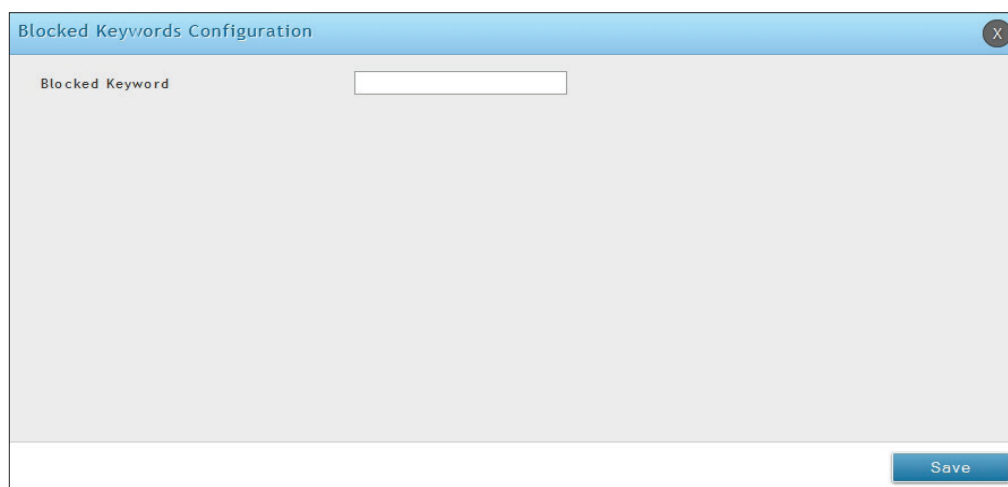

3. Enter a keyword and click **Save**.

Dynamic Filtering

Note: You must activate the DWC-1000-WCF license to access the Dynamic Web Content Filtering option.

Path: Security > Web Content Filter > Dynamic Filtering

This feature allows the administrator to block access from a range of web content categories. The controller must be upgraded with the WCF license, and then the Content Filtering option, which allows the user to filter out internet sites, needs to be enabled.

The Dynamic Content Filtering configuration page will let the administrator choose from a range of pre-defined categories to be blocked. When enabled, access to a website belonging to one of these configured categories will be blocked with an error page.

To configure:

1. Go to **Security > Web Content Filtering > Dynamic Filtering**.

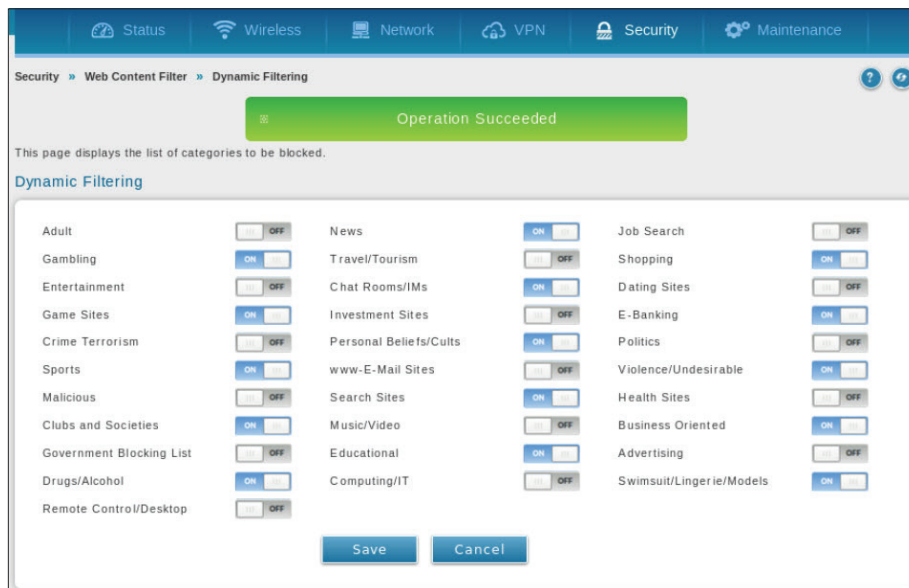

2. Toggle which service you want to filter (refer to the table below) to **On** and click **Save**.

Field	Description
Adult	Sites that host explicit sex content, nudity and sites that use profanity
News	Sites that offer news and information on current events, including newspapers, broadcasters and other publishers
Job Search	Sites that offer job listings, interview coaching and other employment-related services
Gambling	Sites that offer online gambling or information about gambling
Travel/Tourism	Sites with travel and tourism information like city maps and services including planning trips, reservations for bus/train/airlines, hotel booking etc.
Shopping	Online shops, catalogs, auction sites and classified ads etc.
Entertainment	Websites for TV, movies, entertainment news etc., and sites hosting video content of movies, TV streaming etc.
Chatrooms/IM	Social networking sites, chatrooms and instant messaging sites

Field	Description
Dating Sites	Online dating, match-making, relationship advice, personal ads and web pages related to marriage
Game Sites	Sites that offer online games, MORPG and information about computer games, cheat codes etc.
Investment Sites	Sites for brokerages, trusts, insurance and other investments related organizations
E-banking	Sites providing online banking services offered by financial institutions
Crime/Terrorism	Sites providing information on anti-social activities like murder, sabotage, bombing etc.
Personal Beliefs/Cults	Sites about religion, places of worship, religious groups, and occultism
Politics	Sites about politics, elections and legislation and sites that promote a politician or political party
Sports	Sites about sports teams, fan clubs, and generally about all kinds of sports.
Email Sites	Websites that allow users to send and/or receive email through a web accessible email account.

Firewall

Firewall Rules

Note: You must activate the DCS-1000-VPN license to access the firewall options.

Path: Security > Firewall > Firewall Rules

Inbound (Option to LAN/DMZ) rules restrict access to traffic entering your network, selectively allowing only specific outside users to access specific local resources. By default all access from the insecure Option side are blocked from accessing the secure LAN, except in response to requests from the LAN or DMZ. To allow outside devices to access services on the secure LAN, you must create an inbound firewall rule for each service.

If you want to allow incoming traffic, you must make the controller's Option port IP address known to the public. This is called "exposing your host." How you make your address known depends on how the Option ports are configured; for this controller you may use the IP address if a static address is assigned to the Option port, or if your Option address is dynamic a DDNS (Dynamic DNS) name can be used.

Outbound (LAN/DMZ to Option) rules restrict access to traffic leaving your network, selectively allowing only specific local users to access specific outside resources. The default outbound rule is to allow access from the secure zone (LAN) to either the public DMZ or insecure Option. On other hand, the default outbound rule is to deny access from DMZ to insecure Option. When the default outbound policy is allow always, you can block hosts on the LAN from accessing internet services by creating an outbound firewall rule for each service.

To create a new firewall rule:

1. Click **Security > Firewall > Firewall Rules**.

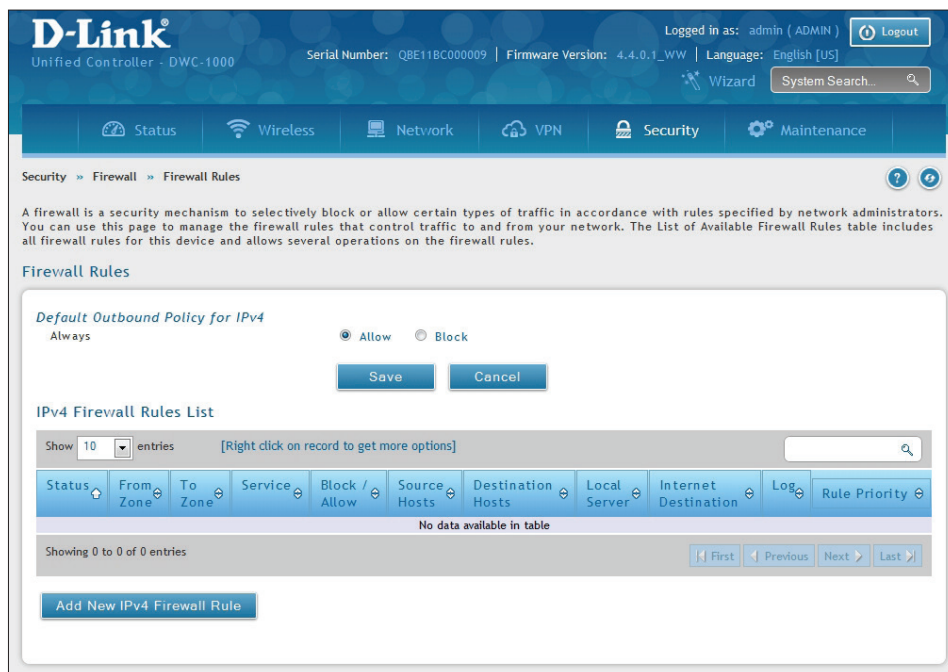

2. Right-click an entry and click either **Edit** or **Delete**. To add a new group, click **Add New IPv4 Firewall Rule**.

The screenshot shows the 'IPv4 Firewall Rules Configuration' window. The settings are as follows:

- From Zone: SECURE (LAN)
- To Zone: INSECURE (Dedicated WAN)
- Service: ANY
- Action: Always Block
- Source Hosts: Any Single Address Address Range
- Destination Hosts: Any Single Address Address Range
- Log: Never Always
- QoS Priority: Normal-Service

A 'Save' button is located at the bottom right of the dialog.

3. Complete the fields from the table below and click **Save**.

Field	Description
From Zone	Select the source of originating traffic: either secure LAN, public DMZ, or insecure Option. For an inbound rule Option should be selected.
To Zone	Select the destination of traffic covered by this rule. If the From Zone is the Option, the To Zone can be the public DMZ or secure LAN. Similarly if the From Zone is the LAN, then the To Zone can be the public DMZ or insecure Option.
Service	Select a service from the drop-down menu. ANY means all traffic is affected by this rule.
Action	Select an action from the drop-down menu.
Source Hosts	Select a source host. If you select Single Address or Address Range, you will need to enter the IP address or IP range.
Destination Hosts	Select a Destination host. If you select Single Address or Address Range, you will need to enter the IP address or IP range.
Log	Select whether to log firewall traffic or not.
QoS Priority (IPv4 only)	Outbound rules (where To Zone = insecure Option only) can have the traffic marked with a QoS priority tag. Select a priority level: <ul style="list-style-type: none"> • Normal-Service: ToS=0 (lowest QoS) • Minimize-Cost: ToS=1 • Maximize-Reliability: ToS=2 • Maximize-Throughput: ToS=4 • Minimize-Delay: ToS=16

Schedules

Path: Security > Firewall > Schedules

Firewall rules can be enabled or disabled automatically if they are associated with a configured schedule. The schedule configuration page allows you to define days of the week and the time of day for a new schedule, and then this schedule can be selected in the firewall rule configuration page.

Note: All schedules will follow the time in the controller's configured time zone. Refer to the section on choosing your Time Zone and configuring NTP servers for more information.

To add a schedule profile:

1. Click **Security > Firewall > Schedules Profiles**.

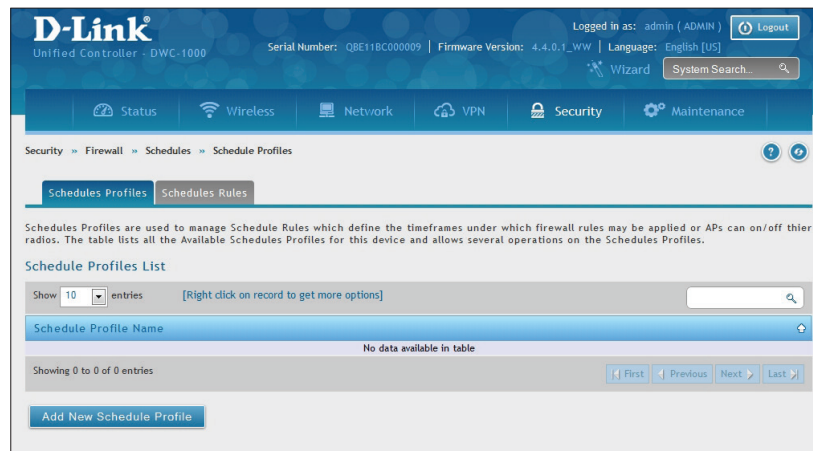

2. Click **Add New Schedule Profile**. Enter a name for the profile and click **Save**.

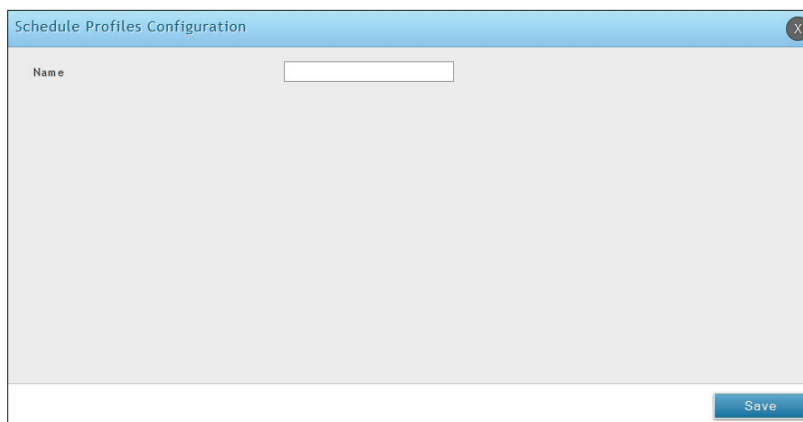

3. Click the **Schedules Rules** tab. Next to *Schedule Name*, select the schedule profile you want to configure.

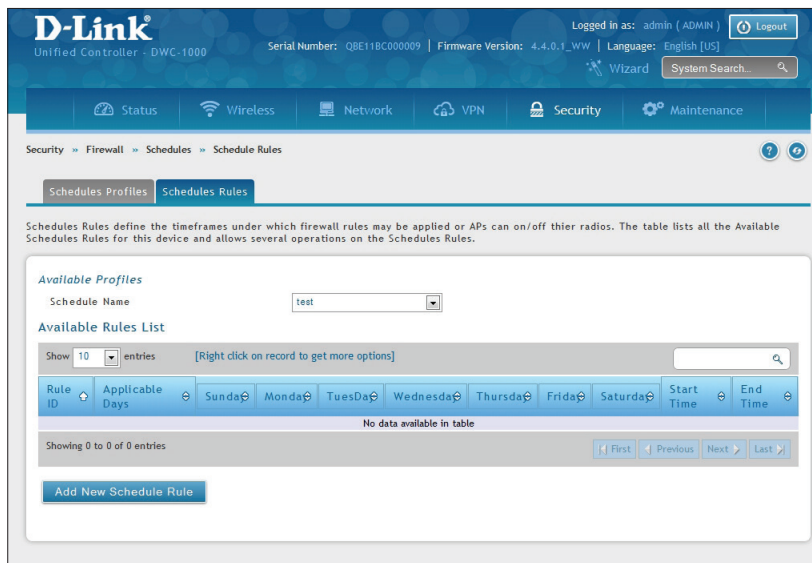

4. Right-click an entry and select either **Edit** or **Delete**, or to add a new schedule rule, click **Add New Schedule**.

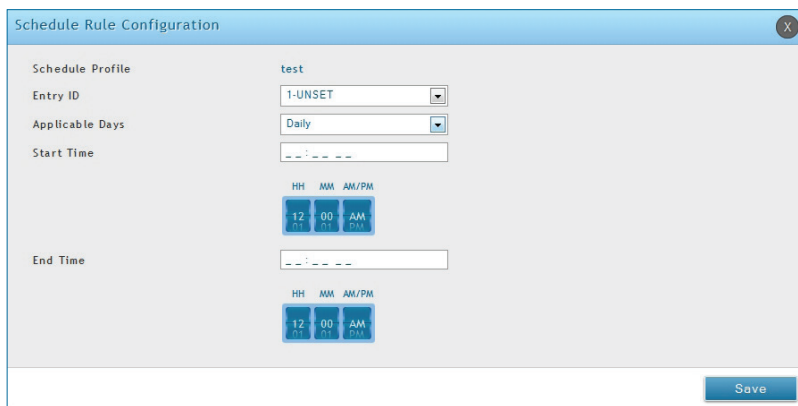

Field	Description
Name	Enter a name for your schedule.
Scheduled Days	Select All Days or Specific Days .
Monday - Sunday	If you selected <i>Specific Days</i> , toggle each day you want to ON .
Scheduled Time of Day	Select All Day or Specific Times .
Start Time/End Time	If you selected <i>Specific Times</i> , use the mouse on the blue boxes representing the hour, minutes, and am/pm to select the start time and end time. Click, hold, and move up to decrease the value or move down to increase the value.
Save	Click to save your settings.

Blocked Clients

Path: Security > Firewall > Blocked Clients

This page displays a list of blocked clients. You may add new clients to block.

To configure blocked clients:

1. Go to **Security > Firewall > Blocked Clients**.

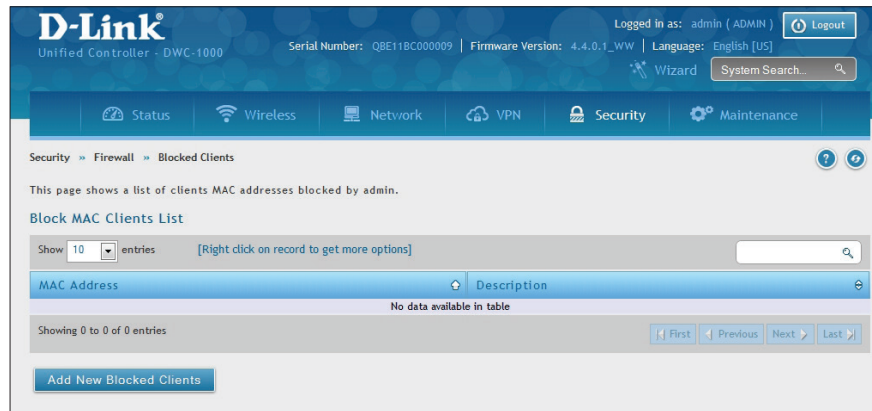

2. Click **Add New Blocked Clients**. Enter the client's MAC address and a description.
3. Click **Save**.

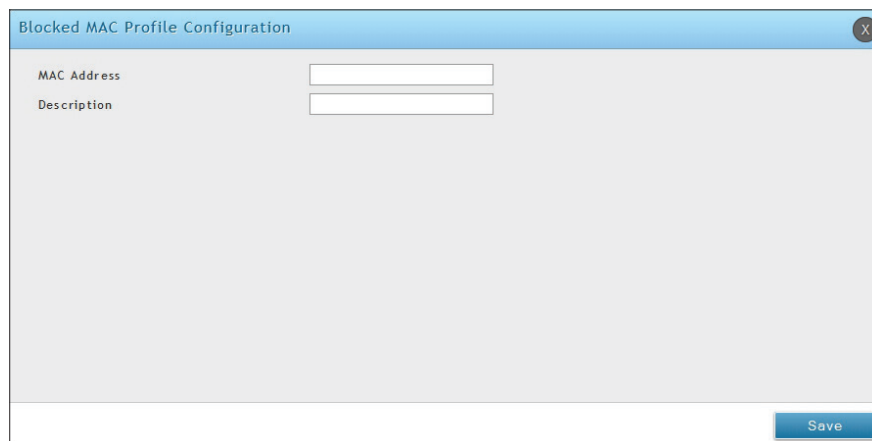

The screenshot shows the 'Blocked MAC Profile Configuration' dialog box. It has a title bar with a close button (X). The form contains two input fields: 'MAC Address' and 'Description'. A 'Save' button is located at the bottom right of the dialog.

Custom Services

Path: Security > Firewall > Custom Services

Custom services can be defined to add to the list of services available during firewall rule configuration. While common services have known TCP/UDP/ICMP ports for traffic, many custom or uncommon applications exist in the LAN or Option. In the custom service configuration menu, you can define a range of ports and identify the traffic type (TCP/UDP/ICMP) for this service. Once defined, the new service will appear in the services list of the firewall rules configuration menu.

To add, delete, or edit a custom service:

1. Click **Security > Firewall > Custom Services**.

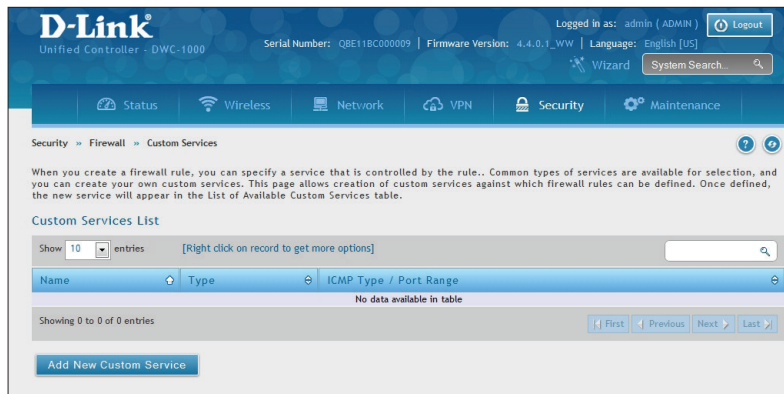

2. Right-click an entry and click either **Edit** or **Delete**. To add a new schedule, click **Add New Custom Service**.

Field	Description
Name	Enter a name for your custom service.
Type	Enter the layer 3 protocol that the service uses (TCP, UDP, BOTH, or ICMP).
Port Type	Select Port Range or Multiple Ports .
Start Port	If you selected Port Range, enter the first (TCP, UDP or BOTH) port of a range that the service uses.
Finish Port	If you selected Port Range, enter the last port of a range that the service uses.
Ports	If you selected Multiple Ports, enter the port or ports separated by a comma.
ICMP Type	The ICMP type is a numeric value that can range between 0 and 40.
Save	Click to save your settings.

ALGs

Path: Security > Firewall > ALGs

Application Level Gateways (ALGs) are security components that enhance the firewall and NAT support of this controller to seamlessly support application layer protocols. In some cases, enabling the ALG will allow the firewall to use dynamic ephemeral TCP/ UDP ports to communicate with the known ports a particular client application (such as H.323 or RTSP) requires, without which the admin would have to open large number of ports to accomplish the same support. Because the ALG understands the protocol used by the specific application that it supports, it is a very secure and efficient way of introducing support for client applications through the controller's firewall.

1. Go to **Security > Firewall > ALGs** page.

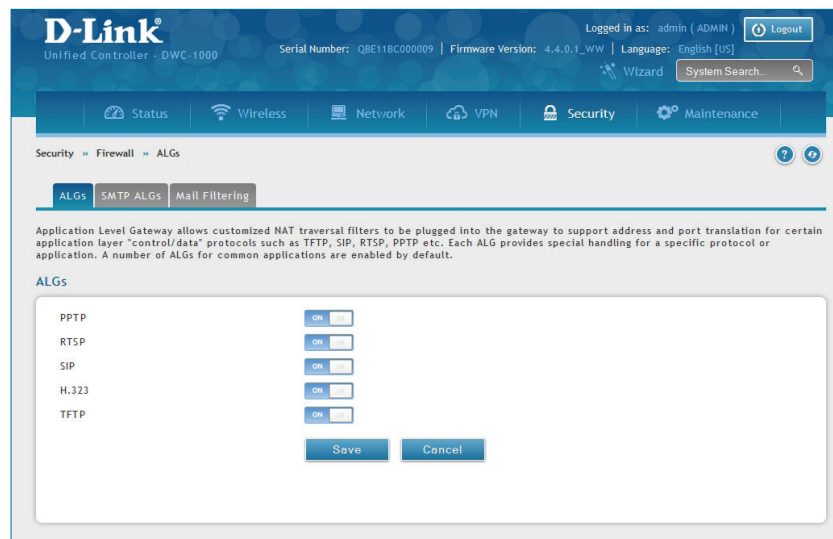

2. Toggle the protocol(s) to **ON** that you want to allow through the controller.

SMTP ALGs

Path: Security > Firewall > ALGs > SMTP ALGs

Simple Mail Transfer Protocol (SMTP) is a text based protocol used for transferring email between mail servers over the Internet. Typically, the local SMTP server will be located on a DMZ so that the mail sent by remote SMTP servers will traverse the controller to reach the local server. Local users will then use email client software to retrieve their email from the local SMTP server. SMTP is also used when clients are sending email and SMTP ALG can be used to monitor SMTP traffic originating from both clients and servers.

1. Click **Security > Firewall > ALGs > SMTP ALGs** tab.

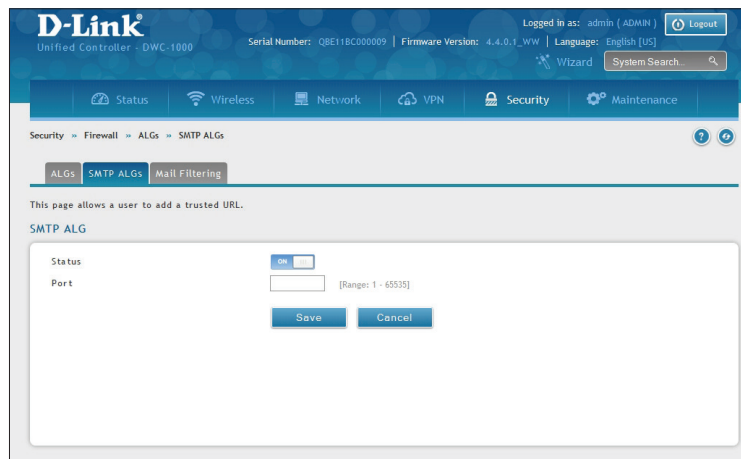

2. Toggle *Status* to **ON**.
3. Enter the port at which the SMTP packets are inspected.
4. Click **Save**.

Mail Filtering

Path: Security > Firewall > ALGs > Mail Filtering

1. Click **Security > Firewall > ALGs > Mail Filtering** tab.

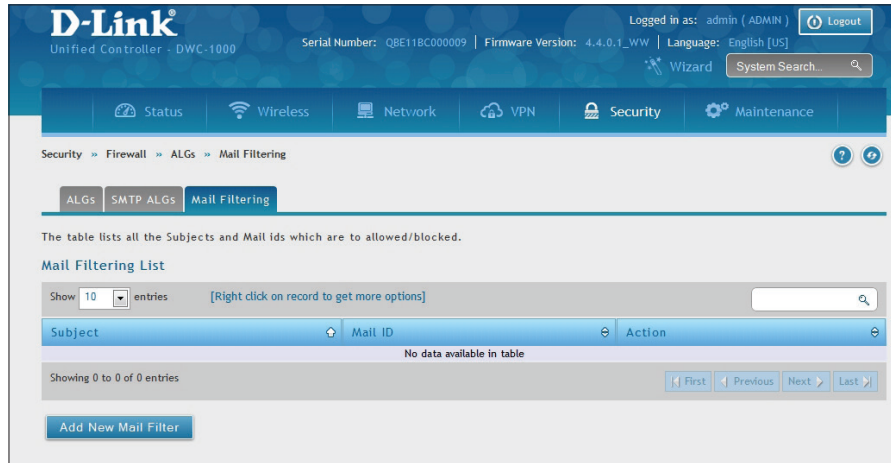

2. Right-click an entry and select either **Edit** or **Delete**. To add a new mail ID, click **Add New Mail Filter**.

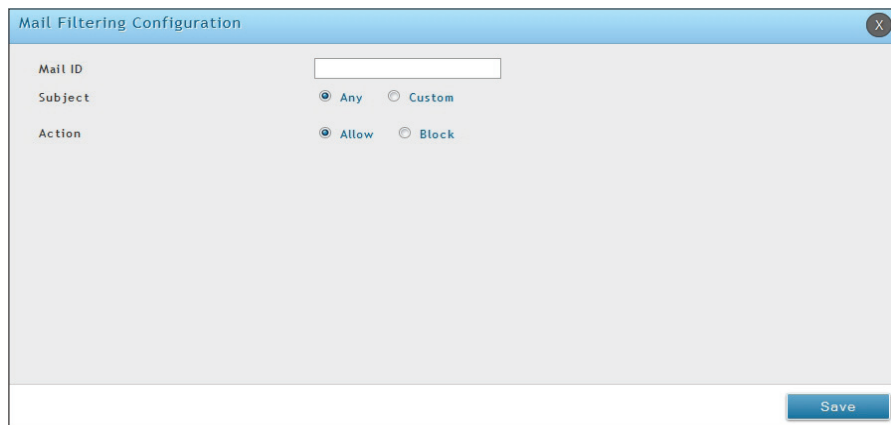

3. Enter a subject and a mail ID.
4. Select your action as allow or block.
5. Click **Save**.

VPN Passthrough

Path: Security > Firewall > VPN Passthrough

This switch's firewall settings can be configured to allow encrypted VPN traffic for IPSec, PPTP, and L2TPVPN tunnel connections between the LAN and internet. A specific firewall rule or service is not appropriate to introduce this passthrough support; instead the options in the VPN Passthrough page must be toggled to **ON**.

1. Click **Security > Firewall > VPN Passthrough**.

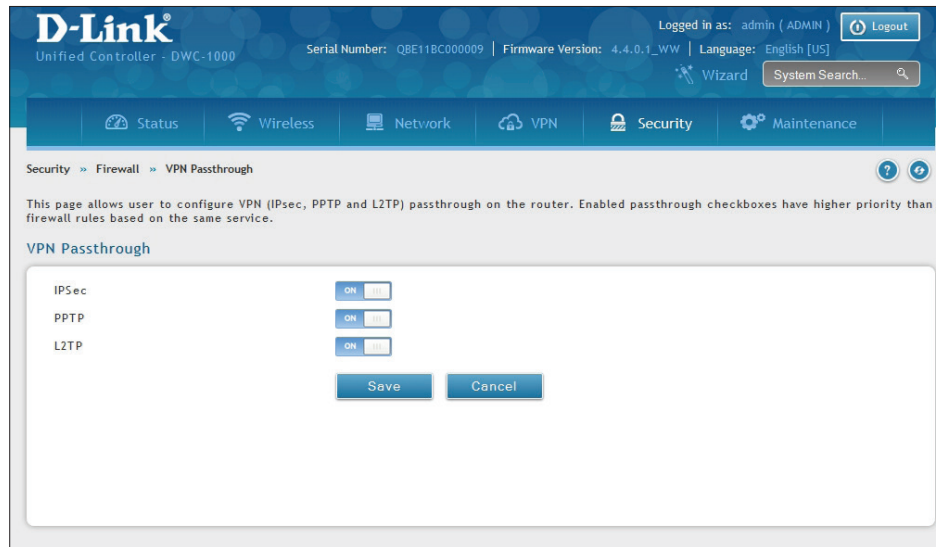

2. Toggle the VPN protocol you want to allow to **ON** and click **Save**.

Dynamic Port Forwarding

Application Rules

Path: Security > Firewall > Dynamic Port Forwarding > Application Rules

Application rules are also referred to as port triggering. This feature allows devices on the LAN or DMZ to request one or more ports to be forwarded to them. Port triggering waits for an outbound request from the LAN/DMZ on one of the defined outgoing ports, and then opens an incoming port for that specified type of traffic. This can be thought of as a form of dynamic port forwarding, while an application is transmitting data over the opened outgoing or incoming port(s).

Port triggering application rules are more flexible than static port forwarding that is an available option when configuring firewall rules. This is because a port triggering rule does not have to reference a specific LAN IP or IP range. Also, ports are not left open when not in use, thereby providing a level of security that port forwarding does not offer.

Note: Port triggering is not appropriate for servers on the LAN, since there is a dependency on the LAN device making an outgoing connection before incoming ports are opened.

Some applications require that when external devices connect to them, they receive data on a specific port or range of ports in order to function properly. The controller must send all incoming data for that application only on the required port or range of ports. The controller has a list of common applications and games with corresponding outbound and inbound ports to open. You can also specify a port triggering rule by defining the type of traffic (TCP or UDP) and the range of incoming and outgoing ports to open when enabled.

1. Click **Security > Firewall > Dynamic Port Forwarding > Application Rules** tab.

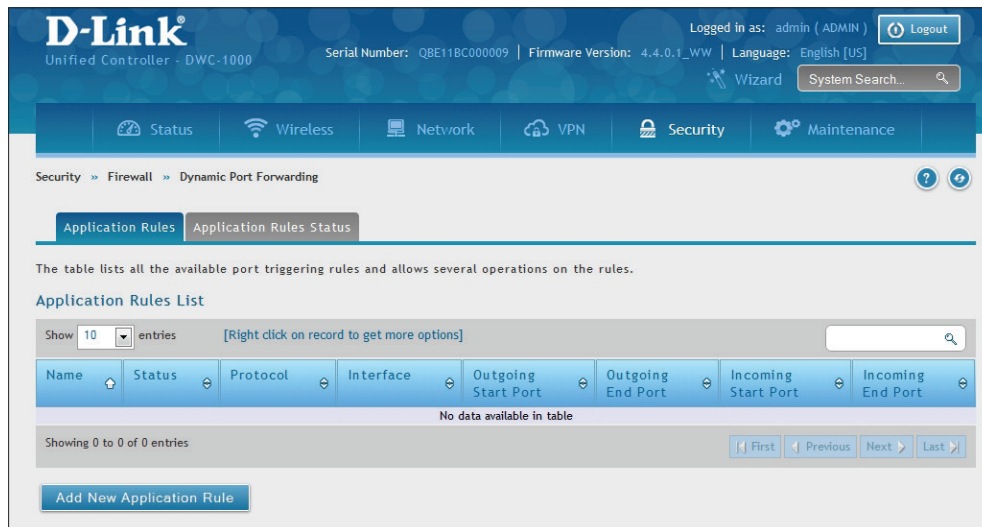

2. Right-click an entry and select either **Edit** or **Delete**. To add a new schedule, click **Add New Application Rule**.

3. Complete the fields from the table below and click **Save**.

Field	Description
Name	Enter a name for your rule.
Enable	Toggle to ON to activate the rule.
Protocol	Select TCP or UDP .
Interface	Select either LAN or DMZ .
Outgoing (Trigger) Port Range	Enter the start and end trigger port range.
Incoming Port Range	Enter the port range to open.
Save	Click to save your settings.

4. Click on the **Application Rules Status** tab to see a list of rules and their status.

Attack Checks

Path: Security > Firewall > Attack Checks

Attacks can be malicious security breaches or unintentional network issues that render the controller unusable. Attack checks allow you to manage Option security threats such as continual ping requests and discovery via ARP scans. TCP and UDP flood attack checks can be enabled to manage extreme usage of Option resources.

Additionally certain Denial-of-Service (DoS) attacks can be blocked. These attacks, if uninhibited, can use up processing power and bandwidth and prevent regular network services from running normally. ICMP packet flooding, SYN traffic flooding, and Echo storm thresholds can be configured to temporarily suspect traffic from the offending source.

1. Click **Security > Firewall > Attack Checks**.

The screenshot shows the 'Attack Checks' configuration page in the D-Link web interface. The page is organized into several sections:

- WAN Security Checks:**
 - Stealth Mode: ON
 - Block TCP Flood: ON
- LAN Security Checks:**
 - Block UDP Flood: ON, [25] [Range: 25 - 500]
 - Allow Ping from LAN: ON
- ICSA Settings:**
 - Block ICMP Notification: ON
 - Block Fragmented Packets: OFF
 - Block Multicast Packets: OFF
 - Block Spoofed IP Packets: OFF
- DoS Attacks:**
 - SYN Flood Detect Rate: [128] [Range: 1 - 10000] max/sec
 - Echo Storm: [15] [Range: 1 - 10000] Ping pkts./sec
 - ICMP Flood: [100] [Range: 1 - 10000] ICMP pkts./sec

Buttons for 'Save' and 'Cancel' are located at the bottom of the configuration area.

2. Complete the fields from the table below and click **Save**.

Field	Description
Stealth Mode	If this option is toggled to ON , the controller will not respond to port scans from the WAN. This makes it less susceptible to discovery and attacks.
Block TCP Flood	If this option is toggled to ON , the controller will drop all invalid TCP packets and be protected from a SYN flood attack.
Block UDP Flood	If this option is toggled to ON , the controller will not accept more than 20 simultaneous, active UDP connections from a single computer on the LAN. You can set the number of simultaneous active UDP connections to be accepted from a single computer on the LAN; the default is 25.
Allow Ping from LAN	Toggle to ON to allow local computers to ping.
Block ICMP Notification	Toggle to ON to prevent ICMP packets from being identified as such. ICMP packets, if identified, can be captured and used in a Ping (ICMP) flood DoS attack.

Field	Description
Block Fragmented Packets	Toggle to ON to drop any fragmented packets through or to the gateway
Block Multicast Packets	Toggle to ON to drop multicast packets, which could indicate a spoof attack, through or to the controller.
Block Spoofed IP Packets	Toggle to ON to block any spoofed IP packets.
SYN Flood Detect Rate	The rate at which the SYN Flood can be detected.
Echo Storm	The number of ping packets per second at which the controller detects an Echo storm attack from the Option and prevents further ping traffic from that external address.
ICMP Flood	The number of ICMP packets per second at which the controller detects an ICMP flood attack from the Option and prevents further ICMP traffic from that external address.

Note: The ping on LAN interfaces is enabled by default. To disable the ping response from LAN hosts to the LAN/Option port of the device, uncheck the "Allow Ping from LAN" option.

VPN

A VPN provides a secure communication channel ("tunnel") between two gateway routers or a remote PC client. The following types of tunnels can be created:

- Gateway-to-gateway VPN: To connect two or more routers to secure traffic between remote sites.
- Remote Client (client-to-gateway VPN tunnel): A remote client initiates a VPN tunnel as the IP address of the remote PC client is not known in advance. The gateway in this case acts as a responder.
- Remote client behind a NAT router: The client has a dynamic IP address and is behind a NAT Router. The remote PC client at the NAT router initiates a VPN tunnel as the IP address of the remote NAT router is not known in advance. The gateway Option port acts as responder.
- PPTP server for LAN / Option PPTP client connections.
- L2TP server for LAN / Option L2TP client connections.

IPSec VPN Policies

Path: VPN > IPSec VPN > Policies

An IPSec policy is between the DWC-1000 and another gateway/router and an IPSec client on a remote host. The IPSec mode can be either tunnel or transport depending on the network being traversed between the two policy endpoints.

- **Transport:** This is used for end-to-end communication between the DWC-1000 and the tunnel endpoint, either another IPSec gateway or an IPSec VPN client on a host. Only the data payload is encrypted, and the IP header is not modified or encrypted.
- **Tunnel:** This mode is used for network-to-network IPSec tunnels where this gateway is one endpoint of the tunnel. In this mode, the entire IP packet including the header is encrypted and/or authenticated.

When tunnel mode is selected, you can enable NetBIOS and DHCP over IPSec. DHCP over IPSec allows this switch to serve IP leases to hosts on the remote LAN. Also, in this mode you can define the single IP address, range of IPs, or subnet on both the local and remote private networks that can communicate over the tunnel.

To configure the radio settings:

1. Click **VPN > IPSec VPN > Policies**.

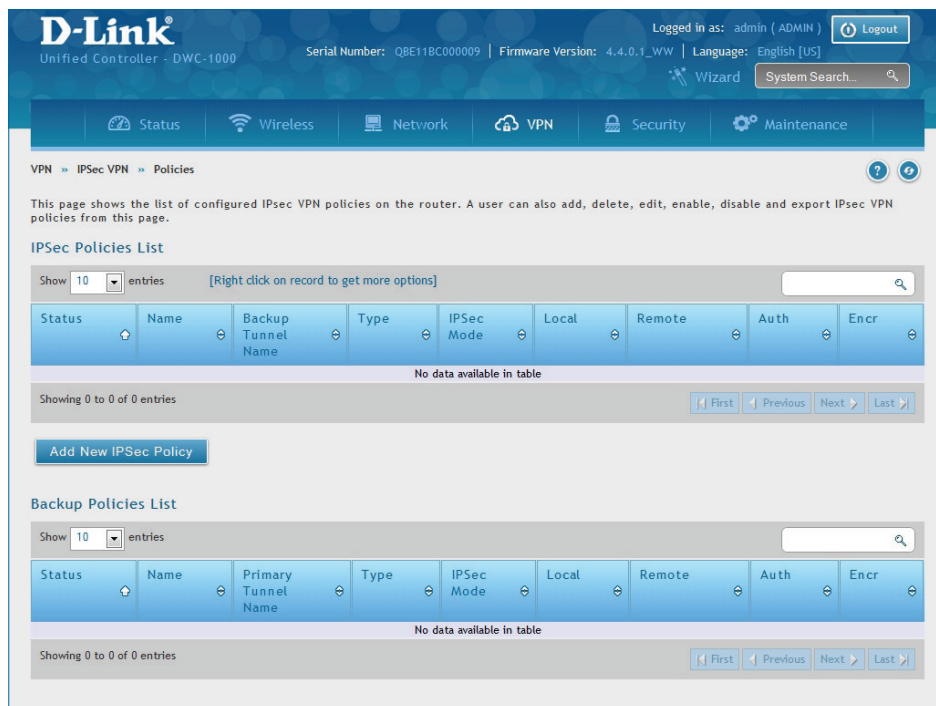

2. Click **Add new IPSec Policy**. Fill in the General section where you will name the IPSec Policy, select policy type, define the tunnel type, and define endpoints.

The screenshot shows the 'IPsec Policy Configuration' window with the following settings:

- Policy Name: [Empty text box]
- Policy Type: Auto Policy
- IP Protocol Version: IPv4
- IKE Version: IKEv1
- IPsec Mode: Tunnel Mode
- Select Local Gateway: Option1
- Remote Endpoint: IP Address
- IP Address / FQDN: [Empty text box]
- Enable Mode Config: OFF
- Enable NetBIOS: OFF
- Enable RollOver: OFF
- Protocol: ESP
- Enable DHCP: OFF
- Local IP: Subnet
- Local Start IP Address: [Empty text box]
- Local Subnet Mask: [Empty text box]
- Remote IP: Subnet
- Remote Start IP Address: [Empty text box]
- Remote Subnet Mask: [Empty text box]
- Enable Keepalive: OFF

Field	Description
Policy Name	Enter a unique name for the VPN Policy. This name is not an identifier for the remote WAN/client.
Policy Type	Select either Manual or Auto . <ul style="list-style-type: none"> • Manual: All settings (including the keys) for the VPN tunnel are manually input for each end point. No third-party server or organization is involved. • Auto: Some parameters for the VPN tunnel are generated automatically. This requires using the IKE (Internet Key Exchange) protocol to perform negotiations between the two VPN Endpoints.
IP Protocol Version	Select either IPv4 or IPv6 .
IKE Version	Select the version of IKE.
IPsec Mode	Select either Tunnel or Transport . IPsec tunnel mode is useful for protecting traffic between different networks, when traffic must pass through an intermediate, untrusted network. Tunnel mode is primarily used for interoperability with gateways, or end-systems that do not support L2TP/IPsec or PPTP connections. Transport mode is the default mode for IPsec, and it is used for end-to-end communications (for example, for communications between a client and a server).
Select Local Gateway	In the event that two Option ports are configured to connect to your ISP, select the gateway that will be used as the local endpoint for this IPsec tunnel.
Remote Endpoint	Select the type of identifier that you want to provide for the controller at the remote endpoint (either IP Address or FQDN [Fully Qualified Domain Name])
IP Address/FQDN	Enter the identifier for the controller.
Enable Mode Config	Toggle to ON to enable. Mode Config is similar to DHCP and is used to assign IP addresses to the remote VPN clients.
Enable NetBIOS	Toggle to ON to allow NetBIOS broadcasts to travel over the VPN tunnel
Enable RollOver	Toggle to ON to enable VPN rollover. You must have the Option Mode set to Rollover.
Protocol	Select a protocol from the drop-down menu.
Enable DHCP	Toggle to ON to allow VPN clients that are connected to your controller over IPsec to receive an assigned IP using DHCP.
Local IP/Remote IP	Select the type of identifier that you want to provide for the endpoint: <ul style="list-style-type: none"> • Any: Specifies that the policy is for traffic from the given end point (local or remote). Note that selecting Any for both local and remote end points is not valid. • Single: Limits the policy to one host. Enter the IP address of the host that will be part of the VPN. • Range: Allows computers within an IP address range to connect to the VPN. Enter the Start IP Address and End IP Address in the provided fields. • Subnet: Allows an entire subnet to connect to the VPN. Enter the network address and subnet mask in the provided fields.
Enable Keepalive	Toggle to ON to periodically send ping packets to the host on the peer side of the network to keep the tunnel alive.

- Once the tunnel type and endpoints of the tunnel are defined, you can determine the Phase 1/Phase 2 negotiation to use for the tunnel. This is covered in the IPsec mode setting, as the policy can be Manual or Auto. For Auto policies, the Internet Key Exchange (IKE) protocol dynamically exchanges keys between two IPsec hosts. The Phase 1 IKE parameters are used to define the tunnel's security association details.

The Phase 2 Auto policy parameters cover the security association lifetime and encryption/authentication details of the phase 2 key negotiation.

The VPN policy is one half of the IKE/VPN policy pair required to establish an Auto IPsec VPN tunnel. The IP addresses of the machine or machines on the two VPN endpoints are configured here, along with the policy parameters required to secure the tunnel.

Phase1(IKE SA Parameters)

Exchange Mode:

Direction / Type:

Nat Traversal: ON OFF

Local Identifier Type:

Remote Identifier Type:

Encryption Algorithm

DES	<input type="checkbox"/> OFF	3DES	<input type="checkbox"/> OFF
AES-128	<input checked="" type="checkbox"/> ON <input type="checkbox"/> OFF	AES-192	<input type="checkbox"/> OFF
AES-256	<input type="checkbox"/> OFF		
BLOWFISH	<input type="checkbox"/> OFF		
CAST128	<input type="checkbox"/> OFF		

Authentication Algorithm

MD5	<input type="checkbox"/> OFF	SHA-1	<input checked="" type="checkbox"/> ON <input type="checkbox"/> OFF
SHA2-256	<input type="checkbox"/> OFF	SHA2-384	<input type="checkbox"/> OFF
SHA2-512	<input type="checkbox"/> OFF		

Authentication Method:

Pre-Shared Key: [Length: 8 - 49]

Diffie-Hellman (DH) Group:

SA-Lifetime: [Default: 28800, Range: 300 - 2147483647] Seconds

Enable Dead Peer Detection: OFF

Extended Authentication:

Phase2-(Auto Policy Parameters)

SA Lifetime:

Encryption Algorithm

DES	<input type="checkbox"/> OFF	NONE	<input type="checkbox"/> OFF
3DES	<input type="checkbox"/> OFF	AES-128	<input checked="" type="checkbox"/> ON <input type="checkbox"/> OFF
AES-192	<input type="checkbox"/> OFF	AES-256	<input type="checkbox"/> OFF
AES-CCM	<input type="checkbox"/> OFF	AES-GCM	<input type="checkbox"/> OFF
TWOFISH (128)	<input type="checkbox"/> OFF	TWOFISH (192)	<input type="checkbox"/> OFF
TWOFISH (256)	<input type="checkbox"/> OFF		
BLOWFISH	<input type="checkbox"/> OFF		
CAST128	<input type="checkbox"/> OFF		

Integrity Algorithm

MD5	<input type="checkbox"/> OFF	SHA-1	<input checked="" type="checkbox"/> ON <input type="checkbox"/> OFF
SHA2-224	<input type="checkbox"/> OFF	SHA2-256	<input type="checkbox"/> OFF
SHA2-384	<input type="checkbox"/> OFF	SHA2-512	<input type="checkbox"/> OFF
PFS Key Group	<input type="checkbox"/> OFF		

A Manual policy does not use IKE and instead relies on manual keying to exchange authentication parameters between the two IPSec hosts. The incoming and outgoing security parameter index (SPI) values must be mirrored on the remote tunnel endpoint. The encryption and integrity algorithms and keys must match on the remote IPSec host exactly in order for the tunnel to establish successfully. Note that using Auto policies with IKE are preferred as in some IPSec implementations the SPI (security parameter index) values require conversion at each endpoint.

The DWC-1000 supports VPN roll-over feature. This means that policies configured on the primary Option port will rollover to the secondary port in case of a link failure. This feature can be used only if your Option is configured in Auto-Rollover mode.

Note: *Once you have created an IPSec policy, you may right-click the policy and select **Export** to save as a file. You can then upload this to another controller or keep as a backup. To upload a saved policy, refer to "Easy VPN Setup" on page 261.*

Tunnel Mode

Path: VPN > IPsec VPN > Tunnel Mode

When tunnel mode is selected, you can enable NetBIOS and DHCP over IPsec. DHCP over IPsec allows this switch to serve IP leases to hosts on the remote LAN. You can also define a single IP address, a range of IPs, or a subnet on both the local and remote private networks that can communicate over the tunnel.

The DWC-1000 allows full tunnel and split tunnel support. Full tunnel mode just sends all traffic from the client across the VPN tunnel to the switch. Split tunnel mode only sends traffic to the private LAN based on pre-specified client routes. These client routes give the client access to specific private networks, thereby allowing access control over specific LAN services.

1. Click **VPN > IPsec VPN > Tunnel Mode**.

2. Complete the fields in the table below and click **Save**.

Field	Description
Tunnel Mode	Select either Full Tunnel or Split Tunnel .
Start/End IP Address	Enter the starting and ending IP addresses.
Primary/Secondary DNS	Enter the primary and secondary DNS server addresses.
Primary/Secondary WINS	Enter the primary and secondary WINS server addresses.
Save	Click Save to save and activate your settings.

Split DNS Names

In a split DNS infrastructure, you create two zones for the same domain, one to be used by the internal network, the other to be used by the external network. Split DNS directs internal hosts to an internal domain name server for name resolution and external hosts are directed to an external domain name server for name resolution.

To add a DNS name:

1. Click **VPN > IPsec VPN > Tunnel Mode > Split DNS Names** tab.

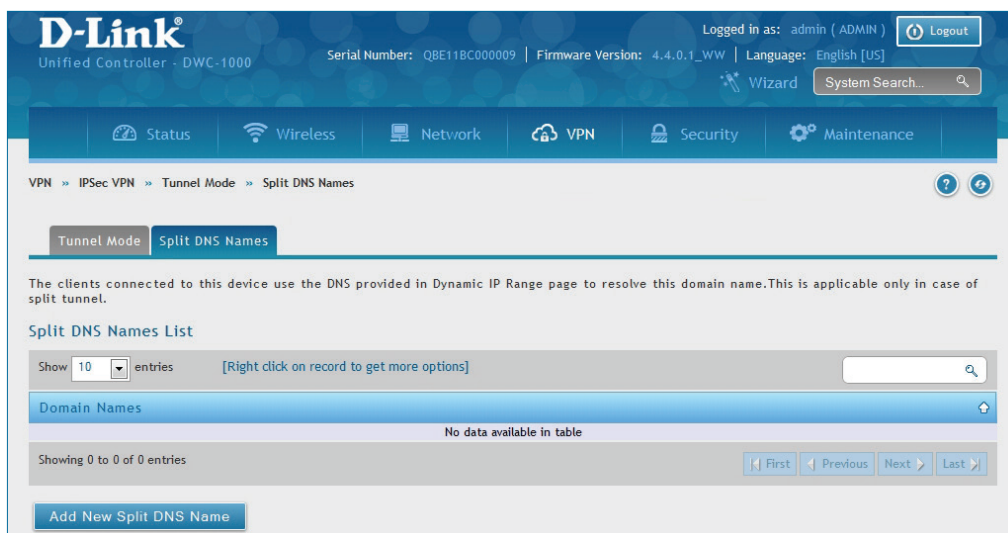

2. Click **Add New Split DNS name**. You can right-click any created entries to edit or delete.

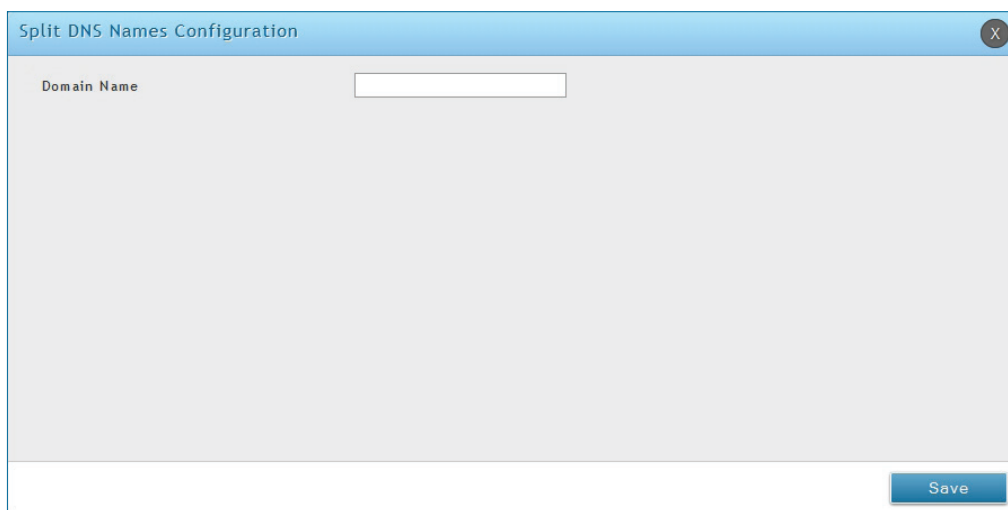

3. Enter a domain name, and click **Save**.

DHCP Range

This page displays the IP range to be assigned to clients connecting using DHCP over IPsec. By default, the range is in 192.168.12.0 subnet.

To configure the *DHCP over IPsec* DHCP server settings:

1. Click **VPN > IPsec VPN > DHCP Range**.

The screenshot shows the D-Link Unified Controller web interface. The top navigation bar includes 'Status', 'Wireless', 'Network', 'VPN', 'Security', and 'Maintenance'. The current page is 'VPN > IPsec VPN > DHCP Range'. The page content includes a note: 'This page allows you to define the IP address range for clients connecting using DHCP over IPsec. Note: To support DHCP over IPsec, enable DHCP server on the LAN.' Below this is the 'DHCP Range' configuration section with three input fields: 'Starting IP Address' (192.168.12.100), 'Ending IP Address' (192.168.12.254), and 'Subnet Mask' (255.255.255.0). There are 'Save' and 'Cancel' buttons at the bottom of the form.

2. Complete the fields in the table below and click **Save**.

Field	Description
Starting IP Address	Enter the starting IP address to issue your clients connecting using DHCP over IPsec.
Ending IP Address	Enter the ending IP address.
Subnet Mask	Enter the subnet mask.
Save	Click Save to save and activate your settings.

Note: To support DHCP over IPsec, enable DHCP server on the LAN.

Certificates

The DWC-1000 uses digital certificates for IPsec VPN authentication. You can obtain a digital certificate from a well-known Certificate Authority (CA) such as VeriSign, or generate and sign your own certificate using functionality available on this gateway.

The switch comes with a self-signed certificate, and this can be replaced by one signed by a CA as per your networking requirements. A CA certificate provides strong assurance of the server's identity and is a requirement for most corporate network VPN solutions.

Trusted Certificates

The certificates menu allows you to view a list of certificates (both from a CA and self-signed) currently loaded on the switch. The following certificate data is displayed in the list of Trusted (CA) certificates:

CA Identity (Subject Name): The certificate is issued to this person or organization

Issuer Name: This is the CA name that issued this certificate

Expiry Time: The date after which this Trusted certificate becomes invalid

To upload a certificate:

1. Click **VPN > IPsec VPN > Certificate > Trusted Certificates** tab.

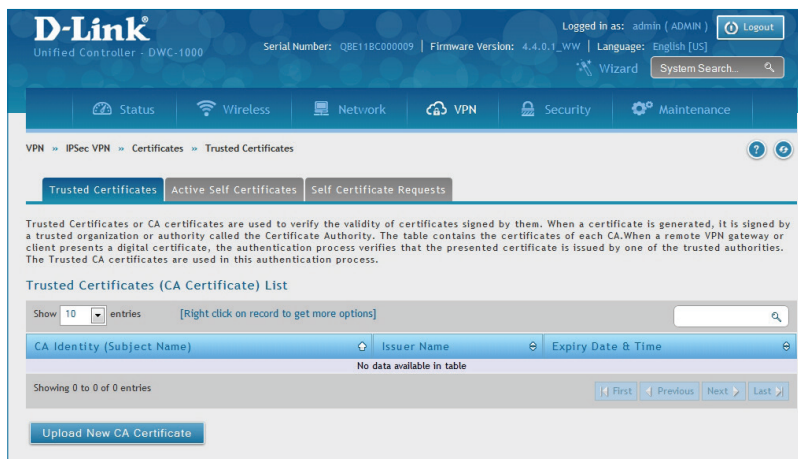

2. Click the **Browse** button. Locate your certificate, and click **Open**.
3. Click **Upload**.

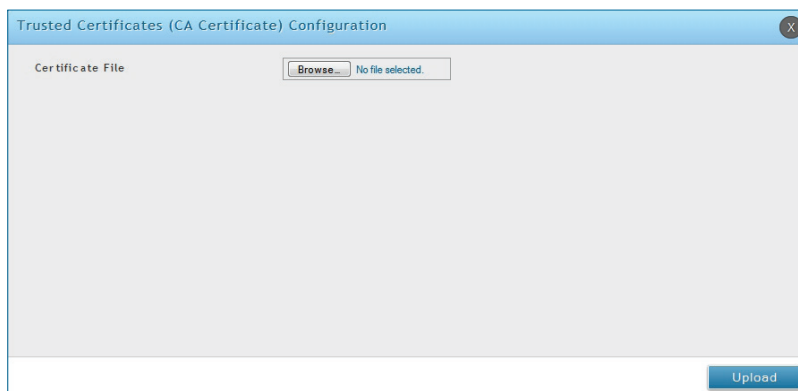

Active Self Certificates

A self certificate is a certificate issued by a CA identifying your device (or self-signed if you don't want the identity protection of a CA). The Active Self Certificate table lists the self certificates currently loaded on the switch. The following information is displayed for each uploaded self certificate:

Name: The name you use to identify this certificate, it is not displayed to IPSec VPN peers.

Subject Name: This is the name that will be displayed as the owner of this certificate. This should be your official registered or company name, as IPSec or SSL VPN peers are shown this field.

Serial Number: The serial number is maintained by the CA and used to identify this signed certificate.

Issuer Name: This is the CA name that has issued (signed) this certificate

Expiry Time: The date after which this signed certificate becomes invalid. You should renew the certificate before it expires.

To upload a certificate:

1. Click **VPN > IPSec VPN > Certificate > Active Self Certificates** tab.

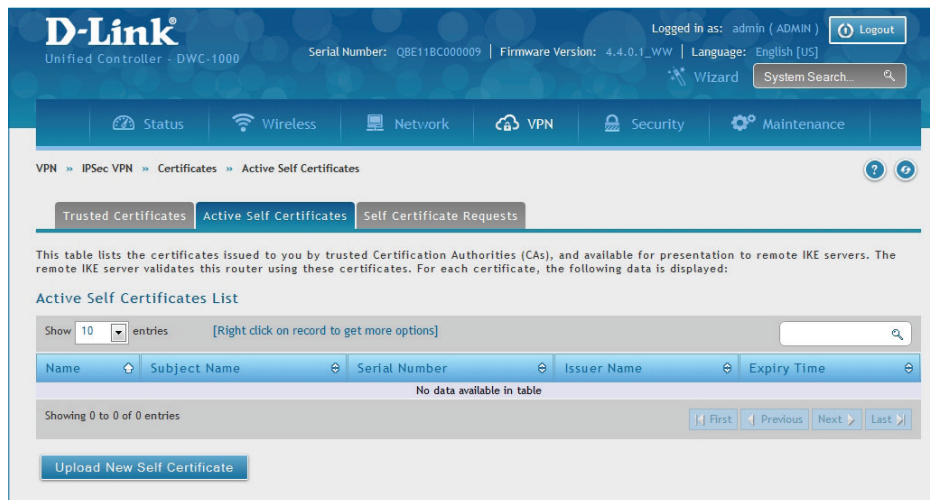

2. Click the **Browse** button. Locate your certificate, and click **Open**.
3. Click **Upload**.

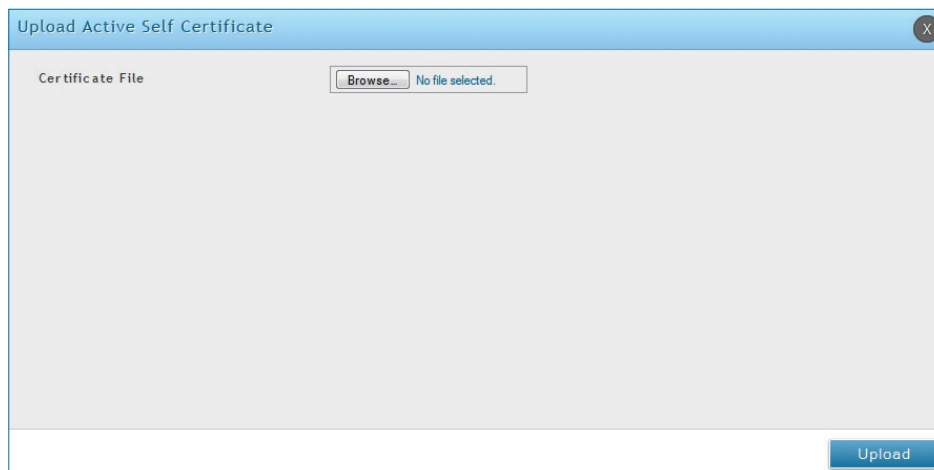

Self Certificate Requests

To request a self certificate to be signed by a CA, you can generate a Certificate Signing Request from the switch by entering the identification parameters and passing it along to the CA for signing. Once signed, the CA's Trusted Certificate and signed certificate from the CA are uploaded to activate the self-certificate validating the identity of this switch. The self certificate is then used in IPsec and SSL connections with peers to validate the switch's authenticity.

To generate a certificate signing request:

1. Click **VPN > IPsec VPN > Certificates > Self Certificate Requests**.

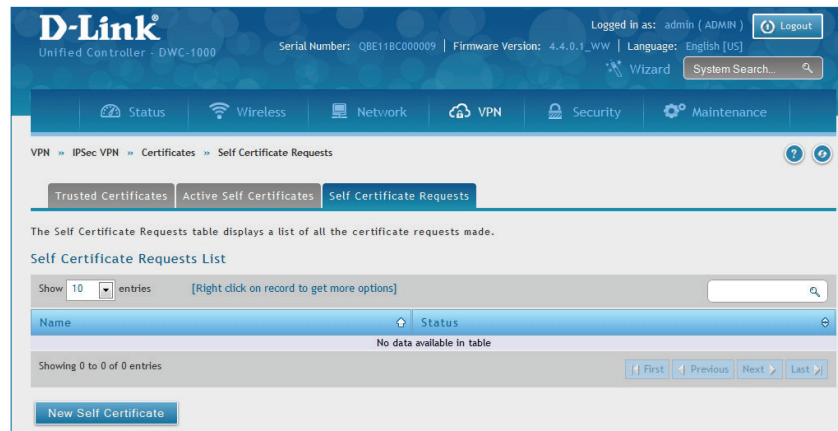

2. Click **New Self Certificate**.
3. Complete the fields in the table below and click **Save**.

The screenshot shows the 'Generate Self Certificate Request' dialog box. It has a title bar with a close button. The form contains the following fields:

- Name: Text input field
- Subject: Text input field
- Hash Algorithm: Drop-down menu with 'MD5' selected
- Signature Key Length: Drop-down menu with '512' selected
- IP Address: Text input field
- Domain Name: Text input field
- Email Address: Text input field

At the bottom right of the dialog, there is a 'Save' button.

Field	Description
Name	Enter a name (identifier) for the certificate.
Subject	This field will populate the CN (Common Name) entry of the generated certificate. Subject names are usually defined in the following format: CN=<device name>, OU=<department>, O=<organization>, L=<city>, ST=<state>, C=<country>. For example: CN=router1, OU=my_company, O=mydept, L=SFO, C=US.
Hash Algorithm	Select the algorithm from the drop-down menu. Select either MD5 or SHA-1 .
Signature Key Length	Select the signature key length from the drop-down menu. Select either 512 , 1024 , or 2048
Application Type	Select the application type from the drop-down menu. Select either HTTPS or IPSec .
IP Address	Enter an IP address (optional).
Domain Name	Enter a domain name (optional).
Email Address	Enter your email address.
Save	Click Save to save and activate your settings.

Easy VPN Setup

To upload an exported IPsec VPN policy:

1. Click **VPN > IPsec VPN > Easy VPN Setup**.
2. Click **Browse**, and navigate to the policy file you want to upload. Select it, and click **Open**.
3. Click **Upload**.

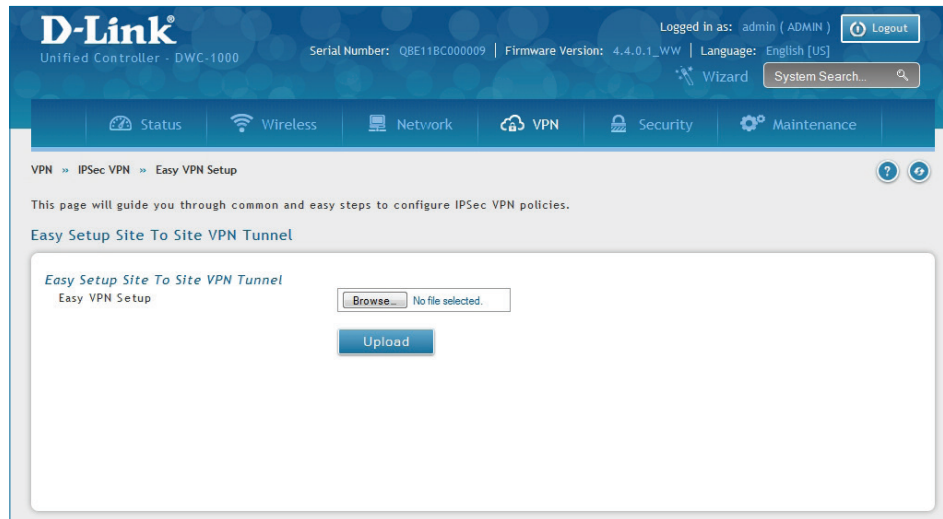

4. Once uploaded, go to **VPN > IPsec VPN > Policies** and the loaded VPN will be listed. Right-click it to edit or delete.

PPTP VPN Server

Path: VPN > PPTP VPN > Server

A PPTP VPN can be established through this switch. Once enabled a PPTP server is available on the switch for LAN and Option PPTP client users to access. Once the PPTP server is enabled, PPTP clients that are within the range of configured IP addresses of allowed clients can reach the controller's PPTP server. Once authenticated by the PPTP server (the tunnel endpoint), PPTP clients have access to the network managed by the controller.

The range of IP addresses allocated to PPTP clients can coincide with the LAN subnet. The PPTP server will default to local PPTP user authentication, but can be configured to employ an external authentication server.

To create a PPTP VPN server:

1. Click **VPN > PPTP VPN > Server**.
2. Complete the fields in the table below and click **Save**.

The screenshot shows the 'PPTP Server' configuration page in the D-Link Unified Controller. The page is titled 'PPTP Server' and includes a description: 'PPTP allows an external user to connect to your router through the Internet. This section allows you to enable/disable PPTP server and define a range of IP addresses for clients connecting to your router. The connected clients can function as if they are on your LAN (they can communicate with LAN hosts, access any servers present etc.)'. The configuration fields are as follows:

- Server Setup:**
 - Enable PPTP Server:
 - PPTP Routing Mode: Nat Classical
 - Range of IP Addresses (Allocated to PPTP Clients):
 - Starting IP Address:
 - Ending IP Address:
 - Authentication Supported:
 - PAP: OFF
 - CHAP: OFF
 - MS-CHAP: OFF
 - MS-CHAPv2: OFF
 - User Time-out:
 - Idle TimeOut: [Ranges: 300 - 1800] Seconds
 - Netbios Setup:
 - Netbios: OFF

Buttons for 'Save' and 'Cancel' are located at the bottom of the configuration area.

Field	Description
Enable PPTP Server	Select either IPv4 or IPv6 .
PPTP Routing Mode	Select either NAT or Classical .
Starting/Ending IP Address	Enter the IP address range to assign your PPTP clients.
IPv6 Prefix	If you selected IPv6, enter the IPv6 prefix.
IPv6 Prefix Length	If you selected IPv6, enter the IPv6 prefix length.
Authentication	Select the authentication type from the drop-down menu.
Authentication Supported	Toggle which type of authentication you want to enable to ON .
Idle TimeOut	Enter the amount of time in seconds that the connection will disconnect when idle.
NetBIOS	Toggle to ON to allow NetBIOS broadcasts to travel over the VPN tunnel.
Save	Click to save your settings.

Client

Path: VPN > PPTP VPN > Client

PPTP VPN Client can be configured on this switch. Using this client, you can access remote network which is local to PPTP server. Once client is enabled, the user can access Status > Active VPNs page and establish PPTP VPN tunnel by clicking **Connect**.

To configure the switch as a PPTP VPN client:

1. Click **VPN > PPTP VPN > Client** tab.
2. Toggle *Client* to **ON** and complete the fields in the table below.

The screenshot shows the D-Link Unified Controller web interface. The top navigation bar includes Status, Wireless, Network, VPN, Security, and Maintenance. The current page is 'VPN > PPTP VPN > Client'. The configuration form for the PPTP Client is displayed with the following fields:

- Client:** A toggle switch currently set to OFF.
- Server IP:** A text input field containing '0.0.0.0'.
- Remote Network:** A text input field containing '0.0.0.0'.
- Remote Netmask:** A text input field containing '0', with a range indicator '[Range: 0 - 32]'.
- Username:** A text input field containing 'dlink'.
- Password:** A text input field with masked characters '.....'.
- MPPE Encryption:** A toggle switch currently set to OFF.
- Idle Time Out:** A text input field containing '0', with a range indicator '[Range: 300 - 1800] Seconds'.

At the bottom of the form are 'Save' and 'Cancel' buttons.

Field	Description
Client	Toggle to ON to enable PPTP client.
Server IP	Enter the IP address of the PPTP server you want to connect to.
Remote Network	Enter the remote network address. This address is local for the PPTP Server.
Remote Netmask	Enter the remote network subnet mask.
Username	Enter your PPTP user name.
Password	Enter your PPTP password.
MPPE Encryption	Toggle to ON to enable Microsoft Point-to-Point Encryption (MPPE).
Idle Time Out	Enter the amount of time (in seconds) that you will disconnect from the PPTP server when idle.
Save	Click Save to save and activate your settings.

PPTP Active Users List

A list of PPTP connections will be displayed on this page. Right-click the connection to connect and disconnect.

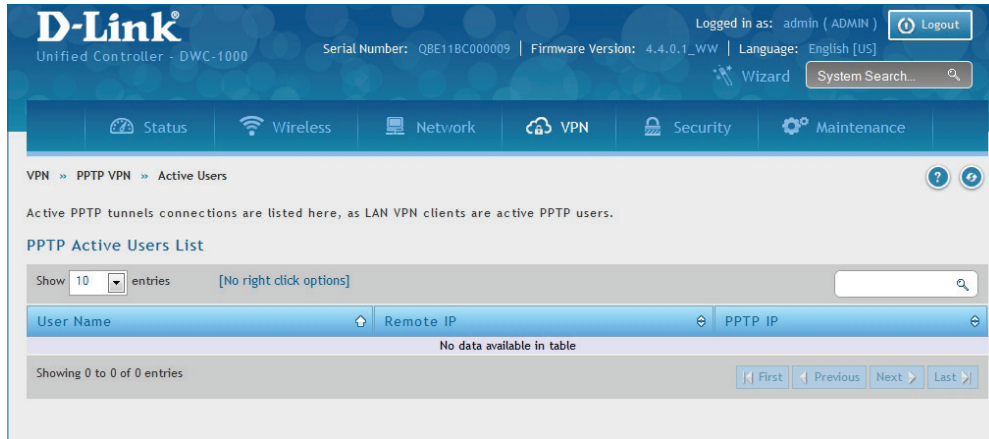

L2TP VPN Server

Path: VPN > L2TP VPN > Server

A L2TP VPN can be established through this switch. Once enabled, an L2TP server is available on the switch for LAN and Option L2TP client users to access. Once the L2TP server is enabled, L2TP clients that are within the range of configured IP addresses of allowed clients can reach the controller's L2TP server. Once authenticated by the L2TP server (the tunnel endpoint), L2TP clients have access to the network managed by the switch.

The range of IP addresses allocated to L2TP clients can coincide with the LAN subnet. The L2TP server will default to local L2TP user authentication, but can be configured to employ an external authentication server should one be configured.

To create a L2TP VPN server:

1. Click **VPN > L2TP VPN > Server**.
2. Complete the fields in the table below, and click **Save**.

The screenshot shows the D-Link Unified Controller web interface. The top navigation bar includes 'Status', 'Wireless', 'Network', 'VPN', 'Security', and 'Maintenance'. The 'VPN' menu is expanded to show 'L2TP VPN' and 'Server'. The 'Server' page is displayed, showing the following configuration options:

- Server Setup:**
 - Enable L2TP Server: ON
 - L2TP Routing Mode: Nat Classical
 - Range of IP Addresses (Allocated to L2TP Clients):
 - Starting IP Address:
 - Ending IP Address:
- Authentication Supported:**
 - PAP: OFF
 - CHAP: OFF
 - MS-CHAP: OFF
 - MS-CHAPv2: OFF
 - Secret Key: OFF
- User Time-out:**
 - Idle TimeOut: [Range: 300 - 1800] Seconds
- Netbios Setup:**
 - Netbios: OFF

Buttons for 'Save' and 'Cancel' are located at the bottom of the configuration area.

Field	Description
Enable L2TP Server	Select either IPv4 or IPv6 .
L2TP Routing Mode	Select either NAT or Classical .
Starting/Ending IP Address	Enter the IP address range to assign your L2TP clients.
IPv6 Prefix	If you selected IPv6, enter the IPv6 prefix.
IPv6 Prefix Length	If you selected IPv6, enter the IPv6 prefix length.
Authentication	Select the authentication type from the drop-down menu.
Authentication Supported	Toggle which type of authentication you want to enable to ON .
Idle TimeOut	Enter the amount of time in seconds that the connection will disconnect when idle.
NetBIOS	Toggle to ON to allow NetBIOS broadcasts to travel over the VPN tunnel.
Save	Click to save your settings.

L2TP Active Users List

A list of L2TP connections will be displayed on this page. Right-click the connection to connect and disconnect.

The screenshot displays the D-Link Unified Controller web interface. At the top, the D-Link logo and 'Unified Controller - DWC-1000' are visible. The user is logged in as 'admin (ADMIN)' with a 'Logout' button. System information includes 'Serial Number: QBE11BC000009', 'Firmware Version: 4.4.0.1_WW', and 'Language: English [US]'. A 'Wizard' icon and a 'System Search...' field are also present. The main navigation bar includes 'Status', 'Wireless', 'Network', 'VPN', 'Security', and 'Maintenance'. The current page is 'VPN >> L2TP VPN >> Active Users'. Below the navigation, a message states: 'Active L2TP tunnels connections are listed here, as LAN VPN clients are active L2TP users.' The 'L2TP Active Users List' section features a 'Show 10 entries' dropdown, a search box, and a table with columns for 'User Name', 'Remote IP', and 'L2TP IP'. The table currently shows 'No data available in table'. At the bottom, it indicates 'Showing 0 to 0 of 0 entries' and includes navigation buttons for 'First', 'Previous', 'Next', and 'Last'.

SSL VPN

Server Policies

SSL VPN Policies can be created on a Global, Group, or User level. User level policies take precedence over Group level policies, and Group level policies take precedence over Global policies. These policies can be applied to a specific network resource, IP address, or IP ranges on the LAN, or to different SSL VPN services supported by the switch. The *List of Available Policies* can be filtered based on whether it applies to a user, group, or all users (global).

To add a SSL VPN policy, you must first assign it to a user, group, or make it global (i.e., applicable to all SSL VPN users). If the policy is for a group, the available configured groups are shown in a drop-down menu and one must be selected. Similarly, for a user-defined policy, a SSL VPN user must be chosen from the available list of configured users.

The next step is to define the policy details. The policy name is a unique identifier for this rule. The policy can be assigned to a specific Network Resource (details follow in the subsequent section), IP address, IP network, or all devices on the LAN of the switch. Based on the selection of one of these four options, the appropriate configuration fields are required (i.e., choosing the network resources from a list of defined resources, or defining the IP addresses). For applying the policy to the addresses, port range/port number can be defined.

The final steps require the policy permission to be set to either permit or deny access to the selected addresses or network resources. Also, the policy can be specified for one or all of the supported SSL VPN services (i.e., VPN tunnel).

Once defined, the policy goes into effect immediately. The policy name, SSL service it applies to, destination (network resource or IP addresses), and permission (deny/permit) is outlined in a list of configured policies for the controller.

Note: You must enable Remote Management. Refer to “VLANs” on page 171.

To create a new SSL VPN policy:

1. Make sure you have enabled remote management and have created user(s) and group(s) to assign to this policy.
2. Click **VPN > SSL VPN > SSL VPN Server Policy**. Next to *SSL VPN Server Policy*, toggle to **On** and click **Save**.
3. Click **Add New SSL VPN Server Policy**.

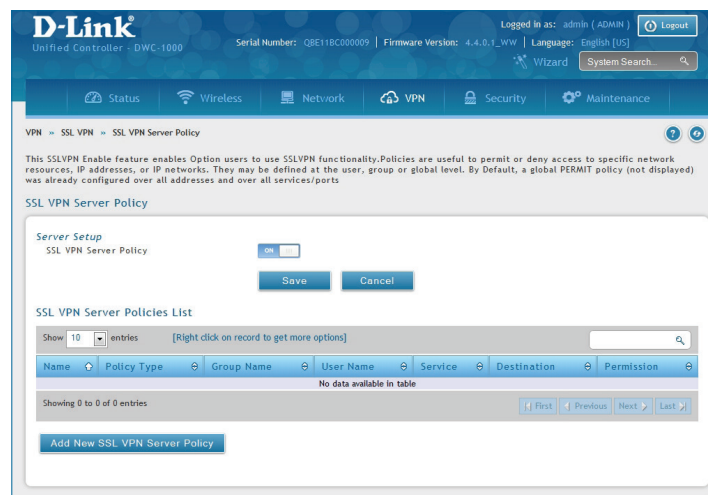

4. Complete the fields from the table below and click **Save**.

The screenshot shows the 'SSL VPN Server Policies Configuration' window. The 'Policy Type' is set to 'Global'. Under 'SSL VPN Policy', 'Apply Policy to' is set to 'Network Resource'. The 'Policy Name' field is empty. The 'ICMP' toggle is set to 'OFF'. Under 'Port Range / Port Number', the 'Defined Resources' dropdown is empty. The 'Permission' is set to 'Permit'. A 'Save' button is at the bottom right.

Network Resource

The screenshot shows the 'SSL VPN Server Policies Configuration' window. The 'Policy Type' is set to 'Global'. Under 'SSL VPN Policy', 'Apply Policy to' is set to 'IP Address'. The 'Policy Name' field is empty. The 'IP Address' field is empty. The 'ICMP' toggle is set to 'OFF'. Under 'Port Range / Port Number', the 'Begin' and 'End' fields are empty, with range indicators '[Range: 0 - 65535]'. The 'Service' is set to 'VPN Tunnel'. The 'Permission' is set to 'Permit'. A 'Save' button is at the bottom right.

IP Address

Field	Description
Policy Type	Select Global , Group , or User .
Available Groups/Users	If you selected Group , select a group from the drop-down menu. If you selected User , select a user from the drop-down menu.
Apply Policy To	Select Network Resource , IP Address , IP Network , or All Addresses .
Policy Name	Enter a unique name for this policy.
IP Address	If you selected IP Address or IP Network , enter the IP address.
Mask Length	If you selected IP Network , enter the mask length (0-32).
ICMP	Toggle to ON to include ICMP traffic.
Begin/End	Enter a port range or leave blank to include all TCP and UDP ports. These fields are not available when selecting Network Resource .
Defined Resources	If you selected Network Resource , select the resource for the <i>Defined Resource</i> drop-down menu. If you have not created a resource, refer to “Resources” on page 271 to create a defined resource.
Service	Select either VPN Tunnel , Port Forwarding , or All . This field is not available when selecting Network Resource .
Permission	Select either Permit or Deny .
Save	Click to save your settings.

Portal Layouts

Path: VPN > SSL VPN > Portal Layouts

You may create a custom page for remote VPN users that is viewed during authentication. You may include login instructions, services, and other details. Note that the default portal LAN IP address is `https://192.168.10.1/scgi-bin/userPortal/portal`. This is the same page that opens when the "User Portal" link is clicked on the SSL VPN menu of the controller web UI.

To create a new portal layout:

1. Click **VPN > SSL VPN > Portal Layouts**.
2. Click **Add New SSL VPN Portal Layout**.

The screenshot shows the D-Link Unified Controller web interface. The top navigation bar includes links for Status, Wireless, Network, VPN, Security, and Maintenance. The current page is "VPN > SSL VPN > Portal Layouts". A description states: "The table lists the SSL portal layouts configured for this device and allows several operations on the portal layouts. The router allows you to create a custom page for remote SSL VPN users that is presented upon authentication. Login instructions, available services, and other usage details that are specific to a domain are useful to present on the authentication portal. Portals are assigned to the user domain." Below this is a table titled "SSL VPN Portal Layouts List" with columns for Layout Name, Use Count, and Portal URL. One entry is shown: "SSLVPN" with a Use Count of 0 and a Portal URL of "https://0.0.0.0/portal/SSLVPN". A button "Add New SSL VPN Portal Layout" is visible at the bottom.

Layout Name	Use Count	Portal URL
SSLVPN	0	https://0.0.0.0/portal/SSLVPN

Note: You may right-click a layout from the list and edit or delete a layout.

3. Complete the fields from the table on the next page and click **Save**.

SSL VPN Portal Layout Configuration
X

Portal Layout and Theme Name

Portal Layout Name

Login Profile Name default ▼

Portal Site Title

Banner Title

Banner Message

Display Banner Message on Login Page OFF

HTTP Meta Tags for Cache Control (Recommended) OFF

ActiveX Web Cache Cleaner OFF

SSL VPN Portal Pages to Display

VPN Tunnel page OFF

Port Forwarding OFF

Save

Field	Description
Portal Layout Name	Enter a name for this portal. This name will be used as part of the path for the SSL portal URL. Only alphanumeric characters are allowed for this field.
Login Profile View	Select a login profile from the drop-down menu.
Portal Site Title	Enter the portal web browser window title that appears when the client accesses this portal. This field is optional.
Banner Title	The banner title that is displayed to SSL VPN clients prior to login. This field is optional.
Banner Message	Enter a message you want to display.
Display Banner Message on Login Page	Toggle to ON to display the banner title and message or OFF to hide the banner title and message.
HTTP Meta Tags for Cache Control	Toggle to ON or OFF . This security feature prevents expired web pages and data from being stored in the client's web browser cache. It is recommended to toggle to ON.
Active X Web Cache Cleaner	Toggle to ON or Off . An ActiveX cache control web cleaner can be pushed from the gateway to the client browser whenever users login to this SSL VPN portal.
Authentication Type	Select the type of authentication from the drop-down menu.
Group	Select what group to include from the drop-down menu.
VPN Tunnel Page	Toggle to ON to allow remote users to view this page.
Port Forwarding	Toggle to ON to allow remote users to view this page.
Save	Click to save your settings.

Resources

Path: VPN > SSL VPN > Resources

Network resources are services or groups of LAN IP addresses that are used to easily create and configure SSL VPN policies. This shortcut saves time when creating similar policies for multiple remote SSL VPN users.

Adding a Network Resource involves creating a unique name to identify the resource and assigning it to one or all of the supported SSL services. Once this is done, editing one of the created network resources allows you to configure the object type (either IP address or IP range) associated with the service. The Network Address, Mask Length, and Port Range/Port Number can all be defined for this resource as required.

Add New Resource

To add a new resource:

1. Click **VPN > SSL VPN > Resources**.
2. Click **Add New Resource**.

The screenshot shows the D-Link Unified Controller web interface. At the top, there is a header with the D-Link logo, 'Unified Controller - DWC-1000', and system information including 'Serial Number: QBE118C000009', 'Firmware Version: 4.4.0.1_WW', and 'Language: English [US]'. A user is logged in as 'admin (ADMIN)' with a 'Logout' button. A search bar and a 'Wizard' icon are also present.

The main navigation menu includes 'Status', 'Wireless', 'Network', 'VPN', 'Security', and 'Maintenance'. The current page is 'VPN > SSL VPN > Resources'. Below the breadcrumb, there is a descriptive paragraph about network resources. Three tables are displayed, each with a search bar and navigation controls. The first table is 'SSL VPN Resources List' with columns: Name, Service, Type, Resource Object, Port, Mask Length. The second table is 'Port Forwarding List for Configured Applications' with columns: Local Server IP Address, TCP Port Number. The third table is 'Port Forwarding List for Configured Host Names' with columns: Local Server IP Address, Fully Qualified Domain Name. Each table shows 'No data available in table' and has an 'Add New Resource' or 'Add New Rule' button below it.

3. Complete the fields from the table on the next page and click **Save**.

SSL VPN Resources Configuration X

SSL VPN Resources

Resource Name

Service VPN Tunnel Port Forwarding All

Resource Object Configuration

ICMP OFF

Object Type ▼

Object Address

Port Range / Port Number

Begin [Range: 0 - 65535]

End [Range: 0 - 65535]

Field	Description
Resource Name	Enter a unique name for this resource.
Service	Select VPN Tunnel , Port Forwarding , or All .
ICMP	Toggle to ON to include ICMP traffic.
Object Type	Select Single IP Address or IP Network .
Object Address	Enter the IP address.
Mask Length	If you selected IP Network, enter the mask length (0-32).
Begin/End	Enter a port range for the object.
Save	Click to save your settings.

Port Forwarding

Port forwarding allows remote SSL users to access specified network applications or services after they login to the User Portal and launch the Port Forwarding service. Traffic from the remote user to the switch is detected and re-routed based on configured port forwarding rules.

Internal host servers or TCP applications must be specified as being made accessible to remote users. Allowing access to a LAN server requires entering the local server IP address and TCP port number of the application to be tunnelled.

To add a port forwarding rule:

1. Click **VPN > SSL VPN > Resources**.
2. Click **Add New Rule** under either *Port Forwarding List for Configured Applications (TCP Port)* or under *Port Forwarding List for Configured Host Names (FQDN)*.
3. Enter the IP address of the local server.
4. Next enter either the TCP port number or the domain name (FQDN).
5. Click **Save**.

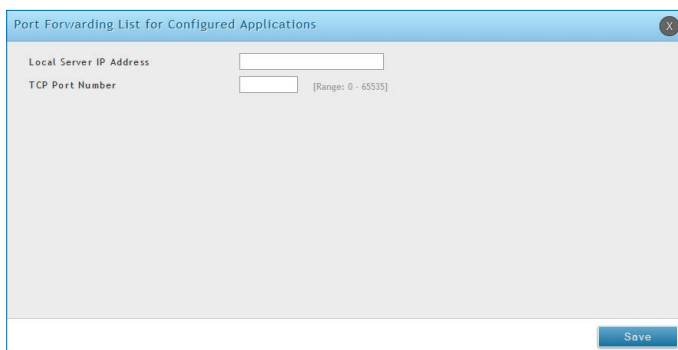

The screenshot shows a dialog box titled "Port Forwarding List for Configured Applications". It contains two input fields: "Local Server IP Address" and "TCP Port Number". The "TCP Port Number" field has a small text label "[Range: 0 - 65535]" next to it. A "Save" button is located at the bottom right of the dialog box.

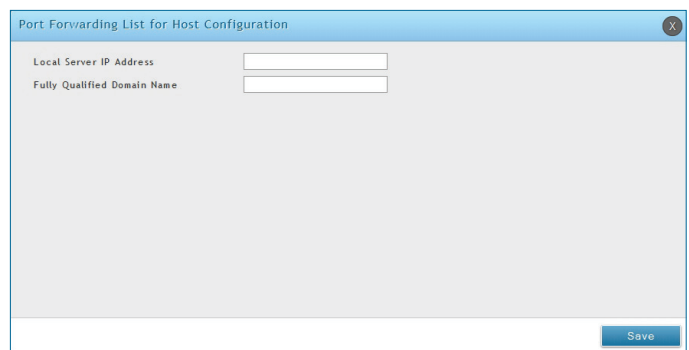

The screenshot shows a dialog box titled "Port Forwarding List for Host Configuration". It contains two input fields: "Local Server IP Address" and "Fully Qualified Domain Name". A "Save" button is located at the bottom right of the dialog box.

Client

Path: VPN > SSL VPN > SSL VPN Client

An SSL VPN tunnel client provides a point-to-point connection between the browser-side machine and this switch. When a SSL VPN client is launched from the user portal, a "network adapter" with an IP address from the corporate subnet, DNS and WINS settings is automatically created. This allows local applications to access services on the private network without any special network configuration on the remote SSL VPN client machine.

It is important to ensure that the virtual (PPP) interface address of the VPN tunnel client does not conflict with physical devices on the LAN. The IP address range for the SSL VPN virtual network adapter should be either in a different subnet or non-overlapping range as the corporate LAN.

The controller allows full tunnel and split tunnel support. Full tunnel mode just sends all traffic from the client across the VPN tunnel to the switch. Split tunnel mode only sends traffic to the private LAN based on pre-specified client routes. These client routes give the SSL client access to specific private networks, thereby allowing access control over specific LAN services.

To configure client mode:

1. Click **VPN > SSL VPN > SSL VPN Client**.

The screenshot shows the D-Link Unified Controller web interface. At the top, it displays the D-Link logo, 'Unified Controller - DWC-1000', and system information including 'Serial Number: QBE118C000009', 'Firmware Version: 4.4.0.1_WW', and 'Language: English [US]'. A navigation menu includes 'Status', 'Wireless', 'Network', 'VPN', 'Security', and 'Maintenance'. The current page is 'VPN > SSL VPN > SSL VPN Client'. A description states: 'An SSL VPN tunnel client provides a point-to-point connection between the browser-side machine and this device. When a SSL VPN client is launched from the user portal, a "network adapter" with an IP address, DNS and WINS settings is automatically created, which allows local applications to talk to services on the private network without any special network configuration on the remote SSL VPN client machine.' The configuration form for the 'SSL VPN Client' includes:

- Full Tunnel Support: ON (toggle)
- DNS Suffix: [Empty text box]
- Primary DNS Server: [Empty text box]
- Secondary DNS Server: [Empty text box]
- Client Address Range Begin: 192.168.251.1
- Client Address Range End: 192.168.251.254
- LCP Timeout: 60 [Range: 1 - 999999] Seconds

 At the bottom of the form are 'Save' and 'Cancel' buttons.

2. Toggle *Full Tunnel Support* to **ON** to support full tunnel or **OFF** to enable split tunnel.
3. Enter a *DNS suffix* to assign to this client (optional).
3. Enter a *primary* and *secondary DNS server addresses* (optional).
4. Enter the range of IP addresses clients will be assigned (DHCP).
5. Next to *LCP Timeout*, set the value for LCP echo interval (in seconds).
6. Click **Save**.

Client Routes

Path: VPN > SSL VPN > SSL VPN Client

If the SSL VPN client is assigned an IP address in a different subnet than the corporate network, a client route must be added to allow access to the private LAN through the VPN tunnel. As well, a static route on the private LAN's firewall (typically this switch) is needed to forward private traffic through the VPN Firewall to the remote SSL VPN client.

When split tunnel mode is enabled, the user is required to configure routes for VPN tunnel clients:

- Destination network: The network address of the LAN or the subnet information of the destination network from the VPN tunnel clients' perspective is set here.
- Subnet mask: The subnet information of the destination network is set here.

To configure a client route:

1. Click **VPN > SSL VPN > Client Routes**.
2. Click **Add New Client Route**.

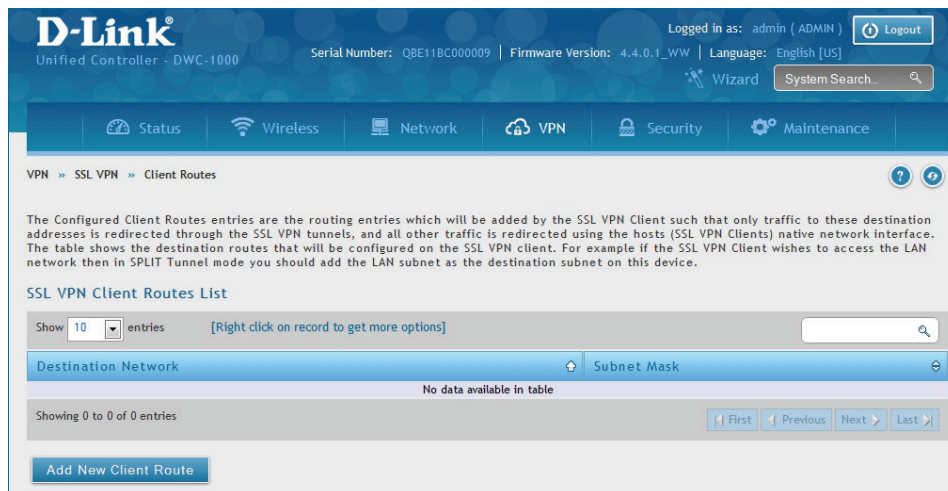

3. Enter the destination network and subnet mask.
4. Click **Save**.

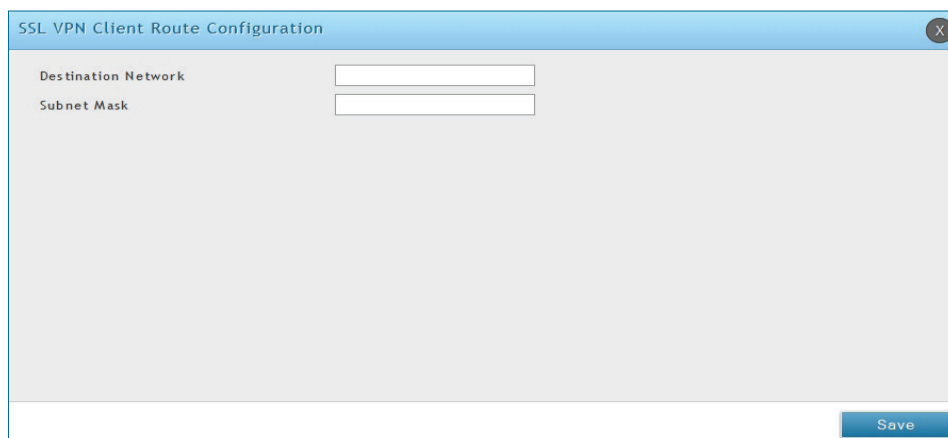

Open VPN Settings

VPN > OpenVPN > OpenVPN Settings

OpenVPN allows peers to authenticate each other using a pre-shared secret key, certificates, or username/password. When used in a multi client-server configuration, it allows the server to release an authentication certificate for every client, using signature and Certificate authority. An OpenVPN can be established through this controller.

You can select server mode, client mode, or access server client mode. In access server client mode, the user has to download the auto login profile from the OpenVPN Access Server, and upload the same to connect.

Server

To configure the controller as an OpenVPN Server:

1. Click **VPN > OpenVPN > OpenVPN Settings**.
2. Toggle *OpenVPN* to **ON** and complete the fields in the table below.

OpenVPN configuration page allows the user to configure OpenVPN as a server or client.

OpenVPN Settings

OpenVPN ON

Mode: Server Client Access Server Client

VPN Network:

VPN Netmask:

Duplicate CN: OFF

Port: [Default: 1194, Range: 1024 - 65535]

Tunnel Protocol: TCP UDP

Encryption Algorithm:

Hash Algorithm:

Tunnel Type: Full Tunnel Split Tunnel

	CA Subject Name	Server / Client Cert Subject Name	Server / Client Key Uploaded	Dh Key Uploaded
<input checked="" type="checkbox"/> ON	C=TW, ST=Taiwan, L=Taipei, O=D-Link Corporation, OU=Certificate for DSR (Self-Signed), CN=D-Link Cor ...	C=TW, ST=Taiwan, L=Taipei, O=D-Link Corporation, OU=Certificate for DSR (Self-Signed), CN=server ...	yes	yes

Enable TLS Authentication Key
Enable TLS Authentication Key: Disabled

Block Invalid Client Certificates
Block Invalid Client Certificates: Disabled

Allow only User Based Auth Configuration
Allow only User Based Auth: OFF

User Based Auth Configuration
Enable User Based Auth: OFF

OpenVPN Authentication
Authentication Server:
Authentication Type:

Field	Description
Mode	Select Server .
VPN Network	Enter the IP network for the VPN.
VPN Netmask	Enter the netmask.
Duplicate CN	This feature allows multiple clients with the same common name to concurrently connect. Duplicate CN option can be configured on server side. If we enable this option, we will be able to use same certificate to connect for multiple clients. For this feature, user based authentication is also required and multiple clients require to have their respective user-name and password.
Port	Enter what port to use. The default port is 1194.
Tunnel Protocol	Select either TCP or UDP .
Encryption Algorithm	Select the encryption algorithm from the drop-down menu.
Hash Algorithm	Select the hash algorithm from the drop-down menu.
Tunnel Type	Select either Full Tunnel or Split Tunnel . Full Tunnel mode just sends all traffic from the client across the VPN tunnel to the controller. Split Tunnel mode only sends traffic to the private LAN based on pre-specified client routes. If you select Split Tunnel, refer to "LAN Configuration" on page 137 to create local networks.
Certificates	Select the set of certificates openvpn server uses. First Row: Set of certificates and keys the server uses. Second Row: Set of certificates and keys newly uploaded.
Enable Tls Authentication Key	Enabling this adds Tls authentication which adds an additional layer of authentication. Can be checked only when the tls key is uploaded. Disabled by default.
Block Invalid Client Certificates	Enabling this adds facility to block invalid client certificate. This feature requires crl certificate which contains list of client certificates to be blocked. Please upload crl certificate in OpenVPN Authentication page.
Allow only User Based Auth Configuration	This method does not require the client certificate, client will authenticate using the username/password only.
User Based Auth Configuration	This option is introduced to provide the additional authentication method using username/password.
Authentication Server	Shows the available authentication servers among which one can be selected for openvpn. All users login into the OmniSSL portal for this openvpn are authenticated through the selected server. Available authentication servers are 1)Local User Database 2)Radius Server 3)LDAP Server 4)POP3 5)Active Directory 6)NT Domain
Authentication Type	This option is only configurable when authentication server is selected as Radius Server. The available authentication types are PAP/CHAP/MSCHAP/MSCHAPV2.
Save	Click Save to save and activate your settings.

Client

To configure the controller as an OpenVPN client:

1. Click **VPN > OpenVPN > OpenVPN Settings**.
2. Toggle *OpenVPN* to **ON** and complete the fields in the table below.

OpenVPN configuration page allows the user to configure OpenVPN as a server or client.

OpenVPN Settings

OpenVPN

Mode: Server Client Access Server Client

Server IP:

Failover Server IP: Optional

Port: [Default: 1194, Range: 1024 - 65535]

Tunnel Protocol: TCP UDP

Encryption Algorithm:

Hash Algorithm:

	CA Subject Name	Server / Client Cert Subject Name	Server / Client Key Uploaded	Dh Key Uploaded
<input checked="" type="checkbox"/>	C-TW, ST-Taiwan, L-Taipei, O-D-Link Corporation, OU=Certificate for DSR (Self-Signed), CN=D-Link Cor ...	C-TW, ST-Taiwan, L-Taipei, O-D-Link Corporation, OU=Certificate for DSR (Self-Signed), CN=server ...	yes	N/A

Enable Tls Authentication Key
Enable Tls Authentication Key:

Block Invalid Client Certificates
Block Invalid Client Certificates:

Allow only User Based Auth Configuration
Allow only User Based Auth:

User Based Auth Configuration
Enable User Based Auth:

Username:

Password:

Field	Description
Mode	Select Client .
Server IP	Enter the IP address of the OpenVPN server.
Failover Server IP	Select the type of identifier that you want to provide for Failover mechanism at the Failover Server IP: IP Address or FQDN (Fully Qualified Domain Name). This feature allows to configure an additional OmniSSL server for client, which will be used when primary server is down. This is optional and applicable only in client mode.
Port	Enter what port to use. The default port is 1194.
Tunnel Protocol	Select either TCP or UDP .
Encryption Algorithm	Select the encryption algorithm from the drop-down menu.
Hash Algorithm	Select the hash algorithm from the drop-down menu.
Certificates	Select the set of certificates OpenVPN server uses. First row indicates the set of certificates and keys that the server uses. Second row indicates the set of certificates and keys newly uploaded.

Field	Description
Enable Tls Authentication Key	Enabling this adds Tls authentication which adds an additional layer of authentication. This can be checked only when the tls key is uploaded. By default, it is disabled.
Block Invalid Client Certificates	Enabling this adds facility to block invalid client certificate. This feature requires crl certificate which contains list of client certificates to be blocked. Please upload crl certificate in OpenVPN Authentication page.
Allow only User Based Auth Configuration	This method does not require the client certificate, client will authenticate using the username/password only.
Enable User Based Auth	This option is introduced to provide the additional authentication method using username/password.
Username	Enter the username.
Password	Enter the password.
Save	Click Save to save and activate your settings.

Access Server Client

To configure the switch as an OpenVPN access server client:

1. Click **VPN > OpenVPN > OpenVPN Settings**.
2. Toggle *OpenVPN* to **ON** and complete the fields in the table below.

OpenVPN configuration page allows the user to configure OpenVPN as a server or client.

OpenVPN Settings

OpenVPN ON

Mode: Server Client Access Server Client

Port: [Default: 1194, Range: 1024 - 65535]

Private Tunnel Client Configuration
Enable Private Tunnel: OFF

Upload Access Server Client Configuration
Upload Status: No
File: No file selected.

	CA Subject Name	Server / Client Cert Subject Name	Server / Client Key Uploaded	Dh Key Uploaded
<input checked="" type="checkbox"/>	C=TW, ST=Taiwan, L=Taipei, O=D-Link Corporation, OU=Certificate for DSR (Self-Signed), CN=D-Link Cor ...	C=TW, ST=Taiwan, L=Taipei, O=D-Link Corporation, OU=Certificate for DSR (Self-Signed), CN=server ...	yes	N/A

Enable Tls Authentication Key: Disabled
Block Invalid Client Certificates: Disabled

Field	Description
Mode	Select Access Server Client .
Port	Enter what port to use. The default port is 1194.
Enable Private Tunnel	Enable Private Tunnel. Applicable only in OpenVPN Access Server mode. This feature connects to www.privatetunnel.com which provides a secured access connectivity. Reachability to www.privatetunnel.com is required.
Upload Status	Displays if a configuration file has been uploaded.
File	Click Browse and locate the configuration file. Click Open and then click Upload .
Certificates	Select the set of certificates OpenVPN server uses. First row indicates the set of certificates and keys that the server uses. Second row indicates the set of certificates and keys newly uploaded.
Enable Tls Authentication Key	Enabling this adds Tls authentication which adds an additional layer of authentication. This can be checked only when the tls key is uploaded. By default, it is disabled.
Block Invalid Client Certificates	Enabling this adds facility to block invalid client certificate. This feature requires crl certificate which contains list of client certificates to be blocked. Please upload crl certificate in OpenVPN Authentication page.
Save	Click Save to save and activate your settings.

Local Networks

If Split Tunnel (from OpenVPN Server) is selected, you can create a local network by following the steps given below:

1. Click **VPN > OpenVPN > Local Networks**.
2. Click **Add New OpenVPN Local Network**.

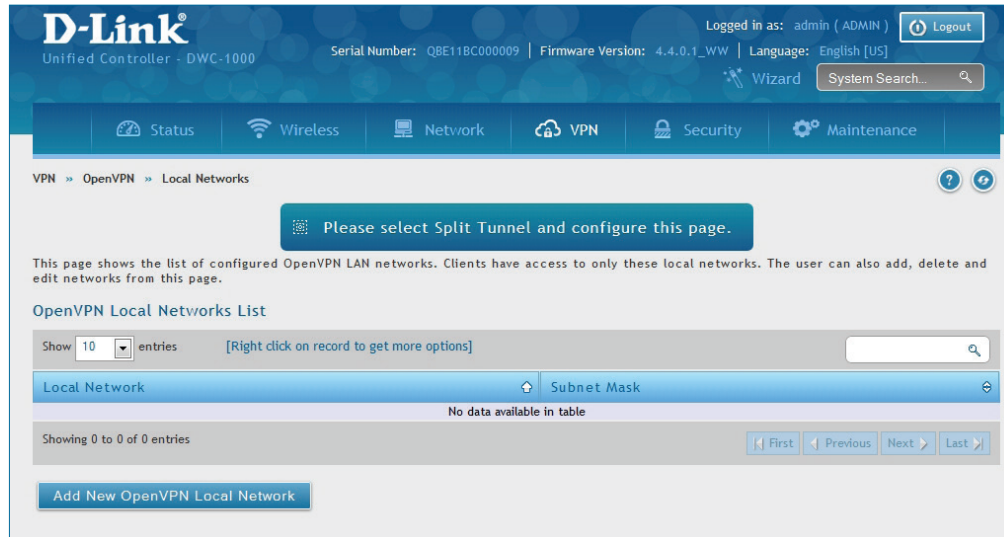

3. Enter a local IP network.
4. Enter the subnet mask.
5. Click **Save**.

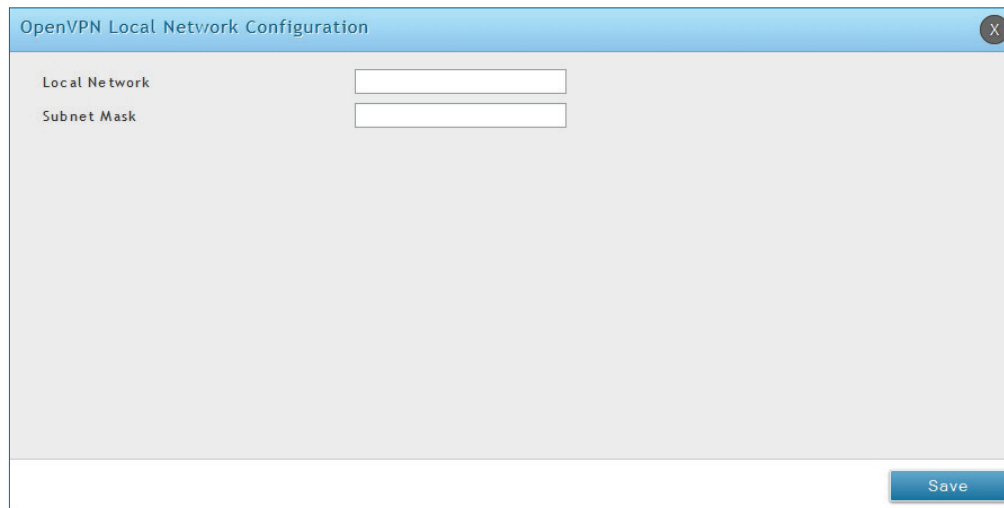

Remote Networks

To create remote networks:

1. Click **VPN > OpenVPN > Remote Networks**.
2. Click **Add New OpenVPN Remote Network**.

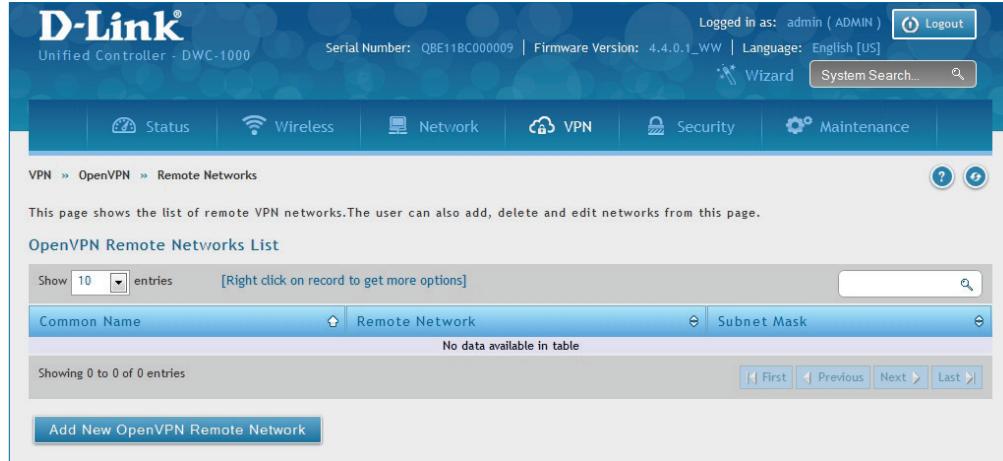

3. Enter a name of the remote network.
4. Enter a local IP network.
5. Enter the subnet mask.
6. Click **Save**.

The screenshot shows the "OpenVPN Remote Network Configuration" dialog box. It contains three input fields: "Common Name", "Remote Network", and "Subnet Mask". A "Save" button is located at the bottom right of the dialog box.

Authentication

Path: VPN > OpenVPN > Authentication

This page will allow you to upload certificates and keys. Click **Browse** and select the file you want to upload. Click **Open**, and then click **Upload**.

The screenshot shows the D-Link OpenVPN Authentication configuration page. The page is titled "OpenVPN Authentication" and includes a navigation menu with options like Status, Wireless, Network, VPN, Security, and Maintenance. The main content area contains several sections for configuring authentication:

- Upload Only CA Certificate:** A toggle switch is set to "off". Below it are "Save" and "Cancel" buttons.
- Trusted Certificate (CA Certificate):** The "Certificate Status" is set to "Yes". There is a "Browse Certificate File" button (showing "No file selected.") and an "Upload" button.
- Server / Client Certificate:** The "Certificate Status" is set to "Yes". There is a "Browse Certificate File" button (showing "No file selected.") and an "Upload" button.
- Server / Client Key:** The "Key Status" is set to "Yes". There is a "Browse Key File" button (showing "No file selected.") and an "Upload" button.
- DH Key:** The "Key Status" is set to "Yes". There is a "Browse Key File" button (showing "No file selected.") and an "Upload" button.
- TLS Authentication Key:** The "Key Status" is set to "No". There is a "Browse Key File" button (showing "No file selected.") and an "Upload" button.
- CRL Certificate:** The "Certificate Status" is set to "No". There is a "Browse Certificate File" button (showing "No file selected.") and an "Upload" button.

Field	Description
Upload Only CA Certificate	On/Off button for uploading only CA certificate. This feature is for "Allow only User Based Auth" feature in OpenVPN Settings Page .
Trusted Certificate (CA Certificate)	Browse and upload the pem formatted CA Certificate.
Server/Client Certificate	Browse and upload the pem formatted Server/Client Certificate.
Server/Client Key	Browse and upload the pem formatted Server/Client Key.
DH Key	Browse and upload the pem formatted Diffie Hellman Key.
TLS Authentication Key	Browse and upload the pem formatted TLS Authentication Key.
CRL Certificate	Browse and upload the pem formatted CRL certificate to revoke the client certificate.

Status and Statistics

This chapter describes the following pages, which display wireless controller and access point status information and statistics.

- “Viewing Statistic and Utilization” on page 285
- “Manage Dashboard” on page 287
- “System Information” on page 289
- “Network Information” on page 291
- “Wireless Information” on page 298
- “ACL & DiffServ Status” on page 332

Viewing Statistic and Utilization

Path: Status > Dashboard

The wireless controller provides a dashboard that displays about the resources the system is using . It presents hardware and usage statistics. The CPU and Memory utilization is a function of the available hardware, current configuration, and traffic through the controller. Interface statistics for the wired connections (LAN, Option1, Option2/DMZ, VLANs) provide indication of packets through and packets dropped by the interface. Click **Refresh** to have this page retrieve the most current statistics.

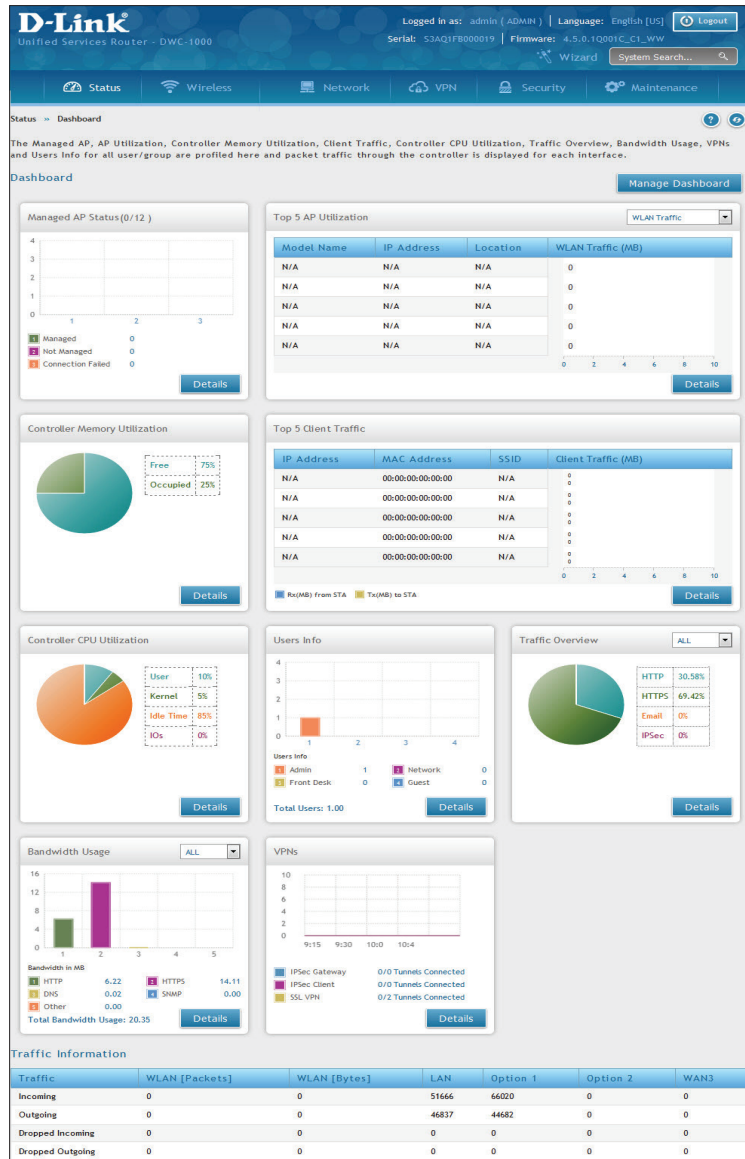

Section	Description
Memory AP Status (X/Y)	Graphical representation of total APs in connected, disconnected, and Connection failure state. (X/Y) X: represents number of AP managed by controller. Y: represents number of total AP supported by the controller, based on the licenses installed. Click on Details to get a list of APs with Model Name, Firmware, MAC Address, IP Address, Location, Status, and System UpTime.
Top 5 AP Utilization	Graphical representation of Top 5 AP Utilization based on the individual WLAN traffic. WLAN Traffic shows the MB traffic consumption of AP. RF Utilization shows RF Utilization percentage (2.4 GHz and 5 GHz) of AP. Authenticated Clients show associated clients to AP. Click on Details to get detailed AP Statistics including Model Name, IP Address, Location, MAC Address, Firmware, AP Up Time, Auth. Clients, WLAN Traffic, RF Utilization 5G, and RF Utilization 2.4G
Controller Memory Utilization	Graphical representation of total memory utilization. Click on Details to get detailed numbers of Total Memory, Used Memory, Free Memory, Cached Memory, Buffer Memory in MBs.
Top 5 Client Traffic	Graphical representation of Top 5 Client based on the individual WLAN traffic. Click on Details to get detailed Client Statistics including Client IP Address, Client MAC Address, SSID, AP MAC Address, AP Location, Channel, NetBIOS, Rx Traffic (MB), and Tx Traffic (MB)
Controller CPU Utilization	Percent of the CPU utilization currently consumed by the device. The CPU utilization is broken down into specifics such as all user space processes, such as management operations, kernel space processes, and CPU idle time or IO.
Users Info	Graphical representation of total connected clients of different groups. Click on Details to get detailed counts of Admin Users Logged in, Guest Uses Logged in, Captive Portal uses Logged in, Front Desk Users Logged in, SSLVPN Users Logged in, PPTP Users Logged in, and L2TP Users Logged in.
Traffic Overview	Graphical representation of traffic generated using these protocols http, email, IPsec, https. Click on Details to get detailed traffic in KB for different protocols such as HTTP, HTTPS, DNS, IMAP2, IMAP3, NFS, POP3, SMTP, SNMP, SSH, and TELNET of all interfaces.
Bandwidth Usage	Displays bandwidth usage by network segment such as WLAN or LAN. The data is broken into by applications service such as HTTP, HTTPS, DNS, SNMP, and others.
VPN's	Displays the current number of concurrent and active IPsec and SSL VPN sessions.
Traffic Information	Displays a grid of traffic statistics (incoming, outgoing, dropped in and dropped out packets) for each interface.

Manage Dashboard

To manage the dashboard:

1. Click on the **Manage Dashboard** button.



2. The following window will pop out and allow you to enable or disable the overview panels shown on the dashboard. Toggle the panel to **On** or **Off** and click **Save**.



Detail Information

You can review detail information or statistic by clicking the **Detail** button on each widget.

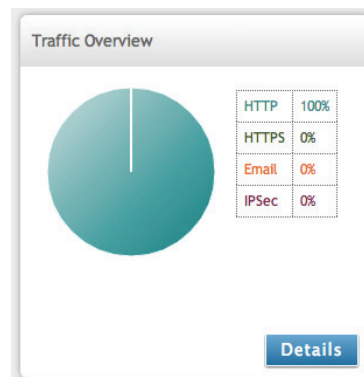

The Traffic Overview Details window shows the following data for the LAN interface:

LAN	
HTTP	28.303711 KB
HTTPS	0.000000 KB
DNS	0.000000 KB
IMAP2	0.000000 KB
IMAP3	0.000000 KB
NFS	0.000000 KB
POP3	0.000000 KB
SMTP	0.000000 KB
SNMP	0.000000 KB
SSH	0.000000 KB

The Traffic Information table shows detailed transmit and receive statistics for each physical port. This includes:

- Port-specific packet-level information for each interface (LAN and VLANs)
- Transmitted and received packets
- Cumulating bytes/sec for transmit/receive directions for each interface

If you suspect issues with any of the wired ports, use this table to identify uptime or transmit level issues with the port. The statistics table has an auto-refresh control for displaying the most current port level data at each page refresh. The default auto-refresh for this page is 10 seconds.

System Information

Viewing System Status

Path: Status > System Information > Device

The Device Info page summarizes the wireless controller configuration settings configured in the Setup and Advanced menus. This page is organized into the following sections:

- General - Shows system name, firmware version, WLAN module version, and serial number.
- Port Information – Shows information based on the administrator configuration parameters. Note that LAN1 will display the local interface of the controller. If you set any of the LAN ports to Standalone, information will be displayed under the corresponding LAN heading.

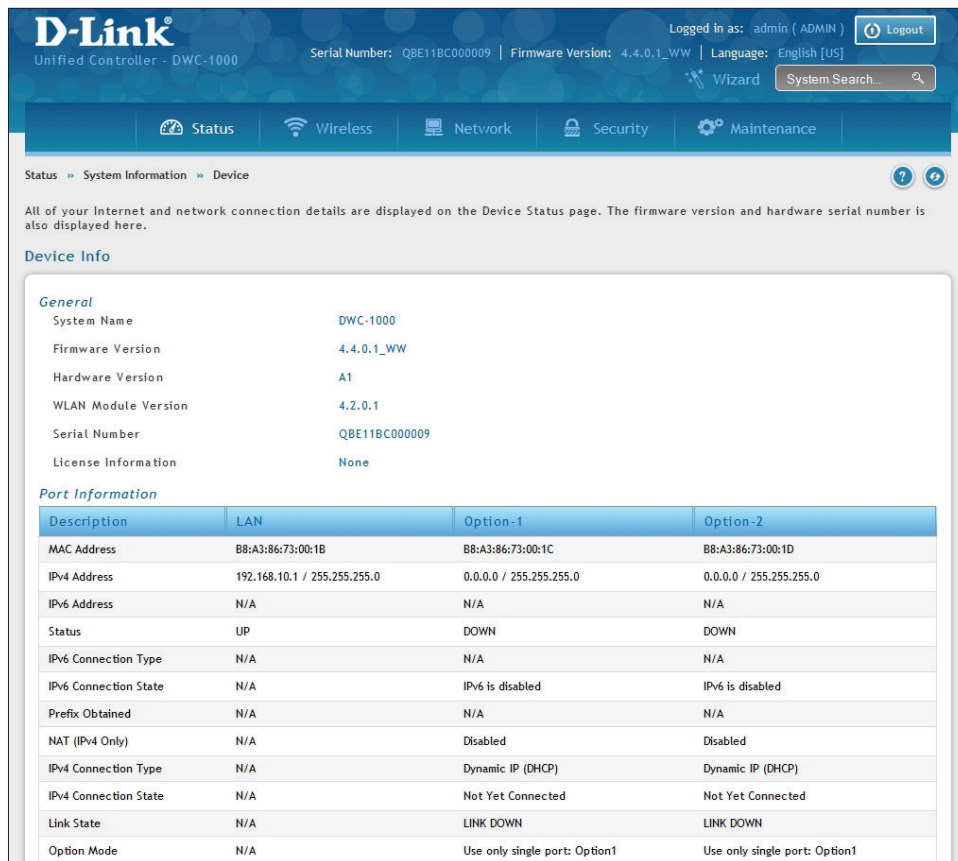

The screenshot shows the D-Link Unified Controller (DWC-1000) web interface. The top navigation bar includes Status, Wireless, Network, Security, and Maintenance. The current page is 'Status > System Information > Device'. The page displays the following information:

Device Info

All of your Internet and network connection details are displayed on the Device Status page. The firmware version and hardware serial number is also displayed here.

General

System Name	DWC-1000
Firmware Version	4.4.0.1_WW
Hardware Version	A1
WLAN Module Version	4.2.0.1
Serial Number	QBE11BC000009
License Information	None

Port Information

Description	LAN	Option-1	Option-2
MAC Address	B8:A3:86:73:00:1B	B8:A3:86:73:00:1C	B8:A3:86:73:00:1D
IPv4 Address	192.168.10.1 / 255.255.255.0	0.0.0.0 / 255.255.255.0	0.0.0.0 / 255.255.255.0
IPv6 Address	N/A	N/A	N/A
Status	UP	DOWN	DOWN
IPv6 Connection Type	N/A	N/A	N/A
IPv6 Connection State	N/A	IPv6 is disabled	IPv6 is disabled
Prefix Obtained	N/A	N/A	N/A
NAT (IPv4 Only)	N/A	Disabled	Disabled
IPv4 Connection Type	N/A	Dynamic IP (DHCP)	Dynamic IP (DHCP)
IPv4 Connection State	N/A	Not Yet Connected	Not Yet Connected
Link State	N/A	LINK DOWN	LINK DOWN
Option Mode	N/A	Use only single port: Option1	Use only single port: Option1

Viewing USB Status

Path: Status > System Information > USB Status

The USB Status page summarizes the USB devices connected to the wireless controller. The wireless controller allows to connect USB printer and USB disk (for firmware upgrade only) directly. There are two USB ports.

The D-Link Wireless Controller has a USB interface for printer access, and file sharing. There is no configuration on the GUI to enable USB device support. Upon inserting your USB storage device, printer cable, the DWC Controller will automatically detect the type of connected peripheral.

- **USB Mass Storage:** Also referred to as a “share port”, files on a USB disk connected to the DWC can be accessed by LAN users as a network drive.
- **USB Printer:** The DWC can provide the LAN with access to printers connected through the USB. The printer driver will have to be installed on the LAN host and traffic will be routed through the DSR between the LAN and printer.

To configure printer on a Windows machine, follow the steps given below:

- Click **'Start'** on the desktop.
- Select **'Printers and faxes'** option.
- Right click and click **'add printer'** or click **'Add printer'** present at the left menu.
- Select the **'Network Printer'** radio button and click **Next** (select “Device isn't listed in case of Windows7”).
- Select the **'Connect to printer using URL'** radio button (**'Select a shared printer by name'** in case of Windows 7) and give the following URL `http://<Router's LAN IP address>:631/printers/<Model Name>` (Model Name can be found in the USB status page of router's GUI).
- Click **'next'** and select the appropriate driver from the displayed list.
- Click on **'next'** and **'finish'** to complete adding the printer.

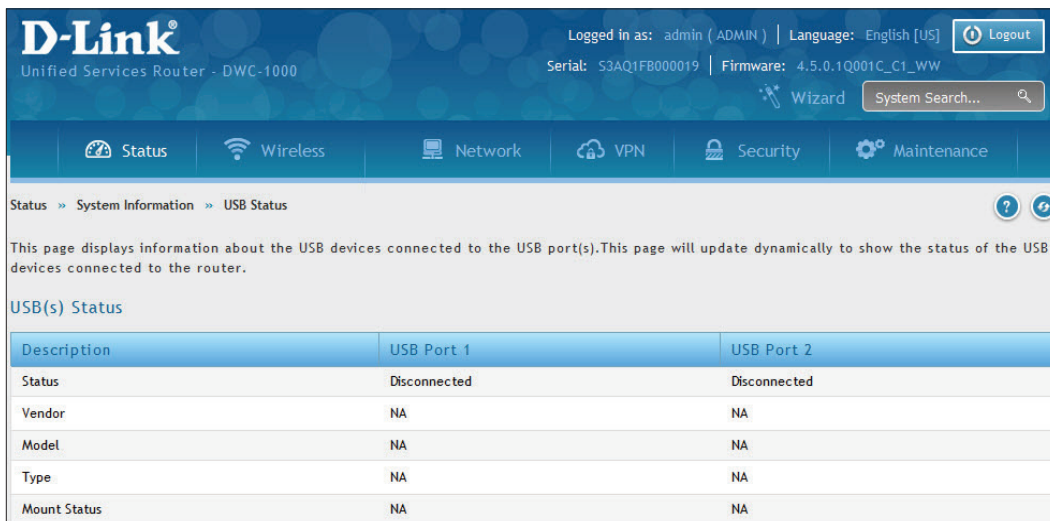

The screenshot shows the D-Link Unified Services Router (DWC-1000) GUI. The user is logged in as 'admin (ADMIN)' and the language is set to 'English [US]'. The router's serial number is 'S3AQ1F8000019' and the firmware version is '4.5.0.1Q001C_C1_WW'. The navigation menu includes Status, Wireless, Network, VPN, Security, and Maintenance. The current page is 'Status >> System Information >> USB Status'. A message states: 'This page displays information about the USB devices connected to the USB port(s). This page will update dynamically to show the status of the USB devices connected to the router.' Below this is a table titled 'USB(s) Status' with columns for 'Description', 'USB Port 1', and 'USB Port 2'. The table shows that both ports are 'Disconnected'.

Description	USB Port 1	USB Port 2
Status	Disconnected	Disconnected
Vendor	NA	NA
Model	NA	NA
Type	NA	NA
Mount Status	NA	NA

Network Information

Viewing DHCP Clients

Path: Status > Network Information > DHCP Leased Clients > LAN Leased Clients

Two separated tabs shows a list of clients that have got IP leased from the wireless controller: LAN leased clients and LAN IPv6 leased clients.

The screenshot shows the D-Link Unified Controller interface. At the top, it displays the D-Link logo, 'Unified Controller - DWC-1000', and system information including 'Serial Number: QBE11BC000009', 'Firmware Version: 4.4.0.1_WW', and 'Language: English [US]'. The user is logged in as 'admin (ADMIN)'. The navigation menu includes 'Status', 'Wireless', 'Network', 'Security', and 'Maintenance'. The breadcrumb path is 'Status >> Network Information >> DHCP Clients >> LAN Leased Clients'. Below the breadcrumb, there are three tabs: 'LAN Leased Clients' (selected), 'IPv6 Leased Clients', and 'DMZ Leased Clients'. A descriptive text states: 'This table displays the list of DHCP clients connected to the LAN DHCP Server and to whom DHCP Server has given leases. If the LAN is serving DHCP addresses, this table will show the list of DHCP clients for the router's LAN DHCP server.' The section is titled 'LAN Leased Clients List'. It features a search bar and a dropdown menu set to '10' entries. Below this is a table with columns for 'Host Name', 'IP Address', and 'MAC Address'. The table is currently empty, displaying 'No data available in table'. At the bottom, it shows 'Showing 0 to 0 of 0 entries' and navigation buttons for 'First', 'Previous', 'Next', and 'Last'.

The screenshot shows the D-Link Unified Controller interface, similar to the previous one. The breadcrumb path is 'Status >> Network Information >> DHCP Clients >> IPv6 Leased Clients'. The 'IPv6 Leased Clients' tab is selected. The descriptive text states: 'This table displays the list of DHCPv6 clients connected to the LAN DHCPv6 Server and to whom DHCPv6 Server has given leases. If the LAN is serving DHCPv6 addresses, this table will show the list of DHCPv6 clients for the router's LAN DHCPv6 server.' The section is titled 'IPv6 Leased Clients List'. It features a search bar and a dropdown menu set to '10' entries. Below this is a table with columns for 'Host Name', 'IP Address', and 'MAC Address'. The table is currently empty, displaying 'No data available in table'. At the bottom, it shows 'Showing 0 to 0 of 0 entries' and navigation buttons for 'First', 'Previous', 'Next', and 'Last'.

Viewing Captive Portal Sessions

Path: Status > Network Information > Captive Portal Sessions

The active run time internet sessions through the controller's managed AP's is listed in the below table. These users are present in the local or external user database and have had their login credentials approved for internet access.

If Internet session passthrough is enabled, select the session and right-click **Disconnect** allowing the admin to selectively drop an authenticated user.

Select the session and right-click **Block device**. The "Block Device" button will result in the selected client being added to the blocked list (Security > Firewall > Blocked Clients), and the current and future sessions from this client will be prevented.

The screenshot shows the D-Link Unified Services Router (DWC-1000) web interface. The top navigation bar includes links for Status, Wireless, Network, VPN, Security, and Maintenance. The main content area is titled "Captive Portal Sessions" and contains a table with the following columns: "User Name" and "IP Address". The table is currently empty, displaying the message "No data available in table". The interface also includes a search bar and pagination controls at the bottom.

Viewing Active Sessions

Path: Status > Network Information > Active Sessions

The Active Sessions page shows the following information about the active Internet sessions through the wireless controller:

- Source
- Destination
- Protocol used during the Internet sessions
- State

D-Link
Unified Services Router - DWC-1000

Logged in as: admin (ADMIN) | Language: English [US] | Logout

Serial: S3AQ1FB000019 | Firmware: 4.5.0.1Q001C_C1_WW

Wizard | System Search...

Status | Wireless | Network | VPN | Security | Maintenance

Status >> Network Information >> Active Sessions

Use this page to monitor the sessions that are active on your router.

Active Sessions List

Show 10 entries [No right click options]

Source	Destination	Protocol	State
No data available in table			

Showing 0 to 0 of 0 entries

First | Previous | Next | Last

Viewing VPN Sessions

Note: This feature is only available when the DCS-1000-VPN license is activated.

Path: Status > Network Information > Active VPNs > IPsec SAs

The Active VPN Sessions page displays the following information about the active VPN sessions through the wireless controller:

- Policy Name
- Endpoint
- Transfer Rate (KB and Packets)
- Configuration State

Click the tab of the VPN session you want to view (IPSec, SSL, PPTP, or Open VPN).

The screenshot displays the D-Link Unified Controller web interface. At the top, the D-Link logo and 'Unified Controller - DWC-1000' are visible. The user is logged in as 'admin (ADMIN)' with a 'Logout' button. System information includes 'Serial Number: QBE11BC000009', 'Firmware Version: 4.4.0.1_WW', and 'Language: English [US]'. A 'Wizard' button and a 'System Search...' field are also present. The main navigation bar includes 'Status', 'Wireless', 'Network', 'VPN', 'Security', and 'Maintenance'. The breadcrumb trail is 'Status > Network Information > Active VPNs > Active IPsec SAs'. Below this, there are four tabs: 'Active IPsec SAs', 'Active SSL VPN Connections', 'Active PPTP VPN Connections', and 'Active Open VPN Connections'. The 'Active IPsec SAs' tab is selected. A message states 'This page lists current established IPsec Security Associations.' Below this is the 'Active IPsec SAs List' section, which includes a 'Show 10 entries' dropdown and a search box. The table headers are 'Policy Name', 'Endpoint', 'tx (KB)', 'tx (Packets)', and 'Configuration State'. The table content is empty, displaying 'No data available in table'. At the bottom, it says 'Showing 0 to 0 of 0 entries' and includes navigation buttons for 'First', 'Previous', 'Next', and 'Last'.

Viewing Traffic on Interfaces

Path: Status > Network Information > Interfaces Statistics

This page shows the incoming/outgoing packets on each interface. Table fields are shown on the next page.

The screenshot shows the D-Link Unified Services Router (DWC-1000) web interface. The user is logged in as 'admin (ADMIN)' and the language is set to 'English [US]'. The page title is 'Interfaces Statistics' and it shows the following data:

LAN

Description	LAN	WAN1	WAN2 / DMZ	WAN3
Incoming Packets	5591627	5711576	0	0
Outgoing Packets	5572086	5557149	0	0
Dropped In Packets	0	0	0	0
Dropped Out Packets	0	0	0	0

VLAN

Show 10 entries [No right click options]

Port	Incoming Packets	Outgoing Packets	Dropped In Packets	Dropped Out Packets
LAN2	0	5	0	0
LAN45	0	5	0	0

Showing 1 to 2 of 2 entries

WLAN Info

Data Information	Packets / Bytes
Transmitted	0 / 0
Received	0 / 0
Transmit Dropped	0 / 0
Receive Dropped	0 / 0

Active Info

Description	Count
ICMP Received	32
Active VPN Tunnels	0
Available VLANs	3
Active Interfaces	5

Section	Description
LAN	
Incoming Packets	The number of IP packets entering the port.
Outgoing Packets	The number of packets leaving the port.
Dropped In Packets	Packets dropped on the inbound path of the interface.
Dropped Out Packets	Packets dropped on the outbound path of the interface.
VLAN	
Port	The port that the VLAN is associated with.
Incoming Packets	The number of IP packets entering the port.
Outgoing Packets	The number of packets leaving the port.
Dropped In Packets	Packets dropped on the inbound path of the interface.
Dropped Out Packets	Packets dropped on the outbound path of the interface.
WLAN Info	
Transmitted	Total packets transmitted across all APs managed by the controller.
Received	Total packets received across all APs managed by the controller.
Transmit Dropped	Total packets transmitted across all APs managed by the controller that were dropped.
Receive Dropped	Packets dropped on the inbound path of the interface.
Active Info	
ICMP Received	Displays the total number of ICMP packets received on the interface.
Active VPN Tunnels	Displays the current number of concurrent and active IPsec and SSL VPN sessions.
Available VLANs	Displays the current number of enabled and active VLAN interfaces.
Active Interfaces	Displays the number of enabled interfaces.
Count	Displays the count for number of packets.

IPv6 Tunnels Status

Path: Network > IPv6 > IPv6 Tunnels Status

This page lists configured and active IPv6 tunnels for routing IPv6 traffic through the appliance.

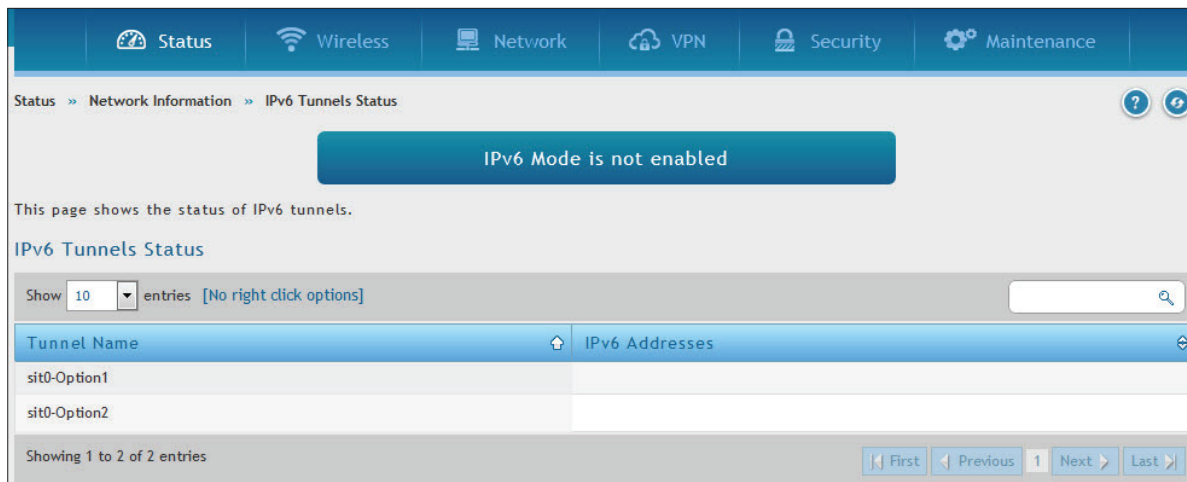

The fields available on the IPv6 Tunnels Status page are:

- **Tunnel Name:** The active IPv6 to IPv4 tunnel identifier.
- **IPv6 Addresses:** The source IPv6 address(es) in your LAN that have data being sent over this tunnel.

Wireless Information

Viewing Controller Status and Statistics

Path: Status > Wireless Information > Controller Status

This page shows the status and statistics information about the controller.

The screenshot shows the D-Link Unified Controller - DWC-1000 web interface. The top navigation bar includes Status, Wireless, Network, Security, and Maintenance. The current page is 'Controller Status' under 'Wireless Information'. The page displays the following information:

WLAN Controller Operational Status	Enabled
IP Address	192.168.10.1
Peer Controllers	0
Cluster Controller	Yes
Cluster Controller IP Address	192.168.10.1

Field	Description
WLAN Controller Operational Status	This status field displays the operational status of the WLAN controller.
IP Address	The IP address of the wireless controller.
Peer Controllers	The number of peer WLAN controllers detected on the network.
Cluster Controller	Indicates whether this controller is the Cluster Controller for the cluster. Among a group of peer Controllers, one of the Controllers is automatically elected or configured to be the Cluster Controller. The Cluster Controller gathers status and statistics about all APs and clients in the peer group. Note: Only the Cluster Controller controller can display managed APs, clients, statistics, and RF Scan databases for the whole cluster. The Controllers that are not Cluster Controllers can display information only about locally attached devices.
Cluster Controller IP Address	The IP address of the peer controller that is the Cluster Controller.

Controller Associated Clients

Path: Status > Wireless Information > Controller Status > Controller Associated Clients

This page shows the controller and its associated clients. If this controller is the Cluster Controller, it will also show the associated clients whom is managed with other peer controllers.

The screenshot shows the D-Link Unified Controller web interface. The top navigation bar includes 'Status', 'Wireless', 'Network', 'Security', and 'Maintenance'. The breadcrumb trail is 'Status > Wireless Information > Controller Status > Controller Associated Clients'. Below the breadcrumb, there are tabs for 'Controller Status', 'Controller Associated Clients', 'Distributed Tunnel', 'Peer Controller Receive Status', and 'Peer Controller Sent Status'. The main content area contains a table titled 'Controller Associated Clients List'. The table has two columns: 'Controller IP Address' and 'Client MAC Address'. The table is currently empty, displaying 'No data available in table'. There are also search and pagination controls.

Field	Description
Controller IP Address	Shows the IP address of the Controller that manages the AP to which the client is associated.
Client MAC Address	Shows the MAC address of the associated client.

Distributed Tunnel

Path: Status > Wireless Information > Controller Status > Distributed Tunnel

The AP-AP tunneling mode is used to support L3 roaming for wireless clients without forwarding any data traffic to the wireless controller.

In the AP-AP tunneling mode, when a client first associates with an AP in the wireless system, the AP forwards the wireless client's data using VLAN forwarding mode. The AP the client initially associates with is called the Home AP. The AP the client roams to is called the Association AP.

The screenshot shows the D-Link Unified Controller web interface. The top navigation bar includes 'Status', 'Wireless', 'Network', 'Security', and 'Maintenance'. The breadcrumb trail is 'Status >> Wireless Information >> Controller Status >> Distributed Tunnel'. Below the breadcrumb, there are tabs for 'Controller Status', 'Controller Associated Clients', 'Distributed Tunnel', 'Peer Controller Receive Status', and 'Peer Controller Sent Status'. The 'Distributed Tunnel' tab is active. The main content area shows 'Distributed Tunneling Status' with a 'Clear Statistics' button. Below this, a table lists four metrics: Tunnel Packets Transmitted (0), Tunnel Roamed Clients (0), Tunnel Clients (0), and Tunnel Client Denials (0).

Field	Description
Tunnel Packets Transmitted	Total number of packets sent by all APs via distributed tunnels.
Tunnel Roamed Clients	Total number of client that successfully roamed away from Home AP using distributed tunneling.
Tunnel Clients	Total number of clients that are associated with an AP that are using distributed tunneling.
Tunnel Client Denials	Total number of clients for which the system was unable to setup a distributed tunnel when client roamed.
Clear Statistics	Clears the current data.

Peer Controller Receive Status

Path: Status > Wireless Information > Controller Status > Peer Controller Receive Status

The Peer Controller Configuration feature lets you send a wireless configuration from one wireless controller to all other controllers. In addition to keeping the controllers synchronized, this function lets you manage all wireless controllers in the cluster from one controller. The Configuration Receive Status page provides information about the configuration a controller has received from one of its peers.

The screenshot shows the D-Link Unified Controller web interface. The top navigation bar includes 'Status', 'Wireless', 'Network', 'Security', and 'Maintenance'. The breadcrumb trail is 'Status >> Wireless Information >> Controller Status >> Peer Controller Receive Status'. Below the breadcrumb, there are tabs for 'Controller Status', 'Controller Associated Clients', 'Distributed Tunnel', 'Peer Controller Receive Status' (which is active), and 'Peer Controller Sent Status'. The main content area shows the following information:

Peer Controller Receive Status	
<i>Configuration Receive Status</i>	
Current Receive Status	Not Started
<i>Last Configuration Received</i>	
Peer Controller IP Address	0.0.0.0
Configuration	None
Timestamp	Jan 1 00:00:00 1970

Field	Description
Current Receive Status	
Current Receive Status	Global status when wireless configuration is received from a peer controller. Possible status values are: <ul style="list-style-type: none"> • Not Started • Receiving Configuration • Saving Configuration • Applying AP Profile Configuration • Success • Failure - Invalid Code Version • Failure - Invalid Hardware Version • Failure - Invalid Configuration

Last Configuration Received	
Peer Controller IP Address	Peer controller IP address of the last wireless controller from which this controller received any wireless configuration data.
Configuration	Shows which portions of configuration were last received from a peer controller. Possible values are: <ul style="list-style-type: none"> • Global • Discovery • Channel/Power • AP Database • AP Profiles • Known Client • Captive Portal • RADIUS Client • QoS ACL • QoS DiffServ • None = wireless controller has not received any configuration for another controller
Timestamp	Shows the last time this wireless controller received any configuration data from a peer controller. The Peer Controller Managed AP Status page shows information about the access points that each peer controller in the cluster manages. Use the drop-down list at the top of this page to select a peer controller whose access point information you want to view. Each peer controller is identified by its IP address.

Peer Controller Sent Status

Path: Status > Wireless Information > Controller Status > Peer Controller Sent Status

You can push portion of the controller configuration from one controller to another controller in the cluster. The Peer Controller Sent Status page display information about the configuration sent by a peer controller in the cluster. It also identifies the IP address of each peer controller that receive the configuration information.

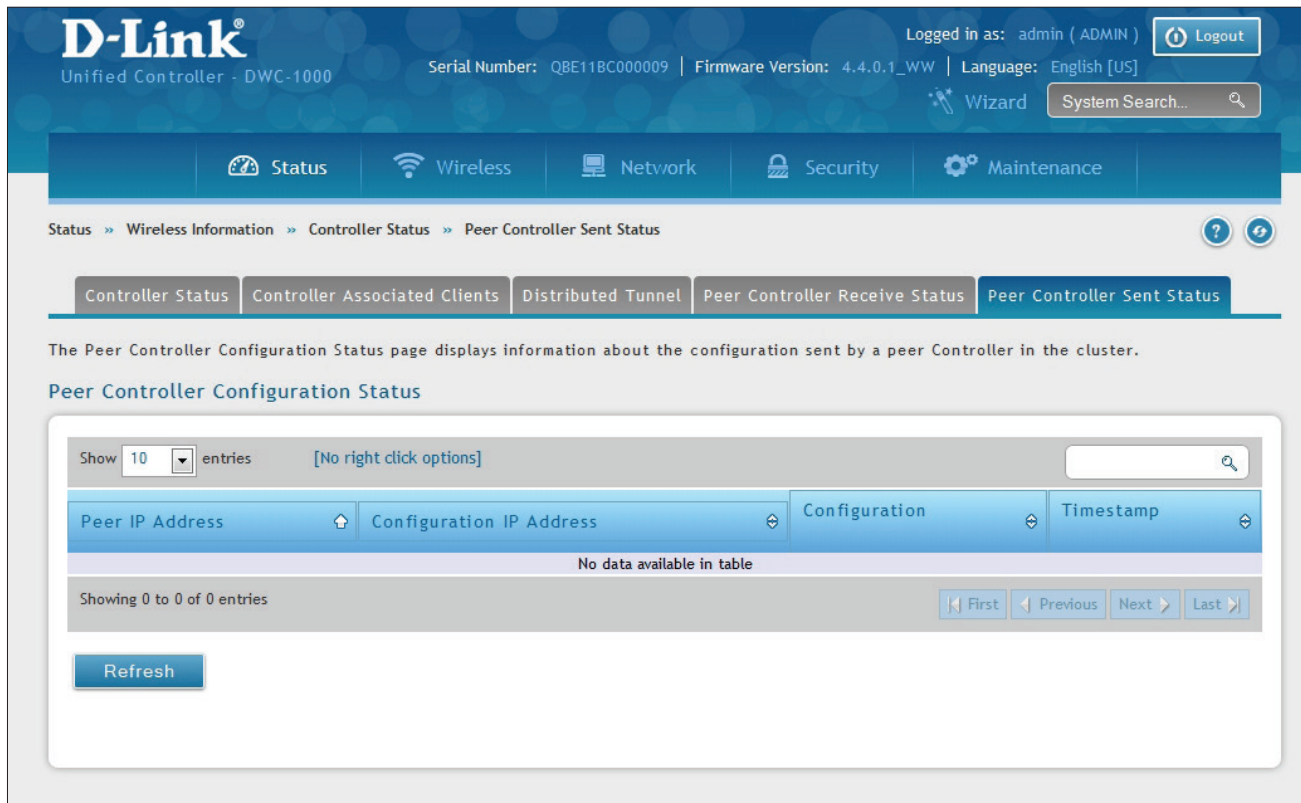

Field	Description
Peer IP Address	Shows the IP address of each peer wireless controller in the cluster that received configuration information.
Configuration IP Address	Shows the IP Address of the controller that sent the configuration information.
Configuration	Identifies which parts of the configuration the controller received from the peer controller. The possible configuration elements can be one or more of the following: <ul style="list-style-type: none"> • Global • Discovery • Channel/Power • AP Database • AP Profiles • Known client • Captive Portal • RADIUS Client
Timestamp	Shows when the configuration was applied to the controller. The time is displayed as UTC time and therefore only useful if the administrator has configured each peer controller to use NTP.

Viewing Access Point Information

Global Status

Path: Status > Wireless Information > Access Point > Global Status

The AP Global Status page shows summary information about managed, failed, and rogue access points the wireless controller has discovered or detected.

The screenshot shows the D-Link Unified Controller interface. At the top, it displays the D-Link logo, the device name 'Unified Controller - DWC-1000', and system information including Serial Number (QBE11BC000009), Firmware Version (4.4.0.1_WW), and Language (English [US]). There is a 'Logout' button and a 'Wizard' button. Below the navigation bar, the breadcrumb path is 'Status > Wireless Information > Access Point > Global Status'. The main content area has tabs for 'Global Status', 'All APs', 'Managed', 'Peer Managed', 'Authentication Failed', 'RF Scan', 'De-Authentication Attacks', and 'Hardware Capability'. A text block explains that the Global page shows status and statistics about the Controller and all associated objects. Below this is the 'APs Global Status' section with a table of statistics.

Field	Description
Total APs	1
Managed APs	1
Standalone APs	0
Rogue APs	11
Discovered APs	0
Connection Failed APs	0
Authentication Failed APs	0
Unknown APs	26
Rogue AP Mitigation Limit	16
Rogue AP Mitigation Count	0
Maximum Managed APs in Peer Group	96
WLAN Utilization	31%

Field	Description
Total APs	Total number of Managed APs in the database. This value is always equal to the sum of Managed Access Points, Connection Failed Access Points, and Discovered Access Points.
Managed APs	Number of APs in the managed AP database that are authenticated, configured, and have an active connection with the Wireless controller.
Standalone APs	Number of trusted APs in Standalone mode. APs in Standalone mode are not managed by a controller.
Rogue APs	Number of Rogue APs currently detected on the WLAN. When an AP performs an RF scan, it might detect access points that have not been validated. It reports these APs as rogues.
Discovered APs	APs that have a connection with the controller, but haven't been completely configured. This value includes all managed APs with a Discovered or Authenticated status.
Connection Failed APs	Number of APs that were previously authenticated and managed, but currently don't have connection with the Wireless controller.
Authentication Failed APs	Number of APs that failed to establish communication with the FASTPATH Unified Wireless controller.

Field	Description
Unknown APs	Number of Unknown APs currently detected on the WLAN. If an AP configured to be managed by the Wireless controller is detected through an RF scan at any time that it is not actively managed it is classified as an Unknown AP.
Rogue AP Mitigation Limit	Maximum number of APs for which the system can send de-authentication frames.
Rogue AP Mitigation Count	Number of APs to which the wireless system is currently sending de-authentication messages to mitigate against rogue APs. A value of 0 indicates that mitigation is not in progress.
Maximum Managed APs in Peer Group	Maximum number of access points that can be managed by the cluster.
WLAN Utilization	Total network utilization across all APs managed by this controller. This is based on global statistics.

All APs

Path: Status > Wireless Information > Access Point > All APs

The All APs List page shows summary information about managed, failed, and rogue access points the wireless controller has discovered or detected. Status entries can be deleted manually.

The screenshot shows the D-Link Unified Controller interface. The top navigation bar includes 'Status', 'Wireless', 'Network', 'Security', and 'Maintenance'. The breadcrumb path is 'Status > Wireless Information > Access Point > All APs'. Below the breadcrumb, there are tabs for 'Global Status', 'All APs', 'Managed', 'Peer Managed', 'Authentication Failed', 'RF Scan', 'De-Authentication Attacks', and 'Hardware Capability'. The 'All APs List' section shows a table with the following data:

MAC Address	IP Address	Age	Status	Radio	Channel
00:1A:97:03:27:DA	N/A	0h:1m:50s	Unknown	802.11b/g	6
00:22:80:3D:8F:90	N/A	0h:9m:50s	Rogue	802.11b/g	1
00:24:01:AB:C7:B8	N/A	0h:10m:50s	Unknown	802.11b/g	1
00:24:01:AB:C7:C8	N/A	0h:10m:50s	Rogue	802.11b/g	1
00:24:01:AB:C7:C9	N/A	0h:10m:50s	Unknown	802.11b/g	1
00:24:01:AB:C8:88	N/A	0h:10m:50s	Rogue	802.11b/g	1
00:24:01:AB:C8:89	N/A	0h:10m:50s	Unknown	802.11b/g	1
00:24:01:AB:CD:98	N/A	0h:3m:51s	Rogue	802.11b/g	6
00:24:01:AB:CD:C8	N/A	0h:0m:51s	Rogue	802.11b/g	11
00:24:01:AB:CD:E8	N/A	0h:10m:50s	Rogue	802.11b/g	1

Field	Description
MAC Address	MAC address of the access point.
IP Address	IP address of the access point.
Age	Amount of time that has passed since the access point was last detected and the information was last updated.
Status	<p>Access point status. Possible values are:</p> <ul style="list-style-type: none"> Managed = access point profile configuration has been applied to the access point and the access point is operating in managed mode. No Database Entry = access point's MAC address does not appear in the local or RADIUS Valid AP database. Authentication (Failed AP) = access point failed to be authenticated by the wireless controller or RADIUS server. Failed = wireless controller lost contact with the access point. A failed entry will remain in the Managed AP database unless you remove it. Note: a managed access point shows a failed status temporarily during a reset. Rogue = access point has not tried to contact the wireless controller and the access point's MAC address is not in the Valid AP database.
Radio	Wireless radio mode the access point is using.
Channel	Operating channel for the radio.

Managed

Path: Status > Wireless Information > Access Point > Managed

The Managed AP List page shows details about the managed access point. Right clicking a managed access point enables more options.

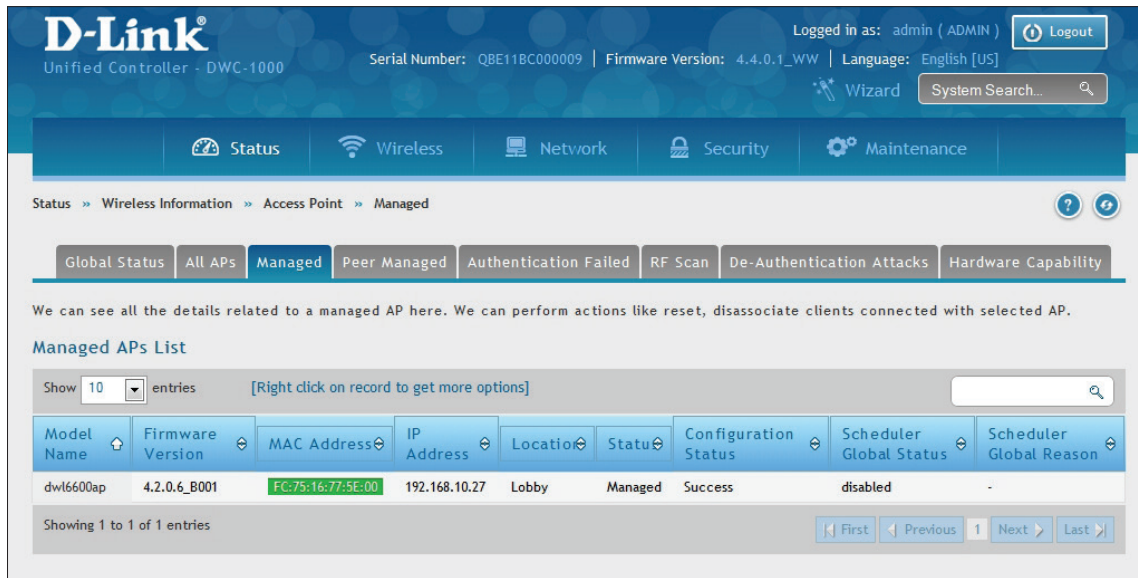

Field	Description
Model Name	The model of the managed AP.
Firmware Version	The firmware version of the managed AP.
MAC Address (*) Peer Managed	Ethernet address of the managed access point. If an asterisk (*) follows the MAC address, the access point is managed by a peer controller.
IP Address	Network IP address of the managed access point.
Location	An optional description of where the AP is physically located. Configured through the AP management section.
Status	<p>Current managed state of the access point. Possible values are:</p> <ul style="list-style-type: none"> Discovered = access point is discovered by the wireless controller, but not authenticated. Authenticated = access point has been validated and authenticated (if authentication is enabled), but it is not configured. Managed = profile configuration has been applied to the access point and the access point is operating in managed mode. Failed = wireless controller lost contact with the access point. A failed entry remains in the Managed AP database, unless you remove it. Note that a managed access point shows a failed status temporarily during a reset. <p>If management connectivity is lost for a managed access point, both of its radios are turned down and all clients associated with the access point are disassociated. The radios resume operation when that access point is managed again by a wireless controller.</p>
Configuration Status	Shows whether the configuration profile applied to the managed access point is successful or not.

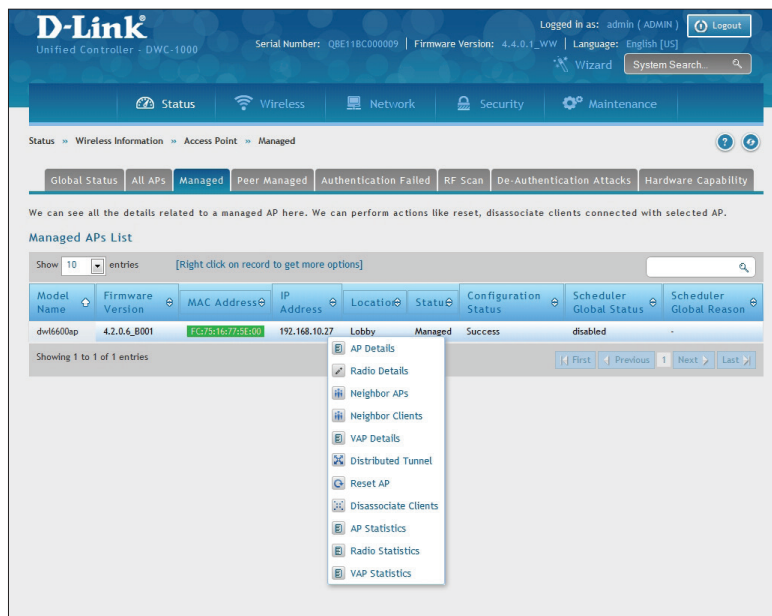

Button	Description
AP Details	Shows detailed status information collected from the access point.
Radio Details	Shows detailed status for a radio interface.
Neighbor APs	Shows the neighbor APs that the specified AP has discovered through periodic RF scans on the selected radio interface.
Neighbor Clients	Shows information about wireless clients associated with an access point or detected by the access point radio.
VAP Details	Shows summary information about the virtual access points (VAPs) for the selected access point and the access point radio interface that the wireless controller manages.
Distributed Tunnel	Shows information about the L2 tunnels currently in use on the access point.
Reset AP	Reset the managed AP back to the factory default settings.
Disassociate Clients	View disassociate clients with the selected AP.

The Managed AP Statistics page shows information about traffic on the access point’s wired and wireless interfaces. This information can help diagnose network issues, such as throughput problems. To view the statistics for a managed access point, right-click on its entry in the Managed AP List and select **AP Statistics**, **Radio Statistics**, and **VAP Statistics**.

Button	Description
AP Statistics	Shows the number and type of packets transmitted and received on a specific access point.
Radio Statistics	Shows per-radio information about the number and type of packets transmitted and received for a specific access point.
VAP Statistics	Shows per-VAP information about the number of packets transmitted and received and the number of wireless client failures for a specific access point.

Peer Managed

Path: Status > Wireless Information > Access Point > Peer Managed

The Peer Controller Managed APs List page provides information about the access points that each peer controller in the cluster manages. Each peer controller is identified by its IP address.

The screenshot shows the D-Link Unified Controller web interface. The top navigation bar includes the D-Link logo, 'Unified Controller - DWC-1000', and system information like 'Serial Number: QBE11BC000009', 'Firmware Version: 4.4.0.1_WW', and 'Language: English [US]'. A 'Logout' button is visible. Below the navigation bar, there are tabs for 'Status', 'Wireless', 'Network', 'Security', and 'Maintenance'. The current page is 'Peer Managed' under 'Access Point' > 'Wireless Information' > 'Status'. A sub-menu includes 'Global Status', 'All APs', 'Managed', 'Peer Managed', 'Authentication Failed', 'RF Scan', 'De-Authentication Attacks', and 'Hardware Capability'. A text block explains that the page displays information about APs managed by peer controllers, identified by their IP addresses. Below this is the 'Peer Controller Managed APs List' section, which includes a 'Show 10 entries' dropdown, a search box, and a table with columns: 'MAC Address', 'AP IP Address', 'PEER IP Address', 'Location', 'Profile', and 'Hardware ID'. The table currently displays 'No data available in table' and has navigation buttons for 'First', 'Previous', 'Next', and 'Last'.

Field	Description
MAC Address	MAC address of each access point managed by the peer controller.
AP IP Address	IP address of the access point.
Peer IP Address	IP address of the peer controller that manages the access point. This field appears when All is selected from the drop-down menu.
Location	Descriptive location configured for the managed access point.
Profile	Access point profile that the wireless controller applies to the access point.
Hardware ID	Hardware ID associated with the access point hardware platform.

Authentication Failed

Path: Status > Wireless Information > Access Point > Authentication Failed

An access point might fail to associate to the wireless controller due to errors such as invalid packet format or vendor ID, or because the access point is not configured as a valid access point with the correct local or RADIUS authentication information. The Authentication Failed APs List page shows information about access points that failed to establish communication with the wireless controller. Right-click on an AP to bring up options to manage, or to view details.

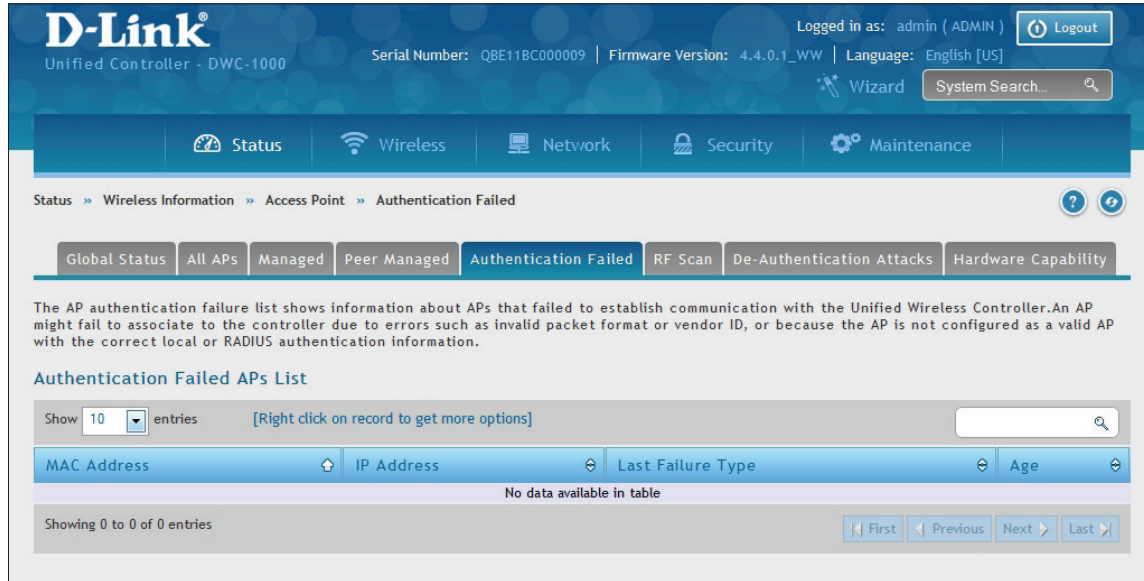

An access point can fail due to any of the reasons:

Failure	Description
No Database Entry	MAC address of the access point is not in the local Valid AP database or the external RADIUS server database, so the access point has not been validated.
Local Authorization	Authentication password configured in the access point did not match the password configured in the local database.
Not Managed	Access point is in the Valid AP database, but the access point Mode in the local database is not set to Managed.
RADIUS Authentication	The password configured in the RADIUS client for the RADIUS server was rejected by the server.
RADIUS Challenged	The RADIUS server is configured to use the Challenge-Response authentication mode, which is incompatible with the access point.
RADIUS Unreachable	The RADIUS server that the access point is configured to use is unreachable.
Invalid RADIUS Response	The access point received a response packet from the RADIUS server that was not recognized or invalid.
Invalid Profile ID	The profile ID specified in the RADIUS database may not exist on the controller. This can also happen with the local database when the configuration has been received from a peer controller.
Profile Mismatch	Hardware Type: The access point hardware type specified in the access point Profile is not compatible with the actual access point hardware.

Fields on the AP Authentication Failure Status Page:

Field	Description
MAC Address	Ethernet address of the AP. If the MAC address of the access point is followed by an asterisk (*), it was reported by a peer controller.
IP Address	IP address of the access point.
Last Failure Type	Last type of failure that occurred. Possible values are: <ul style="list-style-type: none"> • Local Authentication • No Database Entry • Not Managed • RADIUS Authentication • RADIUS Challenged • RADIUS Unreachable • Invalid RADIUS Response • Invalid Profile ID • Profile Mismatch-Hardware Type
Age	Time since failure occurred.

RF Scan

Path: Status > Wireless Information > Access Point > RF Scan

The radio(s) on each access point can scan the radio frequency periodically to collect information about other access points and wireless clients that are within range. In normal operating mode, the access point always scans on the operational channel for the radio. The RF Scan page shows information about other access points and wireless clients that the wireless controller has detected. Right-click on an AP or client to bring up options to view details.

The screenshot shows the D-Link Unified Controller interface. At the top, it displays the user is logged in as 'admin (ADMIN)' and provides system information like 'Serial Number: QBE11BC000009' and 'Firmware Version: 4.4.0.1_WW'. The navigation menu includes Status, Wireless, Network, Security, and Maintenance. The current page is 'RF Scan' under 'Access Point' > 'Wireless Information' > 'Status'. Below the navigation, there are tabs for 'Global Status', 'All APs', 'Managed', 'Peer Managed', 'Authentication Failed', 'RF Scan', 'De-Authentication Attacks', and 'Hardware Capability'. A descriptive paragraph explains that the RF Scan page shows information about all APs detected via RF scan, including those reported as Rogues. Below this is the 'RF Scan APs List' table.

MAC Address	SSID	Physical Mode	Channel	Age	Status
00:1A:97:03:27:DA	DAP-1316-E5-27DA	802.11b/g	6	0d:00:04:16	Unknown
00:22:80:3D:8F:90	dlink1	802.11b/g	1	0d:00:01:17	Rogue
00:24:01:AB:C7:B8	DL VAP w1 g	802.11b/g	1	0d:00:01:17	Unknown
00:24:01:AB:C7:C8		802.11b/g	1	0d:00:01:17	Rogue
00:24:01:AB:C7:C9	vanilla	802.11b/g	1	0d:00:01:17	Unknown
00:24:01:AB:C8:88		802.11b/g	1	0d:00:01:17	Rogue
00:24:01:AB:C8:89	vanilla	802.11b/g	1	0d:00:01:17	Unknown
00:24:01:AB:CD:98		802.11b/g	6	0d:00:06:17	Rogue
00:24:01:AB:CD:C8		802.11b/g	11	0d:00:00:17	Rogue
00:24:01:AB:CD:C9	vanilla	802.11b/g	11	0d:00:00:48	Unknown

Showing 1 to 10 of 38 entries

Field	Description
MAC Address	Ethernet MAC address of the detected access point. This could be a physical radio interface or VAP MAC.
SSID	The wireless name (Service Set Identifier) of the network, which is broadcast in the detected beacon frame.
Physical Mode	The 802.11 mode used on the access point.
Channel	Transmit channel of the access point.
Age	Time since this access point was last detected in an RF scan. Status entries for this page are collected at a point in time and eventually age out. The age value for each entry shows how long ago the wireless controller recorded the entry.
Status	Managed status of the access point. The valid values are: <ul style="list-style-type: none"> • Managed = Neighbor access point is managed by the wireless system. • Standalone = Access point is managed in standalone mode and configured as a valid AP entry (local or RADIUS). • Rogue = Access point is classified as a threat by one of the threat detection algorithms. • Unknown = Access point is detected in the network but is not classified as a threat by the threat detection algorithms.

De-Authentication Attacks

Path: Status > Wireless Information > Access Point > De-Authentication Attacks

The AP De-Authentication Attack page contains information about rogue APs that the Cluster Controller has attacked by using the de-authentication attack feature. The wireless controller can protect against rogue APs by sending de-authentication messages to the rogue AP. The de-authentication attack feature must be globally enabled in order for the wireless system to do this function. Make sure that no legitimate APs are classified as rogues before enabling the attack feature. This feature is disabled by default.

The wireless system can conduct the de-authentication attack against 16 APs at the same time. The intent of this attack is to serve as a temporary measure until the rogue AP is located and disabled.

The de-authentication attack is not effective for all rogue types, and therefore is not used on every detected rogue. The following rogues are not subjected to the attack:

- If the detected rogue is spoofing the BSSID of the valid managed AP, the wireless system does not attempt to use the attack because that attack may deny service to a legitimate AP and provide another avenue for a hacker to attack the system.
- The de-authentication attack is not effective against Ad hoc networks because these networks do not use authentication.
- The APs operating on channels outside of the country domain are not attacked because sending any traffic on illegal channels is against the law.

The wireless controller maintains a list of BSSIDs against which it is conducting a de-authentication attack. The controller sends the list of BSSIDs and channels on which the rogue APs are operating to every managed AP.

The screenshot shows the D-Link Unified Controller web interface. At the top, it displays the D-Link logo, the product name 'Unified Controller - DWC-1000', and system information including the serial number (QBE11BC000009), firmware version (4.4.0.1_WW), and language (English [US]). The user is logged in as 'admin (ADMIN)' and can click 'Logout'. A search bar is available for system search.

The main navigation menu includes 'Status', 'Wireless', 'Network', 'Security', and 'Maintenance'. The current page is 'De-authentication Attacks' under the 'Wireless Information' section.

A prominent red message box states: 'Please enable de-authentication attack'. Below this, there are several filter tabs: 'Global Status', 'All APs', 'Managed', 'Peer Managed', 'Authentication Failed', 'RF Scan', 'De-Authentication Attacks' (selected), and 'Hardware Capability'.

The page contains a descriptive paragraph: 'The AP De-Authentication Attack Status page contains information about rogue APs that the Cluster Controller has attacked by using the de-authentication attack feature. This feature is disabled by default. The wireless controller can protect against rogue APs by sending de-authentication messages to the rogue AP. The de-authentication attack feature must be globally enabled in order for the wireless system to do this function. Make sure that no legitimate APs are classified as rogues before enabling the attack feature.'

The 'De-Authentication Attacks List' section includes a search bar and a table. The table headers are 'BSSID', 'Channel', 'Time Since Attack Started', and 'RF Scan Report Age'. The table currently displays 'No data available in table' and 'Showing 0 to 0 of 0 entries'.

Field	Description
BSSID	Shows the BSSID of the AP against which the attack is launched. The BSSID is a MAC address.
Channel	Identifies the channel on which the rogue AP is operating.
Time Since Attack Started	Shows the amount of time that has passed since the attack started on the AP.
RF Scan Report Age	Shows the amount of time that has passed since the RF Scan reported this AP.

Hardware Capability

Path: Status > Wireless Information > Access Point > Hardware Capability

The wireless controller supports access points that have different hardware capabilities, such as number of radios, supported IEEE 802.11 modes, and software images. Using the AP Hardware Capability page, you view information about the radio hardware and IEEE modes supported by access points, as well as software images that are available for download to the access point.

The screenshot shows the D-Link Unified Controller - DWC-1000 web interface. The user is logged in as 'admin (ADMIN)'. The page title is 'Hardware Capability' under the path 'Status > Wireless Information > Access Point > Hardware Capability'. The page contains a table titled 'List of Hardware Capabilities Supported by APs' with the following data:

Hardware Type	Hardware Type Description	Radio Count	Image Type
hw_dw12600	DWL-2600AP Single Radio b/g/n	1	img_dw12600
hw_dw13600	DWL-3600AP Single Radio b/g/n	1	img_dw13600/6600
hw_dw16600	DWL-6600AP Dual Radio a/b/g/n	2	img_dw13600/6600
hw_dw18600	DWL-8600AP Dual Radio a/b/g/n	2	img_dw18600
hw_dw18610	DWL-8610AP Dual Radio a/b/g/n/ac	2	img_dw18610

Field	Description
Hardware Type	Shows the ID number assigned to each access point hardware type. The wireless controller supports six different types of access point hardware.
Hardware Type Description	Describes the platform and the supported IEEE 802.11 modes.
Radio Count	Shows whether the hardware supports one radio or two radios.
Image Type	Shows the type of software the hardware requires.

The right-click option will display the radio Information for the selected hardware type.

The screenshot shows the 'AP Hardware Radio Capability' dialog box. The information displayed is as follows:

Hardware Type Description	DWL-2600AP Single Radio b/g/n
Radio Mode	Radio - 2
Radio Count	1
802.11a Support	Disable
Radio Type Description	D-Link DWL-2600 b/g/n
802.11bg Support	Enable
VAP Count	16
802.11n Support	Enable
802.11ac Support	Disable

Field	Description
Hardware Type Description	Shows the ID number assigned to each access point hardware type. The wireless controller supports six different types of access point hardware.
Radio Mode	Describes the platform and the supported IEEE 802.11 modes.
Radio Count	Shows whether the hardware supports one radio or two radios.
802.11a Support	Shows whether support for IEEE 802.11a mode is enabled.
Radio Type Description	Displays the type of radio, which might contain information such as the manufacturer name and supported IEEE 802.11 modes.
802.11bg Support	Shows whether support for IEEE 802.11bg mode is enabled.
VAP Count	Displays the number of VAPs the radio supports.
802.11n Support	Shows whether support for IEEE 802.11n mode is enabled.
802.11ac Support	Shows whether support for IEEE 802.11ac mode is enabled.

Associated Clients Global Status

Path: Status > Wireless Information > Associated Clients > Global Status

This page shows statistic information about all the clients which are connected through managed AP.

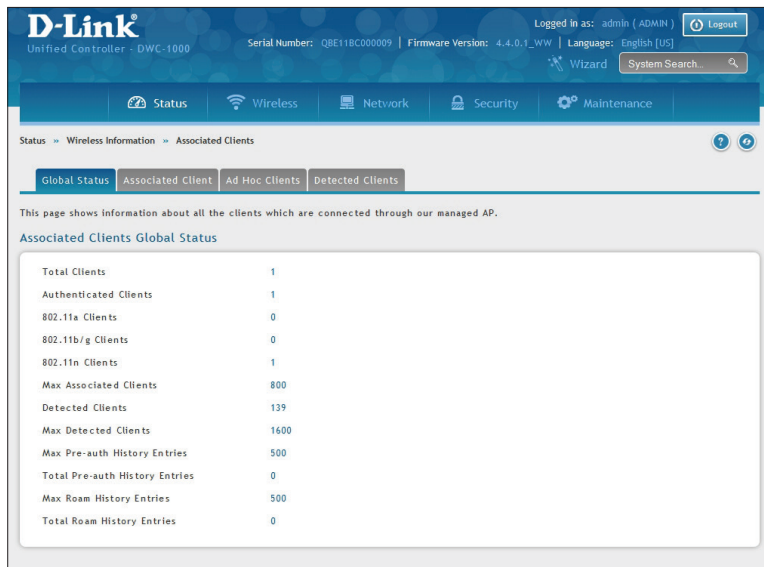

Field	Description
Total Clients	Total number of clients in the database. This total includes clients with an Associated, Authenticated, or Disassociated status.
Authenticated Clients	Total number of clients in the associated client database with an Authenticated status.
802.11a Clients	Total number of IEEE 802.11a-only clients that are authenticated.
802.11b/g Clients	Total number of IEEE 802.11b/g-only clients that are authenticated.
802.11n Clients	Total number of clients that are IEEE 802.11n capable and are authenticated. These include IEEE 802.11a/n, IEEE 802.11b/g/n, 5 GHz IEEE 802.11n, 2.4GHz IEEE 802.11n.
802.11ac Clients	Total number of IEEE 802.11ac-only clients that are authenticated.
Max Associated Clients	Maximum number of clients that can associate with the wireless system. This is the maximum number of entries allowed in the Associated Client database.
Detected Clients	Number of wireless clients detected in the WLAN.
Max Detected Clients	Maximum number of clients that can be detected by the controller. The number is limited by the size of the Detected Client Database.
Max Pre-auth History Entries	Maximum number of Client Pre-Authentication events that can be recorded by the system.
Total Pre-auth History Entries	Current number of pre-authentication history entries in use by the system.
Maximum Roam History Entries	Maximum number of entries that can be recorded in the roam history for all detected clients.
Total Roam History Entries	Current number of pre-authentication history entries in use by the system.

Associated Clients

Path: Status > Wireless Information > Associated Clients > WLAN Associated Clients

The WLAN Associated Clients page tracks the traffic associated with the client connected to the wireless controller. Right-clicking on a client and clicking the **View Details** button displays detailed information about the selected client.

The screenshot shows the D-Link Unified Controller interface. The top navigation bar includes Status, Wireless, Network, Security, and Maintenance. The breadcrumb trail is Status > Wireless Information > Associated Clients > WLAN Associated Clients. Below the breadcrumb trail are tabs for Global Status, Associated Client, Ad Hoc Clients, and Detected Clients. The main content area displays the WLAN Associated Clients List with a table containing one entry. The table has columns for Client MAC Address, Client IP Address, SSID, BSSID, and AP MAC Address. The entry shows Client MAC Address D4:F4:6F:8B:3E:26, Client IP Address 192.168.10.30, SSID dlink1, BSSID FC:75:16:77:5E:10, and AP MAC Address FC:75:16:77:5E:00. Below the table, there are navigation buttons for First, Previous, Next, and Last.

Field	Description
Client MAC Address	Ethernet MAC address of the client station.
Client IP Address	The IP address of the client station.
SSID	Name of the wireless network on which the client is connected.
BSSID	MAC address for the managed access point/virtual access point where this client is associated.
AP MAC Address	Ethernet MAC address of the access point.

The screenshot shows the D-Link Unified Controller interface with a context menu open over the client entry in the WLAN Associated Clients List. The context menu options are: Disconnect, Details, Distributed Tunneling, Neighbor AP Status, Client Statistics, Roam History Details, and Purge Roam History. The table entry is the same as in the previous screenshot.

Field	Description
Disconnect	Disconnects the associated client.
Details	Shows detailed information about the associated client and the AP it is connected to.
Distributed Tunneling	Shows information about distributed tunneling status.
Neighbor AP Status	Shows information about the neighbor AP status.
Client Statistics	Shows detailed statistic information about the associated client and its bandwidth usage.
Roam History Details	Shows a history of the different APs the client has been connected to that are managed by the DWC-1000.
Purge Roam History	Will purge the roam history for the selected client.

After right-clicking next to the MAC address, the Client Statistic page shows the fields in the table on the next page. This page shows information about the traffic a wireless client receives and transmits while it is associated with a single access point. Use the table to view details about an associated client. Each client is identified by its MAC address.



Associated Clients Statistics	
MAC Address	D4:F4:6F:8B:3E:26
Packets Received	2422
Bytes Received	185661
Packets Transmitted	99
Bytes Transmitted	8984
Packets Receive Dropped	0
Bytes Receive Dropped	0
Packets Transmit Dropped	0
Bytes Transmit Dropped	0
Fragments Received	0
Fragments Transmitted	0
Transmit Retries	2
Transmit Retries Failed	1

Field	Description
Packets Received	Total number of packets received from the client station.
Bytes Received	Total number of bytes received from the client station.
Packets Transmitted	Total number of packets transmitted to the client station.
Bytes Transmitted	Total number of bytes transmitted to the client station.
Packets Receive Dropped	Number of packets received from the client stations that were dropped.
Bytes Receive Dropped	Number of bytes received from the client stations that were dropped.
Packets Transmit Dropped	Number of packets transmitted to the client stations that were dropped.
Bytes Transmit Dropped	Number of bytes transmitted to the client stations that were dropped.
Fragments Received	Total number of fragmented packets received from the client station.
Fragments Transmitted	Total number of fragmented packets transmitted to the client station.
Transmit Retries	Number of times transmits to client station succeeded after one or more retries.
Transmit Retries Failed	Number of times transmits to client station failed after one or more retries.
TS Violate Packets Received	Count of packets received by an access point from a wireless client for the specified access category.
TS Violate Packets Transmitted	Count of packets transmitted by an access point to a wireless client for the specified access category.
Duplicates Received	Total number of duplicate packets received from the client station.

To help authenticated clients roam without losing sessions and needing to re-authenticate, wireless clients can try to authenticate to other access points within range of the client. For successful pre-authentication, the target access point must have a VAP with an SSID and security configuration that match the client, including MAC authentication, encryption method, and pre-shared key or RADIUS parameters. The access point that the client is associated with captures all pre-authentication requests and sends them to the controller.

The WLAN Associated Detected Clients Pre-Authentication History List page shows detected clients that have made pre-authentication requests and identifies the access points that received the requests.

Right-clicking next to the MAC address, the Pre-Auth History page shows the fields in the table on the next page.

Pre-Authentication History

MAC Address: 30:C7:AE:1A:D0:98

AP MAC	Radio Interface Number	VAP MAC Address	SSID	User Name	Pre-Auth Status	Age
No data available in table						

Field	Description
MAC Address	MAC address of the client.
AP MAC Address	MAC address of the managed access point to which the client has pre-authenticated.
Radio Interface Number	Radio number to which the client is authenticated (Radio 1 or Radio 2).
VAP MAC Address	VAP MAC address to which the client roamed.
SSID	SSID name used by the VAP.
User Name	User name of client that authenticated via 802.1X.
Pre-Authorization Status	Indicates whether the client successfully authenticated. Shows a status of Success or Failure.
Age	Time since the history entry was added.

The wireless system keeps a record of clients as they roam from one managed access point to another, and displays this information on the WLAN Associated Detected Clients Roam History List.

Right-clicking next to the MAC address, the Roam History page shows the fields in the table below.

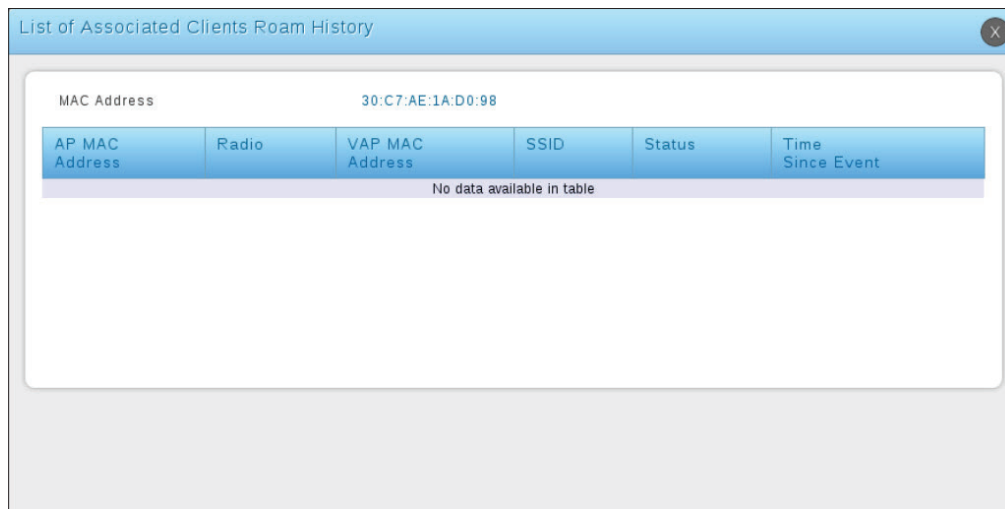

Field	Description
AP MAC Address	MAC address of the managed access point to which the client has pre-authenticated.
Radio	Radio number to which the client is authenticated.
VAP MAC Address	VAP MAC address to which the client roamed.
SSID	SSID name used by the VAP.
Status	A flag indicating whether the history entry represents a new authentication or a roam event.
Time Since Event	Time since the history entry was added.

Ad Hoc Clients

Path: Status > Wireless Information > Associated Clients > Ad Hoc Clients

An ad hoc client is a wireless client that gains access to the WLAN through a wireless client that is associated with an access point. The ad hoc client does not communicate directly with the AP. Ad hoc networks are a particular concern because they consume RF bandwidth and can present a security risk.

Field	Description
MAC Address	The Ethernet address of the client. If the Detection Mode is Beacon then the client is represented as an AP in the RF Scan database and the Neighbor AP List. If the Detection Mode is Data Frame then the client information is in the Neighbor Client List.
AP MAC Address	The base Ethernet MAC Address of the managed AP which detected the client.
Location	The configured descriptive location for the managed AP.
Radio	The radio interface and its configured mode that detected the ad hoc device.
Detection Mode	The mechanism of detecting this Ad Hoc device. The possible values are Beacon Frame or Data Frame.
Age	Time since last detection of the ad hoc network.

Right-click Commands on the WLAN Associated Ad Hoc Clients List

Field	Description
Delete All	Deletes all ad hoc client entries from the list. Clearing the list does not disassociate any of the ad hoc clients, and the clients might still be involved in the ad hoc network.
Deny	Blocks an ad hoc client from WLAN access. The MAC address is added to the Known Client database where the default action is Deny.
Allow	Allows an ad hoc client access to the WLAN. The MAC address is added to the Known Client database where the default action is Allow.

Detected Clients

Path: Status > Wireless Information > Associated Clients > Detected Clients

Wireless clients are detected by the wireless system either when the clients attempt to interact with the system or when the system detects traffic from the clients. The Detected Client Status page shows information about clients that have authenticated with an access point as well information about clients that disassociate and are no longer connected to the system.

The screenshot shows the D-Link Unified Controller interface. The top navigation bar includes 'Status', 'Wireless', 'Network', 'Security', and 'Maintenance'. The current page is 'Detected Clients' under 'Wireless Information > Associated Clients'. A breadcrumb trail is visible: 'Status >> Wireless Information >> Associated Clients >> Detected Clients'. Below the breadcrumb, there are tabs for 'Global Status', 'Associated Client', 'Ad Hoc Clients', and 'Detected Clients'. A descriptive text states: 'The Detected Client Status page contains information about clients that have authenticated with an AP as well information about clients that disassociate and are no longer connected to the system.' Below this is the 'WLAN Associated Detected Clients List' section, which includes a search bar and a table with the following data:

MAC Address	Client Name	Client Status	Age	Create Time
00:08:6B:B5:A4:8D		Detected	0d:00:00:10	0d:00:23:44
00:08:6B:B5:A4:FD		Detected	0d:00:23:44	0d:00:23:44
00:15:99:CE:2F:B5		Detected	0d:00:00:10	0d:00:23:44
00:15:99:CE:2F:CD		Detected	0d:00:00:10	0d:00:23:44
00:15:99:CE:2F:DD		Detected	0d:00:00:10	0d:00:23:44
00:1C:F0:79:0E:61		Detected	0d:00:00:40	0d:00:23:44
00:23:14:59:7D:DC		Detected	0d:00:01:11	0d:00:18:44
00:23:14:AE:F8:98		Detected	0d:00:00:10	0d:00:03:10
00:23:14:F4:E5:68		Detected	0d:00:00:40	0d:00:23:44
00:24:01:9B:DB:B2		Detected	0d:00:17:15	0d:00:23:44

Showing 1 to 10 of 147 entries

Fields on the Detected Client Status Page are shown in the table below:

Field	Description
MAC Address	Ethernet MAC address of the client.
Client Name	Name of the client, if available, from the Known Client Database. If the client is not in the database, the field is blank.
Client Status	Client status, which can be one of the following values: <ul style="list-style-type: none"> Authenticated = wireless client is authenticated with the wireless system. Detected = wireless client is detected by the wireless system, but is not a security threat. Black-Listed = client with this MAC address is specifically denied access via MAC authentication. Rogue = client is classified as a threat by one of the threat-detection algorithms.
Age	Time since any event has been received for this client that updated the detected client database entry.
Create Time	Time since this entry was first added to the detected client database.

Right-click commands on the WLAN Detected Clients List are listed below:

Field	Description
Details	Show detail information about the selected client.
Pre-Auth History	The Detected Client Pre-Authentication History page shows information about the pre-authentication requests that the detected client has made.
Roam History Details	A record of clients as they roam from one managed AP to another managed AP. A history of up to 10 APs is kept for each client.
Purge Roam History	Clears current roam history data from Roam History section.
Triangulation Detail	The Detected Client Triangulation page lists up to three non-sentry and three sentry managed APs that have detected the client.
Rogue Classification	The Wireless Intrusion Detection System (WIDS) can help detect intrusion attempts into the wireless network and take automatic actions to protect the network. The Unified Wireless controller allows you to activate or deactivate various threat detection tests and set threat detection thresholds. The WIDS Client Rogue Classification page provides information about the results of these tests. If a client has been classified as a rogue, this page provides information about which tests the client might have failed to trigger the classification.
Purge Pre-auth History	Clears pre auth data from Pre-Auth History section.

Viewing Radius Accounting Server Statistics

Path: Status > Wireless Information > Radius Accounting Server Statistics

You can view the statistical information for each RADIUS Accounting server configured on the system.

The screenshot displays the 'RADIUS Accounting Server Statistics' page. At the top, there is a navigation menu with tabs for Status, Wireless, Network, VPN, Security, and Maintenance. Below the menu, the breadcrumb trail reads 'Status > Wireless Information > Radius Accounting Server Statistics'. A descriptive text states: 'Use the RADIUS Accounting Statistics page to view statistical information for each RADIUS Accounting server configured on the system.' The main content area is titled 'RADIUS Accounting Server Statistics' and features a search bar and a 'Show 10 entries [No right click options]' dropdown. Below this is a table with the following columns: Server IP, Round Trip Time (Sec), Requests, Retransmissions, Responses, Malformed Access Responses, Bad Authenticators, Pending Requests, Timeouts, Unknown Types, and Packets Dropped. The first row of data shows: 192.168.1.2, 0.00, 0, 0, 0, 0, 0, 0, 0, 0, 0. At the bottom, it indicates 'Showing 1 to 1 of 1 entries' and includes navigation buttons for First, Previous, 1, Next, and Last.

Field	Description
Accounting Server Host Address	Use the drop-down menu to select the IP address of the RADIUS accounting server for which to display statistics.
Round Trip Time (secs)	Displays the time interval, in hundredths of a second, between the most recent Accounting-Response and the Accounting-Request that matched it from this RADIUS accounting server.
Accounting Requests	The number of RADIUS Accounting-Request packets sent to this server. This number does not include retransmissions.
Accounting Retransmissions	The number of RADIUS Accounting-Request packets retransmitted to this server.
Accounting Responses	Displays the number of RADIUS packets received on the accounting port from this server.
Malformed Access Responses	Displays the number of malformed RADIUS Accounting-Response packets received from this server. Malformed packets include packets with an invalid length. Bad authenticators and unknown types are not included as malformed accounting responses.
Bad Authenticators	Displays the number of RADIUS Accounting-Response packets that contained invalid authenticators received from this accounting server.
Pending Requests	The number of RADIUS Accounting-Request packets destined for this server that have not yet timed out or received a response
Timeouts	The number of accounting timeouts to this server.
Unknown Types	The number of RADIUS packets of unknown type which were received from this server on the accounting port.
Packets Dropped	The number of RADIUS packets received from this server on the accounting port and dropped for some other reason

Viewing Cluster Information

Path: Status > Wireless Information > Clustering

The Cluster Information page shows information about other wireless controllers in the network. Peer wireless controllers within the same cluster exchange data about themselves, their managed access points, and their clients. The wireless controller maintains a database with this data, so you can view information about a peer, such as its IP address and software version. If the wireless controller loses contact with a peer, all of the data for that peer is deleted.

One wireless controller in a cluster is elected as a Cluster Controller. The Cluster Controller collects status and statistics from the other controllers in the cluster, including information about the access point's peer controller and the clients associated to those access points.

The screenshot shows the D-Link Unified Controller web interface. The top navigation bar includes 'Status', 'Wireless', 'Network', 'Security', and 'Maintenance'. The current page is 'Clustering' under 'Wireless Information'. The page title is 'Peer Controller & Clustering Info'. The 'Peer Controller Status' section shows the Cluster Controller IP Address as 192.168.10.1 and 0 Peer Controllers. The 'Peer Controllers List' section shows a table with columns for IP Address, Vendor ID, Software Version, Protocol Version, Discovery Reason, Managed AP Count, and Age. The table currently displays 'No data available in table'.

Field	Description
Cluster Information	
Cluster Controller IP Address	IP address of the controller that controls the cluster.
Peer Controllers	Number of peer controllers.
Connected Peer Controllers	
IP Address	IP address of the peer wireless controller in the cluster.
Vendor ID	Vendor ID of the peer controller software.
Software Version	Software version for the given peer controllers.
Protocol Version	Protocol version supported by the software on the peer wireless controllers.
Discovery Reason	Discovery method of the given peer wireless controller, either through an L2 Poll or IP Poll.
Managed AP Count	Number of access points that the wireless controller manages currently.
Age	Time since last communication with the wireless controller, in hours, minutes, and seconds.

Viewing WDS Group Status

Path: Status > Wireless Information > WDS Groups Status > WDS Groups Status

The Wireless Distribution System (WDS)-Managed AP feature allows you to add managed APs to the cluster using over-the-air WDS links through other managed APs. With WDS, APs may be located outdoors where wired connection to the data network is unavailable, or in remote buildings that are not connected to the main campus with a wired network.

The WDS AP group consists of the following managed APs:

- **Root AP:** Acts as a bridge or repeater on the wireless medium and communicates with the controller via the wired link
- **Satellite AP:** Communicates with the controller via a WDS link to the Root AP

The WDS links are secured using WPA2 Personal authentication and AES encryption.

This page displays summary information about configured WDS links. At least one group must be configured for the fields to display. To configure a WDS AP group, use the pages from Wireless > Access Point > WDS Groups.

The screenshot shows the D-Link Unified Controller - DWC-1000 web interface. The top navigation bar includes Status, Wireless, Network, Security, and Maintenance. The current page is 'WDS Groups Status' under 'Wireless Information'. The page displays a summary of configured WDS links and a table with the following columns: ID, Configured AP Count, Connected Root AP, Connected Satellite AP, Configured WDS Link Count, and Detected WDS Links Count. The table currently shows 'No data available in table'.

Field	Description
ID	Unique number that identifies the WDS AP group.
Configured AP Count	Number of APs configured in this WDS AP group.
Connected Root AP	Number of Root APs currently being managed by the controller that are members of this WDS AP Group.
Connected Satellite AP	Number of Satellite APs currently being managed by the controller that are members of this WDS AP Group.
Configured WDS Link Count	Number of configured bidirectional links in the WDS AP Group.
Detected WDS Links Count	Number of WDS links detected in the system. APs on both sides of the link must detect each other in order for the link to be counted.

WDS Group AP Status

Path: Status > Wireless Information > WDS Groups Status > WDS Group AP Status

The WDS AP Group Status page displays detailed information about the configured APs and links in the WDS Group. From this page, you can also send a new password to group members.

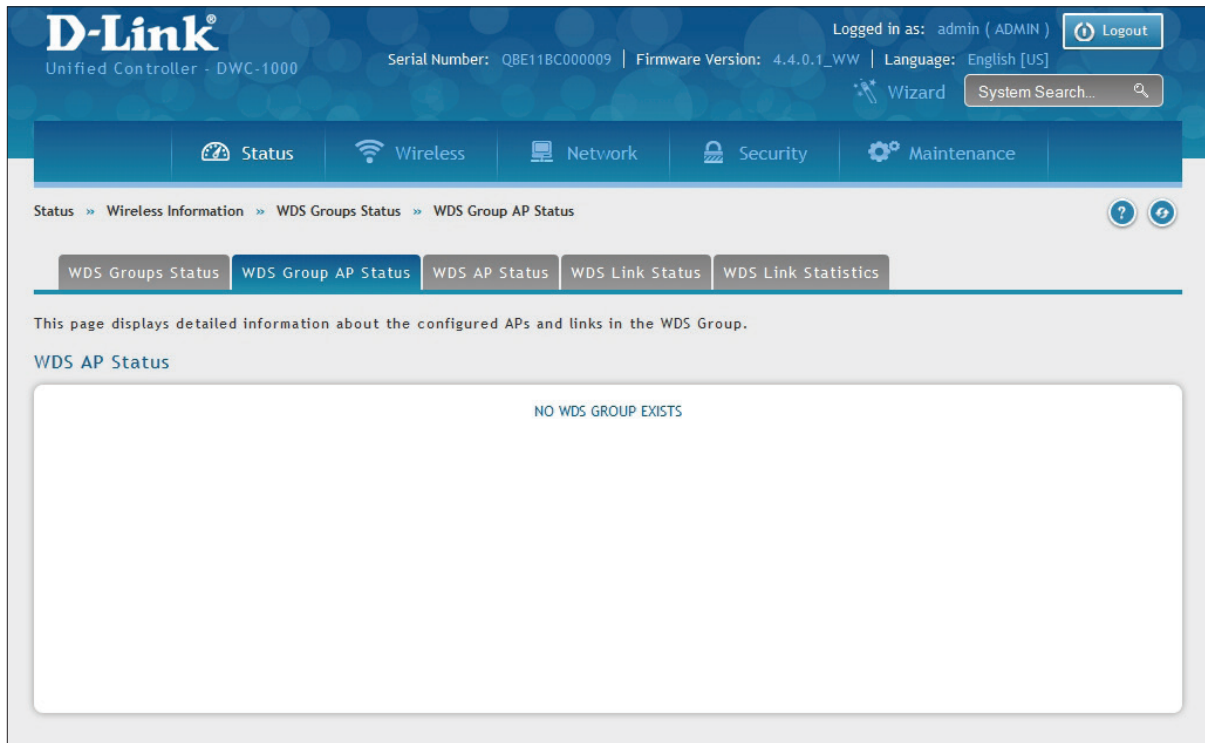

Field	Description
ID	Unique number that identifies the WDS AP group.
Configured AP Count	Number of APs configured in this WDS AP group.
Connected AP Count	Number of APs managed by the controller that are members of this WDS AP Group. This number is the sum of the Connected Root APs and Connected Satellite APs.
Source AP Count	Number of Root APs currently being managed by the controller that are members of this WDS AP Group.
Destination AP Count	Number of Satellite APs currently being managed by the controller that are members of this WDS AP Group.
Source Bridge AP MAC	MAC Address of the device elected as the Spanning Tree Root Bridge. If spanning tree is disabled this value is 00:00:00:00:00:00.
Source Device Type	The type of device elected as the Spanning Tree Root bridge: <ul style="list-style-type: none"> • None (STP is disabled) • Root AP • Satellite AP • External Device (STP Root is not one of the APs)
Config WDS Link Count	Number of configured bidirectional links in the WDS AP Group.
Detect WDS Links Count	Number of WDS links detected in the system. APs on both sides of the link must detect each other in order for the link to be counted.

Field	Description
Blocked WDS Link Count	Number of WDS links blocked by the spanning tree protocol. If the AP on one side of the link reports the link as blocking then the link is counted by this status parameter.
WDS Group Password Change Status	Status of the last attempt to configure the password for the WDS Group: <ul style="list-style-type: none">• Not Started• Success• Invalid Password• Requested• Timed Out
Edit Password	To change the password for all controllers and APs in this WDS Group, select the Edit checkbox, type the new password, and then click Apply Password. Password must be minimum of 8 characters and can be up to 63 characters in length.

Viewing WDS AP Status

Path: Status > Wireless Information > WDS Groups Status > WDS AP Status

The WDS AP Group Status page displays summary information about the APs in a configured WDS group.

Field	Description
Group ID	Use the drop-down menu above the fields to select the group number that identifies the configured WDS AP group.
AP MAC Address	Identifies the AP in the group by its MAC address.
AP Connection Status	Indicates whether the AP is currently being managed by one of the controllers in the cluster.
Satellite Mode	Indicates whether the AP is a Satellite AP connected to the network via a WDS link or a Root AP connected to the network via a wired link.
STP Root Mode	Indicates whether this AP is the root of the spanning tree. If spanning tree is disabled then the AP is always reported as Not STP Root.
Root Path Cost	Spanning Tree Path Cost to the root. The root AP always reports this value as 0. If spanning tree is disabled the value is also 0.
Ethernet Port STP State	When spanning tree is enabled on the APs in the WDS group this status parameter reports the spanning tree status of the Ethernet port.
Ethernet Port Mode	On Satellite APs the Ethernet port can be manually disabled. On root APs the port is always enabled.
Ethernet Port Link State	When the Ethernet port is enabled, this status reports the link state of the port.

Viewing WDS Link Status

Path: Status > Wireless Information > WDS Groups Status> WDS Link Status

The WDS AP Link Status page displays summary information about the link configuration and link state in a WDS group.

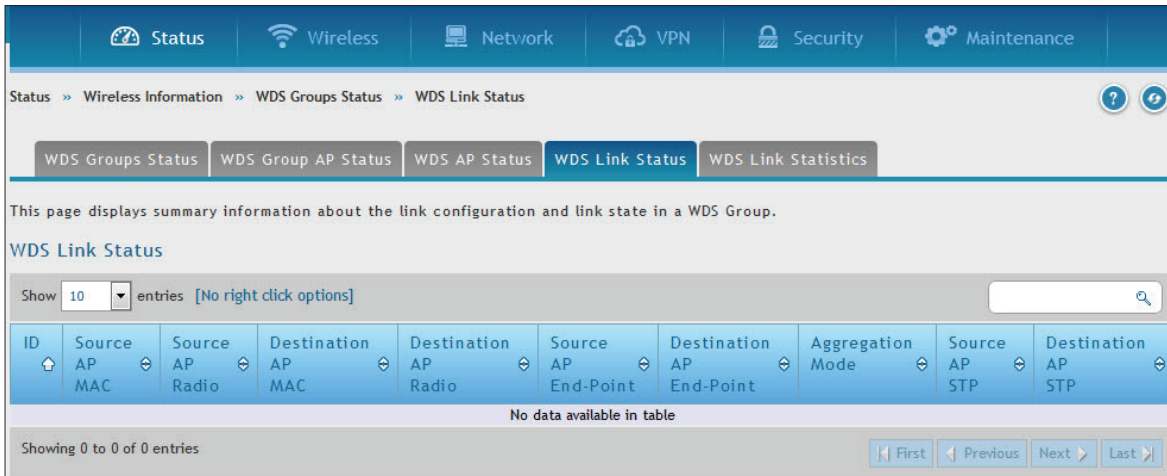

Field	Description
ID	The group number that identifies the configured WDS AP group.
Source AP MAC	The MAC address of one end-point of the WDS link.
Source AP Radio	The radio number of the WDS link endpoint on the source AP.
Destination AP MAC	The MAC address of the Source AP in the group.
Destination AP Radio	The radio number of the WDS link endpoint on the destination AP.
Source AP End-Point	Indicates whether the AP specified by the destination MAC detected the AP specified by the source MAC.
Destination AP End-Point	Indicates whether the AP specified by the source MAC detected the AP specified by the destination MAC.
Aggregation Mode	When parallel links are defined between two APs, this field indicates whether this link is part of the aggregation link pair.
Source AP STP	Spanning Tree State of the link on the source AP, which is one of the following: <ul style="list-style-type: none"> • Disabled (STP is disable or Link is down) • Forwarding • Learning • Listening • Blocking
Destination AP STP	Spanning Tree State of the link on the destination AP, which is one of the following: <ul style="list-style-type: none"> • Disabled (STP is disable or Link is down) • Forwarding • Learning • Listening • Blocking

Viewing WDS Link Statistics

Path: Status > Wireless Information > WDS Groups Status > WDS Link Statistics

The WDS Group Link Statistics page displays summary information about the packets sent and received on the WDS links.

The screenshot shows the D-Link Unified Controller web interface. The top navigation bar includes 'Status', 'Wireless', 'Network', 'Security', and 'Maintenance'. The breadcrumb trail is 'Status > Wireless Information > WDS Groups Status > WDS Link Statistics'. The page title is 'WDS Link Statistics'. Below the title, there is a message: 'This Page displays summary information about the packets sent and received on the WDS links.' The table has 9 columns: ID, Source AP MAC, Source Radio, Destination AP MAC, Destination Radio, Source AP Packets / Bytes Sent, Source AP Packets / Bytes Received, Destination AP Packets / Bytes Sent, and Destination AP Packet / Bytes Received. The table is currently empty, displaying 'No data available in table'.

Field	Description
ID	The group number that identifies the configured WDS AP group.
Source AP MAC	The MAC address of one end-point of the WDS link.
Source Radio	The radio number of the WDS link endpoint on the source AP.
Destination AP MAC	The MAC address of the Source AP in the group.
Destination Radio	The radio number of the WDS link endpoint on the destination AP.
Source AP Packets/ Bytes Sent	Number of packets/bytes sent by the source AP.
Source AP Packets/Bytes Received	Number of packets/bytes received by the source AP.
Destination AP Packets/Bytes Sent	Number of packets/bytes sent by the destination AP.
Destination AP Packets/Bytes Received	Number of packets/bytes received by the destination AP.

ACL & DiffServ Status

IP ACL

Path: Status > ACL & DiffServ > IP ACL

The IP ACL status page displays the number of rules configured for the specific IP ACL ID/Name.

The screenshot shows the D-Link Unified Controller interface. At the top, it displays the user is logged in as 'admin (ADMIN)', the language is 'English [US]', and the firmware version is '4.4.1.2_WW'. The main navigation bar includes 'Status', 'Wireless', 'Network', 'VPN', 'Security', and 'Maintenance'. The breadcrumb path is 'Status >> ACL & DiffServ >> IP ACL'. Below the breadcrumb, there is a search bar and a 'Show 10 entries [No right click options]' dropdown. The main content area shows a table with the header 'IP ACL ID/Name' and 'Rules', but it is currently empty with the message 'No data available in table'. Navigation buttons for 'First', 'Previous', 'Next', and 'Last' are visible at the bottom of the table area.

IP ACL Rules

Path: Status > ACL & DiffServ > IP ACL Rules

The IP ACL Rules status page provides a summary of the Rules configuration for the respective IP ACL List.

The screenshot shows the D-Link Unified Controller interface for the IP ACL Rules page. The user is logged in as 'admin (ADMIN)' and the firmware version is '4.4.1.2_B301_WW'. The breadcrumb path is 'Status >> ACL & DiffServ >> IP ACL Rules'. Below the breadcrumb, there is a search bar and a dropdown menu for 'IP ACL List' with the value '1'. The main content area shows a table with the header 'IP ACL Rules' and columns for 'Rule Id', 'Action', 'Logging', 'Assign Queue Id', and 'Match Every'. The table is currently empty with the message 'No data available in table'. Navigation buttons for 'First', 'Previous', 'Next', and 'Last' are visible at the bottom of the table area.

MAC ACL

Path: Status > ACL & DiffServ > MAC ACL

The MAC ACL status page displays the number of rules configured for the specific MAC ACL Name.

The screenshot shows the D-Link Unified Controller interface. The top navigation bar includes Status, Wireless, Network, VPN, Security, and Maintenance. The breadcrumb path is Status > ACL & DiffServ > MAC ACL. The page title is MAC ACL. Below the title, there is a search bar and a dropdown menu set to '10' entries. A table displays the MAC ACL Name 'aaa' with 0 rules. The page footer shows 'Showing 1 to 1 of 1 entries' and navigation buttons for First, Previous, Next, and Last.

MAC ACL Rules

Path: Status > ACL & DiffServ > MAC ACL Rules

The MAC ACL Rules status page provides a summary of the MAC ACL Rules configuration.

The screenshot shows the D-Link Unified Controller interface for MAC ACL Rules. The breadcrumb path is Status > ACL & DiffServ > MAC ACL Rules. The page title is MAC ACL Rules. Below the title, there is a dropdown menu for the MAC ACL List set to 'aaa'. A table displays the MAC ACL Rules configuration. The table has columns for Rule Id, Action, Logging, Assign Queue Id, Match Every, and CoS. The table is currently empty, showing 'No data available in table'. The page footer shows 'Showing 0 to 0 of 0 entries' and navigation buttons for First, Previous, Next, and Last.

DiffServ Class

Path: Status > ACL & DiffServ > DiffServ Class

The DiffServ Class status page displays the settings done for the configured DiffServ Classes.

The screenshot shows the D-Link Unified Controller interface. The top navigation bar includes Status, Wireless, Network, VPN, Security, and Maintenance. The current page is titled "DiffServ Class" under the path "Status >> ACL & DiffServ >> DiffServ Class". The page displays a table with the following data:

Class Name	Class Type	Reference Class
aaa	All(IPV4)	

The page also shows a search bar, a "Show 10 entries" dropdown, and navigation buttons for "First", "Previous", "1", "Next", and "Last".

DiffServ Policy

Path: Status > ACL & DiffServ > DiffServ Policy

The DiffServ Policy status page provides the Policy name, policy Type and the member classes i.e. the selected classes to which the policy is associated .

The screenshot shows the D-Link Unified Controller interface. The top navigation bar includes Status, Wireless, Network, VPN, Security, and Maintenance. The current page is titled "DiffServ Policy Class Defination" under the path "Wireless >> DiffServ >> DiffServ Policy". The page displays a table with the following data:

Policy Selector	Policy Type
Policy1	In

The page also shows a search bar, a "Show 10 entries" dropdown, and navigation buttons for "First", "Previous", "1", "Next", and "Last". There is also a button labeled "Add New DiffServ Policy".

DiffServ Policy Attribute

Path: Status > ACL & DiffServ > DiffServ Policy Attribute

The DiffServ Policy Attribute status page summarizes the configuration done for the DiffServ Policy Class Definition.

The screenshot shows the D-Link Unified Controller web interface. At the top, it displays the D-Link logo and 'Unified Controller - DWC-1000'. The user is logged in as 'admin (ADMIN)' in 'English [US]' with a 'Logout' button. System information includes 'Serial Number: QBE52E7000011' and 'Firmware Version: 4.4.1.2_B301_WW'. A navigation menu includes Status, Wireless, Network, VPN, Security, and Maintenance. The current page is 'Status >> ACL & DiffServ >> DiffServ Policy Attribute'. Below the breadcrumb is a help hint and the title 'DiffServ Policy Attribute'. A table shows one entry for 'Policy1' with the following attributes:

Policy Name	Policy Type	Class Name	Attribute	Attribute Details
Policy1	IN	aaa	Assign QueueId	Queue Id Value :1

At the bottom of the table, it says 'Showing 1 to 1 of 1 entries' and provides navigation buttons: First, Previous, 1, Next, Last.

Maintenance

This chapter describes the following maintenance activities:

- "Administration" on page 337
- "Management" on page 345
- "Firmware" on page 354
- "Using the Command Line Interface" on page 360
- "Wizard" on page 361

Administration System Setting

Path: Maintenance > Administration > System Setting

Enter a name for the system, and click **Save**.

System Date and Time

Path: Maintenance > Administration > Date and Time

You can configure your time zone, whether or not to adjust for Daylight Savings Time, and with which Network Time Protocol (NTP) server to synchronize the date and time. You can choose to set Date and Time manually, which will store the information on the controller's real time clock (RTC). If the controller has access to the internet, the most accurate mechanism to set the controller time is to enable NTP server communication.

To configure the date and time, follow the steps given below:

1. Select the controller's time zone, relative to Greenwich Mean Time (GMT).
2. If supported for your region, click to **Enable Daylight Savings**.
3. Determine whether to use default or custom Network Time Protocol (NTP) servers. If **custom**, enter the server addresses or FQDN.

Session Settings

Path: Maintenance > Administration > Session Settings

Enter the session timeout value for administrator and guest users, and then click **Save**.

D-Link
Unified Controller - DWC-1000

Serial Number: QBE11BC00009 | Firmware Version: 4.4.0.1_WW | Language: English [US]

Logged in as: admin (ADMIN) [Logout]

Wizard System Search...

Status Wireless Network Security Maintenance

Maintenance » Administration » Session Settings

This page allow the user to set session timeout value for administrator and guest users.

Session Settings

Administrator [Default: 10, Range: 0 - 999] Minutes

Guest [Default: 10, Range: 0 - 999] Minutes

Save **Cancel**

USB Share Ports

Path: Maintenance > Administration > USB Share Ports

This page allows to configure the USB Share Ports feature available in the device.

Status Wireless Network VPN Security Maintenance

Maintenance » Administration » USB Share Ports

Connect Atleast one Printer to Configure USB Share Ports

This page allows the user to configure the SharePort feature available in the device.

USB Share Ports

USB1 Share Port Setup

Enable USB Printer OFF

Enable sharing OFF

USB2 Share Port Setup

Enable USB Printer OFF

Enable sharing OFF

Shared Port Enabled Interfaces List

Interface Name	Enable Printer	Enable Storage
default	<input type="checkbox"/> OFF	<input type="checkbox"/> OFF
2	<input type="checkbox"/> OFF	<input type="checkbox"/> OFF

Save **Cancel**

The fields present on this page are given below:

Field	Description
USB-1 Share Port Setup	
Enable USB Printer	<p>Select this option to allow the USB printer connected to the router to be shared across the network.</p> <p>The USB printer can be accessed on any LAN host (with appropriate printer driver installed) connected to the router by using the following command in the host's add printers window <code>http://<Router's IP:631>/printers/<Device Model></code> (Device Model can be found in the USB settings page).</p>
Enable Sharing	<p>Select this option to allow the USB storage device connected to the router to be shared across the network.</p>
USB-2 Share Port Setup	
Enable USB Printer	<p>Select this option to allow the USB printer connected to the router to be shared across the network.</p> <p>The USB printer can be accessed on any LAN host (with appropriate printer driver installed) connected to the router by using the following command in the host's add printers window <code>http://<Router's IP:631>/printers/<Device Model></code> (Device Model can be found in the USB settings page).</p>
Enable Sharing	<p>Select this option to allow the USB storage device connected to the router to be shared across the network.</p>
Shared Port Enabled Interfaces List	
Interface Name	<p>Displays the LAN interfaces on which the usb sharing is enabled; at least one interface must be selected to begin sharing.</p>
Enable Printer	<p>Enables printer sharing on the selected interface.</p>
Enable Storage	<p>Enables storage device sharing on the selected interface.</p>

Package Manager

Path: Maintenance > Administration > Package Manager

A package is a set of files which are installed by the router from D-Link's repositories. This feature allows users to download new drivers for supported USB devices and language packs to enable multi-lingual support for the router's management interface. Multi-lingual support via the package manager allows the user to choose a language of choice so that the entire textual content in the router's user interface is presented in the selected language.

This feature supports a single driver and single language pack to be stored in the router (i.e. these files are available for use after device reboot). There are 2 types of installations supported by this feature:

1. **Manual Installation:** Upon selecting manual installation, the user has to download the package which will then display the available languages that the router GUI now supports.

Note: Only drivers provided by D-Link can be used for manual installation. A validation process will be performed during installation.

2. **Auto Installation:** By selecting the link "click here," the auto installation of the package is exercised. A page showing the list of available drivers/language packs is displayed from which the user can select and install one of the options. For this type of installation the router must be able to access the internet, as this will allow the user to download the package from a repository server which consists of all the available languages.

The screenshot displays the D-Link Package Manager interface. At the top, it shows the user is logged in as 'admin (ADMIN)' and the language is set to 'English [US]'. The page title is 'D-Link Unified Services Router - DWC-1000'. The main navigation bar includes 'Status', 'Wireless', 'Network', 'VPN', 'Security', and 'Maintenance'. The current page is 'Maintenance >> Administration >> Package Manager'. A message states: 'This page shows the list of available drivers. User can install or uninstall the drivers.' The 'Device Drivers' section contains a 'List of Default Drivers' table with the following data:

Driver	Description	Installed
cdc-acm	D-Link (DWM-156 A5, DWM-156 A6, DWM-157 A1)	0.9
option	D-Link (DWM-152 A1, DWM-152 A2, DWM-152 A3, DWM-156 A1, DWM-...	0.9

Below the table, there is a 'Manual Install' section with a 'Select Driver' label, a 'Browse...' button, and an 'Install' button. The 'Install History' section is currently empty.

The fields present on this page are given below:

Field	Description
List of Default Drivers	It allows the user to install or uninstall the available drivers.
Manual Install	User can upload the provided driver package for installation.
Browse	The user can choose the package to upload. Click on "Install" to save your changes.
Install History	It displays a list of installed and uninstalled packages.

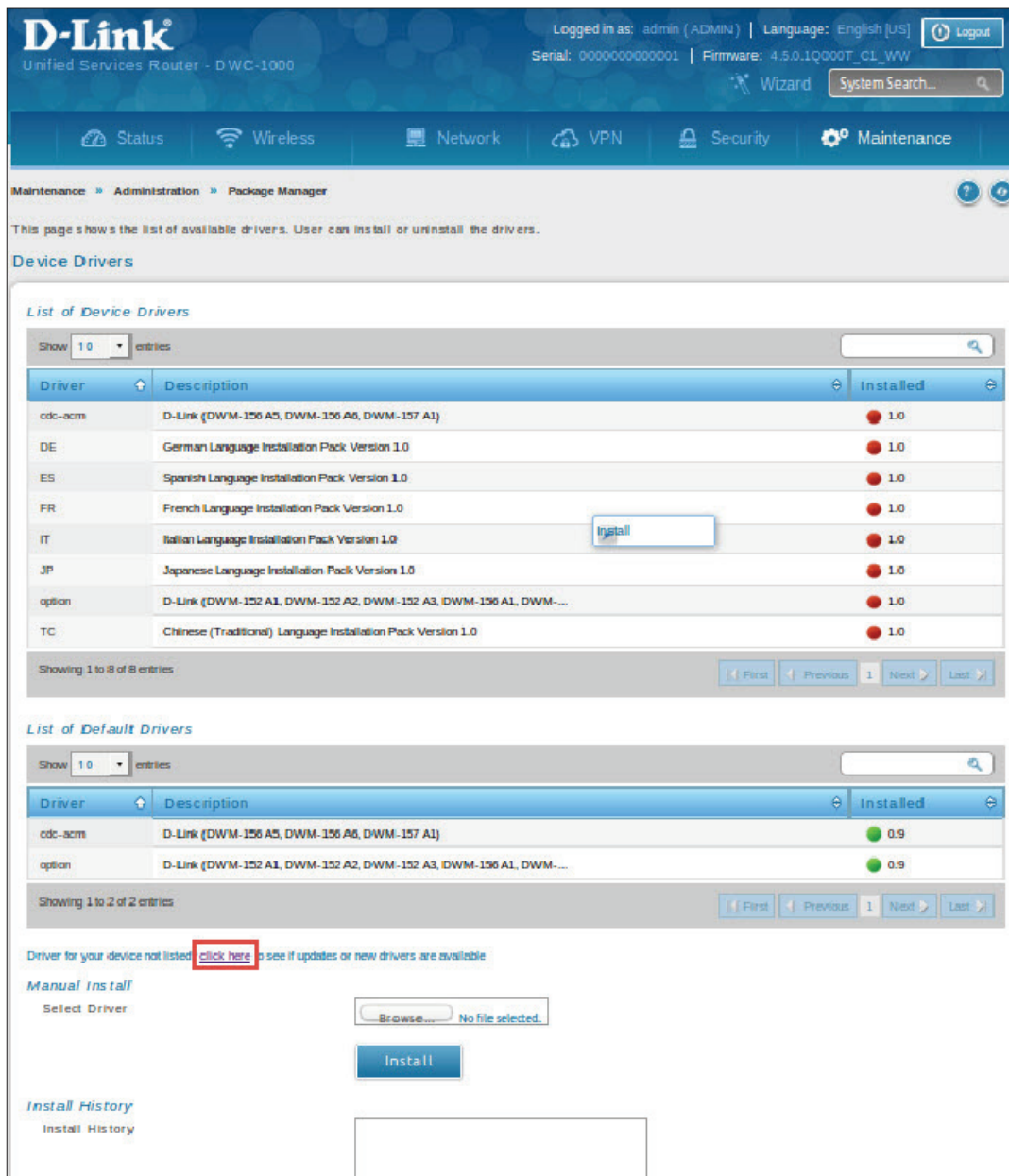

Clicking "**Click Here**" displays a page showing the list of device drivers. The fields are given below:

Field	Description
List of Device Drivers	It displays the list of device drivers.
Description	This describes the drivers that are supported
Action	It consists of 2 options: <ul style="list-style-type: none"> Install: Click on "Install" to install a particular Language pack Remove: To remove the installed language pack, click on "Remove".

Field	Description
Installed	All the language installation packs or option 3G Driver for ThreeG V-1.0 displayed in the list of device drivers are shown in Red color by default, since none of them have been selected. When a particular language installation pack or if Option Driver for ThreeG V-1.0 is selected, the button turns green in color.

Activating Licenses

Path: Maintenance > Administration > License Update

The License Update page lets you activate licenses for additional access points on the wireless controller.

1. Obtain an Activation Key from D-Link:
 - a. Find the wireless controller serial number on the bottom of the device.
 - b. Obtain a license key from D-Link after purchasing the license.
 - c. Open a web browser and go to <https://register.dlink.com> to register with D-Link.
 - d. If you do not have an account, register for a new account.
 - e. Log in with your username and password.
 - f. Click **License Key Activation** on the D-Link Global Registration Portal website.
 - g. Follow the directions to receive an activation code.
2. After obtaining the Activation Key, go to **Maintenance > Administration > License Update**. The License Update page will appear.

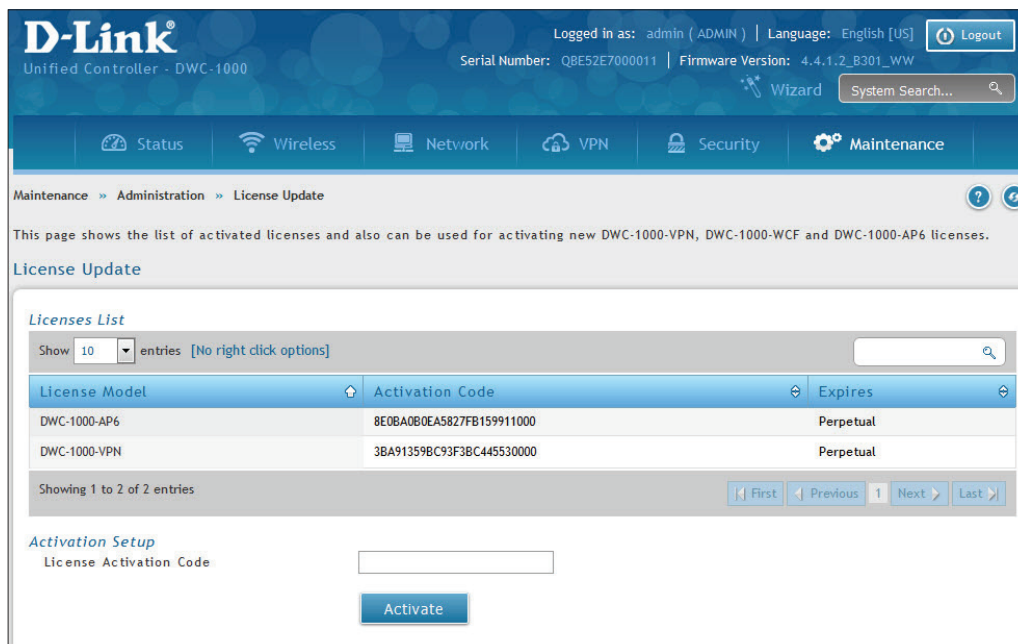

3. Under *Activation Setup*, enter the D-Link-supplied code for the license you want to activate in the Activation Code field.
4. Click **Activate**. The activation code will appear under List of Available Licenses.
5. Reboot the wireless controller to have the license take effect (refer to "Rebooting the Wireless Controller" on page 357).

Localization

Path: Maintenance > Administration > Set Language

By default, the router GUI displays content in English. The user must configure the package manager feature under Maintenance settings, in order to install a language package.

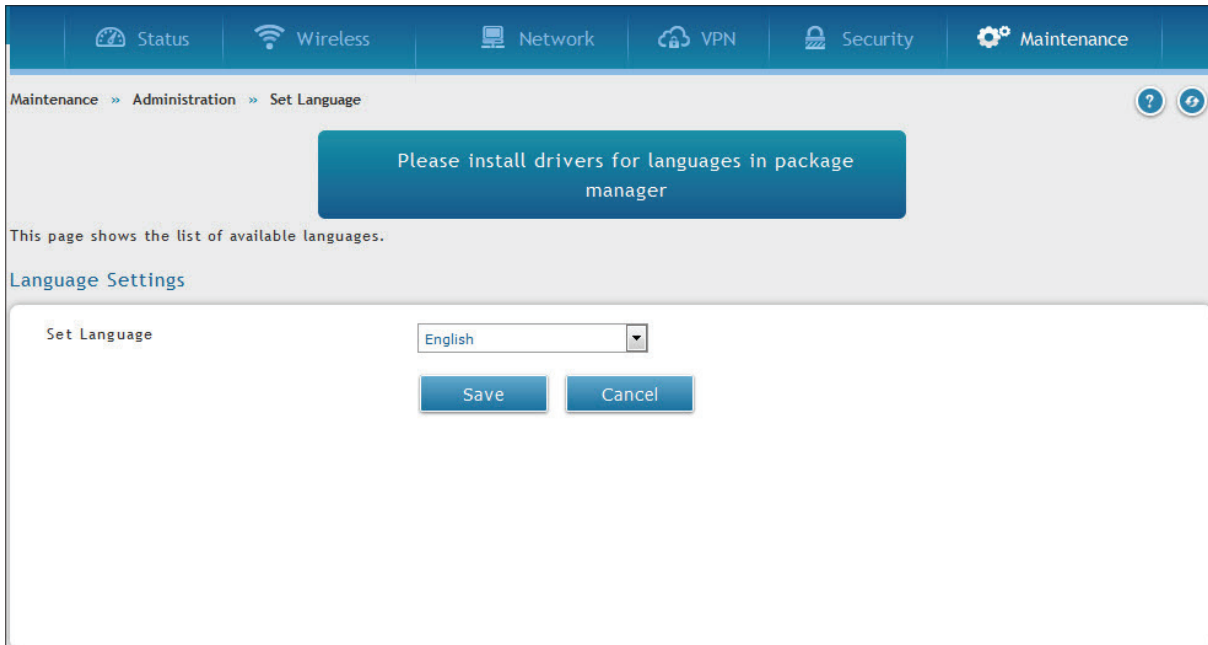

Path: Maintenance > Administration > Package Manager

This page shows the list of available device drivers which the user can install or upgrade, and the list of default drivers. The drivers which are installed by the user are indicated with green icon while un-installed drivers are indicated with red icon.

To install or upgrade any drivers, the user has to right click the respective driver, and click **Install** or **Upgrade**, whichever available.

D-Link Unified Services Router - DWC-1000
 Logged in as: admin (ADMIN) | Language: English [US] | Logout
 Serial: 00000000000001 | Firmware: 4.5.0.1Q000T_C1_WW
 Wizard System Search...

Status Wireless Network VPN Security Maintenance

Maintenance > Administration > Package Manager

This page shows the list of available drivers. User can install or uninstall the drivers.

Device Drivers

List of Device Drivers

Driver	Description	Installed
cdc-acm	D-Link (DWM-156 A5, DWM-156 A6, DWM-157 A1)	1.0
DE	German Language Installation Pack Version 1.0	1.0
ES	Spanish Language Installation Pack Version 1.0	1.0
FR	French Language Installation Pack Version 1.0	1.0
IT	Italian Language Installation Pack Version 1.0	1.0
JP	Japanese Language Installation Pack Version 1.0	1.0
option	D-Link (DWM-152 A1, DWM-152 A2, DWM-152 A3, DWM-156 A1, DWM-...	1.0
TC	Chinese (Traditional) Language Installation Pack Version 1.0	1.0

Showing 1 to 8 of 8 entries

List of Default Drivers

Driver	Description	Installed
cdc-acm	D-Link (DWM-156 A5, DWM-156 A6, DWM-157 A1)	0.9
option	D-Link (DWM-152 A1, DWM-152 A2, DWM-152 A3, DWM-156 A1, DWM-...	0.9

Showing 1 to 2 of 2 entries

Driver for your device not listed. [click here](#) to see if updates or new drivers are available

Manual Install
 Select Driver: No file selected.

Install History
 Install History:

The installed language can be set by selecting the language from the drop down list, present at the following page: Maintenance > Administration > Set Language. The languages supported by the device are Spanish, French, Chinese, Italian, German and English. For complete detail, please refer "Package Manager" on page 340.

Management

Remote Management

Path: Maintenance > Management > Remote Management

Note: This feature is only available with the DCS-1000-VPN license activation.

The Remote Access page allows you to enable remote management from outside your local network to configure your wireless controller. Select HTTP and/or HTTPS.

Note: When remote management is enabled, the controller is accessible to anyone who knows its IP address. It is **HIGHLY RECOMMENDED** that you change the default administrator and guest passwords before continuing.

1. Go to **Maintenance > Management > Remote Management**.

The screenshot shows the D-Link Unified Controller web interface. At the top, it displays the D-Link logo and 'Unified Controller - DWC-1000'. The user is logged in as 'admin (ADMIN)' with the language set to 'English [US]'. The serial number is 'QBE52E7000011' and the firmware version is '4.4.1.2_B301_WW'. The navigation menu includes Status, Wireless, Network, VPN, Security, and Maintenance. The current page is 'Remote Management' under 'Management' in the 'Maintenance' section. A description states: 'From this page a user can configure the remote management feature. This feature can be used to manage the box remotely from Option side.' The 'Remote Management Setup' section includes: 'Enable Remote Management' (ON), 'HTTPS Port No' (4443, range 1-65535), 'SSH' (ON), and 'SNMP' (ON). The 'Access Control Setup' section has 'Access Type' with radio buttons for 'All IP Addresses' (selected), 'IP Address Range', and 'Only Selected PC'. The 'Option Ping' section has 'Respond to Ping' (ON). 'Save' and 'Cancel' buttons are at the bottom.

2. Set HTTP and/or HTTPS to **On**. If you select HTTPS, you may enter a port (4443 is the default setting).
3. To understand each field, refer to the table given on the next page.

Field	Description
Enable Remote Management	By default, Remote management over the internet is disabled. Click ON/OFF button to enable authorized users to access this GUI over the internet.
HTTPS Port Number	You can set the port number for remote management over HTTPS; the default is 4443.
SSH	By default, SSH over the internet is disabled. Click ON/OFF button to enable authorized users to access this CLI over the internet.
SNMP	Switch it ON to access the device through SNMP remotely.
Access Type	Permission for Remote Management can be given to a selected PC, a range of IP addresses, or anyone on the Option or LAN.
Respond to Ping	To configure the controller to respond to an ICMP Echo (ping) packet coming from the Option side, switch it to ON. This setting is usually used as a diagnostic tool for connectivity problems. It is recommended that the option be OFF at other times to prevent hackers from easily discovering the controller through a ping .

Power Saving Settings

Path: Maintenance > Management > Power Saving

There are two options available to support power efficiency on the controller.

1. Go to **Maintenance > Management > Power Saving**.

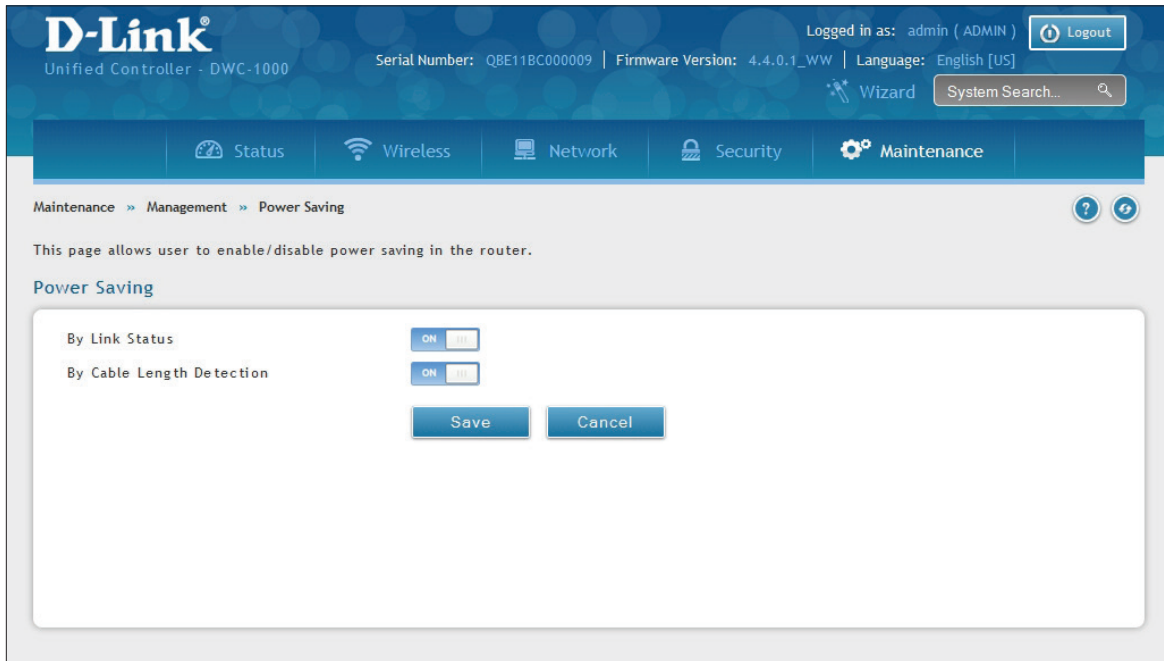

2. Toggle the feature you want to enable to **ON** and click **Save**.

By Link Status: When enabled, the total power to the controller is dependent on the number of connected ports. The overall current drawn, when a single port is connected is less than when all of the available LAN ports have an active Ethernet connection.

By Cable Length Detection: When enabled, the controller will reduce the overall current supplied to the LAN port when a small cable length is connected to that port. Longer cables have higher resistance than shorter cables, and require more power to transmit packets over that distance. This option will reduce the power to a LAN port if an Ethernet cable of less than 10 ft is detected as being connected to that port.

SNMP

Path: Maintenance > Management > SNMP

SNMP is an additional management tool that is useful when multiple controllers in a network are being managed by a central Master system. When an external SNMP manager is provided with this controller's Management Information Base (MIB) file, the manager can update the controller's hierarchal variables to view or update configuration parameters. The controller as a managed device has an SNMP agent that allows the MIB configuration variables to be accessed by the Master (the SNMP manager). The Access Control List on the controller identifies managers in the network that have read-only or read-write SNMP credentials. The Traps List outlines the port over which notifications from this controller are provided to the SNMP community (managers) and also the SNMP version (v1, v2c, v3) for the trap.

Configure SNMP v3 User List

1. Go to **Maintenance > Management > SNMP** page, and click **SNMP** tab.

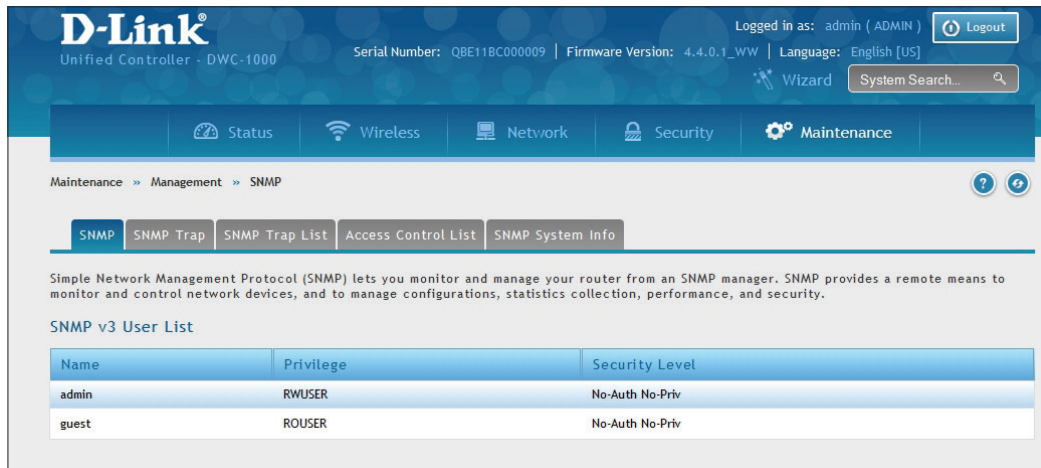

The screenshot shows the D-Link Unified Controller web interface. The top navigation bar includes 'Status', 'Wireless', 'Network', 'Security', and 'Maintenance'. The 'Maintenance' tab is selected, and the breadcrumb path is 'Maintenance > Management > SNMP'. Below the breadcrumb, there are tabs for 'SNMP', 'SNMP Trap', 'SNMP Trap List', 'Access Control List', and 'SNMP System Info'. The 'SNMP' tab is active. The main content area displays the 'SNMP v3 User List' table.

Name	Privilege	Security Level
admin	RWUSER	No-Auth No-Priv
guest	ROUSER	No-Auth No-Priv

2. Right-click either admin or guest and select **Edit**.

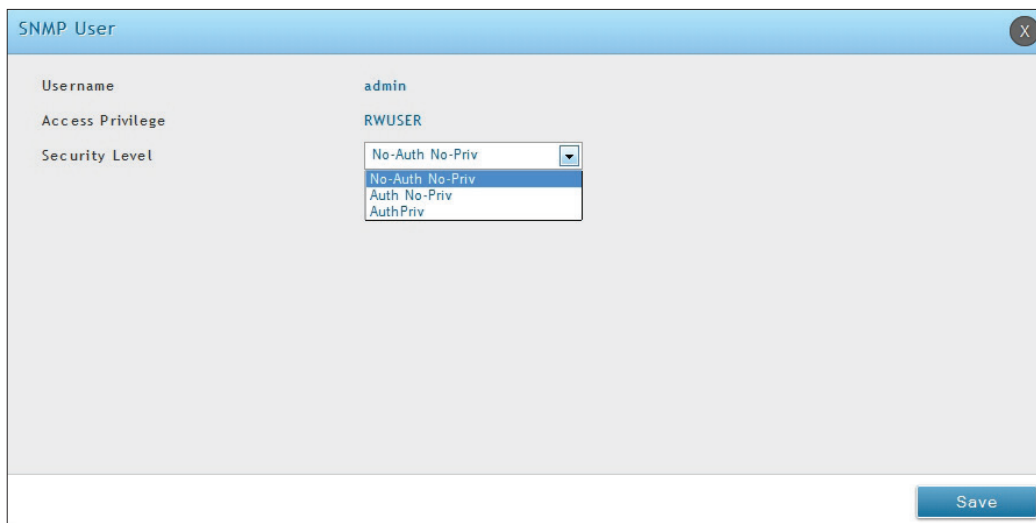

The screenshot shows the 'SNMP User' configuration dialog box. It has a title bar with 'SNMP User' and a close button. The dialog contains the following fields:

- Username:** admin
- Access Privilege:** RWUSER
- Security Level:** A dropdown menu with the following options: No-Auth No-Priv (selected), No-Auth No-Priv, Auth No-Priv, and AuthPriv.

A 'Save' button is located at the bottom right of the dialog.

2. Set the security level.
 - noAuthnoPriv: only requires a username match for authentication
 - authNoPriv: Provides authentication based on the MD5 or SHA algorithms.
 - authPriv: Provides authentication based on the MD5 or SHA algorithms as well as encryption privacy with the DES 256-bit standard.
3. Click **Save**.

Configure SNMP Trap List

1. Go to **Maintenance > Management > SNMP > SNMP Trap List** tab.

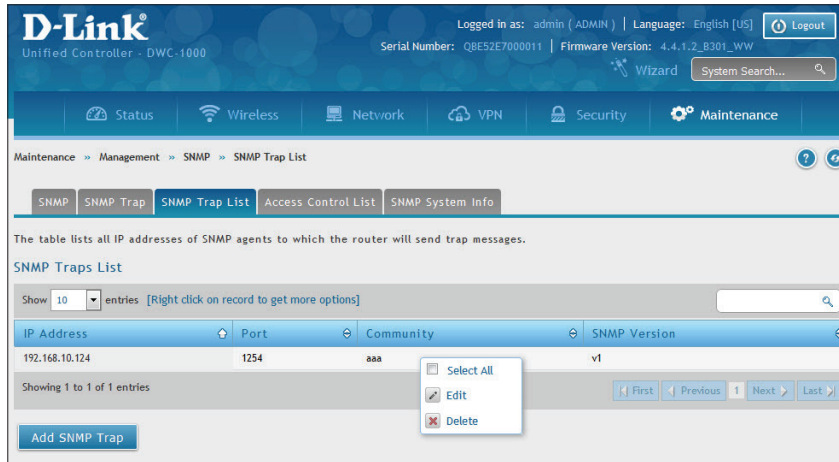

2. Click **Add SNMP Trap**.
3. Complete the fields (refer to the table below).
4. Click **Save**.

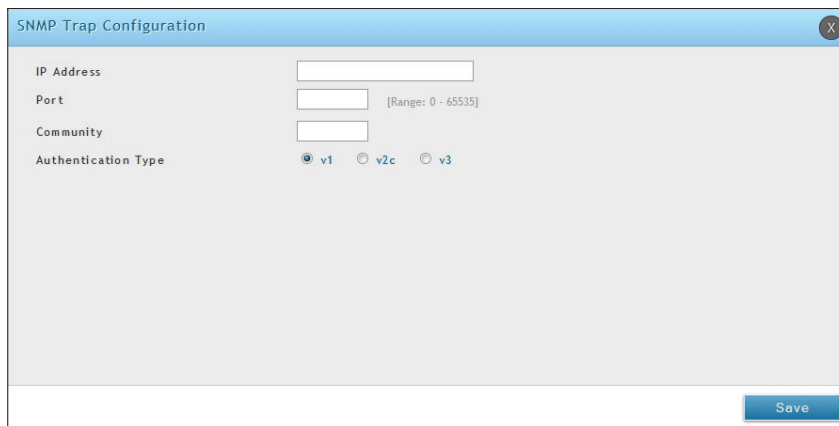

Field	Description
IP Address	The IP Address of the SNMP trap agent.
Port	The SNMP trap port of the IP address to which the trap messages will be sent.
Community	The community string to which the agent belongs. Most agents are configured to listen for traps in the Public community.
Authentication Type	The SNMP version used by the trap agent. The choices are v1, v2c, or v3.

Configure SNMP Access Control List

1. Go to **Maintenance > Management > SNMP > Access Control List** tab.

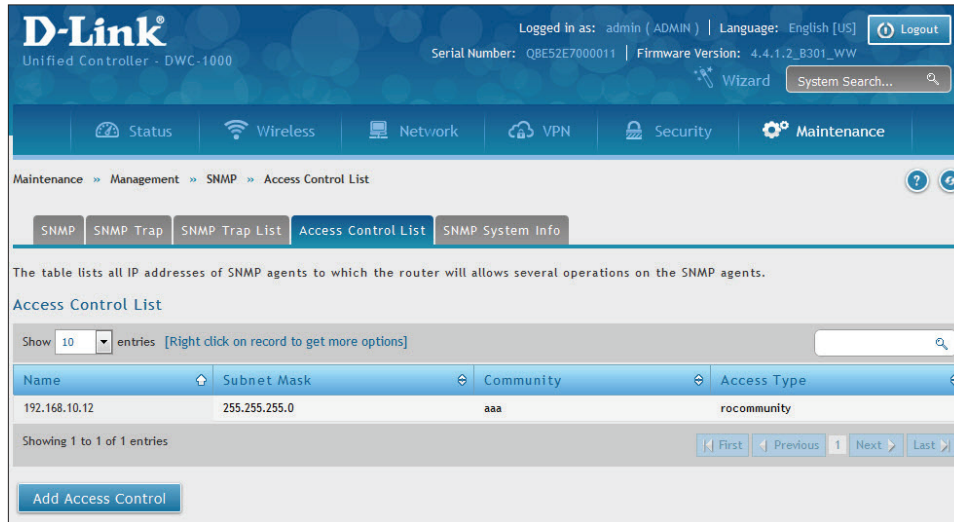

2. Click **Add Access Control**.

The screenshot shows a modal dialog box titled "Access Control List". It contains four input fields: "IP Address", "Subnet Mask", and "Community", each with a text input box. Below these is the "Access Type" section with two radio buttons: "rocommunity" (selected) and "rwcommunity". A blue "Save" button is located at the bottom right of the dialog.

3. Fill-in the fields (refer to the table below).
4. Click **Save**.

Field	Description
IP Address	The IP Address of the SNMP trap agent.
Subnet Mask	The network mask used to determine the list of allowed SNMP managers.
Community	The community string to which the agent belongs.
Access Type	Access will be either read only (ROcommunity) or read-write (RWcommunity).

Configure SNMP System Info

1. Go to **Maintenance > Management > SNMP > SNMP System Info** page.

The screenshot shows the D-Link Unified Controller web interface. The top navigation bar includes 'Status', 'Wireless', 'Network', 'VPN', 'Security', and 'Maintenance'. The breadcrumb trail is 'Maintenance > Management > SNMP > SNMP System Info'. Below the breadcrumb, there are tabs for 'SNMP', 'SNMP Trap', 'SNMP Trap List', 'Access Control List', and 'SNMP System Info'. The main content area is titled 'SNMP System Info' and contains the following text: 'This page displays the current SNMP configuration of the router. The following MIB (Management Information Base) fields are displayed and can be modified here.' Below this text are three input fields: 'SysContact' with the value 'admin', 'SysLocation' with the value 'Block 3', and 'SysName' with the value 'DWC-1000'. At the bottom of the form are 'Save' and 'Cancel' buttons.

2. Enter the information as desired.
 - SysContact: The name of the contact person for this controller. Examples: admin, John Doe.
 - SysLocation: The physical location of the controller: Example: Rack #2, 4th Floor.
 - SysName: A name given for easy identification of the controller.
3. Click **Save**.

Configure Wireless SNMP Info

If you use Simple Network Management Protocol (SNMP) to manage the controller, you can configure the SNMP agent on the controller to send traps to the SNMP manager on your network from this page.

When an AP is managed by a controller, it does not send out any traps. The controller generates all SNMP traps based on its own events and the events it learns through the updates from the APs it manages.

All Wireless SNMP traps are disabled by default.

1. Go to **Maintenance > Management > SNMP > SNMP Trap** tab.

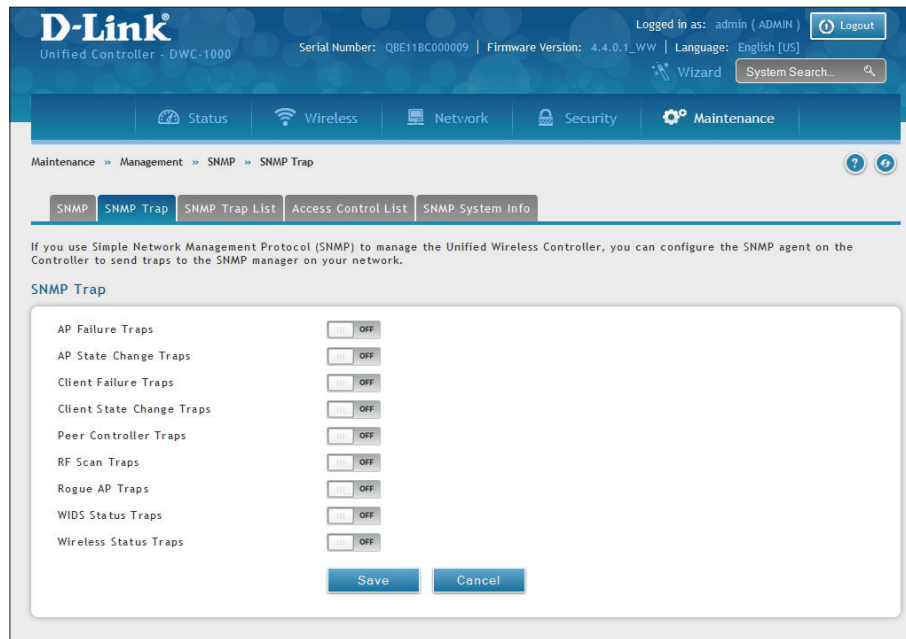

2. Enable the trap as desired (refer to the table below).
3. Click **Save**.

Field	Description
AP Failure Traps	If you enable this field, the SNMP agent sends a trap if an AP fails to associate or authenticate with the controller
AP State Change Traps	If you enable this field, the SNMP agent sends a trap for one of the following reasons: <ul style="list-style-type: none"> • Managed AP Discovered • Managed AP Failed • Managed AP Unknown Protocol Discovered • Managed AP Load Balancing Utilization Exceeded
Client Failure Traps	If you enable this field, the SNMP agent sends a trap if a wireless client fails to associate or authenticate with an AP that is managed by the controller.
Client State Change Traps	If you enable this field, the SNMP agent sends a trap for one of the following reasons associated with the wireless client: <ul style="list-style-type: none"> • Client Association Detected • Client Disassociation Detected • Client Roam Detected
Peer Controller Traps	If you enable this field, the SNMP agent sends a trap for one of the following reasons associated with a peer controller <ul style="list-style-type: none"> • Peer Controller Discovered • Peer Controller Failed • Peer Controller Unknown Protocol Discovered • Configuration command received from peer controller. (The controller does not need to be Cluster Controller for generating this trap.)
RF Scan Traps	If you enable this field, the SNMP agent sends a trap when the RF scan detects a new AP, wireless client, or ad-hoc client.
Rogue AP Traps	If you enable this field, the SNMP agent sends a trap when the controller discovers a rogue AP. The agent also sends a trap every Rogue Detected Trap Interval seconds if any rogue AP continues to be present in the network.

Field	Description
WIDS Status Traps	If you enable this field, the SNMP agent sends a trap for one of the following reasons: <ul style="list-style-type: none">• This controller has become Cluster Controller• Rogue Client detected• Rogue Client(s) continue to exist, after every Rogue Detected Trap Interval seconds• Maximum number of Managed APs in the peer group exceeded.
Wireless Status Traps	If you enable this field, the SNMP agent sends a trap if the operational status of the controller (it need not be Cluster Controller for this trap) changes. It sends a trap if the Channel Algorithm is complete or the Power Algorithm is complete. It also sends a trap if any of the following databases or lists has reached the maximum number of entries: <ul style="list-style-type: none">• Managed AP database• AP Neighbor List• Client Neighbor List• AP Authentication Failure List• RF Scan AP List• Client Association Database• Ad Hoc Clients List• Detected Clients List

Firmware

Backup Configuration Settings

Path: Maintenance > Firmware > Backup/Restore

After you configure the wireless controller as desired, back up the configuration settings. When you back up the settings, they are saved as a file. You can then use the file to restore the settings on the same wireless controller if something goes wrong or on a different wireless controller that will replace or work with other wireless controllers.

1. Click **Maintenance > Firmware > Backup/Restore**.

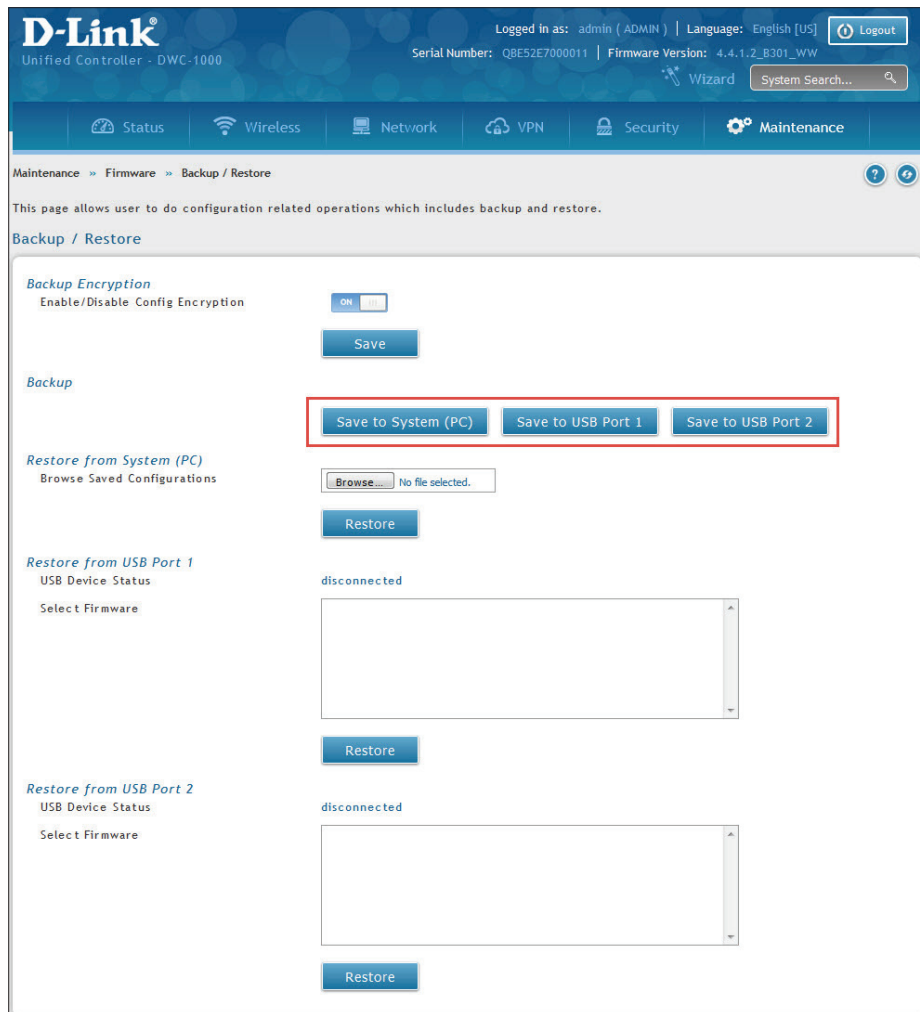

2. Click **Save from System (PC)**, **Save from USB Port 1**, or **Save from USB Port 2**, depending on the location the backup should be saved to.
 - A. If Save from System (PC) is chosen, a dialog box message will appear. Afterwards the browser will automatically begin the download to the default download location.
 - B. If Save from USB Port 1, or Save from USB Port 2 is chosen, the file will immediately be backed up to the corresponding USB flash drive without further prompts. If no USB flash medium is present, these options will do nothing.

Restoring Configuration Settings

Path: Maintenance > Firmware > Backup/Restore

After you use the procedure on the previous page to back up a wireless controller's configuration, you can restore the settings using the following procedure.

1. Click **Maintenance > Firmware > Backup/Restore**.

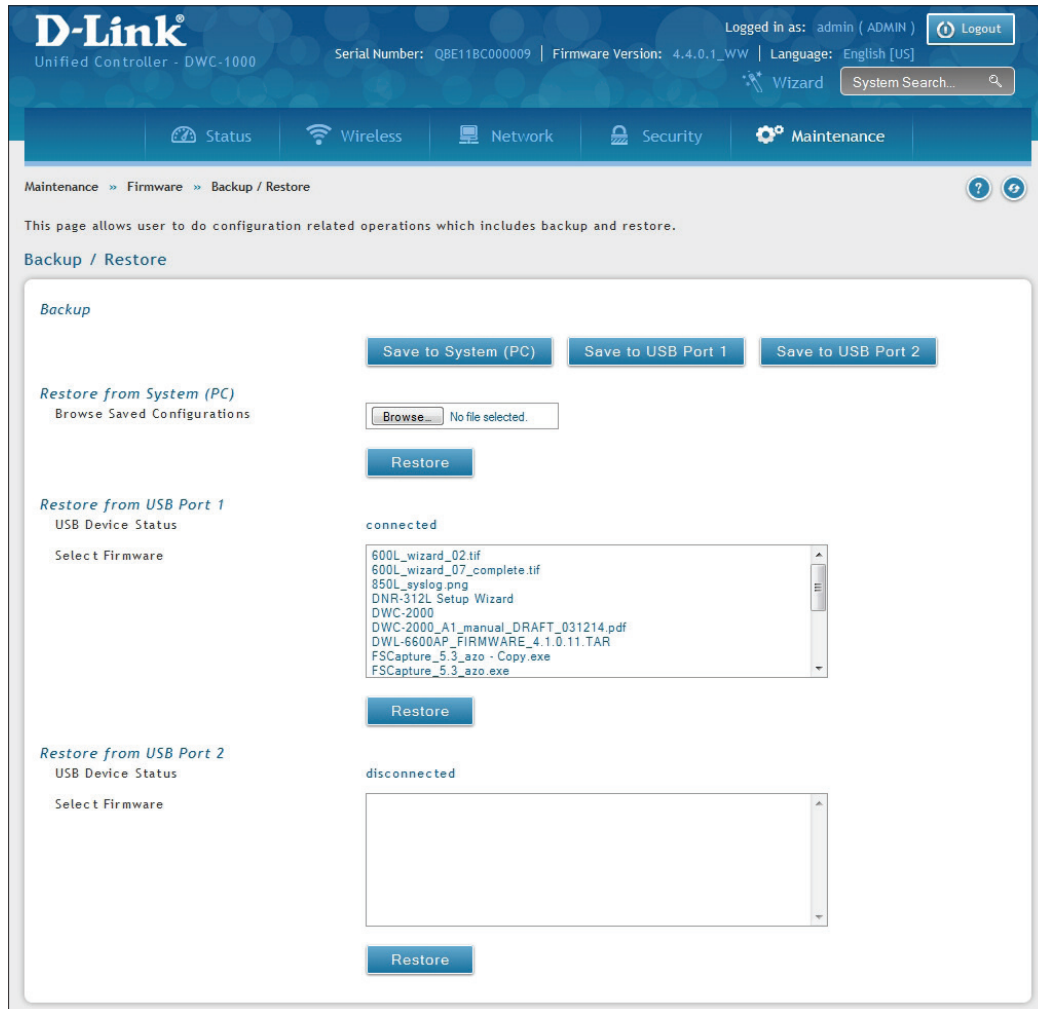

2. In the Restore to System (PC) section, click the **Browse** button. Use the *Choose file* dialog box to find the backup file, then click the file, and click **Open**. You may also restore from a USB drive connected to one of the USB ports.
3. Click **Restore**. A message will appear.
4. Click **OK** to close the message and restore the configuration settings from the selected file.

Soft Reboot

Restoring Factory Default Settings

Path: Maintenance > Firmware > Soft Reboot

If you reset a wireless controller to its factory default settings, it returns to the state when it was new — all changes you made to the default configuration are lost. Examples of settings that get restored include, critical things you need to get online, such as login password, SSID, IP addresses, and wireless security keys.

There are two ways to restore a wireless controller to its original factory default settings:

- Use the reset button on the back of the wireless controller (see “Using the Reset Button to Restore Default Settings” on page 368).
- Use the web management interface instructions below.

1. Click **Maintenance > Firmware > Soft Reboot**.

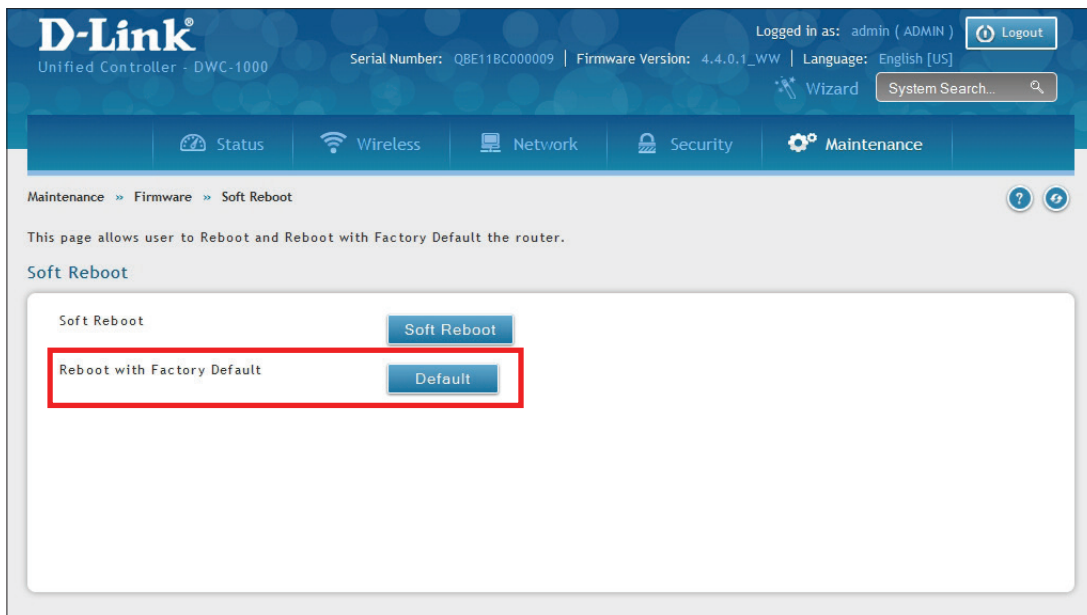

2. Next to Factory Default settings, click the **Default** button.
3. At the confirmation message, click **OK** to restore factory default settings; or click **Cancel** to retain your current settings.

Note: After restoring the factory default configuration, the wireless controller's default LAN IP address is 192.168.10.1, the default login user name is **admin**, and the default login password is **admin**.

Rebooting the Wireless Controller

Path: Maintenance > Firmware > Soft Reboot

You can reboot the wireless controller. Rebooting performs a power cycle and keeps any customized overrides you made to the default settings.

1. Go to **Maintenance > Firmware > Soft Reboot**.

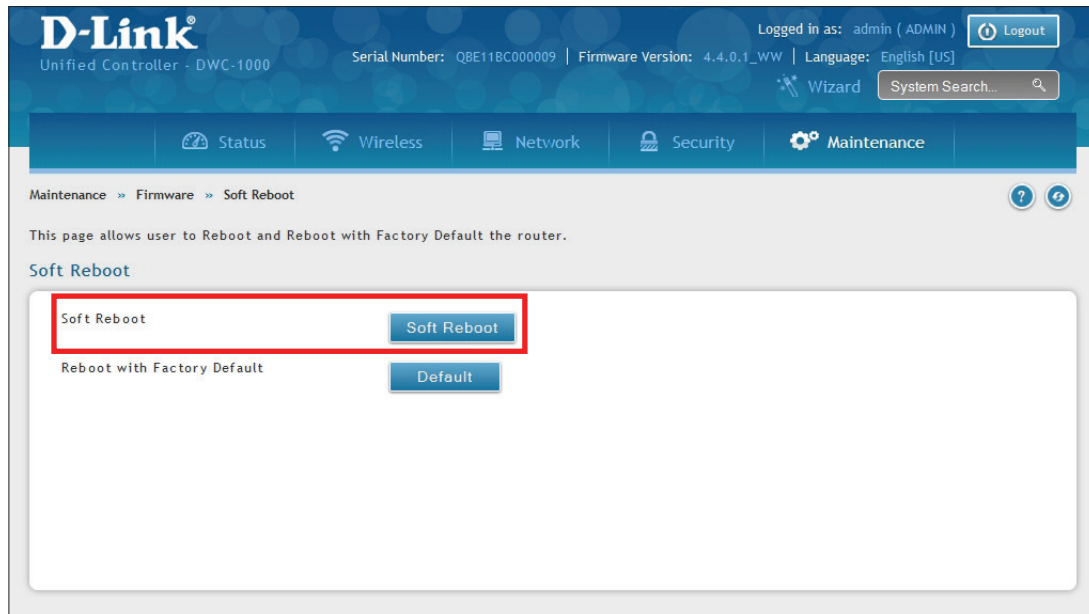

2. Next to Soft Reboot, click **Soft Reboot**. To reboot to the original factory default, click **Default**.
3. At the confirmation message, click **OK** to reboot the wireless controller, or click **Cancel** to abort reboot.

Upgrading Firmware

Wireless Controller Firmware Upgrade

Path: Maintenance > Firmware > Firmware Upgrade > Using System (PC)

D-Link is constantly improving the operation and performance of the wireless controller. When improvements are available, they are offered to customers as firmware upgrade releases.

After you install the wireless controller, check that it has the latest firmware. Thereafter, check for firmware releases and install them as they become available.

1. In the wireless controller web management interface, click **Maintenance > Firmware > Firmware Upgrade**. The **Using System (PC)** page will appear.

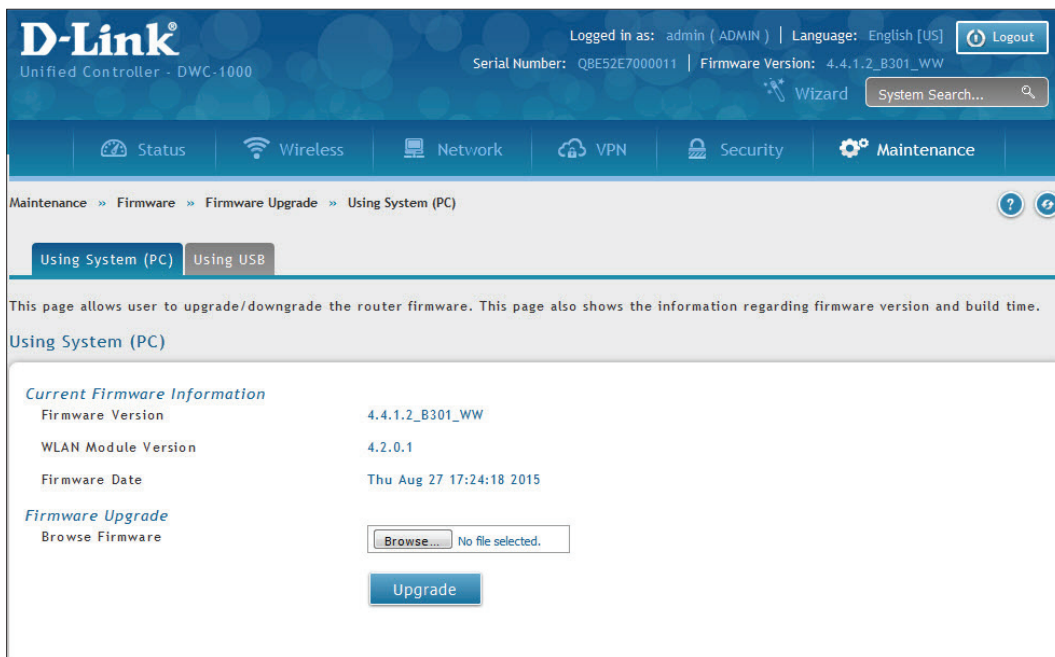

To use a USB drive to update the firmware, click the **Using USB** tab.

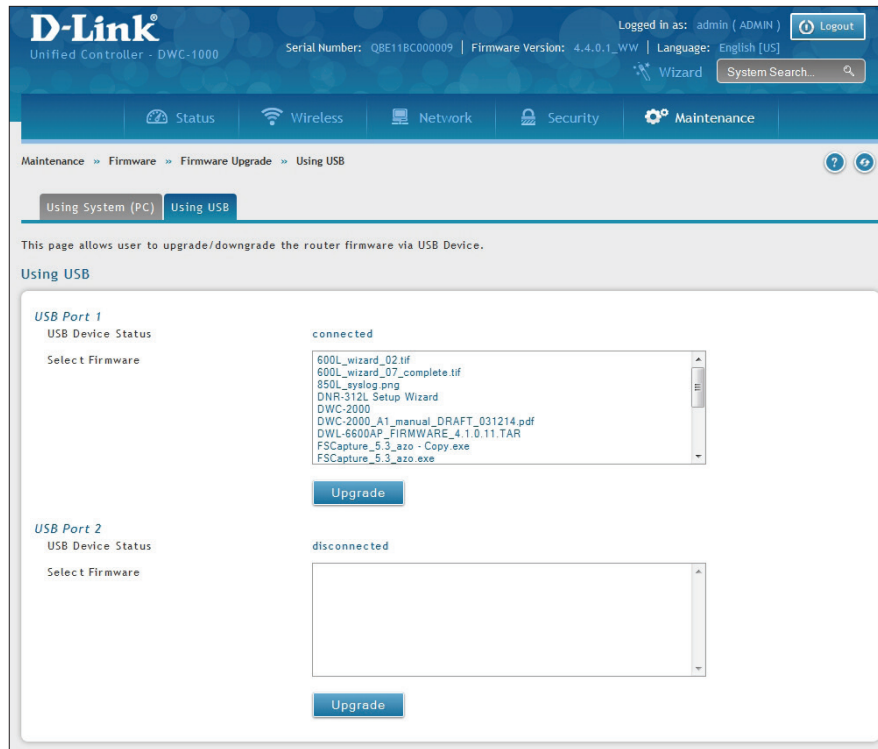

2. If the firmware version on the D-Link Support website has a higher number than the firmware version shown under Firmware Information, continue with this procedure.
3. Download the new firmware from the D-Link website.
4. Under *Firmware Upgrade*, click the **Choose File** button.
5. In the *Browse Firmware* dialog box, navigate to the firmware file, click the file, and then click **Open**. If you want to upgrade using a file from a USB drive, click the Using USB tab near the top of this page.
6. Click **Upgrade**.
7. At the confirmation message, click **OK** to start the firmware upgrade. A progress bar shows the progress of the upgrade.

Note: The upgrade process takes a few minutes. Do not interrupt the upgrade or turn off the system; otherwise, you can damage the firmware. Wait for the upgrade to complete before browsing any sites from your browser.
8. When the upgrade completes, log in to the wireless controller web management interface, click **Maintenance > Firmware > Firmware Upgrade**, and confirm that the new firmware appears next to Firmware on the Using System (PC) page.
9. Record the firmware level in Appendix A.

Using the Command Line Interface

The wireless controller supports a command-line interface (CLI). The CLI lets you use a VT-100 terminal-emulation program to locally or remotely configure, monitor, and control the wireless controller and its managed access points via a simple text-based, tree-structured interface. The wireless controller supports SSH and Telnet management for command-line interaction.

The following procedure describes how to access the CLI:

Note: *A separately purchased USB-to-DB9F serial adapter will be helpful when connecting a PC or Linux workstation to the console. An RJ-45-to-DB9M cable is included with the wireless controller.*

1. Connect a PC with a VT-100 terminal-emulation program to the Console port on the front panel of the wireless controller.
2. CLI login credentials are shared with the GUI for administrator users. When prompted, type cli in the SSH or console prompt and login with administrator user credentials.

For more information, refer to the Wireless Controller CLI Reference Guide: DWC-1000.

Wizard

The Wizard is a user friendly approach provided by D-Link Wireless Controller which guides its users step-by-step for various configurations required for the applications. This is a very useful tool for the new users as it would help them to understand the steps required for the several settings. The wizards available are as follows:

1. Controller/Device Wizard
2. Internet Connection Wizard
3. Security Wizard
4. WLAN Wizard
5. Users Wizard
6. Dynamic DNS Wizard
7. Date and Time Wizard
8. LAN Wizard

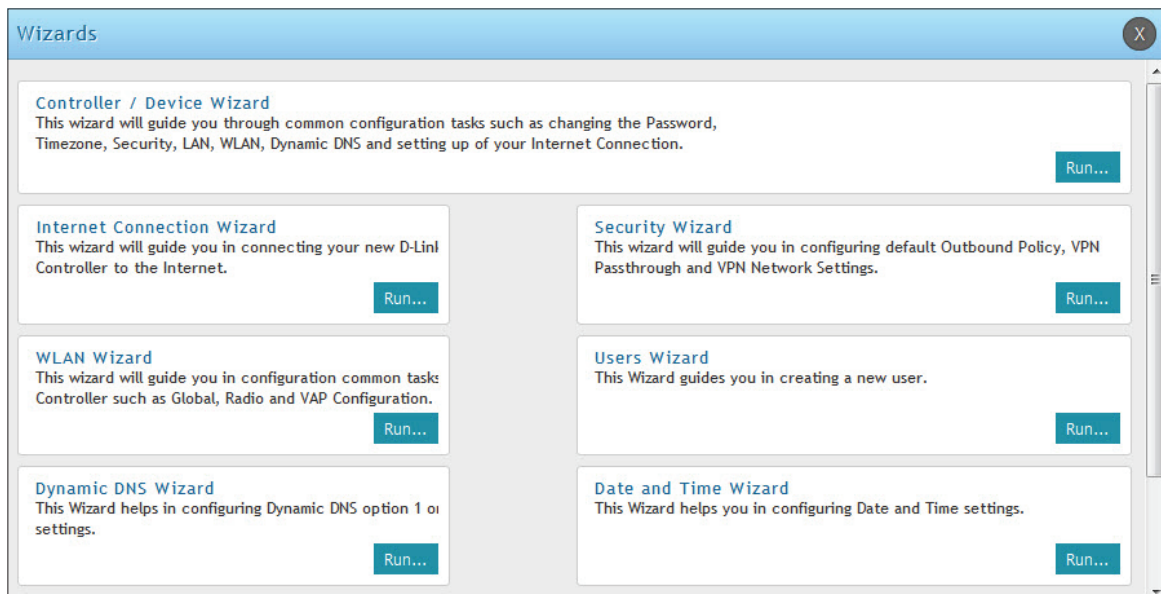

WLAN Wizard

The WLAN controller can manage external AP's and also act as an AP for wireless LAN clients. The Wireless Wizard is a user friendly approach to configure a wireless LAN connection using the controller's built in 802.11 radio. It allows user to aim your wireless adapter, measure network performance and quickly identify and fix wireless broadband problems. The Wizard includes a Wi-Fi analyzer to easily identify the best channel and resolve interference issues. One can even compare the performance of his/her broadband network to networks around the world. The WLAN Wizard helps the user to get wireless network up and running by following the following few steps:

- Step 1: Wireless Global Configuration
- Step 2: Wireless Default Radio Configuration
- Step 3: Wireless Default VAP Configuration
- Step 4: Valid Access Point Summary
- Step 5: Save Settings and Connect

Internet Connection Wizard

The Internet Connection Setup Wizard is available for users new to networking. By going through a few straightforward configuration pages, you can take the information provided by your ISP to get your Option connection up, and enable internet access for your network.

Please follow the procedure given below:

1. You can start using the Wizard by logging in with the administrator password for the controller.

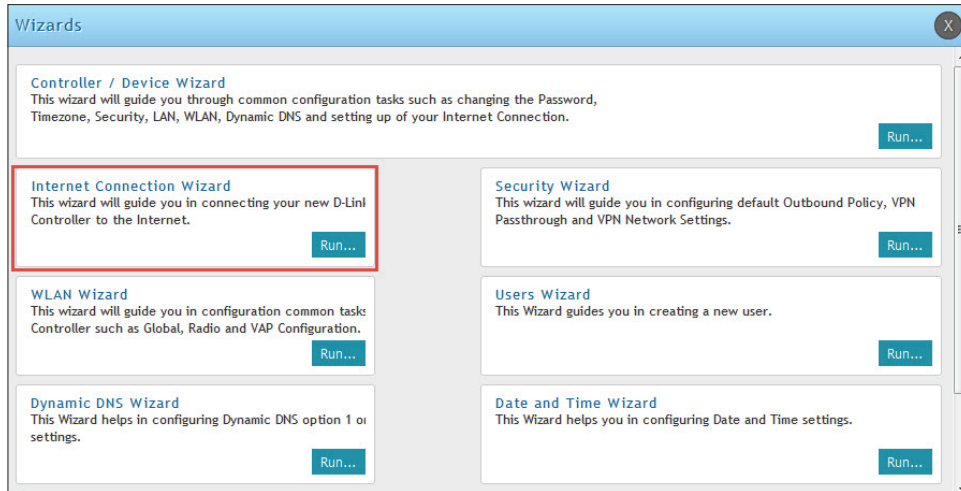

2. Once authenticated, set the time zone that you are located in, and then choose the type of ISP connection: DHCP, Static, PPPoE, PPTP, and L2TP.

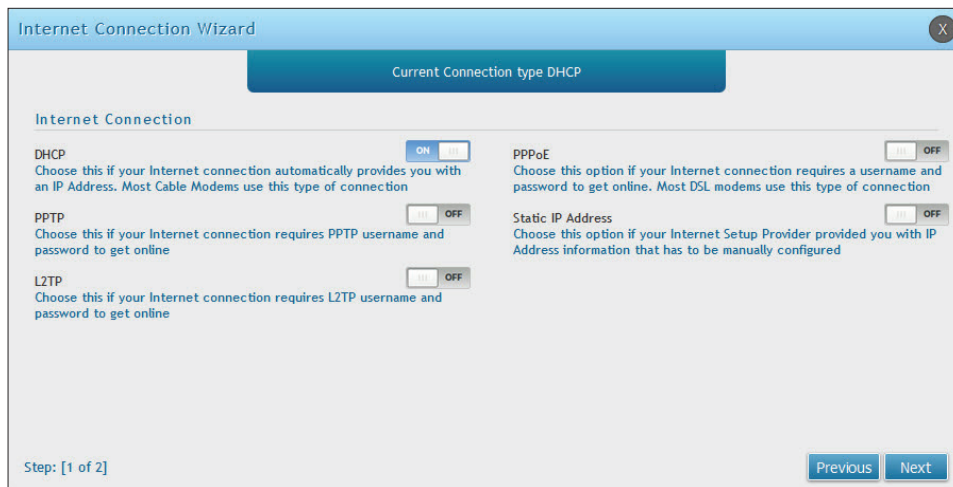

3. Depending on the connection type, a username/password may be required to register this controller with the ISP.

4. In most cases, the default settings can be used if the ISP does not specify that parameter.

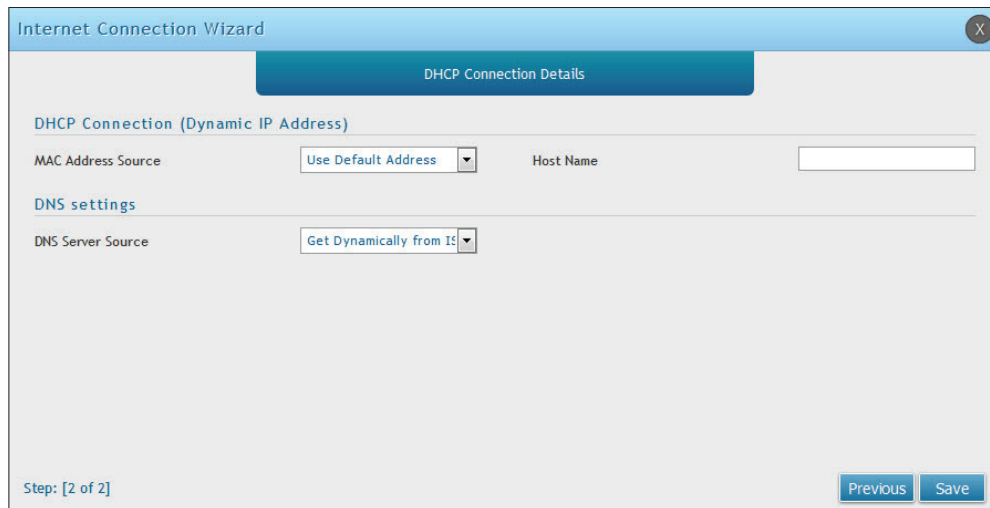

5. The last step in the Wizard is to click the Save button, which confirms the settings by establishing a link with the ISP.

6. Once connected, you can move on and configure other features in this controller.

VPN Wizard

You can use the VPN wizard to quickly create both IKE and VPN policies. Once the IKE or VPN policy is created, you can modify it as required.

Please follow the procedure given below:

1. Select the VPN tunnel type to create.

2. Configure Remote and Local Option address for the tunnel endpoints.

3. Configure the Secure Connection Remote Accessibility fields to identify the remote network.

4. Review the settings and click Connect to establish the tunnel

Note: The VPN Wizard is the recommended method to set up an Auto IPsec policy. Once the Wizard creates the matching IKE and VPN policies required by the Auto policy, one can modify the required fields through the edit link. Refer to the online help for details.

Troubleshooting

In the unlikely event you encounter a problem using the wireless controller, refer to the troubleshooting suggestions in this chapter to identify and resolve the problem.

The topics covered in this chapter are:

- “LED Troubleshooting” on page 366
- “Web Management Interface” on page 366
- “Using the Reset Button to Restore Default Settings” on page 368
- “Problems with Date and Time” on page 368
- “Discovery Problems with Access Points” on page 368
- “Connection Problems” on page 369
- “Network Performance and Rogue Access Point Detection” on page 370
- “Using Diagnostic Tools on the Wireless Controller” on page 371

LED Troubleshooting

After you apply power and turn on the wireless controller, the following sequence of events should occur:

1. When power is first applied, verify that the front panel (green) Power LED to the left of the USB ports is ON.
2. After approximately 2 minutes, verify that the right LAN port LED is ON for any local ports that are connected. This indicates that a link has been established to the connected device.
3. If a RJ-45 port is connected to a 1000Mbps device, verify that the port's left LED is orange. If a port is connected to a 100Mbps device, verify that the port's left LED is green. If a port is connected to a 10Mbps device, verify that the port's right LED is OFF.
4. If a SFP port is connected a 1000Mbps device, verify that the port's LED is orange. If a port is connected to a 100Mbps device, verify that the port's LED is green.

If any of these conditions do not occur, see the appropriate section below.

Power LED is OFF

If the Power and other LEDs are off when your wireless controller is turned on, confirm that the power cord is connected properly to the wireless controller and that the power cord is connected to a functioning power outlet that is not controlled by a wall switch.

If the error persists, please contact D-Link technical support.

LAN Port LEDs Not ON

If the LAN LEDs do not go ON when the Ethernet connection is made:

1. Check that the Ethernet cable connections are secure at the wireless controller and at the switch.
2. Be sure power is applied to the connected switch and that the switch is turned on.
3. Be sure you are using the correct cables (straight-through or crossover).

Web Management Interface

If you cannot access the wireless controller's web management interface from a PC on your local network:

- Check the Ethernet connection between the PC and the wireless controller.
- Be sure your PC's IP address is on the same subnet as the wireless controller. If you are using the recommended addressing scheme, be sure your PC is configured to use a static IPv4 address of 192.168.10.nnn (where nnn is the number 0 or a number from 2 to 255) and a subnet of 255.255.255.0.
- If the wireless controller's IP address has been changed and you do not know the current IP address, reset the wireless controller's configuration to factory default settings. This sets the wireless controller's IP address to 192.168.10.1 (refer to "Soft Reboot" on page 356), but it also loses any changes you made to the factory default settings.
- If you do not want to revert to the factory default settings and lose your configuration settings, you can reboot the wireless controller and use a sniffer to capture packets sent during the reboot. Look at the ARP packets to find the wireless controller's LAN interface address.

-
- Launch your browser and ensure that Java, JavaScript, or ActiveX is enabled. If you are using Internet Explorer, click Refresh to ensure that the Java applet is loaded. Close the browser and launch it again.
 - Ensure that you are using the correct login information. The factory default login name is **admin** and the password is **password**. Ensure that CAPS LOCK is off when entering this information.

Unable to Save Configuration Changes

If the controller does not save the configuration changes, follow the following instructions:

- When entering configuration settings, click **Apply** before moving to another menu or tab; otherwise your changes are lost.
- Click **Refresh** or **Reload** in the browser. Your changes may have been made, but the browser may be caching the old configuration.

Unable to Access Internet

If the controller cannot access the internet, the possible reason for this is that you are using Dynamic IP address and your controller may not have requested an IP address from the ISP.

- Launch your browser and go to an external site such as www.google.com.
- Access the firewall's configuration main menu at <http://192.168.10.1>.
- Select Monitoring > Controller Status.
- Ensure that an IP address is shown for the Option port. If 0.0.0.0 is shown, your firewall has not obtained an IP address from your ISP. See the next symptom.

If the controller cannot obtain the IP address from the ISP:

- Turn off the power to the cable or DSL modem.
- Turn off the controller.
- Wait for 5 minutes, and then reapply power to the cable or DSL modem.
- When the modem LEDs indicate that it has re-synchronized with the ISP, reapply power to the controller. If the controller still cannot obtain an ISP address, see the next symptom.

If the controller still cannot obtain an IP address from the ISP:

- Ask your ISP if it requires a login program — PPP over Ethernet (PPPoE) or some other type of login.
- If yes, verify that your configured login name and password are correct.
- Ask your ISP if it checks for your PC's hostname.
- If yes, select **Network > Internet (IPv4) > Option1 Settings**, and set the account name to the PC hostname of your ISP account.
- Ask your ISP if it allows only one Ethernet MAC address to connect to the Internet, and therefore checks for your PC's MAC address.
- If yes, inform your ISP that you have bought a new network device, and ask them to use the firewall's MAC address.
- Alternatively, select **Network > Internet (IPv4) > Option1 Settings** and configure your controller to spoof your PC's MAC address.

Using the Reset Button to Restore Default Settings

If you cannot access the wireless controller's management interface for some reason, press the reset button on the front panel to restore the factory default settings.

To clear all settings and restore the factory default values:

1. Press and hold the reset button for at least 15 seconds.
2. Release the reset button. The reboot process is complete after several minutes.

Note: After restoring the factory default configuration, the wireless controller's default LAN IP address is 192.168.10.1, the default login user name is **admin**, and the default login password is **admin**.

Problems with Date and Time

The Date and Time page shows the current date and time of day. The wireless controller uses the Network Time Protocol (NTP) to obtain the current time from one of several network time servers on the Internet. Each entry in the log is stamped with the date and time of day.

If you find that the date and time stamps are not accurate,

- Confirm that the wireless controller can reach the Internet.
- If you have just configured the controller, wait for at least 5 minutes, select **Administration > Date and Time > Time Zone**, and recheck the date and time.
- Verify your internet access settings.

If you find that the time is off by an hour,

- Select **Administration > Date and Time > Time Zone**, and view the current date and time settings.
- Toggle the switch to Enable or Disable "**Daylight Savings**", then click **Save**.

Discovery Problems with Access Points

If the wireless controller does not discover any or all access points:

- Be sure the wireless controller is connected to the LAN (see "LAN Port LEDs Not ON" on page 366).
- Be sure you entered the appropriate IP address range if the access points operate in different VLANs, reside behind an IP subnet, or operate in standalone mode (see "Step #1: Enable DHCP Server (Optional)" on page 28).
- If you are using a firewall, unblock the UDP port number for each access port in the firewall.
- Be sure each access point is using a unique IP address (see "AP Discovery Methods" on page 95). If more than one access point has the same IP address, only one of them is discovered. In this case, add the access point to the managed list, change its IP address, and then run discovery again to discover the next access point with that IP address (see "Step #3: Select APs to be Managed" on page 30).

Connection Problems

When an access point is converted from standalone mode to managed mode, its static IP address changes to an IP address that is issued by the DHCP server, either one in the network or one that is configured on the wireless controller. This occurs to ensure that each managed access point has a unique IP address.

If there is no DHCP server or if the access point cannot reach the DHCP server, the access point remains in the Connecting state as it tries to obtain an IP address. If there is no DHCP server in the network, configure one on the wireless controller (see “Step #1: Enable DHCP Server (Optional)” on page 28). When a DHCP server becomes available, the access point can transition from the Connecting state to the Connected state.

If you added a new SSID, but the SSID does not appear under Wi-Fi Networks within 5 minutes, use the following procedure to reboot the Wireless Controller.

1. Click **Maintenance** > **Firmware** > **Soft Reboot**.
2. Click **Soft Reboot**.

Ping to Test LAN Connectivity

Most TCP/IP terminal devices and firewalls contain a ping utility that sends an ICMP echo-request packet to the designated device. The DWC responds with an echo reply. Troubleshooting a TCP/IP network is made very easy by using the ping utility in your PC or workstation.

Procedure to test the LAN path from your PC to your controller:

- On the PC's Windows toolbar, Click Start, and click Run.
- Type ping <IP_address> where <IP_address> is the controller's IP address. Example: ping 192.168.10.1.
- Click OK.
- Observe the display:
 - If the path is working, you see the following message sequence:
Pinging <IP address> with 32 bytes of data
Reply from <IP address>: bytes=32 time=NN ms TTL=xxx
 - If the path is not working, you see the message sequence given below:
Pinging <IP address> with 32 bytes of data
Request timed out.
- If the path is not working, test the physical connections between PC and controller.
 - If the LAN port LED is off, go to the “LED displays” section and follow instructions for “LAN or Internet port LEDs are not lit.”
 - Verify that the corresponding link LEDs are lit for your network interface card and for any hub ports that are connected to your workstation and firewall.
- If the path is still not up, test the network configuration:
 - Verify that the Ethernet card driver software and TCP/IP software are installed and configured on the PC.
 - Verify that the IP address for the controller and PC are correct and on the same subnet.

Testing the LAN path from your PC to a remote device:

- On the PC's Windows toolbar, click Start, and then click Run.
- Type ping -n 10 <IP_address> where -n 10 specifies a maximum of 10 tries and <IP address> is the IP address of a remote device such as your ISP's DNS server. Example: ping -n 10 10.1.1.1.
- Click OK, and then observe the display (see the previous procedure).
- If the path is not working, do the following:
 - Check that the PC has the IP address of your firewall listed as the default gateway. (If the IP configuration of your PC is assigned by DHCP, this information is not visible in your PC's Network Control Panel.)
 - Verify that the network (subnet) address of your PC is different from the network address of the remote device.
 - Verify that the cable or DSL modem is connected and functioning.
 - Ask your ISP if it has assigned a hostname to your PC.
- If yes, select Network > Internet (IPv4) > Option1 Settings and enter that hostname as the ISP account name.
 - Ask your ISP if it rejects the Ethernet MAC addresses of all but one of your PCs.

Many broadband ISPs restrict access by allowing traffic from the MAC address of only your broadband modem; but some ISPs additionally restrict access to the MAC address of just a single PC connected to that modem. If this is the case, configure your firewall to clone or spoof the MAC address from the authorized PC.

Network Performance and Rogue Access Point Detection

When rogue access point detection is enabled, access points intermittently go off channel for short periods, which can affect network performance. If security concerns are more important than network performance, you can enable rogue access point detection. If network performance is more important than security concerns, you can temporarily disable rogue access point detection.

Using Diagnostic Tools on the Wireless Controller

Ping an IP Address

Path: Maintenance > Management > Diagnostics > Network Tools

As part of the diagnostics functions on the wireless controller, you can ping an IP address. You can use this function to test connectivity between the wireless controller and another device on the network connected to the wireless controller.

1. Go to **Maintenance > Management > Diagnostics > Network Tools**.

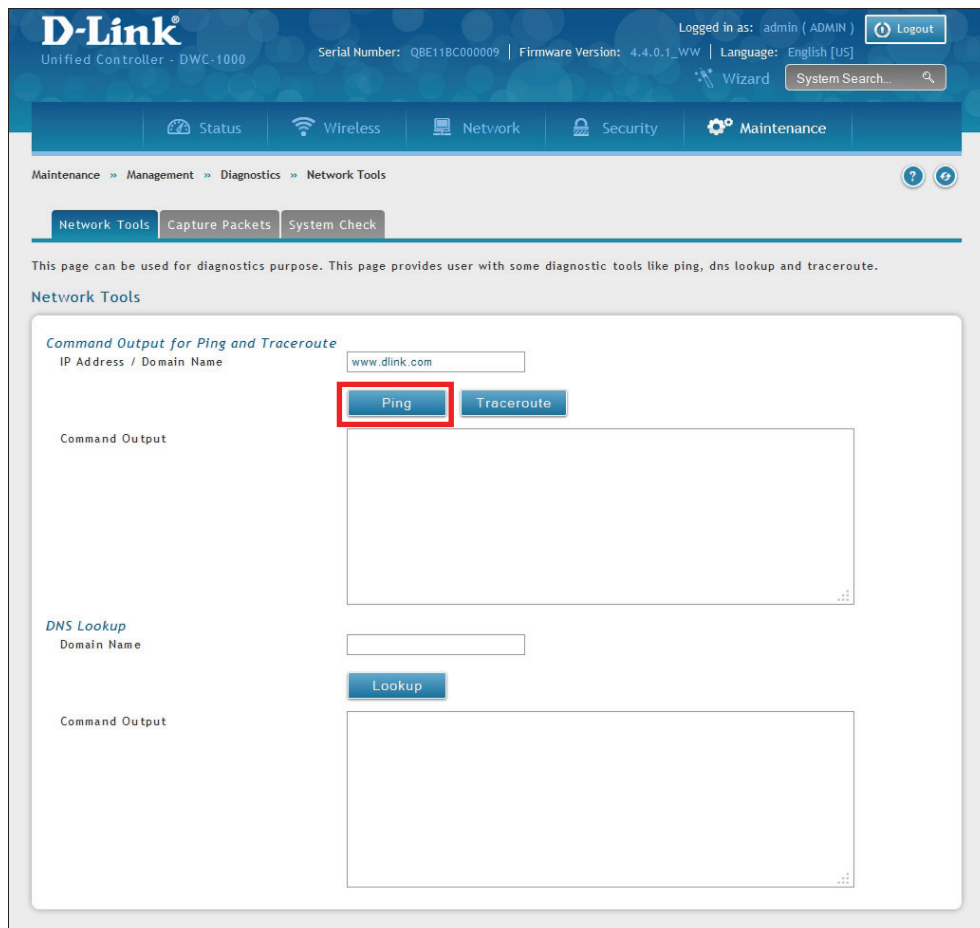

2. Under *Command Output for Ping and Traceroute*, in the IP Address / Domain Name field, enter an IP address or domain name.
3. Click **Ping**. The results will appear in the Command Output display below.

Using Traceroute

Path: Maintenance > Management > Diagnostics > Network Tools

The wireless controller provides a Traceroute function that lets you map the network path to a public host. Up to 30 intermediate controllers (or “hops”) between this wireless controller and the destination will be displayed.

1. Go to **Maintenance > Management > Diagnostics > Network Tools**.

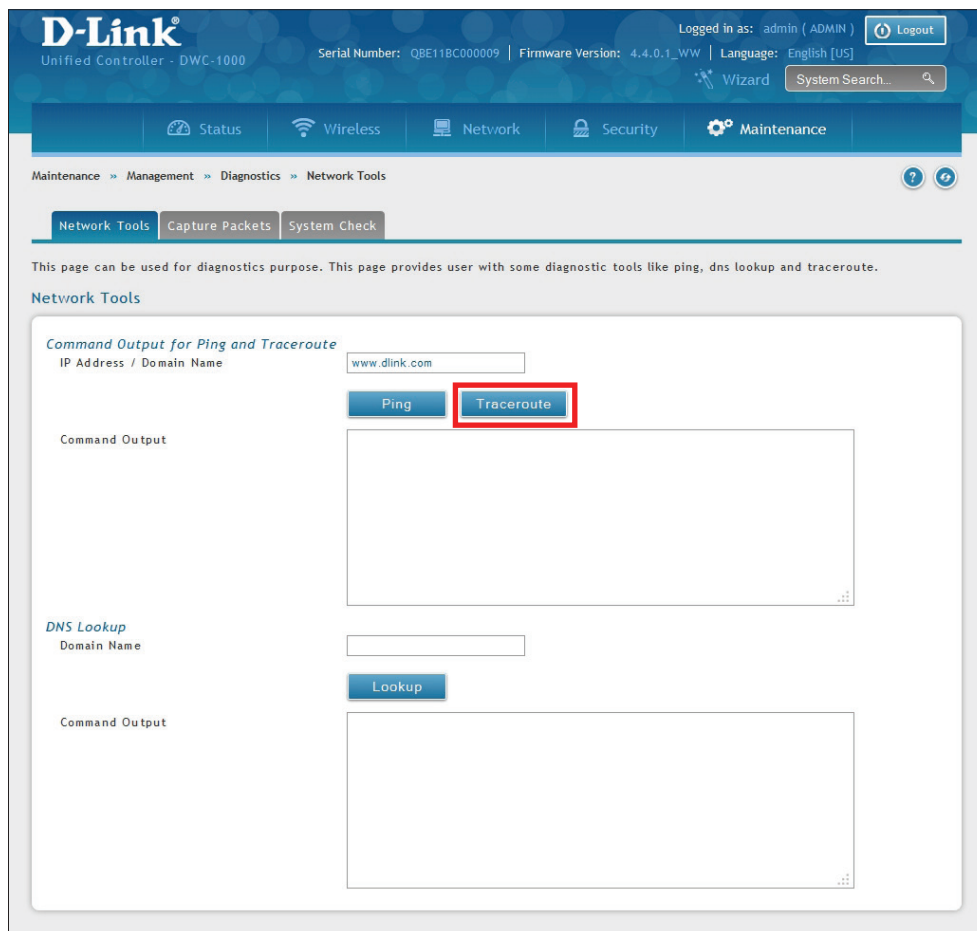

2. Under *Command Output for Ping and Traceroute*, in the IP Address / Domain Name field, enter an IP address or domain name.
3. Click **Traceroute**. The results will appear in the Command Output display given below.

Performing DNS Lookups

Path: Maintenance > Management > Diagnostics > Network Tools

The wireless controller provides a DNS lookup function that lets you retrieve the IP address of a Web, FTP, Mail, or any other server on the Internet.

1. Go to **Maintenance > Management > Diagnostics > Network Tools**.

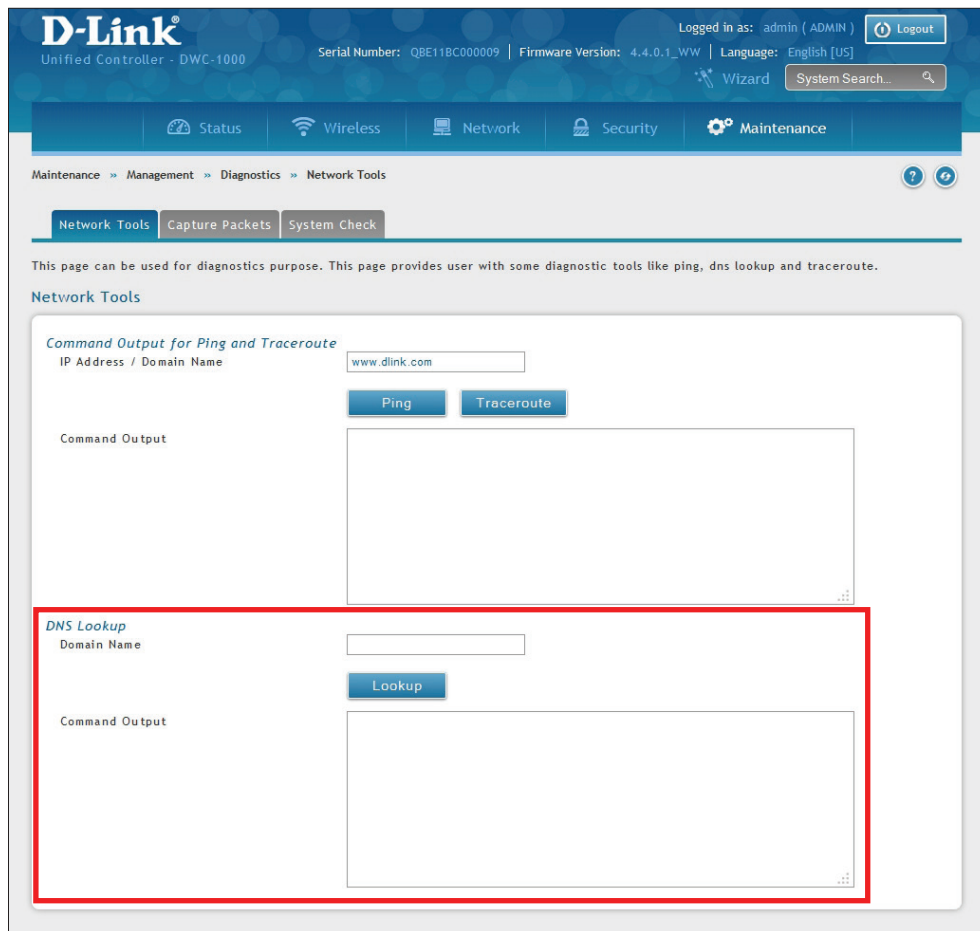

2. Under *DNS Lookup*, in the Domain Name field, enter an Internet name.
3. Click **Lookup**. The results will appear in the Command Output display below. If the host or domain entry exists, a response will appear with the IP address. If the message *Host Unknown* appears, the Internet name does not exist.

Capturing Log Packets

Path: Maintenance > Management > Management > Diagnostics > Capture Packets

The wireless controller lets you capture all packets that pass through the LAN or Option interface. The packet trace is limited to 1 MB of data per capture session. If the capture file size exceeds 1MB, it is deleted automatically and a new capture file is created.

To capture packets:

1. Go to **Maintenance > Management > Diagnostics > Capture Packets**.

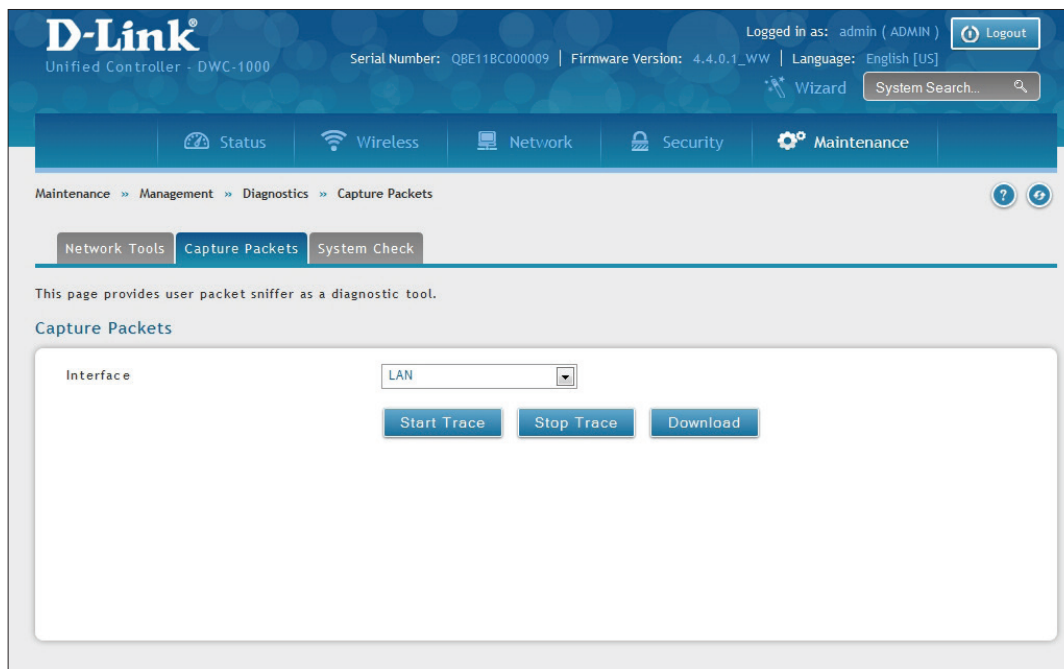

2. Select an interface (LAN or Option 1/Option 2) from the drop-down menu.
3. Click **Start Trace**. The results are shown in the Command Output page. The trace can be downloaded by clicking the **Download** button, which will immediately begin the download to the browsers default download location.

Conducting a System Check

Path: Maintenance > Management > Diagnostics > System Check

As part of the diagnostics functions on the wireless controller, you can ping an IP address. You can use this function to test connectivity between the wireless controller and another device on the network connected to the wireless controller.

1. Go to **Maintenance > Management > Diagnostics > System Check**.

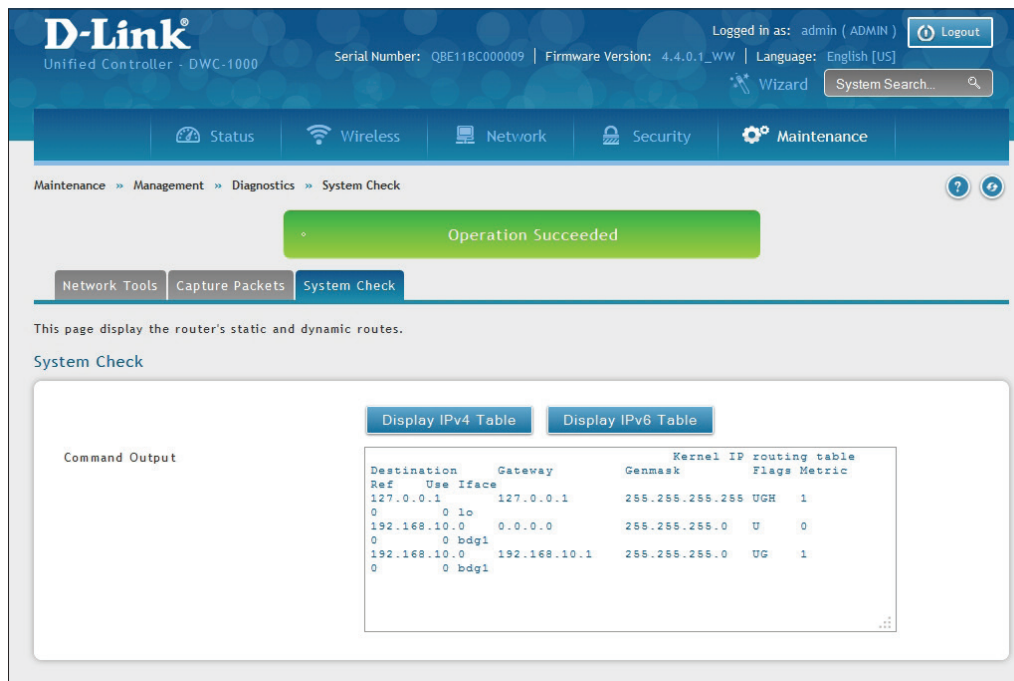

2. Click **Display IPv4 Table** or **Display IPv6 Table**. The results will appear in the Command Output display area.

Generating DBGLOGs

The link (<http://<device-ip>/scgi-bin/dbglog.cgi>) from the device allows the user to download and automate the debug log (dbglog) package, grouping of system status, statistics, and support logs that are useful for D-Link support to evaluate and diagnose the controller issues.

Log Settings

The wireless controller lets you capture log messages. You can monitor the type of traffic that goes through the wireless controller and be notified of potential attacks or errors when they are detected by the controller. The following sections describe the log configuration settings and the ways you can access these logs.

Defining What to Log

Path: Maintenance > Logs Settings > Log Facilities

The Facility Logs page lets you determine the granularity of logs to receive from the wireless controller. Select one of the following facilities: Kernel, System, Network, VPN, WCF, Firewall, Wireless Controller, and Captive Portal.

For each facility, the following events (in order of severity) can be logged:

Severity	Description
Emergency	System is unusable
Alert	Action must be taken immediately
Critical	Critical conditions
Error	Error conditions
Warning	Warning conditions

Field	Description
Notification	Normal but significant condition
Information	Informational
Debugging	Debug-level messages

The display for logging can be customized based on whether the logs are sent to the Event Log viewer in the web management interface (the Event Log viewer is in the Status > System Information > All Logs > Current Logs) or a remote Syslog server for later review. E-mail logs, discussed in a subsequent section, follow the same configuration as logs configured for a Syslog server.

Tracking Traffic/Routing Logs

IPv4

Maintenance > Logs Settings > Routing Logs > IPv4

Traffic through each network segment (LAN, Option, DMZ) can be tracked based on whether the packet was accepted or dropped by the firewall. Denial of service attacks, general attack information, login attempts, dropped packets, and similar events can be captured for review by the IT administrator.

Note: Enabling logging options may generate a significant volume of log messages and is recommended for debugging purposes only.

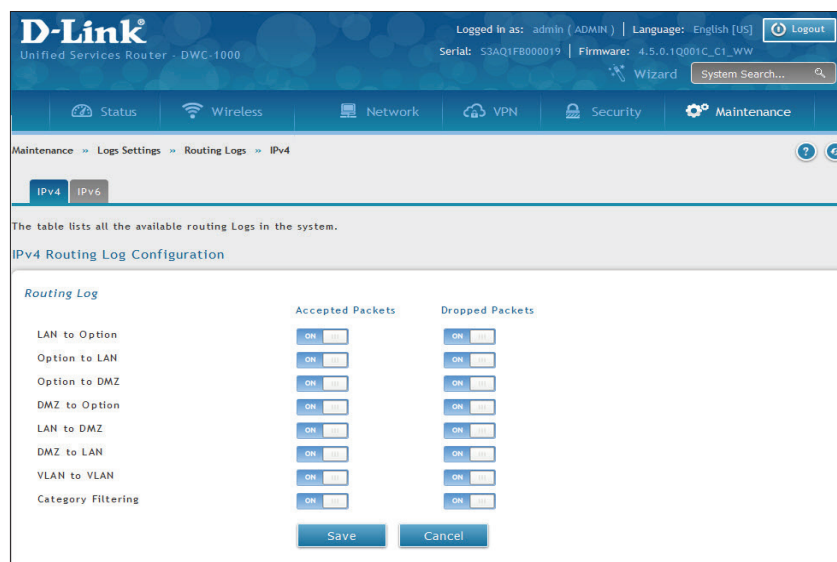

Option	Description
Accepted Packets	If enabled, tracks packets that were transferred through the segment successfully.
Dropped Packets	If enabled, tracks packets that were blocked from being transferred through the segment.

After making your selections on this page, click **Save** to save your changes or click **Cancel** to revert to the previous settings.

IPv6

Maintenance > Logs Settings > Routing Logs > IPv6

This section is used to configure the logging options for each network segment (for example, LAN-WAN).

Note: Enabling logging options may generate a significant volume of log messages and is recommended for debugging purposes only.

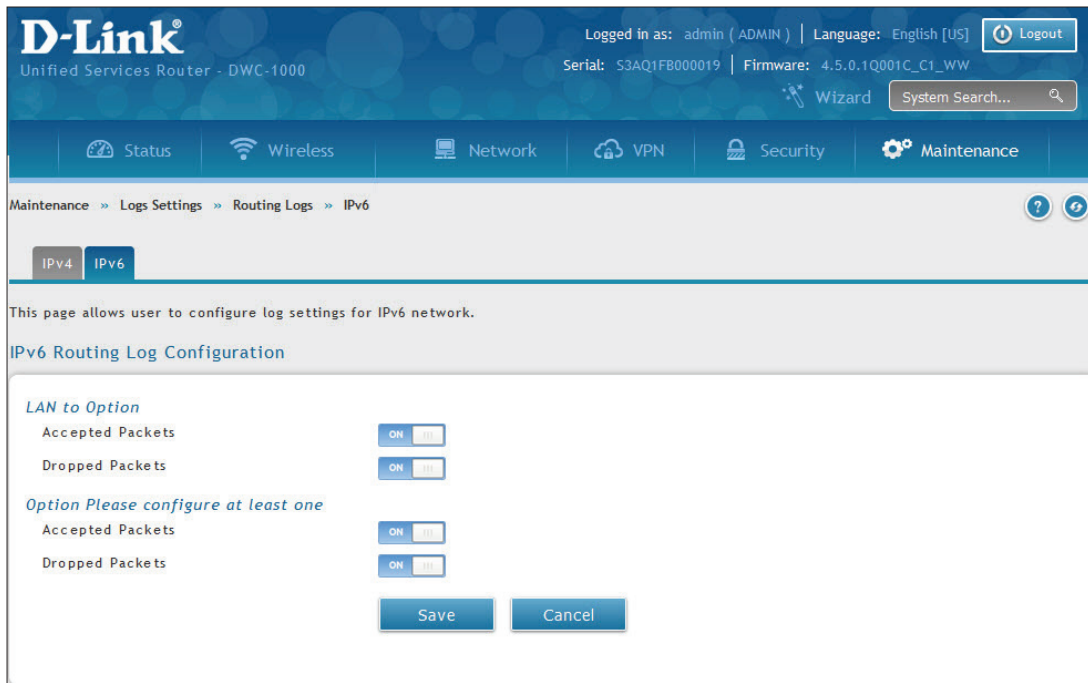

- **Accepted Packets:** This logs packets that were successfully transferred through the segment. This option is useful when the Default Outbound Policy is "Block Always" (see the Firewall Rules page under the Firewall menu).
Example: If Accepted Packets from LAN to WAN is enabled and there is a firewall rule to allow SSH traffic from LAN, whenever a LAN machine tries to make an SSH connection, those packets will be accepted and a message will be logged. (Make sure the log option is set to allow for this firewall rule.)
- **Dropped Packets:** It logs packets that were blocked from being transferred through the segment. This option is useful when the Default Outbound Policy is "Allow Always" (see the Firewall Rules page under the Firewall menu).
Example: If Dropped Packets from LAN to WAN is enabled and there is a firewall rule to block SSH traffic from LAN, then whenever a LAN machine tries to make an SSH connection, those packets will be dropped and a message will be logged. (Make sure the log option is set to allow for this firewall rule.)

System Logging

Path: Maintenance > Logs Settings > System Logs

The System Logs page lets you select the type of traffic passing through the wireless controller that you want to log for display in Syslog, E-mailed logs, or the Event Viewer. This page helps in capturing the suspicious activity such as denial-of-service attacks, general attack information, login attempts, dropped packets, and similar events. Traffic can be tracked based on whether the packet was accepted or dropped by the firewall.

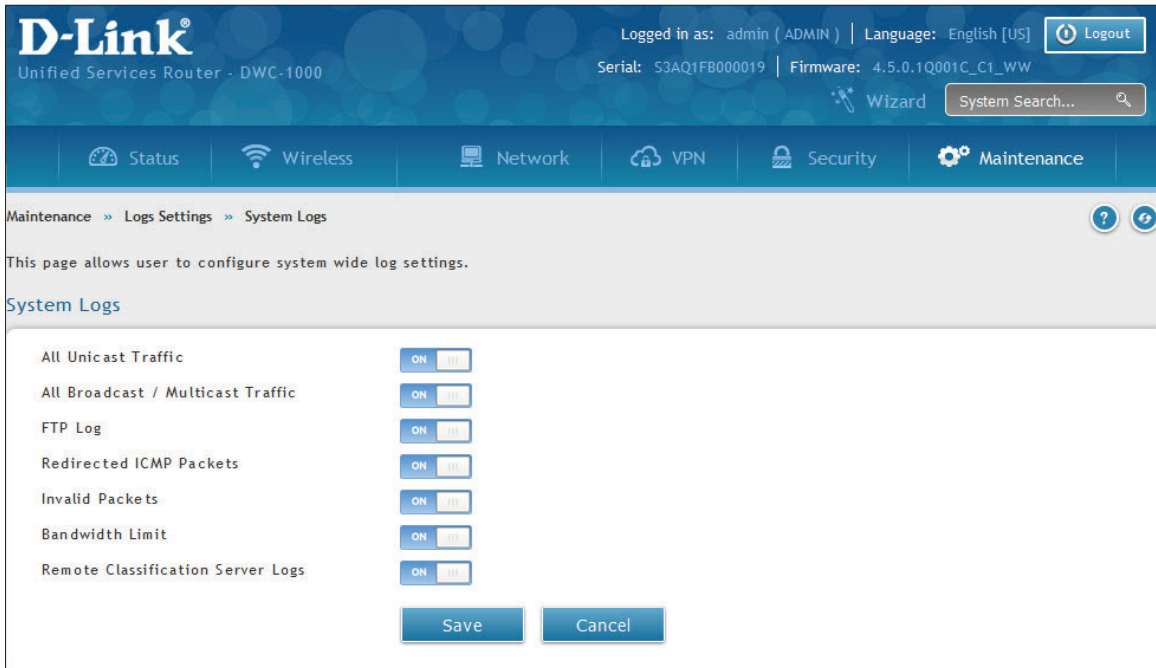

Routing Logs	
All Unicast Traffic	If enabled, tracks packets directed to the wireless controller.
All Broadcast / Multicast Traffic	If enabled, tracks all broadcast or multicast packets directed to the wireless controller.
FTP Logs	If enabled, logged information is sent to FTP logs.
Redirected ICMP Packets	If enabled, tracks the number of redirected Internet Control Message Protocol (ICMP) packets.
Invalid Packets	If enabled, tracks the number of invalid packets received.
Bandwidth Limit	If enabled, it tracks the number of packets exceeded the bandwidth range.
Remote Classification Server Logs	By enabling this option, the logs related to WCF classification will be logged, this option is available only when the WCF licence is enabled in device.

Remote Logging

Email

Path: Maintenance > Logs Settings > Remote Logging > Email

The wireless controller can be configured to send logs to an e-mail address. E-mail logs can be sent out based on a defined schedule by first choosing the frequency: hourly, daily, or weekly. The wireless controller lets you send configuration logs to three e-mail recipients.

The screenshot shows the 'Email Log Configuration' page in the D-Link web interface. The page title is 'Email Log Configuration' and it includes a description: 'This page allows user to configure the remote logging options for the router.' The configuration fields are as follows:

- Remote Log Identifier: DWC-1000
- E-Mail Log: ON
- E-Mail Server Address: [Empty]
- SMTP Port: [Empty] (Range: 1 - 65535)
- Return E-Mail Address: [Empty]
- Send to E-Mail Address (1): [Empty]
- Send to E-Mail Address (2): [Empty] (Optional)
- Send to E-Mail Address (3): [Empty] (Optional)
- Authentication with SMTP: Plain Login (Other options: None, CRAM-MD5)
- User Name: [Empty]
- Password: [Empty]
- Enable Tls: ON
- Respond to Identd from SMTP: ON
- E-Mail log by schedule: Never (Other options: Hourly, Daily, Weekly)

Buttons: Save, Cancel

Field	Description
Log Options	
Remote Log Identifier	Enter a prefix used to identify the source of the message. This identifier is prefixed to both e-mail and Syslog messages.
Routing Logs	
E-Mail Logs	Enables or disables e-mail logs. Choices are: <ul style="list-style-type: none"> • ON = enable e-mail logs. Complete the remaining fields on this page. • OFF = disable e-mail logs. The remaining fields on this page are unavailable.
E-Mail Server Address	If E-Mail Logs is enabled, enter the IP address or Internet Name of a Simple Mail Transfer Protocol (SMTP) server. The wireless controller will connect to this server to send e-mail logs when required. The SMTP server must be operational for e-mail notifications to be received.
SMTP Port	If E-Mail Logs is enabled, enter the SMTP port of the e-mail server.
Return E-Mail Address	If E-Mail Logs is enabled, enter the e-mail address where the replies from the SMTP server are to be sent (required for failure messages).
Send to E-mail Address(1-3)	If E-Mail Logs is enabled, enter up to three email addresses where logs and alerts are to be sent.

Authentication with SMTP Server	<p>If E-Mail Logs is enabled, select an authentication if the SMTP server requires authentication before accepting connections. Choices are:</p> <ul style="list-style-type: none"> • None = no authentication is used. The User Name and Password fields are not available. • Login Plain = authentication used to log in using Base64-encoded passwords over non-encrypted communication session. Base64-encoded passwords offer no cryptographic protection, making them vulnerable. • CRAM-MD5 = a challenge-response authentication mechanism defined in RFC 2195 based on the HMAC-MD5 MAC algorithm. CRAM-MD5 offers a higher level of authentication than Login Plain.
Field	Description
User Name	If Authentication with SMTP Server is set to Login Plain or CRAM-MD5, enter the user name to be used for authentication.
Enable Tls	If the SMTP server requires Tls support to sent logs through emails, then this option should be enabled, and this field is available only for authentication methods Plain Login or CRAM-MD5 .
Password	If Authentication with SMTP Server is set to Plain Login or CRAM-MD5, enter the case-sensitive password to be used for authentication.
Respond to Identd from SMTP	<p>If E-Mail Logs is enabled, this option determines whether the wireless controller responds to IDENT requests from the SMTP server. Choices are:</p> <ul style="list-style-type: none"> • ON = wireless controller responds to an IDENT request from the SMTP server. • OFF = wireless controller ignores IDENT requests from the SMTP server.
Send E-Mail Logs by Schedule	
To receive e-mail logs according to a schedule, configure the appropriate schedule settings. Scheduling options are enabled when the Enable E-Mail Logs option is checked.	
Unit	<p>Select the period of time that you need to send the log. This option is useful when you do not want to receive logs by e-mail, but want to keep e-mail options configured, so you can use the Send Log function Event Log viewer pages. Choices are:</p> <ul style="list-style-type: none"> • Never = disable sending of logs. • Hourly = send logs every hour. • Daily = send logs every day at the specific time. • Weekly = send logs weekly, at the Day and Time specified.
Day	If Unit is set to Weekly, select the day when logs will be sent.
Time	If Unit is set to Daily or Weekly, select the time when logs will be sent.

Syslog Server Configuration

Path: Maintenance > Logs Settings > Remote Logging > Syslog

An external Syslog server is often used by network administrator to collect and store logs from the wireless controller. This remote device typically has less memory constraints than the local Event Viewer on the wireless controller's web management interface. Therefore, a number of logs can be collected over a sustained period. This is useful for debugging network issues or to monitor controller traffic over a long duration.

The wireless controller supports 8 concurrent Syslog servers. Each server can be configured to receive different log facility messages of varying severity using the Remote Logging page.

Syslog Server Configuration

To enable a Syslog server, click the ON/OFF switch next to the Syslog server field and enter an IP address or FQDN in the Name field. The selected facility and severity level messages are sent to the configured (and enabled) Syslog server after you save the settings on this page.

Switch	To have the wireless controller send logs to a Syslog server, check one or more boxes. You can check up to 8 Syslog servers and use them concurrently.
FQDN/IP Address	Enter the IP address or Internet Name of the Syslog server.
Facility	For each syslog server, select a unique facility for logging.
Severity	Select the appropriate Syslog severity. When a severity is selected, all Syslogs with severity equal to or greater than the chosen severity are logged on the configured Syslog Server.

All Logs

Current Logs

Path: Status > System Information > All Logs > Current Logs

The Display Logs window allows you to view configured log messages from the controller as they appear. Each log will appear with a timestamp as determined by the controller's configured time. If remote logging such as a Syslog server or e-mail logging is configured, the same logs are sent to the remote interface while being displayed here. The logs are displayed based on the selection of facility, category, and severity levels.

- Click **Refresh** to refresh logs or reload page again.
- Click **Clear All** to remove all entries in the Display Logs screen.
- Click **Send Logs** to send all logs in the Display Logs screen to pre-configured e-mail recipients.
- Click **Export Logs** to export/save the current log entries to a file.

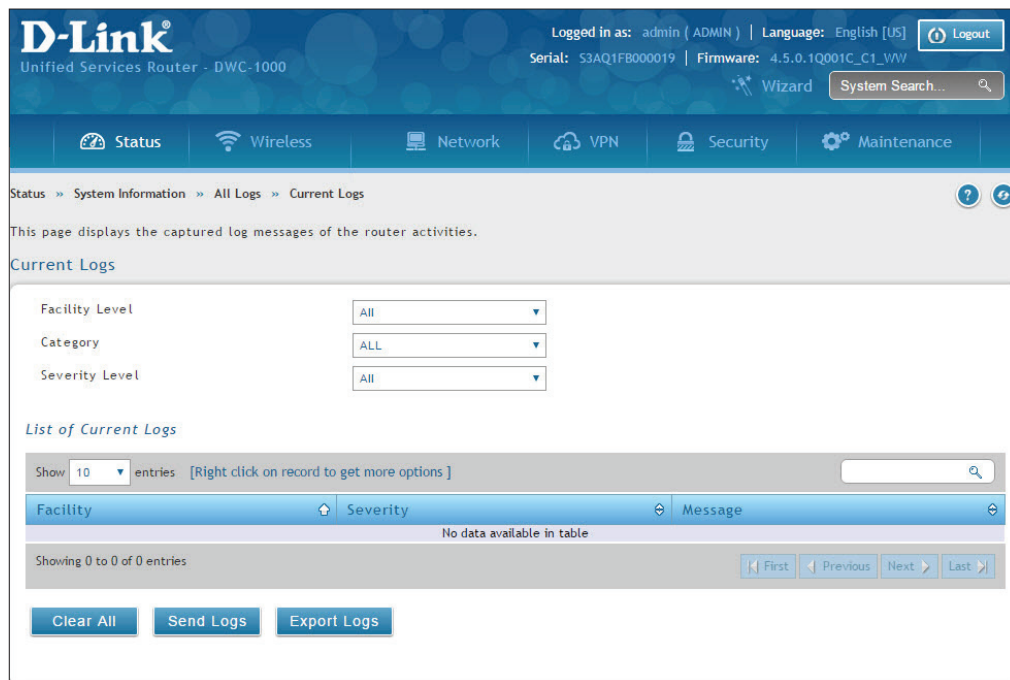

Field	Description
Facility Level	Filter the logs based on the facility level selected .
Category	Filter the logs based on category selected .
Severity Level	Filter the logs based on the severity level selected .
List of Current Logs	
The List of Current Logs window allows you to view configured log messages from the router as they appear. Each log appears with a timestamp as determined by the router's configured time and based on the selection of facility, category, severity levels combination. If remote logging such as a syslog server or e-mail logging is configured, the same logs are sent to the remote interface while being displayed here .	

Appendix A - Basic Planning Worksheet

RF planning enables you to specify how Wi-Fi coverage will be provided. It provides coverage maps and locations prone to weak signals or dead spots that might require additional access points to provide adequate Wi-Fi coverage.

A Basic Planning Worksheet similar to the one in this appendix allows you to collect the following critical information to expedite your planning efforts.

- Building dimensions
- Walls and possible obstructions to wireless coverage
- Number of floors
- Distance between floors
- Total number of users and number of users per access point
- Radio type(s)
- Desired access point data rates
- Areas where you want to deploy access points
- Areas where you cannot deploy an access point
- Areas where you do not want coverage

Step	Task	Completed?
Site Planning		
1	Height of building	
2	Width of building	
3	Number of floors	
4	Floor dimensions	
5	Distance between floors	
6	Visual obstructions	
7	Possible causes of interference	
Access Point Planning		
1	Frequency band	
2	Expected signal quality	
3	Number of clients per access point	
4	Total number of clients per floor	
5	Desired access point data rate	
Wireless Controller Planning		
1	Change the wireless controller default password and record it here:	
2	Configure your time zone and record it here _____	
3	Use default radio configuration? Profile Name: _____ Clients _____ Modes Available: 802.11 b/g: 802.11 n: 802.11 b/g/n: 802.11 a – 5 GHz Only: 802.11 a/n – 5 GHz Only: 802.11 a/n/ac - 5 GHz Only:	
4	SSID information Service Set Identifier (SSID) name: _____ Security (none, WEP, WPA, or WPA2): _____	
5	Use wireless controller as a DHCP server? Yes = host name and IP address should be assigned dynamically. No = use DHCP relay or configure static IP addresses and record them below. IP address: IP subnet mask: Gateway IP address: Primary DNS server: Secondary DNS server:	

6	LAN IP address:	
7	Subnet Mask:	
8	IP address range: Starting IP address range: Ending IP address range:	
9	Default gateway (optional):	
10	DNS server: Primary DNS server: Secondary DNS server:	
11	Domain:	
12	WINS server:	
13	Are you connected to the Internet? Yes No	
14	Confirm and record firmware levels for the wireless controller and all access points: DWC-1000 wireless controller: DWL-2600AP access point: DWL-3600AP access point: DWL-6600AP access point: DWL-6700AP access point: DWL-8600AP access point: DWL-3610AP access point: DWL-6610AP access point: DWL-8610AP access point: DWL-8710AP access point:	
15	Record MAC addresses for the wireless controller and all access points: DWC-1000 wireless controller: DWL-2600AP access point(s): DWL-3600AP access point(s): DWL-6600AP access point(s): DWL-6700AP access point(s): DWL-8600AP access point(s): DWL-3610AP access point(s): DWL-6610AP access point(s): DWL-8610AP access point(s): DWL-8710AP access point(s):	

Appendix B - Factory Default Settings

Feature	Description	Default Setting
Device Login	User login URL	http://192.168.10.1
	User name (case sensitive)	admin
	Login password (case sensitive)	admin
Local area network (LAN)	IP address	192.168.10.1
	IPv4 subnet mask	255.255.255.0
	DHCP server	Disabled
	Time zone	GMT
	Time zone adjusted for Daylight Savings Time	Disabled
	SNMP	Disabled
	Remote management	Disabled

Appendix C - Glossary

Access Point - A device that provides network access to wireless devices.

ARP - Address Resolution Protocol. Broadcast protocol for mapping IP addresses to MAC addresses.

CHAP - Challenge-Handshake Authentication Protocol. Protocol for authenticating users to an ISP.

DDNS - Dynamic DNS. System for updating domain names in real time. Allows a domain name to be assigned to a device with a dynamic IP address.

DHCP - Dynamic Host Configuration Protocol. Protocol for allocating IP addresses dynamically so that addresses can be reused when hosts no longer need them.

DNS - Domain Name System. A hierarchical distributed naming system for computers, services, or any resource connected to the Internet or a private network.

FQDN - Fully qualified domain name. Complete domain name, including the host portion. Example: serverA.companyA.com.

FTP - File Transfer Protocol. Protocol for transferring files between network nodes.

HTTP - Hypertext Transfer Protocol. Protocol used by web browsers and web servers to transfer files.

IKE - Internet Key Exchange. Mode for securely exchanging encryption keys in ISAKMP as part of building a VPN tunnel.

IP - Internet Protocol. The principal communications protocol used for relaying datagrams known as network packets across an internetwork using the Internet Protocol Suite. IP is responsible for routing packets across network boundaries. It is the primary protocol that establishes the Internet.

IPSec - IP security. Suite of protocols for securing VPN tunnels by authenticating or encrypting IP packets in a data stream. IPSec operates in either transport mode (encrypts payload but not packet headers) or tunnel mode (encrypts both payload and packet headers).

ISAKMP - Internet Key Exchange Security Protocol. Protocol for establishing security associations and cryptographic keys on the Internet.

ISP - Internet service provider.

MAC Address - Media-access-control address. Unique physical-address identifier attached to a network adapter.

MTU - Maximum transmission unit. Size, in bytes, of the largest packet that can be passed on. The MTU for Ethernet is a 1500-byte packet.

NAT - Network Address Translation. Process of rewriting IP addresses as a packet passes through a controller or firewall. NAT enables multiple hosts on a LAN to access the Internet using the single public IP address of the LAN's gateway controller.

NetBIOS - Microsoft Windows protocol for file sharing, printer sharing, messaging, authentication, and name resolution.

NTP - Network Time Protocol. Protocol for synchronizing a controller to a single clock on the network, known as the clock master.

PAP - Password Authentication Protocol. Protocol for authenticating users to a remote access server or ISP.

PPPoE - Point-to-Point Protocol over Ethernet. Protocol for connecting a network of hosts to an ISP without the ISP having to manage the allocation of IP addresses.

PPTP - Point-to-Point Tunneling Protocol. Protocol for creation of VPNs for the secure transfer of data from remote clients to private servers over the Internet.

RADIUS - Remote Authentication Dial-In User Service. Protocol for remote user authentication and accounting. Provides centralized management of usernames and passwords.

RSA - Rivest-Shamir-Adleman. Public key encryption algorithm.

SSID - Service Set Identifier. A case-sensitive, 32-alphanumeric character unique identifier used for naming wireless networks. The SSID differentiates one wireless network from another. All access points and devices trying to connect to a specific wireless network must use the same SSID to enable effective roaming.

Subnet - A portion of a network that shares a common address component. On TCP/IP networks, subnets are defined as all devices whose IP addresses have the same prefix. For example, all devices with IP addresses that start with 100.100.100 belong to the same subnet.

TCP - Transmission Control Protocol. Protocol for transmitting data over the Internet with guaranteed reliability and in-order delivery.

UDP - User Data Protocol. Protocol for transmitting data over the Internet quickly but with no guarantee of reliability or in-order delivery.

VPN - Virtual private network. Network that enables IP traffic to travel securely over a public TCP/IP network by encrypting all traffic from one network to another. Uses tunneling to encrypt all information at the IP level.

WINS - Windows Internet Name Service. Service for name resolution. Allows clients on different IP subnets to dynamically resolve addresses, register themselves, and browse the network without sending broadcasts.

Wireless Controller - D-Link device that centralizes and simplifies network management of a wireless LAN by consolidating individually managed access points into a single, unified solution.