

5G NR Gateway

DWM-3010

User Manual



5G NR M2M Gateway

Chapter 1 Introduction.....	7
1.1 Introduction	7
1.2 Contents List	8
1.2.1 Package Contents.....	8
1.3 Hardware Configuration.....	10
1.4 LED Indication.....	12
1.5 Installation & Maintenance Notice.....	13
1.5.1 SYSTEM REQUIREMENTS.....	13
1.5.2 WARNING.....	13
1.5.3 HOT SURFACE CAUTION	15
1.6 Hardware Installation.....	16
1.6.1 Insert the SIM Card, MicroSD Card.....	16
1.6.2 Mount the Unit.....	17
1.6.3 Install the External RF Cable and Antenna	17
1.6.4 Connecting I/O Devices	18
1.6.5 Connecting Serial Devices.....	20
1.6.6 Connecting Power	20
1.6.7 Connecting to the Network or a Host.....	21
1.6.8 Setup by Configuring WEB UI	21
Chapter 2 Basic Network.....	23
2.1 WAN & Uplink.....	23
2.1.1 Physical Interface	24
2.1.2 Connection Setup	30
2.1.3 Load Balance	51
2.2 LAN & VLAN	56
2.2.1 Ethernet LAN	56
2.2.2 VLAN	59
2.2.3 DHCP Server	72
2.3 WiFi.....	80
2.3.1 WiFi Configuration.....	81
2.3.2 Wireless Client List	95

5G NR M2M Gateway

2.3.3 Advanced Configuration	97
2.4 IPv6	100
2.4.1 IPv6 Configuration	100
2.5 Port Forwarding.....	108
2.5.1 Configuration.....	109
2.5.2 Virtual Server & Virtual Computer.....	110
2.5.3 DMZ & Pass Through	116
2.5.4 Special AP & ALG (not supported)	119
2.5.5 IP Translation	120
2.6 Routing.....	123
2.6.1 Static Routing	124
2.6.2 Dynamic Routing	127
2.6.3 Routing Information	135
2.7 DNS & DDNS.....	136
2.7.1 DNS & DDNS Configuration	136
2.8 QoS	140
2.8.1 QoS Configuration.....	140
2.9 Redundancy	149
2.9.1 VRRP	149
Chapter 3 Object Definition.....	152
3.1 Scheduling.....	152
3.1.1 Scheduling Configuration.....	152
3.2 User (not supported)	154
3.3 Grouping.....	155
3.3.1 Host Grouping	155
3.4 External Server	157
3.5 Certificate	160
3.5.1 Configuration.....	160
3.5.2 My Certificate.....	163
3.5.3 Trusted Certificate	170
3.5.4 Issue Certificate	177

5G NR M2M Gateway

Chapter 4 Field Communication	180
4.1 Bus & Protocol	180
4.1.1 Port Configuration	180
4.1.2 Virtual COM	182
4.1.3 Modbus	193
4.2 Data Logging	203
4.2.1 Data Logging Configuration	206
4.2.2 Scheme Setup	208
4.2.3 Log File Management	210
4.3 Data Interchange	212
4.3.1 MQTT	212
Chapter 5 Security	223
5.1 VPN	223
5.1.1 IPSec	224
5.1.2 OpenVPN	232
5.1.3 L2TP	245
5.1.4 PPTP	253
5.1.5 GRE	260
5.2 Firewall	264
5.2.1 Packet Filter	264
5.2.2 URL Blocking	269
5.2.3 MAC Control	273
5.2.4 Content Filter (not supported)	276
5.2.5 Application Filter (not supported)	277
5.2.6 IPS	278
5.2.7 Options	282
Chapter 6 Administration	286
6.1 Configure & Manage	286
6.1.1 Command Script	287
6.1.2 D-ECS(D-LINK EDGE CLOUD SOLUTION)	291
6.1.3 SNMP	293
6.1.4 Telnet & SSH	304

5G NR M2M Gateway

6.2 System Operation	307
6.2.1 Password & MMI	307
6.2.2 System Information	311
6.2.3 System Time	312
6.2.4 System Log	317
6.2.5 Backup & Restore	322
6.2.6 Reboot & Reset	323
6.3 FTP	324
6.3.1 Server Configuration	325
6.3.2 User Account	327
6.4 Diagnostic	328
6.4.1 Diagnostic Tools	328
6.4.2 Packet Analyzer	330
Chapter 7 Service	333
7.1 Cellular Toolkit	333
7.1.1 Data Usage	333
7.1.2 SMS	337
7.1.3 SIM PIN	341
7.1.4 USSD (not supported)	345
7.1.5 Network Scan	346
Chapter 8 Status	348
8.1 Dashboard	348
8.1.1 Device Dashboard	348
8.2 Basic Network	350
8.2.1 WAN & Uplink Status	350
8.2.2 LAN & VLAN Status	354
8.2.3 WiFi Status	355
8.2.4 DDNS Status	358
8.3 Security	359
8.3.1 VPN Status	359
8.3.2 Firewall Status	364

5G NR M2M Gateway

8.4 Administration.....	368
8.4.1 Configure & Manage Status.....	368
8.4.2 Log Storage Status.....	370
8.5 Statistics & Report.....	371
8.5.1 Connection Session.....	371
8.5.2 Network Traffic.....	372
8.5.3 Login Statistics.....	373
8.5.4 Cellular Usage.....	374
Regulatory Information.....	378

5G NR M2M Gateway

Chapter 1 Introduction

1.1 Introduction

Congratulations on your purchase of this outstanding product: 5G NR M2M Gateway. For Industrial IoT applications, D-LINK 5G NR M2M Gateway is absolutely the right choice.

With a built-in world-class 5G module, you just need to insert SIM card from local mobile carrier to get to Internet. The dual SIM design provides a more reliable WAN connection for critical applications. By VPN tunneling technology, remote sites easily become a part of Intranet, and all data are transmitted in a secure (256-bit AES encryption) link. The feature of AI/DI/DO allows gateway to have real-time response whenever events are detected by sensors.

This DWM-3010 series product is loaded with luxuriant security features including VPN, firewall, NAT, port forwarding, DHCP server and many other powerful features for industrial IoT (IIoT) applications.

Main Features:

- Built-in a high speed 5G NR cellular module for high bandwidth and low latency traffic.
- Support dual SIMs for the redundant wireless WAN connection.
- Provide Gigabit Ethernet ports to connect other IP-based devices.
- Provide RS-232/485 serial port for controlling legacy serial devices or Modbus devices.
- Equip 802.11b/g/n/ac concurrent dualband WiFi access point.
- Designed by solid and easy-to-mount metal body for industrial environment to work with a variety IIoT applications.

Before you install and use this product, please read this manual in detail for fully exploiting the functions of this product.

5G NR M2M Gateway

1.2 Contents List

1.2.1 Package Contents

#Standard Package

Items	Description	Contents	Quantity
1	DWM-3010 5G NR M2M Gateway(*1)		1pcs
2	10 pin Terminal Block		1pcs
3	4 pin Terminal Block		1pcs
4	2 pin Terminal Block		1pcs
5	RJ45 Cable		1pcs
6	DIN-Rail Bracket		1pcs
7	5G NR FR1 Antenna		4pcs
8	WiFi 2.4G/5G Antenna		2pcs
9	DC 12 V Power adapter		1pcs

1 The maximum power consumption of DWM-3010 series product is 20.0 Watt (TBC)

5G NR M2M Gateway

5G NR M2M Gateway

1.3 Hardware Configuration

➤ Front View

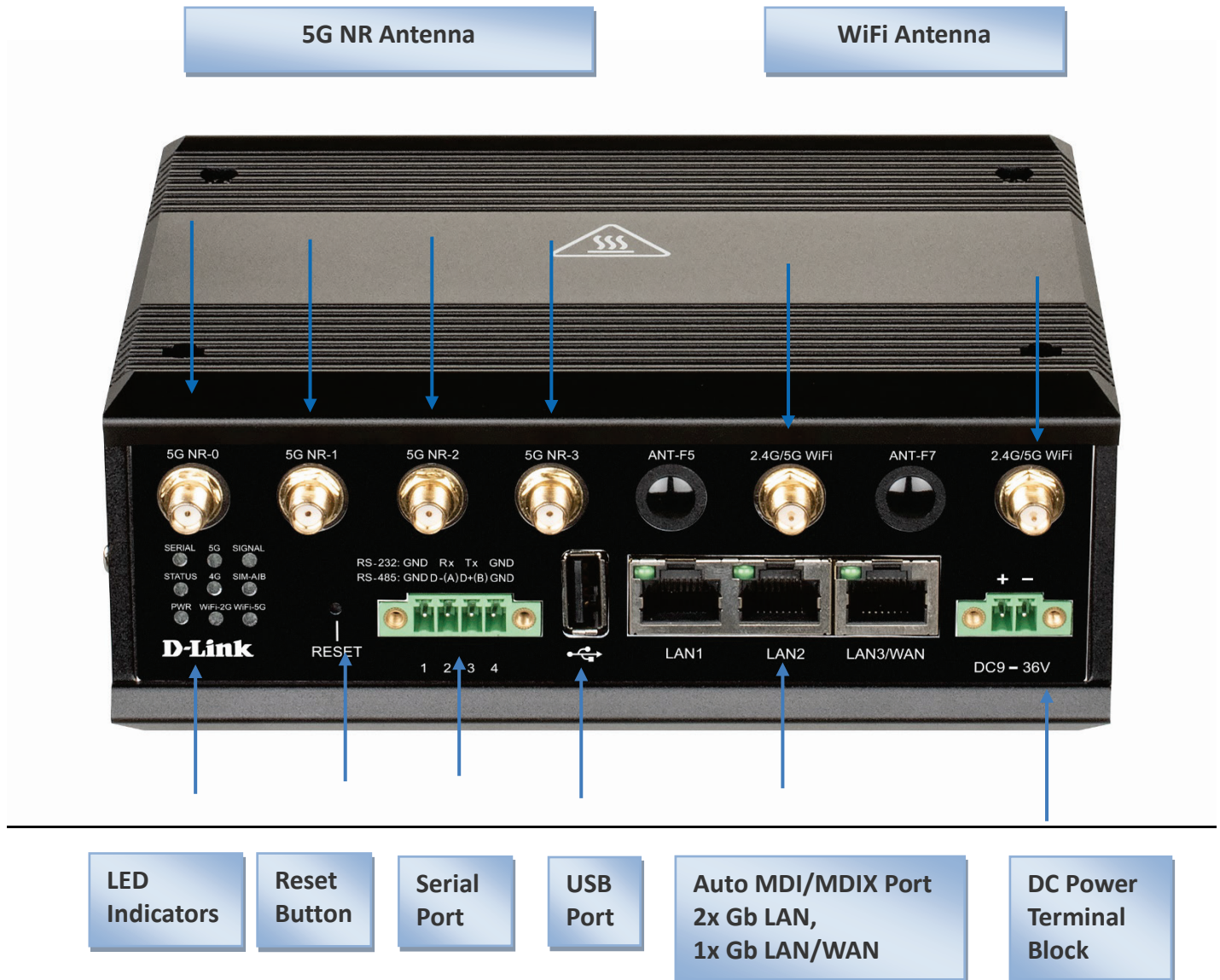

⌘ Reset Button

The RESET button provides user with a quick and easy way to restore the default setting. Press the RESET button continuously for 6 seconds, and then release it. The device will restore to factory default settings.

⌘ 5G NR, WiFi Antenna

All the 5G NR and WiFi antennas are optional accessories, and not included in the standard package. You need to purchase the suitable antennas and required RF cables to fit your application.

5G NR M2M Gateway

➤ Left View

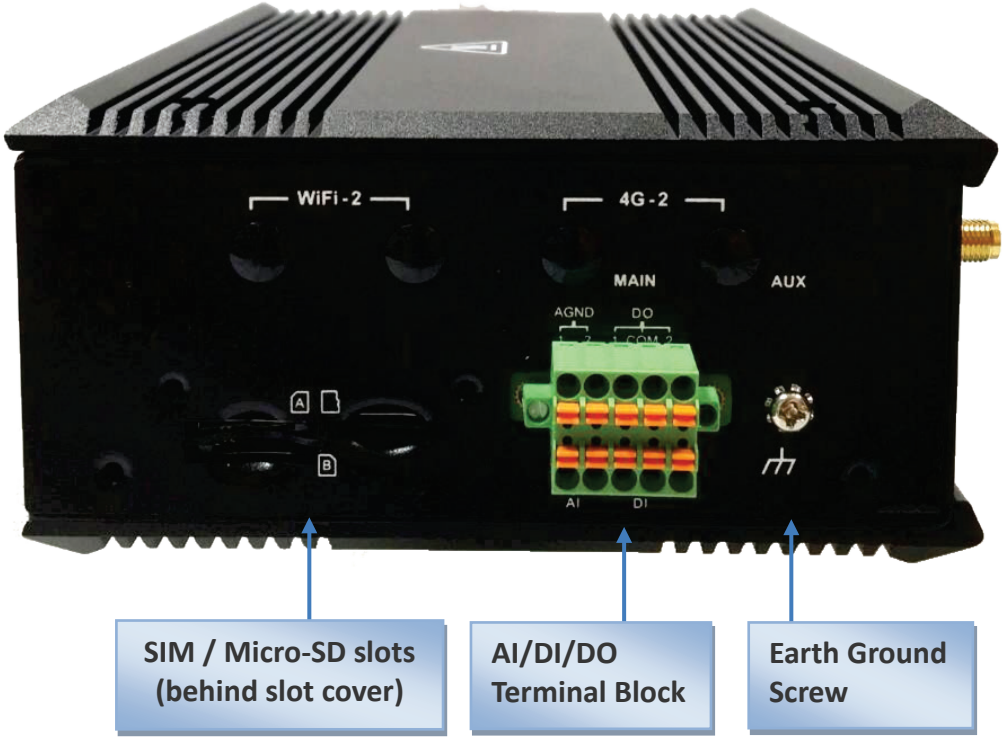

5G NR M2M Gateway

1.4 LED Indication

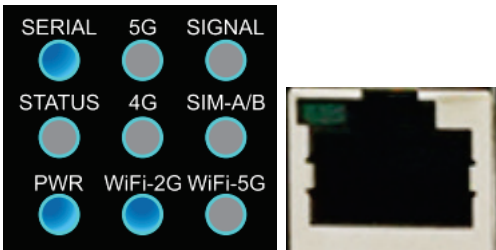

LED Icon	Indication	LED Color	Description
	Power Source	Blue	OFF: Device is powered off. Steady ON: Device is powered ON.
	Status	Blue	Flash (per Second) : Device works normally. Flash(very fast) : Device is in Recovery Mode or abnormal.
	Serial	Blue	OFF : No Serial data transferred via serial port Flash : while data packet transferred via Serial port
	WiFi-2GHz	Blue	OFF : WiFi function was disabled Steady ON : WiFi(2.4GHz) is enabled Flash : Data packet transferred via WiFi1 LAN interface.
	WiFi-5GHz	Blue	OFF : WiFi function was disabled Steady ON : WiFi (5GHz) is enabled Flash : Data packet transferred via WiFi2 LAN interface.
	5G NR	Blue	OFF : No Current Service is not 5G Steady ON : 5G is attached Flash (per Second) : Data transfer is going
	4G LTE	Blue	OFF : No Current Service is not 3G/4G (Just query PCC) Steady On : 3G/4G is attached Flash (per Second) : Data transfer is going
	SIM A/B	Blue	OFF: No SIM inserted or No SIM card is in use Steady ON : SIM A slot is in use Flash (per Second) : SIM B slot is in use
	Signal	Blue	Steady On : Signal Strength is 61~100% Slow Flash (on/off per 2 Seconds) : Signal Strength is 31~60% Flash(on/off per seconds) : Signal Strength is 0~30% OFF: Not attach any signal
	LAN 1 ~ LAN 3/WAN	Green	OFF : Ethernet Not connect to the host yet. Steady ON: Ethernet connection of LAN or WAN is established. Flash: Data packet transferred via Ethernet.

5G NR M2M Gateway

1.5 Installation & Maintenance Notice

1.5.1 SYSTEM REQUIREMENTS

Network Requirements	<ul style="list-style-type: none">• A gigabit Ethernet RJ45 cable• 5G cellular service subscription• IEEE 802.11 b/g/n/a/ac wireless clients• 10/100/1000 Ethernet adapter on PC
Web-based Configuration Utility Requirements	<p>Computer with the following:</p> <ul style="list-style-type: none">• Windows®, Macintosh, or Linux-based operating system• An installed Ethernet adapter <p>Browser Requirements:</p> <ul style="list-style-type: none">• Internet Explorer 6.0 or higher• Chrome 2.0 or higher• Firefox 3.0 or higher• Safari 3.0 or higher

1.5.2 WARNING



TERRA

- Only use the power supply that complies with the power specification of the gateway. Using an out-of-spec voltage rating power source is dangerous and may damage the product.
- Do not open or repair the case yourself. If the product is too hot, turn off the power immediately and have it repaired at a qualified service center.

5G NR M2M Gateway

Federal Communication Commission Interference Statement

This device complies with Part 15 of the FCC Rules. Operation is subject to the following two conditions: (1) This device may not cause harmful interference, and (2) this device must accept any interference received, including interference that may cause undesired operation.

This equipment has been tested and found to comply with the limits for a Class B digital device, pursuant to Part 15 of the FCC Rules. These limits are designed to provide reasonable protection against harmful interference in a residential installation. This equipment generates, uses and can radiate radio frequency energy and, if not installed and used in accordance with the instructions, may cause harmful interference to radio communications. However, there is no guarantee that interference will not occur in a particular installation. If this equipment does cause harmful interference to radio or television reception, which can be determined by turning the equipment off and on, the user is encouraged to try to correct the interference by one of the following measures:

- Reorient or relocate the receiving antenna.
- Increase the separation between the equipment and receiver.
- Connect the equipment into an outlet on a circuit different from that to which the receiver is connected.
- Consult the dealer or an experienced radio/TV technician for help.

FCC Caution: Any changes or modifications not expressly approved by the party responsible for compliance could void the user's authority to operate this equipment.

This transmitter must not be co-located or operating in conjunction with any other antenna or transmitter.

FOR PORTABLE DEVICE USAGE (<20m from body/SAR needed)

Radiation Exposure Statement:

The product comply with the FCC portable RF exposure limit set forth for an uncontrolled environment and are safe for intended operation as described in this manual. The further RF exposure reduction can be achieved if the product can be kept as far as possible from the user body or set the device to lower output power if such function is available.

FOR MOBILE DEVICE USAGE (>20cm/low power)

Radiation Exposure Statement:

This equipment complies with FCC radiation exposure limits set forth for an uncontrolled environment. This equipment should be installed and operated with minimum distance 20cm between the radiator & your body.

FOR COUNTRY CODE SELECTION USAGE (WLAN DEVICES)

Note: The country code selection is for non-US model only and is not available to all US model. Per FCC regulation, all WiFi product marketed in US must fixed to US operation channels only.

5G NR M2M Gateway

1.5.3 HOT SURFACE CAUTION



CAUTION: The surface temperature for the metallic enclosure can be very high! Especially after operating for a long time, installed at a closed cabinet without air conditioning support, or in a high ambient temperature space.

DO NOT touch the hot surface with your fingers while servicing!!

5G NR M2M Gateway

1.6 Hardware Installation

Hereunder list the available H/W ports of DWM-3010:

- **SIM Slot:** 2* Micro-SIM (3FF) slot
- **Ethernet:** 3* 10/100/1000Mbps RJ45 LAN ports, including one LAN/WAN configurable port
- **Analog Input:** 2* AI ports (supports 0~10V)
- **Digital Input:** 2* DI ports (isolated, "Logic 0": 0~2V, "Logic 1": 5~30V)
- **Digital Output:** 2* DO ports (isolated, Non-Relayed Output, Maximum 24V/300mA for each port)
- **Field Bus:** 1* RS-232/485 for legacy serial device, or Modbus RTU/ASCII devices
- **USB Port:** 1* USB 2.0 Type A port
- **Storage:** 1* MicroSD slot for SD 3.0 (SDXC) compliant storage expansion
- **Power Source :** 1* 2-pin Terminal Block for 9~36V DC power

This section describes how to install and configure the hardware.

1.6.1 Insert the SIM Card, MicroSD Card

WARNING: BEFORE INSERTING OR CHANGING THE SIM CARD AND/OR MicroSD CARD, PLEASE MAKE SURE THAT POWER OF THE DEVICE IS SWITCHED OFF.

The SIM card slots are located at the left side of the device housing. You need to unscrew and remove the outer SIM card cover before installing or removing the SIM card and/or MicroSD card. Please follow the instructions to insert a SIM card. After SIM card is well placed, push the SIM card loader into its slot.

Step 1:
Loosen the screws as below and remove the SIM cover.

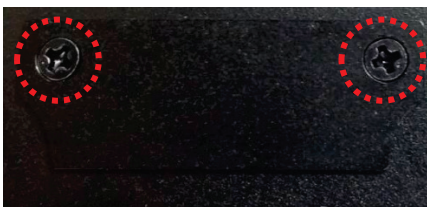

Step 2:
Push the SIM card into the slot A (SIM-A) or slot B (SIM-B).

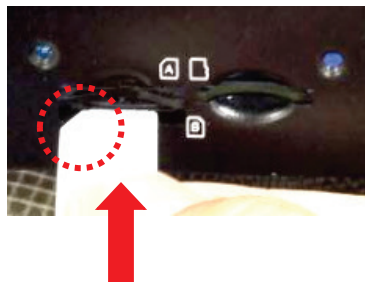

Step 3:
Push the inserted SIM card again to eject it from the SIM slot.



5G NR M2M Gateway

1.6.2 Mount the Unit

The DWM-3010 series product can be mounted on a wall, horizontal plane, or DIN Rail in a cabinet with the mounting accessories (DIN-rail kit or optional brackets). The mounting accessories are not screwed on the product when out of factory. Please screw the DIN-rail bracket or wall-mount kits on the product first.

1.6.3 Install the External RF Cable and Antenna

As illustrated in Section 1.3, there are several SMA antenna Jacks for you to install the required RF cables and antennas for the RF signal transmission and receiving. You have to purchase required RF cables and antennas separately for a specific project or installation site to get excellent RF performance.

Since there is limited spacing for allocating all SMA antenna Jacks around the enclosure, the separation among SMA Jacks (or direct-attached antennas) could be not the optimized arrangement. **It is not recommended to attach the SMA antennas directly to the SMA Jacks.** It is very likely to get degraded RF performance at specific circumstances. It depends heavily on the environment.

However, there are well-known rules of thumb for solving the antenna separation issue.

- 1: The horizontal distance between antennas should be greater than 1/4 of its wavelength, and there will be best separation at 1/2 of its wavelength.***
- 2. If multiple frequency antennas are near each other, then use spacing distance of the lower frequency antenna, or even better try to satisfy the rule for both frequencies.***

Wavelength Table for Major RF Category

RF Category	Frequency	Wavelength	1/2 Wave Length (Best Separation)	1/4 Wave Length (Good Separation)
WiFi 802.11	5.8GHz	5.2cm	2.6cm	1.3cm
WiFi 802.11	2.4GHz	12.5cm	6.2cm	3.1cm
Cellular LTE	2600MHz	11.5cm	5.8cm	2.9cm
Cellular LTE	2100MHz	14.3cm	7.1cm	3.7cm
Cellular LTE	900MHz	33.3cm	16.6cm	8.3cm
Cellular LTE	700MHz	42.8cm	21.4cm	10.7cm

For example, if you have a 900MHz LTE antenna and a WiFi 2.4GHz antenna, you would want them to be separated by at least 8.3cm to get good antenna separation.

So, it is recommended to use some external RF cables to extend and separate the adjacent antennas and get better antenna separation and RF performance, if required.

5G NR M2M Gateway

1.6.4 Connecting I/O Devices

There are multiple AI/DI/DO ports together with a 10-pin terminal block. Please refer to following pin assignment and specification to connect Input and Output devices

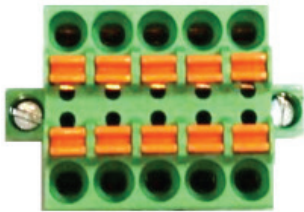

AGND	AGND	DO1	DO_COM	DO2
1	2	3	4	5
6	7	8	9	10
AI1	AI2	DI1	DI_COM	DI2

Mode	Specification	
Analog Input	0-10V analog Voltage	with 12-bit ADC, sample rate upto 125kHz; +/- 2.5mV precision
Digital Input (Isolated)	Trigger Voltage (high)	Logic level 1: 5V~30V
	Normal Voltage (low)	Logic level 0: 0V~2V
Digital Output (Isolated)	Voltage (Non-Relayed Mode)	Depends on external device maximum voltage is 24V/300mA

If the AI signal range of your device will run out off the design spec. of DWM-3010 (0-10V), you have to add a certain scaling circuit to prevent overflow readings and even damage the DWM-3010.

Example of AI Connection Diagram

(1) AI Connection (for 0~10V signal)

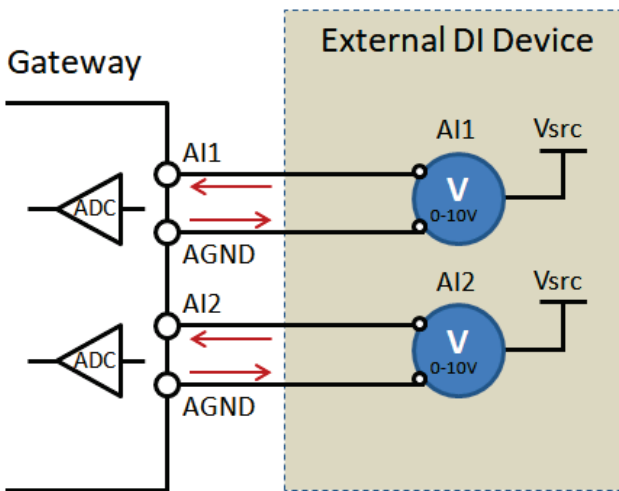

(2) AI Connection (for > 10V signal)

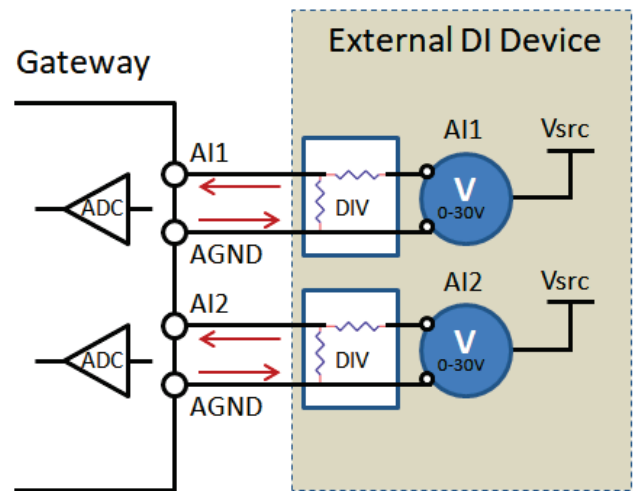

5G NR M2M Gateway

Example of DI Connection Diagram

(1) Sink-type DI Connection

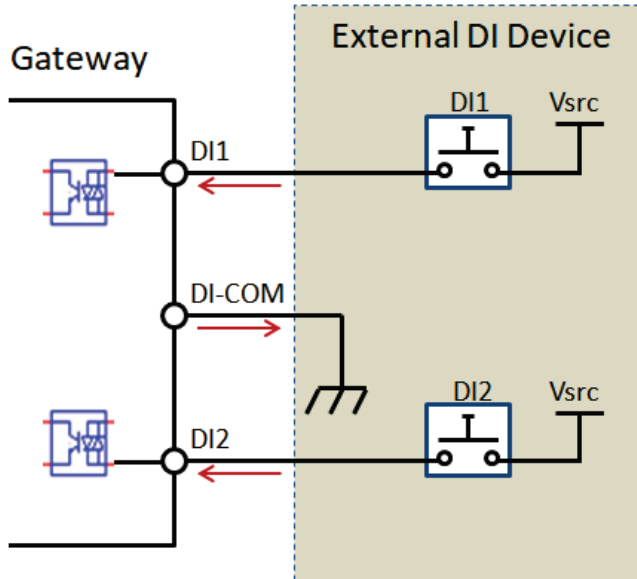

(2) Source-type DI Connection

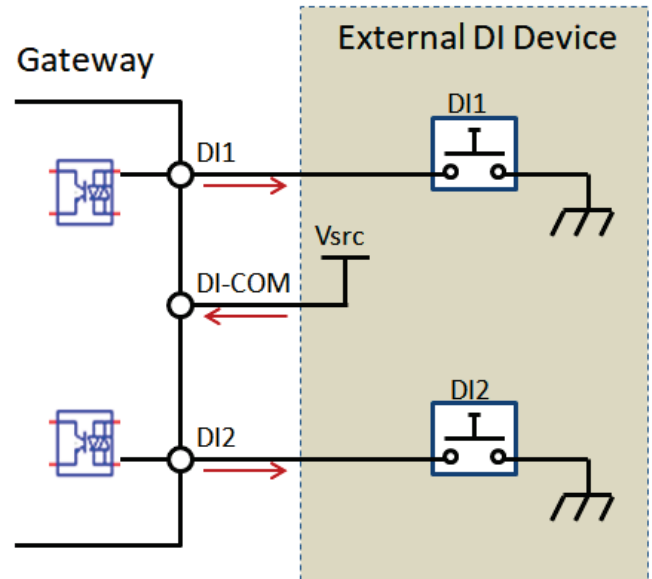

Example of DO Connection Diagram

(1) Sink-type DO Connection

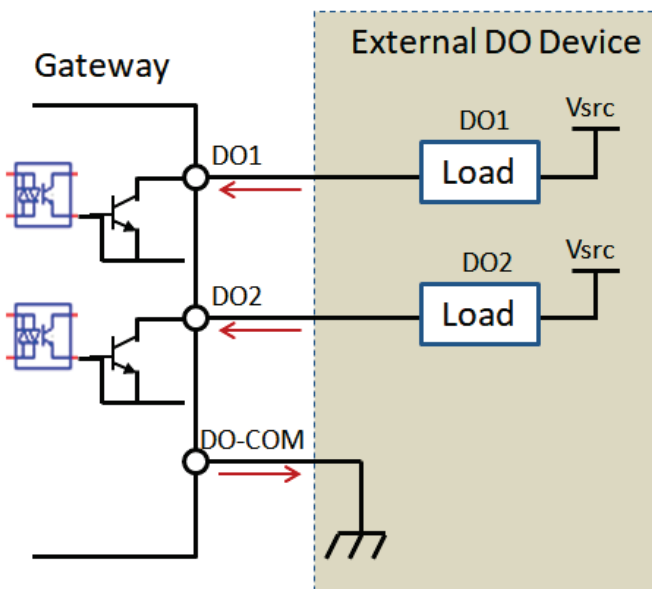

(2) Source-type DO Connection

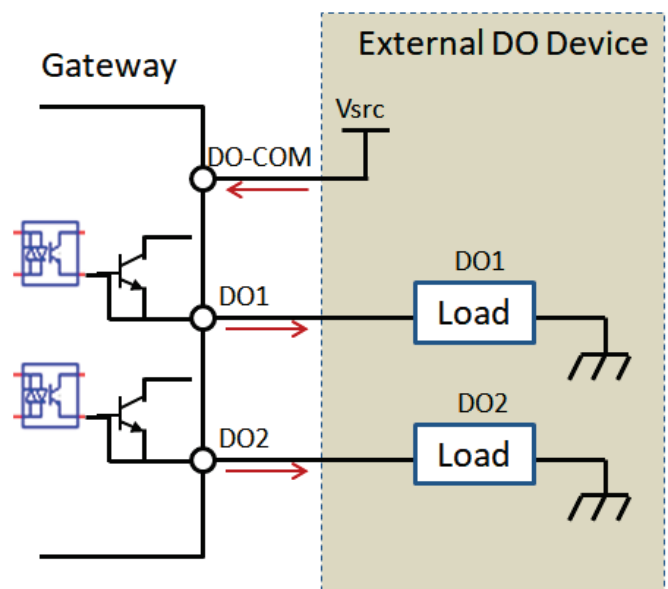

5G NR M2M Gateway

1.6.5 Connecting Serial Devices

The DWM-3010 series products provide 4-pin Terminal Block serial port for connecting to your serial device. Connect the serial device to the terminal block with the right pin assignments of RS-232/485 are shown as below.



	1	2	3	4
RS-232	GND	RxD	TxD	GND
RS-485	GND	D- (A)	D+ (B)	GND

1.6.6 Connecting Power

The DWM-3010 series product can be powered by connecting DC power source to the 2-pin power terminal block. It supports 9 to 36V DC power input. Following picture indicates the power terminal block pin assignments. Please check carefully and connect to the right power requirements and polarity.



PWR
GND

5G NR M2M Gateway

1.6.7 Connecting to the Network or a Host

The DWM-3010 series provides RJ45 ports to connect 10/100/1000Mbps Ethernet. It can auto detect the transmission speed on the network and configure itself automatically. Connect one Ethernet cable to the RJ45 port (LAN) of the device and plug another end of the Ethernet cable into your computer's network port. In this way, you can use the RJ45 Ethernet cable to connect to the host PC's Ethernet port for configuring the device.

1.6.8 Setup by Configuring WEB UI

You can browse web UI to configure the device.

Type in the IP Address (<http://192.168.0.1>)²

When you see the login page, enter the user name and password and then click '**Login**' button. The default setting for both username and password is '**admin**'.

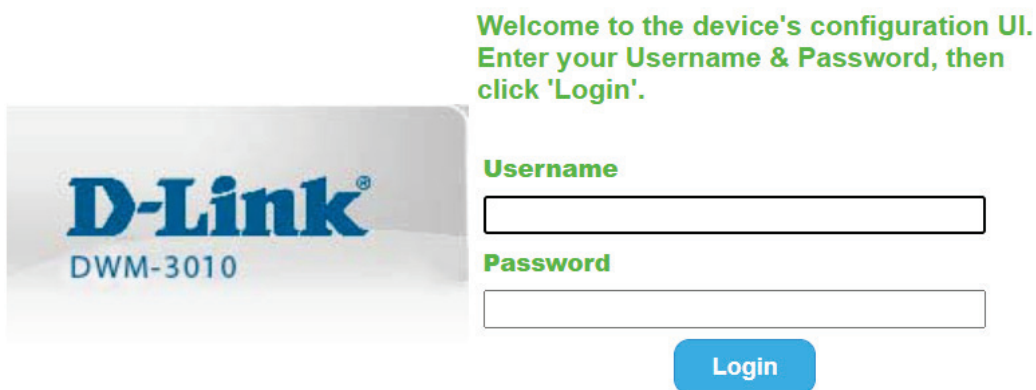

For the security consideration, you will be asked to change the logging password while the first time login to the device.

² The default LAN IP address of this gateway is 192.168.0.1. If you change it, you need to login by using the new IP address.

5G NR M2M Gateway

Change Password

For security consideration, you are being asked to change the password while the first time login to the device.

Enter the new password below.

(NOTE: The password must be at least 10 characters long, and must contain at least 1 English letter and 1 number. The password cannot be the same as the login account.)

New Password:

New Password Confirmation:

OK

After that, you will be asked to login again with the new password.

Note 1: Keep the login password properly for further device configuration.

Note 2: If, someday, you lose or forget the login password, the ONLY way to remedy is to recover the device to its factory default settings via long-pressing the Reset button.

Note 3: Under such situation, your device configuration will be erased accordingly. So, In addition to keep the login password, you may have to backup the device donfiguration and keep it properly for any unexpected accident.

5G NR M2M Gateway

Chapter 2 Basic Network

2.1 WAN & Uplink

Interface Name	Physical Interface	Operation Mode	Action
WAN-1	Cellular	Always on	<input type="button" value="Edit"/>
WAN-2	-	Disable	<input type="button" value="Edit"/>
WAN-3	-	Disable	<input type="button" value="Edit"/>

The gateway provides multiple WAN interfaces to let all client hosts in Intranet of the gateway access the Internet via ISP. But ISPs in the world apply various connection protocols to let gateways or user's devices dial in ISPs and then link to the Internet via different kinds of transmit media.

So, the WAN Connection lets you specify the WAN Physical Interface, WAN Internet Setup and WAN Load Balance for Intranet to access Internet. For each WAN interface, you must specify its physical interface first and then its Internet setup to connect to ISP. Besides, since the gateway has multiple WAN interfaces, you can assign physical interface to participate in the Load Balance function.

5G NR M2M Gateway

2.1.1 Physical Interface

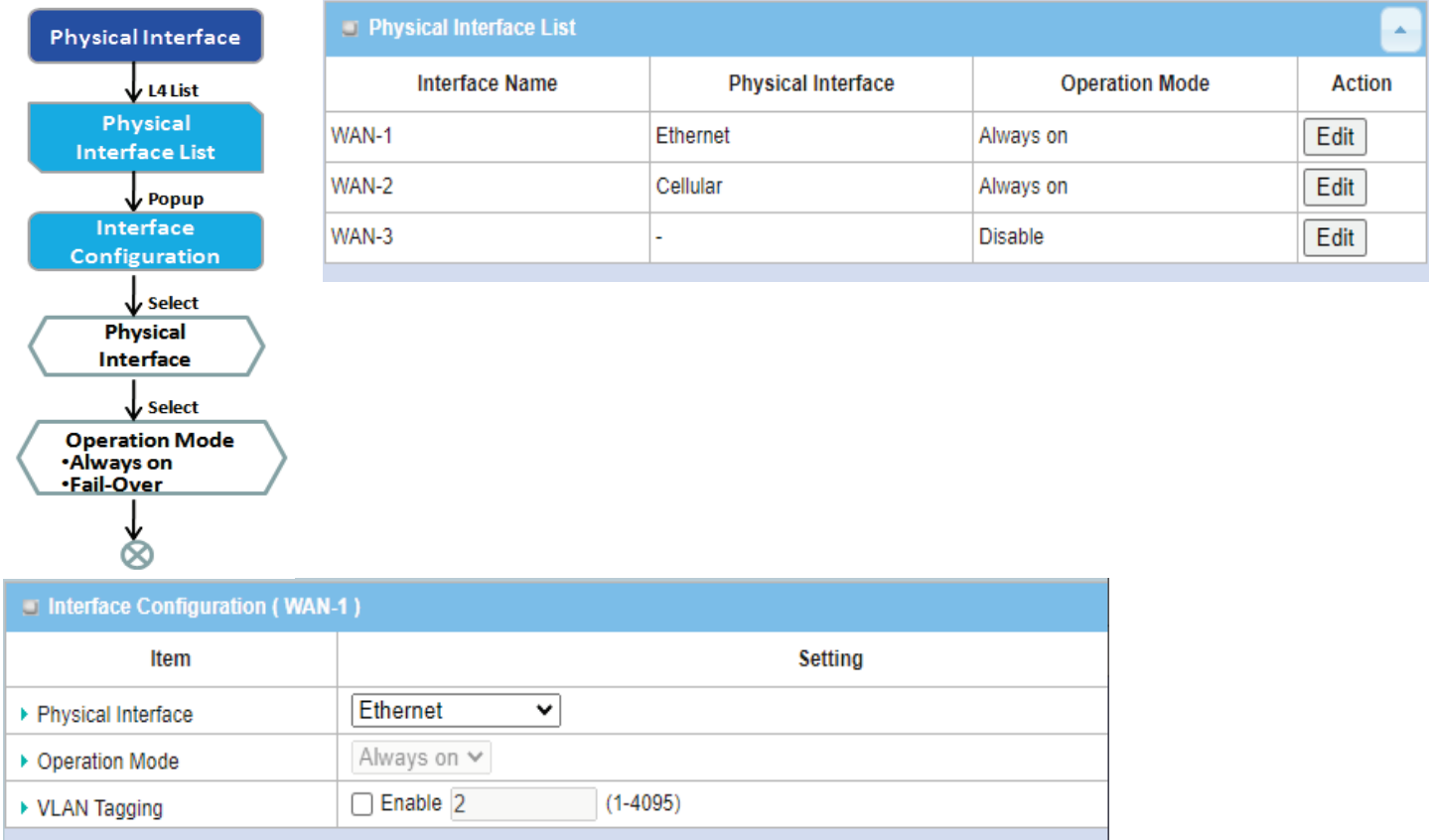

M2M gateways are usually equipped with various WAN interfaces to support different WAN connection scenario for requirement. You can configure the WAN interface one by one to get proper internet connection setup. **Refer to the product specification for the available WAN interfaces in the product you purchased.**

The first step to configure one WAN interface is to specify which kind of connection media to be used for the WAN connection, as shown in "Physical Interface" page.

In "Physical Interface" page, there are two configuration windows, "Physical Interface List" and "Interface Configuration". "Physical Interface List" window shows all the available physical interfaces. After clicking on the "Edit" button for the interface in "Physical Interface List" window the "Interface Configuration" window will appear to let you configure a WAN interface.

Physical Interface:

- **Ethernet WAN:** The gateway has one or more RJ45 WAN ports that can be configured to be WAN connections. You can directly connect to external DSL modem or setup behind a firewall device.
- **Cellular WAN:** The gateway has one built-in 5G NR modem as WAN connection. For each cellular WAN, there are 1 or 2 SIM cards to be inserted for special failover function.

5G NR M2M Gateway



- Please **MUST POWER OFF** the gateway before you insert or remove SIM card.
- The SIM card can be damaged if you insert or remove SIM card while the gateway is in

5G NR M2M Gateway

Operation Mode:

There are three option items "Always on", "Failover", and "Disable" for the operation mode setting.

Always on: Set this WAN interface to be active all the time. When two or more WAN are established at "Always on" mode, outgoing data will through these WAN connections base on load balance policies.

Failover:

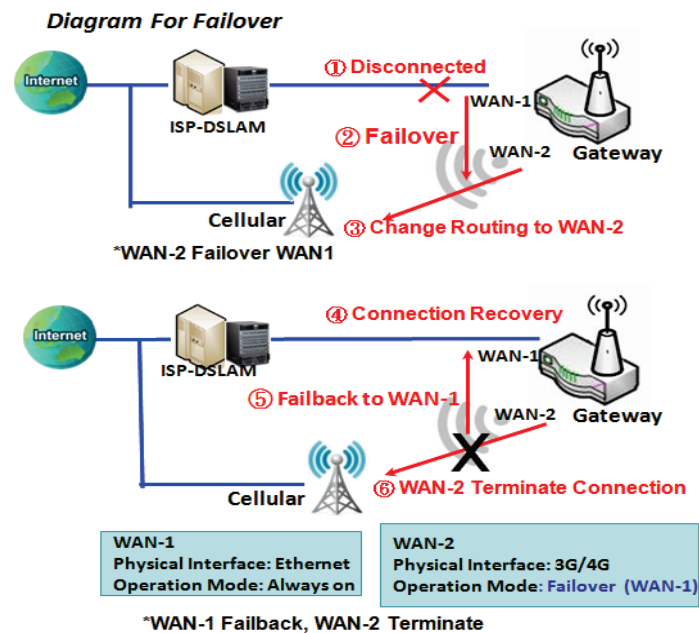

A failover interface is a backup connection to the primary. That means only when its primary WAN connection is broken, the backup connection will be started up to substitute the primary connection. As shown in the diagram, WAN-2 is backup WAN for WAN-1. WAN-1 serves as the primary connection with operation mode "Always on". WAN-2 won't be activated until WAN-1 disconnected. When WAN-1 connection is recovered back with a connection, it will take over data traffic again. At that time, WAN-2 connection will be terminated.

Seamless Failover:

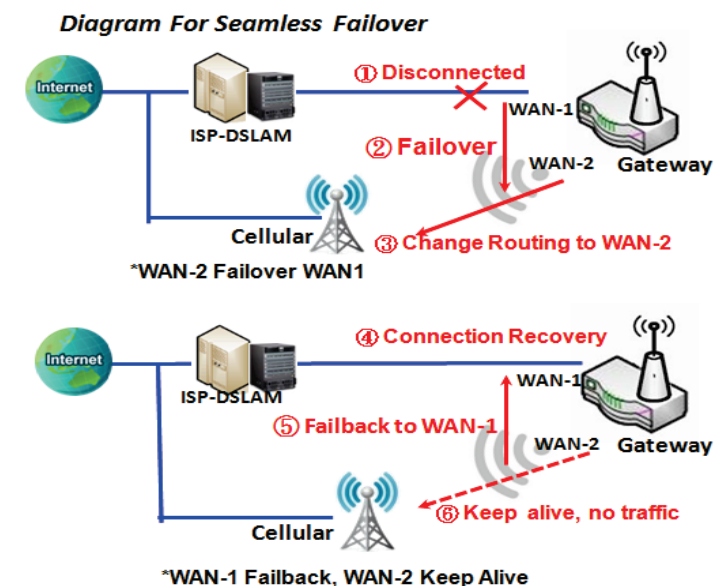

In addition, there is a "Seamless" option for Failover operation mode. When seamless option is activated by checking on the "Seamless" box in configuration window, both the primary connection and the failover connection are started up after system rebooting. But only the primary connection executes the data transfer, while the failover one just keeps alive of connection line. As soon as the primary connection is broken, the system will switch, meaning failover, the routing path to the failover connection to save the dial up time of failover connection since it has been alive.

When the "Seamless" enable checkbox is activated, it can allow the Failover interface to be connected continuously from system booting up. Failover WAN interface just keeps connecting without data traffic. The purpose is to shorten the switch time during

failover process. So, when primary connection is disconnected, failover interface will take over the data transfer mission instantly by only changing routing path to the failover interface. The dialing-up time of

5G NR M2M Gateway

failover connection is saved since it has been connected beforehand.

VLAN Tagging

Sometimes, your ISP required a VLAN tag to be inserted into the WAN packets from Gateway for specific services. Please enable VLAN tagging and specify tag in the WAN physical interface. Please be noted that only Ethernet and ADSL physical interfaces support the feature. For the device with 3G/4G WAN only, it is disabled.

5G NR M2M Gateway

Physical Interface Setting

Go to **Basic Network > WAN > Physical Interface** tab.

The Physical Interface allows user to setup the physical WAN interface and to adjust WAN's behavior.

Note: Numbers of available WAN Interfaces can be different for the purchased gateway.

Physical Interface List			
Interface Name	Physical Interface	Operation Mode	Action
WAN-1	Ethernet	Always on	<button>Edit</button>
WAN-2	Cellular	Always on	<button>Edit</button>
WAN-3	-	Disable	<button>Edit</button>

When **Edit** button is applied, an **Interface Configuration** screen will appear. WAN-1 interface is used in this example.

Interface Configuration:

Interface Configuration (WAN-1)	
Item	Setting
▶ Physical Interface	<input type="text" value="Ethernet"/>
▶ Operation Mode	<input type="text" value="Always on"/>
▶ VLAN Tagging	<input type="checkbox"/> Enable <input type="text" value="2"/> (1-4095)

Interface Configuration		
Item	Value setting	Description
Physical Interface	1. A Must fill setting 2. WAN-1 is the primary interface and is factory set to Always on.	Select one expected interface from the available interface dropdown list. It can be Cellular , or Etherent . Depending on the gateway model, Disable and Failover options will be available only to multiple WAN gateways. WAN-2 ~ WAN-n interfaces are only available to multiple WAN gateways
Operation Mode	A Must fill setting	Define the operation mode of the interface. Select Always on to make this WAN always active. Select Disable to disable this WAN interface. Select Failover to make this WAN a Failover WAN when the primary or the secondary WAN link failed. Then select the primary or the existed secondary WAN interface to switch Failover from.

5G NR M2M Gateway

		(Note: for WAN-1, only Always on option is available.)
VLAN Tagging	Optional setting	Check Enable box to enter tag value provided by your ISP. Otherwise uncheck the box. <i>Value Range: 1 ~ 4095.</i> Note: This feature is NOT available for Cellular WAN connection.

5G NR M2M Gateway

2.1.2 Connection Setup

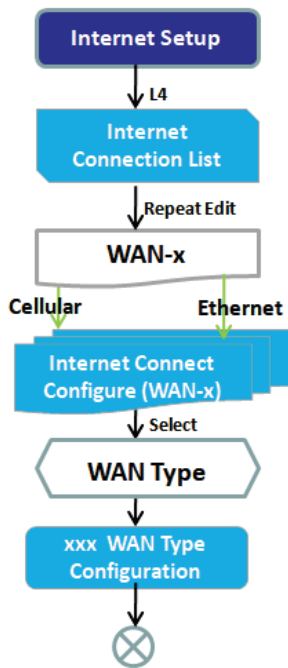

Internet Connection List				
Interface Name	Physical Interface	Operation Mode	WAN Type	Action
WAN-1	Ethernet	Always on	Dynamic IP	Edit
WAN-2	Cellular	Always on	Cellular	Edit
WAN-3	-	Disable	-	Edit

Internet Connection Configuration (WAN-1)	
Item	Setting
WAN Type	Dynamic IP ▼

Dynamic IP WAN Type Configuration	
Item	Setting
Host Name	<input type="text"/> (Optional)
ISP Registered MAC Address	<input type="text"/> Clone (Optional)
Connection Control	Auto-reconnect ▼
MTU Setup	<input type="checkbox"/> Enable
NAT	<input checked="" type="checkbox"/> Enable
IGMP	Disable ▼
WAN IP Alias	<input type="checkbox"/> Enable <input type="text" value="10.0.0.1"/>

After specifying the physical interface for each WAN connection, administrator must configure their connection profile to meet the dial in process of ISP, so that all client hosts in the Intranet of the gateway can access the Internet.

In "Connection Setup" page, there are some configuration windows: "Internet Connection List", "Internet Connection Configuration", "WAN Type Configuration" and related configuration windows for each WAN type. For the Internet setup of each WAN interface, you must specify its WAN type of physical interface first and then its related parameter configuration for that WAN type.

After clicking on the "Edit" button of a physical interface in "Internet Setup List" window, the "Internet Connection Configuration" window will appear to let you specify which kind of WAN type that you will use for that physical interface to make an Internet connection. Based on your chosen WAN type, you can configure necessary parameters in each corresponding configuration window.

5G NR M2M Gateway

Internet Connection List - Ethernet WAN

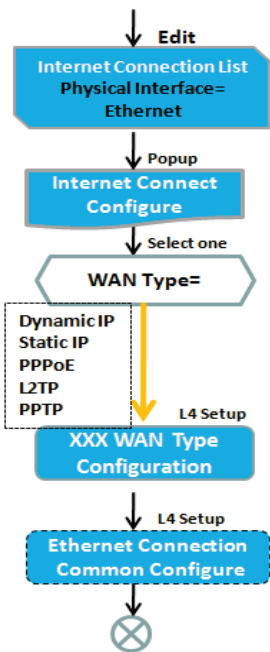

Internet Connection Configuration (WAN - 1)	
Item	Setting
▶ WAN Type	Dynamic IP ▼
Dynamic IP WAN Type Conf	
▶ Host Name	(Optional)
▶ ISP Registered MAC Address	Clone (Optional)
▶ Connection Control	Auto-reconnect ▼
▶ MTU Setup	<input type="checkbox"/> Enable
▶ NAT	<input checked="" type="checkbox"/> Enable
▶ IGMP	Disable ▼
▶ WAN IP Alias	<input type="checkbox"/> Enable 10.0.0.1
Network Monitoring Configuration	
▶ Network Monitoring Configuration	<input checked="" type="checkbox"/> Enable
▶ Checking Method	DNS Query ▼
▶ Loading Check	<input checked="" type="checkbox"/> Enable
▶ Query Interval	5 (seconds)
▶ Latency Threshold	3000 (ms)

WAN Type for Ethernet Interface:

Ethernet is the most common WAN and uplink interface for M2M gateways. Usually it is connected with xDSL or cable modem for you to setup the WAN connection. There are various WAN types to connect with ISP.

- **Static IP:** Select this option if ISP provides a fixed IP to you when you subscribe the service. Usually is more expensive but very important for cooperate requirement.
- **Dynamic IP:** The assigned IP address for the WAN by a DHCP server is different every time. It is cheaper and usually for consumer use.

5G NR M2M Gateway

- **PPP over Ethernet:** As known as PPPoE. This WAN type is widely used for ADSL connection. IP is usually different for every dial up.
- **PPTP:** This WAN type is popular in some countries, like Russia.
- **L2TP :** This WAN type is popular in some countries, like Israel.

Configure Ethernet WAN Setting

When **Edit** button is applied, **Internet Connection Configuration** screen will appear. WAN-1 interface is used in this example.

5G NR M2M Gateway

WAN Type = Dynamic IP

Internet Connection Configuration (WAN - 1)	
Item	Setting
▶ WAN Type	Dynamic IP ▼

When you select it, "Dynamic IP WAN Type Configuration" will appear. Items and setting is explained below

Dynamic IP WAN Type Configuration	
Item	Setting
▶ Host Name	<input type="text"/> (Optional)
▶ ISP Registered MAC Address	<input type="text"/> <input type="button" value="Clone"/> (Optional)

Dynamic IP WAN Type Configuration		
Item	Value setting	Description
Host Name	An optional setting	Enter the host name provided by your Service Provider.
ISP Registered MAC Address	An optional setting	Enter the MAC address that you have registered with your service provider. Or Click the Clone button to clone your PC's MAC to this field. Usually this is the PC's MAC address assigned to allow you to connect to Internet.

WAN Type= Static IP

Internet Connection Configuration (WAN - 1)	
Item	Setting
▶ WAN Type	Static IP ▼

When you select it, "Static IP WAN Type Configuration" will appear. Items and setting is explained below

Static IP WAN Type Configuration	
Item	Setting
▶ WAN IP Address	<input type="text"/>
▶ WAN Subnet Mask	255.255.255.0 (/24) ▼
▶ WAN Gateway	<input type="text"/>
▶ Primary DNS	<input type="text"/>
▶ Secondary DNS	<input type="text"/> (Optional)

Static IP WAN Type Configuration

5G NR M2M Gateway

Item	Value setting	Description
WAN IP Address	A Must filled setting	Enter the WAN IP address given by your Service Provider
WAN Subnet Mask	A Must filled setting	Enter the WAN subnet mask given by your Service Provider
WAN Gateway	A Must filled setting	Enter the WAN gateway IP address given by your Service Provider
Primary DNS	A Must filled setting	Enter the primary WAN DNS IP address given by your Service Provider
Secondary DNS	An optional setting	Enter the secondary WAN DNS IP address given by your Service Provider

WAN Type= PPPoE

▲
Internet Connection Configuration (WAN - 1)

Item	Setting
▶ WAN Type	PPPoE ▼

When you select it, "PPPoE WAN Type Configuration" will appear. Items and setting is explained below

▲
PPPoE WAN Type Configuration

Item	Setting
▶ IP Type	IPv4 ▼
▶ PPPoE Account	<input type="text"/>
▶ PPPoE Password	<input type="text"/>
▶ Primary DNS	<input type="text"/> (Optional)
▶ Secondary DNS	<input type="text"/> (Optional)
▶ Service Name	<input type="text"/> (Optional)
▶ Assigned IP Address	<input type="text"/> (Optional)

PPPoE WAN Type Configuration		
Item	Value setting	Description
PPPoE Account	A Must filled setting	Enter the PPPoE User Name provided by your Service Provider.
PPPoE Password	A Must filled setting	Enter the PPPoE password provided by your Service Provider.
Primary DNS	An optional setting	Enter the IP address of Primary DNS server.
Secondary DNS	An optional setting	Enter the IP address of Secondary DNS server.
Service Name	An optional setting	Enter the service name if your ISP requires it
Assigned IP Address	An optional setting	Enter the IP address assigned by your Service Provider.

5G NR M2M Gateway

WAN Type= PPTP

Internet Connection Configuration (WAN - 1)	
Item	Setting
▶ WAN Type	PPTP ▼

When you select it, "PPTP WAN Type Configuration" will appear. Items and setting is explained below

PPTP WAN Type Configuration	
Item	Setting
▶ IP Mode	Dynamic IP Address ▼
▶ Server IP Address / Name	<input type="text"/>
▶ PPTP Account	<input type="text"/>
▶ PPTP Password	<input type="text"/>
▶ Connection ID	<input type="text"/> (Optional)
▶ MPPE	<input type="checkbox"/> Enable

PPTP WAN Type Configuration		
Item	Value setting	Description
IP Mode	A Must filled setting	<p>Select either Static or Dynamic IP address for PPTP Internet connection.</p> <ul style="list-style-type: none"> When Static IP Address is selected, you will need to enter the WAN IP Address, WAN Subnet Mask, and WAN Gateway. <ul style="list-style-type: none"> WAN IP Address (A Must filled setting): Enter the WAN IP address given by your Service Provider. WAN Subnet Mask (A Must filled setting): Enter the WAN subnet mask given by your Service Provider. WAN Gateway (A Must filled setting): Enter the WAN gateway IP address given by your Service Provider. When Dynamic IP is selected, there are no above settings required.
Server IP Address/Name	A Must filled setting	Enter the PPTP server name or IP Address.
PPTP Account	A Must filled setting	Enter the PPTP username provided by your Service Provider.
PPTP Password	A Must filled setting	Enter the PPTP connection password provided by your Service Provider.
Connection ID	An optional setting	Enter a name to identify the PPTP connection.
MPPE	An optional setting	Select Enable to enable MPPE (Microsoft Point-to-Point Encryption) security for PPTP connection.

5G NR M2M Gateway

WAN Type= L2TP

Internet Connection Configuration (WAN - 1)	
Item	Setting
▶ WAN Type	L2TP ▼

When you select it, "L2TP WAN Type Configuration" will appear. Items and setting is explained below

L2TP WAN Type Configuration	
Item	Setting
▶ IP Mode	Dynamic IP Address ▼
▶ Server IP Address / Name	<input type="text"/>
▶ L2TP Account	<input type="text"/>
▶ L2TP Password	<input type="text"/>
▶ Service Port	User-defined ▼ <input type="text" value="1702"/>
▶ MPPE	<input type="checkbox"/> Enable

L2TP WAN Type Configuration		
Item	Value setting	Description
IP Mode	A Must filled setting	<p>Select either Static or Dynamic IP address for L2TP Internet connection.</p> <ul style="list-style-type: none"> ● When Static IP Address is selected, you will need to enter the WAN IP Address, WAN Subnet Mask, and WAN Gateway. <ul style="list-style-type: none"> ■ WAN IP Address (A Must filled setting): Enter the WAN IP address given by your Service Provider. ■ WAN Subnet Mask (A Must filled setting): Enter the WAN subnet mask given by your Service Provider. ■ WAN Gateway (A Must filled setting): Enter the WAN gateway IP address given by your Service Provider. ● When Dynamic IP is selected, there are no above settings required.
Server IP Address/Name	A Must filled setting	Enter the L2TP server name or IP Address.
L2TP Account	A Must filled setting	Enter the L2TP username provided by your Service Provider.
L2TP Password	A Must filled setting	Enter the L2TP connection password provided by your Service Provider.
Service Port	A Must filled setting	<p>Enter the service port that the Internet service.</p> <p>There are three options can be selected :</p> <ul style="list-style-type: none"> ● Auto: Port will be automatically assigned. ● 1701 (For Cisco): Set service port to port 1701 to connect to CISCO server. ● User-defined: enter a service port provided by your Service Provider.
MPPE	An optional setting	Select Enable to enable MPPE (Microsoft Point-to-Point Encryption) security for PPTP connection.

5G NR M2M Gateway

Ethernet Connection Common Configuration

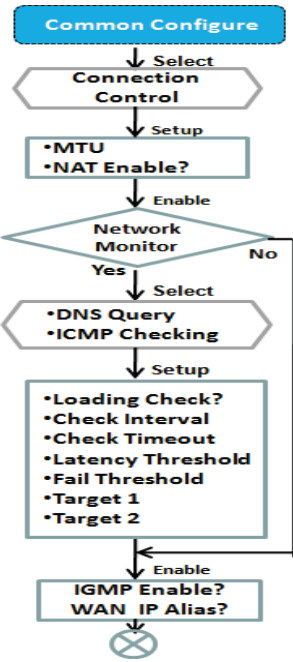

▶ Connection Control	Auto-reconnect ▼
▶ MTU Setup	<input type="checkbox"/> Enable
▶ NAT	<input checked="" type="checkbox"/> Enable
▶ IGMP	Disable ▼
▶ WAN IP Alias	<input type="checkbox"/> Enable 10.0.0.1
Network Monitoring Configuration	
▶ Network Monitoring Configuration	<input checked="" type="checkbox"/> Enable
▶ Checking Method	DNS Query ▼
▶ Loading Check	<input checked="" type="checkbox"/> Enable
▶ Query Interval	5 (seconds)
▶ Latency Threshold	3000 (ms)
▶ Fail Threshold	5 (Times)
▶ Target1	DNS1 ▼
▶ Target2	None ▼

There are some important parameters to be setup no matter which Ethernet WAN type is selected. You should follow up the rule to configure.

Connection Control.

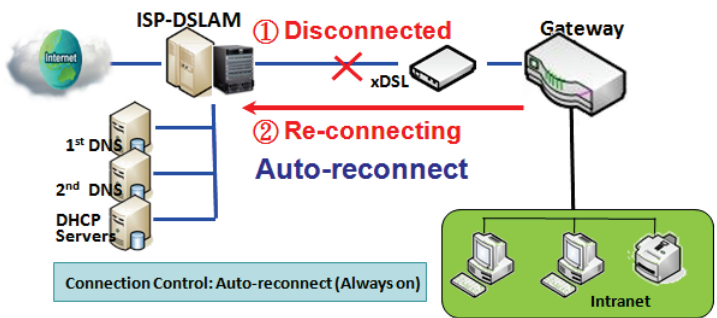

Auto-reconnect: This gateway will establish Internet connection automatically once it has been booted up, and try to reconnect once the connection is down. It's recommended to choose this scheme if for mission critical applications to ensure full-time Internet connection.

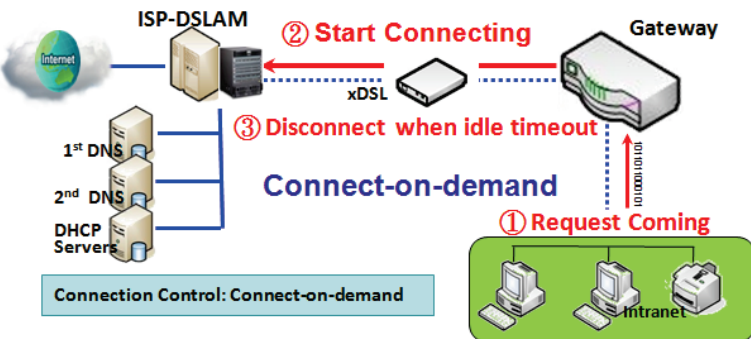

Connect-on-demand: This gateway won't start to establish Internet connection until local data is going to be sent to WAN side. After normal data transferring between LAN and WAN sides, this gateway will disconnect WAN connection if idle time reaches value of Maximum Idle Time.

5G NR M2M Gateway

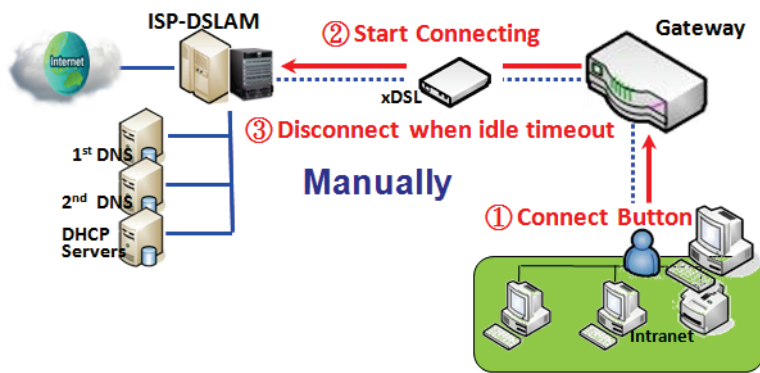

Manually: This gateway won't start to establish WAN connection until you press "Connect" button on web UI. After normal data transferring between LAN and WAN sides, this gateway will disconnect WAN connection if idle time reaches value of Maximum Idle Time.

Please be noted, if the WAN interface serves as the primary one for another WAN interface in Failover role, the Connection Control parameter will not be available to you to configure as the system must set it to "Auto-reconnect (Always on)".

Network Monitoring

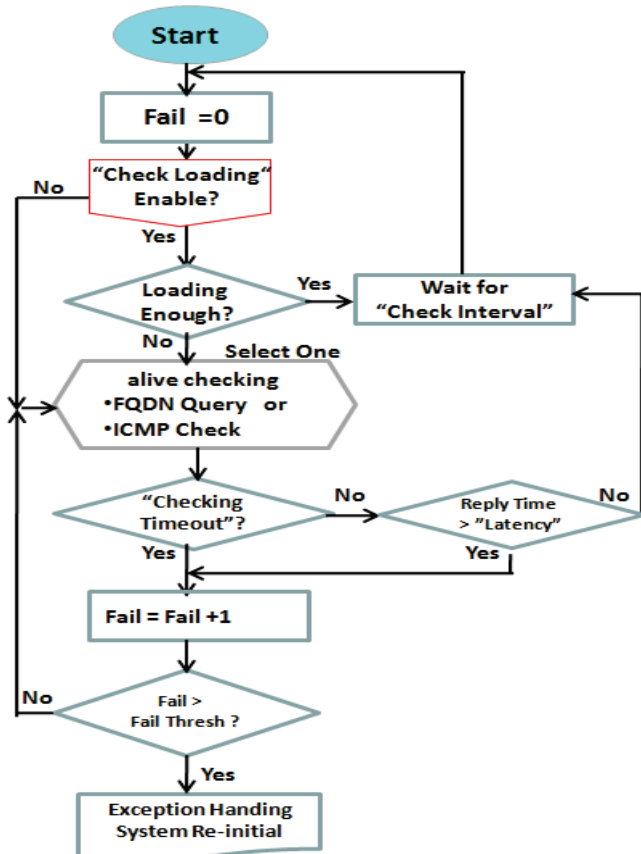

It is necessary to monitor connection status continuous. To do it, "ICMP Check" and "FQDN Query" are used to check. When there is traffic of connection, checking packet will waste bandwidth. Response time of replied packets may also increase. To avoid "Network Monitoring" work abnormally, enabling "Checking Loading" option will stop connection check when there is traffic. It will wait for another "Check Interval" and then check loading again. When you do "Network Monitoring", if reply time longer than "Latency" or even no response longer than "Checking Timeout", "Fail" count will be increased. If it is continuous and "Fail" count is more than "Fail Threshold", gateway will do exception handling process and re-initial this connection again. Otherwise, network monitoring process will be start again.

5G NR M2M Gateway

Set up “Ethernet Common Configuration”

Ethernet WAN Common Configuration		
Item	Value setting	Description
Connection Control	A Must filled setting	<p>There are three connection modes.</p> <ul style="list-style-type: none"> • Auto-reconnect enables the router to always keep the Internet connection on. • Connect-on-demand enables the router to automatically re-establish Internet connection as soon as user attempts to access the Internet. Internet connection will be disconnected when it has been inactive for a specified idle time. • Connect Manually allows user to connect to Internet manually. Internet connection will be inactive after it has been inactive for specified idle time.
Maximum Idle Time	<ol style="list-style-type: none"> 1. An Optional setting 2. By default 600 seconds is filled-in 	<p>Specify the maximum Idle time setting to disconnect the internet connection when the connection idle timed out.</p> <p>Value Range: 300 ~ 86400.</p> <p>Note: This field is available only when Connect-on-demand or Connect Manually is selected as the connection control scheme.</p>
MTU Setup	<ol style="list-style-type: none"> 1. An Optional setting 2. Uncheck by default 	<p>Check the Enable box to enable the MTU (Maximum Transmission Unit) limit, and specify the MTU for the 3G/4G connection.</p> <p>MTU refers to Maximum Transmission Unit. It specifies the largest packet size permitted for Internet transmission.</p> <p>Value Range: 1200 ~ 1500.</p>
MTU Setup	<ol style="list-style-type: none"> 1. A Must filled setting 2. Auto (value zero) is set by default 3. Manual set range 1200~1500 	<p>MTU refers to Maximum Transmission Unit. It specifies the largest packet size permitted for Internet transmission.</p> <p>When set to Auto (value '0'), the router selects the best MTU for best Internet connection performance.</p>
NAT	<ol style="list-style-type: none"> 1. An optional setting 2. NAT is enabled by default 	<p>Enable NAT to apply NAT on the WAN connection. Uncheck the box to disable NAT function.</p>
IGMP	<ol style="list-style-type: none"> 1. A Must filled setting 2. Disable is set by default 	<p>Enable IGMP (Internet Group Management Protocol) would enable the router to listen to IGMP packets to discover which interfaces are connected to which device. The router uses the interface information generated by IGMP to reduce bandwidth consumption in a multi-access network environment to avoid flooding the entire network.</p>
WAN IP Alias	<ol style="list-style-type: none"> 1. An optional setting 2. Uncheck by default 	<p>Enable WAN IP Alias then enter the IP address provided by your service provider.</p> <p>WAN IP Alias is used by the device router and is treated as a second set of WAN IP to provide dual WAN IP address to your LAN network.</p>

5G NR M2M Gateway

Network Monitoring Configuration	
Item	Setting
▶ Network Monitoring Configuration	<input checked="" type="checkbox"/> Enable
▶ Checking Method	DNS Query ▼
▶ Loading Check	<input checked="" type="checkbox"/> Enable
▶ Query Interval	5 (seconds)
▶ Latency Threshold	3000 (ms)
▶ Fail Threshold	5 (Times)
▶ Target1	DNS1 ▼
▶ Target2	None ▼

Network Monitoring Configuration		
Item	Value setting	Description
Network Monitoring Configuration	1. An optional setting 2. Box is checked by default	Check the Enable box to activate the network monitoring function.
Checking Method	1. An Optional setting 2. DNS Query is set by default	Choose either DNS Query or ICMP Checking to detect WAN link. With DNS Query , the system checks the connection by sending DNS Query packets to the destination specified in Target 1 and Target 2. With ICMP Checking , the system will check connection by sending ICMP request packets to the destination specified in Target 1 and Target 2.
Loading Check	1. An optional setting 2. Box is checked by default	Check the Enable box to activate the loading check function. Enable Loading Check allows the gateway to ignore unreturned DNS queries or ICMP requests when WAN bandwidth is fully occupied. This is to prevent false link-down status.
Query Interval	1. An Optional setting 2. 5 seconds is selected by default.	Specify a time interval as the DNS Query Interval . Query Interval defines the transmitting interval between two DNS Query or ICMP checking packets. With DNS Query , the system checks the connection by sending DNS Query packets to the destination specified in Target 1 and Target 2. Value Range: 2 ~ 14400.
Check Interval	1. An Optional setting 2. 5 seconds is selected by default.	Specify a time interval as the ICMP Checking Interval . Query Interval defines the transmitting interval between two DNS Query or ICMP checking packets. With ICMP Checking , the system will check connection by sending ICMP request packets to the destination specified in Target 1 and Target 2. Value Range: 2 ~ 14400.
Latency Threshold	1. An Optional setting 2. 3000 ms is set by default	Enter a number of detecting disconnection times to be the threshold before disconnection is acknowledged. Latency Threshold defines the tolerance threshold of responding time. Value Range: 2000 ~ 3000 seconds.
Fail Threshold	1. An Optional setting 2. 5 times is set by default	Enter a number of detecting disconnection times to be the threshold before disconnection is acknowledged. Fail Threshold specifies the detected disconnection before the router recognize the WAN link down status. Value Range: 1 ~ 10 times.

5G NR M2M Gateway

Target 1	<ol style="list-style-type: none">1. An Optional filled setting2. DNS1 is selected by default	<p>Target1 specifies the first target of sending DNS query/ICMP request. DNS1: set the primary DNS to be the target. DNS2: set the secondary DNS to be the target. Gateway: set the Current gateway to be the target. Other Host: enter an IP address to be the target.</p>
Target 2	<ol style="list-style-type: none">1. An Optional filled setting2. None is selected by default	<p>Target1 specifies the second target of sending DNS query/ICMP request. None: no second target is required. DNS1: set the primary DNS to be the target. DNS2: set the secondary DNS to be the target. Gateway: set the Current gateway to be the target. Other Host: enter an IP address to be the target.</p>
Save	N/A	Click Save to save the settings.
Undo	N/A	Click Undo to cancel the settings.

5G NR M2M Gateway

Internet Connection – Cellular WAN

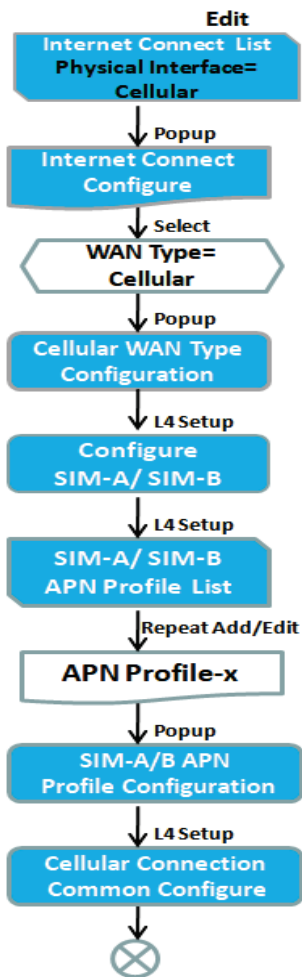

Internet Connection Configuration (WAN-2)	
Item	Setting
▶ WAN Type	Cellular ▼
Cellular WAN Type Configuration	
▶ Preferred SIM Card	SIM-A First ▼ Failback : <input type="checkbox"/> Enable
▶ Auto Flight Mode	<input type="checkbox"/> Enable
▶ SIM Switch Policy	Policy Setting
Connection with SIM-A Card	
Connection with SIM-B Card	
Cellular Connection Common Configuration	
Item	Setting
▶ Connection Control	Auto-reconnect ▼
▶ Time Schedule	(0) Always ▼
▶ MTU Setup	<input type="checkbox"/> Enable
▶ IP Passthrough (Cellular Bridge)	<input type="checkbox"/> Enable Fixed MAC : <input type="text"/>
▶ NAT	<input checked="" type="checkbox"/> Enable
▶ IGMP	Disable ▼
▶ WAN IP Alias	<input type="checkbox"/> Enable <input type="text" value="10.0.0.1"/>

Preferred SIM Card – Dual SIM Fail Over

For Cellular embedded device, one embedded cellular module can create only one WAN interface. This device has featured by using dual SIM cards for one module with special fail-over mechanism. It is called Dual SIM Failover. This feature is useful for ISP switch over when location is changed. Within “Dual SIM Failover”, there are various usage scenarios, including "SIM-A First", "SIM-B First“ with “Failback” enabled or not, and “SIM-A Only and “SIM-B Only”.

5G NR M2M Gateway

SIM-A/SIM-B only: When “SIM-A Only” or “SIM-B Only” is used, the specified SIM slot card is the only one to be used for negotiation parameters between gateway device and cellular ISP.

SIM-A / SIM-B first without enable Failback

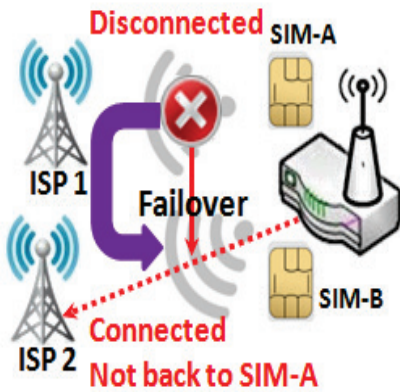

By default, “SIM-A First” scenario is used to connect to cellular ISP for data transfer. In the case of “SIM-A First” or “SIM-B First” scenario, the gateway will try to connect to the Internet by using SIM-A or SIM-B card first. And when the connection is broken, the gateway will switch to use the other SIM card for an alternate automatically and **will not switch back** to use original SIM card except current SIM connection is also broken. That is, SIM-A and SIM-B are used iteratively, but either one will keep being used for data transfer when current connection is still alive.

SIM-A / SIM-B first with Failback enable

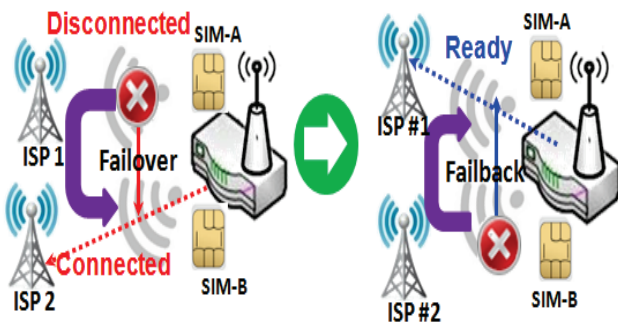

With Failback option enabled, “SIM-A First” scenario is used to connect when the connection is broken, gateway system will switch to use SIM-B. And when SIM-A connection is recovered, it will switch back to use original SIM-A card

5G NR M2M Gateway

Configure Cellular WAN Setting

When **Edit** button is applied, **Internet Connection Configuration**, and **Cellular WAN Configuration** screens will appear.

Internet Connection Configuration (WAN-2)	
Item	Setting
▶ WAN Type	Cellular ▼

Cellular WAN Type Configuration	
Item	Setting
▶ Preferred SIM Card	SIM-A First ▼ Failback : <input type="checkbox"/> Enable
▶ Auto Flight Mode	<input type="checkbox"/> Enable
▶ SIM Switch Policy	Policy Setting

Cellular Connection Configuration		
Item	Value setting	Description
WAN Type	1. A Must filled setting 2. Cellular is set by default.	From the dropdown box, select Internet connection method for Cellular WAN Connection. Only Cellular is available.
Preferred SIM Card	1. A Must filled setting 2. By default SIM-A First is selected 3. Failback is unchecked by default	<p>Choose which SIM card you want to use for the connection.</p> <p>When SIM-A First or SIM-B First is selected, it means the connection is built first by using SIM A/SIM B. And if the connection is failed, it will change to the other SIM card and try to dial again, until the connection is up.</p> <p>When SIM-A only or SIM-B only is selected, it will try to dial up only using the SIM card you selected.</p> <p>When Failback is checked, it means if the connection is dialed-up not using the main SIM you selected, it will failback to the main SIM and try to establish the connection periodically.</p> <p>Note_1: For the product with single SIM design, only SIM-A Only option is available.</p> <p>Note_2: Failback is available only when SIM-A First or SIM-B First is selected.</p>
Auto Flight Mode	The box is unchecked by default	<p>Check the Enable box to activate the function.</p> <p>By default, if you disabled the Auto Flight Mode, the cellular module will always occupy a physical channel with cellular tower. It can get data connection instantly, and receive managing SMS all the time on required. If you enabled the Auto Flight Mode, the gateway will pop up a message <i>"Flight mode will cause cellular function to be malfunctioned when the data session is offline."</i>, and it will make the cellular module into flight mode and disconnected with cellular tower physically. In, addition, whenever the cellular module is going to be used for data connection to backup the failed primary connection, the cellular module will be active to connect with cellular tower and get the data connection for use, It takes few more seconds.</p> <p>Note: Keep it unchecked unless your cellular ISP asked the connected gateway to enable the Auto Flight Mode.</p>

5G NR M2M Gateway

SIM Switch Policy NA Click the **Policy Setting** button to define the SIM Switch policy or browse the current policy settings.

Policy Setting	
Item	Setting
▶ Failed connection	<input type="text" value="0"/> (1-10) times
▶ RSSI Monitor	<input type="checkbox"/> Enable Threshold: - <input type="text" value="0"/> (-90~-113 dBm)
▶ Network Service	<input type="checkbox"/> Enable Loss LTE signal: <input type="text" value="0"/> (1~30 minutes)
▶ Roaming Service	<input type="checkbox"/> Enable Timeout: <input type="text" value="0"/> (1~30 minutes)

Configure SIM-A / SIM-B Card

Here you can set configurations for the cellular connection according to your situation or requirement.

Connection with SIM-A Card	
Item	Setting
▶ Network Type	<input type="text" value="Auto"/> ▼
▶ Dial-Up Profile	<input type="text" value="Manual-configuration"/> ▼
▶ APN	<input type="text"/>
▶ PIN Code	<input type="text"/> (Optional)
▶ Dial Number	<input type="text"/> (Optional)
▶ Account	<input type="text"/> (Optional)
▶ Password	<input type="text"/> <input type="checkbox"/> (Optional)
▶ Authentication	<input type="text" value="Auto"/> ▼
▶ IP Mode	<input type="text" value="Dynamic IP"/> ▼
▶ Primary DNS	<input type="text"/> (Optional)
▶ Secondary DNS	<input type="text"/> (Optional)
▶ Roaming	<input type="checkbox"/> Enable

Note_1: Configurations of SIM-B Card follows the same rule of Configurations of SIM-A Card, here we list SIM-A as the example.

Note_2: Both **Connection with SIM-A Card** and **Connection with SIM-B Card** will pop up only when the **SIM-A First** or **SIM-B First** is selected, otherwise it only pops out one of them.

Connection with SIM-A/-B Card		
Item	Value setting	Description
Network Type	1. A Must filled setting 2. By default Auto is selected	Select Auto to register a network automatically, regardless of the network type. Select 2G Only to register the 2G network only. Select 2G Prefer to register the 2G network first if it is available.

5G NR M2M Gateway

		<p>Select 3G only to register the 3G network only. Select 3G Prefer to register the 3G network first if it is available. Select LTE only to register the 4G network only.</p> <p>Note: Options may be different due to the specification of the module.</p>
Dial-Up Profile	<p>1. A Must filled setting 2. By default Manual-configuration is selected</p>	<p>Specify the type of dial-up profile for your cellular network. It can be Manual-configuration, APN Profile List, or Auto-detection.</p> <p>Select Manual-configuration to set APN (Access Point Name), Dial Number, Account, and Password to what your carrier provides. Select APN Profile List to set more than one profile to dial up in turn, until the connection is established. It will pop up a new filed, please go to Basic Network > WAN & Uplink > Internet Setup > SIM-A APN Profile List for details. Select Auto-detection to automatically bring out all configurations needed while dialing-up, by comparing the IMSI of the SIM card to the record listed in the manufacturer’s database.</p> <p>Note_1: You are highly recommended to select the Manual or APN Profile List to specify the network for your subscription. Your ISP always provides such network settings for the subscribers. Note_2: If you select Auto-detection, it is likely to connect to improper network, or failed to find a valid APN for your ISP.</p>
APN	<p>1. A Must filled setting 2. String format : any text</p>	<p>Enter the APN you want to use to establish the connection. This is a must-filled setting if you selected Manual-configuration as dial-up profile scheme.</p>
IP Type	<p>1. A Must filled setting 2. By default IPv4 is selected</p>	<p>Specify the IP type of the network service provided by your cellular network. It can be IPv4, IPv6, or IPv4/6.</p>
PIN code	<p>1. An Optional setting 2. String format : interger</p>	<p>Enter the PIN (Personal Identification Number) code if it needs to unlock your SIM card.</p>
Dial Number, Account, Password	<p>1. An Optional setting 2. String format : any text</p>	<p>Enter the optional Dial Number, Account, and Password settings if your ISP provided such settings to you. Note: These settings are only displayed when Manual-configuration is selected.</p>
Authentication	<p>1. A Must filled setting 2. By default Auto is selected</p>	<p>Select PAP (Password Authentication Protocol) and use such protocol to be authenticated with the carrier’s server. Select CHAP (Challenge Handshake Authentication Protocol) and use such protocol to be authenticated with the carrier’s server. When Auto is selected, it means it will authenticate with the server either PAP or CHAP.</p>
IP Mode	<p>1. A Must filled setting 2. By default Dynamic IP is selected</p>	<p>When Dynamic IP is selected, it means it will get all IP configurations from the carrier’s server and set to the device directly. If you have specific application provided by the carrier, and want to set IP configurations on your own, you can switch to Static IP mode and fill in all parameters that required, such as IP address, subnet mask and gateway.</p> <p>Note: IP Subnet Mask is a must filled setting, and make sure you have the right configuration. Otherwise, the connection may get issues.</p>
Primary DNS	<p>1. An Optional setting 2. String format : IP address (IPv4 type)</p>	<p>Enter the IP address to change the primary DNS (Domain Name Server) setting. If it is not filled-in, the server address is given by the carrier while dialing-up.</p>
Secondary DNS	<p>1. An Optional setting</p>	<p>Enter the IP address to change the secondary DNS (Domain Name Server)</p>

5G NR M2M Gateway

	2. String format : IP address (IPv4 type)	setting. If it is not filled-in, the server address is given by the carrier while dialing-up.
Roaming	The box is unchecked by default	Check the box to establish the connection even the registration status is roaming, not in home network. Note: It may cost additional charges if the connection is under roaming.

Create/Edit SIM-A / SIM-B APN Profile List

You can add a new APN profile for the connection, or modify the content of the APN profile you added. It is available only when you select **Dial-Up Profile** as **APN Profile List**.

SIM-A APN Profile List Add Delete									
ID	Profile Name	APN	IP Type	Account	Password	Authentication	Priority	Enable	Actions

List all the APN profile you created, easily for you to check and modify. It is available only when you select **Dial-Up Profile** as **APN Profile List**.

When **Add** button is applied, an **APN Profile Configuration** screen will appear.

SIM-A APN Profile Configuration	
Item	Setting
▶ Profile Name	<input type="text" value="Profile-1"/>
▶ APN	<input type="text"/>
▶ IP Type	<input type="text" value="IPv4"/> ▼
▶ Account	<input type="text"/> (Optional)
▶ Password	<input type="text"/> (Optional)
▶ Authentication	<input type="text" value="Auto"/> ▼
▶ Priority	<input type="text"/>
▶ Profile	<input type="checkbox"/> Enable

SIM-A/-B APN Profile Configuration		
Item	Value setting	Description
Profile Name	1. By default Profile-x is listed 2. String format : any text	Enter the profile name you want to describe for this profile.
APN	String format : any text	Enter the APN you want to use to establish the connection.
IP Type	1. A Must filled setting 2. By default IPv4 is selected	Specify the IP type of the network service provided by your cellular network. It can be IPv4 , IPv6 , or IPv4/6 .
Account	String format : any text	Enter the Account you want to use for the authentication. Value Range: 0 ~ 53 characters.
Password	String format : any text	Enter the Password you want to use for the authentication.
Authentication	1. A Must filled setting 2. By default Auto is selected	Select the Authentication method for the cellular connection. It can be Auto , PAP , CHAP , or None .

5G NR M2M Gateway

Priority	1. A Must filled setting 2. String format : integer	Enter the value for the dialing-up order. The valid value is from 1 to 16. It will start to dial up with the profile that assigned with the smallest number. Value Range: 1 ~ 16.
Profile	The box is checked by default	Check the box to enable this profile. Uncheck the box to disable this profile in dialing-up action.
Save	N/A	Click the Save button to save the configuration.
Undo	N/A	Click the X button to restore what you just configured back to the previous setting.

Setup Cellular Connection Common Configuration

Here you can change common configurations for Cellular WAN.

Cellular Connection Common Configuration	
Item	Setting
▶ Connection Control	Auto-reconnect ▼
▶ Time Schedule	(0) Always ▼
▶ MTU Setup	<input type="checkbox"/> Enable
▶ IP Passthrough (Cellular Bridge)	<input type="checkbox"/> Enable Fixed MAC : <input type="text"/>
▶ NAT	<input checked="" type="checkbox"/> Enable
▶ IGMP	Disable ▼
▶ WAN IP Alias	<input type="checkbox"/> Enable <input type="text" value="10.0.0.1"/>

Cellular Connection Common Configuration		
Item	Value setting	Description
Connection Control	By default Auto-reconnect is selected	When Auto-reconnect is selected, it means it will try to keep the Internet connection on all the time whenever the physical link is connected. When Connect-on-demand is selected, it means the Internet connection will be established only when detecting data traffic. When Connect Manually is selected, it means you need to click the Connect button to dial up the connection manually. Please go to Status > Basic Network > WAN & Uplink tab for details. Note: If the WAN interface serves as the primary one for another WAN interface in Failover role(and vice versa), the Connection Control parameter will not be available on both WANs as the system must set it to "Auto-reconnect"
Maximum Idle Time	1. An Optional setting 2. By default 600 seconds is filled-in	Specify the maximum Idle time setting to disconnect the internet connection when the connection idle timed out. Value Range: 300 ~ 86400. Note: This field is available only when Connect-on-demand or Connect Manually is selected as the connection control scheme.
Time Schedule	1. A Must filled setting 2. By default (0) Always is selected	When (0) Always is selected, it means this WAN is under operation all the time. Once you have set other schedule rules, there will be other options to select. Please go to Object Definition > Scheduling for details.
MTU Setup	1. An Optional setting	Check the Enable box to enable the MTU (Maximum Transmission Unit)

5G NR M2M Gateway

	2. Uncheck by default	limit, and specify the MTU for the cellular connection. MTU refers to Maximum Transmission Unit. It specifies the largest packet size permitted for Internet transmission. Value Range: 1200 ~ 1500.
IP Pass-through (Cellular Bridge)	1. The box is unchecked by default 2. String format for Fixed MAC : MAC address, e.g. 00:50:18:aa:bb:cc	When Enable box is checked, it means the device will directly assign the WAN IP to the first connected local LAN client. However, when an optional Fixed MAC is filled-in a non-zero value, it means only the client with this MAC address can get the WAN IP address. Note: When the IP Pass-through is on, NAT and WAN IP Alias will be unavailable until the function is disabled again.
NAT	Check by default	Uncheck the box to disable NAT (Network Address Translation) function.
IGMP	By default Disable is selected	Select Auto to enable IGMP function. Check the Enable box to enable IGMP Proxy .
WAN IP Alias	1. Unchecked by default 2. String format: IP address (IPv4 type)	Check the box to enable WAN IP Alias , and fill in the IP address you want to assign.

Network Monitoring Configuration	
Item	Setting
▶ Network Monitoring Configuration	<input checked="" type="checkbox"/> Enable
▶ Checking Method	DNS Query ▼
▶ Loading Check	<input checked="" type="checkbox"/> Enable
▶ Query Interval	5 (seconds)
▶ Latency Threshold	3000 (ms)
▶ Fail Threshold	5 (Times)
▶ Target1	DNS1 ▼
▶ Target2	None ▼

Network Monitoring Configuration		
Item	Value setting	Description
Network Monitoring Configuration	1. An optional setting 2. Box is checked by default	Check the Enable box to activate the network monitoring function.
Checking Method	1. An Optional setting 2. DNS Query is set by default	Choose either DNS Query or ICMP Checking to detect WAN link. With DNS Query , the system checks the connection by sending DNS Query packets to the destination specified in Target 1 and Target 2. With ICMP Checking , the system will check connection by sending ICMP request packets to the destination specified in Target 1 and Target 2.
Loading Check	1. An optional setting 2. Box is checked by default	Check the Enable box to activate the loading check function. Enable Loading Check allows the gateway to ignore unreturned DNS queries or ICMP requests when WAN bandwidth is fully occupied. This is to prevent false link-down status.
Query Interval	1. An Optional setting 2. 5 seconds is selected by default.	Specify a time interval as the DNS Query Interval . Query Interval defines the transmitting interval between two DNS Query or ICMP checking packets.

5G NR M2M Gateway

		With DNS Query , the system checks the connection by sending DNS Query packets to the destination specified in Target 1 and Target 2. <u>Value Range:</u> 2 ~ 14400.
Check Interval	1. An Optional setting 2. 5 seconds is selected by default.	Specify a time interval as the ICMP Checking Interval . Query Interval defines the transmitting interval between two DNS Query or ICMP checking packets. With ICMP Checking , the system will check connection by sending ICMP request packets to the destination specified in Target 1 and Target 2. <u>Value Range:</u> 2 ~ 14400.
Latency Threshold	1. An Optional setting 2. 3000 ms is set by default	Enter a number of detecting disconnection times to be the threshold before disconnection is acknowledged. Latency Threshold defines the tolerance threshold of responding time. <u>Value Range:</u> 2000 ~ 3000 seconds.
Fail Threshold	1. An Optional setting 2. 5 times is set by default	Enter a number of detecting disconnection times to be the threshold before disconnection is acknowledged. Fail Threshold specifies the detected disconnection before the router recognize the WAN link down status. <u>Value Range:</u> 1 ~ 10 times.
Target 1	1. An Optional filled setting 2. DNS1 is selected by default	Target1 specifies the first target of sending DNS query/ICMP request. DNS1: set the primary DNS to be the target. DNS2: set the secondary DNS to be the target. Gateway: set the Current gateway to be the target. Other Host: enter an IP address to be the target.
Target 2	1. An Optional filled setting 2. None is selected by default	Target1 specifies the second target of sending DNS query/ICMP request. None: no second target is required. DNS1: set the primary DNS to be the target. DNS2: set the secondary DNS to be the target. Gateway: set the Current gateway to be the target. Other Host: enter an IP address to be the target.
Save	N/A	Click Save to save the settings.
Undo	N/A	Click Undo to cancel the settings.

5G NR M2M Gateway

2.1.3 Load Balance

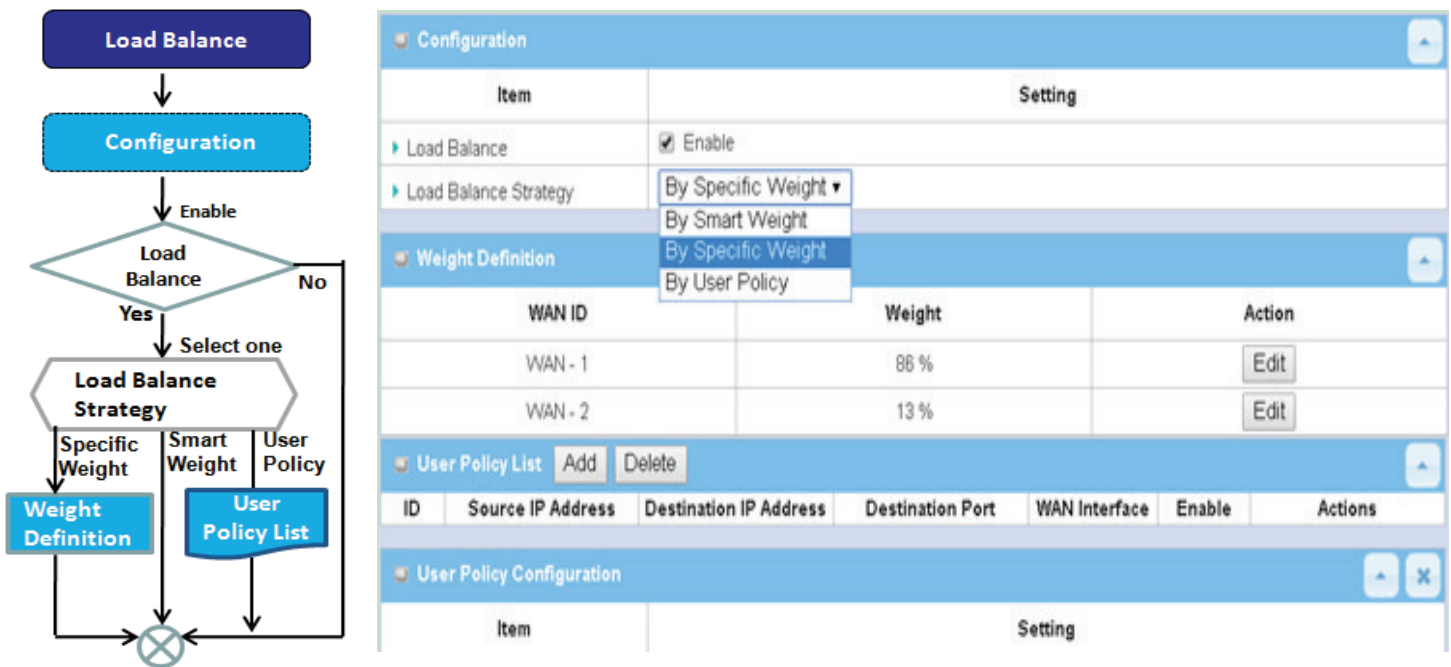

When there are multiple WAN interfaces, and when the bandwidth of one WAN connection is not enough for the traffic loads from the Intranet to the Internet, the WAN load balance function can be considered to enlarge the total WAN bandwidth.

Load Balance Strategy

There are three optional strategies for load balance: **“By Smart Weight”**, **“By Specific Weight”**, and **“By User Policy”**. Administrator can select strategy according to application requirement and environment status. The strategies are explained as below.

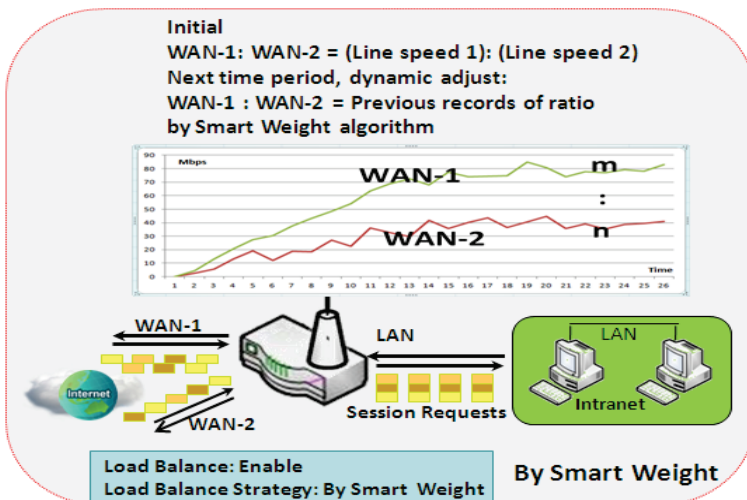

By Smart Weight

If based on "By Smart Weight" strategy, gateway will take the line speed settings of all WAN interfaces specified in "Physical Interface" configuration page as default ratio for data transfer. Based on the ratio of packet bytes via these WAN interfaces in past period (maybe 5 minutes), system decides how many sessions will be transferred via each WAN interface for next period. Administrator may take it as a fast approach to maximize the bandwidth utilization of multiple WAN interfaces in gateway

5G NR M2M Gateway

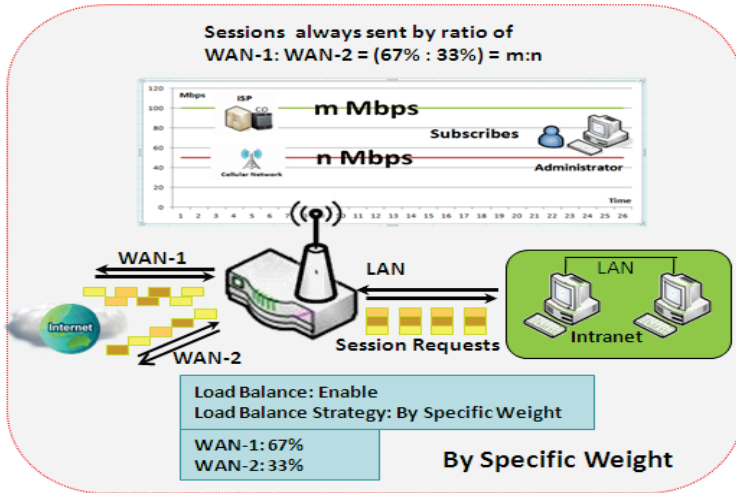

By Specific Weight

When you select "By Specific Weight", you need to set up ratio of WAN-1/WAN-2 to decide sessions sent ratio. Total ratio should be 100%. Ratio is usually defined based on practical WAN speed of environment. Gateway's traffic control process will operate routing adequately based on the dedicated weights ratio on all WAN interfaces.

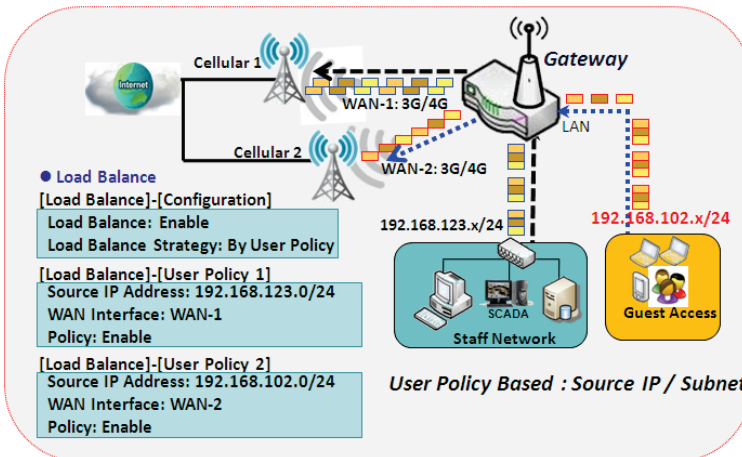

By User Policy

If "By User Policy" load balance strategy is selected, it can allow you to mapping Source IP, Destination IP, or Destination Port to assigned WAN interface. This IP address is not only a single IP but also a subnet or IP range. Destination port can be a single port or port range. You can select one target for one mapping to setup IP address and leave others just left as "any"/ "All". Besides this, you can also set protocol as TCP, UDP or both.

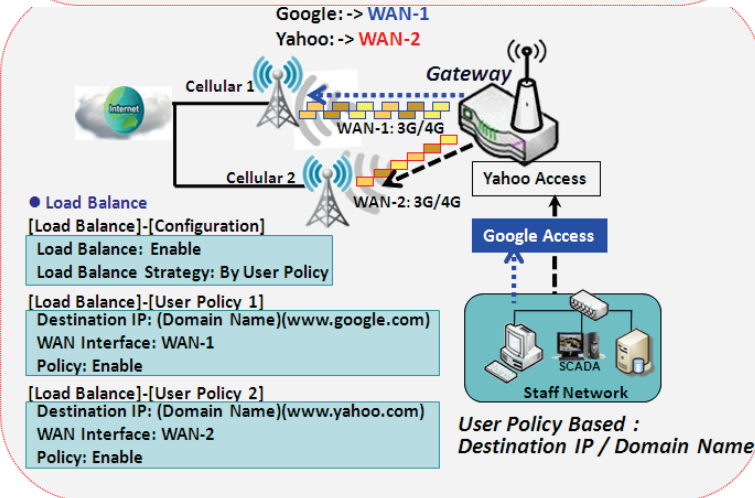

Diagrams shown on left side are examples user policy. The first diagram illustrates example for mapping various source IP subnets to different WAN interface. All packets from different subnet will be routed to the assigned WAN interface. Administrator can manage and balance the loading among available WAN interfaces accordingly.

The second diagram illustrates another example for routing packets with designated destination IP or domain name to a certain WAN interface. If packets no belong to user policy rule, the gateway just routes those packets based on smart weight algorithm.

5G NR M2M Gateway

Load Balance Setting

Go to **Basic Network > WAN & Uplink > Load Balance** Tab.

The **Load Balance** function is used to manage balance bandwidth usage among multiple WAN connections. When you choose "By Smart Weight" strategy, system will operate load balance function automatically based on the embedded Smart Weight algorithm. However, when you choose "By Specific Weight" strategy, the further "Weight Definition" configuration window will let you define the ratio of transferred sessions between all WAN interfaces for data transfer. At last, when you choose "By User Policy" strategy, the further "User Policy List" shows all defined user policy entries, and the "User Policy Configuration" window will let you create and define one user policy for routing dedicated packet flow via one WAN interface.

Enable/Select Load Balance Strategy

Configuration		
Item	Setting	
▶ Load Balance	<input type="checkbox"/> Enable	
▶ Load Balance Strategy	By Specific Weight ▾	

Configuration Item	Value setting	Description
Load Balance	Unchecked by default	Check the Enable box to activate Load Balance function.
Load Balance Strategy	1. A Must filled setting 2. By Smart Weight is selected by default.	There are up to three load balance strategies. Select the preferred one. By Smart Weight: System will operate load balance function automatically based on the embedded Smart Weight algorithm. By Specific Weight: System will adjust the ratio of transferred sessions among all WANs based on the specified weights for each WAN. By User Policy: System will route traffics through available WAN interface based on user defined rules. Note: The number of available strategies depends on the model you purchased.
Save	NA	Click the Save button to save the configuration
Undo	NA	Click the Undo button to restore what you just configured back to the previous setting.

When **By Specific Weight** is selected, user needs to adjust the percentage of WAN loading. System will give a value according to the bandwidth ratio of each WAN at first time and keep the value after clicking **Save** button.

Weight Definition		
WAN ID	Weight	Action
WAN - 1	86 %	<input type="button" value="Edit"/>
WAN - 2	13 %	<input type="button" value="Edit"/>

5G NR M2M Gateway

Weight Definition		
Item	Value setting	Description
WAN ID	NA	The Identifier for each available WAN interface..
Weight	1. A Must filled setting 2. Set with bandwidth ratio of each WAN by default.	Enter the weight ratio for each WAN interface. Initially, the bandwidth ratio of each WAN is set by default. Value Range: 1 ~ 99. Note: The sum of all weights can't be greater than 100%.
Save	NA	Click the Save button to save the configuration
Undo	NA	Click the Undo button to restore what you just configured back to the previous setting.

When **By User Policy** is selected, a **User Policy List** screen will appear. With properly configured your policy rules, system will route traffics through available WAN interface based on user defined rules

Create User Policy

User Policy List						
ID	Source IP Address	Destination IP Address	Destination Port	WAN Interface	Enable	Actions

When **Add** button is applied, **User Policy Configuration** screen will appear.

User Policy Configuration	
Item	Setting
▶ Source IP Address	Any ▼
▶ Destination IP Address	Any ▼
▶ Destination Port	All ▼
▶ Protocol	Both ▼
▶ WAN Interface	WAN - 1 ▼
▶ Policy	<input type="checkbox"/> Enable

User Policy Configuration		
Item	Value setting	Description
Source IP Address	1. A Must filled setting 2. Any is selected by default.	There are four options can be selected : Any: No specific Source IP is provided. The traffic may come from any source Subnet: Specify the Subnet for the traffics come from the subnet. Input format is : xxx.xxx.xxx.xxx/xx e.g. 192.168.123.0/24. IP Range: Specify the IP Range for the traffics come from the IPs Single IP: Specify a unique IP Address for the traffics come from the IP. Input format is : xxx.xxx.xxx.xxx e.g. 192.168.123.101.
Destination IP Address	1. A Must filled setting 2. Any is selected by default.	There are five options can be selected : Any: No specific destination IP is provided. The traffic may come to any destination. Subnet: Specify the Subnet for the traffics come to the subnet. Input format

5G NR M2M Gateway

		<p>is : xxx.xxx.xxx.xxx/xx e.g. 192.168.123.0/24.</p> <p>IP Range: Specify the IP Range for the traffics come to the IPs</p> <p>Single IP: Specify a unique IP Address for the traffics come to the IP. Input format is : xxx.xxx.xxx.xxx e.g. 192.168.123.101.</p> <p>Domain Name: Specify the domain name for the traffics come to the domain</p>
Destination Port	<p>1. A Must filled setting</p> <p>2. All is selected by default.</p>	<p>There are four options can be selected :</p> <p>All: No specific destination port is provided.</p> <p>Port Range: Specify the Destination Port Range for the traffics</p> <p>Single Port: Specify a unique destination Port for the traffics</p> <p>Well-known Applications: Select the service port of well-known application defined in dropdown list.</p>
Protocol	<p>1. A Must filled setting</p> <p>2. Both is selected by default.</p>	<p>There are three options can be selected. They are Both, TCP, and UDP.</p>
WAN Interface	<p>1. A Must filled setting</p> <p>2. WAN-1 is selected by default.</p>	<p>User can select the interface that traffic should go.</p> <p>Note that the WAN interface dropdown list will only show the available WAN interfaces.</p>
Policy	<p>Unchecked by default</p>	<p>Check the Enable checkbox to activate the policy rule.</p>
Save	<p>NA</p>	<p>Click the Save button to save the configuration</p>
Undo	<p>NA</p>	<p>Click the Undo button to restore what you just configured back to the previous setting.</p>

5G NR M2M Gateway

2.2 LAN & VLAN

This section provides the configuration of LAN and VLAN. VLAN is an optional feature, and it depends on the product specification of the purchased gateway.

2.2.1 Ethernet LAN

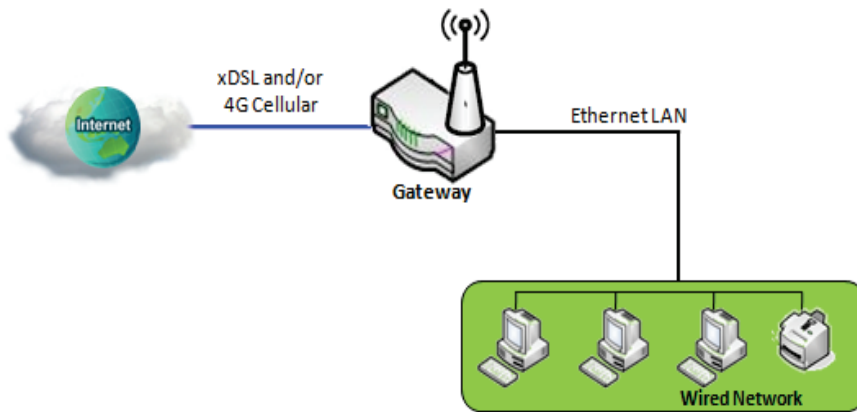

The Local Area Network (LAN) can be used to share data or files among computers attached to a network. Following diagram illustrates the network that wired and interconnects computers.

Please follow the following instructions to do IPv4 Ethernet LAN Setup.

Configuration	
Item	Setting
▶ IP Mode	Static IP
▶ LAN IP Address	<input type="text" value="192.168.0.1"/>
▶ Subnet Mask	<input type="text" value="255.255.255.0 (/24)"/>

Configuration		
Item	Value setting	Description
IP Mode	N/A	It shows the LAN IP mode for the gateway according the related configuration. Static IP: If there is at least one WAN interface activated, the LAN IP mode is fixed in Static IP mode. Dynamic IP: If all the available WAN interfaces are disabled, the LAN IP mode can be Dynamic IP mode.
LAN IP Address	1. A Must filled setting 2. 192.168.0.1 is set by default	Enter the local IP address of this device. The network device(s) on your network must use the LAN IP address of this device as their Default Gateway. You can change it if necessary. Note: It's also the IP address of web UI. If you change it, you need to type new IP address in the browser to see web UI.
Subnet Mask	1. A Must filled setting 2. 255.255.255.0 (/24) is set by default	Select the subnet mask for this gateway from the dropdown list. Subnet mask defines how many clients are allowed in one network or subnet. The default subnet mask is 255.255.255.0 (/24), and it means maximum 254 IP

5G NR M2M Gateway

		addresses are allowed in this subnet. However, one of them is occupied by LAN IP address of this gateway, so there are maximum 253 clients allowed in LAN network. Value Range: 255.0.0.0 (/8) ~ 255.255.255.252 (/30).
Save	N/A	Click the Save button to save the configuration
Undo	N/A	Click the Undo button to restore what you just configured back to the previous setting.

Create / Edit Additional IP

This gateway provides the LAN IP alias function for some special management consideration. You can add additional LAN IP for this gateway, and access to this gateway with the additional IP.

Additional IP
Add
Delete
▲
✕

ID	Name	Interface	IP Address	Subnet Mask	Enable	Action
----	------	-----------	------------	-------------	--------	--------

When **Add** button is applied, **Additional IP Configuration** screen will appear.

Additional IP Configuration
▲
✕

Item	Setting
▶ Name	<input type="text"/>
▶ Interface	lo ▼
▶ IP Address	<input type="text"/>
▶ Subnet Mask	255.255.255.0 (/24) ▼
▶ Enable	<input type="checkbox"/>

Save

Configuration		
Item	Value setting	Description
Name	.1 An Optional Setting	Enter the name for the alias IP address.
Interface	1. A Must filled setting 2. lo is set by default	Specify the Interface type. It can be lo or br0 .
IP Address	1. An Optional setting 2. 192.168.0.1 is set by default	Enter the addition IP address for this device.
Subnet Mask	1. A Must filled setting 2. 255.255.255.0 (/24) is set by default	Select the subnet mask for this gateway from the dropdown list. Subnet mask defines how many clients are allowed in one network or subnet. The default subnet mask is 255.255.255.0 (/24), and it means maximum 254 IP addresses are allowed in this subnet. However, one of them is occupied by LAN IP address of this gateway, so there are maximum 253 clients allowed in LAN network. Value Range: 255.0.0.0 (/8) ~ 255.255.255.255 (/32).

5G NR M2M Gateway

Save NA Click the **Save** button to save the configuration

5G NR M2M Gateway

2.2.2 VLAN

VLAN (Virtual LAN) is a logical network under a certain switch or router device to group client hosts with a specific VLAN ID. This gateway supports both Port-based VLAN and Tag-based VLAN. These functions allow you to divide local network into different “virtual LANs”. It is common requirement for some application scenario. For example, there are various departments within SMB. All client hosts in the same department should own common access privilege and QoS property. You can assign departments either by port-based VLAN or tag-based VLAN as a group, and then configure it by your plan. In some cases, ISP may need router to support “VLAN tag” for certain kinds of services (e.g. IPTV). You can group all devices required this service as one tag-based VLAN.

If the gateway has only one physical Ethernet LAN port, only very limited configuration is available if you enable the Port-based VLAN.

➤ Port-based VLAN

Port-based VLAN function can group Ethernet ports, Port-1 ~ Port-4, and WiFi Virtual Access Points, VAP-1 ~ VAP-8, together for differentiated services like Internet surfing, multimedia enjoyment, VoIP talking, and so on. Two operation modes, NAT and Bridge, can be applied to each VLAN group. One DHCP server can be allocated for a NAT VLAN group to let group host member get its IP address. Thus, each host can surf Internet via the NAT mechanism of business access gateway. In bridge mode, Intranet packet flow is delivered out WAN trunk port with VLAN tag to upper link for different services.

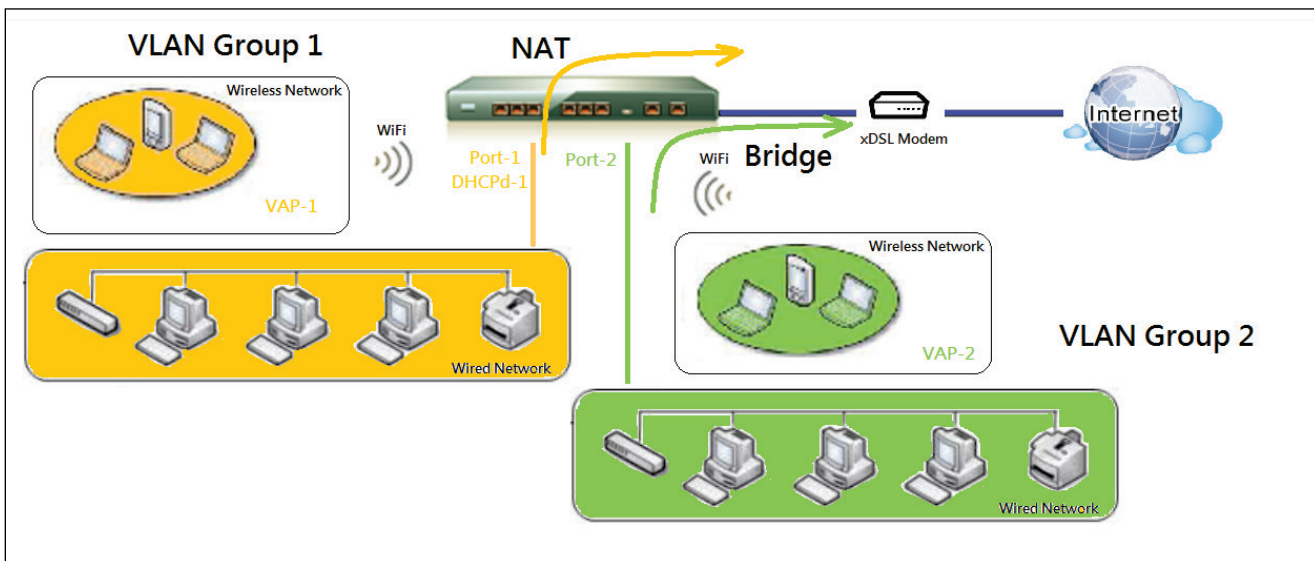

A port-based VLAN is a group of ports on an Ethernet or Virtual APs of Wired or Wireless Gateway that form a logical LAN segment. Following is an example.

For example, in a company, administrator schemes out 3 network segments, Lobby/Meeting Room, Office, and Data Center. In a Wireless Gateway, administrator can configure Lobby/Meeting Room segment with VLAN ID 3. The VLAN group includes Port-3 and VAP-8 (SSID: Guest) with NAT mode and DHCP-3 server equipped. He also configure Office segment with VLAN ID 2. The VLAN group includes Port-2 and VAP-1 (SSID: Staff) with NAT mode and DHCP-2 server equipped. At last, administrator also configure Data Center segment with VLAN ID 1. The VLAN group includes Port-1 with NAT mode to WAN interface as shown in following diagram.

5G NR M2M Gateway

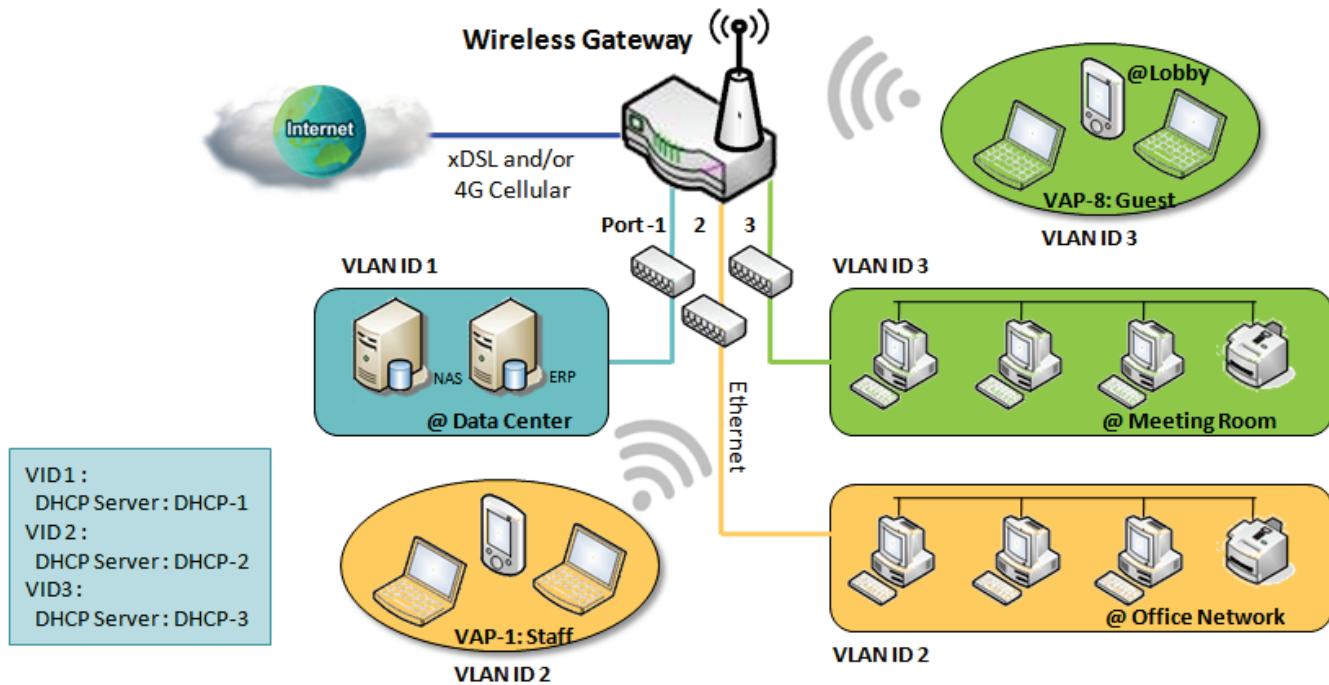

Above is the general case for 3 Ethernet LAN ports in the gateway. But if the device just has one Ethernet LAN port, there will be only one VLAN group for the device. Under such situation, it still supports both the NAT and Bridge mode for the Port-based VLAN configuration.

➤ Tag-based VLAN

Tag-based VLAN function can group Ethernet ports, Port-1 ~ Port-4, and WiFi Virtual Access Points, VAP-1 ~ VAP-8, together with different VLAN tags for deploying subnets in Intranet. All packet flows can carry with different VLAN tags even at the same physical Ethernet port for Intranet. These flows can be directed to different destination because they have differentiated tags. The approach is very useful to group some hosts at different geographic location to be in the same workgroup.

Tag-based VLAN is also called a VLAN Trunk. The VLAN Trunk collects all packet flows with different VLAN IDs from Router device and delivers them in the Intranet. VLAN membership in a tagged VLAN is determined by VLAN ID information within the packet frames that are received on a port. Administrator can further use a VLAN switch to separate the VLAN trunk to different groups based on VLAN ID. Following is an example.

5G NR M2M Gateway

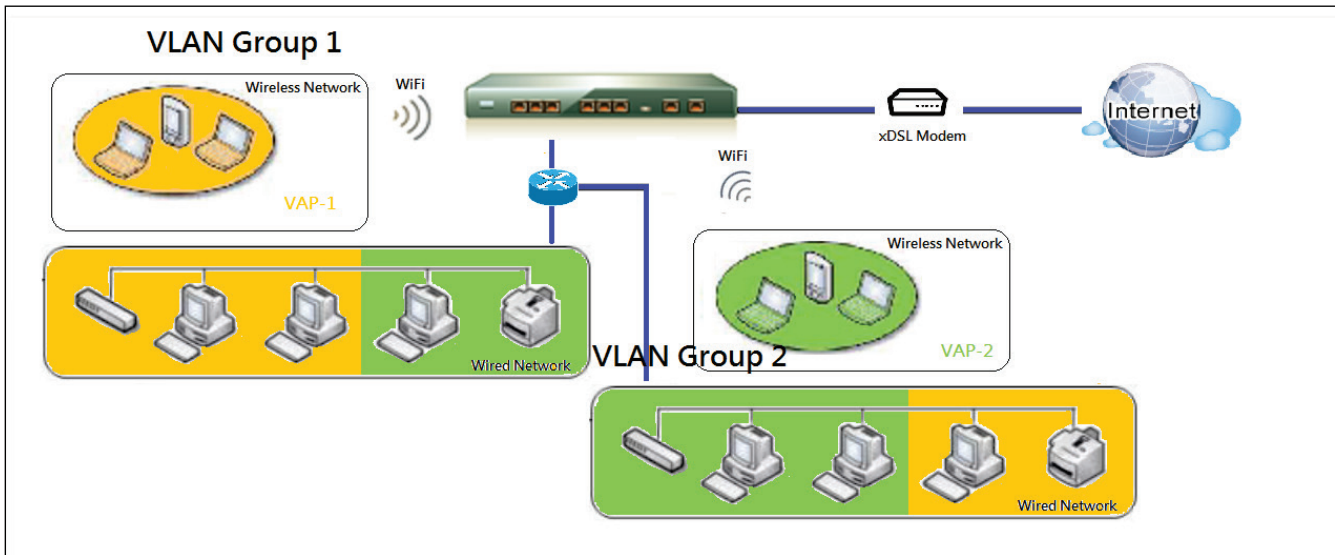

For example, in a company, administrator schemes out 3 network segments, Lab, Meeting Rooms, and Office. In a Security VPN Gateway, administrator can configure Office segment with VLAN ID 12. The VLAN group is equipped with DHCP-3 server to construct a 192.168.12.x subnet. He also configure Meeting Rooms segment with VLAN ID 11. The VLAN group is equipped with DHCP-2 server to construct a 192.168.11.x subnet for Intranet only. That is, any client host in VLAN 11 group can't access the Internet. At last, he configures Lab segment with VLAN ID 10. The VLAN group is equipped with DHCP-1 server to construct a 192.168.10.x subnet.

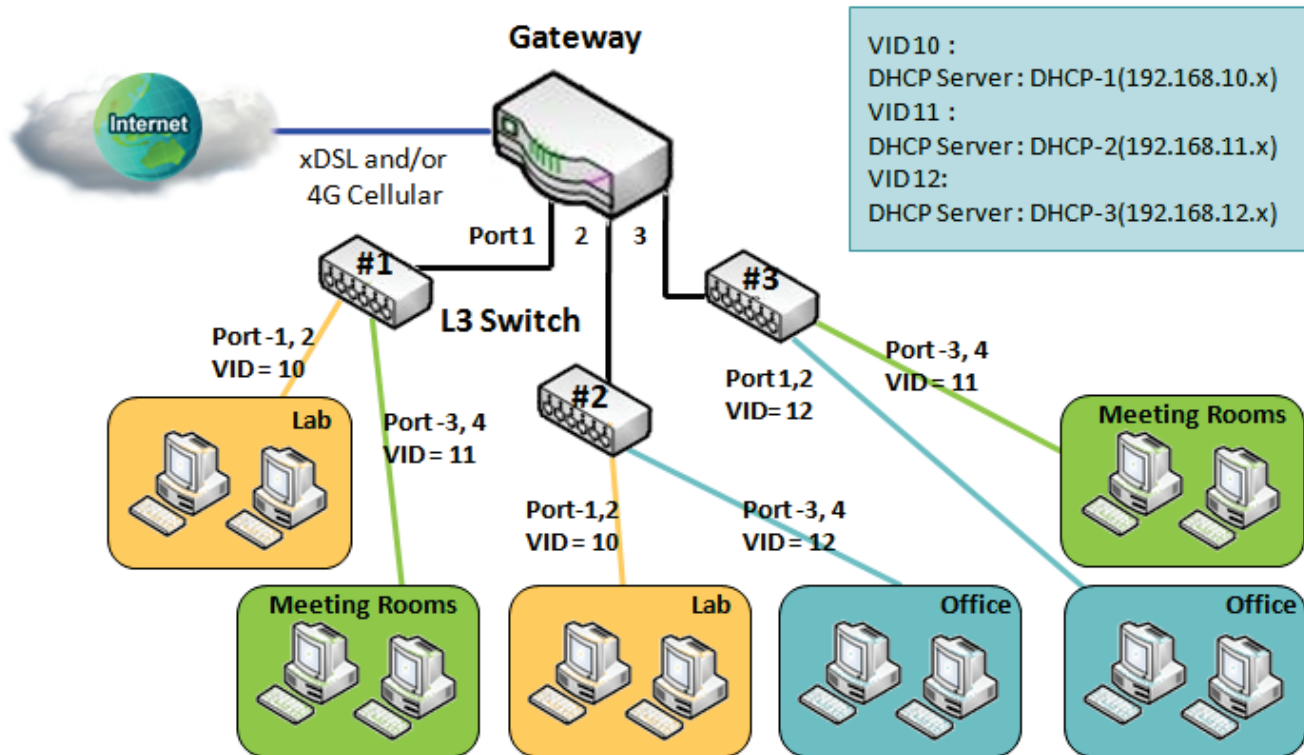

5G NR M2M Gateway

➤ VLAN Groups Access Control

Administrator can specify the Internet access permission for all VLAN groups. He can also configure which VLAN groups are allowed to communicate with each other.

VLAN Group Internet Access

Administrator can specify members of one VLAN group to be able to access Internet or not. Following is an example that VLAN groups of VID is 2 and 3 can access Internet but the one with VID is 1 cannot access Internet. That is, visitors in meeting room and staffs in office network can access Internet. But the computers/servers in data center cannot access Internet since security consideration. Servers in data center only for trusted staffs or are accessed in secure tunnels.

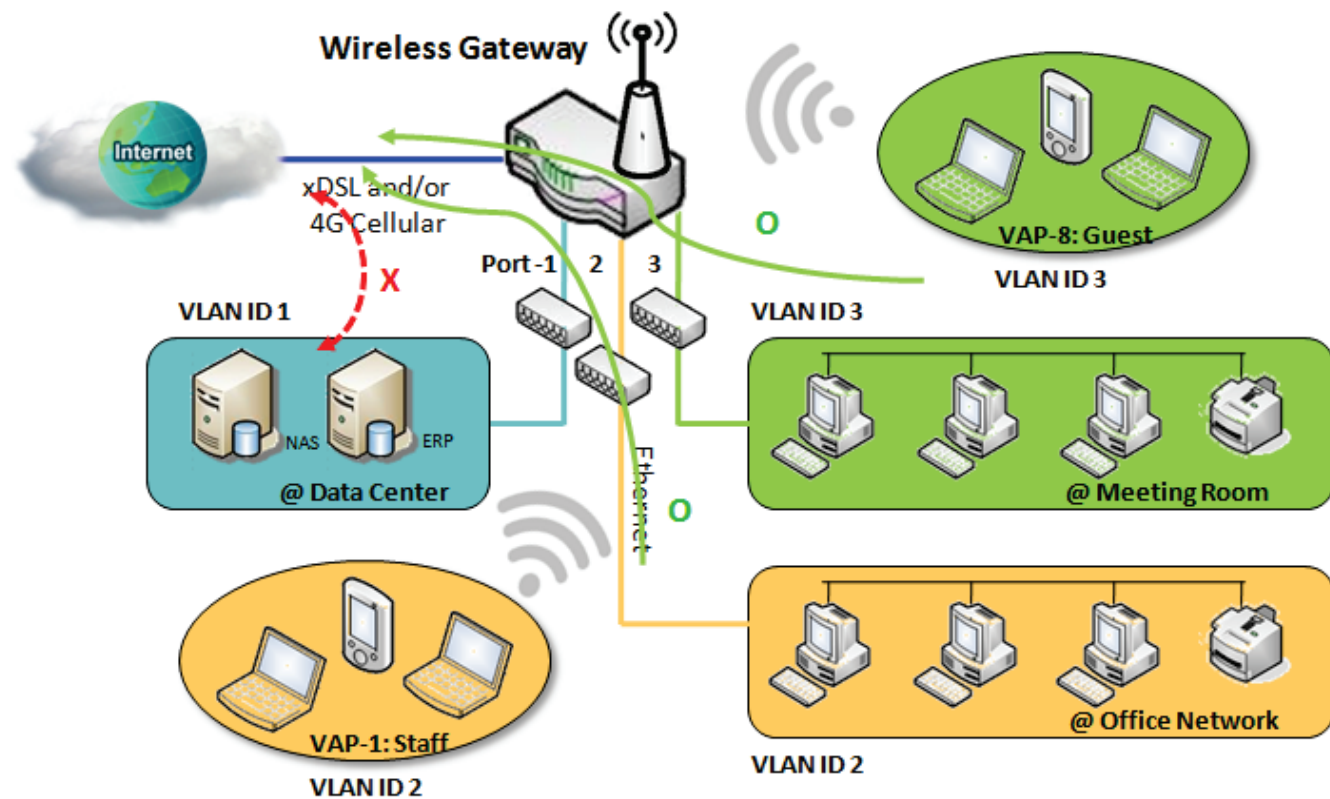

5G NR M2M Gateway

Inter VLAN Group Routing:

In Port-based tagging, administrator can specify member hosts of one VLAN group to be able to communicate with the ones of another VLAN group or not. This is a communication pair, and one VLAN group can join many communication pairs. But communication pair doesn't have the transitive property. That is, A can communicate with B, and B can communicate with C, it doesn't imply that A can communicate with C. An example is shown at following diagram. VLAN groups of VID is 1 and 2 can access each other but the ones between VID 1 and VID 3 and between VID 2 and VID 3 can't.

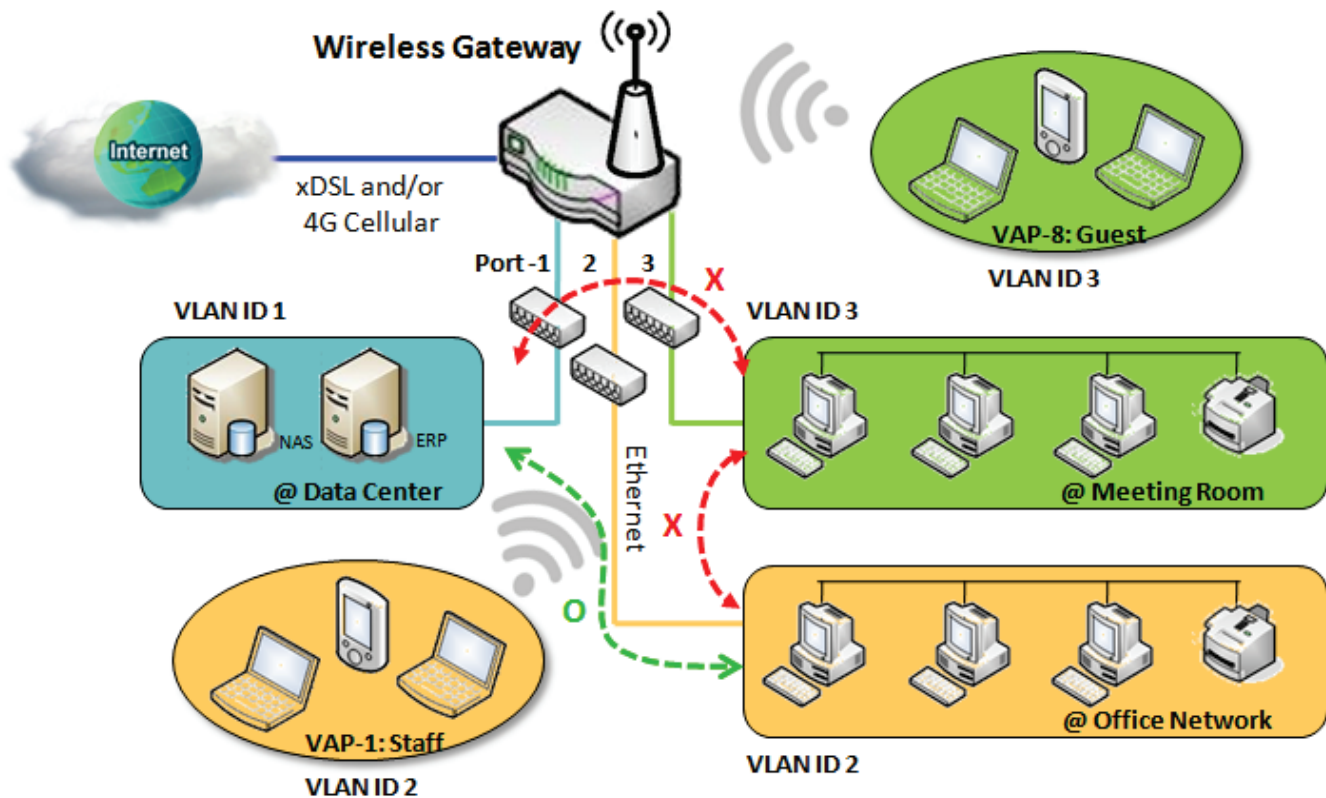

5G NR M2M Gateway

VLAN Setting

Go to **Basic Network > LAN & VLAN > VLAN** Tab.

The VLAN function allows you to divide local network into different virtual LANs. There are Port-based and Tag-based VLAN types. Select one that applies.

Configuration	
Item	Setting
VLAN Types	Port-based ▼
System Reserved VLAN ID	Start ID <input type="text" value="1"/> (1-4091) ~ End ID <input type="text" value="5"/>

Configuration		
Item	Value setting	Description
VLAN Type	Port-based is selected by default	Select the VLAN type that you want to adopt for organizing you local subnets. Port-based: Port-based VLAN allows you to add rule for each LAN port, and you can do advanced control with its VLAN ID. Tag-based: Tag-based VLAN allows you to add VLAN ID, and select member and DHCP Server for this VLAN ID. Go to Tag-based VLAN List table.
System Reserved VLAN ID	1 ~ 5 is reserved by default	Specify the VLAN ID range that is reserved for the system operation. For the Port-based/Tag-based VLAN grouping, only use the ID outside the reserved range. Value Range: 1 ~ 4091.
Save	NA	Click the Save button to save the configuration

Port-based VLAN – Create/Edit VLAN Rules

The port-based VLAN allows you to custom each LAN port. There is a default rule shows the configuration of all LAN ports. Also, if your device has a DMZ port, you will see DMZ configuration, too. The maxima rule numbers is based on LAN port numbers.

Port-based VLAN List										
Name	VLAN ID	VLAN Tagging	NAT / Bridge	Port Members	LAN IP Address	Subnet Mask	Joined WAN	WAN VID	Enable	Actions
DMZ	4094	X	NAT	DMZ Port	192.168.6.254	255.255.255.0	WAN - 1	0	<input checked="" type="checkbox"/>	<input type="button" value="Edit"/>
LAN	Native VLAN	X	NAT	<input type="button" value="Detail"/>	192.168.123.254	255.255.255.0	All WANs	0	<input checked="" type="checkbox"/>	<input type="button" value="Edit"/>

When **Add** button is applied, Port-based VLAN Configuration screen will appear, which is including 3 sections: **Port-based VLAN Configuration**, **IP Fixed Mapping Rule List**, and **Inter VLAN Group Routing** (enter through a button)

5G NR M2M Gateway

Port-based VLAN - Configuration

Port-based VLAN Configuration	
Item	Setting
▶ Name	VLAN - 1
▶ VLAN ID	
▶ VLAN Tagging	Disable ▾
▶ NAT / Bridge	NAT ▾
▶ Port Members	Port: <input type="checkbox"/> Port-2 <input type="checkbox"/> Port-3 2.4G: <input type="checkbox"/> VAP-1 <input type="checkbox"/> VAP-2 <input type="checkbox"/> VAP-3 <input type="checkbox"/> VAP-4 <input type="checkbox"/> VAP-5 <input type="checkbox"/> VAP-6 <input type="checkbox"/> VAP-7 <input type="checkbox"/> VAP-8 5G: <input type="checkbox"/> VAP-1 <input type="checkbox"/> VAP-2 <input type="checkbox"/> VAP-3 <input type="checkbox"/> VAP-4 <input type="checkbox"/> VAP-5 <input type="checkbox"/> VAP-6 <input type="checkbox"/> VAP-7 <input type="checkbox"/> VAP-8
▶ LAN to Join	<input type="checkbox"/> Enable <input type="text" value="DHCP 1"/> ▾

Port-based VLAN Configuration (part-I)		
Item	Value setting	Description
Name	1. A Must filled setting 2. String format: already have default texts	Define the Name of this rule. It has a default text and cannot be modified.
VLAN ID	A Must filled setting	Define the VLAN ID number, range is 1~4094.
VLAN Tagging	Disable is selected by default.	The rule is activated according to VLAN ID and Port Members configuration when Enable is selected. The rule is activated according Port Members configuration when Disable is selected.
NAT / Bridge	NAT is selected by default.	Select NAT mode or Bridge mode for the rule.
Port Members	These boxes are unchecked by default.	Select which LAN port(s) and VAP(s) that you want to add to the rule. Note: The available member list can be different for the purchased product.
LAN to Join	The box is unchecked by default.	Check the Enable box and select one of the defined DHCP Server for the List to define the DHCP server for the VLAN group. If you enabled this function, all the rest settings will be greyed out, not required to configured manually.
Save	NA	Click the Save button to save the configuration
Undo	NA	Click the Undo button to restore what you just configured back to the previous setting.

If you didn't decide to bind the VLAN group to a pre-defined DHCP server, you have to further specify the following settings.

5G NR M2M Gateway

▶ WAN & WAN VID to Join	All WANs ▾ None
▶ LAN IP Address	192.168.2.254
▶ Subnet Mask	255.255.255.0 (/24) ▾
▶ DHCP Server / Relay	Server ▾
▶ DHCP Server Name	
▶ IP Pool	Starting Address: 192.168.2.100 Ending Address: 192.168.2.200
▶ Lease Time	86400 seconds
▶ Domain Name	(Optional)
▶ Primary DNS	(Optional)
▶ Secondary DNS	(Optional)
▶ Primary WINS	(Optional)
▶ Secondary WINS	(Optional)
▶ Gateway	(Optional)
▶ Enable	<input type="checkbox"/>

Port-based VLAN Configuration (part-II)		
Item	Value setting	Description
WAN & WAN VID to Join	All WANs is selected by default.	Select which WAN or All WANs that allow accessing Internet. Note: If Bridge mode is selected, you need to select a WAN and enter a VID.
LAN IP Address	A Must filled setting	Assign an IP Address for the DHCP Server that the rule used, this IP address is a gateway IP.
Subnet Mask	255.255.255.0(/24) is selected by default.	Select a Subnet Mask for the DHCP Server.
DHCP Server /Relay	Server is selected by default.	Define the DHCP Server type. There are three types you can select: Server , Relay , and Disable . Relay : Select Relay to enable DHCP Relay function for the VLAN group, and you only need to fill the DHCP Server IP Address field. Server : Select Server to enable DHCP Server function for the VLAN group, and you need to specify the DHCP Server settings. Disable : Select Disable to disable the DHCP Server function for the VLAN group.
DHCP Server IP Address (for DHCP Relay only)	A Must filled setting	If you select Relay type of DHCP Server, assign a DHCP Server IP Address that the gateway will relay the DHCP requests to the assigned DHCP server.
DHCP Option 82 (for DHCP Relay only)	An Optional filled setting	If you select Relay type of DHCP Server, you can further enable the DHCP Option 82 setting if the DHCP server support it.
DHCP Server Name	A Must filled setting	Define name of the DHCP Server for the specified VLAN group.
IP Pool	A Must filled setting	Define the IP Pool range. There are Starting Address and Ending Address fields. If a client requests an IP address from this DHCP Server, it will assign an IP address in the range of IP pool .
Lease Time	A Must filled setting	Define a period of time for an IP Address that the DHCP Server leases to a new

5G NR M2M Gateway

		device. By default, the lease time is 86400 seconds.
Domain Name	String format can be any text	The Domain Name of this DHCP Server. <i>Value Range:</i> 0 ~ 31 characters.
Primary DNS	IPv4 format	The Primary DNS of this DHCP Server.
Secondary DNS	IPv4 format	The Secondary DNS of this DHCP Server.
Primary WINS	IPv4 format	The Primary WINS of this DHCP Server.
Secondary WINS	IPv4 format	The Secondary WINS of this DHCP Server.
Gateway	IPv4 format	The Gateway of this DHCP Server.
Enable	The box is unchecked by default.	Click Enable box to activate this rule.
Save	NA	Click the Save button to save the configuration
Undo	NA	Click the Undo button to restore what you just configured back to the previous setting.

5G NR M2M Gateway

Besides, you can add some IP rules in the **IP Fixed Mapping Rule List** if DHCP Server for the VLAN groups is required.

IP Fixed Mapping Rule List Add Delete			
MAC Address	IP Address	Enable	Actions

When **Add** button is applied, **Mapping Rule Configuration** screen will appear.

Mapping Rule Configuration		
Item	Value setting	Description
MAC Address	A Must filled setting	Define the MAC Address target that the DHCP Server wants to match.
IP Address	A Must filled setting	Define the IP Address that the DHCP Server will assign. If there is a request from the MAC Address filled in the above field, the DHCP Server will assign this IP Address to the client whose MAC Address matched the rule.
Enable	The box is unchecked by default.	Click Enable box to activate this rule.
Save	NA	Click the Save button to save the configuration

Note: ensure to always click on **Apply** button to apply the changes after the web browser refreshed taken you back to the VLAN page.

Port-based VLAN List Add Delete										
Name	VLAN ID	VLAN Tagging	NAT / Bridge	Port Members	LAN IP Address	Subnet Mask	Joined WAN	WAN VID	Enable	Actions
LAN	Native VLAN Tag 1	X	NAT	Detail	192.168.66.1	255.255.254.0	All WANs	0	<input checked="" type="checkbox"/>	Edit

Apply Inter VLAN Group Routing

5G NR M2M Gateway

Port-based VLAN – Inter VLAN Group Routing

Click **VLAN Group Routing** button, the **VLAN Group Internet Access Definition** and **Inter VLAN Group Routing** screen will appear.

VLAN Group Internet Access Definition		
VLAN IDs	Members	Internet Access(WAN)
1	Port : 2,3 2.4G VAP: 1,2,3,4,5,6,7,8 5G VAP: 1,2,3,4,5,6,7,8	Allow <input type="button" value="Edit"/>

Inter VLAN Group Routing		
VLAN IDs	Members	Action
		<input type="button" value="Edit"/>
		<input type="button" value="Edit"/>
		<input type="button" value="Edit"/>
		<input type="button" value="Edit"/>

When **Edit** button is applied, a screen similar to this will appear.

VLAN Group Internet Access Definition		
VLAN IDs	Members	Internet Access(WAN)
<input checked="" type="checkbox"/> 1	Port : 2,3 2.4G VAP: 1,2,3,4,5,6,7,8 5G VAP: 1,2,3,4,5,6,7,8	Allow <input type="button" value="Edit"/>

Inter VLAN Group Routing		
VLAN IDs	Members	Action
<input type="checkbox"/> 1		<input type="button" value="Edit"/>
		<input type="button" value="Edit"/>
		<input type="button" value="Edit"/>
		<input type="button" value="Edit"/>

Inter VLAN Group Routing		
Item	Value setting	Description
VALN Group Internet Access Definition	All boxes are checked by default.	By default, all boxes are checked means all VLAN ID members are allow to access WAN interface. If uncheck a certain VLAN ID box, it means the VLAN ID member can't access Internet anymore. Note: VLAN ID 1 is available always; it is the default VLAN ID of LAN rule. The

5G NR M2M Gateway

		other VLAN IDs are available only when they are enabled.
Inter VLAN Group Routing	The box is unchecked by default.	Click the expected VLAN IDs box to enable the Inter VLAN access function. By default, members in different VLAN IDs can't access each other. The gateway supports up to 4 rules for Inter VLAN Group Routing . For example, if ID_1 and ID_2 are checked, it means members in VLAN ID_1 can access members of VLAN ID_2, and vice versa.
Save	N/A	Click the Save button to save the configuration

Tag-based VLAN – Create/Edit VLAN Rules

The **Tag-based VLAN** allows you to customize each LAN port according to VLAN ID. There is a default rule shows the configuration of all LAN ports and all VAPs. Also, if your device has a DMZ port, you will see DMZ configuration, too. The router supports up to a maximum of 128 tag-based VLAN rule sets.

Tag-based VLAN List						
VLAN ID	Internet	Port Members	Bridge Interface	IP Address	Subnet Mask	Actions
Native VLAN	<input checked="" type="checkbox"/>	Port: <input checked="" type="checkbox"/> Port-2 <input checked="" type="checkbox"/> Port-3 2.4G: <input checked="" type="checkbox"/> VAP-1 <input checked="" type="checkbox"/> VAP-2 <input checked="" type="checkbox"/> VAP-3 <input checked="" type="checkbox"/> VAP-4 <input checked="" type="checkbox"/> VAP-5 <input checked="" type="checkbox"/> VAP-6 <input checked="" type="checkbox"/> VAP-7 <input checked="" type="checkbox"/> VAP-8 5G: <input checked="" type="checkbox"/> VAP-1 <input checked="" type="checkbox"/> VAP-2 <input checked="" type="checkbox"/> VAP-3 <input checked="" type="checkbox"/> VAP-4 <input checked="" type="checkbox"/> VAP-5 <input checked="" type="checkbox"/> VAP-6 <input checked="" type="checkbox"/> VAP-7 <input checked="" type="checkbox"/> VAP-8	DHCP 1			<input type="button" value="Edit"/> <input type="button" value="Select"/>

When **Add** button is applied, **Tag-based VLAN Configuration** screen will appear.

Tag-based VLAN Configuration	
Item	Setting
VLAN ID	<input type="text" value="0"/>
Internet Access	<input checked="" type="checkbox"/> Enable
Port Members	Port: <input type="checkbox"/> Port-2 <input type="checkbox"/> Port-3 2.4G: <input type="checkbox"/> VAP-1 <input type="checkbox"/> VAP-2 <input type="checkbox"/> VAP-3 <input type="checkbox"/> VAP-4 <input type="checkbox"/> VAP-5 <input type="checkbox"/> VAP-6 <input type="checkbox"/> VAP-7 <input type="checkbox"/> VAP-8 5G: <input type="checkbox"/> VAP-1 <input type="checkbox"/> VAP-2 <input type="checkbox"/> VAP-3 <input type="checkbox"/> VAP-4 <input type="checkbox"/> VAP-5 <input type="checkbox"/> VAP-6 <input type="checkbox"/> VAP-7 <input type="checkbox"/> VAP-8
Bridge Interface	<input type="text" value="DHCP 1"/>

Tag-based VLAN Configuration (Part-I)		
Item	Value setting	Description
VALN ID	A Must filled setting	Define the VLAN ID number, that is outside the system reserved range. Value Range: 1 ~ 4095.
Internet Access	The box is checked by default.	Click Enable box to allow the members in the VLAN group access to internet.
Port Members	The boxes are unchecked by default.	Check the LAN port box(es) to join the VLAN group. Check the VAP box(es) to join the VLAN group. Note: Only the wireless gateway has the VAP list.
Bridge Interface	DHCP 1 is selected by default.	Select a predefined DHCP Server , a New to defined a new DHCP server for these members of this VLAN group.
Save	N/A	Click Save button to save the configuration Note: After clicking Save button, always click Apply button to apply the settings.

5G NR M2M Gateway

If you select New to create a new DHCP server setting for the VLAN group, you have to further specify the following configuration.

▶ IP Address	<input type="text"/>
▶ Subnet Mask	255.255.255.0 (/24) ▼
▶ DHCP Relay	<input type="checkbox"/> Enable & Server IP : <input type="text"/>
▶ WAN Interface	WAN - 1 ▼
▶ DHCP Relay Option 82	<input type="checkbox"/> Enable

Tag-based VLAN Configuration (part-II)		
Item	Value setting	Description
IP Address	A Must filled setting	Assign an IP Address for the DHCP Server that the rule used, this IP address is a gateway IP.
Subnet Mask	255.255.255.0(/24) is selected by default.	Select a Subnet Mask for the DHCP Server.
DHCP Relay	The box is unchecked by default.	Check the box to enable the DHCP Relay function for the VLAN group, and you only need to fill the DHCP Server IP Address field.
WAN Interface	WAN-1 is selected by default.	Select which WAN interface that allow accessing Internet.
DHCP Option 82	An Optional filled setting	If you select Relay type of DHCP Server, you can further enable the DHCP Option 82 setting if the DHCP server support it.
Save	NA	Click the Save button to save the configuration
Undo	NA	Click the Undo button to restore what you just configured back to the previous setting.

Tag-based VLAN Summary

The configured tag-based VLAN group information will be displayed in the following screen.

Tag-based VLAN Summary	
Port	VLAN IDs
Port2	Native VLAN
Port3	Native VLAN

5G NR M2M Gateway

2.2.3 DHCP Server

➤ DHCP Server

The gateway supports up to 4 DHCP servers to fulfill the DHCP requests from different VLAN groups (please refer to VLAN section for getting more usage details). And there is one default setting for whose LAN IP Address is the same one of gateway LAN interface, with its default Subnet Mask setting as “255.255.255.0”, and its default IP Pool ranges is from “.100” to “.200” as shown at the DHCP Server List page on gateway’s WEB UI.

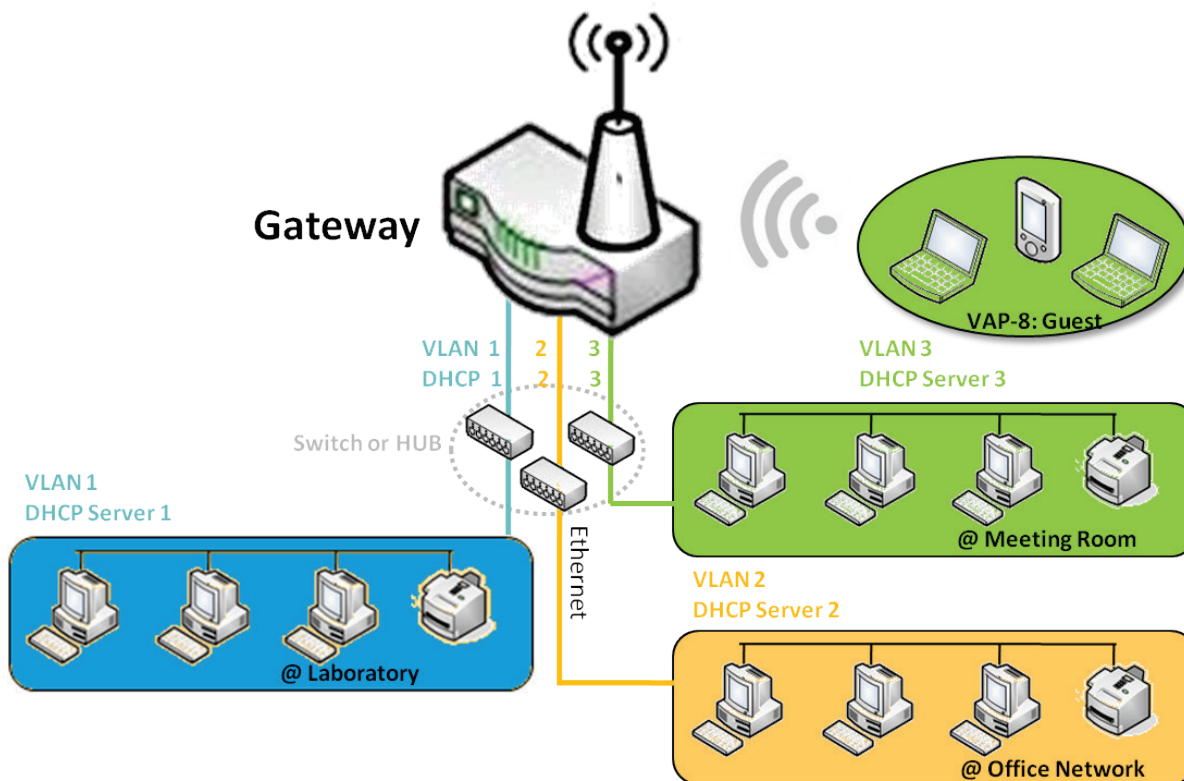

User can add more DHCP server configurations by clicking on the “Add” button behind “DHCP Server List”, or clicking on the “Edit” button at the end of each DHCP Server on list to edit its current settings. Besides, user can select a DHCP Server and delete it by clicking on the “Select” check-box and the “Delete” button.

5G NR M2M Gateway

➤ Fixed Mapping

User can assign fixed IP address to map the specific client MAC address by select them then copy, when targets were already existed in the **DHCP Client List**, or to add some other Mapping Rules by manually in advance, once the target's MAC address was not ready to connect.

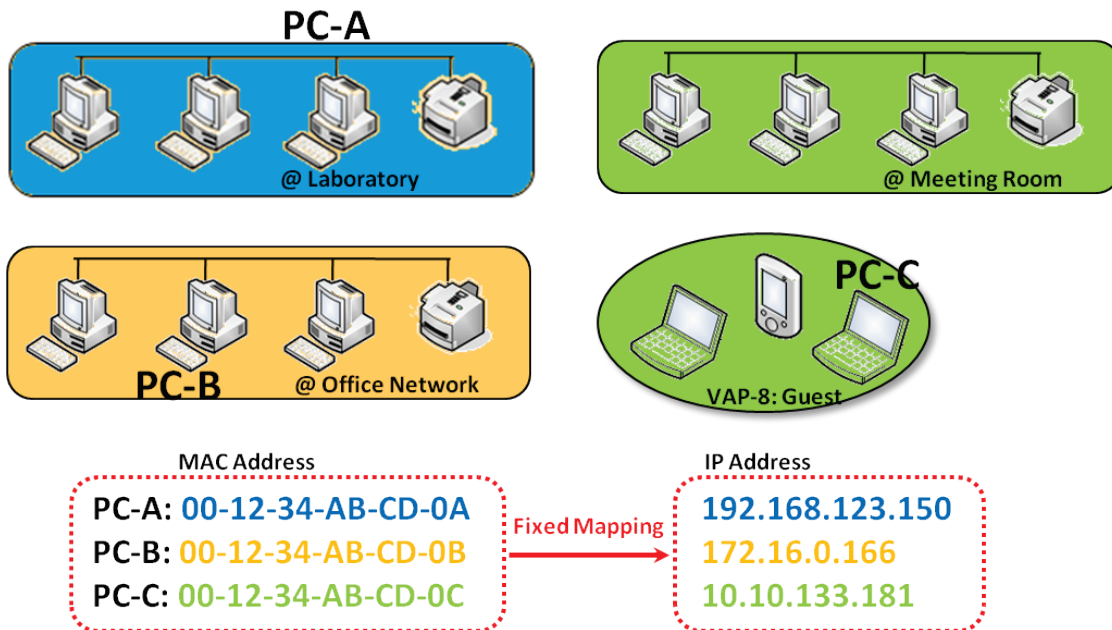

5G NR M2M Gateway

DHCP Server Setting

Go to **Basic Network > LAN & VLAN > DHCP Server** Tab.

The DHCP Server setting allows user to create and customize DHCP Server policies to assign IP Addresses to the devices on the local area network (LAN).

Create / Edit DHCP Server Policy

The gateway allows you to custom your DHCP Server Policy. If multiple LAN ports are available, you can define one policy for each LAN (or VLAN group), and it supports up to a maximum of 4 policy sets.

DHCP Server List												
Add Delete DHCP Client List												
DHCP Server Name	LAN IP Address	Subnet Mask	IP Pool	Lease Time	Domain Name	Primary DNS	Secondary DNS	Primary WINS	Secondary WINS	Gateway	Enable	Actions
DHCP 1	192.168.66.1	255.255.254.0	192.168.66.100-192.168.66.200	900		0.0.0.0	0.0.0.0	0.0.0.0	0.0.0.0	0.0.0.0	<input checked="" type="checkbox"/>	Edit Fixed Mapping

When **Add** button is applied, **DHCP Server Configuration** screen will appear.

DHCP Server Configuration	
Item	Setting
▶ DHCP Server Name	<input type="text" value="DHCP 2"/>
▶ LAN IP Address	<input type="text" value="192.168.2.1"/>
▶ Subnet Mask	<input type="text" value="255.255.255.0 (/24)"/> ▼
▶ IP Pool	Starting Address: <input type="text"/> Ending Address: <input type="text"/>
▶ Lease Time	<input type="text" value="86400"/> seconds
▶ Domain Name	<input type="text"/> (Optional)
▶ Primary DNS	<input type="text"/> (Optional)
▶ Secondary DNS	<input type="text"/> (Optional)
▶ Primary WINS	<input type="text"/> (Optional)
▶ Secondary WINS	<input type="text"/> (Optional)
▶ Gateway	<input type="text"/> (Optional)

5G NR M2M Gateway

DHCP Server Configuration		
Item	Value setting	Description
DHCP Server Name	1. String format can be any text 2. A Must filled setting	Enter a DHCP Server name. Enter a name that is easy for you to understand.
LAN IP Address	1. IPv4 format. 2. A Must filled setting	The LAN IP Address of this DHCP Server.
Subnet Mask	255.0.0.0 (/8) is set by default	The Subnet Mask of this DHCP Server.
IP Pool	1. IPv4 format. 2. A Must filled setting	The IP Pool of this DHCP Server. It composed of Starting Address entered in this field and Ending Address entered in this field.
Lease Time	1. Numeric string format. 2. A Must filled setting	The Lease Time of this DHCP Server. Value Range: 300 ~ 604800 seconds.
Domain Name	String format can be any text	The Domain Name of this DHCP Server.
Primary DNS	IPv4 format	The Primary DNS of this DHCP Server.
Secondary DNS	IPv4 format	The Secondary DNS of this DHCP Server.
Primary WINS	IPv4 format	The Primary WINS of this DHCP Server.
Secondary WINS	IPv4 format	The Secondary WINS of this DHCP Server.
Gateway	IPv4 format	The Gateway of this DHCP Server.
Server	The box is unchecked by default.	Click Enable box to activate this DHCP Server.
Save	N/A	Click the Save button to save the configuration
Undo	N/A	Click the Undo button to restore what you just configured back to the previous setting.
Back	N/A	When the Back button is clicked the screen will return to the DHCP Server Configuration page.

Create / Edit Mapping Rule List on DHCP Server

The gateway allows you to custom your Mapping Rule List on DHCP Server. It supports up to a maximum of 64 rule sets. When **Fix Mapping** button is applied, the **Mapping Rule List** screen will appear.

Mapping Rule List Add Delete ↑ ×			
MAC Address	IP Address	Enable	Actions

When **Add** button is applied, **Mapping Rule Configuration** screen will appear.

5G NR M2M Gateway

Mapping Rule Configuration	
Item	Setting
▶ MAC Address	<input type="text"/>
▶ IP Address	<input type="text"/>
▶ Rule	<input type="checkbox"/> Enable

Mapping Rule Configuration		
Item	Value setting	Description
MAC Address	1. MAC Address string format 2. A Must filled setting	The MAC Address of this mapping rule.
IP Address	1. IPv4 format. 2. A Must filled setting	The IP Address of this mapping rule.
Rule	The box is unchecked by default.	Click Enable box to activate this rule.
Save	N/A	Click the Save button to save the configuration
Undo	N/A	Click the Undo button to restore what you just configured back to the previous setting.
Back	N/A	When the Back button is clicked the screen will return to the DHCP Server Configuration page.

View / Copy DHCP Client List

When **DHCP Client List** button is applied, **DHCP Client List** screen will appear.

DHCP Client List Copy to Fixed Mapping					
LAN Interface	IP Address	Host Name	MAC Address	Remaining Lease Time	Actions
Ethernet	Dynamic /192.168.123.100	James-P45V	74:D0:2B:62:8D:42	00:49:07	<input type="checkbox"/> Select

DHCP Client List Copy to Fixed Mapping					
LAN Interface	IP Address	Host Name	MAC Address	Remaining Lease Time	Actions
					<input type="checkbox"/> Select

When the DHCP Client is selected and **Copy to Fixed Mapping** button is applied. The IP and MAC address of DHCP Client will apply to the Mapping Rule List on specific DHCP Server automatically.

Enable / Disable DHCP Server Options

The **DHCP Server Options** setting allows user to set **DHCP OPTIONS 66, 72, or 114**. Click the **Enable** button to activate the DHCP option function, and the DHCP Server will add the expected options in its sending out **DHCPOFFER** **DHCPACK** packages.

5G NR M2M Gateway

Option	Meaning	RFC
66	TFTP server name	[RFC 2132]
72	Default World Wide Web Server	[RFC 2132]
114	URL	[RFC 3679]

▲ ✕

Item	Setting
▶ DHCP Server Options	<input type="checkbox"/> Enable

Create / Edit DHCP Server Options

The gateway supports up to a maximum of 99 option settings.

▲ ✕

ID	Option Name	DHCP Server Select	Option Select	Type	Value	Enable	Actions
Add Delete							

When **Add/Edit** button is applied, **DHCP Server Option Configuration** screen will appear.

▲ ✕

Item	Setting
▶ Option Name	<input type="text" value="Option 1"/>
▶ DHCP Server Select	<input type="text" value="DHCP 1 ▼"/>
▶ Option Select	<input type="text" value="DHCP OPTION 66 ▼"/>
▶ Type	<input type="text" value="Single IP Address ▼"/>
▶ Value	<input type="text"/>
▶ Enable	<input type="checkbox"/> Enable

DHCP Server Option Configuration		
Item	Value setting	Description
Option Name	1. String format can be any text 2. A Must filled setting.	Enter a DHCP Server Option name. Enter a name that is easy for you to understand.
DHCP Server Select	Dropdown list of all available DHCP servers.	Choose the DHCP server this option should apply to.
Option Select	1. A Must filled setting. 2. Option 66 is selected by default.	Choose the specific option from the dropdown list. It can be Option 66, Option 72, Option 144, Option 42, Option 150, or Option 160. Option 42 for ntp server; Option 66 for tftp;

5G NR M2M Gateway

		Option 72 for www; Option 144 for url;		
Type	Dropdown list of DHCP server option value's type	Each different options has different value types.		
		66	Single IP Address	
			Single FQDN	
		72	IP Addresses List, separated by “,”	
		114	Single URL	
		42	IP Addresses List, separated by “,”	
		150	IP Addresses List, separated by “,”	
		160	Single IP Address	
		Single FQDN		
Value	<ol style="list-style-type: none"> IPv4 format FQDN format IP list URL format A Must filled setting 	Should conform to Type :		
			Type	Value
		66	Single IP Address	IPv4 format
			Single FQDN	FQDN format
		72	IP Addresses List, separated by “,”	IPv4 format, separated by “,”
	114	Single URL	URL format	
Enable	The box is unchecked by default.	Click Enable box to activate this setting.		
Save	NA	Click the Save button to save the setting.		
Undo	NA	When the Undo button is clicked the screen will return back with nothing changed.		

Create / Edit DHCP Relay

The gateway supports up to a maximum of 6 DHCP Relay configurations.

DHCP Relay Configuration List							
ID	Agent Name	LAN interface	WAN interface	Server IP	DHCP Relay Option 82	Enable	Actions

When **Add/Edit** button is applied, **DHCP Relay Configuration** screen will appear.

DHCP Relay Configuration	
Item	Setting
▶ Agent Name	<input type="text"/>
▶ LAN interface	LAN ▼
▶ WAN interface	WAN - 1 ▼
▶ Server IP	<input type="text"/>
▶ DHCP OPTION 82	<input type="checkbox"/>
▶ Enable	<input type="checkbox"/>

5G NR M2M Gateway

DHCP Relay Configuration		
Item	Value setting	Description
Agent Name	1. String format can be any text 2. A Must filled setting.	Enter a DHCP Relay name. Enter a name that is easy for you to understand. <i>Value Range:</i> 1~64 characters.
LAN Interface	1. A Must filled setting. 2. LAN is selected by default.	Choose a LAN Interface for the dropdown list to apply with the DHCP Relay function.
WAN Interface	1. A Must filled setting. 2. WAN-1 is selected by default.	Choose a WAN Interface for the dropdown list to apply with the DHCP Relay function. It can be the available WAN interface(s), and L2TP connection.
Server IP	1. A Must filled setting. 2. null by default.	Assign a DHCP Server IP Address that the gateway will relay the DHCP requests to the assigned DHCP server via specified WAN interface.
DHCP OPTION 82	The box is unchecked by default.	Click Enable box to activate DHCP OPTION 82 function. Option 82 is organized as a single DHCP option that contains circuit-ID information known by the relay agent. If the relayed DHCP server required the such information, you have to enable it, otherwise, just leave it as unchecked.
Enable	The box is unchecked by default.	Click Enable box to activate this setting.
Save	NA	Click the Save button to save the setting.
Undo	NA	When the Undo button is clicked the screen will return back with nothing changed.

5G NR M2M Gateway

2.3 WiFi

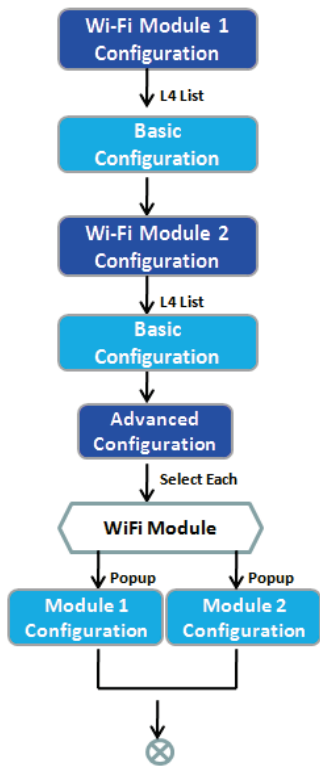

Basic Configuration								
Item	Setting							
▶ Operation Band	2.4G Single Band							
2.4G WiFi Configuration								
Item	Setting							
▶ WiFi Module	<input checked="" type="checkbox"/> Enable							
▶ Channel	Auto <input checked="" type="radio"/> By AP Numbers <input type="radio"/> By Less Interference							
▶ WiFi System	802.11b/g/n Mixed							
▶ WiFi Operation Mode	AP Router Mode							
▶ Green AP	<input type="checkbox"/> Enable							
▶ VAP Isolation	<input checked="" type="checkbox"/> Enable							
▶ Time Schedule	(0) Always							
2.4G VAP List								
Add Delete								
ID	VAP	SSID	Authentication	Encryption	STA Isolation	Broadcast SSID	Enable	Actions

The gateway provides WiFi interface for mobile devices or BYOD devices to connect for Internet/Intranet accessing. WiFi function is usually modularized design in a gateway, and there can be single or dual modules within a gateway. The WiFi system in the gateway complies with IEEE 802.11ac/11n/11g/11b standard in 2.4GHz or 5GHz single band or 2.4G/5GHz concurrent dual bands of operation. There are several wireless operation modes provided by this device. They are: **“AP Router Mode”**, **“WDS Only Mode”**, and **“WDS Hybrid Mode”**. You can choose the expected mode from the wireless operation mode list.

There are some sub-sections for you to configure the WiFi function, including “Basic Configuration” and “Advanced Configuration”. In Basic Configuration section, you have to finish almost all the settings for using the WiFi function. And the Advanced Configuration section provides more parameters for advanced user to fine tune the connectivity performance for the WiFi function.

5G NR M2M Gateway

2.3.1 WiFi Configuration

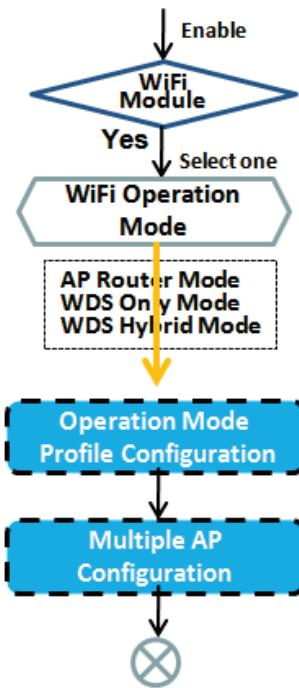

2.4G WiFi Configuration

Item	Setting
WiFi Module	<input checked="" type="checkbox"/> Enable
Channel	Auto <input type="checkbox"/> By AP Numbers <input type="checkbox"/> By Less Interference
WiFi System	802.11b/g/n Mixed
WiFi Operation Mode	AP Router Mode
Green AP	<input type="checkbox"/> Enable
VAP Isolation	<input checked="" type="checkbox"/> Enable
Time Schedule	(0) Always

2.4G VAP List Add Delete

ID	VAP	SSID	Authentication	Encryption	STA Isolation	Broadcast SSID	Enable	Actions
1	VAP 1	Staff_2.4G	WPA2-PSK	AES	<input type="checkbox"/>	<input checked="" type="checkbox"/>	<input checked="" type="checkbox"/>	Edit Select
2	VAP 2	default	Open	None	<input type="checkbox"/>	<input checked="" type="checkbox"/>	<input checked="" type="checkbox"/>	Edit Select

VAP Configuration

Item	Setting
VAP	VAP1
SSID	Staff_2.4G
Max. STA	<input type="checkbox"/> Enable
Authentication	WPA2-PSK
Encryption	AES
Preshared Key	1234567890
STA Isolation	<input checked="" type="checkbox"/>
Broadcast SSID	<input checked="" type="checkbox"/>
Enable	<input checked="" type="checkbox"/>

Due to optional module(s) and frequency band, you need to setup module one by one. For each module, you need to specify the operation mode, and then setup the virtual APs for wireless access.

In addition, if you configured the WiFi Uplink function in the **Basic Network > WAN & Uplink > Physical Interface** tab, the WiFi uplink function is activated. However, for the wireless LAN function of the module worked under WiFi uplink operation, it also provides AP Router function for local wireless clients to connect to wireless uplink network via the gateway.

Hereunder are the scenarios for each wireless operation mode, you can get how it works, and what is the difference among them. To connect your wireless devices with the wireless gateway, make sure your application scenario for WiFi network and choose the most adequate operation mode.

5G NR M2M Gateway

AP Router Mode

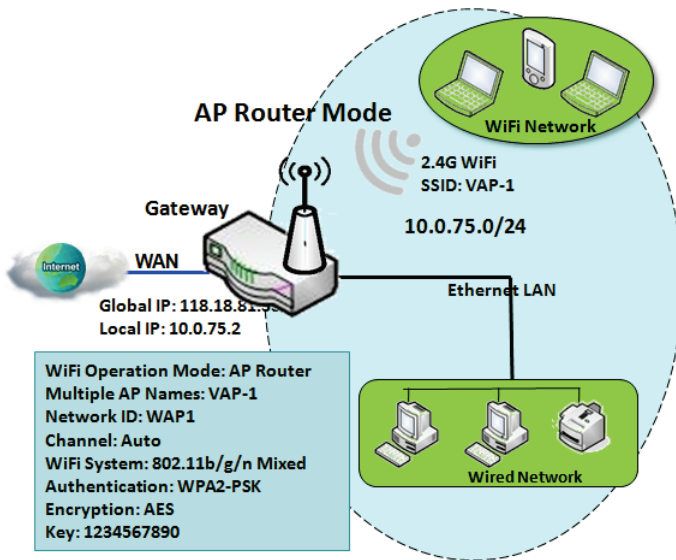

This mode allows you to get your wired and wireless devices connected to form the Intranet of the wireless gateway, and the Intranet will link to the Internet with NAT mechanism of the gateway. So, this gateway is working as a WiFi AP, but also a WiFi hotspot for Internet accessing service. It means local WiFi clients can associate to it, and go to Internet. With its NAT mechanism, all of wireless clients don't need to get public IP addresses from ISP.

WDS Only Mode

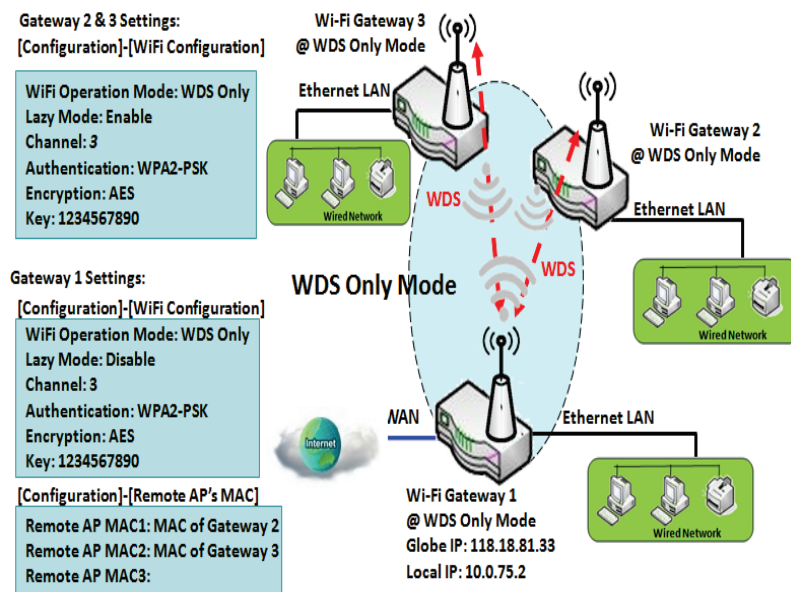

WDS (Wireless Distributed System) Only mode drives a WiFi gateway to be a bridge for its wired Intranet and a repeater to extend distance. You can use multiple WiFi gateways as a WiFi repeater chain with all gateways setup as "WDS Only" mode. All gateways can communicate with each other through WiFi. All wired client hosts within each gateway can also communicate each other in the scenario. Only one gateway within repeater chain can be DHCP server to provide IP for all wired client hosts of every gateway which being disabled DHCP server. This gateway can be NAT router to provide internet access

The diagram illustrates that there are two wireless gateways 2, 3 running at "WDS Only"

mode. They both use channel 3 to link to local Gateway 1 through WDS. Both gateways connected by WDS need to setup the remote AP MAC for each other. All client hosts under gateway 2, 3 can request IP address from the DHCP server at gateway 1. Besides, wireless Gateway 1 also execute the NAT mechanism for all client hosts Internet accessing.

5G NR M2M Gateway

WDS Hybrid Mode

Gateway 2 / AP 1 Settings:

[Configuration]-[WiFi Configuration]

WiFi Operation Mode: WDS Hybrid
 Lazy Mode: Enable
 Multiple AP Names: VAP1
 Network ID: Extended-WiFi
 Channel: same as Router 1
 Authentication: same as Router 1
 Encryption: same as Router 1
 Key: same as Router 1

Gateway 1 Settings:

[Configuration]-[WiFi Configuration]

WiFi Operation Mode: WDS Hybrid
 Lazy Mode: Disable
 Multiple AP Names: VAP1
 Network ID: Extended-WiFi
 Channel: 3
 Authentication: WPA2-PSK
 Encryption: AES
 Key: 1234567890

[Configuration]-[Remote AP's MAC]

Remote AP MAC1: MAC of Router 2
 Remote AP MAC2: MAC of AP 1
 Remote AP MAC3:

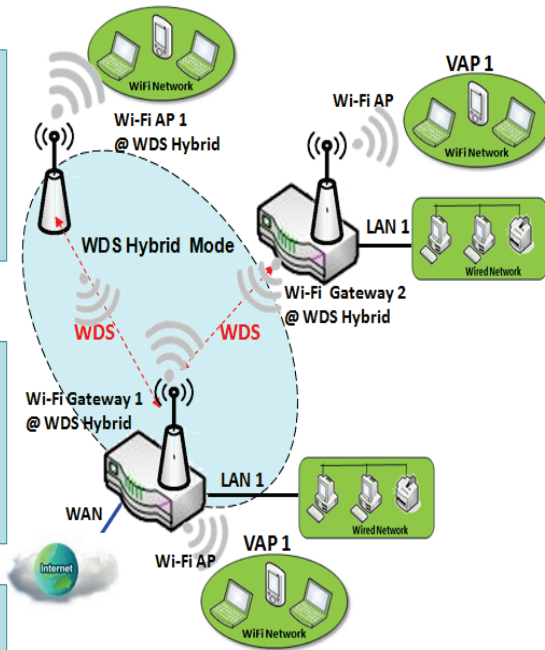

WDS hybrid mode includes both WDS and AP Router mode. WDS Hybrid mode can act as an access point for its WiFi Intranet and a WiFi bridge for its wired and WiFi Intranets at the same time. Users can thus use the features to build up a large wireless network in a large space like airports, hotels or campus.

The diagram illustrates Gateway 1, Gateway 2 and AP 1 connected by WDS. Each gateway has access point function for WiFi client access. Gateway 1 has DHCP server to assign IP to each client hosts. All gateways and AP are under WDS hybrid mode. To setup WDS hybrid mode, it need to fill all configuration items similar to that of AP-router and WDS modes.

Multiple VAPs

Gateway Settings:

WiFi Operation Mode: AP Router
 VAP1
 SSID: VAP-1
 Authentication: WPA2-PSK
 Encryption: TKIP
 Key: 1234567890
 VAP2
 SSID: VAP-2
 Authentication: WPA2-PSK
 Encryption: TKIP
 Key: 1234567890
 VAP3
 SSID: VAP-3
 Authentication: WPA2
 Encryption: TKIP
 RADIUS Server IP: 192.168.168.
 RADIUS Server Port: 1812
 RADIUS Shared Key

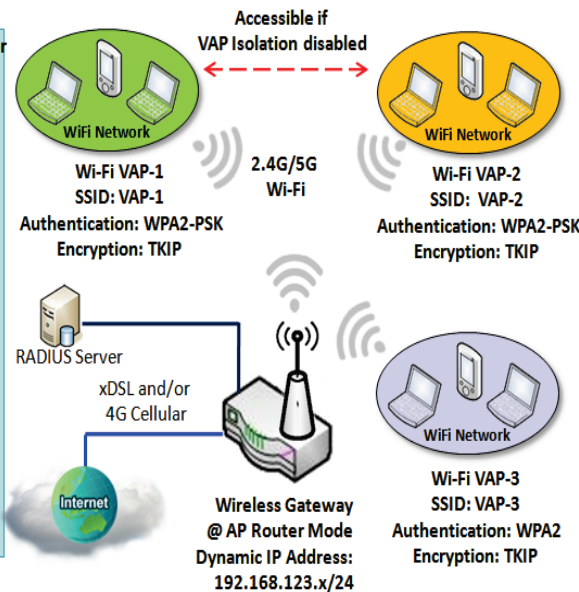

VAP (Virtual Access Point) is function to partition wireless network into multiple broadcast domains. It can simulate multiple APs in one physical AP. This wireless gateway supports up to 8 VAPs. For each VAP, you need to setup SSID, authentication and encryption to control Wi-Fi client access.

Besides, there is a VAP isolation option to manage the access among VAPs. You can allow or blocks communication for the wireless clients connected to different VAPs. As shown in the diagram, the clients in VAP-1 and VAP-2 can communicate to each other when VAP Isolation is disabled.

5G NR M2M Gateway

Wi-Fi Security - Authentication & Encryption

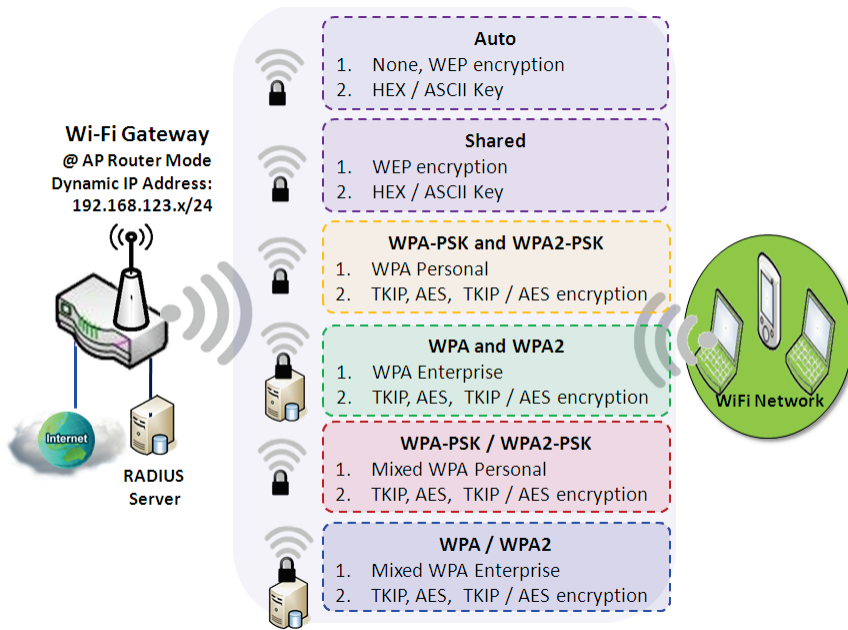

Wi-Fi security provides complete authentication and encryption mechanisms to enhance the data security while your data is transferred wirelessly over the air. The wireless gateway supports Shared, WPA-PSK / WPA2-PSK and WPA / WPA2 authentication. You can select one authentication scheme to validate the wireless clients while they are connecting to the AP. As to the data encryption, the gateway supports WEP, TKIP and AES. The selected encryption algorithm will be applied to the data while the wireless connection is established.

5G NR M2M Gateway

WiFi Configuration Setting

The WiFi configuration allows user to configure 2.4GHz or 5GHz WiFi settings.

Go to **Basic Network > WiFi > WiFi Module One** Tab. If the gateway is equipped with two WiFi modules, there will be another **WiFi Module Two**. You can do the similar configurations on both WiFi modules.

Basic Configuration

Basic Configuration	
Item	Setting
▶ Operation Band	2.4G Single Band ▾

Basic Configuration		
Item	Value setting	Description
Operation Band	A Must filled setting	Specify the intended operation band for the WiFi module. Basically, this setting is fixed and cannot be changed once the module is integrated into the product. However, there is some module with selectable band or DBDC bands for user to choose according to his network environment. Under such situation, you can specify which operation band is suitable for the application.

Configure WiFi Setting

2.4G WiFi Configuration	
Item	Setting
▶ WiFi Module	<input checked="" type="checkbox"/> Enable
▶ Channel	Auto ▾ <input checked="" type="radio"/> By AP Numbers <input type="radio"/> By Less Interference
▶ WiFi System	802.11b/g/n Mixed ▾
▶ WiFi Operation Mode	AP Router Mode ▾

Configuring Wi-Fi Settings		
Item	Value setting	Description
WiFi Module	The box is checked by default	Check the Enable box to activate WiFi function.
Channel	1. A Must filled setting. 2. Auto is selected by default.	Select a radio channel for the VAP. Each channel is corresponding to different radio band. The permissible channels depend on the Regulatory Domain . There are two available options when Auto is selected: <ul style="list-style-type: none">● By AP Numbers The channel will be selected according to AP numbers (The less, the better).● By Less Interference The channel will be selected according to interference. (The lower, the better).
WiFi System	A Must filled setting	Specify the preferred WiFi System. The dropdown list of WiFi system is based on

5G NR M2M Gateway

	<p>IEEE 802.11 standard.</p> <ul style="list-style-type: none"> ● 2.4G WiFi can select b, g and n only or mixed with each other. ● 5G WiFi can select a, n and ac only or mixed with each other.
WiFi Operation Mode	<p>Specify the WiFi Operation Mode according to your application. Go to the following table for AP Router Mode, WDS Only Mode, and WDS Hybrid Mode settings.</p> <p>Note: The available operation modes depend on the product specification. For a certain product, WDS related modes are only available in 2.4G WiFi system.</p>

In the following, the specific configuration description for each WiFi operation mode is given.

Note: If you configured the WiFi Uplink function in the **Basic Network > WAN & Uplink > Physical Interface** tab, the WiFi uplink function is activated. However, for the wireless LAN function of the module worked under WiFi uplink operation, the **WiFi Operation Mode** is fixed to **WiFi Uplink**, and also provides AP Router function for local wireless clients to connect to wireless uplink network via the gateway.

AP Router Mode [WiFi Uplink Mode] & VAPs Configuration

For the AP Router mode, or WiFi Uplink mode, the device not only supports **stations connection** but also the **router function**. The **WAN** port and the **NAT** function are **enabled**.

▶ WiFi Operation Mode	AP Router Mode ▾
▶ Green AP	<input type="checkbox"/> Enable
▶ VAP Isolation	<input checked="" type="checkbox"/> Enable
▶ Time Schedule	(0) Always ▾

AP Router Mode		
Item	Value setting	Description
Green AP	The box is unchecked by default.	Check the Enable box to activate Green AP function.
VAP Isolation	The box is checked by default.	Check the Enable box to activate this function. By default, the box is checked; it means that stations which associated to different VAPs cannot communicate with each other.
Profile	The box is unchecked by default.	Check the Enable box to enable the activate profile setting. Note: This setting is only available in WiFi Uplink operation mode.
Time Schedule	A Must filled setting	Apply a specific Time Schedule to this rule; otherwise leave it as (0) Always . If the dropdown list is empty ensure Time Schedule is pre-configured. Refer to Object Definition > Scheduling > Configuration tab.

2.4G VAP List								Add	Delete	↶	✕
ID	VAP	SSID	Authentication	Encryption	STA Isolation	Broadcast SSID	Enable	Actions			
1	VAP 1	DWM-3010-C159	WPA2-PSK	AES	<input type="checkbox"/>	<input checked="" type="checkbox"/>	<input checked="" type="checkbox"/>	Edit	<input type="checkbox"/>	Select	

5G NR M2M Gateway

By default, VAP 1 is enabled and security key is required to connect to the gateway wirelessly to enhance the security level and prevent unexpected access of un-authorized devices.

The default wifi key is printed on both the device label and the Security Card. It is created randomly and differs from devices. So, you can connected to the VAP1 (SSID: DWM-3010-XXXX) with the provided key.

However, it is strongly recommended that you have to change the security key to a easy-to-remember one by clicking the Edit button.

Click **Add / Edit** button in the VAP List screen to create or edit the settings for a VAP. A VAP Configuration screen will appear.

For VAP 1:

VAP Configuration	
Item	Setting
▶ VAP	VAP1
▶ SSID	DWM-3010-C159
▶ Max. STA	<input type="checkbox"/> Enable
▶ Authentication	WPA2-PSK
▶ Encryption	AES
▶ Preshared Key	1234567890
▶ STA Isolation	<input checked="" type="checkbox"/>
▶ Broadcast SSID	<input checked="" type="checkbox"/>
▶ Enable	<input checked="" type="checkbox"/>

For others:

VAP Configuration	
Item	Setting
▶ VAP	VAP2
▶ SSID	default
▶ Max. STA	<input type="checkbox"/> Enable
▶ Authentication	Open
▶ Encryption	None
▶ STA Isolation	<input type="checkbox"/>
▶ Broadcast SSID	<input type="checkbox"/>
▶ Enable	<input type="checkbox"/>

5G NR M2M Gateway

VAP Configuration		
Item	Value setting	Description
SS ID	1. String format : Any text	Enter the SSID for the VAP, and decide whether to broadcast the SSID or not. The SSID is used for identifying from another AP, and client stations will associate with AP according to SSID.
Max. STA	The box is unchecked by default.	Check this box and enter a limitation to limit the maximum number of client station. The box is unchecked by default. It means no special limitation on the number of connected STAs.
Authentication	1. A Must filled setting 2. VAP1: WPA2-PSK is selected be default; Others: Open is selected be default.	For security, there are several authentication methods supported. Client stations should provide the key when associate with this device.
		When Open is selected The check box named 802.1x shows up next to the dropdown list. <ul style="list-style-type: none"> ● 802.1x (The box is unchecked by default) When 802.1x is enabled, it means the client stations will be authenticated by RADIUS server. RADIUS Server IP (The default IP is 0.0.0.0) RADIUS Server Port (The default value is 1812) RADIUS Shared Key
		When Shared is selected The pre-shared WEP key should be set for authenticating.
		When Auto is selected The device will select Open or Shared by requesting of client automatically. The check box named 802.1x shows up next to the dropdown list. <ul style="list-style-type: none"> ● 802.1x (The box is unchecked by default) When 802.1x is enabled, it means the client stations will be authenticated by RADIUS server. RADIUS Server IP (The default IP is 0.0.0.0) RADIUS Server Port (The default value is 1812) RADIUS Shared Key
		When WPA or WPA2 is selected They are implementation of IEEE 802.11i. WPA only had implemented part of IEEE 802.11i, but owns the better compatibility . WPA2 had fully implemented 802.11i standard, and owns the highest security . <ul style="list-style-type: none"> ● RADIUS Server The client stations will be authenticated by RADIUS server. RADIUS Server IP (The default IP is 0.0.0.0) RADIUS Server Port (The default value is 1812) RADIUS Shared Key
		When WPA / WPA2 is selected It owns the same setting as WPA or WPA2 . The client stations can associate with this device via WPA or WPA2 .
		When WPA-PSK or WPA2-PSK is selected It owns the same encryption system as WPA or WPA2. The authentication uses pre-shared key instead of RADIUS server.
When WPA-PSK / WPA2-PSK is selected It owns the same setting as WPA-PSK or WPA2-PSK . The client stations can associate with this device via WPA-PSK or WPA2-PSK .		
Encryption	1. A Must filled setting. 2. VAP1: AES is selected be default; Others: None is selected be default.	Select a suitable encryption method and enter the required key(s). The available method in the dropdown list depends on the Authentication you selected. None It means that the device is open system without encrypting.

5G NR M2M Gateway

		<p>WEP Up to 4 WEP keys can be set, and you have to select one as current key. The key type can set to HEX or ASCII. If HEX is selected, the key should consist of (0 to 9) and (A to F). If ASCII is selected, the key should consist of ASCII table.</p> <p>TKIP TKIP was proposed instead of WEP without upgrading hardware. Enter a Pre-shared Key for it. The length of key is from 8 to 63 characters.</p> <p>AES The newest encryption system in WiFi, it also designed for the fast 802.11n high bitrates schemes. Enter a Pre-shared Key for it. The length of key is from 8 to 63 characters. You are recommended to use AES encryption instead of any others for security.</p> <p>TKIP / AES TKIP / AES mixed mode. It means that the client stations can associate with this device via TKIP or AES. Enter a Pre-shared Key for it. The length of key is from 8 to 63 characters.</p>
STA Isolation	VAP1: The box is checked by default; Others: unchecked by default.	Check the Enable box to activate this function. By default, the box is checked; it means that stations which associated to the same VAP cannot communicate with each other.
Broadcast SSID	VAP1: The box is checked by default; Others: unchecked by default.	Check the Enable box to activate this function. If the broadcast SSID option is enabled, it means the SSID will be broadcasted, and the stations can associate with this device by scanning SSID.
Enable	VAP1: The box is checked by default; Others: unchecked by default.	Check the Enable box to activate this VAP.
Save	N/A	Click the Save button to save the current configuration.
Undo	N/A	Click the Undo button to restore configuration to previous setting before saving.
Apply	N/A	Click the Apply button to apply the saved configuration.

5G NR M2M Gateway

WDS Only Mode

For the WDS Only mode, the device only bridges the connected wired clients to another WDS-enabled WiFi device which the device associated with. That is, it also means the no wireless clients stat can connect to this device while WDS Only Mode is selected.

WiFi Operation Mode	WDS Only Mode
Green AP	<input type="checkbox"/> Enable
Time Schedule	(0) Always
Scan Remote AP's MAC List	Scan
Remote AP MAC 1	<input type="text"/>
Remote AP MAC 2	<input type="text"/>
Remote AP MAC 3	<input type="text"/>
Remote AP MAC 4	<input type="text"/>

WDS Only Mode		
Item	Value setting	Description
Green AP	The box is unchecked by default.	Check the Enable box to activate Green AP function.
Time Schedule	A Must filled setting	Apply a specific Time Schedule to this rule; otherwise leave it as (0) Always . If the dropdown list is empty ensure Time Schedule is pre-configured. Refer to Object Definition > Scheduling > Configuration tab.
Scan Remote AP's MAC List	N/A	Press the Scan button to scan the spatial AP information, and then select one from the AP list, the MAC of selected AP will be auto filled in the following Remote AP MAC table.
Remote AP MAC 1~4	A Must filled setting	Enter the remote AP's MAC manually, or via auto-scan approach, The device will bridge the traffic to the remote AP when associated successfully.

2.4G VAP List								
ID	VAP	SSID	Authentication	Encryption	STA Isolation	Broadcast SSID	Enable	Actions
1	VAP 1	DWM-3010-C159	WPA2-PSK	AES	<input type="checkbox"/>	<input checked="" type="checkbox"/>	<input checked="" type="checkbox"/>	<input type="button" value="Edit"/> <input type="checkbox"/> Select

By default, VAP 1 is enabled and security key is required to connect to the gateway wirelessly to enhance the security level and prevent unexpected access of un-authorized devices.

The default wifi key is printed on both the device label and the Security Card. It is created randomly and differs from devices. So, you can connected to the VAP1 (SSID: DWM-3010-XXXX) with the provided key.

However, it is strongly recommended that you have to change the security key to a easy-to-remember one by clicking the Edit button.

5G NR M2M Gateway

Under **WDS Only** mode, only VAP1 is available for further specifying the required authentication and Encryption settings. Click **Edit** button in the VAP List screen and a VAP Configuration screen will appear for you to configure the required settings

VAP Configuration	
Item	Setting
▶ VAP	VAP1
▶ SSID	DWM-3010-C159
▶ Max. STA	<input type="checkbox"/> Enable
▶ Authentication	WPA2-PSK
▶ Encryption	AES
▶ Preshared Key	1234567890
▶ STA Isolation	<input checked="" type="checkbox"/>
▶ Broadcast SSID	<input checked="" type="checkbox"/>
▶ Enable	<input checked="" type="checkbox"/>

For the detail description about VAP configuration, please refer to the description stated in AP-Router section.

5G NR M2M Gateway

WDS Hybrid Mode

For the WDS Hybrid mode, the device bridges all the wired **LAN** and **WLAN** clients to another WDS or WDS hybrid enabled WiFi devices which the device associated with.

WiFi Operation Mode	WDS Hybrid Mode ▾
Lazy Mode	<input type="checkbox"/> Enable
Green AP	<input type="checkbox"/> Enable
VAP Isolation	<input checked="" type="checkbox"/> Enable
Time Schedule	(0) Always ▾
Scan Remote AP's MAC List	Scan
Remote AP MAC 1	<input type="text"/>
Remote AP MAC 2	<input type="text"/>
Remote AP MAC 3	<input type="text"/>
Remote AP MAC 4	<input type="text"/>

WDS Hybrid Mode		
Item	Value setting	Description
Lazy Mode	The box is checked by default.	Check the Enable box to activate this function. With the function been enabled, the device can auto-learn WDS peers without manually entering other AP's MAC address. But at least one of the APs has to fill remote AP MAC addresses.
Green AP	The box is unchecked by default.	Check the Enable box to activate Green AP function.
VAP Isolation	The box is checked by default.	Check the Enable box to activate this function. By default, the box is checked; it means that stations which associated to different VAPs cannot communicate with each other.
Time Schedule	A Must filled setting	Apply a specific Time Schedule to this rule; otherwise leave it as (0) Always . If the dropdown list is empty ensure Time Schedule is pre-configured. Refer to Object Definition > Scheduling > Configuration tab.
Scan Remote AP's MAC List	Available when Lazy Mode disabled.	Press the Scan button to scan the spatial AP information, and then select one from the AP list, the MAC of selected AP will be auto filled in the following Remote AP MAC table.
Remote AP MAC 1~4	Available when Lazy Mode disabled.	Enter the remote AP's MAC manually, or via auto-scan approach, The device will bridge the traffic to the remote AP when associated successfully.

2.4G VAP List								Add	Delete
ID	VAP	SSID	Authentication	Encryption	STA Isolation	Broadcast SSID	Enable	Actions	
1	VAP 1	DWM-3010-C159	WPA2-PSK	AES	<input type="checkbox"/>	<input checked="" type="checkbox"/>	<input checked="" type="checkbox"/>	Edit <input type="checkbox"/> Select	

By default, VAP 1 is enabled and security key is required to connect to the gateway wirelessly to enhance the security level and prevent unexpected access of un-authorized devices.

The default wifi key is printed on both the device label and the Security Card. It is created randomly and differs from devices. So, you can connected to the VAP1 (SSID: DWM-3010-XXXX) with the provided key.

5G NR M2M Gateway

However, it is strongly recommended that you have to change the security key to a easy-to-remember one by clicking the Edit button.

Under **WDS Hybrid** mode, the VAP function is available and you can further specifying the required VAP settings for connecting with wireless client devices.

Click **Add / Edit** button in the VAP List screen to create or edit the settings for a VAP. A VAP Configuration screen will appear.

For VAP 1:

VAP Configuration	
Item	Setting
▶ VAP	VAP1
▶ SSID	DWM-3010-C159
▶ Max. STA	<input type="checkbox"/> Enable
▶ Authentication	WPA2-PSK
▶ Encryption	AES
▶ Preshared Key	1234567890
▶ STA Isolation	<input checked="" type="checkbox"/>
▶ Broadcast SSID	<input checked="" type="checkbox"/>
▶ Enable	<input checked="" type="checkbox"/>

5G NR M2M Gateway

For others:

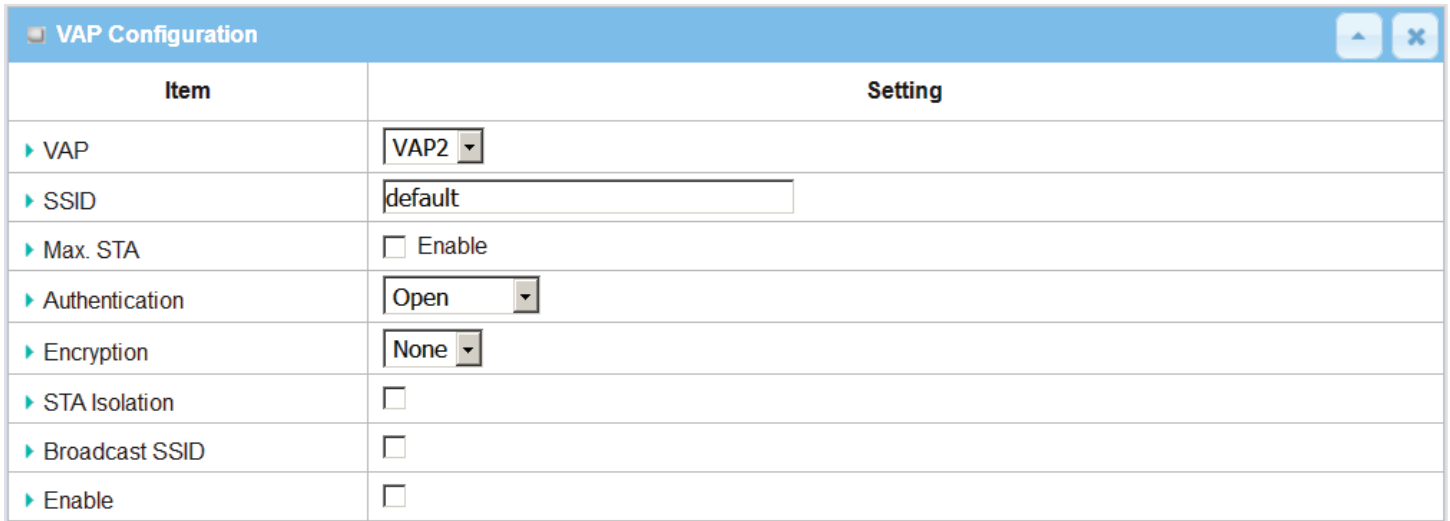
A screenshot of a configuration window titled "VAP Configuration". The window has a blue header bar with the title and two window control buttons (maximize and close). Below the header is a table with two columns: "Item" and "Setting". The table contains eight rows of configuration options, each with a right-pointing arrow icon to its left. The settings include dropdown menus for VAP, SSID, Authentication, and Encryption, and checkboxes for Max. STA, STA Isolation, Broadcast SSID, and Enable.

Item	Setting
▶ VAP	VAP2
▶ SSID	default
▶ Max. STA	<input type="checkbox"/> Enable
▶ Authentication	Open
▶ Encryption	None
▶ STA Isolation	<input type="checkbox"/>
▶ Broadcast SSID	<input type="checkbox"/>
▶ Enable	<input type="checkbox"/>

For the detail description about VAP configuration, please refer to the description stated in AP-Router section.

5G NR M2M Gateway

2.3.2 Wireless Client List

The **Wireless Client List** page shows the information of wireless clients which are associated with this device.

Go to **Basic Network > WiFi > Wireless Client List** Tab.

Select Target WiFi

Target WiFi	
Item	Setting
▶ Module Select	One ▾
▶ Operation Band	2.4G ▾
▶ Multiple AP Names	All ▾

Target Configuration		
Item	Value setting	Description
Module Select	A Must filled setting.	Select the WiFi module to check the information of connected clients. For those single WiFi module products, this option is hidden.
Operation Band	A Must filled setting.	Specify the intended operation band for the WiFi module. Basically, this setting is fixed and cannot be changed once the module is integrated into the product. However, there is some module with selectable band for user to choose according to his network environment. Under such situation, you can specify which operation band is suitable for the application.
Multiple AP Names	1. A Must filled setting. 2. All is selected by default.	Specify the VAP to show the associated clients information in the following Client List. By default, All VAP is selected.

Show Client List

The following Client List shows the information for wireless clients that is associated with the selected VAP(s).

Client List								
IP Address Configuration & Address	Host Name	MAC Address	Mode	Rate	RSSI0	RSSI1	Signal	Interface

Target Configuration		
Item	Value setting	Description
IP Address Configuration & Address	N/A	It shows the Client's IP address and the deriving method. Dynamic means the IP address is derived from a DHCP server. Static means the IP address is a fixed one that is self-filled by client.
Host Name	N/A	It shows the host name of client.
MAC Address	N/A	It shows the MAC address of client.
Mode	N/A	It shows what kind of Wi-Fi system the client used to associate with this device.
Rate	N/A	It shows the data rate between client and this device.

5G NR M2M Gateway

RSSI0, RSSI1	N/A	It shows the RX sensitivity (RSSI) value for each radio path.
Signal	N/A	The signal strength between client and this device.
Interface	N/A	It shows the VAP ID that the client associated with.
Refresh	N/A	Click the Refresh button to update the Client List immediately.

5G NR M2M Gateway

2.3.3 Advanced Configuration

This device provides advanced wireless configuration for professional user to optimize the wireless performance under the specific installation environment. Please note that if you are not familiar with the WiFi technology, just leave the advanced configuration with its default values, or the connectivity and performance may get worse with improper settings.

Go to **Basic Network > WiFi > Advanced Configuration** Tab.

Select Target WiFi

Target WiFi	
Item	Setting
▶ Module Select	One ▼
▶ Operation Band	2.4G ▼

Target Configuration		
Item	Value setting	Description
Module Select	A Must filled setting.	Select the WiFi module to check the information of connected clients. For those single WiFi module products, this option is hidden.
Operation Band	A Must filled setting.	Specify the intended operation band for the WiFi module. Basically, this setting is fixed and cannot be changed once the module is integrated into the product. However, there is some module with selectable band for user to choose according to his network environment.

Setup Advanced Configuration

Advanced Configuration	
Item	Setting
▶ Regulatory Domain	(36, 40, 44, 48, 52, 56, 60, 64, 149, 153, 157, 161, 165)
▶ Beacon Interval	<input type="text" value="100"/> Range: (1~1000 msec)
▶ DTIM Interval	<input type="text" value="3"/> Range: (1~255)
▶ RTS Threshold	<input type="text" value="2347"/> Range: (1~2347)
▶ Fragmentation	<input type="text" value="2346"/> Range: (256~2346)
▶ WMM	<input checked="" type="checkbox"/> Enable
▶ Short GI	<input type="text" value="400ns"/> ▼
▶ TX Rate	<input type="text" value="Best"/> ▼
▶ RF Bandwidth	<input type="text" value="Auto"/> ▼
▶ Transmit Power	<input type="text" value="100%"/> ▼

5G NR M2M Gateway

▶ 5G Band Steering	<input type="checkbox"/> Enable
▶ WIDS	<input type="checkbox"/> Enable
▶ Dynamic Frequency Selection	<input checked="" type="checkbox"/> Enable

▶ Associate RSSI Threshold	- <input type="text" value="0"/> Range: (0~100 dBm)
----------------------------	---

Advanced Configuration		
Item	Value setting	Description
Regulatory Domain	The default setting is according to where the product sale to	It limits the available radio channel of this device. The permissible channels depend on the Regulatory Domain .
Beacon Interval	1. A Must filled setting. 2. 100 is set by default	It shows the time interval between each beacon packet broadcasted. The beacon packet contains SSID , Channel ID and Security setting . Value Range: 1 ~ 1000 msec.
DTIM Interval	1. A Must filled setting. 2. 3 is set by default	A DTIM (Delivery Traffic Indication Message) is a countdown informing clients of the next window for listening to broadcast message. When the device has buffered broadcast message for associated client, it sends the next DTIM with a DTIM value. Value Range: 1 ~ 255.
RTS Threshold	1. A Must filled setting. 2. 2347 is set by default	RTS (Request to send) Threshold means when the packet size is over the setting value, then active RTS technique. RTS/CTS is a collision avoidance technique. It means RTS never activated when the threshold is set to 2347 . Value Range: 1 ~ 2347.
Fragmentation	1. A Must filled setting. 2. 2346 is set by default	Wireless frames can be divided into smaller units (fragments) to improve performance in the presence of RF interference at the limits of RF coverage. Value Range: 256 ~ 2346.
WMM	The box is checked by default	WMM (WiFi Multimedia) can help control latency and jitter when transmitting multimedia content over a wireless connection.
Short GI	By default 400ns is selected	Short GI (Guard Interval) is defined to set the sending interval between each packet. Note that lower Short GI could increase not only the transition rate but also error rate .
TX Rate	By default Best is selected	It means the data transition rate . When Best is selected, the device will choose a proper data rate according to signal strength .
RF Bandwidth	By default Auto is selected	The setting of RF bandwidth limits the maximum data rate.
Transmit Power	By default 100% is selected	Normally the wireless transmitter operates at 100% power. By setting the transmit power to control the WiFi coverage .
5G Band Steering	The box is unchecked by default	When the client station associate with 2.4G WiFi, the device will send the client to 5G WiFi automatically if the client is available on accessing this 5G WiFi band. This option is only available on the module that supports 5GHz band.
WIDS	The box is unchecked by default	The WIDS (Wireless Intrusion Detection System) will analyze all packets and make a statistic table in WiFi status. Go to Status > Basic Network > WiFi tab for detailed WIDS status.
Dynamic Frequency Selection	The box is checked by default	Dynamic Frequency Selection (DFS) is a legally required feature for all WiFi devices that share the 5 GHz band with radar. DFS enables a gateway to detect radar signals and switch their operating frequency to prevent interference. This process ensures that radar systems send and receive accurate information.

5G NR M2M Gateway

		Note: Dynamic Frequency Selection (DFS) option is only available for the WiFi module with 5GHz radio.
Associate RSSI Threshold	1. A Must filled setting. 2. 0 is set by default	Specify a connection threshold for the RSSI value. If the RSSI of the WiFi client is less than the threshold, it would be rejected to associate with the AP. And if the average RSSI value while data transmission is less than the threshold, the connection would be disconnected directly. The default value 0 means disable the RSSI threshold checking function. <u>Value Range:</u> 0 ~ -100 dBm.
Save	N/A	Click the Save button to save the current configuration.
Undo	N/A	Click the Undo button to restore configuration to previous setting before saving.

5G NR M2M Gateway

2.4 IPv6

The growth of the Internet has created a need for more addresses than are possible with IPv4. IPv6 (Internet Protocol version 6) is a version of the Internet Protocol (IP) intended to succeed IPv4, which is the protocol currently used to direct almost all Internet traffic. IPv6 also implements additional features not present in IPv4. It simplifies aspects of address assignment (stateless address auto-configuration), network renumbering and router announcements when changing Internet connectivity providers.

2.4.1 IPv6 Configuration

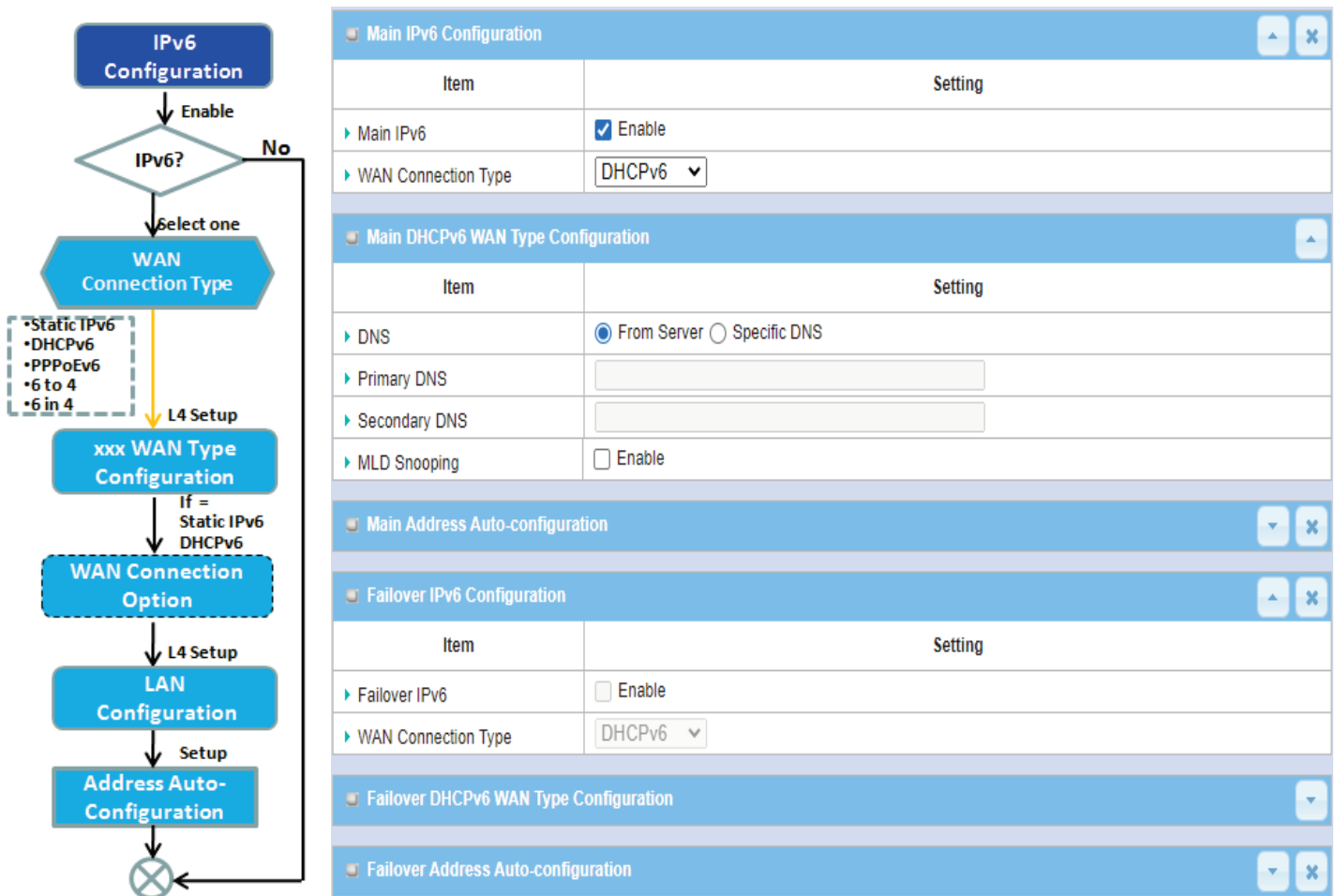

The **IPv6 Configuration** setting allows user to set the IPv6 connection type to access the IPv6 network. This gateway supports various types of IPv6 connection, including **Static IPv6**, **DHCPv6**, and **PPPoEv6**

Note: The available WAN connection types can be different, depending on the Interface type of WAN.

5G NR M2M Gateway

IPv6 WAN Connection Type

Static IPv6

Static IPv6 does the same function as static IPv4. The static IPv6 provides manual setting of IPv6 address, IPv6 default gateway address, and IPv6 DNS.

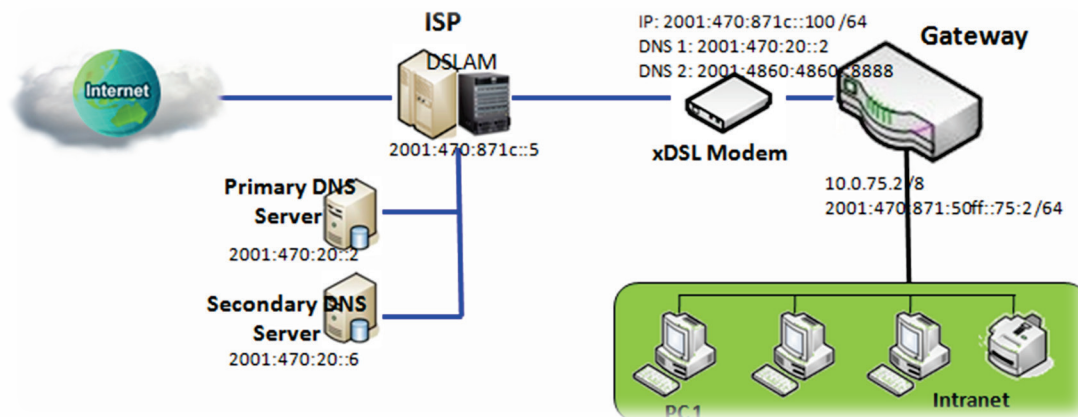

Above diagram depicts the IPv6 IP addressing, type in the information provided by your ISP to setup the IPv6 network.

DHCPv6

DHCP in IPv6 does the same function as DHCP in IPv4. The DHCP server sends IP address, DNS server addresses and other possible data to the DHCP client to configure automatically. The server also sends a lease time of the address and time to re-contact the server for IPv6 address renewal. The client has then to resend a request to renew the IPv6 address.

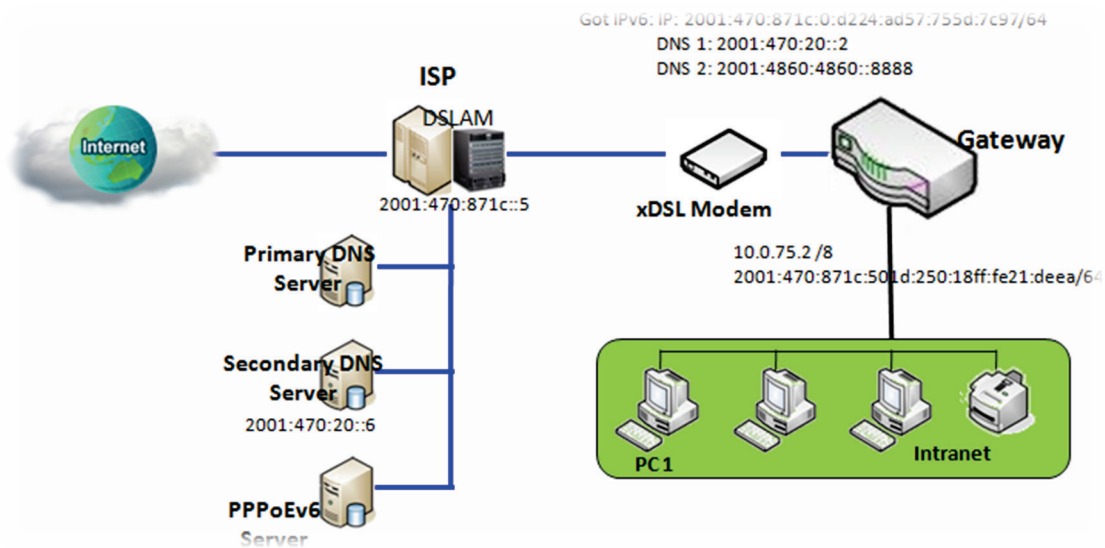

Above diagram depicts DHCP IPv6 IP addressing, the DHCPv6 server on the ISP side assigns IPv6 address, IPv6 default gateway address, and IPv6 DNS to client host's automatically.

5G NR M2M Gateway

PPPoEv6

PPPoEv6 in IPv6 does the same function as PPPoE in IPv4. The PPPoEv6 server provides configuration parameters based on PPPoEv6 client request. When PPPoEv6 server gets client request and successfully authenticates it, the server sends IP address, DNS server addresses and other required parameters to automatically configure the client.

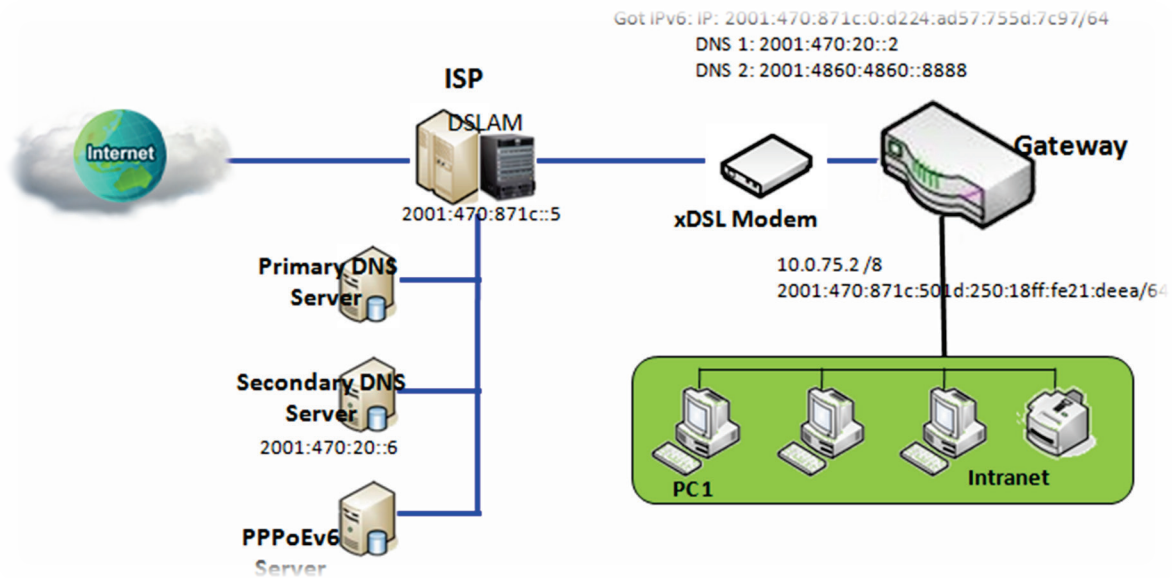

The diagram above depicts the IPv6 addressing through PPPoE, PPPoEv6 server (DSLAM) on the ISP side provides IPv6 configuration upon receiving PPPoEv6 client request. When PPPoEv6 server gets client request and successfully authenticates it, the server sends IP address, DNS server addresses and other required parameters to automatically configure the client.

5G NR M2M Gateway

IPv6 Configuration Setting

Go to **Basic Network > IPv6 > Configuration** Tab.

The **IPv6 Configuration** setting allows user to set the IPv6 connection type to access the IPv6 network.

The device provides two types of IPv6 connections, one is for the Main IPv6 connection, and the other is for Failover IPv6 connection. You have to configure the Main IPv6 related configurations first, and the configure the Failover parts if required.

Main IPv6 Configuration	
Item	Setting
▶ Main IPv6	<input type="checkbox"/> Enable
▶ WAN Connection Type	DHCPv6 ▼

IPv6 Configuration		
Item	Value setting	Description
IPv6	The box is unchecked by default,	Check the Enable box to activate the Main IPv6 function.
WAN Connection Type	1. A Must filled setting 2. DHCPv6 is selected by default	<p>Define the selected IPv6 WAN Connection Type to establish the IPv6 connectivity via Main / Failover WAN Interface. The available WAN connection type are Static IPv6, DHCPv6, PPPoEv6, or just IPv6.</p> <p>Select Static IPv6 when your ISP provides you with a set IPv6 addresses. Select DHCPv6 when your ISP provides you with DHCPv6 services. Select PPPoEv6 when your ISP provides you with PPPoEv6 account settings. Select IPv6 when your ISP provides you with IPv6 (DHCPv6) services.</p> <p>Note: The available WAN connection types can be different, depending on the Interface type of corresponding WAN.</p>

Static IPv6 WAN Type Configuration

5G NR M2M Gateway

Main Static IPv6 WAN Type Configuration	
Item	Setting
▶ IPv6 Address	<input type="text"/>
▶ Subnet Prefix Length	<input type="text"/>
▶ Default Gateway	<input type="text"/>
▶ Primary DNS	<input type="text"/>
▶ Secondary DNS	<input type="text"/>
▶ MLD Snooping	<input type="checkbox"/> Enable

Static IPv6 WAN Type Configuration		
Item	Value setting	Description
IPv6 Address	A Must filled setting	Enter the WAN IPv6 Address for the router.
Subnet Prefix Length	A Must filled setting	Enter the WAN Subnet Prefix Length for the router.
Default Gateway	A Must filled setting	Enter the WAN Default Gateway IPv6 address.
Primary DNS	An optional setting	Enter the WAN primary DNS Server .
Secondary DNS	An optional setting	Enter the WAN secondary DNS Server .
MLD Snooping	The box is unchecked by default	Enable/Disable the MLD Snooping function

DHCPv6 WAN Type Configuration

Main DHCPv6 WAN Type Configuration	
Item	Setting
▶ DNS	<input checked="" type="radio"/> From Server <input type="radio"/> Specific DNS
▶ Primary DNS	<input type="text"/>
▶ Secondary DNS	<input type="text"/>
▶ MLD Snooping	<input type="checkbox"/> Enable

DHCPv6 WAN Type Configuration		
Item	Value setting	Description
DNS	The option [From Server] is selected by default	Select the [Specific DNS] option to active Primary DNS and Secondary DNS. Then fill the DNS information.
Primary DNS	Can not modified by default	Enter the WAN primary DNS Server .
Secondary DNS	Can not modified by default	Enter the WAN secondary DNS Server .
MLD	The box is unchecked by default	Enable/Disable the MLD Snooping function

5G NR M2M Gateway

5G NR M2M Gateway

PPPoEv6 WAN Type Configuration

Main PPPoEv6 WAN Type Configuration	
Item	Setting
▶ Account	<input type="text"/>
▶ Password	<input type="text"/>
▶ Service Name	<input type="text"/>
▶ Connection Control	Auto-reconnect (Always on)
▶ MTU	<input type="text"/>
▶ MLD Snooping	<input type="checkbox"/> Enable

PPPoEv6 WAN Type Configuration		
Item	Value setting	Description
Account	A Must filled setting	Enter the Account for setting up PPPoEv6 connection. If you want more information, please contact your ISP. Value Range: 0 ~ 45 characters.
Password	A Must filled setting	Enter the Password for setting up PPPoEv6 connection. If you want more information, please contact your ISP.
Service Name	A Must filled setting/Option	Enter the Service Name for setting up PPPoEv6 connection. If you want more information, please contact your ISP. Value Range: 0 ~ 45 characters.
Connection Control	Fixed value	The value is Auto-reconnect(Always on) .
MTU	A Must filled setting	Enter the MTU for setting up PPPoEv6 connection. If you want more information, please contact your ISP. Value Range: 1280 ~ 1492.
MLD Snooping	The box is unchecked by default	Enable/Disable the MLD Snooping function

Address Auto-configuration

Main Address Auto-configuration	
Item	Setting
▶ Auto-configuration	<input checked="" type="checkbox"/> Enable
▶ Auto-configuration Type	Stateless ▼
▶ Router Advertisement Lifetime	<input type="text" value="200"/> (seconds)

Address Auto-configuration		
Item	Value setting	Description
Auto-configuration	The box is unchecked by default	Check to enable the Auto configuration feature.

5G NR M2M Gateway

Auto-configuration Type

1. Only can be selected when **Auto-configuration** enabled
2. Stateless is selected by default

Define the selected IPv6 WAN Connection Type to establish the IPv6 connectivity.

Select **Stateless** to manage the Local Area Network to be SLAAC + RDNSS
Router Advertisement Lifetime (A Must filled setting): Enter the Router Advertisement Lifetime (in seconds). 200 is set by default.

Value Range: 0 ~ 65535.

Select **Stateful** to manage the Local Area Network to be **Stateful (DHCPv6)**.
IPv6 Address Range (Start) (A Must filled setting): Enter the start IPv6 Address for the DHCPv6 range for your local computers. 0100 is set by default.

Value Range: 0001 ~ FFFF.

IPv6 Address Range (End) (A Must filled setting): Enter the end IPv6 Address for the DHCPv6 range for your local computers. 0200 is set by default.

Value Range: 0001 ~ FFFF.

IPv6 Address Lifetime (A Must filled setting): Enter the DHCPv6 lifetime for your local computers. 36000 is set by default.

Value Range: 0 ~ 65535.

If above settings are configured, click the **save button** to save the configuration.

5G NR M2M Gateway

2.5 Port Forwarding

Network address translation (NAT) is a methodology of remapping one IP address space into another by modifying network address information in Internet Protocol (IP) datagram packet headers while they are in transit across a traffic routing device. The technique was originally used for ease of rerouting traffic in IP networks without renumbering every host. It has become a popular and essential tool in conserving global address space allocations in face of IPv4 address exhaustion. The product you purchased embeds and activates the NAT function. You also can disable the NAT function in **[Basic Network]-[WAN & Uplink]-[Internet Setup]-[WAN Type Configuration]** page.

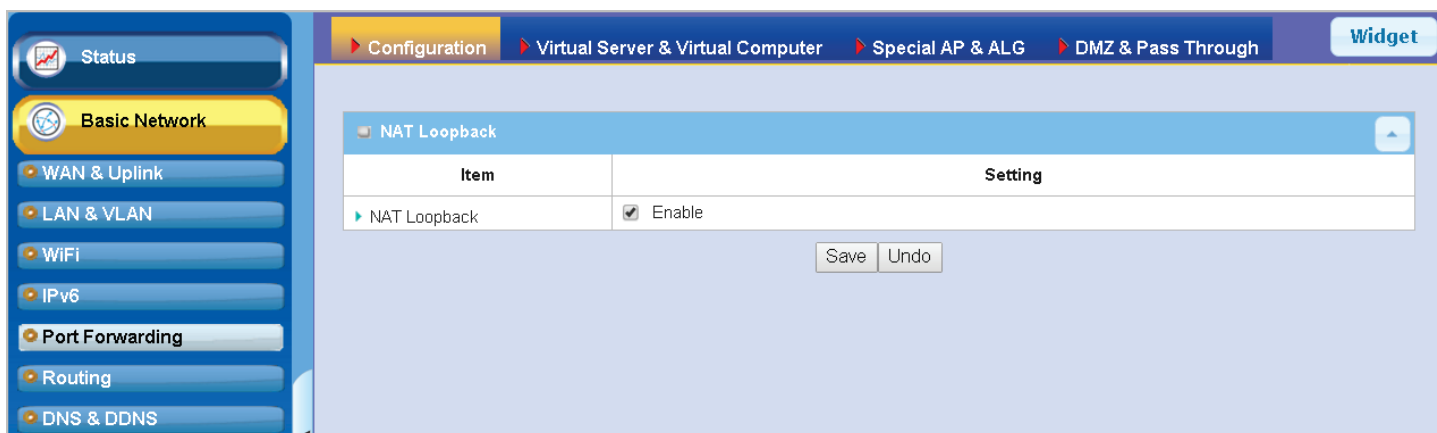

Usually all local hosts or servers behind corporate gateway are protected by NAT firewall. NAT firewall will filter out unrecognized packets to protect your Intranet. So, all local hosts are invisible to the outside world. Port forwarding or port mapping is function that redirects a communication request from one address and port number combination to assigned one. This technique is most commonly used to make services on a host residing on a protected or masqueraded (internal) network available to hosts on the opposite side of the gateway (external network), by remapping the destination IP address and port number

5G NR M2M Gateway

2.5.1 Configuration

[NAT Loopback](#)

This feature allows you to access the WAN global IP address from your inside NAT local network. It is useful when you run a server inside your network. For example, if you set a mail server at LAN side, your local devices can access this mail server through gateway's global IP address when enable NAT loopback feature. On either side are you in accessing the email server, at the LAN side or at the WAN side, you don't need to change the IP address of the mail server.

[Configuration Setting](#)

Go to **Basic Network > Port Forwarding > Configuration** tab.

The NAT Loopback allows user to access the WAN IP address from inside your local network.

Enable NAT Loopback

NAT Loopback	
Item	Setting
▶ NAT Loopback	<input checked="" type="checkbox"/> Enable

Configuration		
Item	Value setting	Description
NAT Loopback	The box is checked by default	Check the Enable box to activate this NAT function
Save	N/A	Click the Save button to save the settings.
Undo	N/A	Click the Undo button to cancel the settings

5G NR M2M Gateway

2.5.2 Virtual Server & Virtual Computer

The screenshot displays the configuration interface for the gateway, divided into three main sections:

- Configuration:** A table with two columns: 'Item' and 'Setting'.

Item	Setting
Virtual Server	<input type="checkbox"/> Enable
Virtual Computer	<input checked="" type="checkbox"/> Enable
- Virtual Server List:** A table with columns: ID, WAN Interface, Server IP, Source IP, Protocol, Public Port, Private Port, Time Schedule, Enable, and Actions. It includes 'Add' and 'Delete' buttons.
- Virtual Computer List:** A table with columns: ID, Global IP, Local IP, Enable, and Actions. It includes 'Add' and 'Delete' buttons.

There are some important Port Forwarding functions implemented within the gateway, including "Virtual Server", "NAT loopback" and "Virtual Computer".

It is necessary for cooperate staffs who travel outside and want to access various servers behind office gateway. You can set up those servers by using "Virtual Server" feature. After trip, if want to access those servers from LAN side by global IP, without change original setting, NAT Loopback can achieve it.

"Virtual computer" is a host behind NAT gateway whose IP address is a global one and is visible to the outside world. Since it is behind NAT, it is protected by gateway firewall. To configure Virtual Computer, you just have to map the local IP of the virtual computer to a global IP.

5G NR M2M Gateway

Virtual Server & NAT Loopback

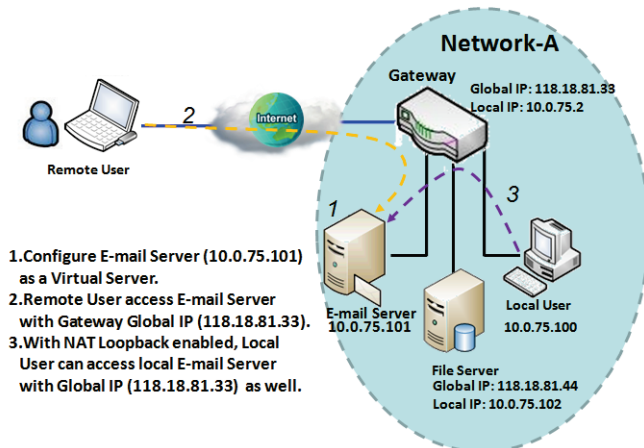

"Virtual Server" allows you to access servers with the global IP address or FQDN of the gateway as if they are servers existed in the Internet. But in fact, these servers are located in the Intranet and are physically behind the gateway. The gateway serves the service requests by port forwarding the requests to the LAN servers and transfers the replies from LAN servers to the requester on the WAN side. As shown in example, an E-mail virtual server is defined to be located at a server with IP address 10.0.75.101 in the Intranet of Network-A, including SMTP service port 25 and POP3 service port 110. So, the remote user can access the E-mail server with the gateway's global

IP 118.18.81.33 from its WAN side. But the real E-mail server is located at LAN side and the gateway is the port forwarder for E-mail service.

NAT Loopback allows you to access the WAN global IP address from your inside NAT local network. It is useful when you run a server inside your network. For example, if you set a mail server at LAN side, your local devices can access this mail server through gateway's global IP address when enable NAT loopback feature. On either side are you in accessing the email server, at the LAN side or at the WAN side, you don't need to change the IP address of the mail server.

Virtual Computer

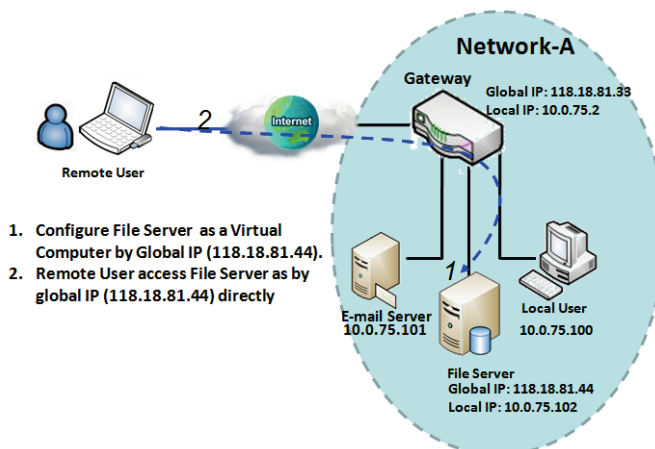

"Virtual Computer" allows you to assign LAN hosts to global IP addresses, so that they can be visible to outside world. While so, they are also protected by the gateway firewall as being client hosts in the Intranet. For example, if you set a FTP file server at LAN side with local IP address 10.0.75.102 and global IP address 118.18.82.44, a remote user can access the file server while it is hidden behind the NAT gateway. That is because the gateway takes care of all accessing to the IP address 118.18.82.44, including to forward the access requests to the file server and to send the replies from the server to outside world.

5G NR M2M Gateway

Virtual Server & Virtual Computer Setting

Go to **Basic Network > Port Forwarding > Virtual Server & Virtual Computer** tab.

Enable Virtual Server and Virtual Computer

Configuration	
Item	Setting
▶ Virtual Server	<input type="checkbox"/> Enable
▶ Virtual Computer	<input checked="" type="checkbox"/> Enable

Configuration Item	Value setting	Description
Virtual Server	The box is unchecked by default	Check the Enable box to activate this port forwarding function
Virtual Computer	The box is checked by default	Check the Enable box to activate this port forwarding function
Save	N/A	Click the Save button to save the settings.
Undo	N/A	Click the Undo button to cancel the settings.

Create / Edit Virtual Server

The gateway allows you to custom your Virtual Server rules. It supports up to a maximum of 20 rule-based Virtual Server sets.

Virtual Server List Add Delete									
ID	WAN Interface	Server IP	Source IP	Protocol	Public Port	Private Port	Time Schedule	Enable	Actions

When **Add** button is applied, **Virtual Server Rule Configuration** screen will appear.

5G NR M2M Gateway

Virtual Server Rule Configuration	
Item	Setting
▶ WAN Interface	<input checked="" type="checkbox"/> All <input type="checkbox"/> WAN-1 <input type="checkbox"/> WAN-2 <input type="checkbox"/> WAN-3
▶ Server IP	<input type="text"/>
▶ Source IP	Any ▼
▶ Protocol	TCP(6) & UDP(17) ▼
▶ Public Port	Single Port ▼ <input type="text"/>
▶ Private Port	Single Port ▼ <input type="text"/>
▶ Time Schedule	(0) Always ▼
▶ Rule	<input type="checkbox"/> Enable

Virtual Server Rule Configuration		
Item	Value setting	Description
WAN Interface	<ol style="list-style-type: none"> 1. A Must filled setting 2. Default is ALL. 	<p>Define the selected interface to be the packet-entering interface of the gateway.</p> <p>If the packets to be filtered are coming from WAN-x then select WAN-x for this field.</p> <p>Select ALL for packets coming into the gateway from any interface. It can be selected WAN-x box when WAN-x enabled.</p> <p>Note: The available check boxes (WAN-1 ~ WAN-4) depend on the number of WAN interfaces for the product.</p>
Server IP	A Must filled setting	This field is to specify the IP address of the interface selected in the WAN Interface setting above.
Source IP	<ol style="list-style-type: none"> 1. A Must filled setting 2. By default Any is selected 	<p>This field is to specify the Source IP address.</p> <p>Select Any to allow the access coming from any IP addresses.</p> <p>Select Specific IP Address to allow the access coming from an IP address.</p> <p>Select IP Range to allow the access coming from a specified range of IP address.</p>
Protocol	<ol style="list-style-type: none"> 1. A Must filled setting 2. TCP & UDP is selected by default. 	<p>When "ICMPv4" is selected It means the option "Protocol" of packet filter rule is ICMPv4. Apply Time Schedule to this rule, otherwise leave it as Always. (refer to Scheduling setting under Object Definition) Then check Enable box to enable this rule.</p> <p>When "TCP" is selected It means the option "Protocol" of packet filter rule is TCP. Public Port selected a predefined port from Well-known Service, and Private Port is the same with Public Port number. Public Port is selected Single Port and specify a port number, and Private Port can be set a Single Port number. Public Port is selected Port Range and specify a port range, and Private Port can be selected Single Port or Port Range. <u>Value Range:</u> 1 ~ 65535 for Public Port, Private Port.</p>

5G NR M2M Gateway

When **“UDP”** is selected
 It means the option “Protocol” of packet filter rule is UDP.
Public Port selected a predefined port from **Well-known Service**, and **Private Port** is the same with **Public Port** number.
Public Port is selected **Single Port** and specify a port number, and **Private Port** can be set a **Single Port** number.
Public Port is selected **Port Range** and specify a port range, and **Private Port** can be selected **Single Port** or **Port Range**.
Value Range: 1 ~ 65535 for Public Port, Private Port.

When **“TCP & UDP”** is selected
 It means the option “Protocol” of packet filter rule is TCP and UDP.
Public Port selected a predefined port from **Well-known Service**, and **Private Port** is the same with **Public Port** number.
Public Port is selected **Single Port** and specify a port number, and **Private Port** can be set a **Single Port** number.
Public Port is selected **Port Range** and specify a port range, and **Private Port** can be selected **Single Port** or **Port Range**.
Value Range: 1 ~ 65535 for Public Port, Private Port.

When **“GRE”** is selected
 It means the option “Protocol” of packet filter rule is GRE.

When **“ESP”** is selected
 It means the option “Protocol” of packet filter rule is ESP.

When **“SCTP”** is selected
 It means the option “Protocol” of packet filter rule is SCTP.

When **“User-defined”** is selected
 It means the option “Protocol” of packet filter rule is User-defined.
 For **Protocol Number**, enter a port number.

Time Schedule	1. An optional filled setting 2. (0) Always Is selected by default.	Apply Time Schedule to this rule; otherwise leave it as (0) Always. (refer to Scheduling setting under Object Definition)
Rule	1. An optional filled setting 2. The box is unchecked by default.	Check the Enable box to activate the rule.
Save	N/A	Click the Save button to save the settings.
Undo	N/A	Click the X button to cancel the settings and return to previous page.

5G NR M2M Gateway

Create / Edit Virtual Computer

The gateway allows you to custom your Virtual Computer rules. It supports up to a maximum of 20 rule-based Virtual Computer sets.

Virtual Computer List				
ID	Global IP	Local IP	Enable	Actions

When **Add** button is applied, **Virtual Computer Rule Configuration** screen will appear.

Virtual Computer Rule Configuration		
Global IP	Local IP	Enable
<input type="text"/>	<input type="text"/>	<input type="checkbox"/>

Virtual Computer Rule Configuration		
Item	Value setting	Description
Global IP	A Must filled setting	This field is to specify the IP address of the WAN IP.
Local IP	A Must filled setting	This field is to specify the IP address of the LAN IP.
Enable	N/A	Then check Enable box to enable this rule.
Save	N/A	Click the Save button to save the settings.

5G NR M2M Gateway

2.5.3 DMZ & Pass Through

DMZ (De Militarized Zone) Host is a host that is exposed to the Internet cyberspace but still within the protection of firewall by gateway device. So, the function allows a computer to execute 2-way communication for Internet games, Video conferencing, Internet telephony and other special applications. In some cases when a specific application is blocked by NAT mechanism, you can indicate that LAN computer as a DMZ host to solve this problem.

The DMZ function allows you to ask the gateway pass through all normal packets to the DMZ host behind the NAT gateway only when these packets are not expected to receive by applications in the gateway or by other client hosts in the Intranet. Certainly, the DMZ host is also protected by the gateway firewall. Activate the feature and specify the DMZ host with a host in the Intranet when needed.

Item	Setting
DMZ	<input checked="" type="checkbox"/> Enable <input checked="" type="checkbox"/> All <input type="checkbox"/> WAN-1 <input type="checkbox"/> WAN-2 <input type="checkbox"/> WAN-3 <input type="checkbox"/> WAN-4 DMZ Host: <input type="text" value="10.0.75.100"/>
Pass Through Enable	<input checked="" type="checkbox"/> IPSec <input checked="" type="checkbox"/> PPTP <input checked="" type="checkbox"/> L2TP

DMZ Scenario

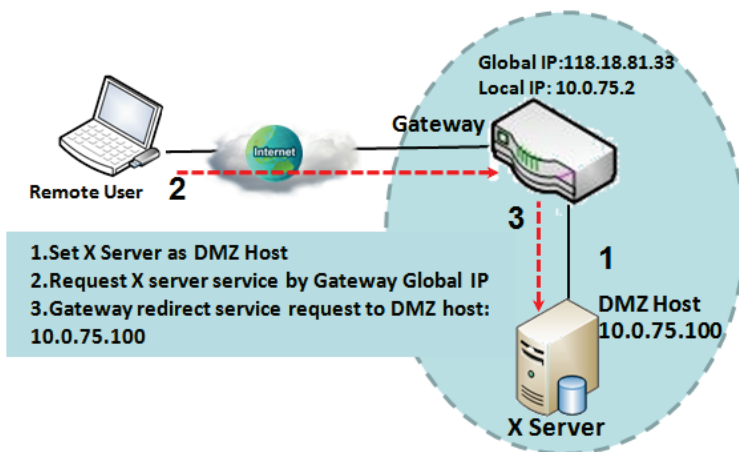

When the network administrator wants to set up some service daemons in a host behind NAT gateway to allow remote users request for services from server actively, you just have to configure this host as DMZ Host. As shown in the diagram, there is an X server installed as DMZ host, whose IP address is 10.0.75.100. Then, remote user can request services from X server just as it is provided by the gateway whose global IP address is 118.18.81.33. The gateway will forward those packets, not belonging to any configured virtual server or applications, directly to the DMZ host.

5G NR M2M Gateway

VPN Pass through Scenario

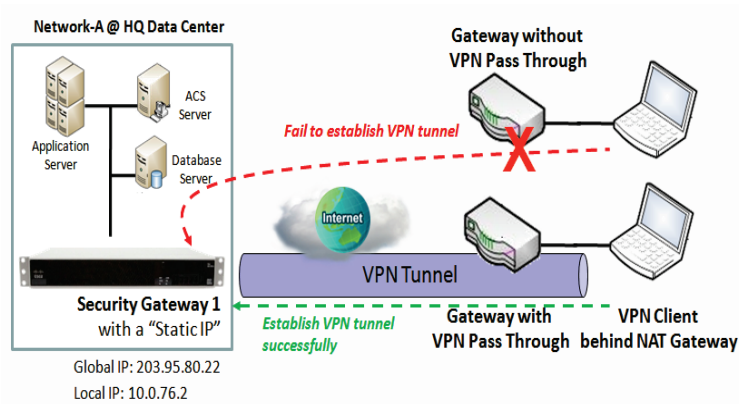

Since VPN traffic is different from that of TCP or UDP connection, it will be blocked by NAT gateway. To support the pass through function for the VPN connections initiating from VPN clients behind NAT gateway, the gateway must implement some kind of VPN pass through function for such application. The gateway support the pass through function for IPSec, PPTP, and L2TP connections, you just have to check the corresponding checkbox to activate it.

DMZ & Pass Through Setting

Go to **Basic Network > Port Forwarding > DMZ & Pass Through** tab.

The DMZ host is a host that is exposed to the Internet cyberspace but still within the protection of firewall by gateway device.

Enable DMZ and Pass Through

Configuration	
Item	Setting
DMZ	<input type="checkbox"/> Enable <input checked="" type="checkbox"/> All <input type="checkbox"/> WAN-1 <input type="checkbox"/> WAN-2 <input type="checkbox"/> WAN-3 <input type="checkbox"/> WAN-4 DMZ Host: <input type="text"/>
Pass Through Enable	<input checked="" type="checkbox"/> IPSec <input checked="" type="checkbox"/> PPTP <input checked="" type="checkbox"/> L2TP

Configuration Item	Value setting	Description
DMZ	1. A Must filled setting 2. Default is ALL .	Check the Enable box to activate the DMZ function Define the selected interface to be the packet-entering interface of the gateway, and fill in the IP address of Host LAN IP in DMZ Host field . If the packets to be filtered are coming from WAN-x then select WAN-x for this field. Select ALL for packets coming into the router from any interfaces. It can be selected WAN-x box when WAN-x enabled.

5G NR M2M Gateway

		Note: The available check boxes (WAN-1 ~ WAN-4) depend on the number of WAN interfaces for the product.
Pass Through Enable	The boxes are checked by default	Check the box to enable the pass through function for the IPSec , PPTP , and L2TP . With the pass through function enabled, the VPN hosts behind the gateway still can connect to remote VPN servers.
Save	N/A	Click the Save button to save the settings.
Undo	N/A	Click the Undo button to cancel the settings

5G NR M2M Gateway

2.5.4 Special AP & ALG (not supported)

Not supported feature for the purchased product, leave it as blank.

5G NR M2M Gateway

2.5.5 IP Translation

IP Translation is similar to One-to-One NAT. It is a feature where you can configure the gateway with multiple IP addresses issued by your Internet Service Provider (ISP) and map them to individual intranet devices with specific IP addresses. That is, configuring the IP Translation feature creates a one-to-one mapping between a public IP address and a private IP address of a local host. In addition, admin users also map a private IP address range to a public IP address range of equal instances.

This feature offers another way to make systems behind a firewall and configured with private IP addresses appear to have public IP addresses.

ID	Mapping Source IP/Domain Name	Mask	Mapping Destination IP/Domain Name	Mask	Physical interface	Description	Enable	Actions
1	1.1.1.8	255.255.255.255	8.8.8.8	255.255.255.255	All	DNS Server	<input checked="" type="checkbox"/>	<input type="button" value="Edit"/> <input type="checkbox"/> Select
2	1.1.1.201	255.255.255.255	192.168.123.201	255.255.255.255	All	Remote IPCam-1	<input checked="" type="checkbox"/>	<input type="button" value="Edit"/> <input type="checkbox"/> Select
3	1.1.1.202	255.255.255.255	192.168.123.202	255.255.255.255	All	Remote IPCam-2	<input checked="" type="checkbox"/>	<input type="button" value="Edit"/> <input type="checkbox"/> Select

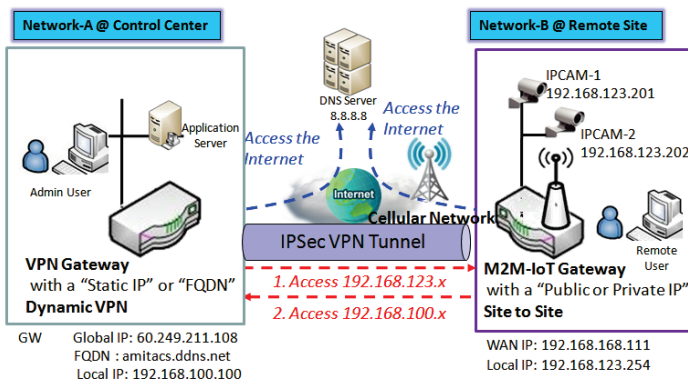

As shown in above configuration settings for the VPN gateway at Control Center, the Admin user can access the DNS Server with mapped IP 1.1.1.8, instead of its real IP 8.8.8.8; and he can also access (or manage) the remote IPCams with mapped IP 1.1.1.201 and 1.1.1.202, instead of their real IP 192.168.123.xxx.

From Control Center to Remote Site

- Admin user can ping DNS Server by mapped IP Address 1.1.1.8 instead of 8.8.8.8
- Admin User in Control Center also can manage remote IPCam via VPN Tunnel directly by mapped IP Address 1.1.1.201 instead of 192.168.123.201
IP Address 1.1.1.202 instead of 192.168.123.202

From Remote Site to Control Center

- Remote User can manage remote VPN Gateway, GUI,SSH directly by mapped specific IP Address 1.1.1.1 instead of FQDN amitacs.ddns.net

5G NR M2M Gateway

IP Translation Setting

Go to **Basic Network > Port Forwarding > IP Translation** tab.

Enable IP Translation

Configuration	
Item	Setting
IP Translation	<input type="checkbox"/> Enable

Configuration Item	Value setting	Description
IP Translation	The box is unchecked by default	Check the Enable box to activate the IP translation function
Save	N/A	Click the Save button to save the settings.

Create / Edit IP Translation Rule

When **Add** button is applied, **IP Translation Configuration** screen will appear.

IP Translation Configuration	
Item	Setting
Mapping Source IP/Domain Name	IP <input type="text"/>
Mask	255.255.255.255 (/32) <input type="text"/>
Mapping Destination IP/Domain Name	IP <input type="text"/>
Mask	255.255.255.255 (/32) <input type="text"/>
Physical Interface	All <input type="text"/>
Description	<input type="text"/>
Enable	<input type="checkbox"/>

IP Translation Configuration Item	Value setting	Description
Mapping Source IP/Domain Name	1. A Must filled setting 2.IP is selected by default.	Specify the mapped IP / Domain Name that will be issued from the hosts behind the NAT gateway. The NAT gateway will translate the specified source IP/Domain Name into other real IP / Domain Name that might be in the Internet or Intranet.
Mask	1. A Must filled setting 2.255.255.255.255(/32) is selected by default.	Enter the required subnet mask if Source IP is specified above. It can be a single IP with 255.255.255.255 (/32) subnet mask, or an IP group limited with proper subnet setting.

5G NR M2M Gateway

Mapping Destination IP/Domain Name	1. A Must filled setting 2.IP is selected by default.	Specify the expected real target IP / Domain Name that will be used to replace the original one that is issued by the hosts behind the NAT gateway.
Mask	1. A Must filled setting 2. 255.255.255.255(/32) is selected by default.	Enter the required subnet mask if Destination IP is specified above. It can be a single IP with 255.255.255.255 (/32) subnet mask, or an IP group limited with proper subnet setting.
Physical Interface	1. A Must filled setting 2. All is selected by default.	Specify the interface to apply the translation rule. The enabled WAN Interface will be available in the dropdown list. By default, All is selected, and the translation rule will be applied to the traffics passing through all WAN interfaces.
Description	An optional setting.	Specify a brief description or rule name for this IP Translation rule.
Enable	The box is unchecked by default	Check the Enable box to activate the translation rule.
Save	N/A	Click the Save button to save the settings.
Undo	N/A	Click the Undo button to cancel the settings

5G NR M2M Gateway

2.6 Routing

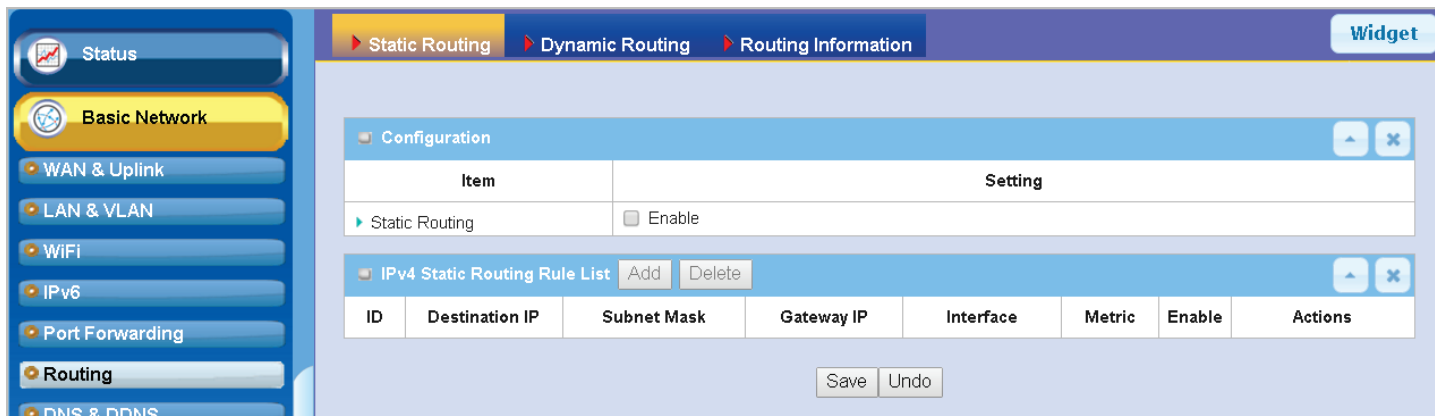

If you have more than one router and subnet, you will need to enable routing function to allow packets to find proper routing path and allow different subnets to communicate with each other. Routing is the process of selecting best paths in a network. It is performed for many kinds of networks, like electronic data networks (such as the Internet), by using packet switching technology. The routing process usually directs forwarding on the basis of routing tables which maintain a record of the routes to various network destinations. Thus, constructing routing tables, which are held in the router's memory, is very important for efficient routing. Most routing algorithms use only one network path at a time.

The routing tables record your pre-defined routing paths for some specific destination subnets. It is **static routing**. However, if the contents of routing tables record the obtained routing paths from neighbor routers by using some protocols, such as RIP, OSPF and BGP. It is **dynamic routing**. These both routing approaches will be illustrated one after one. In addition, the gateway also built in one advanced configurable routing software Quagga for more complex routing applications, you can configure it if required via Telnet CLI.

5G NR M2M Gateway

2.6.1 Static Routing

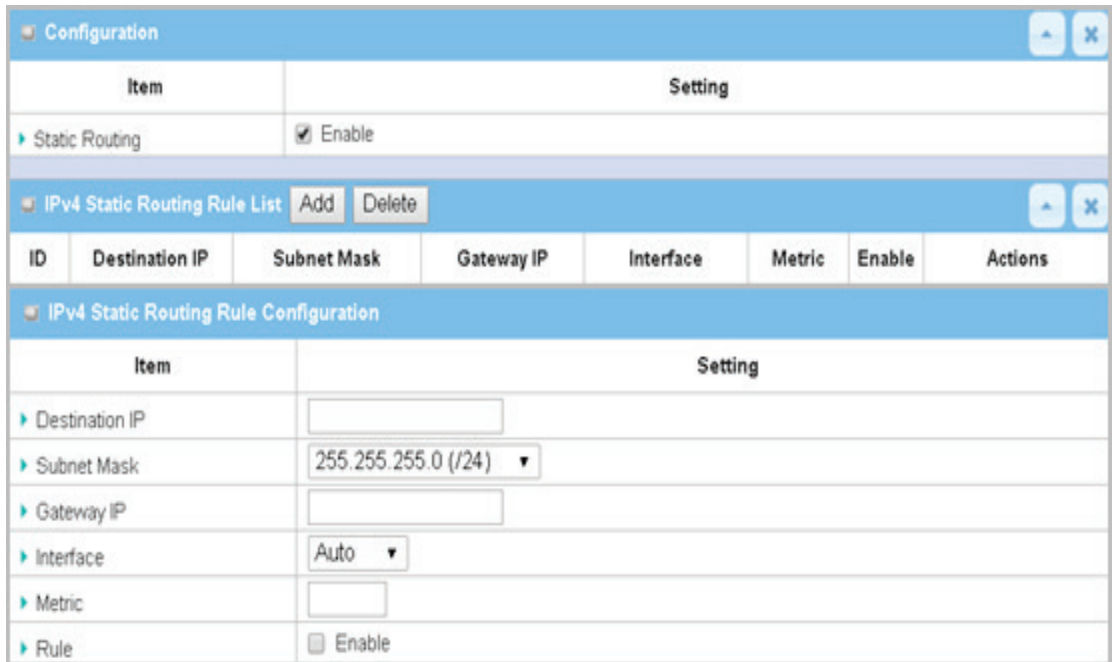
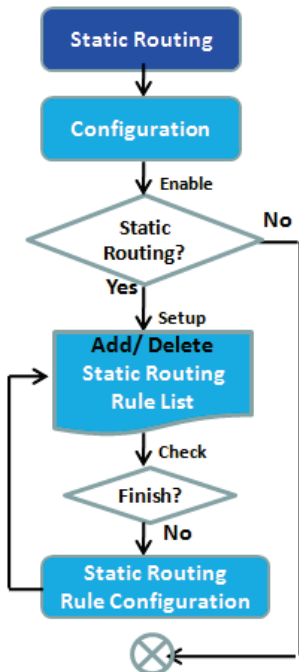

"Static Routing" function lets you define the routing paths for some dedicated hosts/servers or subnets to store in the routing table of the gateway. The gateway routes incoming packets to different peer gateways based on the routing table. You need to define the static routing information in gateway routing rule list.

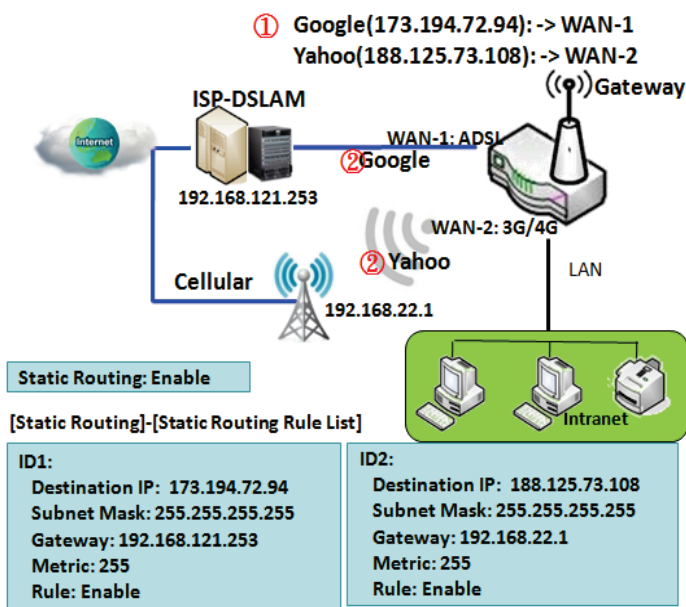

When the administrator of the gateway wants to specify what kinds of packets to be transferred via which gateway interface and which peer gateway to their destination. It can be carried out by the "Static Routing" feature. Dedicated packet flows from the Intranet will be routed to their destination via the pre-defined peer gateway and corresponding gateway interface that are defined in the system routing table by manual.

As shown in the diagram, when the destination is Google access, rule 1 set interface as ADSL, routing gateway as IP-DSLAM gateway 192.168.121.253. All the packets to Google will go through WAN-1. And the same way applied to rule 2 of access Yahoo. Rule 2 sets 3G/4G as interface.

5G NR M2M Gateway

Static Routing Setting

Go to **Basic Network > Routing > Static Routing** Tab.

There are three configuration windows for static routing feature, including "Configuration", "Static Routing Rule List" and "Static Routing Rule Configuration" windows. "Configuration" window lets you activate the global static routing feature. Even there are already routing rules, if you want to disable routing temporarily, just uncheck the Enable box to disable it. "Static Routing Rule List" window lists all your defined static routing rule entries. Using "Add" or "Edit" button to add and create one new static routing rule or to modify an existed one.

When "**Add**" or "**Edit**" button is applied, the "Static Routing Rule Configuration" window will appear to let you define a static routing rule.

Enable Static Routing

Just check the **Enable** box to activate the "Static Routing" feature.

Configuration	
Item	Setting
Static Routing	<input checked="" type="checkbox"/> Enable

Static Routing		
Item	Value setting	Description
Static Routing	The box is unchecked by default	Check the Enable box to activate this function

Create / Edit Static Routing Rules

The Static Routing Rule List shows the setup parameters of all static routing rule entries. To configure a static routing rule, you must specify related parameters including the destination IP address and subnet mask of dedicated host/server or subnet, the IP address of peer gateway, the metric and the rule activation.

IPv4 Static Routing Rule List							
ID	Destination IP	Subnet Mask	Gateway IP	Interface	Metric	Enable	Actions

The gateway allows you to custom your static routing rules. It supports up to a maximum of 64 rule sets. When **Add** button is applied, **Static Routing Rule Configuration** screen will appear, while the **Edit** button at the end of each static routing rule can let you modify the rule.

5G NR M2M Gateway

IPv4 Static Routing Rule Configuration	
Item	Setting
▶ Destination IP	<input type="text"/>
▶ Subnet Mask	255.255.255.0 (/24) ▼
▶ Gateway IP	<input type="text"/>
▶ Interface	Auto ▼
▶ Metric	<input type="text"/>
▶ Rule	<input type="checkbox"/> Enable

IPv4 Static Routing		
Item	Value setting	Description
Destination IP	1. IPv4 Format 2. A Must filled setting	Specify the Destination IP of this static routing rule.
Subnet Mask	255.255.255.0 (/24) is set by default	Specify the Subnet Mask of this static routing rule.
Gateway IP	1. IPv4 Format 2. A Must filled setting	Specify the Gateway IP of this static routing rule.
Interface	Auto is set by default	Select the Interface of this static routing rule. It can be Auto , or the available WAN / LAN interfaces.
Metric	1. Numeric String Format 2. A Must filled setting	The Metric of this static routing rule. <i>Value Range: 0 ~ 255.</i>
Rule	The box is unchecked by default.	Click Enable box to activate this rule.
Save	NA	Click the Save button to save the configuration
Undo	NA	Click the Undo button to restore what you just configured back to the previous setting.
Back	NA	When the Back button is clicked the screen will return to the Static Routing Configuration page.

5G NR M2M Gateway

2.6.2 Dynamic Routing

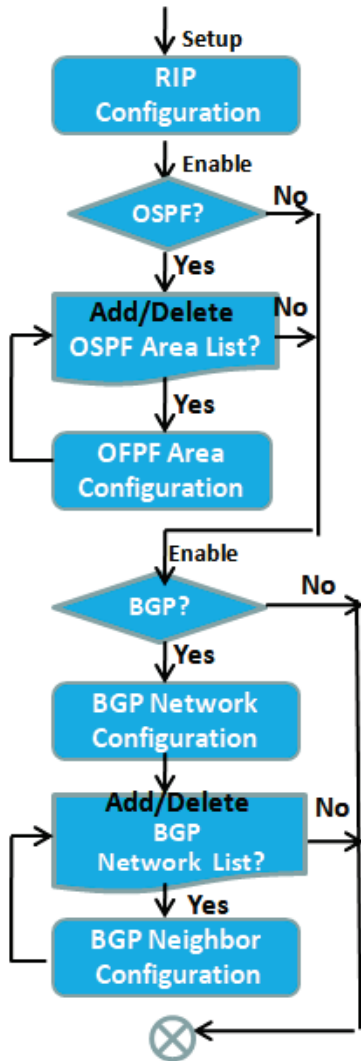

RIP Configuration	
Item	Setting
▶ RIP Enable	Disable

OSPF Configuration	
Item	Setting
▶ OSPF	<input type="checkbox"/> Enable
▶ Router ID	
▶ Authentication	None
▶ Backbone Subnet	

OSPF Area List				
Add Delete				
ID	Area Subnet	Area ID	Enable	Actions

OSPF Area Configuration	
Item	Setting
▶ Area Subnet	
▶ Area ID	
▶ Area	<input type="checkbox"/> Enable

Save

BGP Configuration	
Item	Setting
▶ BGP	<input type="checkbox"/> Enable
▶ ASN	
▶ Router ID	

BGP Network List			
Add Delete			
ID	Network Subnet	Enable	Actions

BGP Neighbor List				
Add Delete				
ID	Neighbor IP	Remote ASN	Enable	Actions

Dynamic Routing, also called adaptive routing, describes the capability of a system, through which routes are characterized by their destination, to alter the path that the route takes through the system in response to a change in network conditions.

This gateway supports dynamic routing protocols, including RIPv1/RIPv2 (Routing Information Protocol), OSPF (Open Shortest Path First), and BGP (Border Gateway Protocol), for you to establish routing table automatically. The feature of dynamic routing will be very useful when there are lots of subnets in your network. Generally speaking, RIP is suitable for small network. OSPF is more suitable for medium network. BGP is more used for big network infrastructure.

5G NR M2M Gateway

The supported dynamic routing protocols are described as follows.

RIP Scenario

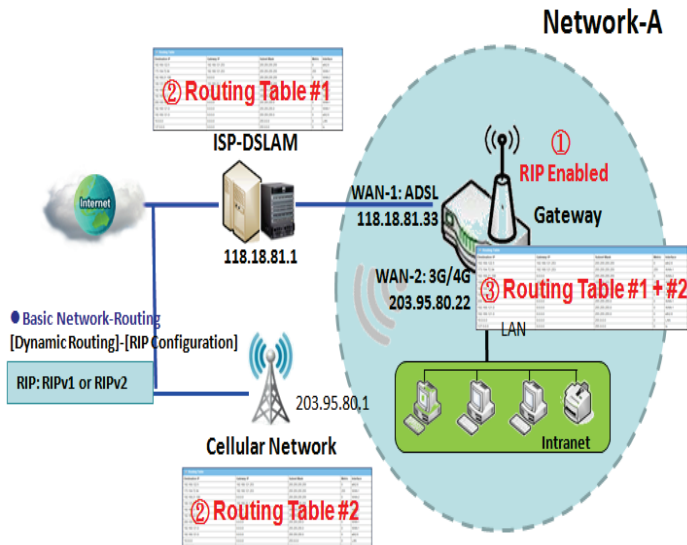

The Routing Information Protocol (RIP) is one of the oldest distance-vector routing protocols, which employs the hop count as a routing metric. RIP prevents routing loops by implementing a limit on the number of hops allowed in a path from the source to a destination. The maximum number of hops allowed for RIP is 15. This hop limit, however, also limits the size of networks that RIP can support. A hop count of 16 is considered an infinite distance, in other words the route is considered unreachable. RIP implements the split horizon, route poisoning and hold-down mechanisms to prevent incorrect routing information from being propagated.

OSPF Scenario

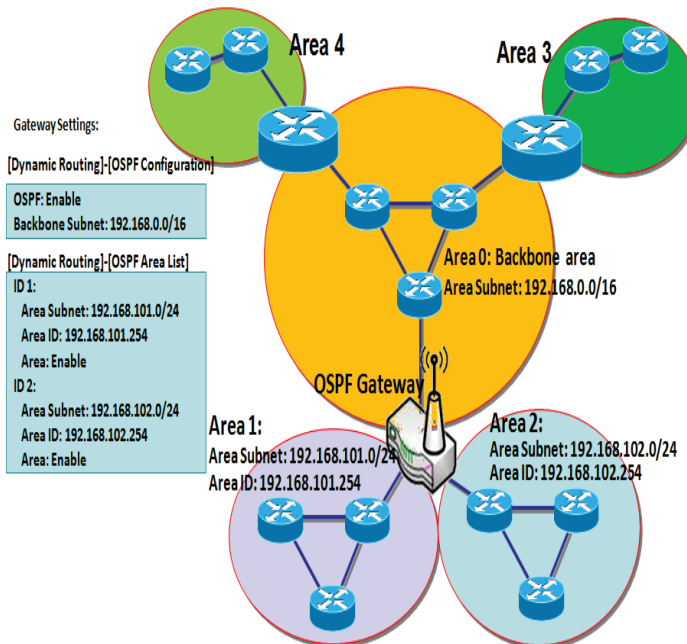

Open Shortest Path First (OSPF) is a routing protocol that uses link state routing algorithm. It is the most widely used interior gateway protocol (IGP) in large enterprise networks. It gathers link state information from available routers and constructs a topology map of the network. The topology is presented as a routing table which routes datagrams based solely on the destination IP address.

Network administrator can deploy OSPF gateway in large enterprise network to get its routing table from the enterprise backbone, and forward routing information to other routers, which are not linked to the enterprise backbone. Usually, an OSPF network is subdivided into routing areas to simplify administration and optimize traffic and resource utilization.

As shown in the diagram, OSPF gateway gathers routing information from the backbone gateways in area 0, and will forward its routing information to the routers in area 1 and area 2 which are not in the backbone.

5G NR M2M Gateway

BGP Scenario

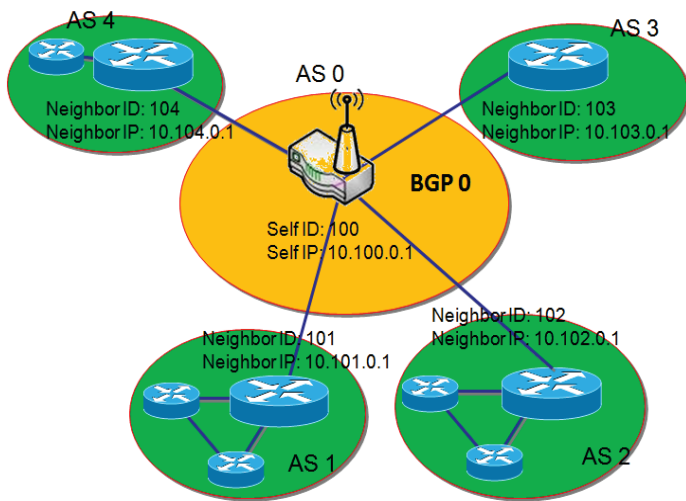

Border Gateway Protocol (BGP) is a standard exterior gateway protocol designed to exchange routing and reachability information between autonomous systems (AS) on the Internet. It usually makes routing decisions based on paths, network policies, or rule-sets.

Most ISPs use BGP to establish routing between one another (especially for multi-homed). Very large private IP networks also use BGP internally. The major BGP gateway within one AS will link with some other border gateways for exchanging routing information. It will distribute the collected data in AS to all routers in other AS.

As shown in the diagram, BGP 0 is gateway to dominate AS0 (self IP is 10.100.0.1 and self ID is 100). It links with other BGP gateways in the Internet. The scenario is like Subnet in one ISP to be linked with the ones in other ISPs. By operating with BGP protocol, BGP 0 can gather routing information from other BGP gateways in the Internet. And then it forwards the routing data to the routers in its dominated AS. Finally, the routers resided in AS 0 know how to route packets to other AS.

5G NR M2M Gateway

Dynamic Routing Setting

Go to **Basic Network > Routing > Dynamic Routing** Tab.

The dynamic routing setting allows user to customize RIP, OSPF, and BGP protocol through the router based on their office setting.

In the "Dynamic Routing" page, there are several configuration windows for dynamic routing feature. They are the "RIP Configuration" window, "OSPF Configuration" window, "OSPF Area List", "OSPF Area Configuration", "BGP Configuration", "BGP Neighbor List" and "BGP Neighbor Configuration" window. RIP, OSPF and BGP protocols can be configured individually.

The "RIP Configuration" window lets you choose which version of RIP protocol to be activated or disable it. The "OSPF Configuration" window can let you activate the OSPF dynamic routing protocol and specify its backbone subnet. Moreover, the "OSPF Area List" window lists all defined areas in the OSPF network. However, the "BGP Configuration" window can let you activate the BGP dynamic routing protocol and specify its self ID. The "BGP Neighbor List" window lists all defined neighbors in the BGP network.

RIP Configuration

The RIP configuration setting allows user to customize RIP protocol through the router based on their office setting.



Item	Setting
RIP Enable	Disable

RIP Configuration		
Item	Value setting	Description
RIP Enable	Disable is set by default	Select Disable will disable RIP protocol. Select RIP v1 will enable RIPv1 protocol. Select RIP v2 will enable RIPv2 protocol.

OSPF Configuration

The OSPF configuration setting allows user to customize OSPF protocol through the router based on their office setting.

5G NR M2M Gateway

OSPF Configuration	
Item	Setting
▶ OSPF	<input type="checkbox"/> Enable
▶ Router ID	<input type="text"/>
▶ Authentication	None ▾
▶ Backbone Subnet	<input type="text"/>

OSPF Configuration		
Item	Value setting	Description
OSPF	Disable is set by default	Click Enable box to activate the OSPF protocol.
Router ID	1. IPv4 Format 2. A Must filled setting	The Router ID of this router on OSPF protocol
Authentication	None is set by default	The Authentication method of this router on OSPF protocol. Select None will disable Authentication on OSPF protocol. Select Text will enable Text Authentication with entered the Key in this field on OSPF protocol. Select MD5 will enable MD5 Authentication with entered the ID and Key in these fields on OSPF protocol.
Backbone Subnet	1. Classless Inter Domain Routing (CIDR) Subnet Mask Notation. (Ex: 192.168.1.0/24) 2. A Must filled setting	The Backbone Subnet of this router on OSPF protocol.

Create / Edit OSPF Area Rules

The gateway allows you to custom your OSPF Area List rules. It supports up to a maximum of 32 rule sets.

OSPF Area List Add Delete				
ID	Area Subnet	Area ID	Enable	Actions

When **Add** button is applied, **OSPF Area Rule Configuration** screen will appear.

5G NR M2M Gateway

OSPF Area Configuration
⏪ ⏩

Item	Setting
▶ Area Subnet	<input style="width: 100%;" type="text"/>
▶ Area ID	<input style="width: 100%;" type="text"/>
▶ Area	<input type="checkbox"/> Enable

OSPF Area Configuration		
Item	Value setting	Description
Area Subnet	1. Classless Inter Domain Routing (CIDR) Subnet Mask Notation. (Ex: 192.168.1.0/24) 2. A Must filled setting	The Area Subnet of this router on OSPF Area List.
Area ID	1. IPv4 Format 2. A Must filled setting	The Area ID of this router on OSPF Area List.
Area	The box is unchecked by default.	Click Enable box to activate this rule.
Save	N/A	Click the Save button to save the configuration

5G NR M2M Gateway

BGP Configuration

The BGP configuration setting allows user to customize BGP protocol through the router setting.

BGP Configuration	
Item	Setting
▶ BGP	<input type="checkbox"/> Enable
▶ ASN	<input type="text"/>
▶ Router ID	<input type="text"/>

BGP Network Configuration		
Item	Value setting	Description
BGP	The box is unchecked by default	Check the Enable box to activate the BGP protocol.
ASN	1. Numeric String Format 2. A Must filled setting	The ASN Number of this router on BGP protocol. <u>Value Range:</u> 1 ~ 4294967295.
Router ID	1. IPv4 Format 2. A Must filled setting	The Router ID of this router on BGP protocol.

Create / Edit BGP Network Rules

The gateway allows you to custom your BGP Network rules. It supports up to a maximum of 32 rule sets.

BGP Network List			
ID	Network Subnet	Enable	Actions

When **Add** button is applied, **BGP Network Configuration** screen will appear.

BGP Network Configuration	
Item	Setting
▶ Network Subnet	IP : <input type="text"/> 255.255.255.0 (/24) ▾
▶ Network	<input type="checkbox"/> Enable

Item	Value setting	Description
Network Subnet	1. IPv4 Format 2. A Must filled setting	The Network Subnet of this router on BGP Network List. It composes of entered the IP address in this field and the selected subnet mask.

5G NR M2M Gateway

Network	The box is unchecked by default.	Click Enable box to activate this rule.
Save	N/A	Click the Save button to save the configuration

Create / Edit BGP Neighbor Rules

The gateway allows you to custom your BGP Neighbor rules. It supports up to a maximum of 32 rule sets.

BGP Neighbor List

▲

ID	Neighbor IP	Remote ASN	Enable	Actions
----	-------------	------------	--------	---------

When **Add** button is applied, **BGP Neighbor Configuration** screen will appear.

BGP Neighbor Configuration
▲ ✕

Item	Setting
▶ Neighbor IP	<input type="text"/>
▶ Remote ASN	<input type="text"/>
▶ Neighbor	<input type="checkbox"/> Enable

BGP Neighbor Configuration		
Item	Value setting	Description
Neighbor IP	1. IPv4 Format 2. A Must filled setting	The Neighbor IP of this router on BGP Neighbor List.
Remote ASN	1. Numeric String Format 2. A Must filled setting	The Remote ASN of this router on BGP Neighbor List. <u>Value Range:</u> 1 ~ 4294967295.
Neighbor	The box is unchecked by default.	Click Enable box to activate this rule.
Save	N/A	Click the Save button to save the configuration

5G NR M2M Gateway

2.6.3 Routing Information

The routing information allows user to view the routing table and policy routing information. Policy Routing Information is only available when the Load Balance function is enabled and the Load Balance Strategy is By User Policy.

Go to **Basic Network > Routing > Routing Information** Tab.

Routing Table				
Destination IP	Subnet Mask	Gateway IP	Metric	Interface
100.105.167.72	255.255.255.252	0.0.0.0	0	WAN-2
192.168.66.0	255.255.255.0	0.0.0.0	0	LAN
192.168.127.0	255.255.255.0	0.0.0.0	0	WAN-1
169.254.0.0	255.255.0.0	0.0.0.0	0	LAN
127.0.0.0	255.0.0.0	0.0.0.0	0	lo

Routing Table		
Item	Value setting	Description
Destination IP	N/A	Routing record of Destination IP. IPv4 Format.
Subnet Mask	N/A	Routing record of Subnet Mask. IPv4 Format.
Gateway IP	N/A	Routing record of Gateway IP. IPv4 Format.
Metric	N/A	Routing record of Metric. Numeric String Format.
Interface	N/A	Routing record of Interface Type. String Format.

Policy Routing Information				
Policy Routing Source	Source IP	Destination IP	Destination Port	WAN Interface
Load Balance	-	-	-	-

Policy Routing Information		
Item	Value setting	Description
Policy Routing Source	N/A	Policy Routing of Source. String Format.
Source IP	N/A	Policy Routing of Source IP. IPv4 Format.
Destination IP	N/A	Policy Routing of Destination IP. IPv4 Format.
Destination Port	N/A	Policy Routing of Destination Port. String Format.
WAN Interface	N/A	Policy Routing of WAN Interface. String Format.

5G NR M2M Gateway

2.7 DNS & DDNS

How does user access your server if your WAN IP address changes all the time? One way is to register a new domain name, and maintain your own DNS server. Another simpler way is to apply a domain name to a third-party DDNS service provider. The service can be free or charged. If you want to understand the basic concepts of DNS and Dynamic DNS, you can refer to Wikipedia website^{3,4}.

2.7.1 DNS & DDNS Configuration

Dynamic DNS

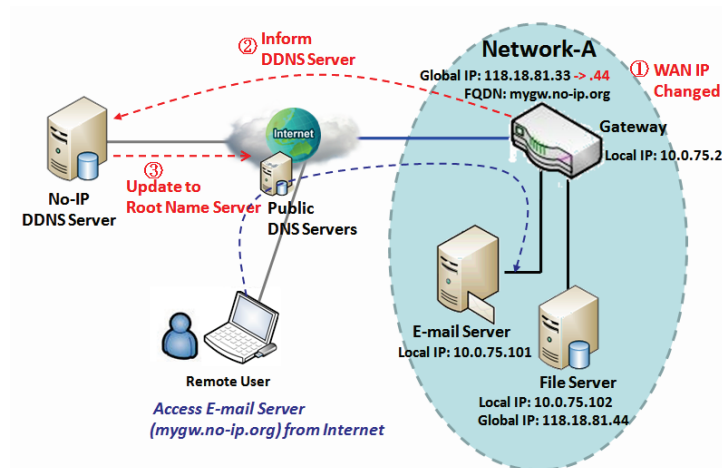

To host your server on a changing IP address, you have to use dynamic domain name service (DDNS). Therefore, anyone wishing to reach your host only needs to know the domain name. Dynamic DNS will map the name of your host to your current IP address, which changes each time you connect your Internet service provider.

The Dynamic DNS service allows the gateway to alias a public dynamic IP address to a static domain name, allowing the gateway to be more easily accessed from various locations on the Internet. As shown in the diagram, user registered a domain name to a third-

party DDNS service provider (NO-IP) to use DDNS function. Once the IP address of designated WAN interface has changed, the dynamic DNS agent in the gateway will inform the DDNS server with the new IP address. The server automatically re-maps your domain name with the changed IP address. So, other hosts or remote users in the Internet world are able to link to your gateway by using your domain name regardless of the changing global IP address.

3 http://en.wikipedia.org/wiki/Domain_Name_System

4 http://en.wikipedia.org/wiki/Dynamic_DNS

5G NR M2M Gateway

DNS & DDNS Setting

Go to **Basic Network > DNS & DDNS > Configuration** Tab.

The DNS & DDNS setting allows user to setup Dynamic DNS feature and DNS redirect rules.

Setup Dynamic DNS

The gateway allows you to custom your Dynamic DNS settings.

Dynamic DNS	
Item	Setting
▶ DDNS	<input type="checkbox"/> Enable
▶ WAN Interface	WAN-1
▶ Provider	DynDNS.org(Dynamic)
▶ Host Name	
▶ User Name / E-Mail	
▶ Password / Key	

DDNS (Dynamic DNS) Configuration		
Item	Value setting	Description
DDNS	The box is unchecked by default	Check the Enable box to activate this function.
WAN Interface	WAN 1 is set by default	Select the WAN Interface IP Address of the gateway.
Provider	DynDNS.org (Dynamic) is set by default	Select your DDNS provider of Dynamic DNS. It can be DynDNS.org(Dynamic) , DynDNS.org(Custom) , NO-IP.com , etc...
Host Name	1. String format can be any text 2. A Must filled setting	Your registered host name of Dynamic DNS. Value Range: 0 ~ 63 characters.
User Name / E-Mail	1. String format can be any text 2. A Must filled setting	Enter your User name or E-mail addresss of Dynamic DNS.
Password / Key	1. String format can be any text 2. A Must filled setting	Enter your Password or Key of Dynamic DNS.
Save	N/A	Click Save to save the settings
Undo	N/A	Click Undo to cancel the settings

5G NR M2M Gateway

Setup DNS Redirect

DNS redirect is a special function to redirect certain traffics to a specified host. Administator can manage the internet / intranet traffics that are going to access some restricted DNS and force those traffics to be redirected to a specified host.

DNS Redirect	
Item	Setting
DNS Redirect	<input type="checkbox"/> Enable

DNS Redirect Configuration		
Item	Value setting	Description
DNS Redirect	The box is unchecked by default	Check the Enable box to activate this function.
Save	N/A	Click Save to save the settings
Undo	N/A	Click Undo to cancel the settings

If you enabled the DNS Redirect function, you have to further specify the redirect rules. According to the rules, the gateway can redirect the traffic that matched the DNS to corresponding pre-defined IP address.

Redirect Rule					
ID	Mapping Rule	Condition	Description	Enable	Action

When **Add** button is applied, **Redirect Rule** screen will appear.

Redirect Rule					
Item	Setting				
Mapping Rule	<table border="1"><thead><tr><th>Domain Name</th><th>IP</th></tr></thead><tbody><tr><td><input type="text"/> (* for Any)</td><td><input type="text"/></td></tr></tbody></table>	Domain Name	IP	<input type="text"/> (* for Any)	<input type="text"/>
	Domain Name	IP			
<input type="text"/> (* for Any)	<input type="text"/>				
Condition	Always				
Description	<input type="text"/>				
Enable	<input type="checkbox"/> Enable				

Redirect Rule Configuration		
Item	Value setting	Description
Domain Name	1. String format can be any text 2. A Must filled setting	Enter a domain name to be redirect. The traffic to specified domain name will be redirect to the following IP address. Value Range: at least 1 character is required; '*' for any.
IP	1. IPv4 format	Enter an IP Address as the target for the DNS redirect.

5G NR M2M Gateway

	2. A Must filled setting	
Condition	1. A Must filled setting 2. Always is selected by default.	Specify when will the DNS redirect action can be applied. It can be Always , or WAN Block . Always: The DNS redirect function can be applied to matched DNS all the time. WAN Block: The DNS redirect function can be applied to matched DNS only when the WAN connection is disconnected, or un-reachable.
Description	1. String format can be any text 2. A Must filled setting	Enter a brief description for this rule. <i>Value Range:</i> 0 ~ 63 characters.
Enable	The box is unchecked by default	Click the Enable button to activate this rule.
Save	N/A	Click Save to save the settings
Undo	N/A	Click Undo to cancel the settings

5G NR M2M Gateway

2.8 QoS

The total amount of data traffic increases nowadays as the higher demand of mobile applications, like Game / Chat / VoIP / P2P / Video / Web access. In order to pose new requirements for data transport, e.g. low latency, low data loss, the entire network must ensure them via a connection service guarantee.

The main goal of QoS (Quality of Service) is prioritizing incoming data, and preventing data loss due to factors such as jitter, delay and dropping. Another important aspect of QoS is ensuring that prioritizing one data flow doesn't interfere with other data flows. So, QoS helps to prioritize data as it enters your router. By attaching special identification marks or headers to incoming packets, QoS determines which queue the packets enter, based on priority. This is useful when there are certain types of data you want to give higher priority to, such as voice packets given higher priority than Web data packets.

To utilize your network throughput completely, administrator must define bandwidth control rules carefully to balance the utilization of network bandwidth for all users to access. It is indeed required that an access gateway satisfies the requirements of latency-critical applications, minimum access right guarantee, fair bandwidth usage for same subscribed condition and flexible bandwidth management. D-LINK Security Gateway provides a Rule-based QoS to carry out the requirements.

2.8.1 QoS Configuration

This gateway provides lots of flexible rules for you to set QoS policies. Basically, you need to know three parts of information before you create your own policies. First, "who" needs to be managed? Second, "what" kind of service needs to be managed? The last part is "how" you prioritize. Once you have this information, you can continue to learn functions in this section in more detail.

[QoS Rule Configuration](#)

When you want to add a new QoS rule or edit one already existed, the "QoS Rule Configuration" window shows up for you to configure. The parameters in a rule include the applied WAN interfaces, the dedicated host group based on MAC address or IP address, the dedicated kind of service packets, the system resource to be distributed, the corresponding control function for your specified resource, the packet flow direction, the sharing method for the control function, the integrated time schedule rule and the rule activation. Following diagram illustrates how to organize a QoS rule.

5G NR M2M Gateway

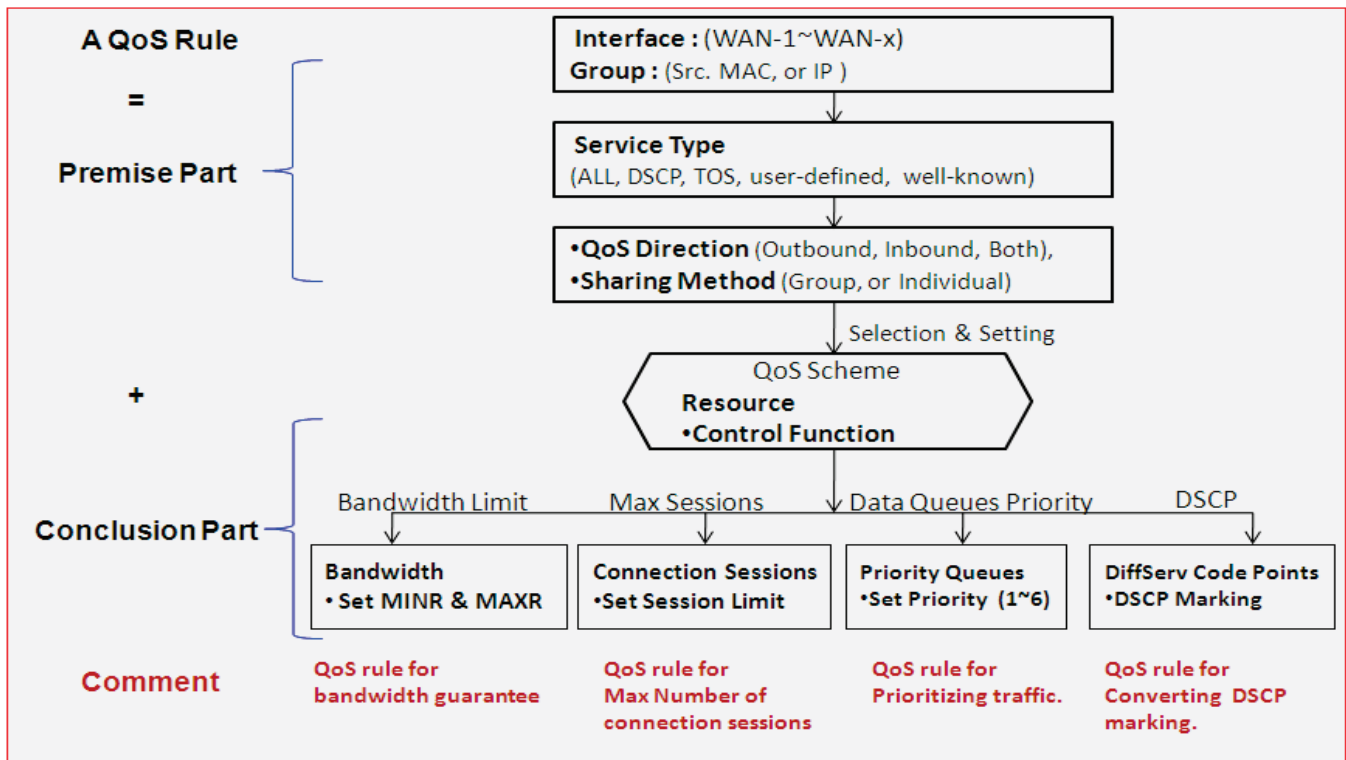

In above diagram, a QoS rule is organized by the premise part and the conclusion part. In the premise part, you must specify the WAN interface, host group, service type in the packets, packet flow direction to be watched and the sharing method of group control or individual control. However, in the conclusion part, you must make sure which kind of system resource to distribute and the control function based on the chosen system resource for the rule.

The Rule-based QoS has following features.

Multiple Group Categories

Specify the group category in a QoS rule for the target objects to be applied on.

Group Category can be based on VLAN ID, MAC Address, IP Address, Host Name or Packet Length.

Differentiated Services

Specify the service type in a QoS rule for the target packets to be applied on.

Differentiated services can be based on 802.1p, DSCP, TOS, VLAN ID, User-defined Services and Well-known Services. Well-known services include FTP(21), SSH(TCP:22), Telnet(23), SMTP(25), DNS(53), TFTP(UDP:69), HTTP(TCP:80), POP3(110), Auth(113), SFTP(TCP:115), SNMP&Traps(UDP:161-162), LDAP(TCP:389), HTTPS(TCP:443), SMTPs(TCP:465), ISAKMP(500), RTSP(TCP:554), POP3s(TCP:995), NetMeeting(1720), L2TP(UDP:1701) and PPTP(TCP:1723).

Available Control Functions

There are 4 resources can be applied in a QoS rule: bandwidth, connection sessions, priority queues and DiffServ Code Point (DSCP). Control function that acts on target objects for specific services of packet flow is based on these resources.

For bandwidth resource, control functions include guaranteeing bandwidth and limiting bandwidth. For

5G NR M2M Gateway

priority queue resource, control function is setting priority. For DSCP resource, control function is DSCP marking. The last resource is Connection Sessions; the related control function is limiting connection sessions.

Individual / Group Control

One QoS rule can be applied to individual member or whole group in the target group. This feature depends on model.

Outbound / Inbound Control

One QoS rule can be applied to the outbound or inbound direction of packet flow, even them both. This feature depends on model.

Two QoS rule examples are listed as below.

QoS Rule Example #1 - Connection Sessions

QoS Rule Configuration	
Item	Setting
▶ Interface	WAN - 1
▶ Group	IP 10.0.75.16 Subnet Mask : 255.255.255.240 (/28)
▶ Service	All
▶ Queue Outbound	N/A
▶ Queue Inbound	N/A
▶ Time Schedule	(0) Always
▶ Rule Enable	<input checked="" type="checkbox"/> Enable

When administrator wants to limit maximum connection sessions from some client hosts (IP 10.0.75.16~31) to 20000 to avoid resource unbalanced, he can setup this rule as above configuration.

This rule defines that all client hosts, whose IP address is in the range of 10.0.75.16~31, can access the Internet via "WAN-1" interface under the limitation of the maximum 20000 connection sessions totally at any time

5G NR M2M Gateway

QoS Rule Example #2 – DifferServ Code Points

QoS Rule Configuration	
Item	Setting
▶ Interface	All WANs ▾
▶ Group	IP ▾ 10.0.75.196 Subnet Mask : 255.255.255.252 (/30) ▾
▶ Service	DSCP ▾ ▶ DiffServ CodePoint IP Precedence 4(CS4) ▾
▶ Queue Outbound	N/A
▶ Queue Inbound	N/A
▶ Time Schedule	(0) Always ▾
▶ Rule Enable	<input checked="" type="checkbox"/> Enable

When the administrator of the gateway wants to convert the code point value, "IP Precedence 4(CS4)", in the packets from some client hosts (IP 10.0.75.196~199) to the code value, "AF Class2(High Drop)", he can use the "Rule-based QoS" function to carry out this rule by defining an QoS rule as shown in above configuration. Under such configuration, all packets from WAN interfaces to LAN IP address 10.0.75.196 ~ 10.0.75.199 which have DiffServ code points with "IP Precedence 4(CS4)" value will be modified by "DSCP Marking" control function with "AF Class 2(High Drop)" value at any time.

5G NR M2M Gateway

QoS Configuration Setting

Go to **Basic Network > QoS > Configuration** tab.

In "QoS Configuration" page, there are some configuration windows for QoS function. They are the "Configuration" window, "System Resource Configuration" window, "QoS Rule List" window, and "QoS Rule Configuration" window.

The "Configuration" window can let you activate the Rule-based QoS function. In addition, you can also enable the "Flexible Bandwidth Management" (FBM) feature for better utilization of system bandwidth by FBM algorithm. Second, the "System Configuration" window can let you configure the total bandwidth and session of each WAN. Third, the "QoS Rule List" window lists all your defined QoS rules. At last, the "QoS Rule Configuration" window can let you define one QoS rule.

Enable QoS Function

Configuration	
Item	Setting
▶ QoS Types	Software <input type="checkbox"/> Enable
▶ Flexible Bandwidth Management	<input type="checkbox"/> Enable

Configuration Item	Value Setting	Description
QoS Type	1. Software is selected by default. 2. The box is unchecked by default.	Select the QoS Type from the dropdown list, and then click Enable box to activate the QoS function. The default QoS type is set to Software QoS. For some models, there is another option for Hardware QoS.
Flexible Bandwidth Management	The box is unchecked by default	Click Enable box to activate the Flexible Bandwidth Management function.
Save	N/A	Click the Save button to save the settings.

Check the "Enable" box to activate the "Rule-based QoS" function. Also enable the Flexible Bandwidth Management (FBM) feature when needed. When FBM is enabled, system adjusts the bandwidth distribution dynamically based on current bandwidth usage situation to reach maximum system network performance while transparent to all users. Certainly, the bandwidth subscription profiles of all current users are considered in system's automatic adjusting algorithm.

5G NR M2M Gateway

Setup System Resource

System Resource Configuration	
Item	Setting
▶ Type of System Queue	Bandwidth Queue 6 (1~6)
▶ WAN Interface	WAN - 1

WAN Interface Resource	
Item	Setting
▶ Bandwidth of Upstream	100 Mbps
▶ Bandwidth of Downstream	100 Mbps
▶ Total Connection Sessions	30000 (1~100000)

System Resource Configuration		
Item	Value Setting	Description
Type of System Queue	1. A Must filled setting. 2. Bandwidth Queue , and 6 are set by default.	Define the system queues that are available for the QoS settings. The supported type of system queues are Bandwidth Queue and Priority Queues . <i>Value Range: 1 ~ 6.</i>
WAN Interface	WAN-1 is selected by default.	Select the WAN interface and then the following WAN Interface Resource screen will show the related resources for configuration. <ul style="list-style-type: none"> ● Bandwidth of Upstream / Downstream Specify total upload / download bandwidth of the selected WAN. <i>For Gigabit Ethernet: 1~102400Kbps, or 1~1000Mbps;</i> <i>For Fast Ethernet: 1~102400Kbps, or 1~100Mbps;</i> <i>For 3G/4G: 1~153600Kbps, or 1~150Mbps.</i> ● Total Connection Sessions Specify total connection sessions of the selected WAN. <i>1 ~ 10000.</i>
Save	N/A	Click the Save button to save the settings.

Each WAN interface should be configured carefully for its upstream bandwidth, downstream bandwidth and maximum number of connection sessions.

5G NR M2M Gateway

Create / Edit QoS Rules

After enabled the QoS function and configured the system resources, you have to further specify some QoS rules for provide better service on the interested traffics. The gateway supports up to a maximum of 128 rule-based QoS rule sets.

QoS Rule List									
Interface	Group	Service	Resource	Control Function	Direction	Sharing Method	Time Schedule	Enable	Actions

When **Add** button is applied, **QoS Rule Configuration** screen will appear.

QoS Rule Configuration	
Item	Setting
▶ Interface	All WANs ▾
▶ Group	Src. MAC Address ▾ <input type="text"/>
▶ Service	All ▾
▶ Resource	Bandwidth ▾
▶ Control Function	Set MINR & MAXR ▾ <input type="text"/> --- <input type="text"/> Mbps ▾
▶ QoS Direction	Outbound ▾
▶ Time Schedule	(0) Always ▾
▶ Rule Enable	<input type="checkbox"/> Enable

QoS Rule Configuration		
Item	Value setting	Description
Interface	<ol style="list-style-type: none"> 1. A Must filled setting. 2. All WANs is selected by default. 	Specify the WAN interface to apply the QoS rule. Select All WANs or a certain WAN-n to filter the packets entering to or leaving from the interface(s).
Group	<ol style="list-style-type: none"> 1. A Must filled setting. 2. Src. MAC Address is selected by default. 	<p>Specify the Group category for the QoS rule. It can be Src. MAC Address, IP, or Host Name.</p> <p>Select Src. MAC Address to prioritize packets based on MAC;</p> <p>Select IP to prioritize packets based on IP address and Subnet Mask;</p> <p>Select Host Name to prioritize packets based on a group of a pre-configured group of host from the dropdown list. If the dropdown list is empty, ensure if any group is pre-configured.</p> <p>Note: The required host groups must be created in advance and corresponding QoS checkbox in the Multiple Bound Services field is checked before the Host Group option become available. Refer to Object Definition > Grouping > Host</p>

5G NR M2M Gateway

		Grouping.
Service	1. A Must filled setting. 2. All is selected by default.	<p>Specify the service type of traffics that have to be applied with the QoS rule. It can be All, DSCP, TOS, User-defined Service, or Well-known Service.</p> <p>Select All for all packets.</p> <p>Select DSCP for DSCP type packets only.</p> <p>Select TOS for TOS type packets only. You have to select a service type (Minimize-Cost, Maximize-Reliability, Maximize-Throughput, or Minimize-Delay) from the dropdown list as well.</p> <p>Select User-defined Service for user-defined packets only. You have to define the port range and protocol as well.</p> <p>Select Well-known Service for specific application packets only. You have to select the required service from the dropdown list as well.</p>
Resource, and Control Function	A Must filled setting	<p>Specify the Resource Type and corresponding Control function for the QoS rule. The available Resource options are Bandwidth, Connection Sessions, Priority Queues, and DiffServ Codepoints.</p> <p>Bandwidth: Select Bandwidth as the resource type for the QoS Rule, and you have to assign the min rate, max rate and rate unit as the bandwidth settings in the Control Function / Set MINR & MAXR field.</p> <p>Connection Sessions: Select Connection Sessions as the resource type for the QoS Rule, and you have to assign supported session number in the Control Function / Set Session Limitation field.</p> <p>Priority Queues: Select Priority Queues as the resource type for the QoS Rule, and you have to specify a priority queue in the Control Function / Set Priority field.</p> <p>DiffServ Code Points: Select DiffServ Code Points as the resource type for the QoS Rule, and you have to select a DSCP marking from the Control Function / DSCP Marking dropdown list.</p>
QoS Direction	1. A Must filled setting. 2. Outbound is selected by default.	<p>Specify the traffic flow direction for the packets to apply the QoS rule. It can be Outbound, Inbound, or Both.</p> <p>Outbound: Select Outbound to prioritize the traffics going to the Internet via the specified interface. Under such situation, the hosts specified in the Group field is a source group.</p> <p>Inbound: Select Inbound to prioritize the traffics coming from the Internet via the specified interface. Under such situation, the hosts specified in the Group field is a destination group.</p> <p>Both: Select both to prioritize the traffics passing through the specified interface, both Inbound and Outbound are considered. Under such situation, the hosts specified in the Group field can be a source or destination group.</p>
Sharing Method	1. A Must filled setting. 2. Group Control is selected by default.	<p>Specify the preferred sharing method for how to apply the QoS rule on the selected group. It can be Individual Control or Group Control.</p> <p>Individual Control: If Individual Control is selected, each host in the group will</p>

5G NR M2M Gateway

		have his own QoS service resource as specified in the rule. Group Control: If Group Control is selected, all the group hosts share the same QoS service resource.
Time Schedule	1. A Must filled setting. 2. (0) Always is selected by default.	Apply Time Schedule to this rule; otherwise leave it as (0) Always . (refer to Object Definition > Scheduling > Configuration settings)
Rule Enable	The box is unchecked by default.	Click Enable box to activate this QoS rule.
Save	N/A	Click the Save button to save the settings.

5G NR M2M Gateway

2.9 Redundancy

In engineering, redundancy is the duplication of critical components or functions of a system with the intention of increasing reliability of the system, usually in the form of a backup or fail-safe. In an IP networking, the access gateway is the critical part of the networking system. Redundant gateway plays the backup one of the master gateway and it will take over the data transmitting job once it finds the master gateway failed.

The purchased gateway can serve as the redundant gateway of core router in the enterprise by using the Virtual Router Redundancy Protocol (VRRP).

2.9.1 VRRP

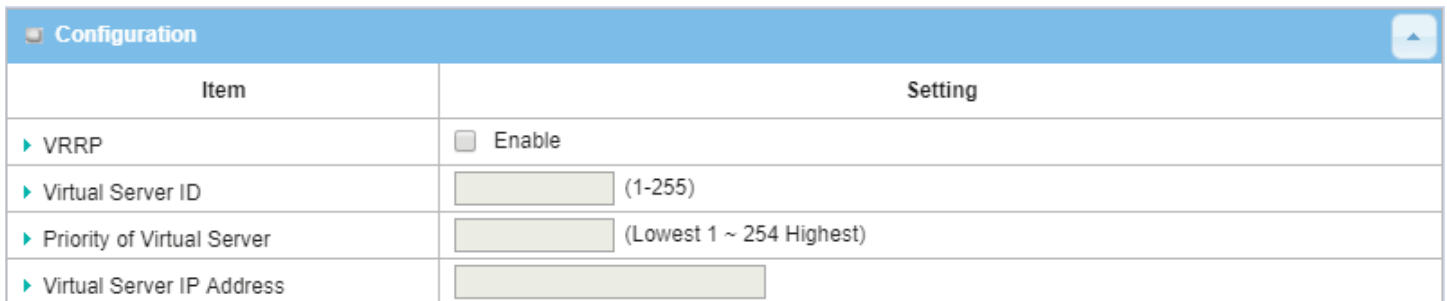

Item	Setting
▶ VRRP	<input type="checkbox"/> Enable
▶ Virtual Server ID	<input type="text"/> (1-255)
▶ Priority of Virtual Server	<input type="text"/> (Lowest 1 ~ 254 Highest)
▶ Virtual Server IP Address	<input type="text"/>

Virtual Router Redundancy Protocol (VRRP) is a computer networking protocol providing device redundancy. It allows a backup router or switch to automatically take over if the primary (master) router or switch fails. This increases the availability and reliability of routing paths via automatic default gateway selections on an IP network.

The protocol achieves this by creation of virtual routers, which are an abstract representation of multiple routers, i.e. master and backup routers, acting as a group. The default gateway of a participating host is assigned to the virtual router instead of a physical router. If the physical router that is routing packets on behalf of the virtual router fails, another physical router is selected to automatically replace it. The physical router that is forwarding packets at any given time is called the master router.

A group of physical VRRP gateways combined together to play a virtual server with one unique virtual server ID and one unique virtual server IP address. But these VRRP gateways have their own priority values to serve as the sequence for backing up the master gateway.

The gateway with VRRP function can join one group of redundant gateways to serve as the backup one for the master gateway. Fill same values of virtual server ID and IP for these gateways, and each gateway owns its own priority as the sequence in the backup list. They construct a VRRP redundant gateway group. Following diagram illustrates the group example with two member gateways.

5G NR M2M Gateway

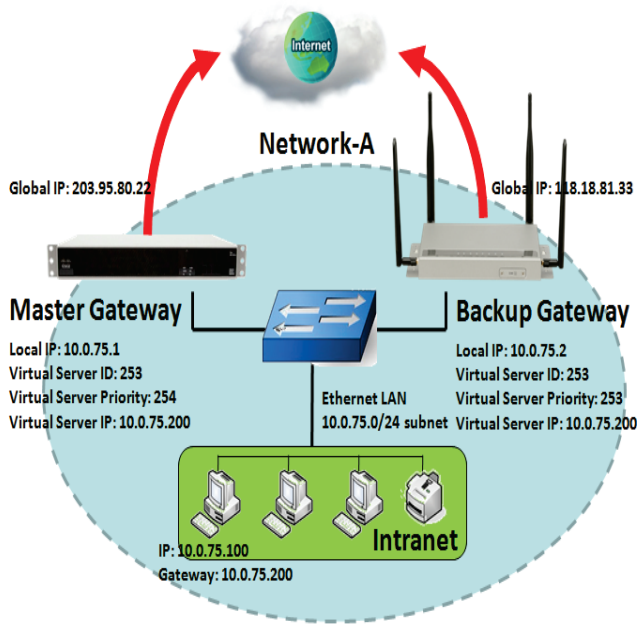

As shown in the diagram, Master Gateway and Backup Gateway are redundant gateway group of Network-A. Subnet of network-A is 10.0.75.0/24. Master gateway has LAN IP 10.0.75.1 and WAN IP 203.95.80.22. Backup gateway has LAN IP 10.0.75.2 and 118.18.81.33 for WAN-1. They both serve as NAT routers.

Specify the ID of VRRP virtual server to be "253" and its IP address to be "10.0.75.200". The priority of the master gateway is 254 and it is larger than the one (253) of the backup gateway. At first stage, all data from the Intranet go through the master gateway that has the highest priority. Once the master Internet connection is broken, the backup gateway will take over the data transmitting job and serve as the master gateway.

When a gateway with higher priority recovers from broken connection, it will take over data transmitting again.

VRRP Setting

The Virtual Router Redundancy Protocol (VRRP) setting allows user to assign available Internet Protocol (IP) routers to participating hosts automatically.

Go to **Basic Network > Redundancy > VRRP** tab.

The device provides multiple VRRP instances for complex LAN connections. Just configure what your application required.

Instance 0 Configuration	
Item	Setting
▶ VRRP	<input type="checkbox"/> Enable
▶ LAN Interface	DHCP 1 ▾
▶ Virtual Router ID	<input type="text"/> (1-255)
▶ Priority of Virtual Router	<input type="text"/> (Lowest 1 ~ 254 Highest)
▶ Virtual Router IP Address	<input type="text"/>

Instance 0 / 1 / 2 / 3 Configuration

5G NR M2M Gateway

Item	Value setting	Description
VRRP	The box is unchecked by default.	Check the Enable box to activate this VRRP function.
LAN Interface	1. A Must filled setting 2. DHCP 1 is selected by default	Specify the LAN interface that will be applied with the VRRP configuration. The available interface can be DHCP 1 ~ DHCP 4 . It depends on the specification for the purchased product.
Virtual Server ID	1. Numeric String Format 2. A Must filled setting	Specify the Virtual Server ID on VRRP of the gateway. <i>Value Range: 1 ~ 255.</i>
Priority of Virtual Server	1. Numeric String Format 2. A Must filled setting	Specify the Priority of Virtual Server on VRRP of the gateway. <i>Value Range: 1 ~ 254, and 254 is the highest priority.</i>
Virtual Server IP Address	1. IPv4 Format 2. A Must filled setting	Specify the Virtual Server IP Address on VRRP of the gateway.
Save	N/A	Click the Save button to save the configuration.
Undo	N/A	Click the Undo button to restore what you just configured back to the previous setting.

5G NR M2M Gateway

Chapter 3 Object Definition

3.1 Scheduling

Scheduling provides ability of adding/deleting time schedule rules, which can be applied to other functionality.

3.1.1 Scheduling Configuration

Go to **Object Definition > Scheduling > Configuration** tab.

Time Schedule List		
Add Delete		
ID	Rule Name	Actions

Button description		
Item	Value setting	Description
Add	N/A	Click the Add button to configure time schedule rule
Delete	N/A	Click the Delete button to delete selected rule(s)

When **Add** button is applied, Time Schedule Configuration and Time Period Definition screens will appear.

Time Schedule Configuration	
Item	Setting
▶ Rule Name	<input type="text"/>
▶ Rule Policy	<input type="text" value="Inactivate"/> the Selected Days and Hours Below.

Time Schedule Configuration		
Item	Value Setting	Description
Rule Name	String: any text	Set rule name
Rule Policy	Default Inactivate	Inactivate/activate the function been applied to in the time period below

5G NR M2M Gateway

Time Period Definition			
ID	Week Day	Start Time (hh:mm)	End Time (hh:mm)
1	-- choose one -- ▾	<input type="text"/>	<input type="text"/>
2	-- choose one -- ▾	<input type="text"/>	<input type="text"/>
3	-- choose one -- ▾	<input type="text"/>	<input type="text"/>
4	-- choose one -- ▾	<input type="text"/>	<input type="text"/>
5	-- choose one -- ▾	<input type="text"/>	<input type="text"/>
6	-- choose one -- ▾	<input type="text"/>	<input type="text"/>
7	-- choose one -- ▾	<input type="text"/>	<input type="text"/>
8	-- choose one -- ▾	<input type="text"/>	<input type="text"/>

Time Period Definition		
Item	Value Setting	Description
Week Day	Select from menu	Select everyday or one of weekday
Start Time	Time format (hh :mm)	Start time in selected weekday
End Time	Time format (hh :mm)	End time in selected weekday
Save	N/A	Click Save to save the settings
Undo	N/A	Click Undo to cancel the settings
Refresh	N/A	Click the Refresh button to refresh the time schedule list.

5G NR M2M Gateway

3.2 User (not supported)

Not supported feature for the purchased product, leave it as blank.

5G NR M2M Gateway

3.3 Grouping

The Grouping function allows user to make group for some services.

3.3.1 Host Grouping

Go to **Object Definition > Grouping > Host Grouping** tab.

The Host Grouping function allows user to make host group for some services, such as QoS, Firewall, and Communication Bus. The supported service types could be different for the purchased product.

Host Group List						
ID	Group Name	Group Type	Member List	Bound Services	Enable	Actions

When **Add** button is applied, **Host Group Configuration** screen will appear.

Host Group Configuration	
Item	Setting
▶ Group Name	<input type="text"/>
▶ Group Type	IP Address-based <input type="button" value="v"/>
▶ Member to Join	<input type="text"/> <input type="button" value="Join"/>
▶ Member List	
▶ Bound Services	<input type="checkbox"/> Firewall <input type="checkbox"/> QoS
▶ Group	<input type="checkbox"/> Enable

Host Group Configuration		
Item	Value setting	Description
Group Name	1. String format can be any text 2. A Must filled setting	Enter a group name for the rule. It is a name that is easy for you to understand.
Group Type	1. IP Address-based is selected by default. 2. A Must filled setting	Select the group type for the host group. It can be IP Address-based , MAC Address-based , or Host Name-based . When IP Address-based is selected, only IP address can be added in Member to Join . When MAC Address-based is selected, only MAC address can be added in Member to Join .

5G NR M2M Gateway

		<p>When Host Name-based is selected, only host name can be added in Member to Join.</p> <p>Note: The available Group Type can be different for the purchased model.</p>
Member to Join	N/A	<p>Add the members to the group in this field.</p> <p>You can enter the member information as specified in the Member Type above, and press the Join button to add.</p> <p>Only one member can be add at a time, so you have to add the members to the group one by one.</p>
Member List	NA	This field will indicate the hosts (members) contained in the group.
Bound Services	The boxes are unchecked by default	<p>Binding the services that the host group can be applied. If you enable the Firewall, the produced group can be used in firewall service. Same as by enable QoS, or other available service types.</p> <p>Note: The supported service type can be different for the purchased product.</p>
Group	The box is unchecked by default	Check the Enable checkbox to activate the host group rule. So that the group can be bound to selected service(s) for further configuration.
Save	N/A	Click Save to save the settings
Undo	N/A	Click Undo to cancel the settings

5G NR M2M Gateway

3.4 External Server

Go to **Object Definition > External Server > External Server** tab.

The External Server setting allows user to add external server.

Create External Server

External Server List Add Delete						
ID	Server Name	Server Type	Server IP/FQDN	Server Port	Server Enable	Actions

When **Add** button is applied, **External Server Configuration** screen will appear.

External Server Configuration	
Item	Setting
▶ Server Name	<input type="text"/>
▶ Server Type	Email Server <input type="text"/> User Name: <input type="text"/> Password: <input type="text"/>
▶ Server IP/FQDN	<input type="text"/>
▶ Server Port	<input type="text" value="25"/>
▶ Server	<input checked="" type="checkbox"/> Enable
Save Undo	

5G NR M2M Gateway

External Server Configuration

Item	Value setting	Description
Sever Name	1. String format can be any text 2. A Must filled setting	Enter a server name. Enter a name that is easy for you to understand.
Server Type	A Must filled setting	<p>Specify the Server Type of the external server, and enter the required settings for the accessing the server.</p> <hr/> <p>Email Server (A Must filled setting) : When Email Server is selected, User Name, and Password are also required. User Name (String format: any text) Password (String format: any text)</p> <hr/> <p>RADIUS Server (A Must filled setting) : When RADIUS Server is selected, the following settings are also required. Primary : Shared Key (String format: any text) Authentication Protocol (By default CHAP is selected) Session Timeout (By default 1) The values must be between 1 and 60. Idle Timeout: (By default 1) The values must be between 1 and 15. Secondary : Shared Key (String format: any text) Authentication Protocol (By default CHAP is selected) Session Timeout (By default 1) The values must be between 1 and 60. Idle Timeout: (By default 1) The values must be between 1 and 15.</p> <hr/> <p>Active Directory Server (A Must filled setting) : When Active Directory Server is selected, Domain setting is also required. Domain (String format: any text)</p> <hr/> <p>LDAP Server (A Must filled setting) : When LDAP Server is selected, the following settings are also required. Base DN (String format: any text) Identity (String format: any text) Password (String format: any text)</p> <hr/> <p>UAM Server (A Must filled setting) : When UAM Server is selected, the following settings are also required. Login URL (String format: any text) Shared Secret (String format: any text) NAS/Gateway ID (String format: any text) Location ID (String format: any text) Location Name (String format: any text)</p> <hr/> <p>TACACS+ Server (A Must filled setting) :</p>

5G NR M2M Gateway

		<p>When TACACS+ Server is selected, the following settings are also required.</p> <p>Shared Key (String format: any text)</p> <p>Session Timeout (String format: any number)</p> <p>The values must be between 1 and 60.</p> <hr/> <p>SCEP Server (A Must filled setting) :</p> <p>When SCEP Server is selected, the following settings are also required.</p> <p>Path (String format: any text, By default cgi-bin is filled)</p> <p>Application (String format: any text, By default pkiclient.exe is filled)</p> <hr/> <p>FTP(SFTP) Server (A Must filled setting) :</p> <p>When FTP(SFTP) Server is selected, the following settings are also required.</p> <p>User Name (String format: any text)</p> <p>Password (String format: any text)</p> <p>Protocol (Select FTP or SFTP)</p> <p>Encryprion (Select Plain, Explicit FTPS or Implicit FTPS)</p> <p>Transfer mode (Select Passive or Active)</p>
Server IP/FQDN	A Must filled setting	Specify the IP address or FQDN used for the external server.
Server Port	A Must filled setting	<p>Specify the Port used for the external server. If you selected a certain server type, the default server port number will be set.</p> <p>For Email Server 25 will be set by default;</p> <p>For Syslog Server, port 514 will be set by default;</p> <p>For RADIUS Server, port 1812, 1823 will be set by default;</p> <p>For Active Directory Server, port 389 will be set by default;</p> <p>For LDAP Server, port 389 will be set by default;</p> <p>For UAM Server, port 3990, 4990 will be set by default;</p> <p>For TACACS+ Server, port 49 will be set by default;</p> <p>For SCEP Server, port 80 will be set by default;</p> <p>For FTP(SFTP) Server, port 21 will be set by default;</p> <p>Value Range: 1 ~ 65535.</p>
Account Port	<p>1. A Must filled setting</p> <p>2. 1813 is set by default</p>	<p>Specify the accounting port used if you selected external RADIUS server.</p> <p>Value Range: 1 ~ 65535.</p>
Server	The box is checked by default	Click Enable to activate this External Server.
Save	N/A	Click Save to save the settings
Undo	N/A	Click Undo to cancel the settings
Refresh	N/A	Click the Refresh button to refresh the external server list.

5G NR M2M Gateway

3.5 Certificate

In cryptography, a public key certificate (also known as a digital certificate or identity certificate) is an electronic document used to prove ownership of a public key. The certificate includes information about the key, information about its owner's identity, and the digital signature of an entity that has verified the certificate's contents are genuine. If the signature is valid, and the person examining the certificate trusts the signer, then they know they can use that key to communicate with its owner⁵.

In a typical public-key infrastructure (PKI) scheme, the signer is a certificate authority (CA), usually a company such as VeriSign which charges customers to issue certificates for them. In a web of trust scheme, the signer is either the key's owner (a self-signed certificate) or other users ("endorsements") whom the person examining the certificate might know and trust. The device also plays as a CA role.

Certificates are an important component of Transport Layer Security (TLS, sometimes called by its older name SSL), where they prevent an attacker from impersonating a secure website or other server. They are also used in other important applications, such as email encryption and code signing. Here, it can be used in IPsec tunneling for user authentication.

3.5.1 Configuration

The configuration setting allows user to create Root Certificate Authority (CA) certificate and configure to set enable of SCEP. Root CA is the top-most certificate of the tree, the private key of which is used to "sign" other certificates.

Go to **Object Definition > Certificate > Configuration** tab.

Create Root CA



ID	Name	Subject	Issuer	Valid To	Action
----	------	---------	--------	----------	--------

When **Generate** button is applied, **Root CA Certificate Configuration** screen will appear. **The required information to be filled for the root CA includes the name, key, subject name and validity.**

⁵ http://en.wikipedia.org/wiki/Public_key_certificate.

5G NR M2M Gateway

Root CA Certificate Configuration	
Item	Setting
▶ Name	<input type="text"/>
▶ Key	Key Type : <input type="text" value="RSA"/> Key Length : <input type="text" value="512-bits"/> Digest Algorithm : <input type="text" value="MD5"/>
▶ Subject Name	Country(C) : <input type="text"/> State(ST) : <input type="text"/> Location(L) : <input type="text"/> Organization(O) : <input type="text"/> Organization Unit(OU) : <input type="text"/> Common Name(CN) : <input type="text"/> E-mail : <input type="text"/>
▶ Validity Period	<input type="text" value="20-years"/>

Root CA Certificate Configuration		
Item	Value setting	Description
Name	1. String format can be any text 2. A Must filled setting	Enter a Root CA Certificate name. It will be a certificate file name
Key	A Must filled setting	This field is to specify the key attribute of certificate. Key Type to set public-key cryptosystems. It only supports RSA now. Key Length to set s the size measured in bits of the key used in a cryptographic algorithm. Digest Algorithm to set identifier in the signature algorithm identifier of certificates
Subject Name	A Must filled setting	This field is to specify the information of certificate. Country(C) is the two-letter ISO code for the country where your organization is located. State(ST) is the state where your organization is located. Location(L) is the location where your organization is located. Organization(O) is the name of your organization. Organization Unit(OU) is the name of your organization unit. Common Name(CN) is the name of your organization. Email is the email of your organization. It has to be email address style.
Validity Period	A Must filled setting	This field is to specify the validity period of certificate.

5G NR M2M Gateway

Setup SCEP

SCEP Configuration	
Item	Setting
▶ SCEP	<input type="checkbox"/> Enable
▶ Automatically re-enroll aging certificates	<input type="checkbox"/> Enable

SCEP Configuration		
Item	Value setting	Description
SCEP	The box is unchecked by default	Check the Enable box to activate SCEP function.
Automatically re-enroll aging certificates	The box is unchecked by default	When SCEP is activated, check the Enable box to activate this function. It will be automatically check which certificate is aging. If certificate is aging, it will activate SCEP function to re-enroll automatically.
Save	N/A	Click Save to save the settings
Undo	N/A	Click Undo to cancel the settings

5G NR M2M Gateway

3.5.2 My Certificate

My Certificate includes a Local Certificate List. Local Certificate List shows all generated certificates by the root CA for the gateway. And it also stores the generated Certificate Signing Requests (CSR) which will be signed by other external CAs. The signed certificates can be imported as the local ones of the gateway.

Self-signed Certificate Usage Scenario

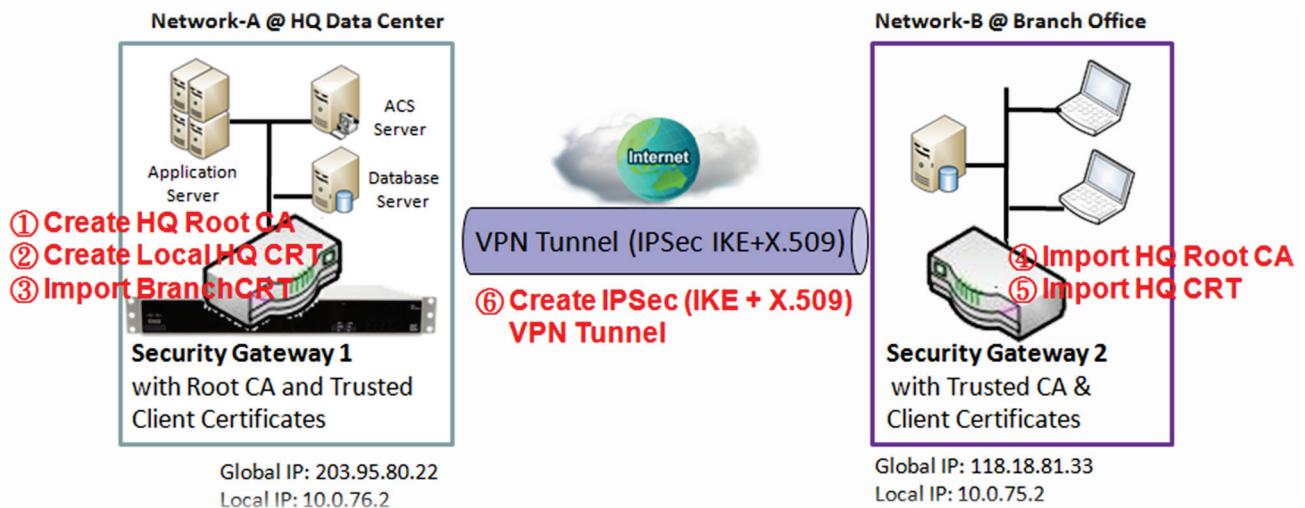

Scenario Application Timing

When the enterprise gateway owns the root CA and VPN tunneling function, it can generate its own local certificates by being signed by itself or import any local certificates that are signed by other external CAs. Also import the trusted certificates for other CAs and Clients. In addition, since it has the root CA, it also can sign Certificate Signing Requests (CSR) to form corresponding certificates for others. These certificates can be used for two remote peers to make sure their identity during establishing a VPN tunnel.

Scenario Description

Gateway 1 generates the root CA and a local certificate (HQCRT) signed by itself. Import a trusted certificate (BranchCRT) –a BranchCSR certificate of Gateway 2 signed by root CA of Gateway 1.

Gateway 2 creates a CSR (BranchCSR) to let the root CA of the Gateway 1 sign it to be the BranchCRT certificate. Import the certificate into the Gateway 2 as a local certificate. In addition, also import the certificates of the root CA of the Gateway 1 into the Gateway 2 as the trusted ones. (Please also refer to following two sub-sections)

Establish an IPSec VPN tunnel with IKE and X.509 protocols by starting from either peer, so that all client hosts in these both subnets can communicate with each other.

5G NR M2M Gateway

Parameter Setup Example

For Network-A at HQ

Following tables list the parameter configuration as an example for the "My Certificate" function used in the user authentication of IPsec VPN tunnel establishing, as shown in above diagram. The configuration example must be combined with the ones in following two sections to complete the whole user scenario.

Use default value for those parameters that are not mentioned in the tables.

Configuration Path	[My Certificate]-[Root CA Certificate Configuration]
Name	HQRootCA
Key	Key Type: RSA Key Length: 1024-bits
Subject Name	Country(C): TW State(ST): Taiwan Location(L): Tainan Organization(O): D-LINKHQ Organization Unit(OU): HQRD Common Name(CN): HQRootCA E-mail: hqrootca@D-Link.com.tw

Configuration Path	[My Certificate]-[Local Certificate Configuration]
Name	HQCRT Self-signed: <input checked="" type="checkbox"/>
Key	Key Type: RSA Key Length: 1024-bits
Subject Name	Country(C): TW State(ST): Taiwan Location(L): Tainan Organization(O): D-LINKHQ Organization Unit(OU): HQRD Common Name(CN): HQCRT E-mail: hqcert@D-Link.com.tw

Configuration Path	[IPSec]-[Configuration]
IPSec	<input checked="" type="checkbox"/> Enable

Configuration Path	[IPSec]-[Tunnel Configuration]
Tunnel	<input checked="" type="checkbox"/> Enable
Tunnel Name	s2s-101
Interface	WAN 1
Tunnel Scenario	Site to Site
Operation Mode	Always on

Configuration Path	[IPSec]-[Local & Remote Configuration]
Local Subnet	10.0.76.0
Local Netmask	255.255.255.0
Full Tunnel	Disable
Remote Subnet	10.0.75.0
Remote Netmask	255.255.255.0
Remote Gateway	118.18.81.33

Configuration Path	[IPSec]-[Authentication]
---------------------------	--------------------------

5G NR M2M Gateway

Key Management	<i>IKE+X.509</i> Local Certificate: <i>HQCRT</i> Remote Certificate: <i>BranchCRT</i>
Local ID	<i>User Name Network-A</i>
Remote ID	<i>User Name Network-B</i>

Configuration Path	[IPSec]-[IKE Phase]
Negotiation Mode	<i>Main Mode</i>
X-Auth	<i>None</i>

For Network-B at Branch Office

Following tables list the parameter configuration as an example for the "My Certificate" function used in the user authentication of IPSec VPN tunnel establishing, as shown in above diagram. The configuration example must be combined with the ones in following two sections to complete the whole user scenario.

Use default value for those parameters that are not mentioned in the tables.

Configuration Path	[My Certificate]-[Local Certificate Configuration]
Name	<i>BranchCRT</i> Self-signed: <input type="checkbox"/>
Key	Key Type: <i>RSA</i> Key Length: <i>1024-bits</i>
Subject Name	Country(C): <i>TW</i> State(ST): <i>Taiwan</i> Location(L): <i>Tainan</i> Organization(O): <i>D-LINKBranch</i> Organization Unit(OU): <i>BranchRD</i> Common Name(CN): <i>BranchCRT</i> E-mail: <i>branchcrt@D-Link.com.tw</i>

Configuration Path	[IPSec]-[Configuration]
IPSec	■ <i>Enable</i>

Configuration Path	[IPSec]-[Tunnel Configuration]
Tunnel	■ <i>Enable</i>
Tunnel Name	<i>s2s-102</i>
Interface	<i>WAN 1</i>
Tunnel Scenario	<i>Site to Site</i>
Operation Mode	<i>Always on</i>

Configuration Path	[IPSec]-[Local & Remote Configuration]
Local Subnet	<i>10.0.75.0</i>
Local Netmask	<i>255.255.255.0</i>
Full Tunnel	<i>Disable</i>
Remote Subnet	<i>10.0.76.0</i>
Remote Netmask	<i>255.255.255.0</i>
Remote Gateway	<i>203.95.80.22</i>

5G NR M2M Gateway

Configuration Path	[IPSec]-[Authentication]
Key Management	<i>IKE+X.509</i> Local Certificate: BranchCRT Remote Certificate: HQCRT
Local ID	<i>User Name</i> Network-B
Remote ID	<i>User Name</i> Network-A

Configuration Path	[IPSec]-[IKE Phase]
Negotiation Mode	<i>Main Mode</i>
X-Auth	<i>None</i>

Scenario Operation Procedure

In above diagram, "Gateway 1" is the gateway of Network-A in headquarters and the subnet of its Intranet is 10.0.76.0/24. It has the IP address of 10.0.76.2 for LAN interface and 203.95.80.22 for WAN-1 interface. "Gateway 2" is the gateway of Network-B in branch office and the subnet of its Intranet is 10.0.75.0/24. It has the IP address of 10.0.75.2 for LAN interface and 118.18.81.33 for WAN-1 interface. They both serve as the NAT security gateways.

Gateway 1 generates the root CA and a local certificate (HQCRT) that is signed by itself. Import the certificates of the root CA and HQCRT into the "Trusted CA Certificate List" and "Trusted Client Certificate List" of Gateway 2.

Gateway 2 generates a Certificate Signing Request (BranchCSR) for its own certificate (BranchCRT) (Please generate one not self-signed certificate in the Gateway 2, and click on the "View" button for that CSR. Just downloads it). Take the CSR to be signed by the root CA of Gateway 1 and obtain the BranchCRT certificate (you need rename it). Import the certificate into the "Trusted Client Certificate List" of the Gateway 1 and the "Local Certificate List" of Gateway 2.

Gateway 2 can establish an IPSec VPN tunnel with "Site to Site" scenario and IKE and X.509 protocols to Gateway 1.

Finally, the client hosts in two subnets of 10.0.75.0/24 and 10.0.76.0/24 can communicate with each other.

5G NR M2M Gateway

My Certificate Setting

Go to **Object Definition > Certificate > My Certificate** tab.

The My Certificate setting allows user to create local certificates. In "My Certificate" page, there are two configuration windows for the "My Certificate" function. The "Local Certificate List" window shows the stored certificates or CSRs for representing the gateway. The "Local Certificate Configuration" window can let you fill required information necessary for corresponding certificate to be generated by itself, or corresponding CSR to be signed by other CAs.

Create Local Certificate

Local Certificate List					
ID	Name	Subject	Issuer	Valid To	Actions

When **Add** button is applied, **Local Certificate Configuration** screen will appear. The required information to be filled for the certificate or CSR includes the name, key and subject name. It is a certificate if the "Self-signed" box is checked; otherwise, it is a CSR.

Local Certificate Configuration	
Item	Setting
▶ Name	<input type="text"/> Self-signed : <input type="checkbox"/>
▶ Key	Key Type : <input type="text" value="RSA"/> Key Length : <input type="text" value="1024-bits"/> Digest Algorithm : <input type="text" value="SHA-1"/>
▶ Subject Name	Country(C) : <input type="text"/> State(ST) : <input type="text"/> Location(L) : <input type="text"/> Organization(O) : <input type="text"/> Organization Unit(OU) : <input type="text"/> Common Name(CN) : <input type="text"/> E-mail : <input type="text"/>
▶ Extra Attributes	Challenge Password: <input type="text"/> Unstructured Name: <input type="text"/>
▶ SCEP Enrollment	Enable: <input type="checkbox"/> SCEP Server: <input type="text" value="--- Option ---"/> <input type="button" value="Add Object"/> CA Certificate: <input type="text" value="DWM-3010.crt"/> CA Encryption Certificate: <input type="text" value="--- Option ---"/> (Optional) CA Identifier: <input type="text"/> (Optional)

5G NR M2M Gateway

Local Certificate Configuration		
Item	Value setting	Description
Name	1. String format can be any text 2. A Must filled setting	Enter a certificate name. It will be a certificate file name If Self-signed is checked, it will be signed by root CA. If Self-signed is not checked, it will generate a certificate signing request (CSR).
Key	A Must filled setting	This field is to specify the key attributes of certificate. Key Type to set public-key cryptosystems. Currently, only RSA is supported. Key Length to set the length in bits of the key used in a cryptographic algorithm. It can be 512/768/1024/1536/2048. Digest Algorithm to set identifier in the signature algorithm identifier of certificates. It can be MD5/SHA-1.
Subject Name	A Must filled setting	This field is to specify the information of certificate. Country(C) is the two-letter ISO code for the country where your organization is located. State(ST) is the state where your organization is located. Location(L) is the location where your organization is located. Organization(O) is the name of your organization. Organization Unit(OU) is the name of your organization unit. Common Name(CN) is the name of your organization. Email is the email of your organization. It has to be email address setting only.
Extra Attributes	A Must filled setting	This field is to specify the extra information for generating a certificate. Challenge Password for the password you can use to request certificate revocation in the future. Unstructured Name for additional information.
SCEP Enrollment	A Must filled setting	This field is to specify the information of SCEP. If user wants to generate a certificate signing request (CSR) and then signed by SCEP server online, user can check the Enable box. Select a SCEP Server to identify the SCEP server for use. The server detailed information could be specified in External Servers. Refer to Object Definition > External Server > External Server . You may click Add Object button to generate, and the settings are the same as those defined in Section 3.4 External Server . Select a CA Certificate to identify which certificate could be accepted by SCEP server for authentication. It could be generated in Trusted Certificates. Select an optional CA Encryption Certificate , if it is required, to identify which certificate could be accepted by SCEP server for encryption data information. It could be generated in Trusted Certificates. Fill in optional CA Identifier to identify which CA could be used for signing certificates.
Save	N/A	Click the Save button to save the configuration.
Back	N/A	When the Back button is clicked, the screen will return to previous page.

5G NR M2M Gateway

When **Import** button is applied, an Import screen will appear. You can import a certificate from an existed certificate file, or directly paste a PEM encoded string as the certificate.

The screenshot shows two sections of the import interface. The top section is titled 'Import' and contains a 'Browse...' button and the text '未選擇檔案。' (No file selected). The bottom section is titled 'PEM Encoded' and contains a large empty text area for pasting a certificate string.

Import Item	Value setting	Description
Import	A Must filled setting	Select a certificate file from user's computer, and click the Apply button to import the specified certificate file to the gateway.
PEM Encoded	1. String format can be any text 2. A Must filled setting	This is an alternative approach to import a certificate. You can directly fill in (Copy and Paste) the PEM encoded certificate string, and click the Apply button to import the specified certificate to the gateway.
Apply	N/A	Click the Apply button to import the certificate.
Cancel	N/A	Click the Cancel button to discard the import operation and the screen will return to the My Certificates page.

5G NR M2M Gateway

3.5.3 Trusted Certificate

Trusted Certificate includes Trusted CA Certificate List, Trusted Client Certificate List, and Trusted Client Key List. The Trusted CA Certificate List places the certificates of external trusted CAs. The Trusted Client Certificate List places the others' certificates what you trust. And the Trusted Client Key List places the others' keys what you trusted.

Self-signed Certificate Usage Scenario

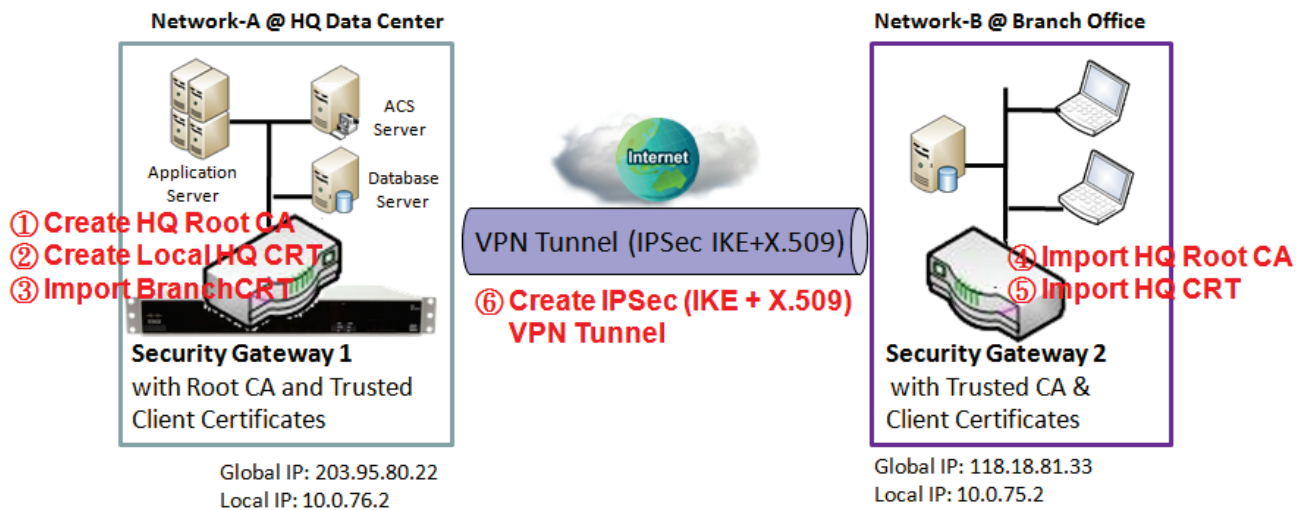

Scenario Application Timing (same as the one described in "My Certificate" section)

When the enterprise gateway owns the root CA and VPN tunneling function, it can generate its own local certificates by being signed by itself. Also imports the trusted certificates for other CAs and Clients. These certificates can be used for two remote peers to make sure their identity during establishing a VPN tunnel.

Scenario Description (same as the one described in "My Certificate" section)

Gateway 1 generates the root CA and a local certificate (HQCRT) signed by itself. Import a trusted certificate (BranchCRT) –a BranchCSR certificate of Gateway 2 signed by root CA of Gateway 1.

Gateway 2 creates a CSR (BranchCSR) to let the root CA of the Gateway 1 sign it to be the BranchCRT certificate. Import the certificate into the Gateway 2 as a local certificate. In addition, also imports the certificates of the root CA of Gateway 1 into the Gateway 2 as the trusted ones. (Please also refer to "My Certificate" and "Issue Certificate" sections).

Establish an IPSec VPN tunnel with IKE and X.509 protocols by starting from either peer, so that all client hosts in these both subnets can communicate with each other.

Parameter Setup Example (same as the one described in "My Certificate" section)

For Network-A at HQ

5G NR M2M Gateway

Following tables list the parameter configuration as an example for the "Trusted Certificate" function used in the user authentication of IPSec VPN tunnel establishing, as shown in above diagram. The configuration example must be combined with the ones in "My Certificate" and "Issue Certificate" sections to complete the setup for the whole user scenario.

Configuration Path	[Trusted Certificate]-[Trusted Client Certificate List]
Command Button	<i>Import</i>

Configuration Path	[Trusted Certificate]-[Trusted Client Certificate Import from a File]
File	<i>BranchCRT.crt</i>

For Network-B at Branch Office

Following tables list the parameter configuration as an example for the "Trusted Certificate" function used in the user authentication of IPSec VPN tunnel establishing, as shown in above diagram. The configuration example must be combined with the ones in "My Certificate" and "Issued Certificate" sections to complete the setup for the whole user scenario.

Configuration Path	[Trusted Certificate]-[Trusted CA Certificate List]
Command Button	<i>Import</i>

Configuration Path	[Trusted Certificate]-[Trusted CA Certificate Import from a File]
File	<i>HQRootCA.crt</i>

Configuration Path	[Trusted Certificate]-[Trusted Client Certificate List]
Command Button	<i>Import</i>

Configuration Path	[Trusted Certificate]-[Trusted Client Certificate Import from a File]
File	<i>HQCRT.crt</i>

Scenario Operation Procedure (same as the one described in "My Certificate" section)

In above diagram, the "Gateway 1" is the gateway of Network-A in headquarters and the subnet of its Intranet is 10.0.76.0/24. It has the IP address of 10.0.76.2 for LAN interface and 203.95.80.22 for WAN-1 interface. The "Gateway 2" is the gateway of Network-B in branch office and the subnet of its Intranet is 10.0.75.0/24. It has the IP address of 10.0.75.2 for LAN interface and 118.18.81.33 for WAN-1 interface. They both serve as the NAT security gateways.

In Gateway 2 import the certificates of the root CA and HQCRT that were generated and signed by Gateway 1 into the "Trusted CA Certificate List" and "Trusted Client Certificate List" of Gateway 2.

Import the obtained BranchCRT certificate (the derived BranchCSR certificate after Gateway 1's root CA signature) into the "Trusted Client Certificate List" of the Gateway 1 and the "Local Certificate List" of

5G NR M2M Gateway

the Gateway 2. For more details, refer to the Network-B operation procedure in "My Certificate" section of this manual.

Gateway 2 can establish an IPSec VPN tunnel with "Site to Site" scenario and IKE and X.509 protocols to Gateway 1.

Finally, the client hosts in two subnets of 10.0.75.0/24 and 10.0.76.0/24 can communicate with each other.

5G NR M2M Gateway

Trusted Certificate Setting

Go to **Object Definition > Certificate > Trusted Certificate** tab.

The Trusted Certificate setting allows user to import trusted certificates and keys.

Import Trusted CA Certificate

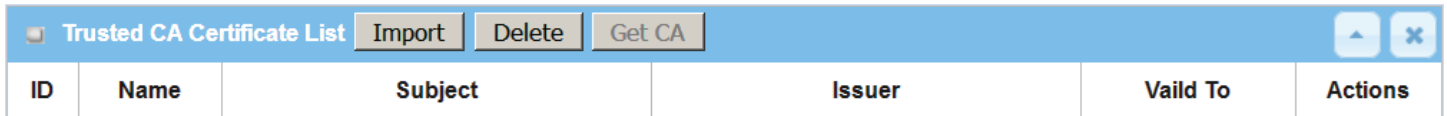

ID	Name	Subject	Issuer	Valid To	Actions
----	------	---------	--------	----------	---------

When **Import** button is applied, a **Trusted CA import** screen will appear. You can import a Trusted CA certificate from an existed certificate file, or directly paste a PEM encoded string as the certificate.

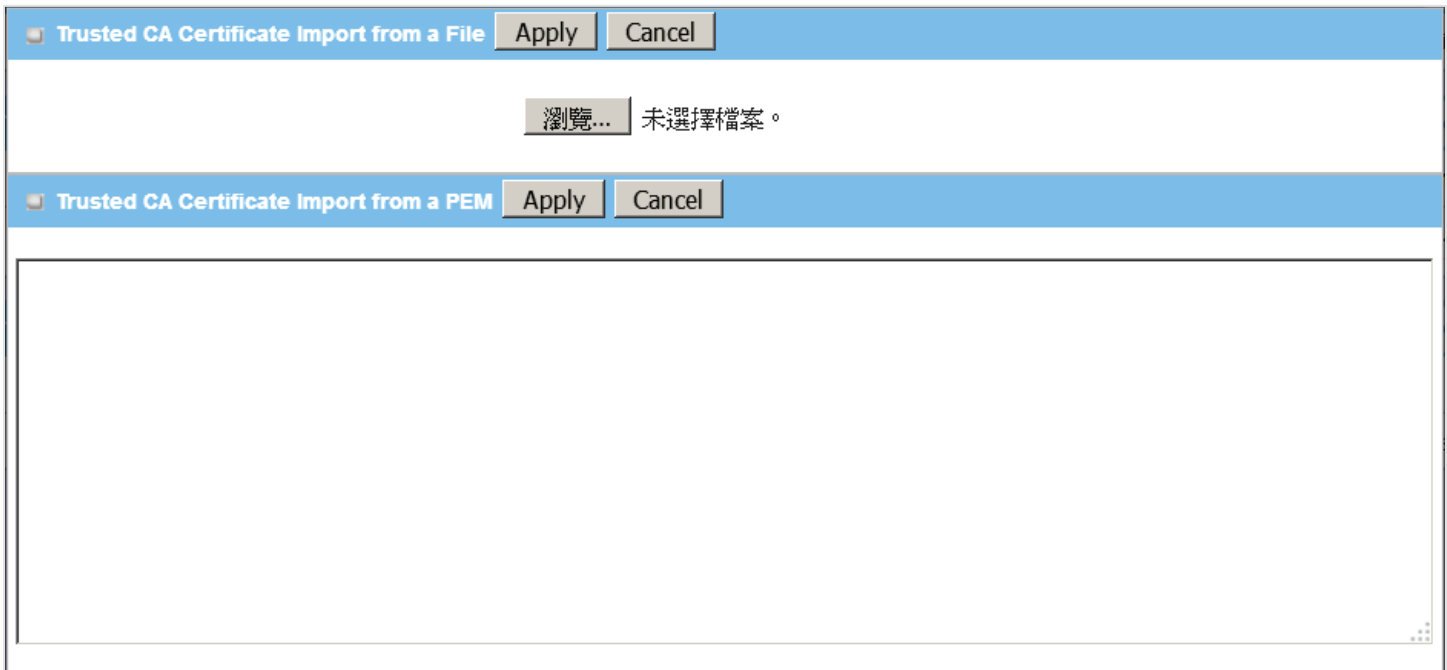

Trusted CA Certificate List		
Item	Value setting	Description
Import from a File	A Must filled setting	Select a CA certificate file from user's computer, and click the Apply button to import the specified CA certificate file to the gateway.
Import from a PEM	1. String format can be any text 2. A Must filled setting	This is an alternative approach to import a CA certificate. You can directly fill in (Copy and Paste) the PEM encoded CA certificate string, and click the Apply button to import the specified CA certificate to the gateway.
Apply	N/A	Click the Apply button to import the certificate.
Cancel	N/A	Click the Cancel button to discard the import operation and the screen will return to the Trusted Certificates page.

5G NR M2M Gateway

Instead of importing a Trusted CA certificate with mentioned approaches, you can also get the CA certificate from the SECP server.

If **SCEP** is enabled (Refer to **Object Definition > Certificate > Configuration**), you can click **Get CA** button, a Get CA Configuration screen will appear.

Item	Setting
▶ SCEP Server	--- Option --- ▼ <input type="button" value="Add Object"/>
▶ CA Identifier	<input type="text"/> (Optional)

Get CA Configuration		
Item	Value setting	Description
SCEP Server	A Must filled setting	Select a SCEP Server to identify the SCEP server for use. The server detailed information could be specified in External Servers. Refer to Object Definition > External Server > External Server . You may click Add Object button to generate.
CA Identifier	1. String format can be any text	Fill in optional CA Identifier to identify which CA could be used for signing certificates.
Save	N/A	Click Save to save the settings.
Close	N/A	Click the Close button to return to the Trusted Certificates page.

Import Trusted Client Certificate

ID	Name	Subject	Issuer	Vaild To	Actions
----	------	---------	--------	----------	---------

When **Import** button is applied, a **Trusted Client Certificate Import** screen will appear. You can import a Trusted Client Certificate from an existed certificate file, or directly paste a PEM encoded string as the certificate.

5G NR M2M Gateway

Trusted Client Certificate Import from a File
Apply
Cancel

瀏覽... 未選擇檔案。

Trusted Client Certificate Import from a PEM
Apply
Cancel

Trusted Client Certificate List		
Item	Value setting	Description
Import from a File	A Must filled setting	Select a certificate file from user's computer, and click the Apply button to import the specified certificate file to the gateway.
Import from a PEM	1. String format can be any text 2. A Must filled setting	This is an alternative approach to import a certificate. You can directly fill in (Copy and Paste) the PEM encoded certificate string, and click the Apply button to import the specified certificate to the gateway.
Apply	N/A	Click the Apply button to import certificate.
Cancel	N/A	Click the Cancel button to discard the import operation and the screen will return to the Trusted Certificates page.

Import Trusted Client Key

Trusted Client Key List
Import
Delete
▲ ✕

ID	Name	Actions

When **Import** button is applied, a **Trusted Client Key Import** screen will appear. You can import a Trusted Client Key from an existed file, or directly paste a PEM encoded string as the key.

5G NR M2M Gateway

Trusted Client Key Import from a File
Apply
Cancel

瀏覽... 未選擇檔案。

Trusted Client Key Import from a PEM
Apply
Cancel

Trusted Client Key List		
Item	Value setting	Description
Import from a File	A Must filled setting	Select a certificate key file from user's computer, and click the Apply button to import the specified key file to the gateway.
Import from a PEM	1. String format can be any text 2. A Must filled setting	This is an alternative approach to import a certificate key. You can directly fill in (Copy and Paste) the PEM encoded certificate key string, and click the Apply button to import the specified certificate key to the gateway.
Apply	N/A	Click the Apply button to import the certificate key.
Cancel	N/A	Click the Cancel button to discard the import operation and the screen will return to the Trusted Certificates page.

5G NR M2M Gateway

3.5.4 Issue Certificate

When you have a Certificate Signing Request (CSR) that needs to be certificated by the root CA of the device, you can issue the request here and let Root CA sign it. There are two approaches to issue a certificate. One is from a CSR file importing from the managing PC and another is copy-paste the CSR codes in gateway's web-based utility, and then click on the "Sign" button.

If the gateway signs a CSR successfully, the "Signed Certificate View" window will show the resulted certificate contents. In addition, a "Download" button is available for you to download the certificate to a file in the managing PC.

Self-signed Certificate Usage Scenario

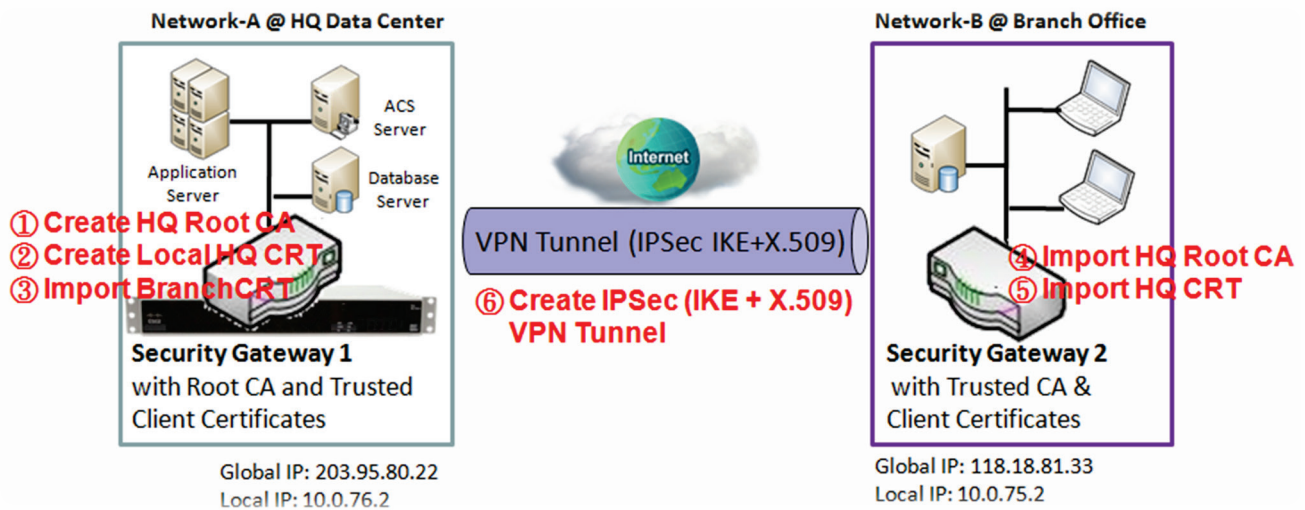

Scenario Application Timing (same as the one described in "My Certificate" section)

When the enterprise gateway owns the root CA and VPN tunneling function, it can generate its own local certificates by being signed by itself. Also imports the trusted certificates for other CAs and Clients. These certificates can be used for two remote peers to make sure their identity during establishing a VPN tunnel.

Scenario Description (same as the one described in "My Certificate" section)

Gateway 1 generates the root CA and a local certificate (HQCRT) signed by itself. Also imports a trusted certificate (BranchCRT) –a BranchCSR certificate of Gateway 2 signed by root CA of Gateway 1.

Gateway 2 creates a CSR (BranchCSR) to let the root CA of the Gateway 1 sign it to be the BranchCRT certificate. Import the certificate into the Gateway 2 as a local certificate. In addition, also imports the certificates of the root CA of the Gateway 1 into the Gateway 2 as the trusted ones. (Please also refer to "My Certificate" and "Trusted Certificate" sections).

5G NR M2M Gateway

Establish an IPSec VPN tunnel with IKE and X.509 protocols by starting from either peer, so that all client hosts in these both subnets can communicate with each other.

Parameter Setup Example (same as the one described in "My Certificate" section)

For Network-A at HQ

Following tables list the parameter configuration as an example for the "Issue Certificate" function used in the user authentication of IPSec VPN tunnel establishing, as shown in above diagram. The configuration example must be combined with the ones in "My Certificate" and "Trusted Certificate" sections to complete the setup for whole user scenario.

Configuration Path	[Issue Certificate]-[Certificate Signing Request Import from a File]
Browse	C:/BranchCSR
Command Button	Sign

Configuration Path	[Issue Certificate]-[Signed Certificate View]
Command Button	Download (default name is "issued.crt")

Scenario Operation Procedure (same as the one described in "My Certificate" section)

In above diagram, the "Gateway 1" is the gateway of Network-A in headquarters and the subnet of its Intranet is 10.0.76.0/24. It has the IP address of 10.0.76.2 for LAN interface and 203.95.80.22 for WAN-1 interface. The "Gateway 2" is the gateway of Network-B in branch office and the subnet of its Intranet is 10.0.75.0/24. It has the IP address of 10.0.75.2 for LAN interface and 118.18.81.33 for WAN-1 interface. They both serve as the NAT security gateways.

Gateway 1 generates the root CA and a local certificate (HQCRT) that is signed by itself. Import the certificates of the root CA and HQCRT into the "Trusted CA Certificate List" and "Trusted Client Certificate List" of Gateway 2.

Gateway 2 generates a Certificate Signing Request (BranchCSR) for its own certificate BranchCRT to be signed by root CA (Please generate one not self-signed certificate in the Gateway 2, and click on the "View" button for that CSR. Just downloads it). Take the CSR to be signed by the root CA of the Gateway 1 and obtain the BranchCRT certificate (you need rename it). Import the certificate into the "Trusted Client Certificate List" of the Gateway 1 and the "Local Certificate List" of the Gateway 2.

Gateway 2 can establish an IPSec VPN tunnel with "Site to Site" scenario and IKE and X.509 protocols to Gateway 1.

Finally, the client hosts in two subnets of 10.0.75.0/24 and 10.0.76.0/24 can communicate with each other.

Issue Certificate Setting

5G NR M2M Gateway

Go to **Object Definition > Certificate > Issue Certificate** tab.

The Issue Certificate setting allows user to import Certificate Signing Request (CSR) to be signed by root CA.

Import and Issue Certificate

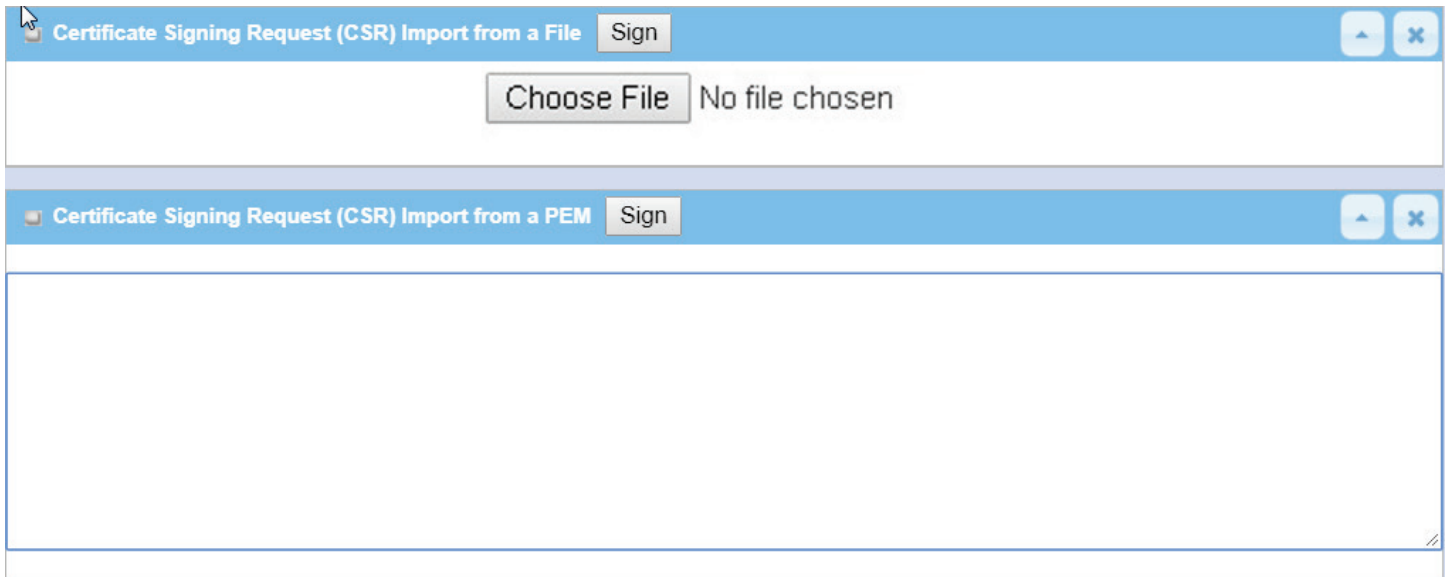

Certificate Signing Request (CSR) Import from a File Item	Value setting	Description
Certificate Signing Request (CSR) Import from a File	A Must filled setting	Select a certificate signing request file you're your computer for importing to the gateway.
Certificate Signing Request (CSR) Import from a PEM	1. String format can be any text 2. A Must filled setting	Enter (copy-paste) the certificate signing request PEM encoded certificate to the gateway.
Sign	N/A	When root CA is exist, click the Sign button sign and issue the imported certificate by root CA.

5G NR M2M Gateway

Chapter 4 Field Communication

4.1 Bus & Protocol

The gateway may equip one or more serial port(s) for various serial communication use through connecting the RS-232 or RS-485 serial devices to an IP-based Ethernet LAN. These communication protocols make user access serial devices anywhere over a local LAN or the Internet easily. They can be "Virtual COM" and "Modbus".

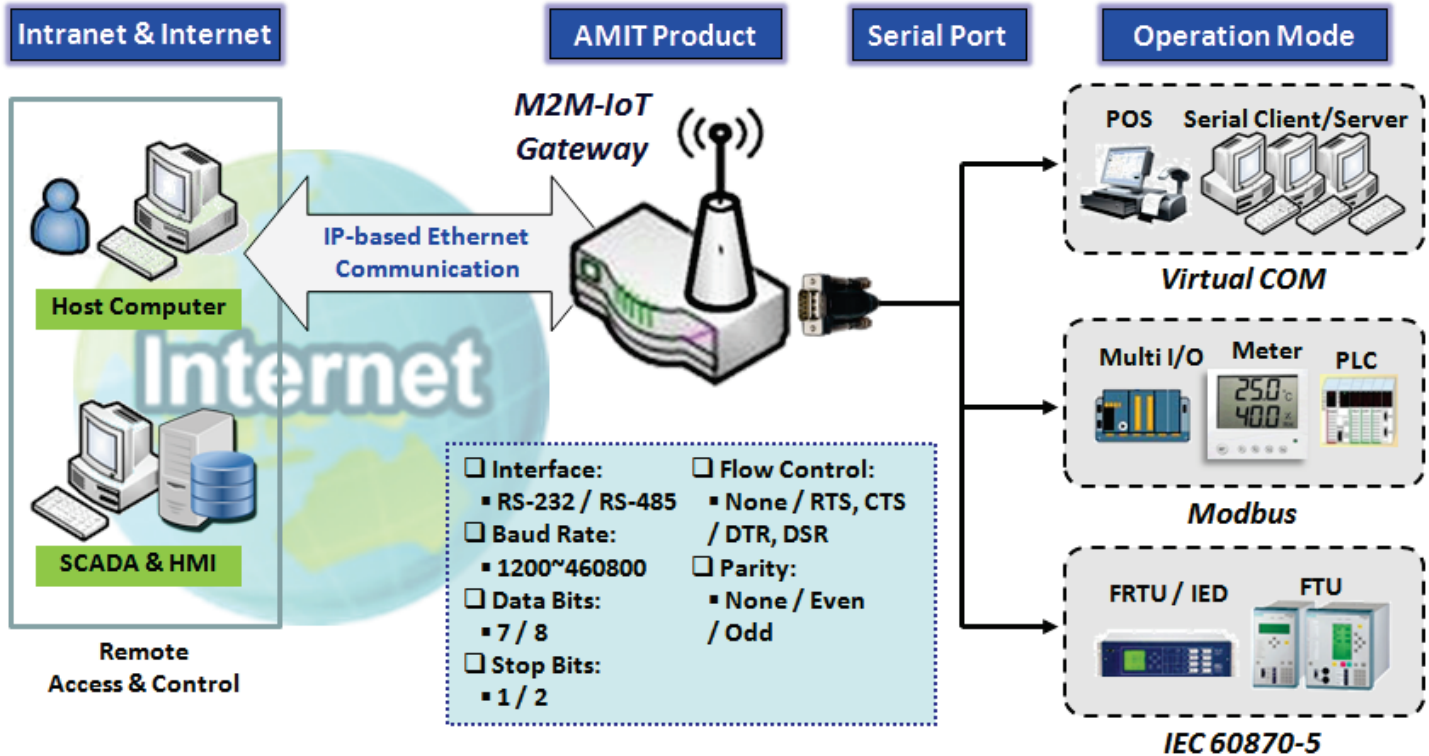

4.1.1 Port Configuration

Before using the supported field communication function, like Virtual COM or Modbus, you need to configure the physical communication port first.

The port configuration screen allows user to configure the operation mode and physical layer settings for each serial interface, and also can quick switch from one communication protocol to another for the serial port. The number of ports and type of the supported protocols could be different for the purchased gateway model.

5G NR M2M Gateway

Port Configuration Setting

Go to **Field Communication > Bus & Protocol > Port Configuration** tab.

In "Port Configuration" page, there is only one configuration window for the serial port settings. The "Configuration" window can let you specify serial port parameters including the operation mode being "Virtual COM", "Modbus" or disabled, the interface, the baud rate, the data bit length, the stop bit length, the flow control being "RTS/CTS", "DTS/DSR" or "None", and the parity.

Serial Port Definition								
Serial Port	Operation Mode	Interface	Baud Rate	Data Bits	Stop Bits	Flow Control	Parity	Action
SPort-0	Disable	RS-232	9600	8	1	None	None	<input type="button" value="Edit"/>

Port Configuration Window		
Item	Value setting	Description
Serial Port	N/A	It displays the serial port ID of the serial port. The number of serial ports varies from the purchased model.
Operation Mode	Disable is set by default	Select the operation mode for the serial interface. The available modes can be Disable, Virtual COM or Modbus.
Interface	RS-232 is set by default	Select the physical interface type for connecting to the access device(s) with the same interface specification. Depending on the purchase model, the supported interface type could be RS-232 or RS-485.
Baud Rate	9600 is set by default	Select the appropriate baud rate for serial device communication. RS-232: 1200 / 2400 / 4800 / 9600 / 19200 / 38400 / 57600 / 115200 RS-485 can use higher baud rate for 230400 and 460800. It depends on the cable length and the installed environment. The longer cable, the lower baud rate for it.
Data Bits	8 is set by default	Select 8 or 7 for data bits.
Stop Bits	1 is set by default	Select 1 or 2 for stop bits.
Flow Control	None is set by default	Select None / RTS, CTS / DTS, DSR for Flow Control in RS-232 mode. The supporting of Flow Control depends on the purchased model.
Parity	None is set by default	Select None / Even / Odd for Parity bit.
Action	N/A	Click Edit button to change the operation mode, or modify the parameters mentioned above for the serial interface communication.
Save	N/A	Click Save button to save the settings.
Undo	N/A	Click Undo button to cancel the settings.

5G NR M2M Gateway

4.1.2 Virtual COM

Create a virtual COM port on user's PC/Host to provide access to serial device connected to the serial port on gateway. Therefore, users can access, control, and manage the connected serial device through Internet (fixed line, or cellular network) anywhere. This application is also known as Ethernet pass-through communication.

Operation Mode Definition for each Serial Port									
Serial Port	Operation Mode	Listen Port	Trust Type	Max Connection	Connection Control	Connection Idle Timeout	Alive Check Timeout	Enable	Action
SPort-0	Disable	N/A	N/A	N/A	N/A	N/A	N/A	<input type="checkbox"/>	Edit

Virtual COM setting screen enables user to connect a Virtual COM port based device to the Internet. It allows user to access serial data remotely. There are Disable, TCP Client, TCP Server, UDP, and RFC2217 modes for remote accessing the connected serial device. These operation modes are illustrated as below.

TCP Client Mode

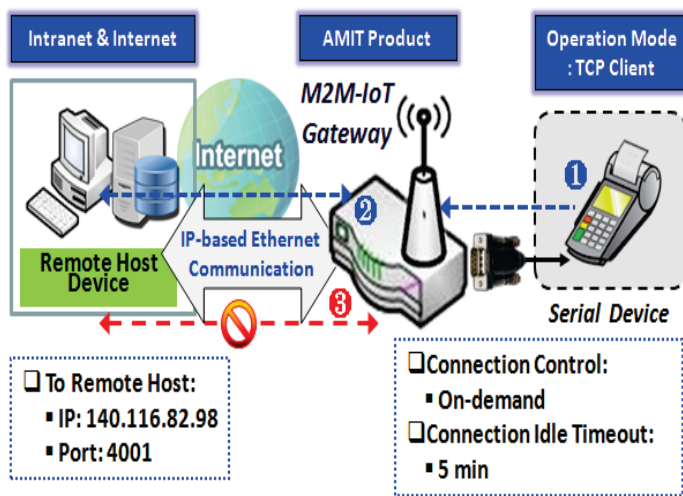

- ① Gateway get Data received from Serial Device.
- ② Establish a TCP Connection and Transmit Data to Remote Host.
- ③ Terminate this TCP Connection once Idle Timeout reached 5 mins.

When the administrator expects the gateway to actively establish a TCP connection to a pre-defined host computer when serial data arrives, the operation mode for the "Virtual COM" function is required to be "TCP Client" and when the connection control of virtual COM is "On-demand", once the gateway receives data from the connected serial device, it will establish a TCP connection to transfer the received serial data to the remote host. Besides, after the data has been transferred, the gateway automatically disconnects the established TCP session from the host computer by using the TCP alive check timeout or idle timeout settings.

5G NR M2M Gateway

TCP Server Mode

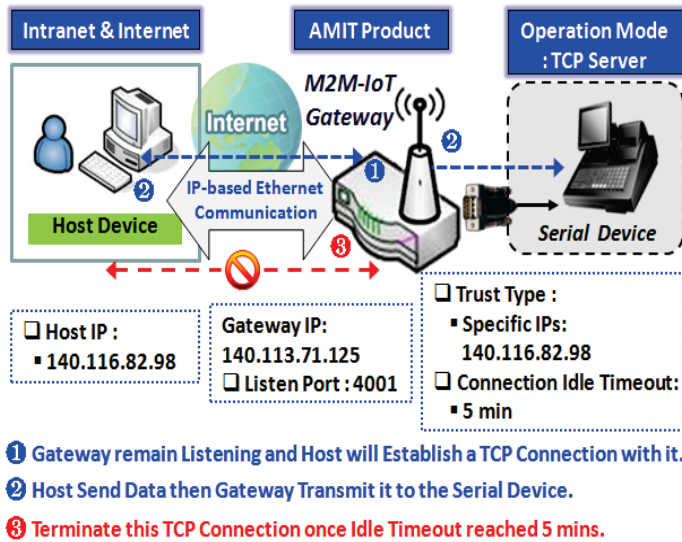

When the administrator expects the gateway to wait passively for the serial data requests from the Host Device (usually we use a computer to play as a Host), and the Host will establish a TCP connection to get data from the serial device, the operation mode for the "Virtual COM" function is required to be "TCP Server". In this mode, the gateway provides a unique "IP: Port" address on a TCP/IP network. It supports up to 4 simultaneous connections, so that multiple hosts can collect data from the same serial device at the same time. After the data has been transferred, the TCP connection will be automatically disconnected from the host computer by using the TCP alive check timeout or idle timeout settings.

UDP Mode

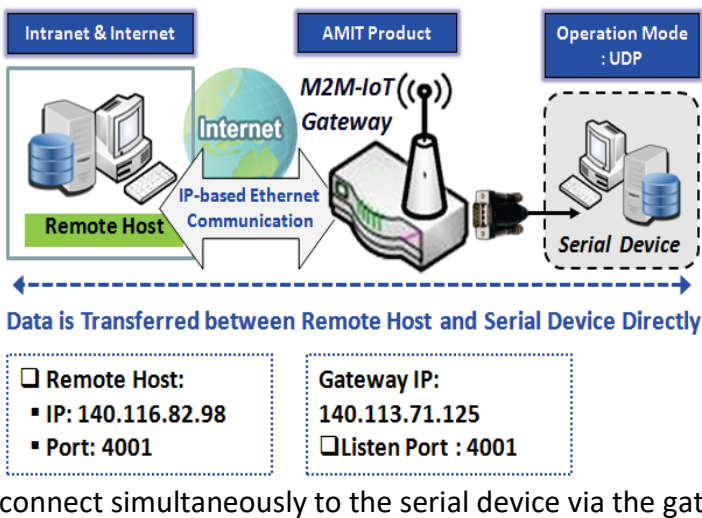

If both the Remote Host Computer and the serial device are expected to initiate a data transfer when it requires doing that, the operation mode for the "Virtual COM" function in the gateway is required to be "UDP". In this mode, the UDP data can be transferred between the gateway and multiple host computers from either peer, making this mode ideal for message display applications.

The remote host computer can directly send UDP data to the serial device via the gateway, and also receive UDP data from the serial device via the gateway at the same time. The gateway supports up to 4 legal hosts to connect simultaneously to the serial device via the gateway.

5G NR M2M Gateway

RFC-2217 Mode

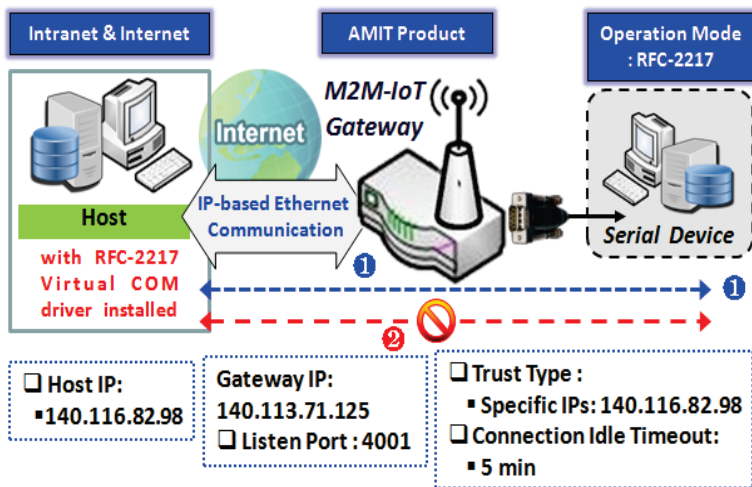

① Send data to each other directly via a transparent connection established

② Terminate this Connection once Idle Timeout reached 5 mins.

RFC-2217 defines general COM port control options based on telnet protocol. A host computer with RFC-2217 driver installed can monitor and manage the remote serial device attached to the gateway's serial port, as though they were connected to the local serial port. When a virtual serial port on the local serial device is being created, it is required to specify the IP-address of the host computers to establish connection with.

Any 3rd party driver supporting RFC2217 can be used to install in the host computer, the driver establishes a transparent connection between host and serial device by mapping the IP:Port of the gateway's serial port to a virtual local COM

port on the host computer.

The host computer can directly send data to the serial device via the gateway, and also receive data from the serial device via the gateway at the same time. The gateway supports up to 4 Internet host computers.

5G NR M2M Gateway

Virtual COM Setting

Virtual COM setting screen enables user to connect a Virtual COM port based device to the Internet. It allows user to access serial data remotely. There are Disable, TCP Client, TCP Server, UDP, and RFC2217 modes for remote accessing the connected serial device. By default, it is configured in Disable mode.

To use the Virtual COM function, you have to specify the operation mode for the multi-function serial port first. Go to **Field Communication > Bus & Protocol > Port Configuration** tab, select the Virtual COM as expected operation mode, and finish the related port configuration as well.

After that, go to **Field Communication > Bus & Protocol > Virtual COM** tab for detailed configuration of Virtual COM setting.

Enable TCP Client Mode

Configure the gateway as the TCP (Transmission Control Protocol) Client. In TCP Client mode, device initiates a TCP connection with a TCP server when there is data to transmit. Device disconnects from the server when the connection is Idle for a specified period. You may also enable full time connection with the TCP server.

Operation Mode Definition for each Serial Port									
Serial Port	Operation Mode	Listen Port	Trust Type	Max Connection	Connection Control	Connection Idle Timeout	Alive Check Timeout	Enable	Action
SPort-0	TCP Client ▼	4001 (1~65535)	Allow All ▼	1	Always on ▼	0 (0-3600secs)	0 (0-3600secs)	<input type="checkbox"/>	Edit

Enable TCP Client Mode Window		
Item	Value setting	Description
Operation Mode	A Must filled setting	Select TCP Client .
Connection Control	Always on is set by default	Choose Always on for a TCP full time connection. Otherwise, choose On-Demand to initiate TCP connection only when required to transmit and disconnect at idle timeout.
Connection Idle Timeout	1. 0 is set by default 2. Range 0 to 3600 sec.	Enter the idle timeout in minutes. The idle timeout is used to disconnect the TCP connection when idle time elapsed . Idle timeout is only available when On-Demand is selected in the Connection Control field. Value Range: 0 ~ 3600 seconds.
Alive Check Timeout	1. 0 is set by default 2. Range 0 to 3600 sec.	Enter the time period of alive check timeout. The TCP connection will be terminated if it doesn't receive response of alive-check longer than this timeout setting Alive check timeout is only available when On-Demand is selected in the Connection Control field. Value Range: 0 ~ 3600 seconds.
Enable	The box is unchecked by default.	Check the Enable box to activate the corresponding serial port in specified operation mode.
Save	N/A	Click the Save button to save the configuration

5G NR M2M Gateway

Specify Data Packing Parameters

Data Packing (for TCP Client, TCP Server and UDP operation mode)				
Serial Port	Data Buffer Length	Delimiter Character 1	Delimiter Character 2	Data Timeout Transmit
SPort-0	<input type="text" value="0"/> (0~1024)	<input type="text" value="0"/> (Hex) <input type="checkbox"/> Enable	<input type="text" value="0"/> (Hex) <input type="checkbox"/> Enable	<input type="text" value="0"/> (0~1000ms)

Data Packing Configuration		
Item	Value setting	Description
Data Buffer Length	1.An optional filled setting 2.Default value is 0	Enter the data buffer length for the serial port. Value Range: 0 ~ 1024.
Delimiter Character 1	1.An optional filled setting 2.Default value is 0	Check the Enable box to activate the Delimiter character 1, and enter the Hex code for it. Value Range: 0x00 ~ 0xFF.
Delimiter Character 2	1.An optional filled setting 2.Default value is 0	Check the Enable box to activate the Delimiter character 2, and enter the Hex code for it. Value Range: 0x00 ~ 0xFF.
Data Timeout Transmit	1.An optional filled setting 2.Default value is 0	Enter the data timeout interval for transmitting serial data through the port. By default, it is set to 0 and the timeout function is disabled. Value Range: 0 ~ 1000ms.
Save	N/A	Click the Save button to save the configuration

Specify Remote TCP Server

Legal Host IP/ FQDN Definition (for TCP Client operation mode)					
ID	To Remote Host	Remote Port	Serial Port	Definition Enable	Action
1		4001	SPort-0	<input type="checkbox"/>	<input type="button" value="Edit"/>
2		4001	SPort-0	<input type="checkbox"/>	<input type="button" value="Edit"/>
3		4001	SPort-0	<input type="checkbox"/>	<input type="button" value="Edit"/>
4		4001	SPort-0	<input type="checkbox"/>	<input type="button" value="Edit"/>

Specify TCP Server Window		
Item	Value setting	Description
To Remote Host	A Must filled setting	Press Edit button to enter IP address or FQDN of the remote TCP server to transmit serial data.
Remote Port	1.A Must filled setting 2.Default value is 4001	Enter the TCP port number. This is the listen port of the remote TCP server. Value Range: 1 ~ 65535.
Serial Port	SPort-0 is set by default	Apply the TCP server connection for a selected serial port. Up to 4 TCP servers can be configured at the same time for each serial port.
Definition Enable	The box is unchecked by default	Check the Enable box to enable the TCP server configuration.
Save	N/A	Click the Save button to save the configuration

5G NR M2M Gateway

Enable TCP Server Mode

Configure the gateway as the TCP (Transmission Control Protocol) Server. The TCP Server waits for connections to be initiated by a remote TCP client device to receive serial data. The setting allows user to specify specific TCP clients or allow any to send serial data for serial data transmission bandwidth control and access control. The TCP Server supports up to 128 simultaneous connections to receive serial data from multiple TCP clients.

Operation Mode Definition for each Serial Port									
Serial Port	Operation Mode	Listen Port	Trust Type	Max Connection	Connection Control	Connection Idle Timeout	Alive Check Timeout	Enable	Action
SPort-0	TCP Server ▼	4001 (1~65535)	Allow All ▼	1	Always on ▼	0 (0-3600secs)	0 (0-3600secs)	<input type="checkbox"/>	Edit

Enable TCP Server Mode Window		
Item	Value setting	Description
Operation Mode	A Must filled setting	Select TCP Server mode.
Listen Port	4001 is set by default	Indicate the listening port of TCP connection. Value Range: 1 ~ 65535.
Trust Type	Allow All is set by default	Choose Allow All to allow any TCP clients to connect. Otherwise choose Specific IP to limit certain TCP clients.
Max Connection	1. Max. 128 connections 2. 1 is set by default	Set the maximum number of concurrent TCP connections. Up to 128 simultaneous TCP connections can be established. Value Range: 1 ~ 128.
Connection Idle Timeout	1. 0 is set by default 2. Range 0 to 3600 sec.	Enter the idle timeout in minutes. The idle timeout is used to disconnect the TCP connection when idle time elapsed . Idle timeout is only available when On-Demand is selected in the Connection Control field. Value Range: 0 ~ 3600 seconds.
Alive Check Timeout	1. 0 is set by default 2. Range 0 to 3600 sec.	Enter the time period of alive check timeout. The TCP connection will be terminated if it doesn't receive response of alive-check longer than this timeout setting Alive check timeout is only available when On-Demand is selected in the Connection Control field. Value Range: 0 ~ 3600 seconds.
Enable	The box is unchecked by default.	Check the Enable box to activate the corresponding serial port in specified operation mode.
Save	N/A	Click Save button to save the settings.

5G NR M2M Gateway

Specify TCP Clients for TCP Server Access

If you selected **Specific IPs** as the trust Type, the Trusted IP Definition window appears. The settings are valid for both TCP Server and RFC-2217 modes.

Trusted IP Definition (for TCP Server & RFC-2217 operation mode)				
ID	Host	Serial Port	Definition Enable	Action
1			<input type="checkbox"/>	Edit
2			<input type="checkbox"/>	Edit
3			<input type="checkbox"/>	Edit
4			<input type="checkbox"/>	Edit
5			<input type="checkbox"/>	Edit
6			<input type="checkbox"/>	Edit
7			<input type="checkbox"/>	Edit
8			<input type="checkbox"/>	Edit

Specify TCP Clients Window		
Item	Value setting	Description
Host	A Must filled setting	Enter the IP address range of allowed TCP clients.
Serial Port	The box is unchecked by default	Check the box to specify the rule for selected Serial Port.
Definition Enable	The box is unchecked by default	Check the Enable box to enable the rule.
Save	N/A	Click Save to save the settings
Undo	N/A	Click Undo to cancel the settings

5G NR M2M Gateway

Enable UDP Mode

UDP (User Datagram Protocol) enables applications using UDP socket programs to communicate with the serial ports on the serial server. The UDP mode provides connectionless communications, which enable you to multicast data from the serial device to multiple host computers, and vice versa, making this mode ideal for message display applications.

Operation Mode Definition for each Serial Port									
Serial Port	Operation Mode	Listen Port	Trust Type	Max Connection	Connection Control	Connection Idle Timeout	Alive Check Timeout	Enable	Action
SPort-0	UDP	4001 (1~65535)	Allow All	1	Always on	0 (0-3600secs)	0 (0-3600secs)	<input type="checkbox"/>	Edit

Enable UDP Mode Window		
Item	Value setting	Description
Operation Mode	A Must filled setting	Select UDP mode.
Listen Port	4001 is set by default	Indicate the listening port of UDP connection. Value Range: 1 ~ 65535
Enable	The box is unchecked by default.	Check the Enable box to activate the corresponding serial port in specified operation mode.
Save	N/A	Click Save to save the settings
Undo	N/A	Click Undo to cancel the settings

Specify Remote UDP

Legal Host IP Definition (for UDP operation mode)					
ID	Remote Host	Remote Port	Serial Port	Definition Enable	Action
1		4001	SPort-0	<input type="checkbox"/>	Edit
2		4001	SPort-0	<input type="checkbox"/>	Edit
3		4001	SPort-0	<input type="checkbox"/>	Edit
4		4001	SPort-0	<input type="checkbox"/>	Edit

Specify Remote UDP hosts Window		
Item	Value setting	Description
Host	A Must filled setting	Press Edit button to enter IP address range of remote UDP hosts.
Remote Port	4001 is set by default	Indicate the UDP port of peer UDP hosts. Value Range: 1 ~ 65535
Serial Port	SPort-0 is set by default	Apply the UDP hosts for a selected serial port. Up to 4 UDP servers can be configured at the same time for each serial port.
Definition Enable	The box is unchecked by default	Check the Enable box to enable the rule.
Save	N/A	Click Save to save the settings
Undo	N/A	Click Undo to cancel the settings

5G NR M2M Gateway

Enable RFC-2217 Mode

RFC-2217 defines general COM port control options based on telnet protocol. With the RFC-2217 mode, remote host can monitor and manage remote serially attached devices, as though they were connected to the local serial port. When a virtual serial port on the local serial device is being created, it is required to specify the IP-address of the remote hosts to establish connection with.

Operation Mode Definition for each Serial Port									
Serial Port	Operation Mode	Listen Port	Trust Type	Max Connection	Connection Control	Connection Idle Timeout	Alive Check Timeout	Enable	Action
SPort-0	RFC-2217 ▼	4001 (1~65535)	Allow All ▼	1	Always on ▼	0 (0-3600secs)	0 (0-3600secs)	<input type="checkbox"/>	Edit

Enable RFC-2217 Mode Window		
Item	Value setting	Description
Operation Mode	A Must filled setting	Select RFC-2217 mode.
Listen Port	4001 is set by default	Indicate the listening port of RFC-2217 connection. Value Range: 1 ~ 65535
Trust Type	Allow All is set by default	Choose Allow All to allow any clients to connect. Otherwise choose Specific IP to limit certain clients.
Connection Idle Timeout	1. 0 is set by default 2. Range 0 to 3600 sec.	Enter the idle timeout in minutes. The idle timeout is used to disconnect the TCP connection when idle time elapsed . Idle timeout is only available when On-Demand is selected in the Connection Control field. Value Range: 0 ~ 3600 seconds.
Alive Check Timeout	1. 0 is set by default 2. Range 0 to 3600 sec.	Enter the time period of alive check timeout. The TCP connection will be terminated if it doesn't receive response of alive-check longer than this timeout setting Alive check timeout is only available when On-Demand is selected in the Connection Control field. Value Range: 0 ~ 3600 seconds.
Enable	The box is unchecked by default.	Check the Enable box to activate the corresponding serial port in specified operation mode.
Save	N/A	Click Save to save the settings
Undo	N/A	Click Undo to cancel the settings

5G NR M2M Gateway

Specify Remote Host for Access

If you selected **Specific IPs** as the trust Type, the Trusted IP Definition window appears. The settings are valid for both TCP Server and RFC-2217 modes.

Trusted IP Definition (for TCP Server & RFC-2217 operation mode)				
ID	Host	Serial Port	Definition Enable	Action
1			<input type="checkbox"/>	Edit
2			<input type="checkbox"/>	Edit
3			<input type="checkbox"/>	Edit
4			<input type="checkbox"/>	Edit
5			<input type="checkbox"/>	Edit
6			<input type="checkbox"/>	Edit
7			<input type="checkbox"/>	Edit
8			<input type="checkbox"/>	Edit

Specify RFC-2217 Clients for Access Window		
Item	Value setting	Description
Host	A Must filled setting	Enter the IP address range of allowed clients.
Serial Port	The box is unchecked by default	Check the box to specify the rule for selected Serial Port.
Definition Enable	The box is unchecked by default	Check the Enable box to enable the rule.
Save	N/A	Click Save to save the settings
Undo	N/A	Click Undo to cancel the settings

5G NR M2M Gateway

Configure VirtualCOM Data Logging

If you intend to monitor the traffic of the serial port, you can configure the data logging settings and enable it to get the traffic log consequently.

COM Logging						
Serial Port	Storage Device	Remote Log Server(UDP)	Upload Server	Data Format	Max Record Day	Enable
SPort-0	External ▾ Download <input type="checkbox"/> Enable	IP <input type="text"/> TX Port <input type="text"/> RX Port <input type="text"/> <input type="checkbox"/> Enable	-- Option -- ▾ Add Object <input type="checkbox"/> Enable	HEX ▾	<input type="text" value="3"/>	<input type="checkbox"/>

COM Logging Configuration Window		
Item	Value setting	Description
Storage Device	The box is unchecked by default.	Check the Enable box and use the attached available storage (USB or SD-card) device to keep the data log file under the folder “\virtual-com-log\SPort-n\Date\”. Click the Download button to get the log files (*.csv).
Remote Log Server (UDP)	The box is unchecked by default.	Check the Enable box and use remote log server to keep the recorded traffic log over the serial port. You have to further specify the IP address and port number for the log server. Value Range: 1 ~ 65535, and 0 for disabled by default.
Upload Server	The box is unchecked by default.	Check the Enable box and select a pre-defined FTP server from the drop down list. You can also click the Add Object button to create a new entry for the server information. The device will auto-upload the logged traffic with a zipped file (*.csv.gz) per hour to the designated FTP server.
Data Format	HEX is set by default	Specify the data format for the logged traffic. It can be HEX or ASCII .
Max Record Day	3 is set by default	Enter the time period of alive check timeout. The TCP connection will be terminated if it doesn't receive response of alive-check longer than this timeout setting Alive check timeout is only available when On-Demand is selected in the Connection Control field. Value Range: 1 ~ 30 days.
Enable	The box is unchecked by default.	Check the Enable box to activate the data logging function for corresponding serial port with specified configuration.
Save	N/A	Click Save to save the settings
Undo	N/A	Click Undo to cancel the settings

5G NR M2M Gateway

4.1.3 Modbus

Modbus is one of the most popular automation protocols in the world, supporting traditional RS-232/422/485 devices and recently developed Ethernet devices. Many industrial devices, such as PLCs, DCSs, HMIs, instruments, and smart meters, use Modbus protocol as the communication standard. It is used to establish master-slave communication between intelligent devices.

However, the Ethernet-based Modbus protocol is so different from the original serial-based protocols. In order to integrate Modbus networks, the IoT Gateway, including one or more serial ports that support RS-232 and RS-485 communication interface, can automatically and intelligently translate between Modbus TCP (Ethernet) and Modbus RTU/ASCII (serial) protocols, allowing Ethernet-based PLCs to control instruments over RS-485 without additional programming or effort.

Serial Port Definition								
Serial Port	Operation Mode	Interface	Baud Rate	Data Bits	Stop Bits	Flow Control	Parity	Action
SPort-0	Modbus	RS-485	9600	8	1	None	None	Edit

NOTE: When Modbus devices are connected to/under the same serial port of IoT Modbus Gateway, those Modbus devices must use the same protocol with the same configuration (i.e., either Modbus RTU or Modbus ASCII with same Baud Rate setting).

Modbus Gateway Scenario

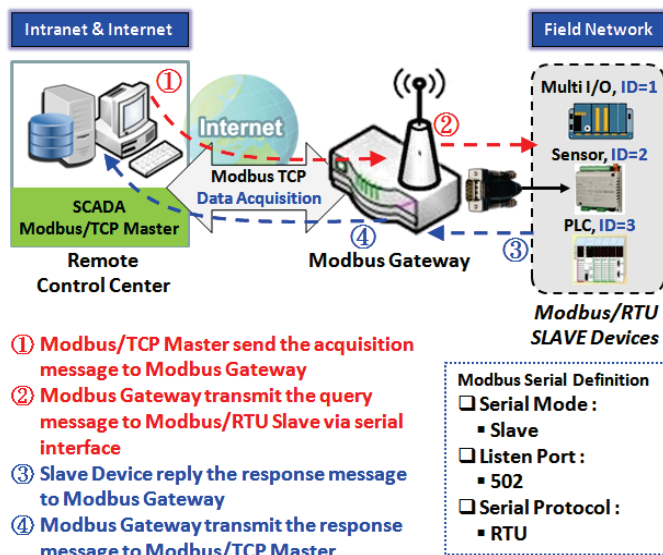

The IoT Gateway serves as a Modbus gateway to communicate with the Modbus TCP Master, the SCADA Server, located at remote control center for Modbus device accessing.

The Modbus TCP Master requests the IoT Gateway for Modbus devices' information, e.g., Data Acquisition or Register/Value Modification, via general Internet accessing, and the IoT Gateway serves as the gateway for data forwarding.

Under such configuration, the Modbus TCP Master requests the information from or sending control commands to various Modbus/RTU Slave devices that attached to the Modbus Gateway. And the Modbus gateway executes corresponding processes and replies the Modbus/TCP Master with the results.

5G NR M2M Gateway

Modbus Slave Scenario

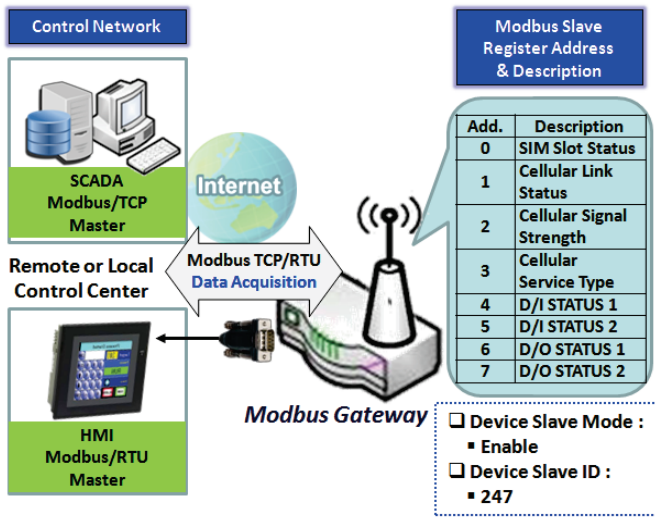

In addition to behave as a Modbus Gateway, there is an integrated Modbus Slave option for providing some device status, like Cellular Network Status, device DI/DO status, to remote Modbus Master via Modbus communication.

With the Slave option enabled, the Modbus Master device can request the information or sending control commands to the IoT Gateway, the Modbus TCP/RTU Slave device. And IoT Gateway executes corresponding processes and replies the Modbus Master devices.

5G NR M2M Gateway

Modbus Setting

Go to **Field Communication > Bus & Protocol > Modbus** tab.

The Modbus setting page enables user to configure the gateway to operate as a Modbus gateway, and allow access among Modbus TCP devices (which are connected to Ethernet network) and Modbus RTU/ASCII devices (which are connected to the Serial Port of the gateway). Once completed the Modbus settings in this section, ensure to select Modbus Operation Mode in Port Configuration screen to enable Modbus communication on the serial port.

Define Modbus Gateway function for each Serial Port

Modbus Gateway Definition						
Serial Port	Gateway Mode	Device Slave Mode	Listen Port	Serial Protocol	Enable	Action
▶ SPort-0	Disable	Slave Mode: Disable	502	RTU	<input checked="" type="checkbox"/>	Edit

Modbus Gateway Definition		
Item	Value setting	Description
Serial Port	N/A	It displays the name of the serial port used. E.g. SPort-0. The number of serial ports varies from the purchased model.
Gateway Mode	Disable is set by default	Specify the Modbus gateway mode for the selected serial port. It can be Disable , Serial as Slave or Serial as Master . A serial port can be attached with one Modbus Master, or daisy-chained a group of Modbus Slave devices. Disable: Select this to disable the respective Modbus gateway function for the selected serial port. Serial as Slave: Select this when the attached serial device(s) are all Modbus Slave devices. Serial as Master: Select this when the attached serial device is a Modbus Master device.
Device Slave Mode	Disable is set by default	Check the Enable box to activate the integrated Modbus Slave function, and enter the preferred ID for the integrated Modbus slave. So that, it can function as a Modbus Slave device, and can be accessed with legacy Modbus Function Code from a SCADA management system. Supported Modbus commands are listed in the following Table. Value Range: 1 ~ 247.
Listen Port	1. 502 is set by default 2. Range 1 to 65535	Specify the Listen Port number if Slave device(s) is attached to the selected serial port. It is a don't care setting if a Master device is attached. Value Range: 1 ~ 65535.

5G NR M2M Gateway

		Note: Use different port number among the serial ports for the product with multiple serial ports.
Serial Protocol	RTU is set by default	Select the serial protocol that is adopted by the attached Modbus device(s). It can be RTU or ASCII .
Enable	N/A	It displays whether the specific Modbus serial port is enabled or disabled. To enable or disable Modbus serial port, go to Field Communication > Bus & Protocol > Port Configuration tab, and set the operation mode as Modbus .

Specify Gateway Configuration

Gateway Mode Configuration for SPort-0	
Item	Setting
▶ Response Timeout	1000 ms (1~65535)
▶ Timeout Retries	0 times (0~5)
▶ 0Bh Exception	<input type="checkbox"/> Enable
▶ Tx Delay	<input type="checkbox"/> Enable
▶ TCP Connection Idle Time	300 sec (1~65535)
▶ Maximum TCP Connections	1 connections (1~4)
▶ TCP Keep-alive	<input type="checkbox"/> Enable
▶ Modbus Master IP Access	Allow All ▼
▶ Message Buffering	<input type="checkbox"/> Enable

Gateway Mode Configuration for SPort-n		
Item	Value setting	Description
Response Timeout	1000 ms is set by default	<p>This sets the response timeout of the slave after master request sent. If the slave does not response within the specified time, data would be discarded.</p> <p>This applies to the serially attached Master sent request over to the remote Slave or requests send from the remote Master sent to the serially attached Slave.</p> <p>Value Range: 1 ~ 65535.</p>
Timeout Retries	0 is set by default	<p>If the slave does not respond to the Master's request, the gateway will resend the request stored in the buffer. If Timeout retries is set to null (value zero), the gateway would not buffer Master requests. If a value other than zero is specified, the gateway would store the Master request in the buffer and retries to send the request in a number of specified times.</p> <p>Once the retries are exhausted, the gateway will send a Modbus error message to the Master. However, if the 0Bh exception box is checked (see below), a 0Bh hex code based-error message will be send instead.</p> <p>Value Range: 0 ~ 5.</p>

5G NR M2M Gateway

0Bh Exception	The box is unchecked by default.	Check the Enable box to enable gateway to send a 0Bh exception code message to Modbus Master to indicate that the slave device does not respond within the timeout interval.
Tx Delay	The box is unchecked by default.	Check the Enable box to activate to the minimum amount of time after receiving a response before the next message can be sent out. When Tx Delay is enabled the Gateway would insert a Tx delay between Master requests. The delay gives sufficient time for the slave devices to turn their transmitters off and their receivers back on.

Setup TCP/IP Connection for Receiving Modbus Master Request

The following Modbus TCP Configuration items allow user to set up the TCP connection settings so that the remote Modbus Master can access to the Modbus gateway. Besides, it also allows user to specify authorized masters on the TCP network.

Item	Value setting	Description
TCP Connection Idle Time	1. 300 is set by default 2. Range 1 to 65535	Enter the idle timeout in seconds. If the gateway does not receive another TCP request before the idle timeout elapsed, the TCP session will be terminated automatically. Value Range: 1 ~ 65535.
Maximum TCP Connections	1. 4 is set by default 2. Range 1 to 4	Enter the allowed maximum simultaneous TCP connections. Value Range: 1 ~ 4.
TCP Keep-alive	The box is unchecked by default.	Check the Enable box to ensure to keep the TCP session connected.
Modbus Master IP Access	Allow All is selected by default.	Specify authorized masters on the TCP network. Select Allow All to allow any Modbus Master to reach the attached Slave(s). Otherwise, limit only specific Master to reach the Slave(s) by selecting Specific IPs . When Specific IPs is selected, a Trusted IP Definition dialog will appear.

Specify Trusted Modbus Masters on the TCP network

When **Specific IPs** is selected, user has to specify the Master(s) by their IP addresses to reach the serially attached Slave(s).

▶ Modbus Master IP Access	Specific IPs ▼			
▶ Trusted IP Definition	ID	Source IP	Enable	Action
	1	Specific IP Address ▼ <input type="text"/>	<input type="checkbox"/>	<input type="button" value="Edit"/>
	2		<input type="checkbox"/>	<input type="button" value="Edit"/>
	3		<input type="checkbox"/>	<input type="button" value="Edit"/>
	4		<input type="checkbox"/>	<input type="button" value="Edit"/>

Item	Value setting	Description
------	---------------	-------------

5G NR M2M Gateway

Source IP	A Must fill setting	<p>Select Specific IP Address to only allow an IP address of the allowed Master to access the attached Slave(s).</p> <p>Select IP Range to only allow a set range of IP addresses of the allowed Master to access the attached Slave(s).</p> <p>Select IP Address-based Group to only allow pre-defined group of IP address of the allowed Master to access the attached Slave(s).</p> <p>Note: group must be pre-defined before this selection become available. Refer to Object Definition > Grouping > Host grouping. You may also access to create a group by the Add Rule shortcut button. Setting done through the Add Rule button will also appear in the Host grouping setting screen.</p> <p>Then check Enable box to enable this rule.</p>
Enable	Unchecked by default	Check the Enable box to enable this rule.

Modbus Priority Definition

Message Buffering must be enabled to prioritize Master request queue to transmit to Modbus Slave as mentioned in the above. Click the **Edit** button to fill in the priority settings.

▶ Message Buffering	<input checked="" type="checkbox"/> Enable			
▶ Modbus Priority Definition	Modbus Priority	Priority Base	Enable	Action
	▶ Modbus Priority 1	IP Address ▼ <input type="text"/>	<input type="checkbox"/>	Edit
	▶ Modbus Priority 2		<input type="checkbox"/>	Edit
	▶ Modbus Priority 3		<input type="checkbox"/>	Edit
	▶ Modbus Priority 4		<input type="checkbox"/>	Edit

Item	Value setting	Description
Message Buffering	<ol style="list-style-type: none"> 1. Unchecked by default 2. Buffer up to 32 requests 	<p>Check the Enable box to buffer up to 32 requests from Modbus Master.</p> <p>If the Enable box is checked, a Modbus Priority Definition dialog will appear consequently. So that, the buffered Master requests can further be configured to prioritize request queue to transmit to Slave based on Master's IP address if requests are coming from remote Master, or based on remote Slave ID if requests are coming from serially attached Master, or based on Function Code.</p>
Modbus Priority	N/A	A Priority List for setting the priority of specified Modbus identity. Modbus Priority 1 ~ Modbus Priority 4.
Priority Base	IP Address by Default	<p>User can specify a Modbus identity with IP Address, Slave ID, or Function Code.</p> <p>The buffered Modbus message that matched the specified identity will be handled with given priority.</p> <p>The Modbus Master requests can be buffered to a certain priority queue according to the Master's IP address if requests are coming from remote Master, or the remote Slave's device ID if requests are coming from serially attached Master, or the specific Function Code that issued by Master.</p>
Enable	Unchecked by default	Check the Enable box to enable the priority settings.

5G NR M2M Gateway

Save N/A Click the **Save** button to save the settings.

Specify Modbus TCP Slave device(s)

If there is a Modbus Master device is attached to a certain serial port of the Modbus Gateway, user has to further specify the Modbus TCP Slave device(s) to send requests to from the attached Modbus RTU/ASCII Master device.

Modbus TCP Slave List for SPort-0 Add Delete					
ID	IP	Port	ID Range	Enable	Actions

When the **Add** button is applied, a **Modbus TCP Slave Configuration** screen will appear.

Modbus TCP Slave Configuration for SPort-0	
Item	Setting
▶ IP	<input type="text"/>
▶ Port	<input type="text"/> (1~65535)
▶ ID Range	<input type="text"/> (1~247) ~ <input type="text"/> (1~247)
▶ Enable	<input type="checkbox"/>

Modbus Remote Slave Configuration		
Item	Value setting	Description
IP	A Must fill setting	Enter the IP address of the remote Modbus TCP Slave device.
Port	1. A Must fill setting 2. Range 1 to 65535	Enter the TCP port on which the remote Modbus TCP Slave device listens (to the TCP client session request). Value Range: 1 ~ 65535.
ID Range	Range 1 to 247	Enter the Modbus ID range for the Modbus TCP Slave(s) that will respond to the Master's request. In addition to specify the Slave IP and Port, for accessing those Remote Modbus RTU Slave(s) located behind another Modbus Gateway, user has to specify the Modbus ID range of the Modbus RTU Slave(s). Value Range: 1 ~ 247.
Enable	It is unchecked by default.	Check the Enable box to enable this rule.
Save	N/A	Click the Save button to save the settings.

5G NR M2M Gateway

Supported Function Code for Integrated Modbus Slave

This setting can setup the Gateway as a standalone Modbus Slave Device. Local SCADA Management System can treat the Gateway as a Slave device, and hence is able to read its information for device monitoring.

Currently, the integrated Modbus Slave device supports the following commands for accessing the 3G/4G Modem Status of the Gateway.

Function Code: 0x03(/Read). 0x06(/Write)

Address: 0 ~ 9999

Register Address	Register Name	R / W	Register Range / Description
0	WAN-1 Connection Status	R	0 ~ 6, 0=Disconnected, 1=Connecting..., 2=Connected, 3=Disconnecting..., 5=Wait for Traffic..., 6=Diconnected
1	WAN-2 Connection Status	R	0 ~ 6, 0=Disconnected, 1=Connecting..., 2=Connected, 3=Disconnecting..., 5=Wait for Traffic..., 6=Diconnected
2	WAN-3 Connection Status	R	0 ~ 6, 0=Disconnected, 1=Connecting..., 2=Connected, 3=Disconnecting..., 5=Wait for Traffic..., 6=Diconnected
3	WAN-4 Connection Status	R	0 ~ 6, 0=Disconnected, 1=Connecting..., 2=Connected, 3=Disconnecting..., 5=Wait for Traffic..., 6=Diconnected
10	3G/4G_SERVICE_TYPE	R	0 ~ 7, 0=2G, 1=none, 2=3G, 3=3.5G, 4~6=3.75G, 7=LTE
11	3G/4G_LINK_STATUS	R	0 ~ 6, 0=Disconnected, 1=Connecting..., 2=Connected, 3=Disconnecting..., 5=Wait for Traffic..., 6=Diconnected
12	3G/4G_SIGNAL_STRENGTH	R	0 ~ 100
13	3G/4G_SIM_STATUS	R	0 : SIM card with PIN code insert 1 : SIM card ready 2 : No SIM card
14	3G/4G_MCC	R	MCC Value
15	3G/4G_MNC	R	MNC Value
16	3G/4G_CS Register Status	R	0 : Unregistered, 1: Registered
17	3G/4G_PS Register Status	R	0 : Unregistered, 1: Registered
18	3G/4G_Roaming Status	R	0 : Not Roaming, 1: Roaming
19	3G/4G_RSSI	R	RSSI Value
20	3G/4G_RSRP	R	RSRP Value
21	3G/4G_RSRQ	R	RSRQ Value
30	3G/4G_Module-2_SERVICE_TYPE	R	0 ~ 7, 0=2G, 1=none, 2=3G, 3=3.5G, 4~6=3.75G, 7=LTE
31	3G/4G_Module-2_LINK_STATUS	R	0 ~ 6, 0=Disconnected, 1=Connecting..., 2=Connected, 3=Disconnecting..., 5=Wait for Traffic..., 6=Diconnected
32	3G/4G_Module-2_SIGNAL_STRENGTH	R	0 ~ 100
33	3G/4G_Module-2_SIM_STATUS	R	0 : SIM card with PIN code insert 1 : SIM card

5G NR M2M Gateway

Register Address	Register Name	R / W	Register Range / Description
			ready 2 : No SIM card
34	3G/4G_Module-2_MCC	R	MCC Value
35	3G/4G_Module-2_MNC	R	MNC Value
36	3G/4G_Module-2_CS Register Status	R	0 : Unregistered, 1: Registered
37	3G/4G_Module-2_PS Register Status	R	0 : Unregistered, 1: Registered
38	3G/4G_Module-2_Roaming Status	R	0 : Not Roaming, 1: Roaming
39	3G/4G_Module-2_RSSI	R	RSSI Value
40	3G/4G_Module-2_RSRP	R	RSRP Value
41	3G/4G_Module-2_RSRQ	R	RSRQ Value
70	ADSL_Download_Data rate	R	ADSL Download Data rate value (kbps)
71	ADSL_Upload_Data rate	R	ADSL Upload Data rate value (kbps)
72	ADSL SNR_Download	R	ADSL SNR Download value (dB)
73	ADSL SNR_Upload	R	ADSL SNR Upload value (dB)
74	ADSL modem link status	R	0 : Disconnected, 1: Connected
101	VPN IPsec tunnel 1 status	R	1 : Connected, 2 : Wait for traffic , 3 : Disconnected , 9 : Connecting
102	VPN IPsec tunnel 2 status	R	1 : Connected, 2 : Wait for traffic , 3 : Disconnected , 9 : Connecting
103	VPN IPsec tunnel 3 status	R	1 : Connected, 2 : Wait for traffic , 3 : Disconnected , 9 : Connecting
104	VPN IPsec tunnel 4 status	R	1 : Connected, 2 : Wait for traffic , 3 : Disconnected , 9 : Connecting
105	VPN IPsec tunnel 5 status	R	1 : Connected, 2 : Wait for traffic , 3 : Disconnected , 9 : Connecting
106	VPN IPsec tunnel 6 status	R	1 : Connected, 2 : Wait for traffic , 3 : Disconnected , 9 : Connecting
107	VPN IPsec tunnel 7 status	R	1 : Connected, 2 : Wait for traffic , 3 : Disconnected , 9 : Connecting
108	VPN IPsec tunnel 8 status	R	1 : Connected, 2 : Wait for traffic , 3 : Disconnected , 9 : Connecting
109	VPN IPsec tunnel 9 status	R	1 : Connected, 2 : Wait for traffic , 3 : Disconnected , 9 : Connecting
110	VPN IPsec tunnel 10 status	R	1 : Connected, 2 : Wait for traffic , 3 : Disconnected , 9 : Connecting
111	VPN IPsec tunnel 11 status	R	1 : Connected, 2 : Wait for traffic , 3 : Disconnected , 9 : Connecting
112	VPN IPsec tunnel 12 status	R	1 : Connected, 2 : Wait for traffic , 3 : Disconnected , 9 : Connecting
113	VPN IPsec tunnel 13 status	R	1 : Connected, 2 : Wait for traffic , 3 : Disconnected , 9 : Connecting
114	VPN IPsec tunnel 14 status	R	1 : Connected, 2 : Wait for traffic , 3 : Disconnected , 9 : Connecting
115	VPN IPsec tunnel 15 status	R	1 : Connected, 2 : Wait for traffic , 3 : Disconnected , 9 : Connecting
116	VPN IPsec tunnel 16 status	R	1 : Connected, 2 : Wait for traffic , 3 : Disconnected , 9 : Connecting
150	DI_STATUS_1	R	0 : OFF, 1 : ON
151	DO_STATUS_1	R/W	0 : OFF, 1 : ON

5G NR M2M Gateway

Register Address	Register Name	R / W	Register Range / Description
152	DI_STATUS_2	R	0 : OFF, 1 : ON
153	DO_STATUS_2	R/W	0 : OFF, 1 : ON
154	DI_STATUS_3	R	0 : OFF, 1 : ON
155	DO_STATUS_3	R/W	0 : OFF, 1 : ON
156	DI_STATUS_4	R	0 : OFF, 1 : ON
157	DO_STATUS_4	R/W	0 : OFF, 1 : ON
201	Serial Port-0_Interface	R	1 : RS-232, 3 : RS-485
202	Serial Port-0_Baud Rate	R	Baud Rate Value
203	Serial Port-0_Data Bits	R	7 or 8
204	Serial Port-0_Stop Bits	R	1 or 2
205	Serial Port-0_Flow Control	R	0 : None, 2 : RTS,CTS, 3 : DTR,DSR
206	Serial Port-0_Parity	R	0 : None, 1 : Odd, 2 : Even
211	Serial Port-1_Interface	R	1 : RS-232, 3 : RS-485
212	Serial Port-1_Baud Rate	R	Baud Rate Value
213	Serial Port-1_Data Bits	R	7 or 8
214	Serial Port-1_Stop Bits	R	1 or 2
215	Serial Port-1_Flow Control	R	0 : None, 2 : RTS,CTS, 3 : DTR,DSR
216	Serial Port-1_Parity	R	0 : None, 1 : Odd, 2 : Even
221	Serial Port-2_Interface	R	1 : RS-232, 3 : RS-485
222	Serial Port-2_Baud Rate	R	Baud Rate Value
223	Serial Port-2_Data Bits	R	7 or 8
224	Serial Port-2_Stop Bits	R	1 or 2
225	Serial Port-2_Flow Control	R	0 : None, 2 : RTS,CTS, 3 : DTR,DSR
226	Serial Port-2_Parity	R	0 : None, 1 : Odd, 2 : Even
231	Serial Port-3_Interface	R	1 : RS-232, 3 : RS-485
232	Serial Port-3_Baud Rate	R	Baud Rate Value
233	Serial Port-3_Data Bits	R	7 or 8
234	Serial Port-3_Stop Bits	R	1 or 2
235	Serial Port-3_Flow Control	R	0 : None, 2 : RTS,CTS, 3 : DTR,DSR
236	Serial Port-3_Parity	R	0 : None, 1 : Odd, 2 : Even
9999	System_Reboot	W	Set 1 for System reboot.

5G NR M2M Gateway

4.2 Data Logging

Data logging is the process of collecting and storing data over a period of time in order to analyze specific trends or record the data-based events/actions of a system, or connected devices. Data logging function is a very useful and also important feature for SCADA telemetry; it makes the monitoring and analyzing tasks easier by checking the status and historical data during whole data acquisition period.

Even facing the network connection problems with remote NOC/SCADA side, you can also enable the data logging proxy function provided by the purchased gateway and keep doing the data acquisition and storing the collected data in local storage (in .CSV file format). When the network connection recovered, admin/user can download the data log files manually via FTP or web UI for further reference and maintenance.

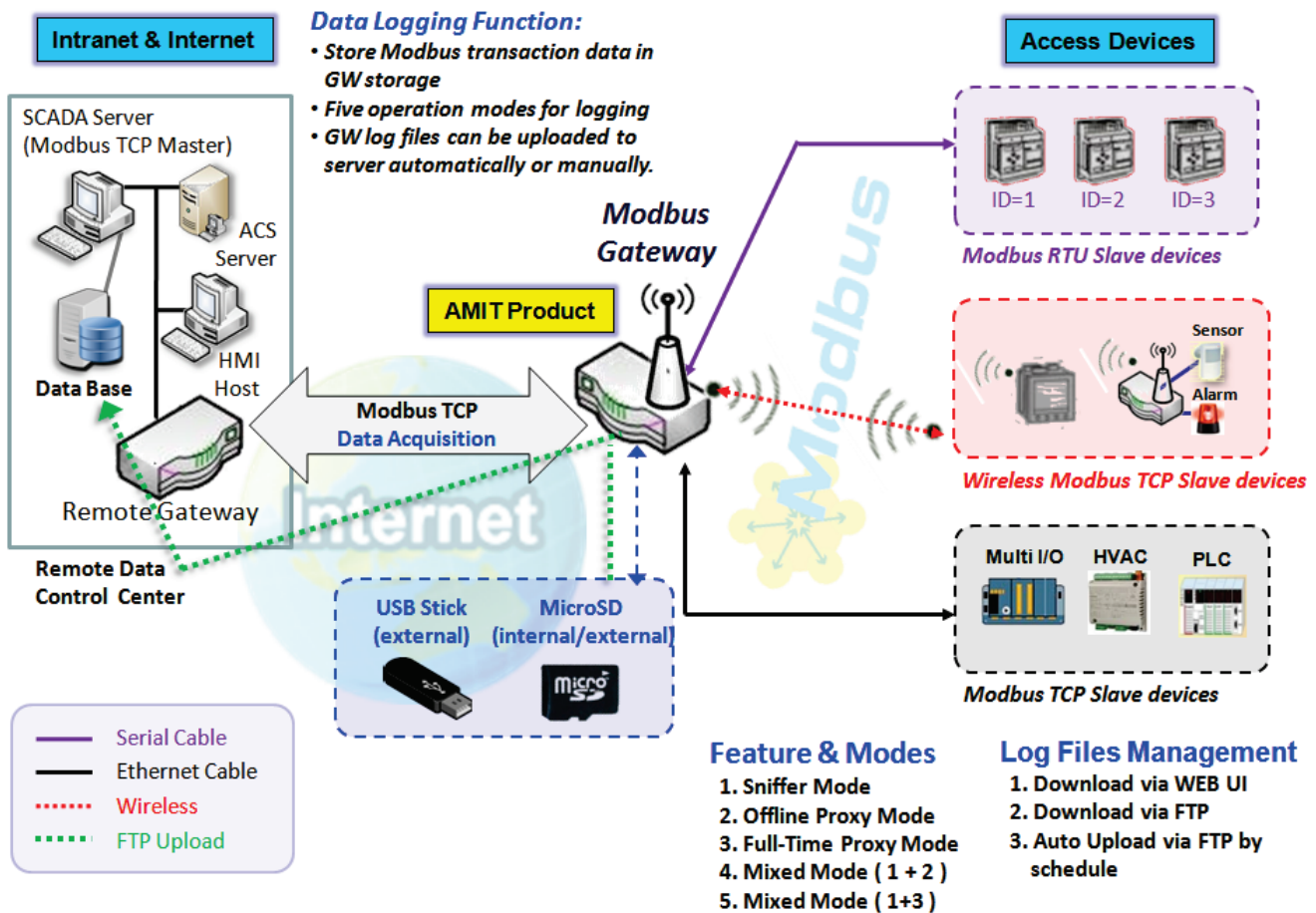

The Modbus Cellular Gateway provides a complete data logging function for collecting the Modbus transaction data for application requirements. There are some data logging schemes to meet different management requirements. They are the Sniffer Mode, Offline Proxy Mode, Full-Time Proxy Mode, and the mixed modes for sniffer and proxy combinations.

With the Sniffer mode enabled, the gateway will monitor and record the communication among a specific Modbus Master and related slaves. It will store the Modbus communication as log files and administrator can check what Modbus communication went over the Modbus gateway, and if there is any communication loss among the Master and Slave sides or not.

5G NR M2M Gateway

However, if there is any network connection problem between the Modbus gateway and remote NOC/SCADA, the remote Modbus server can't reach the Slave devices attached to the Modbus gateway, and consequently, nothing can be monitored and stored under such situation.

With the Proxy mode option enabled, when the Modbus gateway lost the connection with specified Modbus server, it will take over the data acquisition task and keep collecting the required data from Slave devices automatically. Once the connection is recovered, the Modbus gateway may stop the data log proxy function. Remote Modbus server can keep its data acquisition process, and if required, the administrator can also get the stored data log files to tell if everything goes well or not.

Under the Data Logging Proxy mode, user has to create some data acquisition rules via "Proxy Mode Rule Configuration" for collecting the Slave devices data by the Gateway when required. Once the network connection to remote SCADA was lost unexpectedly, the Data Logging Proxy function will be triggered and begin to do the data polling tasks by those pre-defined rules running in background.

➤ Scenario for Sniffer Mode Data Logging

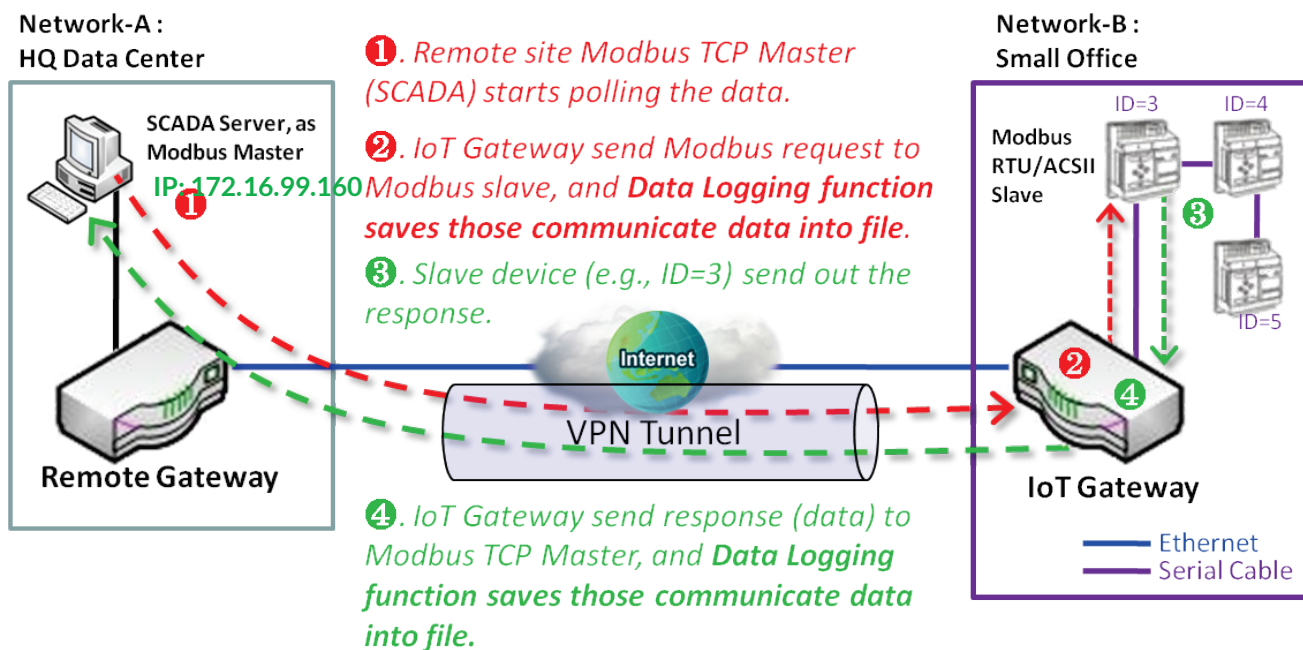

As Illustrated in the diagram, the Modbus gateway will store the following Modbus activities into a log file.

- The Modbus request sent from Remote Modbus TCP Master.
- The response (data) that sent out from the polled Slave device (ID=3)

➤ Scenario for Off-Line Proxy Mode Data Logging

5G NR M2M Gateway

Network-A:
HQ Data Center

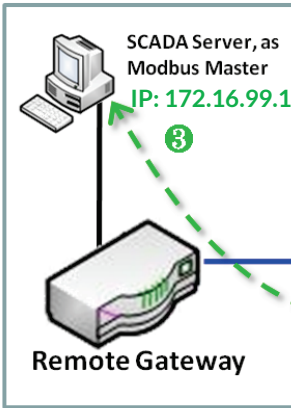

- 1 To do the Data-Acquisition by IoT Gateway itself automatically.
- 2 Save those data as files to internal or external storage unit (e.g., Micro-SD card).
- 3 Data Logging Files Downloading via FTP or WEB UI.

Network-B:
Small Office

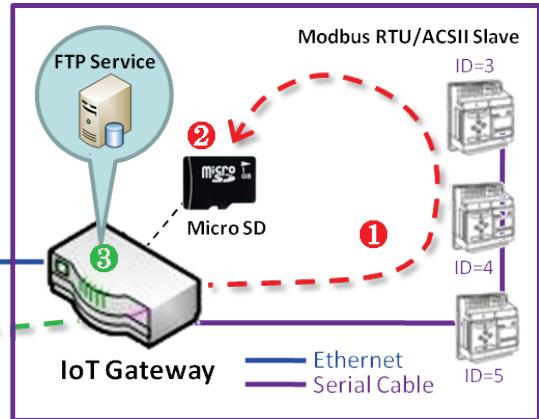

As illustrated, when the connection to a remote Modbus Master broken, the Modbus Gateway will activate the data logging proxy function and execute the pre-defined data acquisition task by itself.

- The Modbus request issued by the Modbus Gateway (Data Logging Proxy).
- The response (data) that sent out from the polled Slave device (ID=3)

Repeat above data acquisition and data logging activities on every 5 sec interval until the connection recovered.

5G NR M2M Gateway

4.2.1 Data Logging Configuration

Data Logging is commonly used in monitoring systems to collect and analyze the field data. With proper configuration, the Gateway will record Modbus messages according to the specified rule list.

Go to **Field Communication > Data Logging > Configuration** tab.

Enable Data Logging

Configuration	
Item	Setting
Data Logging	<input type="checkbox"/> Enable
Storage Device	External ▾

Configuration Item	Value setting	Description
Data Logging	The box is unchecked by default.	Check the Enable box to activate to data logging function.
Storage Device	External is set by default	Choose the sotrage device to store the log files. It can be External or Internal , depends on the product specification.
Save	NA	Click the Save button to save the settings.

Note:

1. If there is no available storage device, the Enable checkbox will be grayed, and you can't enable it for the data logging. That is, if you selected External Storage, plug-in the storage first, and then enable the function and also make the required configuration.
2. Make sure the Modbus Operation Mode is selected and enabled, or there will be no Modbus transactions to be logged. Please refer to **Field Communication > Bus & Protocol > Port Configuration** and **Modbus** tabs.

Create/Edit Modbus Proxy Rules

The Gateway allows you to customize your proxy mode rule list. It supports up to a maximum of 30 rules.

Modbus Proxy Rule List								Add	Delete
ID	Name	Modbus Slave Type	Slave ID	Function Code	Start Address	Number of Coils/Registers	Polling Rate (ms)	Actions	

When the **Add** button is applied, **Modbus Proxy Rule Configuration** screen will appear.

5G NR M2M Gateway

Modbus Proxy Rule List Configuration
Save Undo
✕

Item	Setting
▶ Name	<input style="width: 90%;" type="text"/>
▶ Modbus Slave Type	IP Address:Port ▼ <input style="width: 150px;" type="text"/> : <input style="width: 50px;" type="text"/>
▶ Slave ID	<input style="width: 50px;" type="text"/> (1~247) - <input style="width: 50px;" type="text"/> (1~247)
▶ Function Code	Read Coils (0x01) ▼
▶ Start Address	<input style="width: 50px;" type="text"/> (0~65535)
▶ Number of Coils/Registers	<input style="width: 50px;" type="text"/> (1~125)
▶ Polling Rate (ms)	1000 (500~99999)

Modbus Proxy Rule Configuration		
Item	Value setting	Description
Name	A Must filled setting.	Specify a name as the identifier of the Modbus proxy rule. Value Range: 1 ~ 32 characters.
Modbus Slave Type	IP Address :Port is selected by default.	Specify the Modbus Slave devices to apply with the Modbus proxy rule. It can be IP Address:Port for Modbus TCP slaves or Local Serial Port for local attached Modbus RTU/ASCII slaves. Value Range: 1 ~ 65535 for port number
Slave ID	1. A Must filled setting. 2. Range 1 to 247	Specify the ID range for the slave device(s) to apply with the Modbus proxy rule. Value Range: 1 ~ 247.
Function Code	Read Coils (0x01) is selected by default.	Specify a certain read function for the Data Logging Proxy to issue and record the responses from device(s).
Start Address	1. A Must filled setting. 2. Range 0 to 65535	Specify the Start Address of registers to apply with the specified function code. Value Range: 0 ~ 65535.
Number of Coils/Registers	1. A Must filled setting. 2. Range 1 to 125	Specify the number of coils/registers to apply with the specified function code. Value Range: 1 ~ 125. Note: Start Address plus Number must be smaller than 65536.
Polling Rate (ms)	1. A Must filled setting. 2. 1000 ms is set by default	Enter the poll time in milliseconds to apply the Proxy Mode Rule. Once the proxy mode is activated, the Modbus Gateway will issue pre-defined Modbus message on each Poll Time interval accordingly. Value Range: 500 ~ 99999.
Save	N/A	Click the Save button to save the settings.
Undo	N/A	Click the Undo button to cancel the changes.

5G NR M2M Gateway

4.2.2 Scheme Setup

There are five data logging schemes to meet different management requirements. They are the Sniffer Mode, Offline Proxy Mode, Full-Time Proxy Mode, and the mixed modes for sniffer and proxy combinations. User has to configure the required data logging rules with selected scheme in this Scheme Setup page.

Go to **Field Communication > Data Logging > Scheme Setup** tab.

Create/Edit Data Logging Rules

ID	Name	Mode	Master Type	Master Query Timeout (sec)	Proxy Rules	Enable	Actions
----	------	------	-------------	----------------------------	-------------	--------	---------

When the **Add** button is applied, **Scheme Configuration** screen will appear.

Item	Setting
Name	<input type="text"/>
Mode	Sniffer
Master Type	IP Address <input type="text"/>
Enable	<input type="checkbox"/>

Item	Value setting	Description
Name	A Must filled setting.	Specify a name as the identifier of the data logging rule. Value Range: 1 ~ 16 characters.
Mode	Sniffer is selected by default.	Select an expected data logging scheme for the data logging rule. There are five available schemes : Sniffer : The Modbus gateway will record all the Modbus transctions between the Master and Slave devices. Off-Line Proxy: When the connection between the Modbus gateway and Master is lost, the pre-defined proxy rule will be triggered and the Modbus gateway will issue specified function code to collect and record the data / status from the slave devices Full-Time Proxy: The pre-defined proxy rule will be triggered all the time and the Modbus gateway will issue specified function code to collect and record the data / status from the slave devices Sniffer & Off-Line Proxy: This is a mixed mode for both Sniffer and Off-Line Proxy modes. Sniffer & Full-Time Proxy: This is a mixed mode for both Sniffer and Full-Time Proxy modes.

5G NR M2M Gateway

Master Type	IP Address is selected by default.	Specify the Modbus master device to apply with the data logging rule. It can be IP Address for Modbus TCP master, or Local Serial Port for local attached Modbus RTU/ASCII master.
Master Query Timeout (sec.)	1. An Optional setting. 2. 60 sec is set by default 3. Range 1 to 99999	Specify the timeout value for querying Modbus Master. If no response from the master for the specified timeout setting, selected proxy rule will be triggered and applied with the data logging rule. Note: If Off-Line proxy scheme is selected, the timeout setting will be used to check. Otherwise, it is a don't care value.
Proxy Rules	An Optional setting.	Select the Proxy rule to be applied with the data logging rule. Note: If any proxy scheme is selected, please create the required Proxy rules in advance, and select from the list.
Enable	The box is unchecked by default.	Check the box to activate the data logging rule.
Save	N/A	Click the Save button to save the settings.
Undo	N/A	Click the Undo button to cancel the changes.

5G NR M2M Gateway

4.2.3 Log File Management

There are five data logging schemes to meet different management requirements. They are the Sniffer Mode, Off-Line Proxy Mode, Full-Time Proxy Mode, and the mixed modes for sniffer and proxy combinations. User has to configure the required data logging rules with selected scheme in this Scheme Setup page.

Go to **Field Communication > Data Logging > Log File Management** tab.

If user had created data log rules in the **Field Communication > Data Logging > Scheme Setup** tab, there will be a log file list shown in the following Log File list screen. The default Log File management settings will be applied if user didn't change it via the **Edit** button.

Log File List								
ID	Name	File Content Format	Split File by	Auto Upload	Log File Compression	Delete File After Upload	When Storage Full	Actions
1	Sniffer Log	Raw Data	200 KB	Disabled	N/A	N/A	Remove the Oldest	<input type="button" value="Edit"/> <input type="button" value="Download Log"/>

When the **Edit** button is applied, **Log File Configuration** screen will appear.

Log File List Configuration		Save	Undo
Item	Setting		
File Content Format	Raw Data ▼		
Split File by	Size ▼	200	KB ▼
Auto Upload	<input checked="" type="checkbox"/> Enable	--- Option --- ▼	<input type="button" value="Add Object"/>
Log File Compression	<input type="checkbox"/> Enable		
Delete File After Upload	<input type="checkbox"/> Enable		
When Storage Full	Remove the Oldest ▼		

Log File Configuration		
Item	Value setting	Description
Name	N/A	The name of corresponding data log rule will be displayed. The default log file name will be named as ' Name_yyyyMMddHHmmSS.csv '.
File Content Format	Raw Data is selected by default	Select the data format for the log files. It can be Raw Data , or Modbus Type .
Split File by	Size and 200 KB are set by default	Specify the split file methodology. It can be by Size , or by Time Interval . User has to dpecify a certain file size or time interval for splitting the data logs into a series of files. Value Range: 1 ~ 99999.
Auto Upload	1. An Optional filled setting 2. The box is unchecked by default.	Check the Enable box to activate the auto upload function for logged files. Once been enabled, user has to specify an external FTP server from the dropdown list for auto uploading the log files to the server. Refer to Object Definition > External Server > External Server tab, or create the FTP server

5G NR M2M Gateway

		with the Add Object button.
Log File Compression	1. An Optional filled setting 2. The box is unchecked by default	If Auto Upload is activated, user can further specify whether to compress the log file prior it is uploaded or not. Check the Enable button to activate the Log File Compression function...
Delete File After Upload	1. An Optional filled setting 2. The box is unchecked by default	If Auto Upload is activated, user can further specify whether to delete the transferred log from the gateway storage or not. Check the Enable button to activate the function.
When Storage Full	Remove the Oldest is selected by default	Specify the operation to take when the storage is full. It can be Remove the Oldest log file, or Stop Recording . When Remove the Oldest is selected, the gateway will delete the oldest file once the storage is full, and keep on the data logging activity; When Stop Recording is selected, the gateway will stop the data logging activity once the storage is full.
Save	NA	Click the Save button to save the settings.
Undo	NA	Click the Undo button to cancel the changes.

When the **Download Log** button is applied, the web browser will download a file named as 'log.tar' to the managing host computer.

5G NR M2M Gateway

4.3 Data Interchange

4.3.1 MQTT

MQTT (Message Queuing Telemetry Transport) is an ISO standard (ISO/IEC PRF 20922) publish-subscribe based messaging protocol. It works on top of the TCP/IP protocol. MQTT is a simple messaging protocol, designed for constrained devices with low-bandwidth. So, it's the perfect solution for IoT applications. An MQTT system consists of clients communicating with a server, often called a "broker". A client may be either a publisher of information or a subscriber. Each client can connect to the broker. ⁶

MQTT allows you to send commands to control outputs, read and publish data from sensor nodes, etc... Information is organized in a hierarchy of topics. When a publisher has a new item of data to distribute, it sends a control message with the data to the connected broker. The broker then distributes the information to any clients that have subscribed to that topic. The publisher does not need to have any data on the number or locations of subscribers, and subscribers in turn do not have to be configured with any data about the publishers. Therefore, it makes it really easy to establish a communication among multiple devices. ⁷

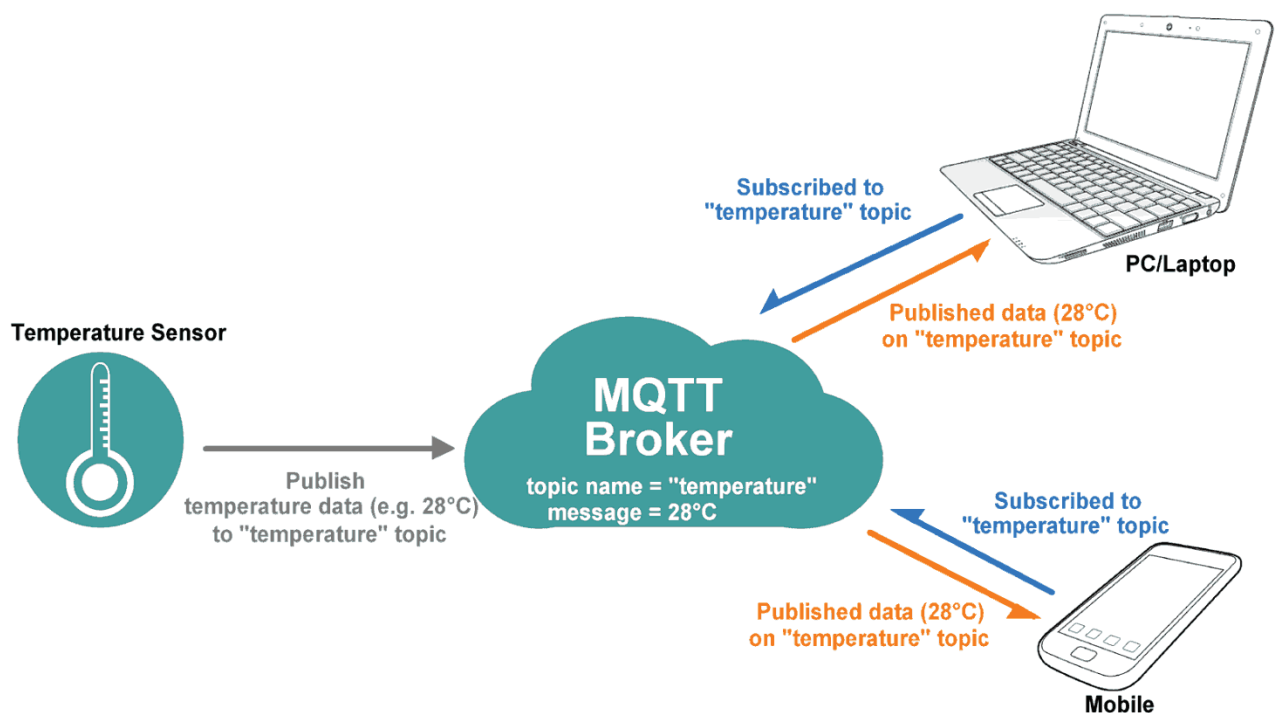

If a broker receives a topic for which there are no current subscribers, it will discard the topic unless the publisher indicates that the topic is to be retained. This allows new subscribers to a topic to receive the most current value rather than waiting for the next update from a publisher.

⁶ <https://en.wikipedia.org/wiki/MQTT>

⁷ <https://randomnerdtutorials.com/what-is-mqtt-and-how-it-works/>

5G NR M2M Gateway

When a publishing client first connects to the broker, it can set up a default message to be sent to subscribers if the broker detects that the publishing client has unexpectedly disconnected from the broker.

Clients only interact with a broker, but a system may contain several broker servers that exchange data based on their current subscribers' topics.

In MQTT there are a few basic concepts that you need to understand:

MQTT - Publish and Subscribe

The first concept is the Publish and subscribe system. In a MQTT publish and subscribe based system, a client device can publish a message on a topic, or it can be subscribed to a particular topic to receive messages.

MQTT - Broker

The broker is primarily responsible for receiving all messages, filtering the messages, decide who is interested in them, and then publishing the message to all subscribed clients.

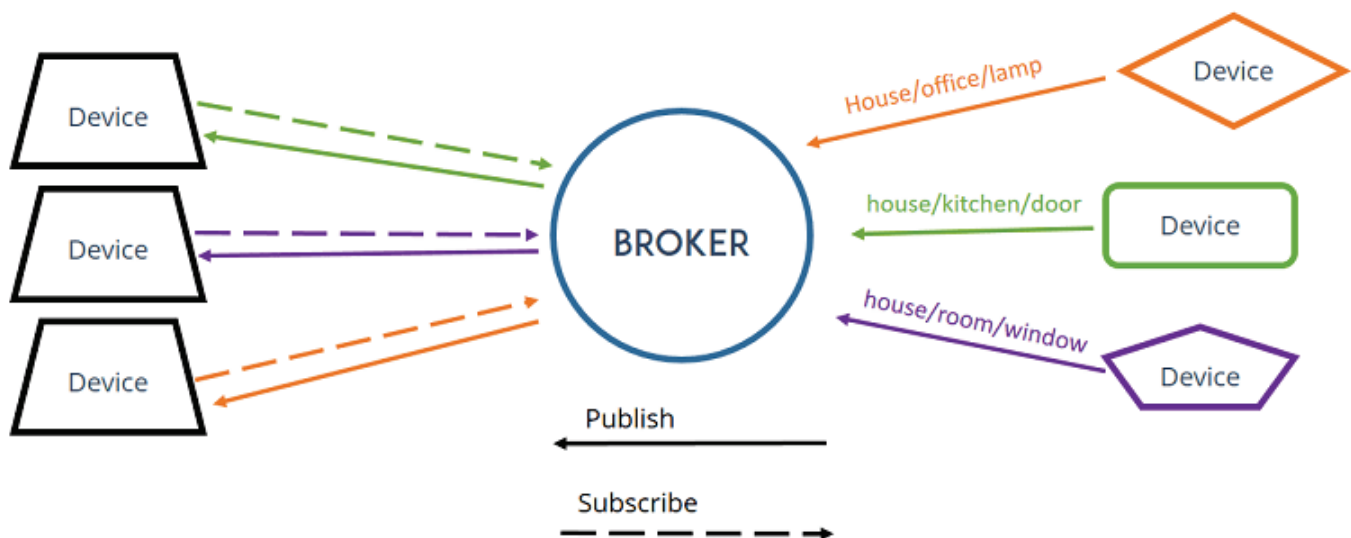

MQTT - Messages

Messages are the information that you want to exchange among your devices. Whether it is a command or data.

A minimal MQTT control message can be as little as two bytes of data. There are fourteen defined message types used to connect and disconnect a client from a broker, to publish data, to acknowledge receipt of data, and to supervise the connection between client and server.

MQTT – Topics

Topics are the way you register interest for incoming messages or how you specify where you want to publish the message.

Topics are represented with strings separated by a forward slash '/'. Each forward slash indicates a topic level. Here's an example on how you would create a topic for a lamp in your home office:

5G NR M2M Gateway

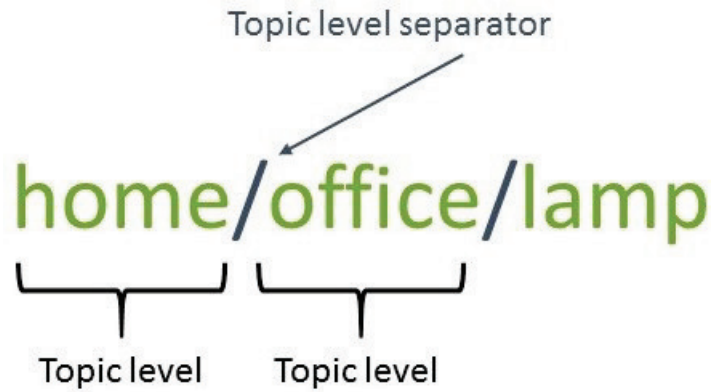

Note: topics are case-sensitive!

If you would like to turn on a lamp in your home office using MQTT, you can imagine the following scenario:

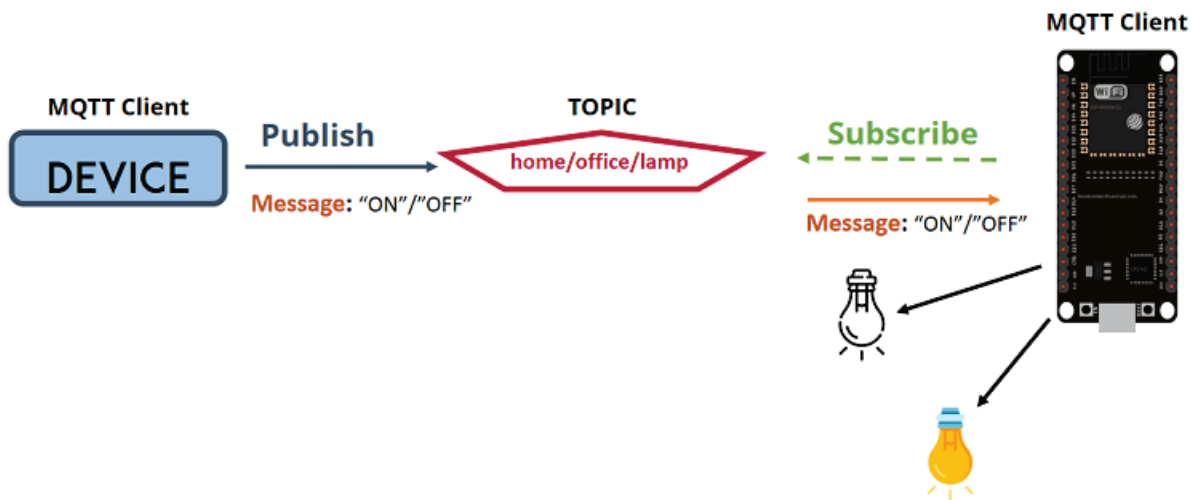

1. You have a device that published "on" and "off" message on the *home/office/lamp* topic.
2. You have a device that controls a lamp. And the device is subscribed to that topic: *home/office/lamp*.
3. So, when a new message is published on that topic, the subscriber received the "on" or "off" message and turns the lamp on or off.

Besides, there are two wildcard characters '+' and '#'. You can use the wildcard characters to subscribe similar topics at the same time easily.

'+' is single level wildcard; A '+' characters represents a single level of hierarchy, and is used between delimiters. For example, you can subscribe the topic "*home/+/lamp*" for all the lamps in a home.

'#' is the multi-level wildcard; A '#' character represents a complete sub-tree of the hierarchy and must be the last character in a subscription topic string. For example, you can subscribe the topic "*home/#*" for all the related message in a home.

5G NR M2M Gateway

This product is provided with MQTT functionality, both MQTT broker and MQTT client functions are supported. You can configure it for your IoT application scenario.

Go to **Field Communication > Data Interchange > MQTT** tab.

Play as a MQTT Broker

MQTT Broker Configuration	
Item	Setting
▶ Broker	<input type="checkbox"/> Enable
▶ Listening Port	<input type="text" value="1883"/> (1~65535)
▶ Authentication	<input type="checkbox"/> Enable
▶ Security	<input type="text" value="None"/> ▼

MQTT Broker Configuration		
Item	Value setting	Description
Broker	The box is unchecked by default.	Check the box to activate the MQTT Broker function.
Listening Port	1. An Optional setting. 2. 1883 is set by default	Specify a port as the listening port for MQTT broker. The MQTT broker will monitor the activity on that port and collect those valid packets from MQTT clients. If there is any MQTT client(s) that subscribing the received topic, the MQTT broker will forward the packet to the corresponding subscriber(s). Value Range: 1 ~ 65535.
Security	1. An Optional setting. 2. None is set by default	Select the security scheme for the MQTT packets. None: no encryption is involved for the MQTT packets. SSL/TLS: SSL/TLS encryption is applied for security. You have to further specify required certificate files. Note: If SSL/TLS is selected, the listen port will be changed to 8883 accordingly by default.
Certificate	1. An Optional setting. 2. None is set by default	Select CA File / CERT File / Key File from the dropdown lists. If you don't have available items in the dropdown list, you have to define or create it first. Please refer to Object Definition > Certificate > Trusted Certificate . CA File could be defined in Trusted Certificate List. CERT File could be defined in Trusted Client Certificate List. KEY File could be defined in Trusted Client Key List.
Authentication	1. An Optional setting. 2. The box is unchecked by default.	Check the box if user (account) authentication is required for subscribing the MQTT messages from the MQTT Broker. With the box checked, you can define up to five user accounts for permitted subscribers.
Save	N/A	Click the Save button to save the settings.

Create/Edit User List

5G NR M2M Gateway

User List Add Delete			
ID	Username	Password	Action

When the **Add** button is applied, **User List Configuration** screen will appear.

User List Configuration Save Undo	
Item	Setting
▶ Username	<input type="text"/>
▶ Password	<input type="text"/>

Scheme Configuration		
Item	Value setting	Description
Username	A Must filled setting.	Specify a name as the identifier of the MQTT subscriber. <i>Value Range:</i> 1 ~ 32 characters.
Password	A Must filled setting.	Specify a password for the user account. <i>Value Range:</i> 1 ~ 32 characters.
Save	N/A	Click the Save button to save the settings.
Undo	N/A	Click the Undo button to cancel the changes.

5G NR M2M Gateway

Play as a MQTT Client

In addition to play as a MQTT Broker, the gateway also support MQTT Client function. It can play as a MQTT client and publish message to MQTT broker, or subscribe interested topic(s) from MQTT Broker(s).

Item	Setting
MQTT Client	<input type="checkbox"/> Enable

Item	Value setting	Description
MQTT Client	The box is unchecked by default.	Check the box to activate the MQTT Client function. With the MQTT Client enabled, the gateway play as a MQTT client and publish message to MQTT broker, or subscribe interested topic(s) from MQTT Broker(s)
Save	N/A	Click the Save button to save the settings.

Create/Edit MQTT Client List

ID	Connection Name	Address	Authentication	Security	Port	Enable	Action
1	Broker01	1.2.3.4	<input type="checkbox"/>	None	1883	<input checked="" type="checkbox"/>	<input type="button" value="Subscriptions Received List"/> <input type="button" value="Edit"/>

When the **Add** button is applied, a sequence of configuration screens will will appear. They are **MQTT Client Configuration**, **MQTT Message Configuration**, **Publish Message List**, and **Subscribe Message List**.

Besides, there is a “**Subscriptions Received List**” button for you to access the subscribed & received message list. When the “**Subscriptions Received List**” button is applied, a message list will appear, and you can browse it page by page, download the messages to a file, or delete the messages.

5G NR M2M Gateway

Define MQTT Client Configuration

MQTT Client Configuration	
Item	Setting
▶ Connection Name	<input type="text"/>
▶ Address	<input type="text"/>
▶ Port	<input type="text" value="1883"/> (1~65535)
▶ Authentication	<input type="checkbox"/>
▶ Security	<input type="text" value="None"/>
▶ Client ID	<input type="text" value="00501869E631"/>
▶ Keep Alive	<input type="text" value="60"/> (5~86400 sec)
▶ Enable	<input type="checkbox"/>

MQTT Client Configuration		
Item	Value setting	Description
Connection Name	The box is unchecked by default.	Specify a name as the identifier of the MQTT Client. It can be identified with the Broker Name, or interested message (topic) Value Range: 1 ~ 64 characters.
Address	1. A Must-filled setting. 2. Blank by default	Specify the host name or IP address of the MQTT broker that the client is going to publish message to it, or subscribe messages from it.
Port	1. An Optional setting. 2. 1883 is set by default	Specify a port as the port for MQTT connection. Value Range: 1 ~ 65535.
Security	1. An Optional setting. 2. None is set by default	Select the security scheme for the MQTT connection. None: no encryption is involved for the MQTT connection. SSL/TLS: SSL/TLS encryption is applied for security. You have to further specify required certificate files. Note: If SSL/TLS is selected, the listen port will be changed to 8883 accordingly by default.
Certificate	1. An Optional setting. 2. None is set by default	Select CA File / CERT File / Key File from the dropdown lists. If you don't have available items in the dropdown list, you have to define or create it first. Please refer to Object Definition > Certificate > Trusted Certificate . CA File could be defined in Trusted Certificate List. CERT File could be defined in Trusted Client Certificate List. KEY File could be defined in Trusted Client Key List.
Client ID	1. A Must-filled setting. 2. ID with device MAC is set by default	Specify an unique ID for the MQTT client. By default the MAC address is used as the ID string.
Authentication	1. An Optional setting. 2. The box is unchecked by default.	Check the box if user (account) authentication is required for subscribing the MQTT messages. With the box checked, you have to further specify Username and Password for the connection.
Username	A Must filled setting.	Specify a name as the identifier of the MQTT client.

5G NR M2M Gateway

		Value Range: 1 ~ 32 characters.
Password	A Must filled setting.	Specify a password for the user account. Value Range: 1 ~ 32 characters.
Keep Alive	1. An Optional setting. 2. 60 sec is set by default.	Specify a keep alive interval to keep the connection alive while the connection is idle. Value Range: 5 ~ 86400 sec.
Enable	The box is unchecked by default.	Check the box to activate this MQTT Client configuration
Save	N/A	Click the Save button to save the settings.
Undo	N/A	Click the Undo button to cancel the changes.
Back	N/A	Click the Back button to go back to previous configuration screen.

Define MQTT Message

You can define the Last Will Message, and optional Topic Prefix for publishing / subscribing MQTT messages.

MQTT Message Configuration

Item	Setting
▶ Last Will	<input checked="" type="checkbox"/> Enable
▶ Topic	<input style="width: 100%;" type="text"/>
▶ Message	<input style="width: 100%; height: 40px;" type="text"/>
▶ QoS	<input checked="" type="radio"/> 0 (At most once) <input type="radio"/> 1 (At least once) <input type="radio"/> 2 (Exactly once)
▶ Topic prefix (Optional)	<input style="width: 100%;" type="text"/>

MQTT Message Configuration		
Item	Value setting	Description
Enable	The box is unchecked by default.	Check the box to activate this Last Will message configuration If the box is checked, you have to further specify Topic, Message, and QoS settings. When the MQTT broker detected that the MQTT client is disconnected, it will send the Last Will message to the interested MQTT subscribers.
Topic	1. A Must-filled setting. 2. Blank by default	Specify the topic for the Last Will message. Value Range: 1 ~ 64 characters, including the topic level separator '/', but excluding the wildcards '+' and '#'.
Message	1. A Must-filled setting. 2. Blank by default	Specify the message content for the Last Will message. Value Range: 1 ~ 256 characters.
QoS	1. An Optional setting. 2. 0 (At most once) is	Select the QoS type for the Last Will message. 0 (At most once): the message will be published only once, and the broker and

5G NR M2M Gateway

	set by default	subscribed client(s) take no additional steps to acknowledge the delivery, no matter it is received or not. 1 (At least once): the message will be published at least once until acknowledgement is received from the broker or subscribed client(s). 2 (Exactly once): the message will be published to subscriber(s) once in a two-level handshake to ensure only one copy of the message is received.
Topic prefix (Optional)	1. An Optional-filled setting. 2. Blank by default	Specify the topic prefix for MQTT message. Value Range: 1 ~ 64 characters.
Save	N/A	Click the Save button to save the settings.
Undo	N/A	Click the Undo button to cancel the changes.
Back	N/A	Click the Back button to go back to previous configuration screen.

Publish Message List

Publish Message List <input type="button" value="Add"/> <input type="button" value="Delete"/>				
ID	Topic	QoS	Enable	

Up to 64 published messages will be shown in the message list. When the **Add** button is applied, **Publish Message Configuration** screen will appear.

Publish Message Configuration <input type="button" value="Save"/> <input type="button" value="Undo"/>	
Item	Setting
▶ Topic	<input type="text"/>
▶ Topics prefix	<input type="checkbox"/> Enable
▶ Message Style	Manual ▾
▶ Message	<input type="text"/>
▶ QoS	<input checked="" type="radio"/> 0 (At most once) <input type="radio"/> 1 (At least once) <input type="radio"/> 2 (Exactly once)
▶ Retained	<input type="checkbox"/> Enable
▶ Publish Behavior	<input type="checkbox"/> Auto Publish
▶ Enable	<input type="checkbox"/>

Publish Message Configuration		
Item	Value setting	Description
Topic	1. A Must-filled setting. 2. Blank by default	Specify the topic for the message to be published. Value Range: 1 ~ 64 characters, including the topic level separator '/', but excluding the wildcards '+' and '#'.
Topic prefix	The box is unchecked by default.	Check the box to add the predefined topic prefix into a MQTT message.

5G NR M2M Gateway

Message Style	1. An Optional-filled setting. 2. Manual is selected by default	Select a message style from the dropdown list. The supported styles are : Manual: The message is create manually, and you can specify the message content below. System Log: The message to be published are the System log of the device. Data Logging: The message to be published are the Data Logging recorded in the designated storage
Message	1. A Must-filled setting. 2. Blank by default	Specify the message content for the Manual publish message. Value Range: 1 ~ 256 characters.
QoS	1. An Optional setting. 2. 0 (At most once) is set by default	Select the QoS type for publishing a message. 0 (At most once): the message will be published only once, and the broker and subscribed client(s) take no additional steps to acknowledge the delevivery, no matter it is received or not. 1 (At least once): the message will be published at least once until acknowledgement is received from the broker or subscribed clent(s). 2 (Exactly once): the message will be published to subscriber(s) once in a two-level handshake to ensure onle one copy of the message is received.
Retained	The box is unchecked by default.	Check the box to activate this message retaining function.
Publish Behavior	The box is unchecked by default.	Check the box(es) for the expected publish behavior: Auto Publish: auto publish a message with specified time interval (1~65535 sec). When the Message or Data variation more than <input type="checkbox"/> lines.: publish a new message that variates from previous one for specified changes. Note: if Message style is set to Manual, only Auto Publish is available.
Enable	The box is unchecked by default.	Check the box to activate this publish message configuration.
Save	N/A	Click the Save button to save the settings.
Undo	N/A	Click the Undo button to cancel the changes.
Back	N/A	Click the Back button to go back to previous configuration screen.

Subscribe Message List

Subscribe Message List <input type="button" value="Add"/> <input type="button" value="Delete"/>			
ID	Topic	QoS	Enable

Up to 64 subscribed messages will be shown in the message list. When the **Add** button is applied, **Subscribe Message Configuration** screen will appear.

5G NR M2M Gateway

Subscribe Message Configuration	
	<input type="button" value="Save"/> <input type="button" value="Undo"/>
Item	Setting
▶ Topic	<input type="text"/>
▶ Topics prefix	<input type="checkbox"/> Enable
▶ QoS	<input checked="" type="radio"/> 0 (At most once) <input type="radio"/> 1 (At least once) <input type="radio"/> 2 (Exactly once)
▶ Enable	<input type="checkbox"/>

Subscribe Message Configuration		
Item	Value setting	Description
Topic	1. A Must-filled setting. 2. Blank by default	Specify the topic for the message to be subscribed. Value Range: 1 ~ 64 characters, including the topic level separator '/', and wildcards '+', '#'.
Topic prefix	The box is unchecked by default.	Check the box to enable the topic prefix for subscribed message.
QoS	1. An Optional setting. 2. 0 (At most once) is set by default	Select the QoS type for subscribing a message. 0 (At most once): the message will be published only once, and the broker and subscribed client(s) take no additional steps to acknowledge the delivery, no matter it is received or not. 1 (At least once): the message will be published at least once until acknowledgement is received from the broker or subscribed client(s). 2 (Exactly once): the message will be published to subscriber(s) once in a two-level handshake to ensure only one copy of the message is received.
Enable	The box is unchecked by default.	Check the box to activate this subscribe message configuration
Save	N/A	Click the Save button to save the settings.
Undo	N/A	Click the Undo button to cancel the changes.
Back	N/A	Click the Back button to go back to previous configuration screen.

5G NR M2M Gateway

Chapter 5 Security

5.1 VPN

A virtual private network (VPN) extends a private network across a public network, such as the Internet. It enables a computer to send and receive data across shared or public networks as if it were directly connected to the private network, while benefitting from the functionality, security and management policies of the private network. This is done by establishing a virtual point-to-point connection through the use of dedicated connections, encryption, or a combination of the two. The tunnel technology supports data confidentiality, data origin authentication and data integrity of network information by utilizing encapsulation protocols, encryption algorithms, and hashing algorithms.

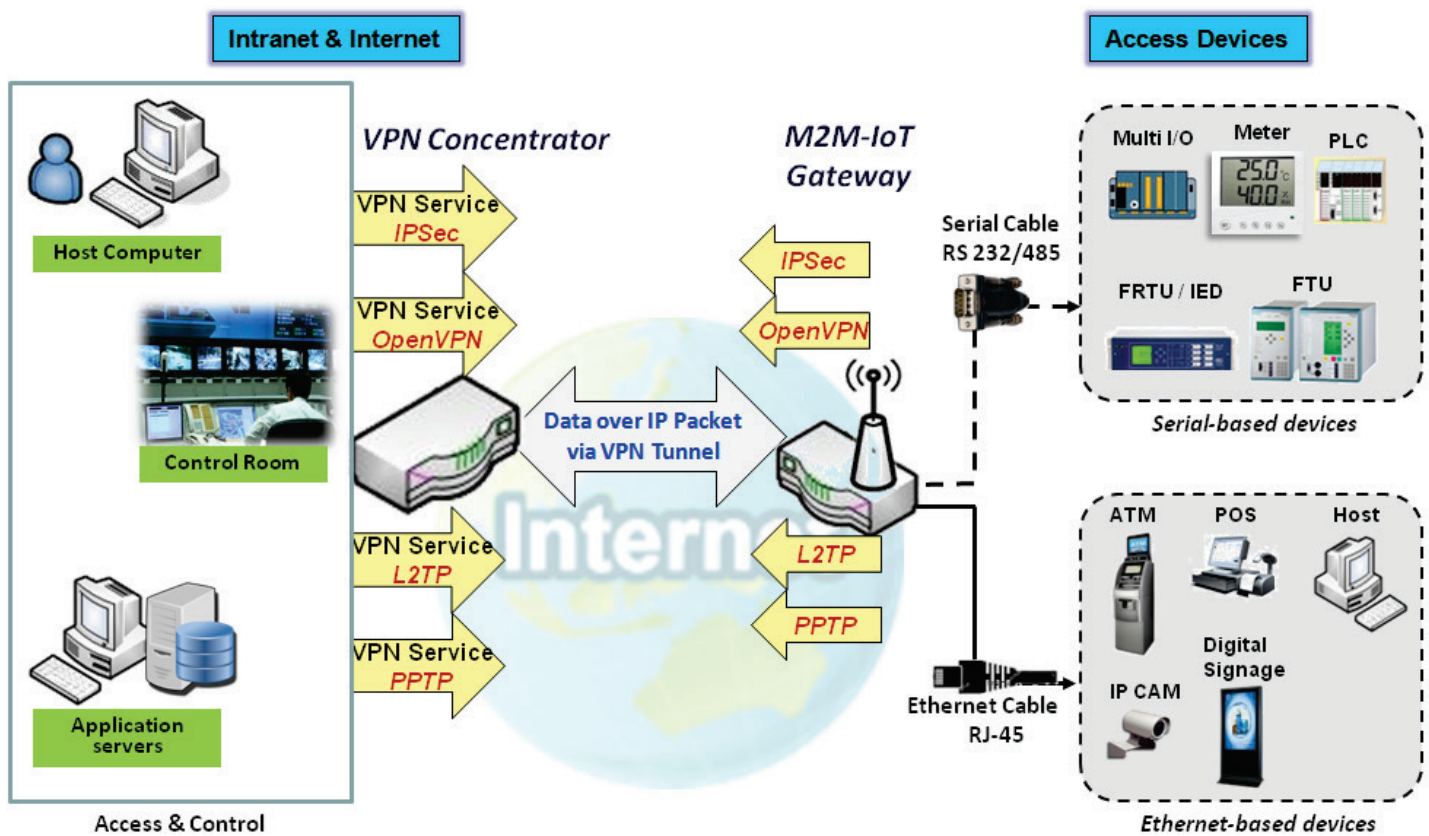

The product series supports different tunneling technologies to establish secure tunnels between multiple sites for data transferring, such as IPSec, OpenVPN, L2TP (over IPSec), PPTP and GRE. Besides, some advanced functions, like Full Tunnel, Tunnel Failover, Tunnel Load Balance, NetBIOS over IPSec, NAT Traversal and Dynamic VPN, are also supported.

5G NR M2M Gateway

5.1.1 IPSec

Internet Protocol Security (IPSec) is a protocol suite for securing Internet Protocol (IP) communications by authenticating and encrypting each IP packet of a communication session. IPSec includes protocols for establishing mutual authentication between agents at the beginning of the session and negotiation of cryptographic keys to be used during the session.

An IPSec VPN tunnel is established between IPSec client and server. Sometimes, we call the IPSec VPN client as the initiator and the IPSec VPN server as the responder. This gateway can be configured as different roles and establish number of tunnels with various remote devices. Before going to setup the VPN connections, you may need to decide the scenario type for the tunneling.

IPSec Tunnel Scenarios

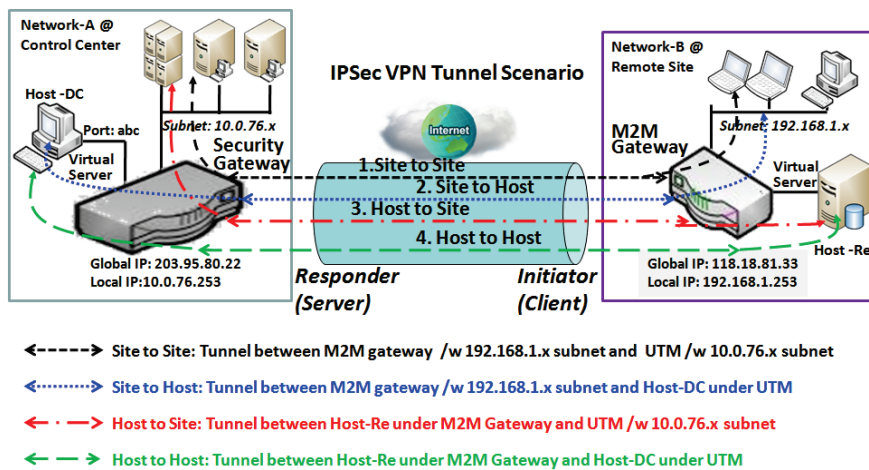

To build IPSec tunnel, you need to fill in remote gateway global IP, and optional subnet if the hosts behind IPSec peer can access to remote site or hosts. Under such configuration, there are four scenarios:

Site to Site: You need to setup remote gateway IP and subnet of both gateways. After the IPSec tunnel established, hosts behind both gateways can communication each other through the tunnel.

Site to Host: Site to Host is suitable for tunneling between clients in a subnet and an application server (host). As in the diagram, the clients behind the M2M gateway can access to the host "Host-DC" located in the control center through Site to Host VPN tunnel.

Host to Site: On the contrast, for a single host (or mobile user to) to access the resources located in an intranet, the Host to Site scenario can be applied.

Host to Host: Host to Host is a special configuration for building a VPN tunnel between two single hosts.

5G NR M2M Gateway

IPSec Setting

Go to **Security > VPN > IPSec** tab.

The IPSec Setting allows user to create and configure IPSec tunnels.

Enable IPSec

Configuration	
Item	Setting
▶ IPSec	<input type="checkbox"/> Enable
▶ Max. Concurrent IPSec Tunnels	16

Configuration Window		
Item	Value setting	Description
IPSec	Unchecked by default	Click the Enable box to enable IPSec function.
Max. Concurrent IPSec Tunnels	Depends on Product specification.	The specified value will limit the maximum number of simultaneous IPSec tunnel connection. The default value can be different for the purchased model.
Save	N/A	Click Save to save the settings
Undo	N/A	Click Undo to cancel the settings

Create/Edit IPSec tunnel

Ensure that the IPSec enable box is checked to enable before further configuring the IPSec tunnel settings.

IPSec Tunnel List						
ID	Tunnel Name	Interface	Remote Gateway	Remote Subnet	Status	Enable

When **Add/Edit** button is applied, a series of configuration screens will appear. They are Tunnel Configuration, Local & Remote Configuration, Authentication, IKE Phase, IKE Proposal Definition, IPSec Phase, and IPSec Proposal Definition. You have to configure the tunnel details for both local and remote VPN devices.

5G NR M2M Gateway

Tunnel Configuration	
Item	Setting
Tunnel	<input type="checkbox"/> Enable
Tunnel Name	IPSec #1
Interface	WAN-1 ▼
Tunnel Scenario	Site-to-Site(Tunnel mode) ▼
Tunnel TCP MSS	Auto ▼ 0 (64~1500 Bytes)
ICMP Keep alive	<input type="checkbox"/> Enable Max. fail times 3 Interval 30 (secs.) Source Addr. Destination Addr.
Encapsulation Protocol	ESP ▼
IKE Version	v1 ▼

Tunnel Configuration Window		
Item	Value setting	Description
Tunnel	Unchecked by default	Check the Enable box to activate the IPSec tunnel
Tunnel Name	1. A Must fill setting 2. String format can be any text	Enter a tunnel name. Enter a name that is easy for you to identify. Value Range: 1 ~ 19 characters.
Interface	1. A Must fill setting 2. WAN 1 is selected by default	Select the interface on which IPSec tunnel is to be established. It can be the available WAN and LAN interfaces.
Tunnel Scenario	1. A Must fill setting 2. Site to site is selected by default	Select an IPSec tunneling scenario from the dropdown box for your application. Select Site-to-Site , Site-to-Host , Host-to-Site , or Host-to-Host . If LAN interface is selected, only Host-to-Host scenario is available. With Site-to-Site or Site-to-Host or Host-to-Site , IPSec operates in tunnel mode. The difference among them is the number of subnets. With Host-to-Host , IPSec operates in transport mode.
Tunnel TCP MSS	1. An optional setting 2. Auto is set by default	Select from the dropdown box to define the size of Tunnel TCP MSS. Select Auto , and all devices will adjust this parameter automatically. Select Manual , and specify an expected value for Tunnel TCP MSS. Value Range: 64 ~ 1500 bytes.
ICMP Keep Alive	1. An optional setting 2. Unchecked by default	Check the Enable box to activate the ICMP keep alive function for the tunnel. If the keep alive function is enabled, you have to define the number of fail trials, check interval, and source/destination IP address for the ICMP packets. Value Range: 1~999 for fail trials and time interval.
Encapsulation Protocol	1. A Must fill setting 2. ESP is selected by default	Select the Encapsulation Protocol from the dropdown box for this IPSec tunnel. Available encapsulations are ESP and AH .
IKE Version	1. A Must fill setting 2. v1 is selected by default	Specify the IKE version for this IPSec tunnel. Select v1 or v2 .

5G NR M2M Gateway

Local & Remote Configuration				
Item	Setting			
▶ Local Subnet List	ID	Subnet IP Address	Subnet Mask	Actions
	1	<input type="text" value="192.168.66.0"/>	<input type="text" value="255.255.255.0/(24)"/>	<input type="button" value="Delete"/>
	<input type="button" value="Add"/>			
▶ Remote Subnet List	ID	Subnet IP Address	Subnet Mask	Actions
	1	<input type="text"/>	<input type="text" value="255.255.255.0/(24)"/>	<input type="button" value="Delete"/>
	<input type="button" value="Add"/>			
▶ Remote Gateway	<input type="text"/> (IP Address/FQDN)			

Local & Remote Configuration Window		
Item	Value setting	Description
Local Subnet List	A Must fill setting	<p>Specify the Local Subnet IP address and Subnet Mask. Click the Add or Delete button to add or delete a Local Subnet.</p> <p>Note_1: When Dynamic VPN option in Tunnel Scenario is selected, there will be only one subnet available. Note_2: When Host-to-Site or Host-to-Host option in Tunnel Scenario is selected, Local Subnet will not be available. Note_3: When Hub and Spoke option in Hub and Spoke is selected, there will be only one subnet available.</p>
Remote Subnet List	A Must fill setting	<p>Specify the Remote Subnet IP address and Subnet Mask. Click the Add or Delete button to add or delete Remote Subnet setting.</p>
Remote Gateway	1. A Must fill setting. 2. Format can be a ipv4 address or FQDN	Specify the Remote Gateway.

Authentication	
Item	Setting
▶ Key Management	<input type="text" value="IKE+Pre-shared Key"/> (Min. 8 characters)
▶ Local ID	Type: <input type="text" value="User Name"/> ID: <input type="text"/> (Optional)
▶ Remote ID	Type: <input type="text" value="User Name"/> ID: <input type="text"/>

Authentication Configuration Window		
Item	Value setting	Description
Key Management	1. A Must fill setting 2. Pre-shared Key 8 to 32 characters.	<p>Select Key Management from the dropdown box for this IPsec tunnel.</p> <p>IKE+Pre-shared Key: user needs to set a key (8 ~ 32 characters). IKE+X.509: user needs Certificate to authenticate. IKE+X.509 will be available only when Certificate has been configured properly. Refer to Certificate section of this manual and also Object Definition > Certificate in web-based utility.</p>
Local ID	An optional setting	<p>Specify the Local ID for this IPsec tunnel to authenticate.</p> <p>Select User Name for Local ID and enter the username. The username may include but can't be all numbers. Select FQDN for Local ID and enter the FQDN. Select User@FQDN for Local ID and enter the User@FQDN. Select Key ID for Local ID and enter the Key ID (English alphabet or number).</p>

5G NR M2M Gateway

Remote ID	An optional setting	<p>Specify the Remote ID for this IPsec tunnel to authenticate.</p> <p>Select User Name for Remote ID and enter the username. The username may include but can't be all numbers.</p> <p>Select FQDN for Local ID and enter the FQDN.</p> <p>Select User@FQDN for Remote ID and enter the User@FQDN.</p> <p>Select Key ID for Remote ID and enter the Key ID (English alphabet or number).</p> <p>Note: Remote ID will be not available when Dynamic VPN option in Tunnel Scenario is selected.</p>
------------------	---------------------	--

IKE Phase	
Item	Setting
▶ Negotiation Mode	Main Mode ▼
▶ X-Auth	None ▼ X-Auth Account (Optional) User Name : <input type="text"/> Password : <input type="text"/>
▶ Dead Peer Detection (DPD)	<input checked="" type="checkbox"/> Enable Timeout : <input type="text" value="180"/> (seconds) Delay : <input type="text" value="30"/> (seconds)
▶ Phase1 Key Life Time	<input type="text" value="3600"/> (seconds) (Max. 86400)

IKE Phase Window		
Item	Value setting	Description
Negotiation Mode	Main Mode is set by default default	Specify the Negotiation Mode for this IPsec tunnel. Select Main Mode or Aggressive Mode .
X-Auth	None is selected by default	Specify the X-Auth role for this IPsec tunnel. Select Server, Client, or None. Selected None no X-Auth authentication is required. Selected Server this gateway will be an X-Auth server. Click on the X-Auth Account button to create remote X-Auth client account. Selected Client this gateway will be an X-Auth client. Enter User name and Password to be authenticated by the X-Auth server gateway. Note: X-Auth Client will not be available for Dynamic VPN option selected in Tunnel Scenario.
Dead Peer Detection (DPD)	1. Checked by default 2. Default Timeout 180s and Delay 30s	Click Enable box to enable DPD function. Specify the Timeout and Delay time in seconds. Value Range: 0 ~ 999 seconds for Timeout and Delay.
Phase1 Key Life Time	1. A Must fill setting 2. Default 3600s 3. Max. 86400s	Specify the Phase1 Key Life Time. Value Range: 30 ~ 86400.

IKE Proposal Definition				
ID	Encryption	Authentication	DH Group	Definition
1	AES-128 ▼	SHA1 ▼	Group 2 ▼	<input checked="" type="checkbox"/> Enable
2	AES-128 ▼	MD5 ▼	Group 2 ▼	<input checked="" type="checkbox"/> Enable
3	DES ▼	SHA1 ▼	Group 2 ▼	<input checked="" type="checkbox"/> Enable
4	3DES ▼	SHA1 ▼	Group 2 ▼	<input checked="" type="checkbox"/> Enable

IKE Proposal Definition Window		
Item	Value setting	Description

5G NR M2M Gateway

IKE Proposal Definition	A Must fill setting	Specify the Phase 1 Encryption method. It can be DES / 3DES / AES-128 / AES-192 / AES-256.
		Specify the Authentication method. It can be None / MD5 / SHA1 / SHA2-256.
		Specify the DH Group. It can be None / Group1 / Group2 / Group5 / Group14 / Group15 / Group16 / Group17 / Group18.
		Check Enable box to enable this setting

IPSec Phase	
Item	Setting
Phase2 Key Life Time	<input type="text" value="28800"/> (seconds) (Max. 86400)

IPSec Phase Window		
Item	Value setting	Description
Phase2 Key Life Time	1. A Must fill setting 2. 28800s is set by default 3. Max. 86400s	Specify the Phase2 Key Life Time in second. Value Range: 30 ~ 86400.

IPSec Proposal Definition				
ID	Encryption	Authentication	PFS Group	Definition
1	<input type="text" value="AES-128"/>	<input type="text" value="SHA1"/>	<input type="text" value="Group 2"/>	<input checked="" type="checkbox"/> Enable
2	<input type="text" value="AES-128"/>	<input type="text" value="MD5"/>		<input checked="" type="checkbox"/> Enable
3	<input type="text" value="DES"/>	<input type="text" value="SHA1"/>		<input checked="" type="checkbox"/> Enable
4	<input type="text" value="3DES"/>	<input type="text" value="SHA1"/>		<input checked="" type="checkbox"/> Enable

IPSec Proposal Definition Window		
Item	Value setting	Description
IPSec Proposal Definition	A Must fill setting	Specify the Encryption method. It can be DES / 3DES / AES-128 / AES-192 / AES-256. Note: None is available when Encapsulation Protocol is set as AH .
		Specify the Authentication method. It can be None / MD5 / SHA1 / SHA2-256. Note: None and SHA2-256 are available only when Encapsulation Protocol is set as ESP ; they are not available for AH Encapsulation.
		Specify the PFS Group. It can be None / Group1 / Group2 / Group5 / Group14 / Group15 / Group16 / Group17 / Group18. Click Enable to enable this setting
		Save N/A Click Save to save the settings Undo N/A Click Undo to cancel the settings Back N/A Click Back to return to the previous page.

5G NR M2M Gateway

Create/Edit Dynamic VPN Server List

Dynamic VPN List ⬆️ ⬇️

Similar to create an IPSec VPN Tunnel for site/host to site/host scenario, when **Add / Edit** button is applied a series of configuration screen will appear. They are Tunnel Configuration, Local & Remote Configuration, Authentication, IKE Phase, IKE Proposal Definition, IPSec Phase, and IPSec Proposal Definition. You have to configure the tunnel details for the gateway as a Dynamic VPN server.

Note: For the purchased gateway, you can configure one Dynamic VPN server for each WAN interface.

Tunnel Configuration	
Item	Setting
▶ Tunnel	<input type="checkbox"/> Enable
▶ Tunnel Name	<input type="text" value="Dynamic IPSec1"/>
▶ Interface	<input type="text" value="WAN1"/> ▼
▶ Tunnel Scenario	<input type="text" value="Tunnel Mode"/> ▼
▶ Encapsulation Protocol	<input type="text" value="ESP"/> ▼
▶ IKE Version	<input type="text" value="v1"/> ▼

Tunnel Configuration Window		
Item	Value setting	Description
Tunnel	Unchecked by default	Check the Enable box to activate the Dynamic IPSec VPN tunnel.
Tunnel Name	1. A Must fill setting 2. String format can be any text	Enter a tunnel name. Enter a name that is easy for you to identify. Value Range: 1 ~ 19 characters.
Interface	1. A Must fill setting 2. WAN 1 is selected by default	Select WAN interface on which IPSec tunnel is to be established.
Tunnel Scenario	1. A Must fill setting 2. Tunnel Mode is selected by default	Select the Dynamic IPSec tunneling scenario. It can be Tunnel Mode or Transport Mode .
Encapsulation Protocol	1. A Must fill setting 2. ESP is selected by default	Select the Encapsulation Protocol from the dropdown box for this IPSec tunnel. Available encapsulations are ESP and AH .
IKE Version	1. A Must fill setting 2. v1 is selected by default	Specify the IKE version for this IPSec tunnel.

Local & Remote Configuration	
Item	Setting
▶ Local Subnet	<input type="text" value="192.168.66.0"/>
▶ Local Netmask	<input type="text" value="255.255.255.0/(24)"/> ▼

Local & Remote Configuration Window

5G NR M2M Gateway

Item	Value setting	Description
Local Subnet	A Must fill setting	Specify the Local Subnet IP address.
Local Netmask	A Must fill setting	Specify the Local Subnet Mask.

Authentication	
Item	Setting
▶ Key Management	IKE+Pre-shared Key <input type="text"/> (Min. 8 characters)
▶ Local ID	Type: User Name <input type="text"/> ID: <input type="text"/> (Optional)
▶ Remote ID	Type: User Name <input type="text"/> ID: <input type="text"/>

Authentication Configuration Window		
Item	Value setting	Description
Key Management	1. A Must fill setting 2. Pre-shared Key 8 to 32 characters.	Select Key Management from the dropdown box for this IPsec tunnel. IKE+Pre-shared Key ; user needs to set a key (8 ~ 32 characters).
Local ID	An optional setting	Specify the Local ID for this IPsec tunnel to authenticate. Select User Name for Local ID and enter the username. The username may include but can't be all numbers. Select FQDN for Local ID and enter the FQDN. Select User@FQDN for Local ID and enter the User@FQDN. Select Key ID for Local ID and enter the Key ID (English alphabet or number).
Remote ID	An optional setting	Specify the Remote ID for this IPsec tunnel to authenticate. Select User Name for Remote ID and enter the username. The username may include but can't be all numbers. Select FQDN for Local ID and enter the FQDN. Select User@FQDN for Remote ID and enter the User@FQDN. Select Key ID for Remote ID and enter the Key ID (English alphabet or number). Note: Remote ID will be not available when Dynamic VPN option in Tunnel Scenario is selected.

For the rest IKE Phase, IKE Proposal Definition, IPsec Phase, and IPsec Proposal Definition settings, they are the same as that of creating an IPsec Tunnel described in previous section. Please refer to the related description.

5G NR M2M Gateway

5.1.2 OpenVPN

OpenVPN is an application that implements virtual private network (VPN) techniques for creating secure point-to-point or site-to-site connections in routed or bridged configurations and remote access facilities. It uses a custom security protocol that utilizes SSL/TLS for key exchange. It is capable of traversing network address translators (NATs) and firewalls.

OpenVPN allows peers to authenticate each other using a Static Key (pre-shared key) or certificates. When used in a multi-client-server configuration, it allows the server to release an authentication certificate for every client, using signature and certificate authority. It uses the OpenSSL encryption library extensively, as well as the SSLv3/TLSv1 protocol, and contains many security and control features.

OpenVPN Tunneling is a Client and Server based tunneling technology. The OpenVPN Server must have a Static IP or a FQDN, and maintain a Client list. The OpenVPN Client may be a mobile user or mobile site with public IP or private IP, and requesting the OpenVPN tunnel connection. The product supports both OpenVPN Server and OpenVPN Client features to meet different application requirements.

There are two OpenVPN connection scenarios. They are the TAP and TUN scenarios. The product can create either a layer-3 based IP tunnel (TUN), or a layer-2 based Ethernet TAP that can carry any type of Ethernet traffic. In addition to configuring the device as a Server or Client, you have to specify which type of OpenVPN connection scenario is to be adopted.

OpenVPN TUN Scenario

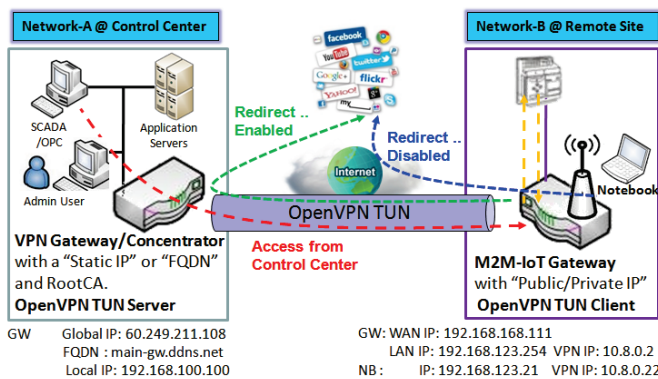

1. M2M-IoT Gateway (as OpenVPN TUN Client) connects to peer VPN Gateway/Concentrator (as OpenVPN TUN Server).
2. M2M-IoT Gateway will be assigned 10.8.0.2 IP Address after OpenVPN TUN Connection established. (10.8.0.x is a virtual subnet)
3. Local networked device will get a virtual IP 10.8.0.x if its traffic goes through the OpenVPN TUN connection (when NAT disabled & Redirect Internet Traffic enabled).
4. SCADA Server in Control Center can access remote attached device(s) with the assigned IP Address 10.8.0.2.

The term "TUN" mode is referred to routing mode and operates with layer 3 packets. In routing mode, the VPN client is given an IP address on a different subnet than the local LAN under the OpenVPN server. This virtual subnet is created for connecting to any remote VPN computers. In routing mode, the OpenVPN server creates a "TUN" interface with its own IP address pool which is different to the local LAN. Remote hosts that dial-in will get an IP address inside the virtual network and will have access only to the server where OpenVPN resides.

If you want to offer remote access to a VPN server from client(s), and inhibit the access to remote LAN resources under VPN server, OpenVPN TUN mode is the simplest solution.

As shown in the diagram, the M2M-IoT Gateway is configured as an OpenVPN TUN Client, and connects to an OpenVPN TUN Server. Once the OpenVPN TUN connection is established, the connected TUN client will be assigned a virtual IP (10.8.0.2) which is belong to a virtual subnet that is different to the local subnet in Control Center. With such connection, the local networked devices will get a virtual IP 10.8.0.x if its traffic goes through

5G NR M2M Gateway

the OpenVPN TUN connection when Redirect Internet Traffic settings is enabled; Besides, the SCADA Server in Control Center can access remote attached serial device(s) with the virtual IP address (10.8.0.2).

OpenVPN TAP Scenario

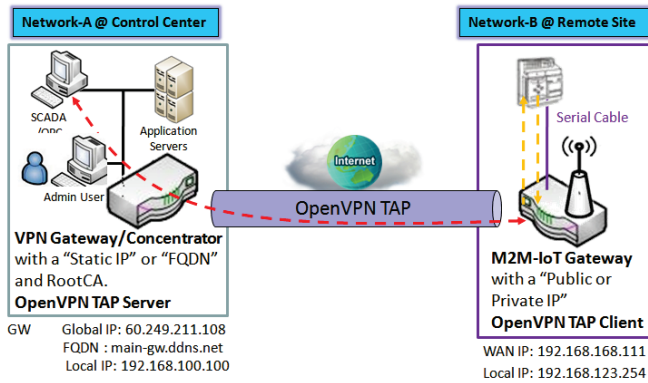

1. M2M-IoT Gateway (as OpenVPN TAP Client) connects to peer VPN Gateway/Concentrator (as OpenVPN TAP Server).
2. M2M-IoT Gateway will be assigned **192.168.100.210** IP Address after OpenVPN TAP Connection established. (same subnet as in Control Center)
3. SCADA Server in Control Center can access remote attached device(s) with the assigned IP Address 192.168.100.210.

The term "TAP" is referred to bridge mode and operates with layer 2 packets. In bridge mode, the VPN client is given an IP address on the same subnet as the LAN resided under the OpenVPN server. Under such configuration, the OpenVPN client can directly access to the resources in LAN. If you want to offer remote access to the entire remote LAN for VPN client(s), you have to setup OpenVPN in "TAP" bridge mode.

As shown in the diagram, the M2M-IoT Gateway is configured as an OpenVPN TAP Client, and connects to an OpenVPN TAP Server. Once the OpenVPN TAP connection is established, the connected TAP client will be assigned a virtual IP (192.168.100.210) which is the same subnet as

that of local subnet in Control Center. With such connection, the SCADA Server in Control Center can access remote attached serial device(s) with the virtual IP address (192.168.100.210).

5G NR M2M Gateway

Open VPN Setting

Go to **Security > VPN > OpenVPN** tab.

The OpenVPN setting allows user to create and configure OpenVPN tunnels.

Enable OpenVPN

Enable OpenVPN and select an expected configuration, either server or client, for the gateway to operate.

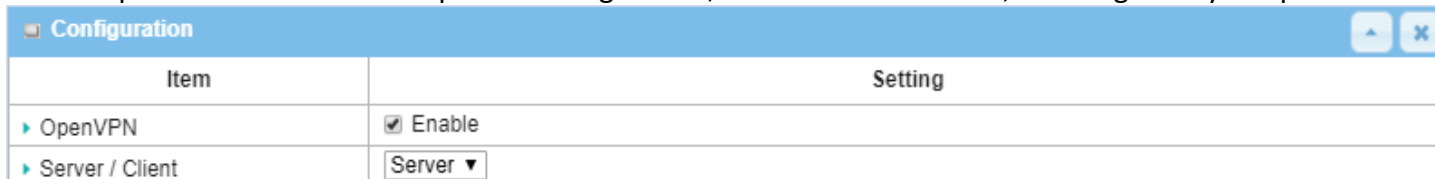

Item	Setting
▶ OpenVPN	<input checked="" type="checkbox"/> Enable
▶ Server / Client	Server ▼

Configuration		
Item	Value setting	Description
OpenVPN	The box is unchecked by default	Check the Enable box to activate the OpenVPN function.
Server/Client	Server Configuration is selected by default.	When Server is selected, as the name indicated, server configuration will be displayed below for further setup. When Client is selected, you can specify the client settings in another client configuration window.

5G NR M2M Gateway

As an OpenVPN Server

If **Server** is selected, an OpenVPN Server Configuration screen will appear. **OpenVPN Server Configuration** window can let you enable the OpenVPN server function, specify the virtual IP address of OpenVPN server, when remote OpenVPN clients dial in, and the authentication protocol.

Item	Setting
OpenVPN	<input checked="" type="checkbox"/> Enable
Server / Client	Server ▼
OpenVPN Configuration file	<input type="checkbox"/> Enable <input type="button" value="Export"/> client.ovpn

Item	Value setting	Description
OpenVPN Configuration File	1. An Optional setting. 2. The box is unchecked by default.	Click the Enable box to activate the export feature of OpenVPN Client configuration to a .ovpn file. You have to further click the Export button to get the configuration file.

The OpenVPN Server supports up to 4 TUN / TAP tunnels at the same time.

Item	Setting
OpenVPN Server	<input type="checkbox"/> Enable
Protocol	TCP ▼
Port	4430
Tunnel Scenario	TUN ▼
Authorization Mode	TLS ▼ CA Cert.: amit-IDG761AM-JH.crt ▼ Server Cert.: LocalCert1 ▼
Server Virtual IP	10.8.0.0
DHCP-Proxy Mode	<input checked="" type="checkbox"/> Enable
IP Pool	Starting Address: <input type="text"/> ~ Ending Address: <input type="text"/>
Gateway	<input type="text"/>
Netmask	255.255.255.0(/24) ▼
Redirect Default Gateway	<input type="checkbox"/> Enable
Encryption Cipher	Blowfish ▼
Hash Algorithm	SHA-1 ▼
LZO Compression	Adaptive ▼
Persist Key	<input checked="" type="checkbox"/> Enable
Persist Tun	<input checked="" type="checkbox"/> Enable
Advanced Configuration	<input type="button" value="Edit"/>

5G NR M2M Gateway

OpenVPN Server Configuration		
Item	Value setting	Description
OpenVPN Server	The box is unchecked by default.	Click the Enable to activate OpenVPN Server functions.
Protocol	<ol style="list-style-type: none"> 1. A Must filled setting 2. By default TCP is selected. 	Define the selected Protocol for connecting to the OpenVPN Server. <ul style="list-style-type: none"> • Select TCP , or UDP -> The TCP protocol will be used to access the OpenVPN Server, and Port will be set as 4430 automatically. • Select UDP -> The UDP protocol will be used to access the OpenVPN Server, and Port will be set as 1194 automatically.
Port	<ol style="list-style-type: none"> 1. A Must filled setting 2. By default 4430 is set. 	Specify the Port for connecting to the OpenVPN Server. Value Range: 1 ~ 65535.
Tunnel Scenario	<ol style="list-style-type: none"> 1. A Must filled setting 2. By default TUN is selected. 	Specify the type of Tunnel Scenario for connecting to the OpenVPN Server. It can be TUN for TUN tunnel scenario, or TAP for TAP tunnel scenario.
Authorization Mode	<ol style="list-style-type: none"> 1. A Must filled setting 2. By default TLS is selected. 	Specify the authorization mode for the OpenVPN Server. <ul style="list-style-type: none"> • TLS ->The OpenVPN will use TLS authorization mode, and the following items CA Cert., Server Cert. and DH PEM will be displayed. CA Cert. could be generated in Certificate. Refer to Object Definition > Certificate > Trusted Certificate. Server Cert. could be generated in Certificate. Refer to Object Definition > Certificate > My Certificate. • Static Key ->The OpenVPN will use static key (pre-shared) authorization mode, and the following items Local Endpoint IP Address, Remote Endpoint IP Address and Static Key will be displayed. Note: Static Key will be available only when TUN is chosen in Tunnel Scenario.
Local Endpoint IP Address	A Must filled setting	Specify the virtual Local Endpoint IP Address of this OpenVPN gateway. Value Range: The IP format is 10.8.0.x, the range of x is 1~254. Note: Local Endpoint IP Address will be available only when Static Key is chosen in Authorization Mode.
Remote Endpoint IP Address	A Must filled setting	Specify the virtual Remote Endpoint IP Address of the peer OpenVPN gateway. Value Range: The IP format is 10.8.0.x, the range of x is 1~254. Note: Remote Endpoint IP Address will be available only when Static Key is chosen in Authorization Mode.
Static Key	A Must filled setting	Specify the Static Key . Note: Static Key will be available only when Static Key is chosen in Authorization Mode.
Server Virtual IP	A Must filled setting	Specify the Server Virtual IP . Value Range: The IP format is 10.y.0.0, the range of y is 1~254. Note: Server Virtual IP will be available only when TLS is chosen in Authorization Mode.
DHCP-Proxy Mode	<ol style="list-style-type: none"> 1. A Must filled setting 2. The box is checked by default. 	Check the Enable box to activate the DHCP-Proxy Mode . Note: DHCP-Proxy Mode will be available only when TAP is chosen in Tunnel Device.
IP Pool	A Must filled setting	Specify the virtual IP pool setting for the OpenVPN server. You have to specify the Starting Address and Ending Address as the IP address pool for the OpenVPN clients.

5G NR M2M Gateway

		Note: IP Pool will be available only when TAP is chosen in Tunnel Device, and DHCP-Proxy Mode is unchecked (disabled).
Gateway	A Must filled setting	Specify the Gateway setting for the OpenVPN server. It will be assigned to the connected OpenVPN clients. Note: Gateway will be available only when TAP is chosen in Tunnel Device, and DHCP-Proxy Mode is unchecked (disabled).
Netmask	By default - select one - is selected.	Specify the Netmask setting for the OpenVPN server. It will be assigned to the connected OpenVPN clients. Value Range: 255.255.255.0/24 (only support class C) Note_1: Netmask will be available when TAP is chosen in Tunnel Device, and DHCP-Proxy Mode is unchecked (disabled). Note_2: Netmask will also be available when TUN is chosen in Tunnel Device.
Redirect Default Gateway	1. An Optional setting. 2. The box is unchecked by default.	Check the Enable box to activate the Redirect Default Gateway function.
Encryption Cipher	1. A Must filled setting. 2. By default Blowfish is selected.	Specify the Encryption Cipher from the dropdown list. It can be Blowfish/AES-256/AES-192/AES-128/None .
Hash Algorithm	By default SHA-1 is selected.	Specify the Hash Algorithm from the dropdown list. It can be SHA-1/MD5/MD4/SHA2-256/SHA2-512/None/Disable .
LZO Compression	By default Adaptive is selected.	Specify the LZO Compression scheme. It can be Adaptive/YES/NO/Default .
Multicast	1. An Optional setting. 2. The box is checked by default.	Check the Enable box to activate the Multicast function. Note: Multicast function is only available for TAP tunnel scenario.
Persis Key	1. An Optional setting. 2. The box is checked by default.	Check the Enable box to activate the Persis Key function.
Persis Tun	1. An Optional setting. 2. The box is checked by default.	Check the Enable box to activate the Persis Tun function.
Advanced Configuration	N/A	Click the Edit button to specify the Advanced Configuration setting for the OpenVPN server. If the button is clicked, Advanced Configuration will be displayed below.
Save	N/A	Click Save to save the settings.
Undo	N/A	Click X to cancel the changes and return to last page.

5G NR M2M Gateway

When **Advanced Configuration** is selected, an OpenVPN Server Advanced Configuration screen will appear.

OpenVPN Server Advanced Configuration	
Item	Setting
▶ TLS Cipher	None ▼
▶ TLS Auth. Key	<input type="text"/> (Optional)
▶ Client to Client	<input checked="" type="checkbox"/> Enable
▶ Duplicate CN	<input checked="" type="checkbox"/> Enable
▶ Tunnel MTU	1500
▶ Tunnel UDP Fragment	0
▶ Tunnel UDP MSS-Fix	<input type="checkbox"/> Enable
▶ CCD-Dir Default File	<input type="text"/>
▶ Client Connection Script	<input type="text"/>
▶ Additional Configuration	<input type="text"/>

OpenVPN Server Advanced Configuration		
Item	Value setting	Description
TLS Cipher	1. A Must filled setting. 2. TLS-RSA-WITH-AES128-SHA is selected by default	Specify the TLS Cipher from the dropdown list. It can be None / TLS-RSA-WITH-RC4-MD5 / TLS-RSA-WITH-AES128-SHA / TLS-RSA-WITH-AES256-SHA / TLS-DHE-DSS-AES128-SHA / TLS-DHE-DSS-AES256-SHA . Note: TLS Cipher will be available only when TLS is chosen in Authorization Mode.
TLS Auth. Key	1. An Optional setting. 2. String format: any text	Specify the TLS Auth. Key . Note: TLS Auth. Key will be available only when TLS is chosen in Authorization Mode.
Client to Client	The box is checked by default	Check the Enable box to enable the traffics among different OpenVPN Clients. Note: Client to Client will be available only when TLS is chosen in Authorization Mode
Duplicate CN	The box is checked by default	Check the Enable box to activate the Duplicate CN function. Note: Duplicate CN will be available only when TLS is chosen in Authorization Mode
Tunnel MTU	1. A Must filled setting 2. The value is 1500 by default	Specify the Tunnel MTU . Value Range: 0 ~ 1500.
Tunnel UDP Fragment	1. A Must filled setting 2. The value is 1500 by default	Specify the Tunnel UDP Fragment . By default, it is equal to Tunnel MTU . Value Range: 0 ~ 1500. Note: Tunnel UDP Fragment will be available only when UDP is chosen in

5G NR M2M Gateway

		Protocol.
Tunnel UDP MSS-Fix	<ol style="list-style-type: none">1. An Optional setting.2. The box is unchecked by default.	Check the Enable box to activate the Tunnel UDP MSS-Fix Function. Note: Tunnel UDP MSS-Fix will be available only when UDP is chosen in Protocol.
CCD-Dir Default File	<ol style="list-style-type: none">1. An Optional setting.2. String format: any text	Specify the CCD-Dir Default File . <i>Value Range:</i> 0 ~ 256 characters.
Client Connection Script	<ol style="list-style-type: none">1. An Optional setting.2. String format: any text	Specify the Client Connection Script . <i>Value Range:</i> 0 ~ 256 characters.
Additional Configuration	<ol style="list-style-type: none">1. An Optional setting.2. String format: any text	Specify the Additional Configuration . <i>Value Range:</i> 0 ~ 256 characters.

5G NR M2M Gateway

As an OpenVPN Client

If **Client** is selected, the configuration screen will be changed as below and an OpenVPN Client List screen appear.

Configuration	
Item	Setting
▶ OpenVPN	<input type="checkbox"/> Enable
▶ Server / Client	Client ▾
▶ OpenVPN Configuration file	<input type="checkbox"/> Enable <input type="button" value="Upgrade"/> Interface WAN-1 ▾

OpenVPN Configuration		
Item	Value setting	Description
OpenVPN	The box is unchecked by default	Check the Enable box to activate the OpenVPN function.
Server/Client	Server Configuration is selected by default.	When Server is selected, as the name indicated, server configuration will be displayed below for further setup. When Client is selected, you can specify the client settings in another client configuration window.
OpenVPN Configuration file	1. An Optional setting. 2. The box is unchecked by default.	Click the Enable box to activate the OpenVPN Client configuration via a pre-defined configuration file. You have to further specify the Interface to be applied, and click the Upgrade button to upload the configuration from a .ovpn file. If you enabled this function, you can't add any OpenVPN clients manually.

OpenVPN Client List														
ID	Client Name	Interface	Protocol	Port	Tunnel Scenario	Remote IP/FQDN	Remote Subnet	Redirect Internet Traffic	NAT	Authorization Mode	Encryption Cipher	Hash Algorithm	Enable	Actions

When **Add** button is applied, OpenVPN Client Configuration screen will appear. **OpenVPN Client Configuration** window let you specify the required parameters for an OpenVPN VPN client, such as "OpenVPN Client Name", "Interface", "Protocol", "Tunnel Scenario", "Remote IP/FQDN", "Remote Subnet", "Authorization Mode", "Encryption Cipher", "Hash Algorithm" and tunnel activation.

5G NR M2M Gateway

OpenVPN Client Configuration	
Item	Setting
▶ OpenVPN Client Name	OpenVPN Client #1
▶ Interface	WAN 1 ▼
▶ Protocol	TCP ▼ Port: 443
▶ Tunnel Scenario	TUN ▼
▶ Remote IP/FQDN	
▶ Remote Subnet	<input type="checkbox"/> Enable <input type="text"/> 255.255.255.0(/24) ▼
▶ Redirect Internet Traffic	<input type="checkbox"/> Enable
▶ NAT	<input checked="" type="checkbox"/> Enable
▶ Authorization Mode	TLS ▼ CA Cert.: ▼ Client Cert.: ▼ Client Key.: ▼ Please set the Certificate.
▶ Encryption Cipher	Blowfish ▼
▶ Hash Algorithm	SHA-1 ▼
▶ LZO Compression	Adaptive ▼
▶ Persist Key	<input checked="" type="checkbox"/> Enable
▶ Persist Tun	<input checked="" type="checkbox"/> Enable
▶ Advanced Configuration	<input type="button" value="Edit"/>
▶ Tunnel	<input type="checkbox"/> Enable

OpenVPN Client Configuration		
Item	Value setting	Description
OpenVPN Client Name	A Must filled setting	The OpenVPN Client Name will be used to identify the client in the tunnel list. <u>Value Range: 1 ~ 32 characters.</u>
Interface	1. A Must filled setting 2. By default WAN-1 is selected.	Define the physical interface to be used for this OpenVPN Client tunnel.
Protocol	1. A Must filled setting 2. By default TCP is selected.	Define the Protocol for the OpenVPN Client. <ul style="list-style-type: none"> • Select TCP ->The OpenVPN will use TCP protocol, and Port will be set as 443 automatically. • Select UDP -> The OpenVPN will use UDP protocol, and Port will be set as 1194 automatically.
Port	1. A Must filled setting 2. By default 443 is set.	Specify the Port for the OpenVPN Client to use. <u>Value Range: 1 ~ 65535.</u>
Tunnel Scenario	1. A Must filled setting 2. By default TUN is selected.	Specify the type of Tunnel Scenario for the OpenVPN Client to use. It can be TUN for TUN tunnel scenario, or TAP for TAP tunnel scenario.
Remote IP/FQDN	A Must filled setting	Specify the Remote IP/FQDN of the peer OpenVPN Server for this OpenVPN Client tunnel. Fill in the IP address or FQDN.
Remote Subnet	1. An Optional setting. 2. The box is unchecked by default.	Check the Enable box to activate remote subnet function, and specify Remote Subnet of the peer OpenVPN Server for this OpenVPN Client tunnel. Fill in the remote subnet address and remote subnet mask.
Redirect Internet Traffic	1. An Optional setting. 2. The box is unchecked by default.	Check the Enable box to activate the Redirect Internet Traffic function.
NAT	1. An Optional setting.	Check the Enable box to activate the NAT function.

5G NR M2M Gateway

	2. The box is checked by default.	
Authorization Mode	1. A Must filled setting 2. By default TLS is selected.	Specify the authorization mode for the OpenVPN Server. <ul style="list-style-type: none"> • TLS ->The OpenVPN will use TLS authorization mode, and the following items CA Cert., Client Cert. and Client Key will be displayed. CA Cert. could be selected in Trusted CA Certificate List. Refer to Object Definition > Certificate > Trusted Certificate. Client Cert. could be selected in Local Certificate List. Refer to Object Definition > Certificate > My Certificate. Client Key could be selected in Trusted Client key List. Refer to Object Definition > Certificate > Trusted Certificate. • Static Key ->The OpenVPN will use static key authorization mode, and the following items Local Endpoint IP Address, Remote Endpoint IP Address and Static Key will be displayed.
Local Endpoint IP Address	A Must filled setting	Specify the virtual Local Endpoint IP Address of this OpenVPN gateway. Value Range: The IP format is 10.8.0.x, the range of x is 1~254. Note: Local Endpoint IP Address will be available only when Static Key is chosen in Authorization Mode.
Remote Endpoint IP Address	A Must filled setting	Specify the virtual Remote Endpoint IP Address of the peer OpenVPN gateway. Value Range: The IP format is 10.8.0.x, the range of x is 1~254. Note: Remote Endpoint IP Address will be available only when Static Key is chosen in Authorization Mode.
Static Key	A Must filled setting	Specify the Static Key . Note: Static Key will be available only when Static Key is chosen in Authorization Mode.
Encryption Cipher	By default Blowfish is selected.	Specify the Encryption Cipher . It can be Blowfish/AES-256/AES-192/AES-128/None .
Hash Algorithm	By default SHA-1 is selected.	Specify the Hash Algorithm . It can be SHA-1/MD5/MD4/SHA2-256/SHA2-512/None/Disable .
LZO Compression	By default Adaptive is selected.	Specify the LZO Compression scheme. It can be Adaptive/YES/NO/Default .
Multicast	1. An Optional setting. 2. The box is checked by default.	Check the Enable box to activate the Multicast function. Note: Multicast function is only available for TAP tunnel scenario.
Persis Key	1. An Optional setting. 2. The box is checked by default.	Check the Enable box to activate the Persis Key function.
Persis Tun	1. An Optional setting. 2. The box is checked by default.	Check the Enable box to activate the Persis Tun function.
Advanced Configuration	N/A	Click the Edit button to specify the Advanced Configuration setting for the OpenVPN server. If the button is clicked, Advanced Configuration will be displayed below.
Tunnel	The box is unchecked by default	Check the Enable box to activate this OpenVPN tunnel.
Save	N/A	Click Save to save the settings.
Undo	N/A	Click X to cancel the changes and return to last page.

5G NR M2M Gateway

When **Advanced Configuration** is selected, an OpenVPN Client Advanced Configuration screen will appear.

OpenVPN Client Advanced Configuration	
Item	Setting
▶ TLS Cipher	None ▼
▶ TLS Auth. Key(Optional)	<input type="text"/> (Optional)
▶ User Name(Optional)	<input type="text"/> (Optional)
▶ Password(Optional)	<input type="text"/> (Optional)
▶ Bridge TAP to	VLAN 1 ▼
▶ Firewall Protection	<input type="checkbox"/> Enable
▶ Client IP Address	Dynamic IP ▼
▶ Tunnel MTU	1500
▶ Tunnel UDP Fragment	1500
▶ Tunnel UDP MSS-Fix	<input type="checkbox"/> Enable
▶ nsCertType Verification	<input type="checkbox"/> Enable
▶ TLS Renegotiation Time(seconds)	3600 (seconds)
▶ Connection Retry(seconds)	-1 (seconds)
▶ DNS	Automatically ▼
▶ Additional Configuration	<input type="text"/>

OpenVPN Advanced Client Configuration		
Item	Value setting	Description
TLS Cipher	1. A Must filled setting. 2. TLS-RSA-WITH-AES128-SHA is selected by default	Specify the TLS Cipher from the dropdown list. It can be None / TLS-RSA-WITH-RC4-MD5 / TLS-RSA-WITH-AES128-SHA / TLS-RSA-WITH-AES256-SHA / TLS-DHE-DSS-AES128-SHA / TLS-DHE-DSS-AES256-SHA . Note: TLS Cipher will be available only when TLS is chosen in Authorization Mode.
TLS Auth. Key	1. An Optional setting. 2. String format: any text	Specify the TLS Auth. Key for connecting to an OpenVPN server, if the server required it. Note: TLS Auth. Key will be available only when TLS is chosen in Authorization Mode.
User Name	An Optional setting.	Enter the User account for connecting to an OpenVPN server, if the server required it. Note: User Name will be available only when TLS is chosen in Authorization Mode.
Password	An Optional setting.	Enter the Password for connecting to an OpenVPN server, if the server required it. Note: User Name will be available only when TLS is chosen in Authorization Mode.
Bridge TAP to	By default VLAN 1 is selected	Specify the setting of “ Bridge TAP to ” to bridge the TAP interface to a certain local network interface or VLAN. Note: Bridge TAP to will be available only when TAP is chosen in Tunnel Scenario and NAT is unchecked.
Firewall Protection	The box is unchecked by default.	Check the box to activate the Firewall Protection function. Note: Firewall Protection will be available only when NAT is enabled.
Client IP Address	By default Dynamic IP is	Specify the virtual IP Address for the OpenVPN Client.

5G NR M2M Gateway

	selected	It can be Dynamic IP/Static IP .
Tunnel MTU	1.A Must filled setting 2.The value is 1500 by default	Specify the value of Tunnel MTU . Value Range: 0 ~ 1500.
Tunnel UDP Fragment	The value is 1500 by default	Specify the value of Tunnel UDP Fragment . Value Range: 0 ~ 1500. Note: Tunnel UDP Fragment will be available only when UDP is chosen in Protocol.
Tunnel UDP MSS-Fix	The box is unchecked by default.	Check the Enable box to activate the Tunnel UDP MSS-Fix function. Note: Tunnel UDP MSS-Fix will be available only when UDP is chosen in Protocol.
nsCerType Verification	The box is unchecked by default.	Check the Enable box to activate the nsCerType Verification function. Note: nsCerType Verification will be available only when TLS is chosen in Authorization Mode.
TLS Renegotiation Time (seconds)	The value is 3600 by default	Specify the time interval of TLS Renegotiation Time . Value Range: -1 ~ 86400.
Connection Retry(seconds)	The value is -1 by default	Specify the time interval of Connection Retry . The default -1 means that it is no need to execute connection retry. Value Range: -1 ~ 86400, and -1 means no retry is required.
DNS	By default Automatically is selected	Specify the setting of DNS . It can be Automatically/Manually .
Additional Configuration	An Optional setting.	Enter optional configuration string here. Up to 256 characters is allowable. Value Range: 0 ~ 256 characters.
Save	N/A	Click Save to save the settings.
Undo	N/A	Click X to cancel the changes and return to last page.

5G NR M2M Gateway

5.1.3 L2TP

Configuration	
Item	Setting
L2TP	<input type="checkbox"/> Enable
Client/Server	Server ▾

L2TP Server Configuration	
Item	Setting
L2TP Server	<input type="checkbox"/> Enable
Interface	All WANs ▾
L2TP over IPsec	<input type="checkbox"/> Enable Preshared Key <input type="text"/> (Min. 8 characters)
Server Virtual IP	<input type="text" value="192.168.10.1"/>
IP Pool Starting Address	<input type="text" value="10"/>
IP Pool Ending Address	<input type="text" value="17"/>
Authentication Protocol	<input type="checkbox"/> PAP <input type="checkbox"/> CHAP <input type="checkbox"/> MS-CHAP <input type="checkbox"/> MS-CHAP v2
MPPE Encryption	<input type="checkbox"/> Enable <input type="text" value="40 bits"/> ▾
Service Port	<input type="text" value="1701"/>

L2TP Server Status <input type="button" value="Refresh"/>				
User Name	Remote IP	Remote Virtual IP	Remote Call ID	Actions
No connection from remote				

User Account List <input type="button" value="Add"/> <input type="button" value="Delete"/>				
ID	User Name	Password	Enable	Actions

Layer 2 Tunneling Protocol (L2TP) is a tunneling protocol used to support virtual private networks (VPNs) or as part of the delivery of services by ISPs. It does not provide any encryption or confidentiality by itself. Rather, it relies on an encryption protocol that it passes within the tunnel to provide privacy. This Gateway can behave as a L2TP server and a L2TP client both at the same time.

L2TP Server: It must have a static IP or a FQDN for clients to create L2TP tunnels. It also maintains “User Account list” (user name/ password) for client login authentication; There is a virtual IP pool to assign virtual IP to each connected L2TP client.

L2TP Client: It can be mobile users or gateways in remote offices with dynamic IP. To setup tunnel, it should get “user name”, “password” and server’s global IP. In addition, it is required to identify the operation mode for each tunnel as main connection, failover for another tunnel, or load balance tunnel to increase overall bandwidth. It needs to decide “Default Gateway” or “Remote Subnet” for packet flow. Moreover, you can also define what kind of traffics will pass through the L2TP tunnel in the “Default Gateway / Remote Subnet” parameter.

5G NR M2M Gateway

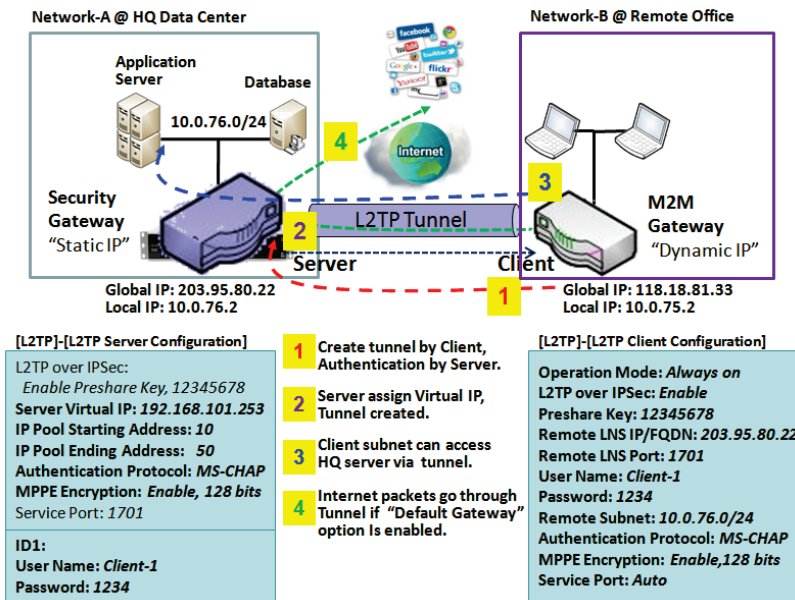

Besides, for the L2TP client peer, a Remote Subnet item is required. It is for the Intranet of L2TP server peer. So, at L2TP client peer, the packets whose destination is in the dedicated subnet will be transferred via the L2TP tunnel. Others will be transferred based on current routing policy of the gateway at L2TP client peer. But, if you entered 0.0.0.0/0 in the Remote Subnet field, it will be treated as a "Default Gateway" setting for the L2TP client peer, all packets, including the Internet accessing of L2TP client peer, will go through the established L2TP tunnel. That means the remote L2TP server peer controls the flow of any packets from the L2TP client peer. Certainly, those packets come through the L2TP tunnel.

5G NR M2M Gateway

L2TP Setting

Go to **Security > VPN > L2TP** tab.

The L2TP setting allows user to create and configure L2TP tunnels.

Enable L2TP

Configuration	
Item	Setting
L2TP	<input type="checkbox"/> Enable
Client/Server	Server ▾

Enable L2TP Window		
Item	Value setting	Description
L2TP	Unchecked by default	Click the Enable box to activate L2TP function.
Client/Server	A Must filled setting	Specify the role of L2TP. Select Server or Client role your gateway will take. Below are the configuration windows for L2TP Server and for L2TP Client.
Save	N/A	Click Save button to save the settings

As a L2TP Server

When select **Server** in Client/Server, the L2TP server Configuration will appear.

L2TP Server Configuration	
Item	Setting
L2TP Server	<input type="checkbox"/> Enable
Interface	All WANs ▾
L2TP over IPsec	<input type="checkbox"/> Enable Preshared Key <input type="text"/> (Min. 2 characters)
Server Virtual IP	<input type="text"/> 192.168.10.1
IP Pool Starting Address	<input type="text"/> 10
IP Pool Ending Address	<input type="text"/> 17
Authentication Protocol	<input type="checkbox"/> PAP <input type="checkbox"/> CHAP <input type="checkbox"/> MS-CHAP <input type="checkbox"/> MS-CHAP v2
MPPE Encryption	<input type="checkbox"/> Enable <input type="text"/> 40 bits ▾
Service Port	<input type="text"/> 1701

L2TP Server Configuration		
Item	Value setting	Description

5G NR M2M Gateway

L2TP Server	The box is unchecked by default	When click the Enable box It will active L2TP server
Interface	1. A Must fill setting 2. All WANs is selected by default	Select the interface on which L2TP tunnel is to be established. It can be the available WAN interfaces.
L2TP over IPsec	The box is unchecked by default	When click the Enable box. It will enable L2TP over IPsec and need to fill in the Pre-shared Key (2~31 characters).
Server Virtual IP	A Must filled setting	Specify the L2TP server Virtual IP It will set as this L2TP server local virtual IP
IP Pool Starting Address	1. A Must filled setting 2. 10 is set by default.	Specify the L2TP server starting IP of virtual IP pool It will set as the starting IP which assign to L2TP client Value Range: 1 ~ 254.
IP Pool Ending Address	1. A Must filled setting 2. 17 is set by default.	Specify the L2TP server ending IP of virtual IP pool It will set as the ending IP which assign to L2TP client Value Range: >= Starting Address, and < (Starting Address + 8) or 254.
Authentication Protocol	A Must filled setting	Select single or multiple Authentication Protocols for the L2TP server with which to authenticate L2TP clients. Available authentication protocols are PAP / CHAP / MS-CHAP / MS-CHAP v2.
MPPE Encryption	A Must filled setting	Specify whether to support MPPE Protocol. Click the Enable box to enable MPPE and from dropdown box to select 40 bits / 56 bits / 128 bits. Note: when MPPE Encryption is enabled, the Authentication Protocol PAP / CHAP options will not be available.
Service Port	A Must filled setting	Specify the Service Port which L2TP server use. Value Range: 1 ~ 65535.
Save	N/A	Click the Save button to save the configuration.
Undo	N/A	Click the Undo button to recovery the configuration.

L2TP Server Status Refresh				
User Name	Remote IP	Remote Virtual IP	Remote Call ID	Actions
No connection from remote				

L2TP Server Status		
Item	Value setting	Description
L2TP Server Status	N/A	It displays the User Name, Remote IP, Remote Virtual IP, and Remote Call ID of the connected L2TP clients. Click the Refresh button to renew the L2TP client information.

User Account List Add Delete				
ID	User Name	Password	Enable	Actions
User Account Configuration Save				
User Name		Password		Account
<input type="text"/>		<input type="text"/>		<input type="checkbox"/> Enable
Save				

5G NR M2M Gateway

User Account List Window		
Item	Value setting	Description
User Account List	Max.of 10 user accounts	<p>This is the L2TP authentication user account entry. You can create and add accounts for remote clients to establish L2TP VPN connection to the gateway device.</p> <p>Click Add button to add user account. Enter User name and password. Then check the enable box to enable the user.</p> <p>Click Save button to save new user account.</p> <p>The selected user account can permanently be deleted by clicking the Delete button.</p> <p><u>Value Range:</u> 1 ~ 32 characters.</p>

5G NR M2M Gateway

As a L2TP Client

When select Client in Client/Server, a series L2TP Client Configuration will appear.

L2TP Client Configuration	
Item	Setting
L2TP Client	<input type="checkbox"/> Enable

L2TP Client Configuration		
Item Setting	Value setting	Description
L2TP Client	The box is unchecked by default	Check the Enable box to enable L2TP client role of the gateway.
Save	N/A	Click Save button to save the settings.
Undo	N/A	Click Undo button to cancel the settings.

Create/Edit L2TP Client

L2TP Client List & Status								
ID	Tunnel Name	Interface	Virtual IP	Remote IP/FQDN	Remote Subnet	Status	Enable	Actions
1	L2TP #1	WAN 1	0.0.0.0	192.168.127.72			<input type="checkbox"/>	<input type="button" value="Edit"/> <input type="checkbox"/> Select

When **Add/Edit** button is applied, a series of configuration screen will appear. You can add up to 8 L2TP Clients.

L2TP Client Configuration	
Item	Setting
Tunnel Name	<input type="text" value="L2TP #1"/>
Interface	<input type="text" value="WAN-1"/>
L2TP over IPsec	<input type="checkbox"/> Enable Preshared Key <input type="text"/> (Min. 2 characters)
Remote LNS IP/FQDN	<input type="text"/>
MTU	<input type="text" value="1500"/>
Remote LNS Port	<input type="text" value="1701"/>
User Name	<input type="text"/>
Password	<input type="text"/>
Tunneling Password (Optional)	<input type="text"/>
Remote Subnet	<input type="text"/>
Authentication Protocol	<input type="checkbox"/> PAP <input type="checkbox"/> CHAP <input type="checkbox"/> MS-CHAP <input type="checkbox"/> MS-CHAP v2
MPPE Encryption	<input type="checkbox"/> Enable
NAT before Tunneling	<input type="checkbox"/> Enable
LCP Echo Type	<input type="text" value="Auto"/> Interval <input type="text" value="30"/> seconds Max. Failure Time <input type="text" value="6"/> times
Service Port	<input type="text" value="Auto"/> <input type="text" value="0"/>
Tunnel	<input type="checkbox"/> Enable

5G NR M2M Gateway

L2TP Client Configuration		
Item Setting	Value setting	Description
Tunnel Name	A Must filled setting	Enter a tunnel name. Enter a name that is easy for you to identify. Value Range: 1 ~ 32 characters.
Interface	A Must filled setting	Define the selected interface to be the used for this L2TP tunnel (WAN-1 is available only when WAN-1 interface is enabled) The same applies to other WAN interfaces (e.g. WAN-2).
L2TP over IPsec	The box is unchecked by default	When click the Enable box. It will enable L2TP over IPsec and need to fill in the Pre-shared Key (2~31 characters).
Remote LNS IP/FQDN	A Must filled setting	Enter the public IP address or the FQDN of the L2TP server.
MTU	1.A Must filled setting 2.The value is 1500 by default	Specify the MTU . Value Range: 0 ~ 1500.
Remote LNS Port	1. A Must filled setting 2. 1701 is set by default	Enter the Remote LNS Port for this L2TP tunnel. Value Range: 1 ~ 65535.
User Name	A Must filled setting	Enter the User Name for this L2TP tunnel to be authenticated when connect to L2TP server. Value Range: 1 ~ 32 characters.
Password	A Must filled setting	Enter the Password for this L2TP tunnel to be authenticated when connect to L2TP server.
Tunneling Password(Optional)	An Optional filled setting	Enter the Tunneling Password for this L2TP tunnel to authenticate.
Remote Subnet	A Must filled setting	Specify the remote subnet for this L2TP tunnel to reach L2TP server. The Remote Subnet format must be IP address/netmask (e.g. 10.0.0.2/24). It is for the Intranet of L2TP VPN server. So, at L2TP client peer, the packets whose destination is in the dedicated subnet will be transferred via the L2TP VPN tunnel. Others will be transferred based on current routing policy of the security gateway at L2TP client peer. If you entered 0.0.0.0/0 in the Remote Subnet field, it will be treated as a default gateway setting for the L2TP client peer, all packets, including the Internet accessing of L2TP Client peer, will go through the established L2TP VPN tunnel. That means the remote L2TP VPN server controls the flow of any packets from the L2TP client peer. Certainly, those packets come through the L2TP VPN tunnel.
Authentication Protocol	1. A Must filled setting 2. Unchecked by default	Specify one ore multiple Authentication Protocol for this L2TP tunnel. Available authentication methods are PAP / CHAP / MS-CHAP / MS-CHAP v2 .
MPPE Encryption	1. Unchecked by default 2. an optional setting	Specify whether L2TP server supports MPPE Protocol . Click the Enable box to enable MPPE. Note: when MPPE Encryption is enabled, the Authentication Protocol PAP / CHAP options will not be available.
NAT before	1. A Must filled	Specify whether NAT is required or not for this L2TP tunnel.

5G NR M2M Gateway

Tunneling	setting 2. Unchecked by default	
LCP Echo Type	1. Auto is set by default	Specify the LCP Echo Type for this L2TP tunnel. It can be Auto , User-defined , or Disable . Auto : the system sets the Interval and Max. Failure Time. User-defined : enter the Interval and Max. Failure Time. The default value for Interval is 30 seconds, and Maximum Failure Times is 6 Times. Disable : disable the LCP Echo. Value Range : 1 ~ 99999 for Interval Time, 1~999 for Failure Time.
Service Port	A Must filled setting	Specify the Service Port for this L2TP tunnel to use. It can be Auto , (1701) for Cisco , or User-defined . Auto : The system determines the service port. 1701 (for Cisco) : The system use port 1701 for connecting with CISCO L2TP Server. User-defined : Enter the service port. The default value is 0. Value Range : 0 ~ 65535.
Tunnel	Unchecked by default	Check the Enable box to enable this L2TP tunnel.
Save	N/A	Click Save button to save the settings.
Undo	N/A	Click X button to cancel the settings and back to last page.

5G NR M2M Gateway

5.1.4 PPTP

Configuration	
Item	Setting
PPTP	<input type="checkbox"/> Enable
Client/Server	Server ▾

PPTP Server Configuration	
Item	Setting
PPTP Server	<input type="checkbox"/> Enable
Interface	All WANs ▾
Server Virtual IP	192.168.0.1
IP Pool Starting Address	10
IP Pool Ending Address	17
Authentication Protocol	<input type="checkbox"/> PAP <input type="checkbox"/> CHAP <input type="checkbox"/> MS-CHAP <input type="checkbox"/> MS-CHAP v2
MPPE Encryption	<input type="checkbox"/> Enable 40 bits ▾

PPTP Server Status Refresh				
User Name	Remote IP	Remote Virtual IP	Remote Call ID	Actions
No connection from remote				

User Account List Add Delete				
ID	User Name	Password	Enable	Actions

Point-to-Point Tunneling Protocol (PPTP) is a method for implementing virtual private networks. PPTP uses a control channel over TCP and a GRE tunnel operating to encapsulate PPP packets. It is a client-server based technology. There are various levels of authentication and encryption for PPTP tunneling, usually natively as standard features of the Windows PPTP stack. The security gateway can play either "PPTP Server" role or "PPTP Client" role for a PPTP VPN tunnel, or both at the same time for different tunnels. PPTP tunnel process is nearly the same as L2TP.

PPTP Server: It must have a static IP or a FQDN for clients to create PPTP tunnels. It also maintains "User Account list" (user name / password) for client login authentication; There is a virtual IP pool to assign virtual IP to each connected PPTP client. u

PPTP Client: It can be mobile users or gateways in remote offices with dynamic IP. To setup tunnel, it should get "user name", "password" and server's global IP. In addition, it is required to identify the operation mode for each tunnel as main connection, failover for another tunnel, or load balance tunnel to increase overall bandwidth. It needs to decide "Default Gateway" or "Remote Subnet" for packet flow. Moreover, you can also define what kind of traffics will pass through the PPTP tunnel in the "Default Gateway / Remote Subnet" parameter.

5G NR M2M Gateway

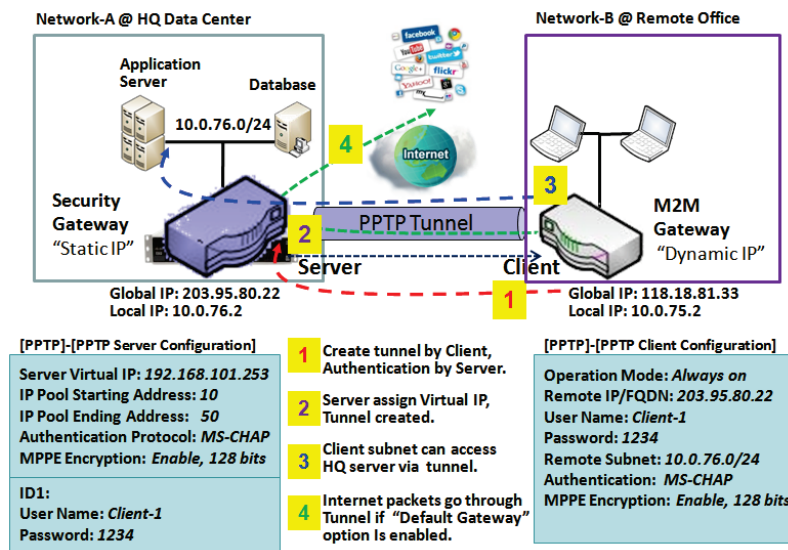

Besides, for the PPTP client peer, a Remote Subnet item is required. It is for the Intranet of PPTP server peer. So, at PPTP client peer, the packets whose destination is in the dedicated subnet will be transferred via the PPTP tunnel. Others will be transferred based on current routing policy of the gateway at PPTP client peer. But, if you entered 0.0.0.0/0 in the Remote Subnet field, it will be treated as a "Default Gateway" setting for the PPTP client peer, all packets, including the Internet accessing of PPTP client peer, will go through the established PPTP tunnel. That means the remote PPTP server peer controls the flow of any packets from the PPTP client peer.

Certainly, those packets come through the PPTP tunnel.

5G NR M2M Gateway

PPTP Setting

Go to **Security > VPN > PPTP** tab.

The PPTP setting allows user to create and configure PPTP tunnels.

Enable PPTP

Configuration	
Item	Setting
PPTP	<input type="checkbox"/> Enable
Client/Server	Server ▾

Enable PPTP Window		
Item	Value setting	Description
PPTP	Unchecked by default	Click the Enable box to activate PPTP function.
Client/Server	A Must fill setting	Specify the role of PPTP. Select Server or Client role your gateway will take. Below are the configuration windows for PPTP Server and for Client.
Save	N/A	Click Save button to save the settings.

As a PPTP Server

The gateway supports up to a maximum of 10 PPTP user accounts.

When **Server** in the Client/Server field is selected, the PPTP server configuration window will appear.

PPTP Server Configuration	
Item	Setting
PPTP Server	<input type="checkbox"/> Enable
Interface	WAN1 ▾
Server Virtual IP	192.168.12.1
IP Pool Starting Address	10
IP Pool Ending Address	17
Authentication Protocol	<input type="checkbox"/> PAP <input type="checkbox"/> CHAP <input checked="" type="checkbox"/> MS-CHAP <input checked="" type="checkbox"/> MS-CHAP v2
MPPE Encryption	<input checked="" type="checkbox"/> Enable 40 bits ▾

5G NR M2M Gateway

PPTP Server Configuration Window		
Item	Value setting	Description
PPTP Server	Unchecked by default	Check the Enable box to enable PPTP server role of the gateway.
Interface	1. A Must fill setting 2. All WANs is selected by default	Select the interface on which PPTP tunnel is to be established. It can be the available WAN interfaces.
Server Virtual IP	1. A Must fill setting 2. Default is 192.168.0.1	Specify the PPTP server Virtual IP address. The virtual IP address will serve as the virtual DHCP server for the PPTP clients. Clients will be assigned a virtual IP address from it after the PPTP tunnel has been established.
IP Pool Starting Address	1. A Must fill setting 2. Default is 10	This is the PPTP server's Virtual IP DHCP server. User can specify the first IP address for the subnet from which the PPTP client's IP address will be assigned. Value Range: 1 ~ 254.
IP Pool Ending Address	1. A Must fill setting 2. Default is 17	This is the PPTP server's Virtual IP DHCP server. User can specify the last IP address for the subnet from which the PPTP client's IP address will be assigned. Value Range: >= Starting Address, and < (Starting Address + 8) or 254.
Authentication Protocol	1. A Must fill setting 2. Unchecked by default	Select single or multiple Authentication Protocols for the PPTP server with which to authenticate PPTP clients. Available authentication protocols are PAP / CHAP / MS-CHAP / MS-CHAP v2.
MPPE Encryption	1. A Must fill setting 2. Unchecked by default	Specify whether to support MPPE Protocol. Click the Enable box to enable MPPE and from dropdown box to select 40 bits / 56 bits / 128 bits. Note: when MPPE Encryption is enabled, the Authentication Protocol PAP / CHAP options will not be available.
Save	N/A	Click Save button to save the settings.
Undo	N/A	Click Undo button to cancel the settings.

PPTP Server Status Refresh				
User Name	Remote IP	Remote Virtual IP	Remote Call ID	Actions
No connection from remote				

PPTP Server Status Window		
Item	Value setting	Description
PPTP Server Status	N/A	It displays the User Name, Remote IP, Remote Virtual IP, and Remote Call ID of the connected PPTP clients. Click the Refresh button to renew the PPTP client information.

User Account List Add Delete				
ID	User Name	Password	Enable	Actions
User Account Configuration Save				
User Name	Password		Account	
<input type="text"/>	<input type="text"/>		<input type="checkbox"/> Enable	
Save				

User Account List Window

5G NR M2M Gateway

Item	Value setting	Description
User Account List	Max.of 10 user accounts	<p>This is the PPTP authentication user account entry. You can create and add accounts for remote clients to establish PPTP VPN connection to the gateway device.</p> <p>Click Add button to add user account. Enter User name and password. Then check the enable box to enable the user.</p> <p>Click Save button to save new user account.</p> <p>The selected user account can permanently be deleted by clicking the Delete button.</p> <p>Value Range: 1 ~ 32 characters.</p>

As a PPTP Client

When select Client in Client/Server, a series PPTP Client Configuration will appear.

PPTP Client Configuration	
Item	Setting
▶ PPTP Client	<input type="checkbox"/> Enable

PPTP Client Configuration		
Item	Value setting	Description
PPTP Client	Unchecked by default	Check the Enable box to enable PPTP client role of the gateway.
Save	N/A	Click Save button to save the settings.
Undo	N/A	Click Undo button to cancel the settings.

Create/Edit PPTP Client

PPTP Client List & Status								
ID	Tunnel Name	Interface	Virtual IP	Remote IP/FQDN	Remote Subnet	Status	Enable	Actions
<div style="display: flex; justify-content: space-between; align-items: center;"> Add Delete Refresh </div>								

When **Add/Edit** button is applied, a series PPTP Client Configuration will appear.

5G NR M2M Gateway

PPTP Client Configuration	
Item	Setting
▶ Tunnel Name	PPTP #1
▶ Interface	WAN1 ▼
▶ Remote IP/FQDN	
▶ MTU	1500
▶ User Name	
▶ Password	
▶ Remote Subnet	
▶ Authentication Protocol	<input type="checkbox"/> PAP <input type="checkbox"/> CHAP <input type="checkbox"/> MS-CHAP <input type="checkbox"/> MS-CHAP v2
▶ MPPE Encryption	<input type="checkbox"/> Enable
▶ NAT before Tunneling	<input type="checkbox"/> Enable
▶ LCP Echo Type	Auto ▼ Interval 30 seconds Max. Failure Time 6 times
▶ Tunnel	<input type="checkbox"/> Enable

PPTP Client Configuration Window		
Item	Value setting	Description
Tunnel Name	A Must fill setting	Enter a tunnel name. Enter a name that is easy for you to identify. Value Range: 1 ~ 32 characters.
Interface	1. A Must fill setting 2. WAN1 is selected by default	Define the selected interface to be the used for this PPTP tunnel (WAN-1 is available only when WAN-1 interface is enabled) The same applies to other WAN interfaces (e.g. WAN-2).
Remote IP/FQDN	1. A Must fill setting. 2. Format can be a ipv4 address or FQDN	Enter the public IP address or the FQDN of the PPTP server.
MTU	1.A Must filled setting 2.The value is 1500 by default	Specify the MTU . Value Range: 0 ~ 1500.
User Name	A Must fill setting	Enter the User Name for this PPTP tunnel to be authenticated when connect to PPTP server. Value Range: 1 ~ 32 characters.
Password	A Must fill setting	Enter the Password for this PPTP tunnel to be authenticated when connect to PPTP server.
Remote Subnet	A Must fill setting	Specify the remote subnet for this PPTP tunnel to reach PPTP server. The Remote Subnet format must be IP address/netmask (e.g. 10.0.0.2/24). It is for the Intranet of PPTP VPN server. So, at PPTP client peer, the packets whose destination is in the dedicated subnet will be transferred via the PPTP VPN tunnel. Others will be transferred based on current routing policy of the security gateway at PPTP client peer. If you entered 0.0.0.0/0 in the Remote Subnet field, it will be treated as a default gateway setting for the PPTP client peer, all packets, including the Internet accessing of PPTP Client peer, will go through the established PPTP VPN tunnel. That means the remote PPTP VPN server controls the flow of any

5G NR M2M Gateway

		packets from the PPTP client peer. Certainly, those packets come through the PPTP VPN tunnel.
Authentication Protocol	1. A Must fill setting 2. Unchecked by default	Specify one ore multiple Authentication Protocol for this PPTP tunnel. Available authentication methods are PAP / CHAP / MS-CHAP / MS-CHAP v2 .
MPPE Encryption	1. Unchecked by default 2. an optional setting	Specify whether PPTP server supports MPPE Protocol . Click the Enable box to enable MPPE. Note: when MPPE Encryption is enabled, the Authentication Protocol PAP / CHAP options will not be available.
NAT before Tunneling	1. A Must filled setting 2. Unchecked by default	Specify whether NAT is required or not for this PPTP tunnel.
LCP Echo Type	Auto is set by default	Specify the LCP Echo Type for this PPTP tunnel. It can be Auto, User-defined, or Disable . Auto: the system sets the Interval and Max. Failure Time. User-defined: enter the Interval and Max. Failure Time. The default value for Interval is 30 seconds, and Maximum Failure Times is 6 Times. Disable: disable the LCP Echo. Value Range: 1 ~ 99999 for Interval Time, 1~999 for Failure Time.
Tunnel	Unchecked by default	Check the Enable box to enable this PPTP tunnel.
Save	N/A	Click Save button to save the settings.
Undo	N/A	Click X button to cancel the settings and back to last page.

5G NR M2M Gateway

5.1.5 GRE

Generic Routing Encapsulation (GRE) is a tunneling protocol developed by Cisco Systems that encapsulates a wide variety of network layer protocols inside virtual point-to-point links over an Internet Protocol internet network.

Deploy a M2M gateway for remote site and establish a virtual private network with control center by using GRE tunneling. So, all client hosts behind M2M gateway can make data communication with server hosts behind control center gateway.

GRE Tunneling is similar to IPsec Tunneling, client requesting the tunnel establishment with the server. Both the client and the server must have a Static IP or a FQDN. Any peer gateway can be worked as either a client or a server, even using the same set of configuration rule.

GRE Tunnel Scenario

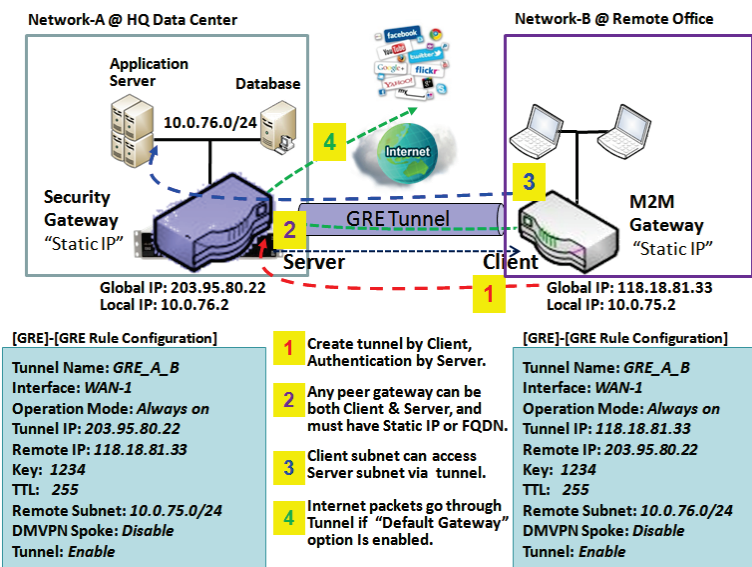

To setup a GRE tunnel, each peer needs to setup its global IP as tunnel IP and fill in the other's global IP as remote IP.

Besides, each peer must further specify the Remote Subnet item. It is for the Intranet of GRE server peer. So, at GRE client peer, the packets whose destination is in the dedicated subnet will be transferred via the GRE tunnel. Others will be transferred based on current routing policy of the gateway at GRE client peer. But, if you entered 0.0.0.0/0 in the Remote Subnet field, it will be treated as a "Default Gateway" setting for the GRE client peer, all packets, including the Internet accessing of GRE client peer, will go through the established GRE tunnel. That means

the remote GRE server peer controls the flow of any packets from the GRE client peer. Certainly, those packets come through the GRE tunnel.

If the GRE server supports DMVPN Hub function, like Cisco router as the VPN concentrator, the GRE client can active the DMVPN spoke function here since it is implemented by GRE over IPsec tunneling.

5G NR M2M Gateway

GRE Setting

Go to **Security > VPN > GRE** tab.

The GRE setting allows user to create and configure GRE tunnels.

Enable GRE

Configuration	
Item	Setting
GRE Tunnel	<input type="checkbox"/> Enable
Max. Concurrent GRE Tunnels	32

Enable GRE Window		
Item	Value setting	Description
GRE Tunnel	Unchecked by default	Click the Enable box to enable GRE function.
Max. Concurrent GRE Tunnels	Depends on Product specification.	The specified value will limit the maximum number of simultaneous GRE tunnel connection. The default value can be different for the purchased model.
Save	N/A	Click Save button to save the settings
Undo	N/A	Click Undo button to cancel the settings

Create/Edit GRE tunnel

GRE Tunnel List										
ID	Tunnel Name	Interface	Tunnel IP	Remote IP	MTU	Key	TTL	Remote Subnet	Enable	Actions

When **Add/Edit** button is applied, a GRE Rule Configuration screen will appear.

5G NR M2M Gateway

GRE Rule Configuration	
Item	Setting
▶ Tunnel Name	<input type="text" value="GRE #1"/>
▶ Interface	<input type="text" value="WAN1"/>
▶ Tunnel IP	IP: <input type="text"/> MASK: <input type="text" value="-- select one --"/> (Optional)
▶ Remote IP	<input type="text"/>
▶ MTU	<input type="text"/>
▶ Key	<input type="text"/> (Optional)
▶ TTL	<input type="text"/>
▶ Remote Subnet	<input type="text"/>
▶ Tunnel	<input type="checkbox"/> Enable

GRE Rule Configuration Window		
Item	Value setting	Description
Tunnel Name	A Must fill setting	Enter a tunnel name. Enter a name that is easy for you to identify. Value Range: 1 ~ 9 characters.
Interface	1. A Must fill setting 2. WAN 1 is selected by default	Select the interface on which GRE tunnel is to be established. It can be the available WAN and LAN interfaces.
Tunnel IP	An Optional setting	Enter the Tunnel IP address and corresponding subnet mask.
Remote IP	A Must fill setting	Enter the Remote IP address of remote GRE tunnel gateway. Normally this is the public IP address of the remote GRE gateway.
MTU	1. A Must filled setting 2. Auto (value zero or blank) is set by default	MTU refers to Maximum Transmission Unit. It specifies the largest packet size permitted for Internet transmission. When set to Auto (value '0' or blank), the router selects the best MTU for best Internet connection performance. Value Range: 0 ~ 1500.
Key	An Optional setting	Enter the Key for the GRE connection. Value Range: 0 ~ 9999999999.
TTL	1. A Must fill setting 2. 1 to 255 range	Specify TTL hop-count value for this GRE tunnel. Value Range: 1 ~ 255.
Remote Subnet	A Must fill setting	Specify the remote subnet for this GRE tunnel. The Remote Subnet format must be IP address/netmask (e.g. 10.0.0.2/24). It is for the Intranet of GRE server peer. So, at GRE client peer, the packets whose destination is in the dedicated subnet will be transferred via the GRE tunnel. Others will be transferred based on current routing policy of the security gateway at GRE client peer. If you entered 0.0.0.0/0 in the Remote Subnet field, it will be treated as a default gateway setting for the GRE client peer, all packets, including the Internet accessing of GRE client peer, will go through the established GRE

5G NR M2M Gateway

		tunnel. That means the remote GRE server peer controls the flow of any packets from the GRE client peer. Certainly, those packets come through the GRE tunnel.
Tunnel	Unchecked by default	Check Enable box to enable this GRE tunnel.
Save	N/A	Click Save button to save the settings.
Undo	N/A	Click X button to cancel the settings and back to last page.

5G NR M2M Gateway

5.2 Firewall

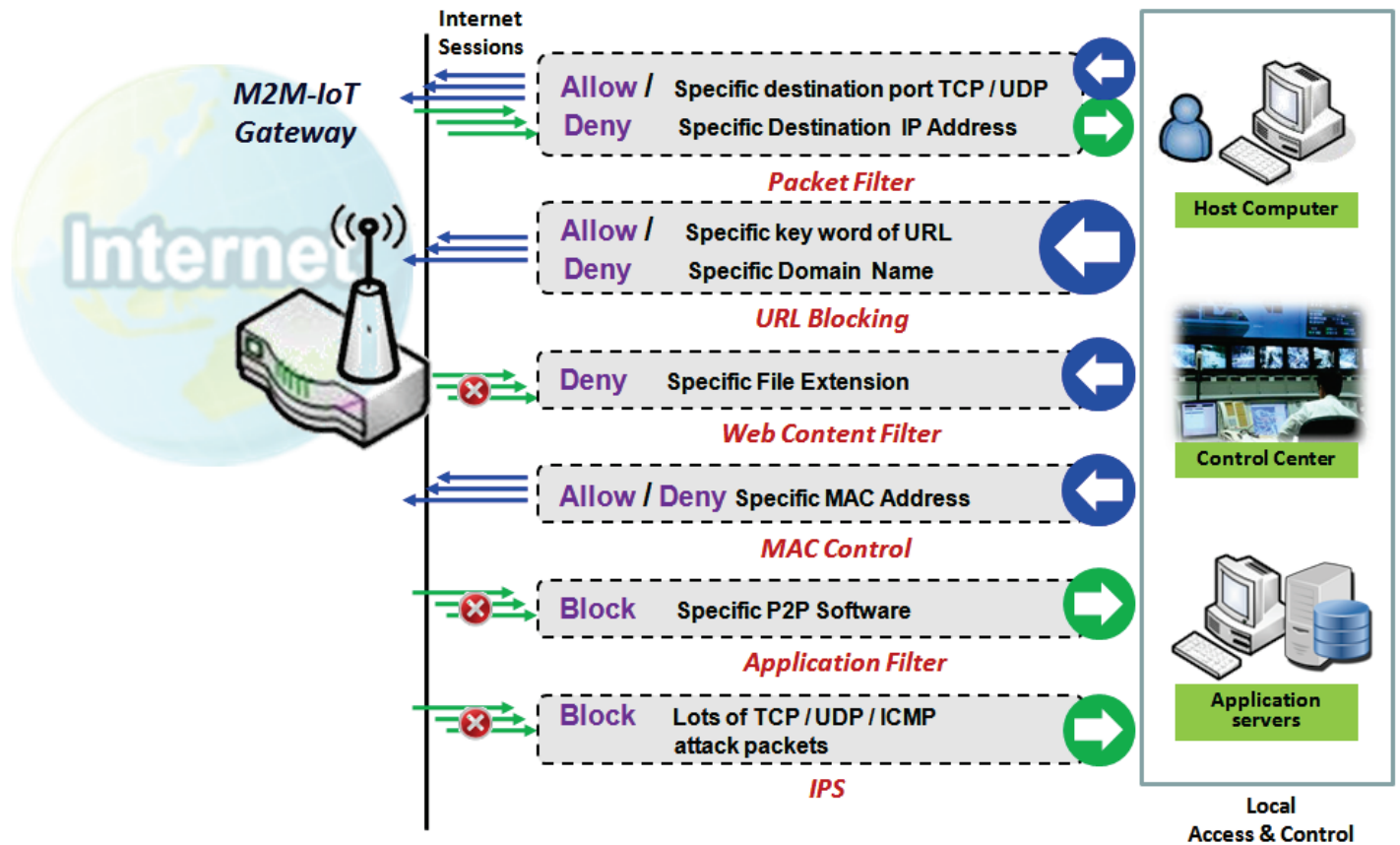

The firewall functions include Packet Filter, URL Blocking, Content Filter, MAC Control, Application Filter, IPS and some firewall options. The supported function can be different for the purchased gateway.

5.2.1 Packet Filter

Configuration												
Item	Setting											
Packet Filters	<input checked="" type="checkbox"/> Enable											
Black List / White List	Deny those match the following rules. ▼											
Log Alert	<input type="checkbox"/> Log Alert											
Packet Filter List												
<input type="button" value="Add"/> <input type="button" value="Delete"/>												
ID	Rule Name	From Interface	To Interface	Source IP	Destination IP	Source MAC	Protocol	Source Port	Destination Port	Time Schedule	Enable	Actions

"Packet Filter" function can let you define some filtering rules for incoming and outgoing packets. So the

5G NR M2M Gateway

gateway can control what packets are allowed or blocked to pass through it. A packet filter rule should indicate from and to which interface the packet enters and leaves the gateway, the source and destination IP addresses, and destination service port type and port number. In addition, the time schedule to which the rule will be active.

Packet Filter with White List Scenario

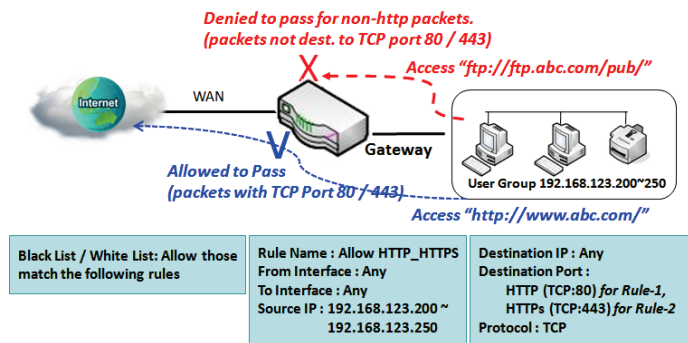

As shown in the diagram, specify "Packet Filter Rule List" as white list (*Allow those match the following rules*) and define the rules. Rule-1 is to allow HTTP packets to pass, and Rule-2 is to allow HTTPS packets to pass.

Under such configuration, the gateway will allow only HTTP and HTTPS packets, issued from the IP range 192.168.123.200 to 250, which are targeted to TCP port 80 or 443 to pass the WAN interface.

Packet Filter Setting

Go to **Security > Firewall > Packet Filter** Tab.

The packet filter setting allows user to create and customize packet filter policies to allow or reject specific inbound/outbound packets through the router based on their office setting.

Enable Packet Filter

Configuration	
Item	Setting
▶ Packet Filters	<input type="checkbox"/> Enable
▶ Black List / White List	Deny those match the following rules. ▼
▶ Log Alert	<input type="checkbox"/> Log Alert

Configuration Window		
Item Name	Value setting	Description
Packet Filter	The box is unchecked by default	Check the Enable box to activate Packet Filter function
Black List / White List	Deny those match the following rules is set by default	When Deny those match the following rules is selected, as the name suggest, packets specified in the rules will be blocked –black listed. In contrast, with

5G NR M2M Gateway

		Allow those match the following rules , you can specifically white list the packets to pass and the rest will be blocked.
Log Alert	The box is unchecked by default	Check the Enable box to activate Event Log.
Save	N/A	Click Save to save the settings
Undo	N/A	Click Undo to cancel the settings

Create/Edit Packet Filter Rules

The gateway allows you to customize your packet filtering rules. It supports up to a maximum of 20 filter rule sets.

ID	Rule Name	From Interface	To Interface	Source IP	Destination IP	Source MAC	Protocol	Source Port	Destination Port	Time Schedule	Enable	Actions
----	-----------	----------------	--------------	-----------	----------------	------------	----------	-------------	------------------	---------------	--------	---------

When **Add** button is applied, **Packet Filter Rule Configuration** screen will appear.

Item	Setting
▶ Rule Name	Rule1
▶ From Interface	Any ▼
▶ To Interface	Any ▼
▶ Source IP	Any ▼
▶ Destination IP	Any ▼
▶ Source MAC	Any ▼
▶ Protocol	Any(0) ▼
▶ Source Port	User-defined Service ▼ [] - []
▶ Destination Port	User-defined Service ▼ [] - []
▶ Time Schedule	{0} Always ▼
▶ Rule	<input type="checkbox"/> Enable

Item Name	Value setting	Description
Rule Name	1. String format can be any text 2. A Must filled setting	Enter a packet filter rule name. Enter a name that is easy for you to remember. Value Range: 1 ~ 30 characters.
From Interface	1. A Must filled setting 2. By default Any is selected	Define the selected interface to be the packet-entering interface of the router. If the packets to be filtered are coming from LAN to WAN then select LAN for this field. Or VLAN-1 to WAN then select VLAN-1 for this field. Other examples are VLAN-1 to VLAN-2. VLAN-1 to WAN.

5G NR M2M Gateway

		Select Any to filter packets coming into the router from any interfaces. Please note that two identical interfaces are not accepted by the router. e.g., VLAN-1 to VLAN-1.
To Interface	1. A Must filled setting 2. By default Any is selected	Define the selected interface to be the packet-leaving interface of the router. If the packets to be filtered are entering from LAN to WAN then select WAN for this field. Or VLAN-1 to WAN then select WAN for this field. Other examples are VLAN-1 to VLAN-2. VLAN-1 to WAN. Select Any to filter packets leaving the router from any interfaces. Please note that two identical interfaces are not accepted by the router. e.g., VLAN-1 to VLAN-1.
Source IP	1. A Must filled setting 2. By default Any is selected	This field is to specify the Source IP address . Select Any to filter packets coming from any IP addresses. Select Specific IP Address to filter packets coming from an IP address. Select IP Range to filter packets coming from a specified range of IP address. Select IP Address-based Group to filter packets coming from a pre-defined group. Note: group must be pre-defined before this option become available. Refer to Object Definition > Grouping > Host grouping . You may also access to create a group by the Add Rule shortcut button.
Destination IP	1. A Must filled setting 2. By default Any is selected	This field is to specify the Destination IP address . Select Any to filter packets that are entering to any IP addresses. Select Specific IP Address to filter packets entering to an IP address entered in this field. Select IP Range to filter packets entering to a specified range of IP address entered in this field. Select IP Address-based Group to filter packets entering to a pre-defined group selected. Note: group must be pre-defined before this selection become available. Refer to Object Definition > Grouping > Host grouping . You may also access to create a group by the Add Rule shortcut button. Setting done through the Add Rule button will also appear in the Host grouping setting screen.
Source MAC	1. A Must filled setting 2. By default Any is selected	This field is to specify the Source MAC address . Select Any to filter packets coming from any MAC addresses. Select Specific MAC Address to filter packets coming from a MAC address. Select MAC Address-based Group to filter packets coming from a pre-defined group selected. Note: group must be pre-defined before this selection become available. Refer to Object Definition > Grouping > Host grouping . You may also access to create a group by the Add Rule shortcut button.
Protocol	1. A Must filled setting 2. By default Any(0) is selected	For Protocol , select Any to filter any protocol packets Then for Source Port , select a predefined port dropdown box when Well-known Service is selected, otherwise select User-defined Service and specify a port range. Then for Destination Port , select a predefined port dropdown box when Well-known Service is selected, otherwise select User-defined Service and specify a port range. Value Range: 1 ~ 65535 for Source Port, Destination Port.
		For Protocol , select ICMPv4 to filter ICMPv4 packets
		For Protocol , select TCP to filter TCP packets

5G NR M2M Gateway

		<p>Then for Source Port, select a predefined port dropdown box when Well-known Service is selected, otherwise select User-defined Service and specify a port range.</p> <p>Then for Destination Port, select a predefined port dropdown box when Well-known Service is selected, otherwise select User-defined Service and specify a port range.</p> <p>Value Range: 1 ~ 65535 for Source Port, Destination Port.</p>
		<p>For Protocol, select UDP to filter UDP packets</p> <p>Then for Source Port, select a predefined port dropdown box when Well-known Service is selected, otherwise select User-defined Service and specify a port range.</p> <p>Then for Destination Port, select a predefined port dropdown box when Well-known Service is selected, otherwise select User-defined Service and specify a port range.</p> <p>Value Range: 1 ~ 65535 for Source Port, Destination Port.</p>
		For Protocol , select GRE to filter GRE packets
		For Protocol , select ESP to filter ESP packets
		For Protocol , select SCTP to filter SCTP packets
		For Protocol , select User-defined to filter packets with specified port number. Then enter a port number in Protocol Number box.
Time Schedule	A Must filled setting	<p>Apply Time Schedule to this rule, otherwise leave it as Always.</p> <p>If the dropdown list is empty ensure Time Schedule is pre-configured. Refer to Object Definition > Scheduling > Configuration tab.</p>
Rule	The box is unchecked by default.	Click Enable box to activate this rule then save the settings.
Save	N/A	Click Save to save the settings.
Undo	N/A	Click X to cancel the settings and back to last page.

5G NR M2M Gateway

5.2.2 URL Blocking

"URL Blocking" function can let you define blocking or allowing rules for incoming and outgoing Web request packets. With defined rules, gateway can control the Web requests containing the complete URL, partial domain name, or pre-defined keywords. For example, one can filter out or allow only the Web requests based on domain input suffixes like .com or .org or keywords like "bct" or "mpe".

An URL blocking rule should specify the URL, partial domain name, or included keywords in the Web requests from and to the gateway and also the destination service port. Besides, a certain time schedule can be applied to activate the URL Blocking rules during pre-defined time interval(s).

The gateway will logs and displays the disallowed web accessing requests that matched the defined URL blocking rule in the black-list or in the exclusion of the white-list.

When you choose "Allow all to pass except those match the following rules" for the "URL Blocking Rule List", you are setting the defined URL blocking rules to belong to the black list. The packets, listed in the rule list, will be blocked if one pattern in the requests matches to one rule. Other Web requests can pass through the gateway. In contrast, when you choose "Deny all to pass except those match the following rules" for the "URL Blocking Rule List", you are setting the defined packet filtering rules to belong to the white list. The Web requests, listed in the rule, will be allowed if one pattern in the requests matches to one rule. Other Web requests will be blocked.

URL Blocking Rule with Black List

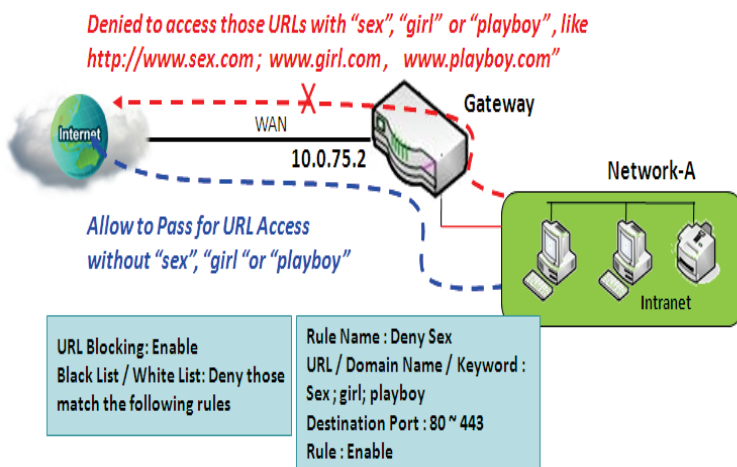

When the administrator of the gateway wants to block the Web requests with some dedicated patterns, he can use the "URL Blocking" function to block specific Web requests by defining the black list as shown in above diagram. Certainly, when the administrator wants to allow only the Web requests with some dedicated patterns to go through the gateway, he can also use the "URL Blocking" function by defining the white list to meet the requirement.

As shown in the diagram, enable the URL blocking function and create the first rule to

deny the Web requests with "sex" or "sexygirl" patterns and the other to deny the Web requests with "playboy" pattern to go through the gateway. System will block the Web requests with "sex", "sexygirl" or "playboy" patterns to pass through the gateway.

5G NR M2M Gateway

URL Blocking Setting

Go to **Security > Firewall > URL Blocking** Tab.

In "URL Blocking" page, there are three configuration windows. They are the "Configuration" window, "URL Blocking Rule List" window, and "URL Blocking Rule Configuration" window.

The "Configuration" window can let you activate the URL blocking function and specify to black listing or to white listing the packets defined in the "URL Blocking Rule List" entry. In addition, log alerting can be enabled to record on-going events for any disallowed Web request packets. Refer to "System Status" in "6.1.1 System Related" section in this user manual for how to view recorded log.

The "URL Blocking Rule List" window lists all your defined URL blocking rule entry. And finally, the "URL Blocking Rule Configuration" window can let you define URL blocking rules. The parameters in a rule include the rule name, the Source IP or MAC, the URL/Domain Name/Keyword, the destination service ports, the integrated time schedule rule and the rule activation.

Enable URL Blocking

Configuration	
Item	Setting
▶ URL Blocking	<input checked="" type="checkbox"/> Enable
▶ Black List / White List	Deny those match the following rules. ▼
▶ Log Alert	<input type="checkbox"/> Enable

Configuration		
Item	Value setting	Description
URL Blocking	The box is unchecked by default	Check the Enable box to activate URL Blocking function.
Black List / White List	Deny those match the following rules is set by default	Specify the URL Blocking Policy, either Black List or White List. Black List: When Deny those match the following rules is selected, as the name suggest, the matched Web request packets will be blocked. White List: When Allow those match the following rules is selected, the matched Web request packets can pass through the Gateway, and the others that don't match the rules will be blocked.
Log Alert	The box is unchecked by default	Check the Enable box to activate Event Log.
Save	NA	Click Save button to save the settings
Undo	NA	Click Undo button to cancel the settings

Create/Edit URL Blocking Rules

The Gateway supports up to a maximum of 20 URL blocking rule sets. Ensure that the URL Blocking is enabled before we can create blocking rules.

5G NR M2M Gateway

ID	Rule Name	Source IP	Source MAC	URL / Domain Name / Keyword	Destination Port	Time Schedule	Enable	Actions
URL Blocking Rule List Add Delete								

When **Add** button is applied, the **URL Blocking Rule Configuration** screen will appear.

URL Blocking Rule Configuration	
Item	Setting
▶ Rule Name	<input type="text" value="Rule1"/>
▶ Source IP	<input type="text" value="Any"/>
▶ Source MAC	<input type="text" value="Any"/>
▶ URL / Domain Name / Keyword	<input type="text"/>
▶ Destination Port	<input type="text" value="Any"/>
▶ Time Schedule Rule	<input type="text" value="(0) Always"/>
▶ Rule	<input type="checkbox"/> Enable

URL Blocking Rules Configuration		
Item	Value setting	Description
Rule Name	<ol style="list-style-type: none"> String format can be any text A Must filled setting 	Specify an URL Blocking rule name. Enter a name that is easy for you to understand.
Source IP	<ol style="list-style-type: none"> A Must filled setting Any is set by default 	This field is to specify the Source IP address . <ul style="list-style-type: none"> Select Any to filter packets coming from any IP addresses. Select Specific IP Address to filter packets coming from an IP address entered in this field. Select IP Range to filter packets coming from a specified range of IP address entered in this field. Select IP Address-based Group to filter packets coming from a pre-defined group selected. Note: group must be pre-defined before this option become available. Refer to Object Definition > Grouping > Host grouping.
Source MAC	<ol style="list-style-type: none"> A Must filled setting Any is set by default 	This field is to specify the Source MAC address . <ul style="list-style-type: none"> Select Any to filter packets coming from any MAC addresses. Select Specific MAC Address to filter packets coming from a MAC address entered in this field. Select MAC Address-based Group to filter packets coming from a pre-defined group selected. Note: group must be pre-defined before this selection become available. Refer to Object Definition > Grouping > Host grouping.
URL / Domain Name / Keyword	<ol style="list-style-type: none"> A Must filled setting Supports up to a maximum of 10 Keywords in a rule by using the delimiter “;”. 	Specify URL, Domain Name, or Keyword list for URL checking. <ul style="list-style-type: none"> In the Black List mode, if a matched rule is found, the packets will be dropped. In the White List mode, if a matched rule is found, the packets will be accepted and the others which don't match any rule will be dropped.
Destination Port	<ol style="list-style-type: none"> A Must filled setting Any is set by default 	This field is to specify the Destination Port number . <ul style="list-style-type: none"> Select Any to filter packets going to any Port. Select Specific Service Port to filter packets going to a specific Port entered in this field. Select Port Range to filter packets going to a specific range of Ports entered in this field.
Time Schedule Rule	A Must filled setting	Apply a specific Time Schedule to this rule; otherwise leave it as (0) Always . If the dropdown list is empty ensure Time Schedule is pre-configured. Refer to Object Definition > Scheduling > Configuration tab.
Rule	The box is unchecked by default.	Click the Enable box to activate this rule.

5G NR M2M Gateway

Save	<i>NA</i>	Click the Save button to save the settings.
Undo	<i>NA</i>	Click the X button to cancel the changes and back to last page.

5G NR M2M Gateway

5.2.3 MAC Control

Configuration

Item	Setting
MAC Control	<input checked="" type="checkbox"/> Enable
Black List / White List	Deny MAC Address Below. ▾
Log Alert	<input type="checkbox"/> Enable
Known MAC from LAN PC List	▾ Copy to

MAC Control Rule List Add Delete

ID	Rule Name	MAC Address	Time Schedule Rule	Enable	Actions
----	-----------	-------------	--------------------	--------	---------

"MAC Control" function allows you to assign the accessibility to the gateway for different users based on device's MAC address. When the administrator wants to reject the traffics from some client hosts with specific MAC addresses, he can use the "MAC Control" function to reject with the black list configuration.

MAC Control with Black List Scenario

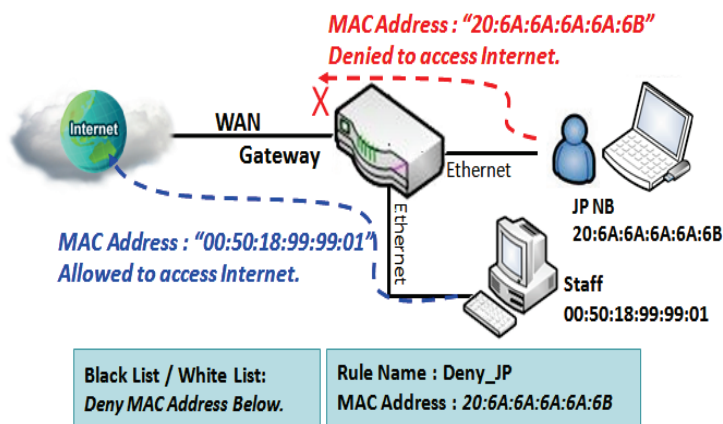

As shown in the diagram, enable the MAC control function and specify the "MAC Control Rule List" is a black list, and configure one MAC control rule for the gateway to deny the connection request from the "JP NB" with its own MAC address 20:6A:6A:6A:6A:6B.

System will block the connecting from the "JP NB" to the gateway but allow others.

5G NR M2M Gateway

MAC Control Setting

Go to **Security > Firewall > MAC Control** Tab.

The MAC control setting allows user to create and customize MAC address policies to allow or reject packets with specific source MAC address.

Enable MAC Control

Configuration	
Item	Setting
▶ MAC Control	<input type="checkbox"/> Enable
▶ Black List / White List	Deny MAC Address Below. ▼
▶ Log Alert	<input type="checkbox"/> Enable
▶ Known MAC from LAN PC List	▼ <input type="button" value="Copy to"/>

Configuration Window		
Item	Value setting	Description
MAC Control	The box is unchecked by default	Check the Enable box to activate the MAC filter function
Black List / White List	Deny MAC Address Below is set by default	When Deny MAC Address Below is selected, as the name suggest, packets specified in the rules will be blocked –black listed. In contrast, with Allow MAC Address Below , you can specifically white list the packets to pass and the rest will be blocked.
Log Alert	The box is unchecked by default	Check the Enable box to activate to activate Event Log.
Known MAC from LAN PC List	N/A	Select a MAC Address from LAN Client List. Click the Copy to to copy the selected MAC Address to the filter rule.
Save	N/A	Click Save to save the settings
Undo	N/A	Click Undo to cancel the settings

5G NR M2M Gateway

Create/Edit MAC Control Rules

The gateway supports up to a maximum of 20 filter rule sets. Ensure that the MAC Control is enabled before we can create control rules.

ID	Rule Name	MAC Address	Time Schedule Rule	Enable	Actions
----	-----------	-------------	--------------------	--------	---------

When **Add** button is applied, **Filter Rule Configuration** screen will appear.

Rule Name	MAC Address (Use : to Compose)	Time Schedule	Enable
<input type="text" value="Rule1"/>	<input type="text"/>	(0) Always ▾	<input type="checkbox"/>
<input type="button" value="Save"/>			

Item	Value setting	Description
Rule Name	1. String format can be any text 2. A Must fill setting	Enter a MAC Control rule name. Enter a name that is easy for you to remember.
MAC Address (Use: to Compose)	1. MAC Address string Format 2. A Must fill setting	Specify the Source MAC Address to filter rule.
Time Schedule	A Must fill setting	Apply Time Schedule to this rule; otherwise leave it as (0) Always . If the dropdown list is empty, ensure Time Schedule is pre-configured. Refer to Object Definition > Scheduling > Configuration tab
Enable	The box is unchecked by default.	Click Enable box to activate this rule, and then save the settings.
Save	N/A	Click Save to save the settings
Undo	N/A	Click Undo to cancel the settings

5G NR M2M Gateway

5.2.4 Content Filter (not supported)

Not supported feature for the purchased product, leave it as blank.

5G NR M2M Gateway

5.2.5 Application Filter (not supported)

Not supported feature for the purchased product, leave it as blank.

5G NR M2M Gateway

5.2.6 IPS

Configuration	
Item	Setting
▶ IPS	<input type="checkbox"/> Enable
▶ Log Alert	<input type="checkbox"/> Enable

Intrusion Prevention	
Item	Setting
▶ SYN Flood Defense	<input type="checkbox"/> Enable <input type="text" value="300"/> Packets/second (10~10000)
▶ UDP Flood Defense	<input type="checkbox"/> Enable <input type="text" value="300"/> Packets/second (10~10000)
▶ ICMP Flood Defense	<input type="checkbox"/> Enable <input type="text" value="300"/> Packets/second (10~10000)
▶ Port Scan Defense	<input type="checkbox"/> Enable <input type="text" value="200"/> Packets/second (10~10000)

To provide application servers in the Internet, administrator may need to open specific ports for the services. However, there are some risks to always open service ports in the Internet. In order to avoid such attack risks, it is important to enable IPS functions.

Intrusion Prevention System (IPS) is network security appliances that monitor network and/or system activities for malicious activity. The main functions of IPS are to identify malicious activity, log information about this activity, attempt to block/stop it and report it. You can enable the IPS function and check the listed intrusion activities when needed. You can also enable the log alerting so that system will record Intrusion events when corresponding intrusions are detected.

IPS Scenario

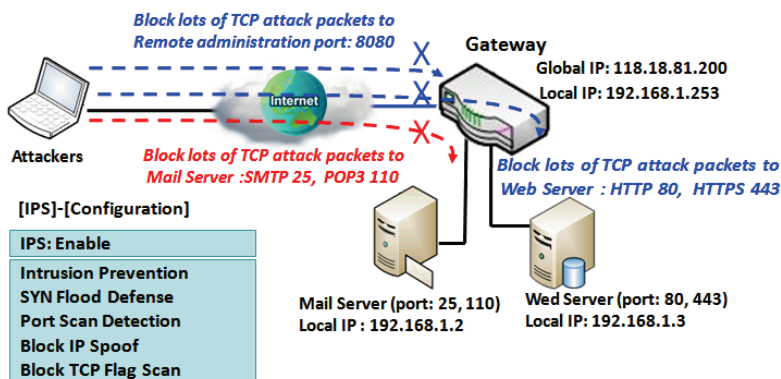

As shown in the diagram, the gateway serves as an E-mail server, Web Server and also provides TCP port 8080 for remote administration. So, remote users or unknown users can request those services from Internet. With IPS enabled, the gateway can detect incoming attack packets, including the TCP ports (25, 80, 110, 443 and 8080) with services. It will block the attack packets and let the normal access to pass through the gateway

5G NR M2M Gateway

IPS Setting

Go to **Security > Firewall > IPS** Tab.

The Intrusion Prevention System (IPS) setting allows user to customize intrusion prevention rules to prevent malicious packets.

Enable IPS Firewall

Configuration	
Item	Setting
▶ IPS	<input type="checkbox"/> Enable
▶ Log Alert	<input type="checkbox"/> Enable

Configuration Window		
Item	Value setting	Description
IPS	The box is unchecked by default	Check the Enable box to activate IPS function
Log Alert	The box is unchecked by default	Check the Enable box to activate to activate Event Log.
Save	N/A	Click Save to save the settings
Undo	N/A	Click Undo to cancel the settings

Setup Intrusion Prevention Rules

The router allows you to select intrusion prevention rules you may want to enable. Ensure that the IPS is enabled before we can enable the defense function.

5G NR M2M Gateway

Intrusion Prevention	
Item	Setting
▶ SYN Flood Defense	<input type="checkbox"/> Enable <input type="text" value="300"/> Packets/second (10~10000)
▶ UDP Flood Defense	<input type="checkbox"/> Enable <input type="text" value="300"/> Packets/second (10~10000)
▶ ICMP Flood Defense	<input type="checkbox"/> Enable <input type="text" value="300"/> Packets/second (10~10000)
▶ Port Scan Defense	<input type="checkbox"/> Enable <input type="text" value="200"/> Packets/second (10~10000)
▶ Block Land Attack	<input type="checkbox"/> Enable
▶ Block Ping of Death	<input type="checkbox"/> Enable
▶ Block IP Spoof	<input type="checkbox"/> Enable
▶ Block TCP Flag Scan	<input type="checkbox"/> Enable
▶ Block Smurf	<input type="checkbox"/> Enable
▶ Block Traceroute	<input type="checkbox"/> Enable
▶ Block Fraggle Attack	<input type="checkbox"/> Enable
▶ ARP Spoofing Defense	<input type="checkbox"/> Enable <input type="text" value="300"/> Packets/second (10~10000)

Setup Intrusion Prevention Rules		
Item Name	Value setting	Description
SYN Flood Defense	1. A Must filled setting	Click Enable box to activate this intrusion prevention rule and enter the traffic threshold in this field.
UDP Flood Defense	2. The box is unchecked by default.	Click Enable box to activate this intrusion prevention rule and enter the traffic threshold in this field.
ICMP Flood Defense	3. Traffic threshold is set to 300 by default	Click Enable box to activate this intrusion prevention rule and enter the traffic threshold in this field.
	4. The value range can be from 10 to 10000.	Value Range: 10 ~ 10000.
Port Scan Defection	1. A Must filled setting	Click Enable box to activate this intrusion prevention rule and enter the traffic threshold in this field.
	2. The box is unchecked by default.	Value Range: 10 ~ 10000.
	3. Traffic threshold is set to 200 by default	
	4. The value range can be from 10 to 10000.	
Block Land Attack		
Block Ping of Death		
Block IP Spoof		
Block TCP Flag Scan	The box is unchecked by default.	Click Enable box to activate this intrusion prevention rule.
Block Smurf		
Block Traceroute		
Block Fraggle		

5G NR M2M Gateway

Attack		
ARP Spoofing Defence	<ol style="list-style-type: none">1. A Must filled setting2. The box is unchecked by default.3. Traffic threshold is set to 300 by default4. The value range can be from 10 to 10000.	Click Enable box to activate this intrusion prevention rule and enter the traffic threshold in this field. <i>Value Range: 10 ~ 10000.</i>
Save	NA	Click Save to save the settings
Undo	NA	Click Undo to cancel the settings

5G NR M2M Gateway

5.2.7 Options

Firewall Options	
Item	Setting
▶ Stealth Mode	<input type="checkbox"/> Enable
▶ SPI	<input checked="" type="checkbox"/> Enable
▶ Discard Ping from WAN	<input type="checkbox"/> Enable

Remote Administrator Host Definition							
ID	Interface	Protocol	IP	Subnet Mask	Service Port	Enable	Action
1	All WAN	HTTPS	Any IP	N/A	443	<input type="checkbox"/>	Edit
2	All WAN	HTTPS	Any IP	N/A	443	<input type="checkbox"/>	Edit
3	All WAN	HTTPS	Any IP	N/A	443	<input type="checkbox"/>	Edit
4	All WAN	HTTPS	Any IP	N/A	443	<input type="checkbox"/>	Edit
5	All WAN	HTTPS	Any IP	N/A	443	<input type="checkbox"/>	Edit

There are some additional useful firewall options in this page.

“Stealth Mode” lets gateway not to respond to port scans from the WAN so that makes it less susceptible to discovery and attacks on the Internet. “SPI” enables gateway to record the packet information like IP address, port address, ACK, SEQ number and so on while they pass through the gateway, and the gateway checks every incoming packet to detect if this packet is valid.

“Discard Ping from WAN” makes any host on the WAN side can’t ping this gateway. And finally, “Remote Administrator Hosts” enables you to perform administration task from a remote host. If this feature is enabled, only specified IP address(es) can perform remote administration.

5G NR M2M Gateway

Enable SPI Scenario

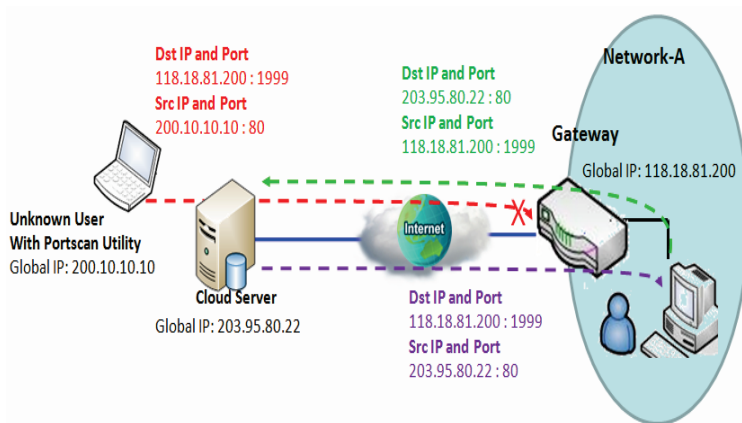

As shown in the diagram, Gateway has the IP address of 118.18.81.200 for WAN interface and 192.168.1.253 for LAN interface. It serves as a NAT gateway. Users in Network-A initiate to access cloud server through the gateway. Sometimes, unknown users will simulate the packets but use different source IP to masquerade. With the SPI feature been enabled at the gateway, it will block such packets from unknown users.

Discard Ping from WAN & Remote Administrator Hosts Scenario

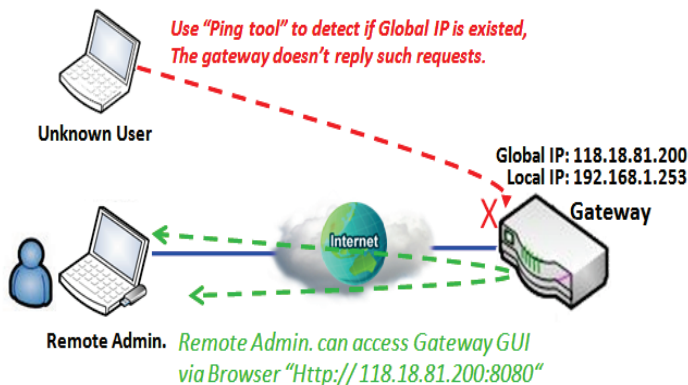

"Discard Ping from WAN" makes any host on the WAN side can't ping this gateway reply any ICMP packets. Enable the Discard Ping from WAN function to prevent security leak when local users surf the internet.

Remote administrator knows the gateway's global IP, and he can access the Gateway GUI via TCP port 8080.

5G NR M2M Gateway

Firewall Options Setting

Go to **Security > Firewall > Options** Tab.

The firewall options setting allows network administrator to modify the behavior of the firewall and to enable Remote Router Access Control.

Enable Firewall Options

Item	Setting
▶ Stealth Mode	<input type="checkbox"/> Enable
▶ SPI	<input checked="" type="checkbox"/> Enable
▶ Discard Ping from WAN	<input type="checkbox"/> Enable

Item	Value setting	Description
Stealth Mode	The box is unchecked by default	Check the Enable box to activate the Stealth Mode function
SPI	The box is checked by default	Check the Enable box to activate the SPI function
Discard Ping from WAN	The box is unchecked by default	Check the Enable box to activate the Discard Ping from WAN function

Define Remote Administrator Host

The router allows network administrator to manage router remotely. The network administrator can assign specific IP address and service port to allow accessing the router via designated WAN interface.

ID	Interface	Protocol	IP	Subnet Mask	Service Port	Enable	Action
1	All WAN	HTTPS	Any IP	N/A	443	<input type="checkbox"/>	Edit
2	All WAN	HTTPS	Any IP	N/A	443	<input type="checkbox"/>	Edit
3	All WAN	HTTPS	Any IP	N/A	443	<input type="checkbox"/>	Edit
4	All WAN	HTTPS	Any IP	N/A	443	<input type="checkbox"/>	Edit
5	All WAN	HTTPS	Any IP	N/A	443	<input type="checkbox"/>	Edit

5G NR M2M Gateway

Remote Administrator Host Definition		
Item	Value setting	Description
Protocol	HTTPS is set by default	Select HTTP or HTTPS method for remote administration.
IP	A Must filled setting	This field is to specify the remote host to assign access right for remote access. Select Any IP to allow any remote hosts Select Specific IP to allow the remote host coming from a specific subnet. An IP address entered in this field and a selected Subnet Mask to compose the subnet.
Service Port	1. 80 for HTTP by default 2. 443 for HTTPS by default	This field is to specify a Service Port to HTTP or HTTPS connection. <i>Value Range: 1 ~ 65535.</i>
Enabling the rule	The box is unchecked by default.	Click Enable box to activate this rule.
Save	N/A	Click Enable box to activate this rule then save the settings.
Undo	N/A	Click Undo to cancel the settings

5G NR M2M Gateway

Chapter 6 Administration

6.1 Configure & Manage

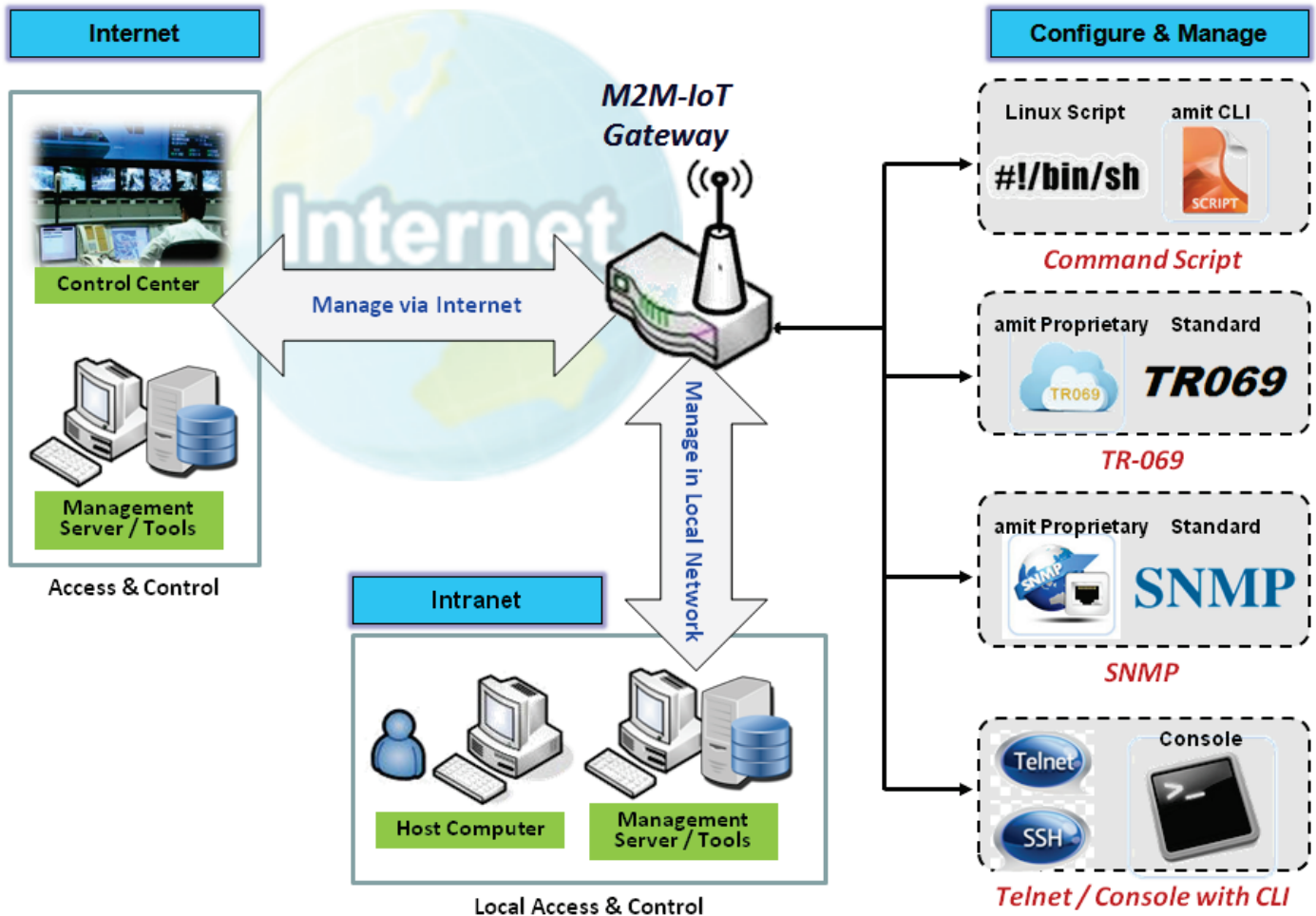

Configure & Manage refers to enterprise-wide administration of distributed systems including (and commonly in practice) computer systems. Centralized management has a time and effort trade-off that is related to the size of the company, the expertise of the IT staff, and the amount of technology being used. This device supports many system management protocols, such as Command Script, TR-069, SNMP, and Telnet with CLI. You can setup those configurations in the "Configure & Manage" section.

5G NR M2M Gateway

6.1.1 Command Script

Command script configuration is the application that allows administrator to setup the pre-defined configuration in plain text style and apply configuration on startup.

Go to **Administration > Command Script > Configuration Tab**.

Enable Command Script Configuration

Configuration	
Item	Setting
▶ Command Script	<input type="checkbox"/> Enable
▶ Backup Script	<button>Via Web UI</button>
▶ Upload Script	<button>Via Web UI</button>
▶ Script Name	<input type="text"/>
▶ Version	<input type="text"/>
▶ Description	<div style="border: 1px solid #ccc; height: 40px;"></div>
▶ Update time	2019-04-08T18:05:31

Configuration Item	Value setting	Description
Command Script	The box is unchecked by default	Check the Enable box to activate the Command Script function.
Backup Script	N/A	Click the Via Web UI or Via Storage button to backup the existed command script in a .txt file. You can specify the script file name in Script Name below.
Upload Script	N/A	Click the Via Web UI or Via Storage button to Upload the existed command script from a specified .txt file.
Script Name	1.An Optional setting 2.Any valid file name	Specify a script file name for script backup, or display the selected upload script file name. Value Range: 0 ~ 32 characters.
Version	1.An Optional setting 2.Any string	Specify the version number for the applied Command script. Value Range: 0 ~ 32 characters.
Description	1.An Optional setting 2.Any string	Enter a short description for the applied Command script.
Update time	N/A	It records the upload time for last commad script upload.

5G NR M2M Gateway

Edit/Backup Plain Text Command Script

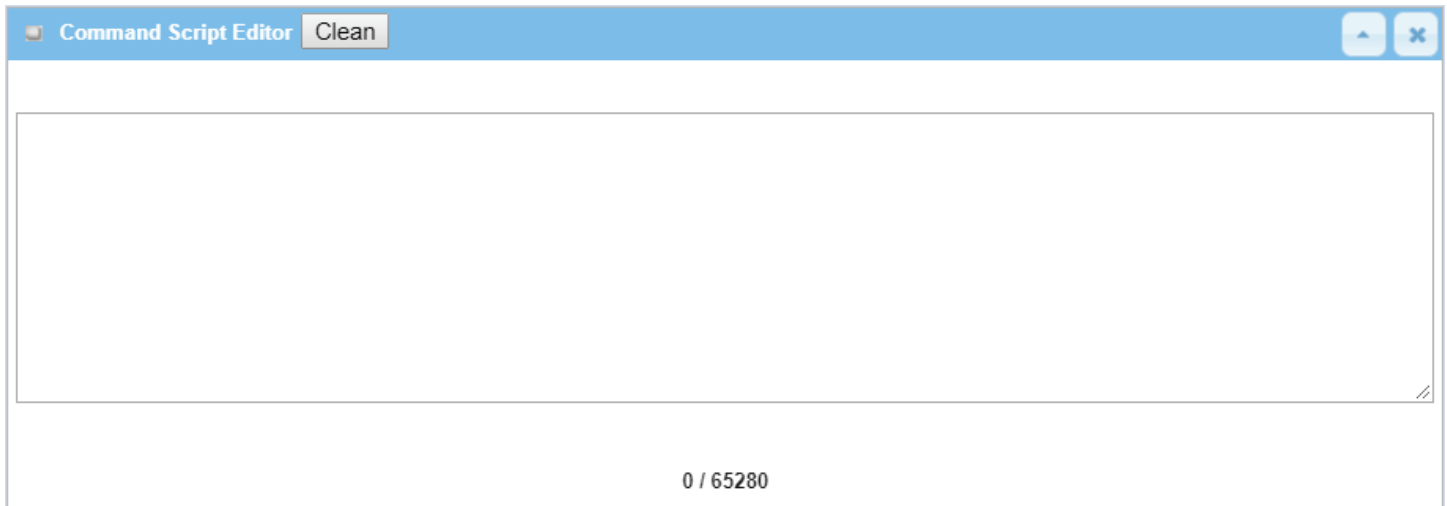

You can edit the plain text configuration settings in the configuration screen as above.

Plain Text Configuration		
Item	Value setting	Description
Clean	NA	Clean text area. (You should click Save button to further clean the configuration already saved in the system.)
Backup	NA	Backup and download configuration.
Save	NA	Save configuration

The supported plain text configuration items are shown in the following list. For the settings that can be executed with standard Linux commands, you can put them in a script file, and apply to the system configure with **STARTUP** command. For those configurations without corresponding Linux command set to configure, you can configure them with proprietary command set.

Configuration Content		
Key	Value setting	Description
OPENVPN_ENABLED	1 : enable 0 : disable	Enable or disable OpenVPN Client function.
OPENVPN_DESCRIPTION	A Must filled Setting	Specify the tunnel name for the OpenVPN Client connection.
OPENVPN_PROTO	udp tcp	Define the Protocol for the OpenVPN Client. <ul style="list-style-type: none">• Select TCP or TCP /UDP ->The OpenVPN will use TCP protocol, and Port will be set as 443 automatically.• Select UDP -> The OpenVPN will use UDP protocol, and Port will be set as 1194 automatically.
OPENVPN_PORT	A Must filled Setting	Specify the Port for the OpenVPN Client to use.
OPENVPN_REMOTE_IPADDR	IP or FQDN	Specify the Remote IP/FQDN of the peer OpenVPN Server for this OpenVPN Client tunnel. Fill in the IP address or FQDN.
OPENVPN_PING_INTVL	seconds	Specify the time interval for OpenVPN keep-alive checking.
OPENVPN_PING_TOUT	seconds	Specify the timeout value for OpenVPN Client keep-alive checking.

5G NR M2M Gateway

OPENVPN_COMP	Adaptive	Specify the LZO Compression algorithm for OpenVPN client.
OPENVPN_AUTH	Static Key/TLS	Specify the authorization mode for the OpenVPN tunnel. <ul style="list-style-type: none"> • TLS ->The OpenVPN will use TLS authorization mode, and the following items CA Cert., Client Cert. and Client Key need to specify as well.
OPENVPN_CA_CERT	A Must filled Setting	Specify the Trusted CA certificate for the OpenVPN client. It will go through Base64 Conversion.
OPENVPN_LOCAL_CERT	A Must filled Setting	Specify the local certificate for OpenVPN client. It will go through Base64 Conversion.
OPENVPN_LOCAL_KEY	A Must filled Setting	Specify the local key for the OpenVPN client. It will go through Base64 Conversion.
OPENVPN_EXTRA_OPTS	Options	Specify the extra options setting for the OpenVPN client.
IP_ADDR1	Ip	Ethernet LAN IP
IP_NETM1	Net mask	Ethernet LAN MASK
PPP_MONITORING	1 : enable 0 : disable	When the Network Monitoring feature is enabled, the router will use DNS Query or ICMP to periodically check Internet connection – connected or disconnected.
PPP_PING	0 : DNS Query 1 : ICMP Query	With DNS Query , the system checks the connection by sending DNS Query packets to the destination specified in PPP_PING_IPADDR. With ICMP Query , the system will check connection by sending ICMP request packets to the destination specified in PPP_PING_IPADDR.
PPP_PING_IPADDR	IP	Specify an IP address as the target for sending DNS query/ICMP request.
PPP_PING_INTVL	seconds	Specify the time interval for between two DNS Query or ICMP checking packets.
STARTUP	Script file	For the configurations that can be configured with standard Linux commands, you can put them in a script file, and apply the script file with STARTUP command. For example, STARTUP=#!/bin/sh STARTUP=echo "startup done" > /tmp/demo

Plain Text System Configuration with Telnet

In addition to the web-style plain text configuration as mentioned above, the gateway system also allow the configuration via Telnet CLI. Administrator can use the proprietary telnet command “*txtConfig*” and related action items to perform the plain system configuration.

The command format is: `txtConfig (action) [option]`

Action	Option	Description
clone	<i>Output file</i>	Duplicate the configuration content from database and stored as a configuration file. (ex: <code>txtConfig clone /tmp/config</code>) The contents in the configuration file are the same as the plain text commands mentioned above. This action is exactly the same as performing the “Backup” plain text configuration.
commit	a existing file	Commit the configuration content to database.

5G NR M2M Gateway

		(ex: <i>txtConfig commit /tmp/config</i>)
enable	NA	Enable plain text system config. (ex: <i>txtConfig enable</i>)
disable	NA	Disable plain text system config. (ex: <i>txtConfig disable</i>)
run_immediately	NA	Apply the configuration content that has been committed in database. (ex: <i>txtConfig run_immediately</i>)
run_immediately	a existing file	Assign a configuration file to apply. (ex: <i>txtConfig run_immediately /tmp/config</i>)

5G NR M2M Gateway

6.1.2 D-ECS(D-LINK EDGE CLOUD SOLUTION)

D-ECS (D-Link Edge Cloud SOLUTION TR-069) allows users to manage DWM-3010 device.

To Enable Remote D-ECS Service:

1. Select “Use Remote Service for Management” or access via webpage <https://us7-nv3-web.decs.dlink.com/web/index.jsp> to enable this feature.
3. Login using your ID and password.
4. The D-ECS can now show device information

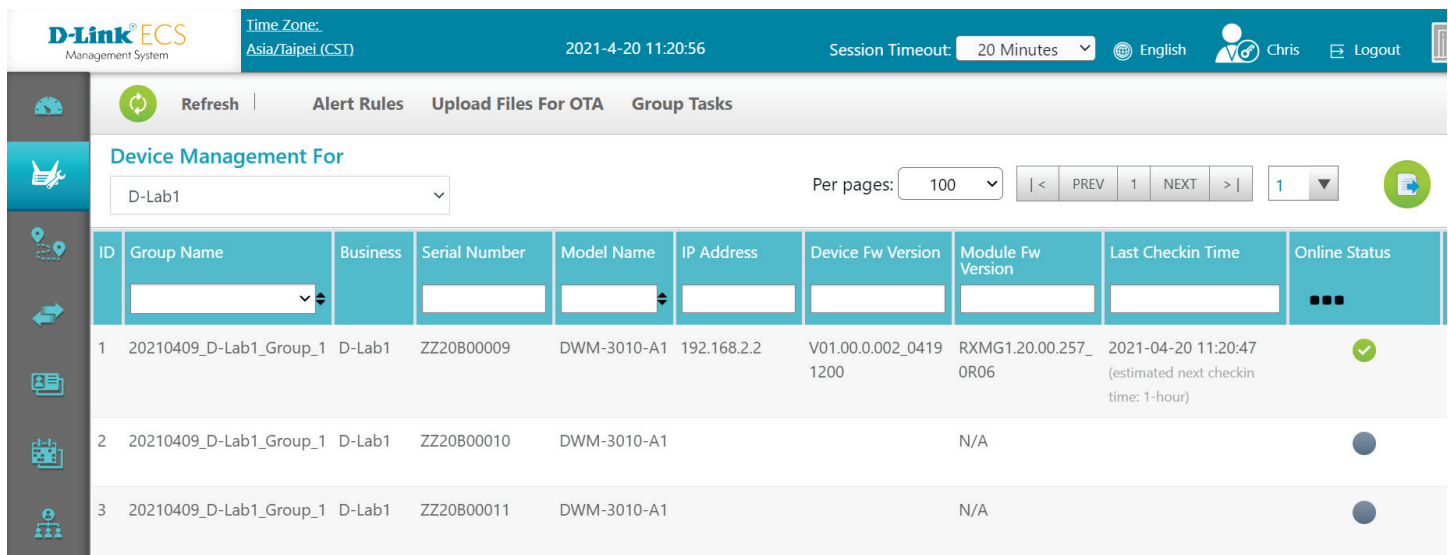

The screenshot shows the D-Link ECS Management System interface. At the top, it displays the D-Link ECS logo, Time Zone (Asia/Taipei (CST)), date and time (2021-4-20 11:20:56), Session Timeout (20 Minutes), language (English), and user name (Chris) with a Logout button. Below the header, there are navigation options: Refresh, Alert Rules, Upload Files For OTA, and Group Tasks. The main content area is titled "Device Management For" and shows a dropdown menu for "D-Lab1". To the right, there are pagination controls: "Per pages: 100", "PREV", "1", "NEXT", and "1". Below this is a table with the following columns: ID, Group Name, Business, Serial Number, Model Name, IP Address, Device Fw Version, Module Fw Version, Last Checkin Time, and Online Status. The table contains three rows of device data.

ID	Group Name	Business	Serial Number	Model Name	IP Address	Device Fw Version	Module Fw Version	Last Checkin Time	Online Status
1	20210409_D-Lab1_Group_1	D-Lab1	ZZ20B00009	DWM-3010-A1	192.168.2.2	V01.00.0.002_0419 1200	RXMG1.20.00.257_ OR06	2021-04-20 11:20:47 (estimated next checkin time: 1-hour)	✓
2	20210409_D-Lab1_Group_1	D-Lab1	ZZ20B00010	DWM-3010-A1			N/A		●
3	20210409_D-Lab1_Group_1	D-Lab1	ZZ20B00011	DWM-3010-A1			N/A		●

To enable Local D-ECS service:

1. Disable “Use Remote Service for Management”
2. Input your Local Service URL. For example: <http://35.173.33.16/ACS/tr069>
<https://decs.dlink.com.sg/ACS/tr069>
3. Input your Local Service IP STUN traffic. For example: 35.173.33.16
decs.dlink.com.sg

5G NR M2M Gateway

The screenshot displays the D-Link DWM-3010 web management interface. The top left corner features the D-Link logo and the model number DWM-3010. The top right corner includes a language dropdown menu set to 'English' and a 'Logout' button. The main navigation menu on the left lists various system functions: Status, Basic Network, Object Definition, Field Communication, Security, Administration, Configure & Manage (highlighted), System Operation, FTP, Diagnostic, and Service. The main content area is titled 'Device Management' and contains a configuration table with the following items and settings:

Item	Setting
Device Management	<input checked="" type="checkbox"/> Enable
Use Remote Service for Management	<input type="checkbox"/> Enable
Input Local Service URL	<input type="text" value="https://decs.dlink.com.sg/ACS/tr069"/>
Input Local Server IP STUN traffic	<input type="text" value="decs.dlink.com.sg"/>

Below the table are 'Save' and 'Undo' buttons. The bottom right corner of the interface shows a Windows logo and the text '© 2015 Windows'.

5G NR M2M Gateway

6.1.3 SNMP

In brief, SNMP, the Simple Network Management Protocol, is a protocol designed to give a user the capability to remotely manage a computer network by polling and setting terminal values and monitoring network events.

In typical SNMP uses, one or more administrative computers, called managers, have the task of monitoring or managing a group of hosts or devices on a computer network. Each managed system executes, at all times, a software component called an agent which reports information via SNMP to the manager.

SNMP agents expose management data on the managed systems as variables. The protocol also permits active management tasks, such as modifying and applying a new configuration through remote modification of these variables. The variables accessible via SNMP are organized in hierarchies. These hierarchies, and other metadata (such as type and description of the variable), are described by Management Information Bases (MIBs).

The device supports several public MIBs and one private MIB for the SNMP agent. The supported MIBs are as follow: MIB-II (RFC 1213, Include IPv6), IF-MIB, IP-MIB, TCP-MIB, UDP-MIB, SMlv1 and SMlv2, SNMPv2-TM and SNMPv2-MIB, and AMIB (a Proprietary MIB)

SNMP Management Scenario

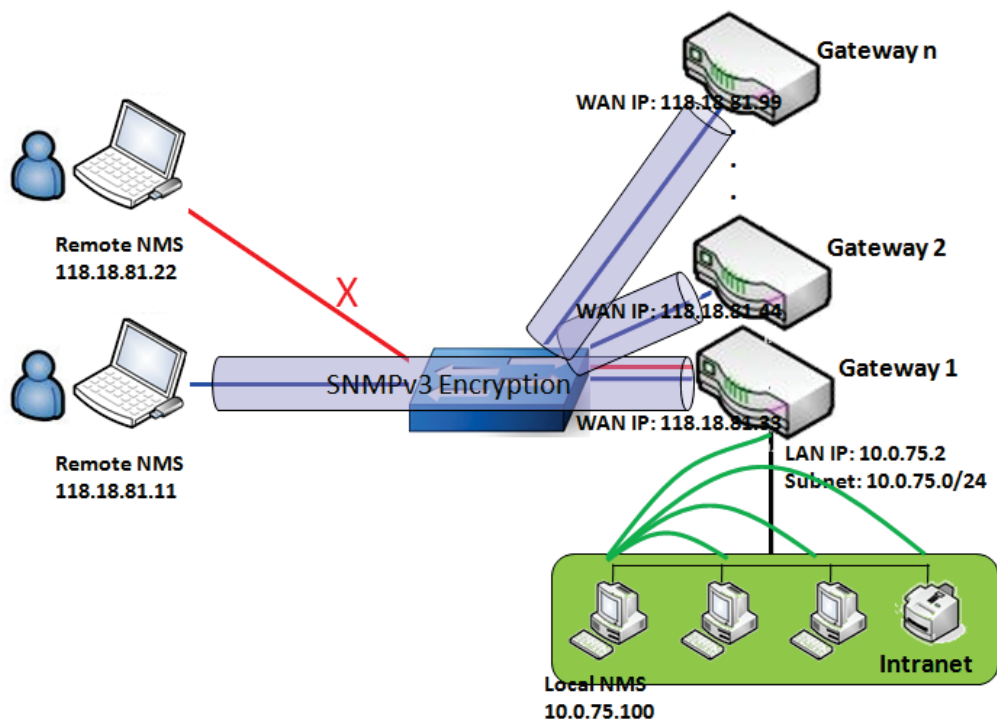

Scenario Application Timing

There are two application scenarios of SNMP Network Management Systems (NMS). Local NMS is in the Intranet and manage all devices that support SNMP protocol in the Intranet. Another one is the Remote NMS to manage some devices whose WAN interfaces are connected together by using a switch or a router with UDP forwarding. If you want to manage some devices and they all have supported SNMP

5G NR M2M Gateway

protocol, use either one application scenario, especially the management of devices in the Intranet. In managing devices in the Internet, the TR-069 is the better solution. Please refer to last sub-section.

Scenario Description

The NMS server can monitor and configure the managed devices by using SNMP protocol, and those devices are located at where UDP packets can reach from NMS.

The managed devices report urgent trap events to the NMS servers.

Use SNMPv3 version of protocol can protected the transmitting of SNMP commands and responses.

The remote NMS with privilege IP address can manage the devices, but other remote NMS can't.

Parameter Setup Example

Following tables list the parameter configuration as an example for the Gateway 1 in above diagram with "SNMP" enabling at LAN and WAN interfaces.

Use default value for those parameters that are not mentioned in the tables.

Configuration Path	[SNMP]-[Configuration]
SNMP Enable	■ LAN ■ WAN
Supported Versions	■ v1 ■ v2c ■ v3
Get / Set Community	ReadCommunity / WriteCommunity
Trap Event Receiver 1	118.18.81.11
WAN Access IP Address	118.18.81.11

Configuration Path	[SNMP]-[User Privacy Definition]		
ID	1	2	3
User Name	UserName1	UserName2	UserName3
Password	Password1	Password2	Disable
Authentication	MD5	SHA-1	Disable
Encryption	DES	Disable	Disable
Privacy Mode	authPriv	authNoPriv	noAuthNoPriv
Privacy Key	12345678	Disable	Disable
Authority	Read/Write	Read	Read
Enable	■ Enable	■ Enable	■ Enable

Scenario Operation Procedure

In above diagram, the NMS server can manage multiple devices in the Intranet or a UDP-reachable network. The "Gateway 1" is one of the managed devices, and it has the IP address of 10.0.75.2 for LAN interface and 118.18.81.33 for WAN-1 interface. It serves as a NAT router.

At first stage, the NMS manager prepares related information for all managed devices and records them in the NMS system. Then NMS system gets the status of all managed devices by using SNMP get commands.

When the manager wants to configure the managed devices, the NMS system allows him to do that by

5G NR M2M Gateway

using SNMP set commands. The "UserName1" account is used if the manager uses SNMPv3 protocol for configuring the "Gateway 1". Only the "UserName1" account can let the "Gateway 1" accept the configuration from the NMS since the authority of the account is "Read/Write".

Once a managed device has an urgent event to send, the device will issue a trap to the Trap Event Receivers. The NMS itself could be one among them.

If you want to secure the transmitted SNMP commands and responses between the NMS and the managed devices, use SNMPv3 version of protocol.

The remote NMS without privilege IP address can't manage the "Gateway 1", since "Gateway 1" allows only the NMS with privilege IP address can manage it via its WAN interface.

5G NR M2M Gateway

SNMP Setting

Go to **Administration > Configure & Manage > SNMP** tab.

The SNMP allows user to configure SNMP relevant setting which includes interface, version, access control and trap receiver.

Enable SNMP

Configuration
⏪ ⏴ ⏵ ⏩

Item	Setting
▶ SNMP Enable	<input checked="" type="checkbox"/> LAN <input type="checkbox"/> WAN
▶ WAN Interface	All WANs ▼
▶ Supported Versions	<input checked="" type="checkbox"/> v1 <input checked="" type="checkbox"/> v2c <input type="checkbox"/> v3
▶ SNMP Port	161
▶ Limited Remote Access IP	IP Range ▼
	<input type="text"/> - <input type="text"/> <input type="checkbox"/> Enable
	<input type="text"/> - <input type="text"/> <input type="checkbox"/> Enable
	<input type="text"/> - <input type="text"/> <input type="checkbox"/> Enable
	<input type="text"/> - <input type="text"/> <input type="checkbox"/> Enable
	<input type="text"/> - <input type="text"/> <input type="checkbox"/> Enable

SNMP Item	Value setting	Description
SNMP Enable	1.The boxes are unchecked by default	Select the interface for the SNMP and enable SNMP functions. When Check the LAN box, it will activate SNMP functions and you can access SNMP from LAN side; When Check the WAN box, it will activate SNMP functions and you can access SNMP from WAN side.
WAN Interface	1.A Must filled setting 2. ALL WANs is selected by default	Specify the WAN interface that a remote SNMP host can access to the device. By default, All WANs is selected, and there is no limitation for the WAN interface.
Supported Versions	1.A Must filled setting 2.The boxes are unchecked by default	Select the version for the SNMP When Check the v1 box. It means you can access SNMP by version 1. When Check the v2c box. It means you can access SNMP by version 2c. When Check the v3 box. It means you can access SNMP by version 3.
SNMP Port	1. String format: any port number	Specify the SNMP Port .

5G NR M2M Gateway

	<p>2. The default SNMP port is 161.</p> <p>3. A Must filled setting</p>	<p>You can fill in any port number. But you must ensure the port number is not to be used.</p> <p>Value Range: 1 ~ 65535.</p>
Limited Remote Access IP	<p>1. String format: any IPv4 address</p> <p>2. It is an optional item.</p>	<p>Specify the Remote Access IP for WAN and check the box to enable it as well. Select Specific IP Address, and fill in a certain IP address. It means only this IP address can access SNMP from LAN/WAN side.</p> <p>Select IP Range, and fill in a range of IP addresses. It means the IP address within specified range can access SNMP from LAN/WAN side.</p> <p>If you left it as blank, it means any IP address can access SNMP from WAN side.</p>
Save	N/A	Click Save to save the settings
Undo	N/A	Click Undo to cancel the settings

Create/Edit Multiple Community

The SNMP allows you to custom your access control for version 1 and version 2 user. The router supports up to a maximum of 10 community sets.



When **Add** button is applied, **Multiple Community Rule Configuration** screen will appear.

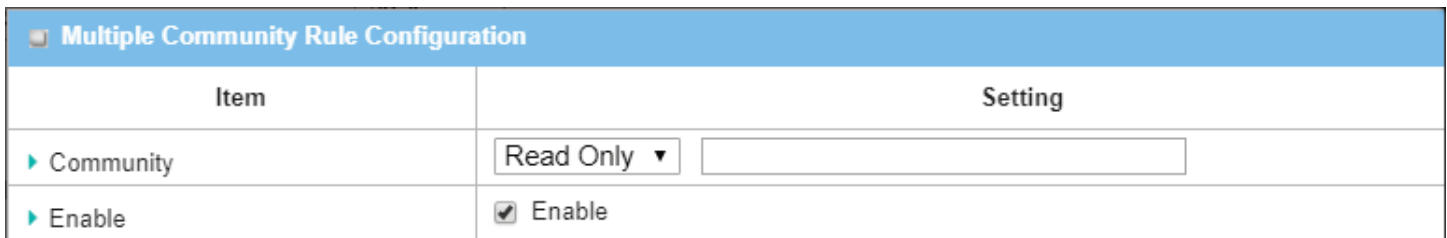

Multiple Community Rule Configuration		
Item	Value setting	Description
Community	<p>1. Read Only is selected by default</p> <p>2. A Must filled setting</p> <p>3. String format: any text</p>	<p>Specify this version 1 or version v2c user's community that will be allowed Read Only (GET and GETNEXT) or Read-Write (GET, GETNEXT and SET) access respectively.</p> <p>The maximum length of the community is 32.</p>
Enable	1.The box is checked by default	Click Enable to enable this version 1 or version v2c user.
Save	N/A	Click the Save button to save the configuration. But it does not apply to SNMP functions. When you return to the SNMP main page. It will show "Click on save button to apply your changes" remind user to click main page Save button.

5G NR M2M Gateway

Undo	N/A	Click the Undo button to cancel the settings.
Back	N/A	Click the Back button to return to last page.

Create/Edit User Privacy

The SNMP allows you to custom your access control for version 3 user. The router supports up to a maximum of 128 User Privacy sets.

User Privacy List										
ID	User Name	Password	Authentication	Encryption	Privacy Mode	Privacy Key	Authority	OID Filter Prefix	Enable	Actions

When **Add** button is applied, **User Privacy Rule Configuration** screen will appear.

User Privacy Rule Configuration	
Item	Setting
▶ User Name	<input type="text"/>
▶ Password	<input type="password"/>
▶ Authentication	None ▼
▶ Encryption	None ▼
▶ Privacy Mode	noAuthNoPriv ▼
▶ Privacy Key	<input type="password"/>
▶ Authority	Read ▼
▶ OID Filter Prefix	<input type="text" value="1"/>
▶ Enable	<input checked="" type="checkbox"/> Enable

User Privacy Rule Configuration		
Item	Value setting	Description
User Name	1. A Must filled setting 2. String format: any text	Specify the User Name for this version 3 user. Value Range: 1 ~ 32 characters.
Password	1. String format: any text	When your Privacy Mode is authNoPriv or authPriv , you must specify the Password for this version 3 user. Value Range: 8 ~ 64 characters.
Authentication	1. None is selected by default	When your Privacy Mode is authNoPriv or authPriv , you must specify the Authentication types for this version 3 user. Selected the authentication types MD5/ SHA-1 to use.
Encryption	1. None is selected by default	When your Privacy Mode is authPriv , you must specify the Encryption protocols for this version 3 user. Selected the encryption protocols DES / AES to use.
Privacy Mode	1. noAuthNoPriv is	Specify the Privacy Mode for this version 3 user.

5G NR M2M Gateway

	selected by default	<p>Selected the noAuthNoPriv. You do not use any authentication types and encryption protocols.</p> <p>Selected the authNoPriv. You must specify the Authentication and Password.</p> <p>Selected the authPriv. You must specify the Authentication, Password, Encryption and Privacy Key.</p>
Privacy Key	1. String format: any text	When your Privacy Mode is authPriv , you must specify the Privacy Key (8 ~ 64 characters) for this version 3 user.
Authority	1. Read is selected by default	Specify this version 3 user's Authority that will be allowed Read Only (GET and GETNEXT) or Read-Write (GET, GETNEXT and SET) access respectively.
OID Filter Prefix	<p>1. The default value is 1</p> <p>2. A Must filled setting</p> <p>3. String format: any legal OID</p>	The OID Filter Prefix restricts access for this version 3 user to the sub-tree rooted at the given OID. Value Range: 1 ~2080768.
Enable	1.The box is checked by default	Click Enable to enable this version 3 user.
Save	N/A	Click the Save button to save the configuration. But it does not apply to SNMP functions. When you return to the SNMP main page. It will show "Click on save button to apply your changes" remind user to click main page Save button.
Undo	N/A	Click the Undo button to cancel the settings
Back	N/A	Click the X button to return the last page.

Create/Edit Trap Event Receiver

The SNMP allows you to custom your trap event receiver. The router supports up to a maximum of 4 Trap Event Receiver sets.

Trap Event Receiver List												Add	Delete	▲	✕
ID	Server IP	Server Port	SNMP Version	Community Name	User Name	Password	Privacy Mode	Authentication	Encryption	Privacy Key	Enable	Actions			

When **Add** button is applied, **Trap Event Receiver Rule Configuration** screen will appear. The default SNMP Version is v1. The configuration screen will provide the version 1 must filled items.

5G NR M2M Gateway

Trap Event Receiver Rule Configuration	
Item	Setting
▶ Server IP	<input type="text"/> (IP Address/FQDN)
▶ Server Port	<input type="text" value="162"/>
▶ SNMP Version	<input type="text" value="v1"/>
▶ Community Name	<input type="text"/>
▶ Enable	<input checked="" type="checkbox"/> Enable

When you selected v2c, the configuration screen is exactly the same as that of v1, except the version.

When you selected v3, the configuration screen will provide more setting items for the version 3 Trap.

Trap Event Receiver Rule Configuration	
Item	Setting
▶ Server IP	<input type="text"/> (IP Address/FQDN)
▶ Server Port	<input type="text" value="162"/>
▶ SNMP Version	<input type="text" value="v3"/>
▶ Community Name	<input type="text"/>
▶ User Name	<input type="text"/>
▶ Password	<input type="text"/>
▶ Privacy Mode	<input type="text" value="noAuthNoPriv"/>
▶ Authentication	<input type="text" value="None"/>
▶ Encryption	<input type="text" value="None"/>
▶ Privacy Key	<input type="text"/>
▶ Enable	<input checked="" type="checkbox"/> Enable

Trap Event Receiver Rule Configuration		
Item	Value setting	Description
Server IP	<ol style="list-style-type: none"> 1. A Must filled setting 2. String format: any IPv4 address or FQDN 	Specify the trap Server IP or FQDN . The DUT will send trap to the server IP/FQDN.
Server Port	<ol style="list-style-type: none"> 1. String format: any port number 2. The default SNMP trap port is 162 3. A Must filled setting 	Specify the trap Server Port . You can fill in any port number. But you must ensure the port number is not to be used. <i>Value Range: 1 ~ 65535.</i>
SNMP Version	<ol style="list-style-type: none"> 1. v1 is selected by default 	Select the version for the trap Selected the v1 . The configuration screen will provide the version 1 must filled items.

5G NR M2M Gateway

		<p>Selected the v2c. The configuration screen will provide the version 2c must filled items.</p> <p>Selected the v3. The configuration screen will provide the version 3 must filled items.</p>
Community Name	<p>1. A v1 and v2c Must filled setting</p> <p>2. String format: any text</p>	<p>Specify the Community Name for this version 1 or version v2c trap.</p> <p>Value Range: 1 ~ 32 characters.</p>
User Name	<p>1. A v3 Must filled setting</p> <p>2. String format: any text</p>	<p>Specify the User Name for this version 3 trap.</p> <p>Value Range: 1 ~ 32 characters.</p>
Password	<p>1. A v3 Must filled setting</p> <p>2. String format: any text</p>	<p>When your Privacy Mode is authNoPriv or authPriv, you must specify the Password for this version 3 trap.</p> <p>Value Range: 8 ~ 64 characters.</p>
Privacy Mode	<p>1. A v3 Must filled setting</p> <p>2. noAuthNoPriv is selected by default</p>	<p>Specify the Privacy Mode for this version 3 trap.</p> <p>Selected the noAuthNoPriv. You do not use any authentication types and encryption protocols.</p> <p>Selected the authNoPriv. You must specify the Authentication and Password.</p> <p>Selected the authPriv. You must specify the Authentication, Password, Encryption and Privacy Key.</p>
Authentication	<p>1. A v3 Must filled setting</p> <p>2. None is selected by default</p>	<p>When your Privacy Mode is authNoPriv or authPriv, you must specify the Authentication types for this version 3 trap.</p> <p>Selected the authentication types MD5/ SHA-1 to use.</p>
Encryption	<p>1. A v3 Must filled setting</p> <p>2. None is selected by default</p>	<p>When your Privacy Mode is authPriv, you must specify the Encryption protocols for this version 3 trap.</p> <p>Selected the encryption protocols DES / AES to use.</p>
Privacy Key	<p>1. A v3 Must filled setting</p> <p>2. String format: any text</p>	<p>When your Privacy Mode is authPriv, you must specify the Privacy Key (8 ~ 64 characters) for this version 3 trap.</p>
Enable	<p>1. The box is checked by default</p>	<p>Click Enable to enable this trap receiver.</p>
Save	N/A	<p>Click the Save button to save the configuration. But it does not apply to SNMP functions. When you return to the SNMP main page. It will show “Click on save button to apply your changes” remind user to click main page Save button.</p>
Undo	N/A	<p>Click the Undo button to cancel the settings.</p>
Back	N/A	<p>Click the X button to return to last page.</p>

Specify SNMP MIB-2 System

5G NR M2M Gateway

If required, you can also specify the required information for the MIB-2 System.

SNMP MIB-2 System	
Item	Setting
▶ sysContact	<input type="text"/>
▶ sysLocation	<input type="text"/>

SNMP MIB-2 System Configuration		
Item	Value setting	Description
sysContact	<ol style="list-style-type: none"> 1. An Optional filled setting 2. String format: any text 	Specify the contact information for MIB-2 system. <u>Value Range: 0 ~ 64 characters.</u>
sysLocation	<ol style="list-style-type: none"> 1. An Optional filled setting 2. String format: any text 	Specify the location information for MIB-2 system. <u>Value Range: 0 ~ 64 characters.</u>

Edit SNMP Options

If you use some particular private MIB, you must fill the enterprise name, number and OID.

Options	
Item	Setting
▶ Enterprise Name	<input type="text" value="Default"/>
▶ Enterprise Number	<input type="text" value="12823"/>
▶ Enterprise OID	1.3.6.1.4.1. <input type="text" value="12823.4.4.9"/>

Options		
Item	Value setting	Description
Enterprise Name	<ol style="list-style-type: none"> 1. The default value is Default 2. A Must filled setting 3. String format: any text 	Specify the Enterprise Name for the particular private MIB. <u>Value Range: 1 ~ 10 characters, and only string with A~Z, a~z, 0~9, '-', '_'.</u>
Enterprise Number	<ol style="list-style-type: none"> The default value is 12823 (Default Enterprise Number) 2. A Must filled setting 3. String format: any 	Specify the Enterprise Number for the particular private MIB. <u>Value Range: 1 ~ 2080768.</u>

5G NR M2M Gateway

	number	
Enterprise OID	<p>1. The default value is 1.3.6.1.4.1.12823.4.4.9 (Default Enterprise OID)</p> <p>2. A Must filled setting</p> <p>3. String format: any legal OID</p>	<p>Specify the Enterprise OID for the particular private MIB.</p> <p>The range of the each OID number is 1-2080768.</p> <p>The maximum length of the enterprise OID is 31.</p> <p>The seventh number must be identical with the enterprise number.</p>
Save	N/A	Click the Save button to save the configuration and apply your changes to SNMP functions.
Undo	N/A	Click the Undo button to cancel the settings.

5G NR M2M Gateway

6.1.4 Telnet & SSH

A command-line interface (CLI), also known as command-line user interface, and console user interface are means of interacting with a computer program where the user (or client) issues commands to the program in the form of successive lines of text (command lines). The interface is usually implemented with a command line shell, which is a program that accepts commands as text input and converts commands to appropriate operating system functions. Programs with command-line interfaces are generally easier to automate via scripting. The device supports both Telnet and SSH (Secure Shell) CLI with default service port 23 and 22, respectively.

Telnet & SSH Scenario

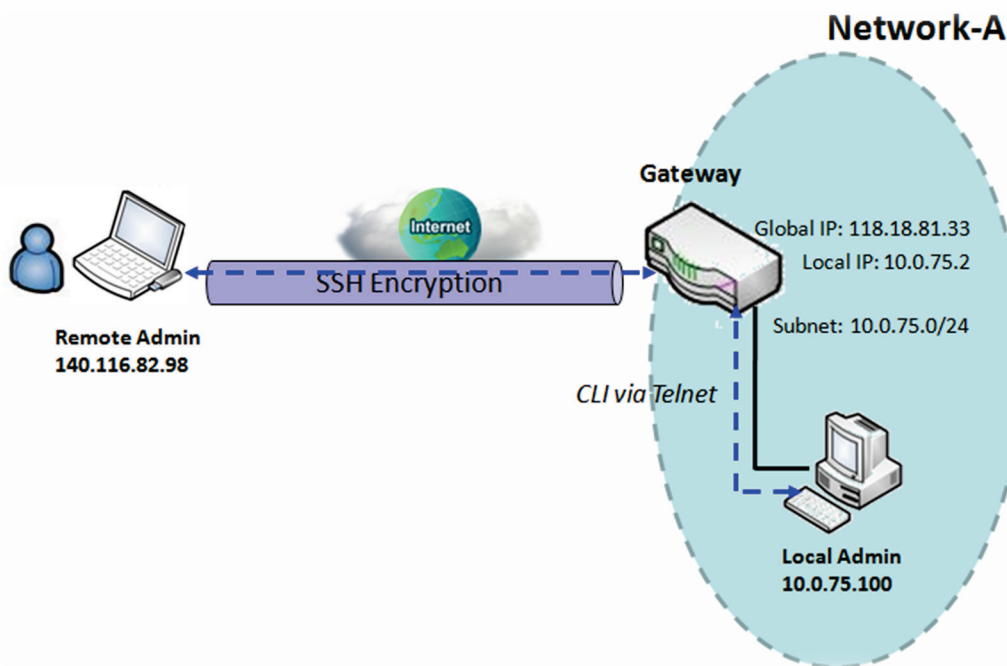

Scenario Application Timing

When the administrator of the gateway wants to manage it from remote site in the Intranet or Internet, he may use "Telnet with CLI" function to do that by using "Telnet" or "SSH" utility.

Scenario Description

The Local Admin or the Remote Admin can manage the Gateway by using "Telnet" or "SSH" utility with privileged user name and password.

The data packets between the Local Admin and the Gateway or between the Remote Admin and the Gateway can be plain texts or encrypted texts. Suggest they are plain texts in the Intranet for Local Admin to use "Telnet" utility, and encrypted texts in the Internet for Remote Admin to use "SSH" utility.

5G NR M2M Gateway

Parameter Setup Example

Following table lists the parameter configuration as an example for the Gateway in above diagram with "Telnet with CLI" enabling at LAN and WAN interfaces.

Use default value for those parameters that are not mentioned in the table.

Configuration Path	[Telnet & SSH]-[Configuration]
Telnet	LAN: <input checked="" type="checkbox"/> Enable WAN: <input type="checkbox"/> Enable Service Port: 23
SSH	LAN: <input checked="" type="checkbox"/> Enable WAN: <input checked="" type="checkbox"/> Enable Service Port: 22

Scenario Operation Procedure

In above diagram, "Local Admin" or "Remote Admin" can manage the "Gateway" in the Intranet or Internet. The "Gateway" is the gateway of Network-A, and the subnet of its Intranet is 10.0.75.0/24. It has the IP address of 10.0.75.2 for LAN interface and 118.18.81.33 for WAN-1 interface. It serves as a NAT gateway.

The "Local Admin" in the Intranet uses "Telnet" utility with privileged account to login the Gateway.

Or the "Remote Admin" in the Internet uses "SSH" utility with privileged account to login the Gateway.

The administrator of the gateway can control the device as like he is in front of the gateway.

5G NR M2M Gateway

Telnet & SSH Setting

Go to Administration > Configure & Manage > Telnet & SSH tab.

The Telnet & SSH setting allows administrator to access this device through the traditional Telnet or SSH Telnet program. Before you can telnet (login) to the device, please configure the related settings with care.

The screenshot shows a configuration window titled "Configuration" with "Save" and "Undo" buttons. It contains two sections: "Telnet" and "SSH". Each section has "LAN" and "WAN" enable checkboxes, a dropdown menu, and a "Service Port" input field. For Telnet, the Service Port is 23. For SSH, the Service Port is 22.

Item	Setting
Telnet	LAN <input checked="" type="checkbox"/> Enable WAN <input type="checkbox"/> Enable (WAN-1 <input checked="" type="checkbox"/> WAN-4 <input type="checkbox"/>) [Dropdown] Service Port <input type="text" value="23"/>
SSH	LAN <input checked="" type="checkbox"/> Enable WAN <input type="checkbox"/> Enable (WAN-1 <input checked="" type="checkbox"/> WAN-4 <input type="checkbox"/>) [Dropdown] Service Port <input type="text" value="22"/>

Configuration		
Item	Value setting	Description
Telnet	<ol style="list-style-type: none">The LAN Enable box is checked by default.By default Service Port is 23.	Check the Enable box to activate the Telnet function for connecting from LAN or WAN interfaces. You can set which number of Service Port you want to provide for the corresponding service. Value Range: 1 ~65535.
SSH	<ol style="list-style-type: none">The LAN Enable box is checked by default.By default Service Port is 22.	Check the Enable box to activate the SSH Telnet function for connecting from LAN or WAN interfaces. You can set which number of Service Port you want to provide for the corresponding service. Value Range: 1 ~65535.
Save	N/A	Click Save to save the settings
Undo	N/A	Click Undo to cancel the settings

Note: The Telnet/SSH login password is the same one as the administrator's login password for the device web GUI.

5G NR M2M Gateway

6.2 System Operation

System Operation allows the network administrator to manage system, settings such as web-based utility access password change, system information, system time, system log, firmware/configuration backup & restore, and reset & reboot.

6.2.1 Password & MMI

Go to **Administration > System Operation > Password & MMI** tab.

Setup Host Name

Host Name screen allows network administrator to setup / change the host name of the gateway. Click the **Modify** button and provide the new username setting.

Item	Setting
▶ Host Name	<input type="text"/>

Username Configuration		
Item	Value setting	Description
Host Name	1. An Optional setting 2. It is blanked by default	Enter the host name of the gateway.
Save	N/A	Click Save button to save the settings
Undo	N/A	Click Undo button to cancel the settings

Change UserName

Username screen allows network administrator to change the web-based MMI login account to access gateway. Click the **Modify** button and provide the new username setting.

Item	Setting
▶ Username	admin <input type="button" value="Modify"/>
▶ New Username	<input type="text"/>
▶ Password	<input type="text"/>

5G NR M2M Gateway

Username Configuration		
Item	Value setting	Description
Username	1. The default Username for web-based MMI is 'admin'.	Display the current MMI login account (Username).
New Username	String: any text	Enter new Username to replace the current setting.
Password	String: any text	Enter current password to verify if you have the permission to change the username setting.
Save	N/A	Click Save button to save the settings
Undo	N/A	Click Undo button to cancel the settings

Change Password

Change password screen allows network administrator to change the web-based MMI login password to access gateway.

Password
⏪ ⏩ ✕

Item	Setting
▶ Old Password	<input type="text"/>
▶ New Password	<input type="text"/> <div style="color: red; font-size: small; margin-top: 2px;"> (NOTE: The password must be at least 10 characters long, and must contain at least 1 English letter and 1 number. The password cannot be the same as the login account.) </div>
▶ New Password Confirmation	<input type="text"/>

Password Configuration		
Item	Value setting	Description
Old Password	1. String: any text 2. The default password for web-based MMI is 'admin'.	Enter the current password to enable you unlock to change password.
New Password	String: any text	Enter new password NOTE: There are some limitation on setting the new password for enhancing the security. The password length must be at least 10 characters, and there must be at least one English character and one numeric character. Beside, the new password must be different to the existing one.
New Password Confirmation	String: any text	Enter new password again to confirm
Save	N/A	Click Save button to save the settings
Undo	N/A	Click Undo button to cancel the settings

5G NR M2M Gateway

Change MMI Setting for Accessing

This is the gateway’s web-based MMI access which allows administrator to access the gateway for management. The gateway’s web-based MMI will automatically logout when the idle time has elapsed. The setting allows administrator to enable automatic logout and set the logout idle time. When the login timeout is disabled, the system won’t logout the administrator automatically.

Item	Setting
▶ Login	Password-Guessing Attack & MAX: <input type="text" value="3"/> (times)
▶ Login Timeout	<input checked="" type="checkbox"/> Enable <input type="text" value="300"/> (seconds)
▶ GUI Access Protocol	<input type="text" value="http/https"/> ▼
▶ External Authentication	<input type="checkbox"/> Enable Type <input type="text" value="RADIUS"/> ▼ Primary Server <input type="text" value="--- Option ---"/> ▼ Secondary Server <input type="text" value="--- Option ---"/> ▼
▶ HTTPs Certificate Setup	<input checked="" type="radio"/> default <input type="radio"/> Select from Certificate List Certificate: <input type="text" value=""/> ▼ Key: <input type="text" value=""/> ▼
▶ HTTP Compression	<input type="checkbox"/> gzip <input type="checkbox"/> deflate
▶ HTTP Binding	<input checked="" type="checkbox"/> DHCP 1
▶ System Boot Mode	<input type="text" value="Normal Mode"/> ▼

MMI Configuration		
Item	Value setting	Description
Login	3 times is set by default	Enter the login trial counting value. Value Range: 3 ~ 10. If someone tried to login the web GUI with incorrect password for more than the counting value, an warning message “ Already reaching maximum Password-Guessing times, please wait a few seconds! ” will be displayed and ignore the following login trials.
Login Timeout	The Enable box is checked, and 300 is set by default.	Check the Enable box to activate the auto logout function, and specify the maximum idle time as well. Value Range: 30 ~ 65535.
GUI Access Protocol	http/https is selected by default.	Select the protocol that will be used for GUI access. It can be http/https , http only , or https only .
HTTPs Certificate Setup	The default box is selected by default	If the https Access Protocol is selected, the HTTPs Certificate Setup option will be available for further configuration. You can leave it as default or select a expected certificate and key from the drop down list. Refer to Object Definition > Certificate Section for the Certificate configuration.

5G NR M2M Gateway

HTTP Compression	The box is unchecked by default.	Check the box (gzip , or deflate) if any comprerssion method is preferred.
HTTP Binding	1. An Optional setting 2. DHCP-1 is checked by default	Select the DHCP Server to bind with http access.
System Boot Mode	Normal Mode is selected by default.	<p>Select the system boot mode that will be adopted to boot up the device.</p> <p>Normal Mode: It takes longer boot up time, with complete firmware image check during the device booting.</p> <p>Fast Mode: It takes shorter boot up time, without checking the firmware image during the device booting.</p> <p>Quick Mode: It takes the shortest boot up time, without checking the firmware image and creating the internal database for User/Group/Captive Portal functions.</p> <p>Note: Use Quick Mode with care, once selected, the User/Group/Captive Portal function will become non-functional.</p>
Save	N/A	Click Save button to save the settings
Undo	N/A	Click Undo button to cancel the settings

5G NR M2M Gateway

6.2.2 System Information

System Information screen gives network administrator a quick look up on the device information for the purchased gateway.

Go to **Administration > System Operation > System Information** tab.

System Information	
Item	Setting
▶ Model Name	VHG87BAM_0T001
▶ Device Serial Number	
▶ Kernel Version	2.6.36
▶ FW Version	0000Y90.J31_e32.BETA_04021700
▶ System Time	Thu, 18 Apr 2019 16:18:16 +0800
▶ Device Up-Time	15day 22hr 30min 35sec

System Information		
Item	Value Setting	Description
Model Name	N/A	It displays the model name of this product.
Device Serial Number	N/A	It displays the serial number of this product.
Kernel Version	N/A	It displays the Linux kernel version of the product
FW Version	N/A	It displays the firmware version of the product
Memory Usage	N/A	It displays the percentage of device memory utilization.
System Time	N/A	It displays the current system time that you browsed this web page.
Device Up-Time	N/A	It displays the statistics for the device up-time since last boot up.
Refresh	N/A	Click the Refresh button to update the system Information immediately.

5G NR M2M Gateway

6.2.3 System Time

The gateway provides manually setup and auto-synchronized approaches for the administrator to setup the system time for the gateway. The time supported synchronization methods can be Time Server, Manual, PC, Cellular Module, or GPS Signal. Select the method first, and then configure rest settings.

Instead of manually configuring the system time for the gateway, there are two simple and quick solutions for you to set the correct time information and set it as the system time for the gateway.

The first one is “Sync with Timer Server”. Based on your selection of time zone and time server in above time information configuration window, system will communicate with time server by NTP Protocol to get system date and time after you click on the **Synchronize immediately** button.

The second one is “Sync with my PC”. Select the method and the system will synchronize its date and time to the time of the administration PC.

Go to **Administration > System Operation > System Time** tab.

Synchronize with Time Server

Item	Setting
▶ Synchronization method	Time Server ▾
▶ Time Zone	(GMT+00:00) Greenwich Mean Time: Dublin, Edinburgh, Lisbon, London ▾
▶ Auto-synchronization	Time Server: <input type="text"/> Available Time Servers (RFC-868): Auto ▾
▶ Daylight Saving Time	<input type="checkbox"/> Enable
▶ NTP Service	<input type="checkbox"/> Enable
▶ Synchronize immediately	Active

System Time Information		
Item	Value Setting	Description
Synchronization method	1. A Must-filled item. 2. Time Server is selected by default.	Select the Time Server as the synchronization method for the system time.
Time Zone	1. A Must-filled item. 2. GMT+00 :00 is selected by default.	Select a time zone where this device locates.
Auto-synchronization	1. A Must-filled item. 2. Auto is selected by default.	Enter the IP or FQDN for the NTP time server you expected, or leave it as auto mode so that the available server will be used for time synchronization one by one.
Daylight Saving	1. It is an optional item.	Check the Enable button to activate the daylight saving function.

5G NR M2M Gateway

Time	2. Un-checked by default	When you enabled this function, you have to specify the start date and end date for the daylight saving time duration.
NTP Service	1. It is an optional item. 2. Un-checked by default	Check the Enable button to activate the NTP Service function. When you enabled this function, the gateway can provide NTP server service for its local connected devices.
Synchronize immediately	N/A	Click the Active button to synchronize the system time with specified time server immediately.
Save	N/A	Click the Save button to save the settings.
Refresh	N/A	Click the Refresh button to update the system time immediately.

Note: Remember to select a correct time zone for the device, otherwise, you will just get the UTC (Coordinated Universal Time) time, not the local time for the device.

Synchronize with Manually Setting

System Time Configuration
⏪ ⏩ ✕

Item	Setting
▶ Synchronization method	Manual ▾
▶ Time Zone	(GMT+00:00) Greenwich Mean Time: Dublin, Edinburgh, Lisbon, London ▾
▶ Daylight Saving Time	<input type="checkbox"/> Enable
▶ Set Date & Time Manually	2019 ▾ / April ▾ / 18 ▾ (Year/Month/Day)
	16 ▾ : 24 ▾ : 27 ▾ (Hour:Minute:Second)
▶ NTP Service	<input type="checkbox"/> Enable

System Time Information		
Item	Value Setting	Description
Synchronization method	1. A Must-filled item. 2. Time Server is selected by default.	Select the Manual as the synchronization method for the system time. It means administrator has to set the Date & Time manually.
Time Zone	1. A Must-filled item. 2. GMT+00 :00 is selected by default.	Select a time zone where this device locates.
Daylight Saving Time	1. It is an optional item. 2. Un-checked by default	Check the Enable button to activate the daylight saving function. When you enabled this function, you have to specify the start date and end date for the daylight saving time duration.
Set Date & Time Manually	1. It is an optional item.	Manually set the date (Year/Month/Day) and time (Hour:Minute:Second) as the system time.
NTP Service	1. It is an optional item. 2. Un-checked by default	Check the Enable button to activate the NTP Service function. When you enabled this function, the gateway can provide NTP server service for its local connected devices.
Save	N/A	Click the Save button to save the settings.

5G NR M2M Gateway

Synchronize with PC

System Time Configuration	
Item	Setting
▶ Synchronization method	PC ▼
▶ NTP Service	<input type="checkbox"/> Enable
▶ Synchronize immediately	Active

System Time Information		
Item	Value Setting	Description
Synchronization method	1. A Must-filled item. 2. Time Server is selected by default.	Select PC as the synchronization method for the system time to let system synchronize its date and time to the time of the administration PC.
NTP Service	1. It is an optional item. 2. Un-checked by default	Check the Enable button to activate the NTP Service function. When you enabled this function, the gateway can provide NTP server service for its local connected devices.
Synchronize immediately	N/A	Click the Active button to synchronize the system time with specified time server immediately.
Save	N/A	Click the Save button to save the settings.
Refresh	N/A	Click the Refresh button to update the system time immediately.

5G NR M2M Gateway

Synchronize with Cellular Time Service

System Time Configuration	
Item	Setting
▶ Synchronization method	Cellular Module ▾
▶ Time Zone	(GMT+00:00) Greenwich Mean Time: Dublin, Edinburgh, Lisbon, London ▾
▶ NTP Service	<input type="checkbox"/> Enable
▶ Synchronize immediately	Active

System Time Information		
Item	Value Setting	Description
Synchronization method	<ol style="list-style-type: none">1. A Must-filled item.2. Time Server is selected by default.	Select Cellular Module as the synchronization method for the system time to let system synchronize its date and time to the time provided from the connected mobile ISP. Note: this option is only available for the product with Cellular WAN interface.
Time Zone	<ol style="list-style-type: none">1. A Must-filled item.2. GMT+00 :00 is selected by default.	Select a time zone where this device locates.
NTP Service	<ol style="list-style-type: none">1. It is an optional item.2. Un-checked by default	Check the Enable button to activate the NTP Service function. When you enabled this function, the gateway can provide NTP server service for its local connected devices.
Synchronize immediately	N/A	Click the Active button to synchronize the system time with specified time server immediately.
Save	N/A	Click the Save button to save the settings.
Refresh	N/A	Click the Refresh button to update the system time immediately.

5G NR M2M Gateway

Synchronize with GPS Time Service

System Time Configuration	
Item	Setting
▶ Synchronization method	GPS Signal ▼
▶ Time Zone	(GMT+00:00) Greenwich Mean Time: Dublin, Edinburgh, Lisbon, London ▼
▶ NTP Service	<input type="checkbox"/> Enable
▶ Synchronize immediately	Active

System Time Information		
Item	Value Setting	Description
Synchronization method	<ol style="list-style-type: none">1. A Must-filled item.2. Time Server is selected by default.	Select GPS Signal as the synchronization method for the system time to let system synchronize its date and time to the time provided from the GNSS service. Note: this option is only available for the product with GNSS interface.
Time Zone	<ol style="list-style-type: none">1. A Must-filled item.2. GMT+00 :00 is selected by default.	Select a time zone where this device locates.
NTP Service	<ol style="list-style-type: none">1. It is an optional item.2. Un-checked by default	Check the Enable button to activate the NTP Service function. When you enabled this function, the gateway can provide NTP server service for its local connected devices.
Synchronize immediately	N/A	Click the Active button to synchronize the system time with specified time server immediately.
Save	N/A	Click the Save button to save the settings.
Refresh	N/A	Click the Refresh button to update the system time immediately.

5G NR M2M Gateway

6.2.4 System Log

System Log screen contains various event log tools facilitating network administrator to perform local event logging and remote reporting.

Go to **Administration > System Operation > System Log** tab.

Item	Setting
▶ Web Log Type Category	<input checked="" type="checkbox"/> System <input checked="" type="checkbox"/> Attacks <input checked="" type="checkbox"/> Drop <input checked="" type="checkbox"/> Login message <input type="checkbox"/> Debug
▶ Email Alert	<input type="checkbox"/> Enable Server: <input type="text" value="--- Option ---"/> <input type="button" value="Add Object"/> E-mail Addresses: <input type="text"/> Subject: <input type="text"/> Log type Category: <input type="checkbox"/> System <input type="checkbox"/> Attacks <input type="checkbox"/> Drop <input type="checkbox"/> Login message <input type="checkbox"/> Debug
▶ Syslog	<input type="checkbox"/> Enable Server: <input type="text" value="--- Option ---"/> <input type="button" value="Add Object"/> Log type Category: <input type="checkbox"/> System <input type="checkbox"/> Attacks <input type="checkbox"/> Drop <input type="checkbox"/> Login message <input type="checkbox"/> Debug
▶ Log to Storage	<input checked="" type="checkbox"/> Enable Select Device: <input type="text" value="Internal"/> Log file name: <input type="text" value="syslog"/> Split file: <input type="checkbox"/> Enable Size: <input type="text" value="200"/> <input type="text" value="KB"/> Interval: <input type="checkbox"/> Enable <input type="text" value="1440"/> (1 ~ 10080 Minutes) Max Records: <input type="text" value="3000"/> (5~10000) <input type="button" value="Download log file"/> <input type="button" value="clear logs"/> Log type Category: <input checked="" type="checkbox"/> System <input checked="" type="checkbox"/> Attacks <input checked="" type="checkbox"/> Drop <input checked="" type="checkbox"/> Login message <input checked="" type="checkbox"/> Debug

View & Email Log History

View button is provided for network administrator to view log history on the gateway. **Email Now** button enables administrator to send instant Email for analysis.

View & Email Log History		
Item	Value setting	Description
View button	N/A	Click the View button to view Log History in Web Log List Window.
Email Now button	N/A	Click the Email Now button to send Log History via Email instantly.

5G NR M2M Gateway

Web Log List Previous Next First Last Download Clear	
Time	Log
Apr 1 06:01:36	dnsmasq-dhcp[6016]: Ignoring domain amit.com.tw for DHCP host name NB-msnb
Apr 1 06:08:31	dnsmasq-dhcp[6016]: Ignoring domain amit.com.tw for DHCP host name NB-msnb
Apr 1 06:15:30	dnsmasq-dhcp[6016]: Ignoring domain amit.com.tw for DHCP host name NB-msnb
Apr 1 06:22:06	dnsmasq-dhcp[6016]: Ignoring domain amit.com.tw for DHCP host name NB-msnb
Apr 1 06:28:42	dnsmasq-dhcp[6016]: Ignoring domain amit.com.tw for DHCP host name NB-msnb
Apr 1 06:35:42	dnsmasq-dhcp[6016]: Ignoring domain amit.com.tw for DHCP host name NB-msnb
Apr 1 06:42:20	dnsmasq-dhcp[6016]: Ignoring domain amit.com.tw for DHCP host name NB-msnb

Web Log List Window		
Item	Value Setting	Description
Time column	N/A	It displays event time stamps
Log column	N/A	It displays Log messages

Web Log List Button Description		
Item	Value setting	Description
Previous	N/A	Click the Previous button to move to the previous page.
Next	N/A	Click the Next button to move to the next page.
First	N/A	Click the First button to jump to the first page.
Last	N/A	Click the Last button to jump to the last page.
Download	N/A	Click the Download button to download log to your PC in tar file format.
Clear	N/A	Click the Clear button to clear all log.
Back	N/A	Click the Back button to return to the previous page.

Web Log Type Category

Web Log Type Category screen allows network administrator to select the type of events to log and be displayed in the Web Log List Window as described in the previous section. Click on the View button to view Log History in the Web Log List window.

Web Log Type Category	<input checked="" type="checkbox"/> System	<input checked="" type="checkbox"/> Attacks	<input checked="" type="checkbox"/> Drop	<input checked="" type="checkbox"/> Login message	<input type="checkbox"/> Debug
-----------------------	--	---	--	---	--------------------------------

Web Log Type Category Setting Window		
Item	Value Setting	Description
System	Checked by default	Check to log system events and to display in the Web Log List window.
Attacks	Checked by default	Check to log attack events and to display in the Web Log List window.
Drop	Checked by default	Check to log packet drop events and to display in the Web Log List window.
Login message	Checked by default	Check to log system login events and to display in the Web Log List window.
Debug	Un-checked by default	Check to log debug events and to display in the Web Log List window.

5G NR M2M Gateway

Email Alert

Email Alert screen allows network administrator to select the type of event to log and be sent to the destined Email account.

▶ Email Alert

Enable
 Server: --- Option --- ▼ Add Object
 E-mail Addresses:
 Subject:
 Log type Category: System Attacks Drop Login message Debug

Email Alert Setting Window		
Item	Value Setting	Description
Enable	Un-checked by default	Check Enable box to enable sending event log messages to destined Email account defined in the E-mail Addresses blank space.
Server	N/A	Select one email server from the Server dropdown box to send Email. If none has been available, click the Add Object button to create an outgoing Email server. You may also add an outgoing Email server from Object Definition > External Server > External Server tab.
E-mail address	String : email format	Enter the recipient's Email address. Separate Email addresses with comma ',' or semicolon ';' Enter the Email address in the format of ' <i>myemail@domain.com</i> '
Subject	String : any text	Enter an Email subject that is easy for you to identify on the Email client.
Log type category	Default unchecked	Select the type of events to log and be sent to the designated Email account. Available events are System, Attacks, Drop, Login message, and Debug.

5G NR M2M Gateway

Syslogd

Syslogd screen allows network administrator to select the type of event to log and be sent to the designated Syslog server.

Syslogd
 Enable Server:

Log type Category: System Attacks Drop Login message Debug

Syslogd Setting Window		
Item	Value Setting	Description
Enable	Un-checked by default	Check Enable box to activate the Syslogd function, and send event logs to a syslog server
Server	N/A	Select one syslog server from the Server dropdown box to sent event log to. If none has been available, click the Add Object button to create a system log server. You may also add an system log server from the Object Definition > External Server > External Server tab.
Log type category	Un-checked by default	Select the type of event to log and be sent to the destined syslog server. Available events are System, Attacks, Drop, Login message, and Debug.

Log to Storage

Log to Storage screen allows network administrator to select the type of events to log and be stored at an internal or an external storage.

Log to Storage
 Enable

Select Device:

Log file name:

Split file: Enable Size:

Interval: Enable (1 ~ 10080 Minutes)

Max Records: (5~10000)

Log type Category: System Attacks Drop Login message Debug

Log to Storage Setting Window		
Item	Value Setting	Description
Enable	Un-checked by default	Check to enable sending log to storage.
Select Device	Internal is selected by default	Select internal or external storage.
Log file name	Un-checked by default	Enter log file name to save logs in designated storage.
Split file Enable	Un-checked by default	Check enable box to split file whenever log file reaching the specified limit.
Split file Size	200 KB is set by default	Enter the file size limit for each split log file. Value Range: 10 ~ 1000.
Interval Enable	Un-checked by default	Check enable box to enable the log interval setting.
Log Interval	1440 is set by default	Enter the log interval setting. Value Range: 1 ~ 10080 Minute.
Max Records	3000 is set by default	Enter the maximum number of records to be stored in the log storage. Value Range: 5 ~ 10000.

5G NR M2M Gateway

Log type category	Un-checked by default	Check which type of logs to send: System, Attacks, Drop, Login message, Debug
-------------------	-----------------------	---

Log to Storage	Button	Description
Download log file	N/A	Click the Download log file button to download log files to a log.tar file.
Clear Logs	N/A	Click the Clear logs button to delete the log files from the storage.

5G NR M2M Gateway

6.2.5 Backup & Restore

In the Backup & Restore window, you can upgrade the device firmware when new firmware is available and also backup / restore the device configuration.

In addition to the factory default settings, you can also customize a special configuration setting as a customized default value. With this customized default value, you can reset the device to the expected default setting if needed.

Go to **Administration > System Operation > Backup & Restore** tab.

FW Backup & Restore	
Item	Setting
▶ FW Upgrade	Via Web UI ▾ FW Upgrade
▶ Backup Configuration Settings	Download ▾ Via Web UI
▶ Auto Restore Configuration	<input type="checkbox"/> Enable Save Conf. Clean Conf. Conf. Info.
▶ Self-defined Logo	Download ▾ Via Web UI Reset
▶ Self-defined CSS	Edit : Download ▾ Via Web UI Reset

FW Backup & Restore		
Item	Value Setting	Description
FW Upgrade	Via Web UI is selected by default	If new firmware is available, click the FW Upgrade button to upgrade the device firmware via Web UI , or Via Storage . After clicking on the “FW Upgrade” command button, you need to specify the file name of new firmware by using “Browse” button, and then click “Upgrade” button to start the FW upgrading process on this device. If you want to upgrade a firmware which is from GPL policy, please check “Accept unofficial firmware”
Backup Configuration Settings	Download is selected by default	You can backup or restore the device configuration settings by clicking the Via Web UI button. Download : for backup the device configuration to a config.bin file. Upload : for restore a designated configuration file to the device. Via Web UI : to retrieve the configuration file via Web GUI.
Auto Restore Configuration	The Enable box is unchecked by default	Click the Enable button to activate the customized default setting function. Once the function is activated, you can save the expected setting as a customized default setting by clicking the Save Conf. button, or clicking the Clean Conf. button to erase the stored customized configuration.

5G NR M2M Gateway

6.2.6 Reboot & Reset

For some special reason or situation, you may need to reboot the gateway or reset the device configuration to its default value. In addition to perform these operations through the Power ON/OFF, or pressing the reset button on the device panel, you can do it through the web GUI too.

Go to **Administration > System Operation > Reboot & Reset** tab.

In the Reboot & Reset window, you can reboot this device by clicking the “Reboot” button, and reset this device to default settings by clicking the “Reset” button.

System Operation	
Item	Setting
▶ Reboot	Now <input type="button" value="Reboot"/>
▶ Reset to Default	<input type="button" value="Reset"/>

System Operation Window		
Item	Value Setting	Description
Reboot	Now is selected by default	Click the Reboot button to reboot the gateway immediately or on a pre-defined time schedule. Now: Reboot immediately Time Schedule: Select a pre-defined auto-reboot time schedule rule to reboot the auto device on a designated tim. To define a time schedule rule, go to Object Definition > Scheduling > Configuration tab.
Reset to Default	N/A	Click the Reset button to reset the device configuration to its default value.

5G NR M2M Gateway

6.3 FTP

The File Transfer Protocol (FTP) is a standard network protocol used to transfer computer files between a client and server on a computer network. FTP is built on a client-server model architecture and uses separate control and data connections between the client and the server. FTP users may authenticate themselves with a clear-text sign-in protocol, normally in the form of a username and password, but can connect anonymously if the server is configured to allow it.

For secure transmission that protects the username and password, and encrypts the content, FTP is often secured with SSL/TLS (FTPS). Besides, SSH File Transfer Protocol (SFTP) is sometimes also used instead, but is technologically different.

This gateway embedded FTP / SFTP server for administrator to download the log files to his computer or database. In the following two sections, you can configure the FTP server and create the user accounts that can login to the server. After login to the FTP server, you can browse the log directory and have the permission to download the stored log files and delete the files you have downloaded to make more storage space for further data logs.

The available log files can be system logs (refer to Administration > System Operation > System Log), Network Packets (refer to Administrator > Diagnostic > Packet Analyzer), Data Log (refer to Field Communication > Data Logging > Log File Management), and GNSS Log (refer to Service > Location Tracking > GNSS). With proper configuration for the various log functions that supported on your purchased product, you can download the log via FTP / SFTP connections.

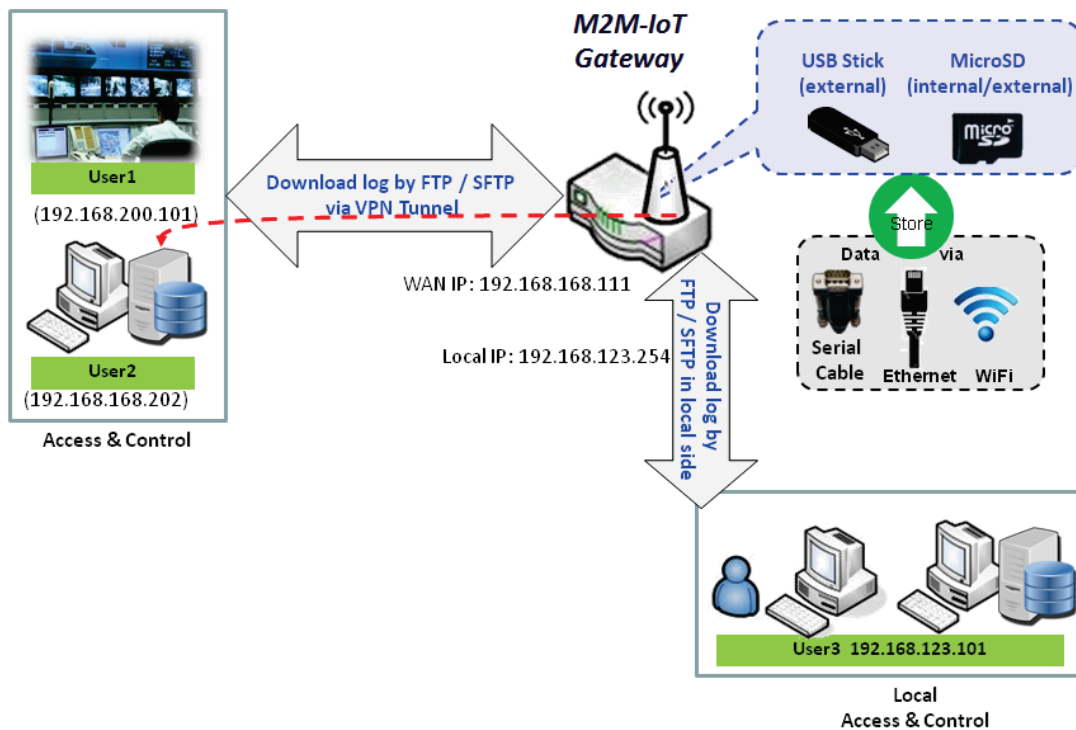

5G NR M2M Gateway

6.3.1 Server Configuration

This section allows user to setup the embedded FTP and SFTP server for retrieving the interested log files.

Go to **Administration > FTP > Server Configuration** tab.

Enable FTP Server

Item	Setting
▶ FTP	<input checked="" type="checkbox"/> Enable
▶ FTP Port	<input type="text" value="21"/>
▶ Timeout	<input type="text" value="300"/> second(s)(60-7200)
▶ Max. Connections per IP	<input type="text" value="2"/> ▼
▶ Max. FTP Clients	<input type="text" value="5"/> ▼
▶ PASV Mode	<input type="checkbox"/> Enable
▶ Port Range of PASV Mode	<input type="text" value="50000"/> ~ <input type="text" value="50031"/>
▶ Auto Report External IP in PASV Mode	<input type="checkbox"/> Enable
▶ ASCII Transfer Mode	<input type="checkbox"/> Enable
▶ FTPS(FTP over SSL/TLS)	<input type="checkbox"/> Enable

Configuration Item	Value setting	Description
FTP	The box is unchecked by default.	Check Enable box to activate the embedded FTP Server function. With the FTP Server enabled, you can retrieve or delete the stored log files via FTP connection. Note: The embedded FTP Server is only for log downloading, so no any write permission is implemented for user file upload to the storage.
FTP Port	Port 21 is set by default	Specify a port number for FTP connection. The gateway will listen for incoming FTP connections on the specified port. Value Range: 1 ~ 65535.
Timeout	300 seconds is set by default.	Specify the maximum timeout interval for the FTP connection. Supported range is 60 to 7200 seconds.
Max. Connections per IP	2 Clients are set by default.	Specify the maximum number of clients from the same IP address for the FTP connection. Up to 5 clients from the same IP address is supported.
Max. FTP Clients	5 Clients are set by default.	Specify the maximum number of clients for the FTP connection. Up to 32 clients is supported.
PASV Mode	Optional setting	Check the Enable box to activate the support of PASV mode for a FTP connection from FTP clients.
Port Range of	Port 50000 ~ 50031 is set	Specify the port range to allocate for PASV style data connection.

5G NR M2M Gateway

PASV Mode	by default.	Value Range: 1024 ~ 65535.
Auto Report External IP in PASV Mode	Optional setting	Check the Enable box to activate the support of overriding the IP address advertising in response to the PASV command.
ASCII Transfer Mode	Optional setting	Check the Enable box to activate the support of ASCII mode data transfers. Binary mode is supported by default.
FTPS (FTP over SSL/TLS)	Optional setting	Check the Enable box to activate the support of secure connections via SSL/TLS.

Enable SFTP Server

SFTP Server Configuration
Save
▲ ✕

Item	Setting
▶ SFTP	<input type="checkbox"/> Enable via <input type="checkbox"/> LAN via <input type="checkbox"/> WAN (WAN-1 <input type="checkbox"/> WAN-2 <input type="checkbox"/>) <input type="text"/>
▶ SFTP Port	<input type="text" value="22"/>

Configuration		
Item	Value setting	Description
SFTP	The box is unchecked by default.	Check Enable box to activate the embedded SFTP Server function. Furthermore, you can check the granted interface(s) for the SFTP connection, via LAN , WAN , or both. Besides, if any WAN interface is selected, you can further limit the hosts that can access to the WAN port via SFTP. The available options are: any , Specific IP Address , or IP Range . With the SFTP Server enabled, you can retrieve or delete the stored log files via secure SFTP connection.
SFTP Port	Default 22	Specify a port number for SFTP connection. The gateway will listen for incoming SFTP connections on the specified port. Value Range: 1 ~ 65535.

5G NR M2M Gateway

6.3.2 User Account

This section allows user to setup user accounts for logging to the embedded FTP and SFTP server to retrieve the interested fog files.

Go to **Administration > FTP > User Account** tab.

Create/Edit FTP User Accounts

User Account List						
ID	User Name	Password	Directory	Permission	Enable	Actions

When **Add** button is applied, **User Account Configuration** screen will appear.

User Account Configuration	
Item	Setting
User Name	admin
Password
Directory	Browse
Permission	Read/Write
Enable	<input checked="" type="checkbox"/>

Configuration		
Item	Value setting	Description
User Name	String : non-blank string	Enter the user account for login to the FTP server. Value Range: 1 ~ 15 characters.
Password	String : no blank	Enter the user password for login to the FTP server.
Directory	N/A	Select a root directory after user login.
Permission	Read/Write is selected by default.	Select the Read/write permission. Note: The embedded FTP Server is only for log downloading, so no any write permission is implemented for user file upload to the storage, even Read/Write option is selected.
Enable	The box is checked by default.	Check the box to activate the FTP user account.

5G NR M2M Gateway

6.4 Diagnostic

This gateway supports simple network diagnosis tools for the administrator to troubleshoot and find the root cause of the abnormal behavior or traffics passing through the gateway. There can be a Packet Analyzer to help record the packets for a designated interface or specific source/destination host, and another Ping and Tracert tools for testing the network connectivity issues.

6.4.1 Diagnostic Tools

The Diagnostic Tools provide some frequently used network connectivity diagnostic tools (approaches) for the network administrator to check the device connectivity.

Go to **Administration > Diagnostic > Diagnostic Tools** tab.

Item	Setting
▶ Ping Test	Host IP: <input type="text"/> Outer Interface: <input type="text" value="Auto"/> LAN Source: <input type="text" value="Default"/> <input type="button" value="Ping"/>
▶ Tracert Test	Host IP: <input type="text"/> Interface: <input type="text" value="Auto"/> <input type="text" value="UDP"/> <input type="button" value="Tracert"/>
▶ Speed Test	Interface: <input type="text" value="Auto"/> mode: <input type="text" value="DL+UL"/> <input type="checkbox"/> SSL <input type="button" value="Test"/>
▶ Wake on LAN	<input type="text"/> <input type="button" value="Wake up"/>

Diagnostic Tools		
Item	Value setting	Description
Ping Test	Optional Setting	This allows you to specify an IP / FQDN, the Outer interface (auto, WAN, LAN, or VLAN), and LAN source (default, LAN, or VLAN) as well, so system will try to ping the specified device to test whether it is alive after clicking on the Ping button. A test result window will appear beneath it.
Tracert Test	Optional setting	Trace route (tracert) command is a network diagnostic tool for displaying the route (path) and measuring transit delays of packets across an IP network. Trace route proceeds until all (three) sent packets are lost for more than twice, then the connection is lost and the route cannot be evaluated. First, you need to specify an IP / FQDN, the test interface (LAN, WAN, or Auto) and the protocol (UDP or ICMP), and by default, it is UDP . Then, system will try to trace the specified host to test whether it is alive after clicking on Tracert button. A test result window will appear beneath it.
Speed Test	Optional setting	This allow you to do q quick speed test for verifying the connectivity on specific interface.
Wake on LAN	Optional setting	Wake on LAN (WOL) is an Ethernet networking standard that allows a computer to be turned on or awakened by a network message. You can specify the MAC address of the computer, in your LAN network, to be remotely turned on by clicking on the Wake up command button.
Save	N/A	Click the Save button to save the configuration.

5G NR M2M Gateway

5G NR M2M Gateway

6.4.2 Packet Analyzer

The Packet Analyzer can capture packets depend on user settings. User can specify interfaces to capture packets and filter by setting rule. Ensure the log storage is available (either embedded SD-Card or external USB Storage), otherwise **Packet Analyzer** cannot be enabled.

Go to **Administration > Diagnostic > Packet Analyzer** tab.

Configuration	
Item	Setting
▶ Packet Analyzer	<input type="checkbox"/> Enable
▶ File Name	<input type="text"/>
▶ Split Files	<input type="checkbox"/> Enable File Size : <input type="text" value="200"/> <input type="text" value="KB"/> ▾
▶ Packet Interfaces	<input type="checkbox"/> WAN-1 <input type="checkbox"/> WAN-2 <input type="checkbox"/> WAN-3 <input type="checkbox"/> WAN-4 <input type="checkbox"/> ASY <input type="text" value="Binary Mode"/> ▾ 2.4G : <input type="checkbox"/> VAP-1 <input type="checkbox"/> VAP-2 <input type="checkbox"/> VAP-3 <input type="checkbox"/> VAP-4 <input type="checkbox"/> VAP-5 <input type="checkbox"/> VAP-6 <input type="checkbox"/> VAP-7 <input type="checkbox"/> VAP-8 5G : <input type="checkbox"/> VAP-1 <input type="checkbox"/> VAP-2 <input type="checkbox"/> VAP-3 <input type="checkbox"/> VAP-4 <input type="checkbox"/> VAP-5 <input type="checkbox"/> VAP-6 <input type="checkbox"/> VAP-7 <input type="checkbox"/> VAP-8

Configuration		
Item	Value setting	Description
Packet Analyzer	The box is unchecked by default.	Check Enable box to activate the Packet Analyzer function. If you cannot enable the checkbox, please check if the storage is available or not. Plug in the USB storage and then enable the Package Analyzer function.
File Name	1. An optional setting 2. Blank is set by default, and the default file name is <Interface>_<Date>_<index>.	Enter the file name to save the captured packets in log storage. If Split Files option is also enabled, the file name will be appended with an index code “_<index>”. The extension file name is .pcap .
Split Files	1. An optional setting 2. The default value of File Size is 200 KB.	Check enable box to split file whenever log file reaching the specified limit. If the Split Files option is enabled, you can further specify the File Size and Unit for the split files. Value Range: 10 ~ 99999. NOTE: File Size cannot be less than 10 KB
Packet Interfaces	An optional setting	Define the interface(s) that Packet Analyzer should work on. At least, one interface is required, but multiple selections are also accepted. The supported interfaces can be: <ul style="list-style-type: none"> ● WAN: When the WAN is enabled at Physical Interface, it can be selected here. ● ASY: This means the serial communication interface. It is used to capture packets appearing in the Field Communication. Therefore, it can only be selected when specific field

5G NR M2M Gateway

		<p>communication protocol, like Modbus, is enabled. Select Binary mode or String mode for the serial interface.</p> <ul style="list-style-type: none"> ● VAP: This means the virtual AP. When WiFi and VAP are enabled, it can be selected here.
Save	N/A	Click the Save button to save the configuration.
Undo	N/A	Click the Undo button to restore what you just configured back to the previous setting.

Once you enabled the Packet Analyzer function on specific Interface(s), you can further specify some filter rules to capture the packets which matched the rules.

☰ Capture Filters
⬆️ ✖️

Item	Setting
▶ Filter	<input type="checkbox"/> Enable
▶ Source MACs	<div style="background-color: #f0f0f0; height: 30px; width: 100%;"></div>
▶ Source IPs	<div style="background-color: #f0f0f0; height: 30px; width: 100%;"></div>
▶ Source Ports	<div style="background-color: #f0f0f0; height: 30px; width: 100%;"></div>
▶ Destination MACs	<div style="background-color: #f0f0f0; height: 30px; width: 100%;"></div>
▶ Destination IPs	<div style="background-color: #f0f0f0; height: 30px; width: 100%;"></div>
▶ Destination Ports	<div style="background-color: #f0f0f0; height: 30px; width: 100%;"></div>

Capture Filters		
Item	Value setting	Description
Filter	Optional setting	Check Enable box to activate the Capture Filter function.
Source MACs	Optional setting	Define the filter rule with Source MACs , which means the source MAC address of packets. Packets which match the rule will be captured. Up to 10 MACs are supported, but they must be separated with “;”, e.g. AA:BB:CC:DD:EE:FF; 11:22:33:44:55:66 The packets will be captured when match any one MAC in the rule.
Source IPs	Optional setting	Define the filter rule with Source IPs , which means the source IP address of packets. Packets which match the rule will be captured. Up to 10 IPs are supported, but they must be separated with “;”,

5G NR M2M Gateway

		e.g. 192.168.1.1; 192.168.1.2 The packets will be captured when match any one IP in the rule.
Source Ports	Optional setting	Define the filter rule with Source Ports , which means the source port of packets. The packets will be captured when match any port in the rule. Up to 10 ports are supported, but they must be separated with “;”, e.g. 80; 53 Value Range: 1 ~ 65535.
Destination MACs	Optional setting	Define the filter rule with Destination MACs , which means the destination MAC address of packets. Packets which match the rule will be captured. Up to 10 MACs are supported, but they must be separated with “;”, e.g. AA:BB:CC:DD:EE:FF; 11:22:33:44:55:66 The packets will be captured when match any one MAC in the rule.
Destination IPs	Optional setting	Define the filter rule with Destination IPs , which means the destination IP address of packets. Packets which match the rule will be captured. Up to 10 IPs are supported, but they must be separated with “;”, e.g. 192.168.1.1; 192.168.1.2 The packets will be captured when match any one IP in the rule.
Destination Ports	Optional setting	Define the filter rule with Destination Ports , which means the destination port of packets. The packets will be captured when match any port in the rule. Up to 10 ports are supported, but they must be separated with “;”, e.g. 80; 53 Value Range: 1 ~ 65535.

5G NR M2M Gateway

Chapter 7 Service

7.1 Cellular Toolkit

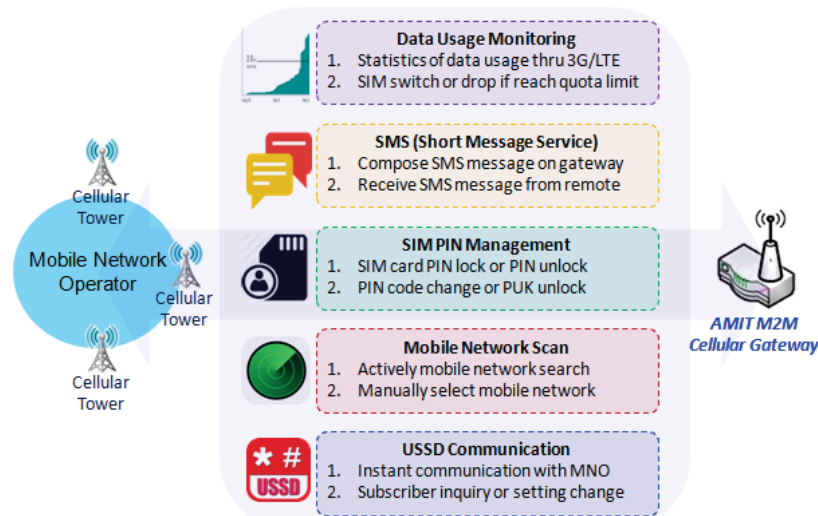

Besides cellular data connection, you may also like to monitor data usage of cellular WAN, sending text message through SMS, changing PIN code of SIM card, communicating with carrier/ISP by USSD command, or doing a cellular network scan for diagnostic purpose.

In Cellular Toolkit section, it includes several useful features that are related to cellular configuration or application. You can configure settings of Data Usage, SMS, SIM PIN, USSD, and Network Scan here. Please note at least a valid SIM card is required to be inserted to device before you continue settings in this

section.

7.1.1 Data Usage

Most of data plan for cellular connection is with a limited amount of data usage. If data usage has been over limited quota, either you will get much lower data throughput that may affect your daily operation, or you will get a 'bill shock' in the next month because carrier/ISP charges a lot for the over-quota data usage.

With help from Data Usage feature, device will monitor cellular data usage continuously and take actions. If data usage reaches limited quota, device can be set to drop the cellular data connection right away. Otherwise, if secondary SIM card is inserted, device will switch to secondary SIM and establish another cellular data connection with secondary SIM automatically.

If Data Usage feature is enabled, all history of cellular data usage can be viewed at **Status > Statistics & Reports > Cellular Usage** tab.

ID	SIM info	Carrier Name	Cycle Period	Start Date	Data Limitation	Connection Restrict	Enable	Action
1	3G/4G SIM A	ISP A	1 Monthly	Mon Apr 01 2019 00:00:00 GMT+0800	1GB	<input checked="" type="checkbox"/>	<input checked="" type="checkbox"/>	<input type="button" value="Edit"/> <input type="checkbox"/> Select

5G NR M2M Gateway

3G/4G Data Usage

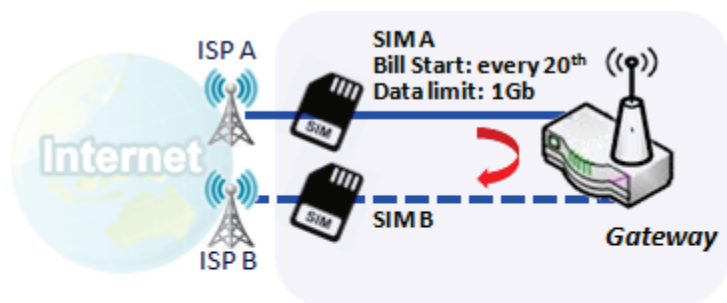

SIM A Settings

- Cycle Period: monthly
- Start Date: 2017 / Feb / 20
- Data Limitation: 1Gb
- Connection Restrict: Enable

Data Usage feature enabling gateway device to continuously monitor cellular data usage and take actions. In the diagram, quota limit of SIM A is **1Gb** per month and bill start date is **20th** of every month. The device is smart to start a new calculation of data usage on every 20th of month. Enable Connection Restrict will force gateway device to drop cellular connection of SIM A when data usage reaches quota limit (1Gb in this case). If SIM failover feature is configured in **Internet Setup**, then gateway will switch to SIM B and establish a new cellular data connection automatically.

5G NR M2M Gateway

Data Usage Setting

Go to **Service** > **Cellular Toolkit** > **Data Usage** tab.

Before finished settings for Data Usage, you need to know bill start date, bill period, and quota limit of data usage according to your data plan. You can ask this information from your carrier or ISP.

Create / Edit Cellular Data Usage Profile

Cellular Data Usage Profile List								
ID	SIM info	Carrier Name	Cycle Period	Start Date	Data Limitation	Connection Restrict	Enable	Action

When **Add** button is applied, Cellular Data Usage Profile Configuration screen will appear. You can create up to four data usage profiles, one profile for each SIM card used in the Gateway.

Cellular Data Usage Profile Configuration	
Item	Setting
▶ SIM Select	Cellular ▼ SIM A ▼
▶ Carrier Name	<input type="text"/>
▶ Cycle Period	Days ▼ <input type="text"/>
▶ Start Date	2021 ▼ / January ▼ / 19 ▼
▶ Data Limitation	<input type="text"/> KB ▼
▶ Connection Restrict	<input type="checkbox"/> Enable
▶ Enable	<input checked="" type="checkbox"/> Enable

Cellular Data Usage Profile Configuration		
Item Setting	Value setting	Description
SIM Select	Cellular-1 and SIM A by default.	Choose a cellular interface (Cellular-1 or Cellular-2), and a SIM card bound to the selected cellular interface to configure its data usage profile. Note: Cellular-2 is only available for for the product with dual cellular module.
Carrier Name	It is an optional item.	Fill in the Carrier Name for the selected SIM card for identification.
Cycle Period	Days by default	The first box has three types for cycle period. They are Days , Weekly and Monthly . Days: For per Days cycle periods, you have to further specify the number of days in the second box. Value Range: 1 ~ 90 days. Weekly, Monthly: The cycle period is one week or one month.
Start Date	N/A	Specify the date to start measure network traffic. Please don't select the day before now, otherwise, the traffic statistics will be incorrect.
Data Limitation	N/A	Specify the allowable data limitation for the defined cycle period.
Connection	Un-Checked by default.	Check the Enable box to activate the connection restriction function.

5G NR M2M Gateway

Restrict		During the specified cycle period, if the actual data usage exceeds the allowable data limitation, the cellular connection will be forced to disconnect.
Enable	Checked by default.	Check the Enable box to activate the data usage profile.

5G NR M2M Gateway

7.1.2 SMS

Short Message Service (SMS) is a text messaging service, which is used to be widely-used on mobile phones. It uses standardized communications protocols to allow mobile phones or cellular devices to exchange short text messages in an instant and convenient way.

SMS Setting

Go to **Service > Cellular Toolkit > SMS** tab

With this gateway device, you can send SMS text messages or browse received SMS messages as you usually do on a cellular phone.

Setup SMS Configuration

Configuration	
Item	Setting
▶ Physical Interface	Cellular-1 ▼
▶ SMS	<input checked="" type="checkbox"/> Enable SIM Status: SIM_A
▶ SMS Storage	SIM Card Only ▼
▶ SMS Space	<input type="checkbox"/> Enable & Keep Available Space <input type="text"/> (1-10)

Configuration		
Item	Value setting	Description
Physical Interface	The box is Cellular-1 by default	Choose a cellular interface (Cellular-1 or Cellular-2) for the following SMS function configuration. Note: Cellular-2 is only available for for the product with dual cellular module.
SMS	The box is checked by default	This is the SMS switch. If the box checked that the SMS function enable, if the box unchecked that the SMS function disable.
SIM Status	N/A	Depend on currently SIM status. The possible value will be SIM_A or SIM_B .
SMS Storage	The box is SIM Card Only by default	This is the SMS storage location. Currently the option only SIM Card Only .
SMS Space	The box is unchecked by default	Check the Enable box and specify a number (1-10) for message count to reserve some available storage space and prevent it from run out of storage. The oldest message(s) will be deleted when the SMS storage is going to full.
Save	N/A	Click the Save button to save the settings

5G NR M2M Gateway

SMS Summary

Show **Unread SMS**, **Received SMS**, **Sent SMS**, **Remaining SMS**, and edit SMS context to send, read SMS from SIM card.

Item	Setting
▶ Unread SMS	0
▶ Received SMS	10
▶ Sent SMS	0
▶ Remaining SMS	0

SMS Summary		
Item	Value setting	Description
Unread SMS	N/A	If SIM card insert to router first time, unread SMS value is zero. When received the new SMS but didn't read, this value plus one.
Received SMS	N/A	This value record the existing SMS numbers from SIM card, When received the new SMS, this value plus one.
Sent SMS	N/A	This value record the number of out going SMS, When sent one SMS, this value plus one.
Remaining SMS	N/A	This value is SMS capacity minus received SMS, When received the new SMS, this value minus one.
New SMS	N/A	Click New SMS button, a New SMS screen appears. User can set the SMS setting from this screen. Refer to New SMS in the next page.
SMS Inbox	N/A	Click SMS Inbox button, a SMS Inbox List screen appears. User can read or delete SMS, reply SMS or forward SMS from this screen. Refer to SMS Inbox List in the next page.
Refresh	N/A	Click the Refresh button to update the SMS summary immediately.

5G NR M2M Gateway

New SMS

You can set the SMS setting from this screen.

Item	Setting
Receivers	<input type="text"/> (Use '+' for International Format and ';' to Compose Multiple Receivers)
Text Message	<div style="border: 1px solid #ccc; height: 100px;"></div> Length of Current Input : 0
Result	

New SMS		
Item	Value setting	Description
Receivers	N/A	Write the receivers to send SMS. User need to add the semicolon and compose multiple receivers that can group send SMS.
Text Message	N/A	Write the SMS context to send SMS. The router supports up to a maximum of 1023 character for SMS context length.
Send	N/A	Click the Send button, above text message will be sent as a SMS.
Result	N/A	If SMS has been sent successfully, it will show Send OK , otherwise Send Failed will be displayed.

SMS Inbox List

You can read or delete SMS, reply SMS or forward SMS from this screen.

ID	From Phone Number	Timestamp	SMS Text Preview	Actions

SMS Inbox List		
Item	Value setting	Description
ID	N/A	The number of SMS.
From Phone Number	N/A	Sender List (Phone Number) for the received SMS
Timestamp	N/A	What time the SMS is received
SMS Text Preview	N/A	Preview the SMS text. Click the Detail button to read a certain message.

5G NR M2M Gateway

Action	The box is unchecked by default	Click the Detail button to read the SMS detail; Click the Reply / Forward button to reply/forward SMS. Besides, you can check the box(es), and then click the Delete button to delete the checked SMS(s).
Refresh	N/A	Refresh the SMS Inbox List.
Delete	N/A	Delete the SMS for all checked box from Action.
Close	N/A	Close the Detail SMS Message screen.

SMS Sent Folder

You can read or delete SMS from this screen.

SMS Sent Folder					Delete	Close	Previous	0 ▼	Next	
ID	Receivers	Timestamp	SMS Text Preview	Actions						

SMS Sent Folder		
Item	Value setting	Description
ID	N/A	The number of SMS.
Receivers	N/A	Receiver list for the sent SMS.
Timestamp	N/A	What time the SMS is sent
SMS Text Preview	N/A	Preview the SMS text. Click the Detail button to read a certain message.
Action	The box is unchecked by default	Click the Detail button to read the SMS detail Besides, you can check the box(es), and then click the Delete button to delete the checked record(s).
Refresh	N/A	Refresh the SMS Sent Folder.
Delete	N/A	Delete the SMS for all checked box from Action.
Close	N/A	Close the Detail SMS Message screen.

5G NR M2M Gateway

7.1.3 SIM PIN

With most cases in the world, users need to insert a SIM card (a.k.a. UICC) into end devices to get on cellular network for voice service or data surfing. The SIM card is usually released by mobile operators or service providers. Each SIM card has a unique number (so-called ICCID) for network owners or service providers to identify each subscriber. As SIM card plays an important role between service providers and subscribers, some security mechanisms are required on SIM card to prevent any unauthorized access.

Enabling a PIN code in SIM card is an easy and effective way of protecting cellular devices from unauthorized access. This gateway device allows you to activate and manage PIN code on a SIM card through its web GUI.

Activate PIN code on SIM Card

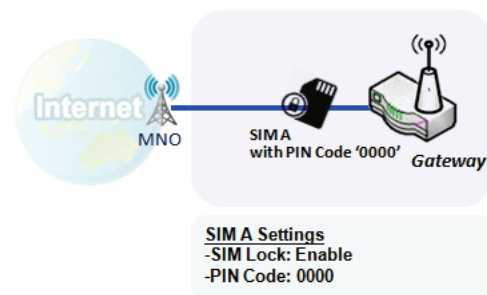

This gateway device allows you to activate PIN code on SIM card. This example shows how to activate PIN code on SIM-A for 3G/4G-1 with default PIN code “0000”.

Change PIN code on SIM Card

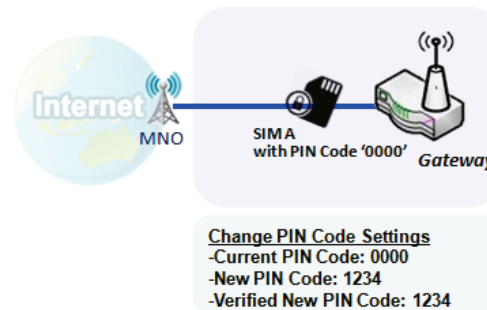

This gateway device allows you to change PIN code on SIM card. Following the example above, you need to type original PIN code “0000”, and then type new PIN code with ‘1234’ if you like to set new PIN code as ‘1234’. To confirm the new PIN code you type is what you want, you need to type new PIN code ‘1234’ in Verified New PIN Code again.

Unlock SIM card by PUK Code

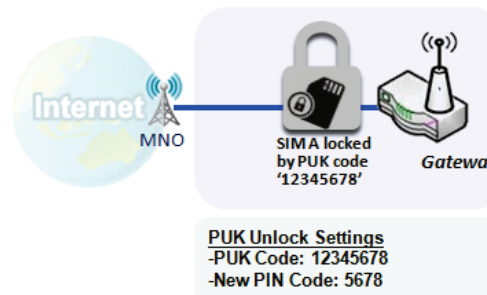

If you entered incorrect PIN code at configuration page for 3G/4G-1 WAN over three times, and then it will cause SIM card to be locked by PUK code. Then you have to call service number to get a PUK code to unlock SIM card. In the diagram, the PUK code is “12345678” and new PIN code is “5678”.

5G NR M2M Gateway

SIM PIN Setting

Go to **Service** > **Cellular Toolkit** > **SIM PIN** Tab

With the SIM PIN Function window, it allows you to enable or disable SIM lock (which means protected by PIN code), or change PIN code. You can also see the information of remaining times of failure trials as we mentioned earlier. If you run out of these failure trials, you need to get a PUK code to unlock SIM card.

Select a SIM Card

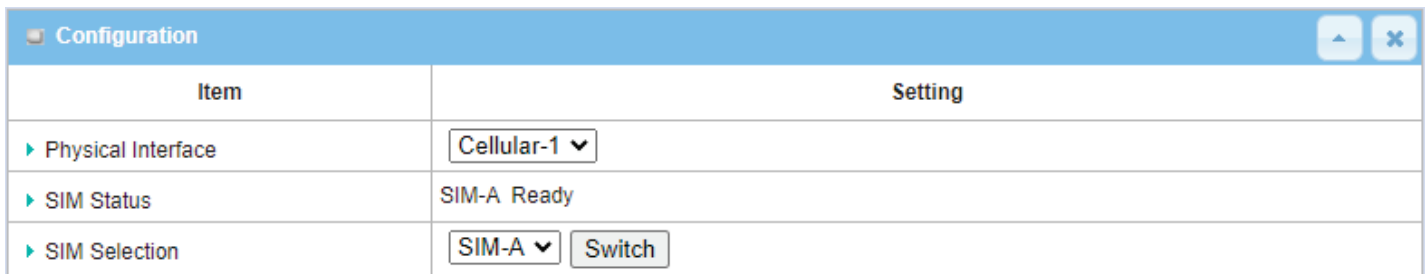

The screenshot shows a configuration window titled "Configuration" with a close button. It contains a table with the following items and settings:

Item	Setting
▶ Physical Interface	Cellular-1 ▼
▶ SIM Status	SIM-A Ready
▶ SIM Selection	SIM-A ▼ <input type="button" value="Switch"/>

Configuration Window		
Item	Value setting	Description
Physical Interface	The box is Cellular-1 by default	Choose a cellular interface (Cellular-1 or Cellular-2) to change the SIM PIN setting for the selected SIM Card. Note: Cellular-2 is only available for for the product with dual cellular module.
SIM Status	N/A	Indication for the selected SIM card and the SIM card status. The status could be Ready , Not Insert , or SIM PIN . Ready -- SIM card is inserted and ready to use. It can be a SIM card without PIN protection or that SIM card is already unlocked by correct PIN code. Not Insert -- No SIM card is inserted in that SIM slot. SIM PIN -- SIM card is protected by PIN code, and it's not unlocked by a correct PIN code yet. That SIM card is still at locked status.
SIM Selection	N/A	Select the SIM card for further SIM PIN configuration. Press the Switch button, then the Gateway will switch SIM card to another one. After that, you can configure the SIM card.

5G NR M2M Gateway

Enable / Change PIN Code

Enable or Disable PIN code (password) function, and even change PIN code function.

SIM function	
<input type="button" value="Save"/> <input type="button" value="Change PIN Code"/>	
Item	Setting
▶ PIN Lock	<input checked="" type="checkbox"/> Enable PIN Code: <input type="text"/> (4~8 digits)
▶ Remaining times	N/A

SIM function Window		
Item Setting	Value setting	Description
PIN lock	Depend on SIM card	Click the Enable button to activate the PIN lock function. For the first time you want to enable the PIN lock function, you have to fill in the PIN code as well, and then click Save button to apply the setting.
Remaining times	Depend on SIM card	Represent the remaining trial times for the SIM PIN unlocking.
Save	N/A	Click the Save button to apply the setting.
Change PIN Code	N/A	Click the Change PIN code button to change the PIN code (password). If the SIM Lock function is not enabled, the Change PIN code button is disabled. In the case, if you still want to change the PIN code, you have to enable the SIM Lock function first, fill in the PIN code, and then click the Save button to enable. After that, You can click the Change PIN code button to change the PIN code.

When **Change PIN Code** button is clicked, the following screen will appear.

Item	Setting
▶ Current PIN Code	<input type="text"/> (4~8 digits)
▶ New PIN Code	<input type="text"/> (4~8 digits)
▶ Verified New PIN Code	<input type="text"/> (4~8 digits)

Item	Value Setting	Description
Current PIN Code	A Must filled setting	Fill in the current (old) PIN code of the SIM card.
New PIN Code	A Must filled setting	Fill in the new PIN Code you want to change.
Verified New PIN Code	A Must filled setting	Confirm the new PIN Code again.
Apply	N/A	Click the Apply button to change the PIN code with specified new PIN code.
Cancel	N/A	Click the Cancel button to cancel the changes and keep current PIN code.

Note: If you changed the PIN code for a certain SIM card, you must also change the corresponding PIN code specified in the **Basic Network > WAN & Uplink > Internet Setup > Connection with SIM Card** page. Otherwise, it may result in wrong SIM PIN trials with invalid (old) PIN code.

5G NR M2M Gateway

Unlock with a PUK Code

The PUK Function window is only available for configuration if that SIM card is locked by PUK code. It means that SIM card is locked and needs additional PUK code to unlock. Usually it happens after too many trials of incorrect PIN code, and the remaining times in SIM Function table turns to 0. In this situation, you need to contact your service provider and request a PUK code for your SIM card, and try to unlock the locked SIM card with the provided PUK code. After unlocking a SIM card by PUK code successfully, the SIM lock function will be activated automatically.

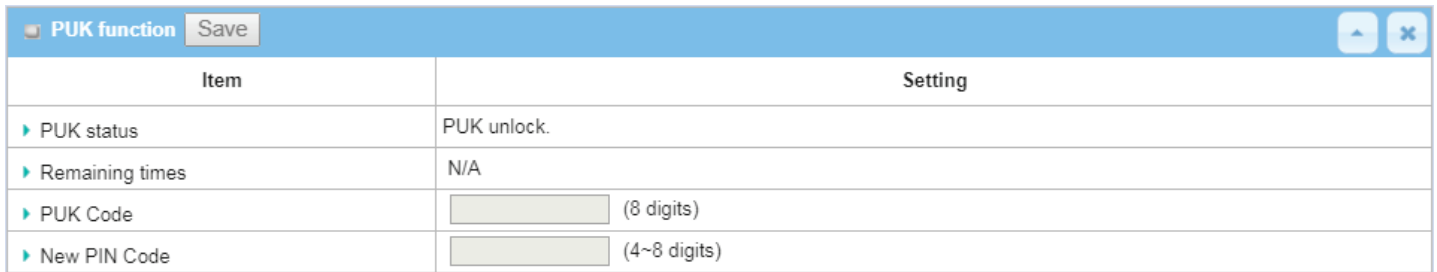

Item	Setting
▶ PUK status	PUK unlock.
▶ Remaining times	N/A
▶ PUK Code	<input type="text"/> (8 digits)
▶ New PIN Code	<input type="text"/> (4~8 digits)

PUK Function Window		
Item	Value setting	Description
PUK status	PUK Unlock / PUK Lock	Indication for the PUK status. The status could be PUK Lock or PUK Unlock . As mentioned earlier, the SIM card will be locked by PUK code after too many trials of failure PIN code. In this case, the PUK Status will turn to PUK Lock . In a normal situation, it will display PUK Unlock .
Remaining times	Depend on SIM card	Represent the remaining trial times for the PUK unlocking. Note : DO NOT make the remaining times down to zero, it will damage the SIM card FOREVER ! Call for your ISP's help to get a correct PUK and unlock the SIM if you don't have the PUK code.
PUK Code	A Must filled setting	Fill in the PUK code (8 digits) that can unlock the SIM card in PUK unlock status.
New PIN Code	A Must filled setting	Fill in the New PIN Code (4~8 digits) for the SIM card. You have to determine your new PIN code to replace the old, forgotten one. Keep the PIN code (password) in mind with care.
Save	N/A	Click the Save button to apply the setting.

Note: If you changed the PUK code and PIN code for a certain SIM card, you must also change the corresponding PIN code specified in the **Basic Network > WAN & Uplink > Internet Setup > Connection with SIM Card** page. Otherwise, it may result in wrong SIM PIN trials with invalid (old) PIN code.

5G NR M2M Gateway

7.1.4 USSD (not supported)

Not supported feature for the purchased product, leave it as blank.

5G NR M2M Gateway

7.1.5 Network Scan

"Network Scan" function can let administrator specify the device how to connect to the mobile system for data communication in each cellular interface. For example, administrator can specify which generation of mobile system is used for connection, 3G, 4G or 5G. Moreover, he can define their connection sequence for the gateway device to connect to the mobile system automatically. Administrator also can scan the mobile systems in the air manually, select the target operator system and apply it. The manual scanning approach is used for problem diagnosis.

Network Scan Setting

Go to **Service > Cellular Toolkit > Network Scan** tab.

In "Network Scan" page, there are two windows for the Network Scan function. The "Configuration" window can let you select which Cellular module (physical interface) is used to perform Network Scan, and system will show the current used SIM card in the module. You can configure each Cellular WAN interface by executing the network scanning one after another. You can also specify the connection sequence of the targeted generation of mobile system, 3G/4G/5G.

Network Scan Configuration

Item	Setting
▶ Physical Interface	Cellular-1 ▼ SIM Status: SIM_A
▶ Network Type	Auto ▼
▶ Scan Approach	Auto ▼

Configuration Item	Value setting	Description
Physical Interface	The box is Cellular-1 by default	Choose a cellular interface (Cellular-1 or Cellular-2) for the network scan function. Note: Cellular-2 is only available for for the product with dual cellular module.
SIM Status	N/A	Show the connected cellular service (identified with SIM_A or SIM_B).
Network Type	Auto is selected by default.	Specify the network type for the network scan function. When Auto is selected, the network will be register automatically; When Auto selected, cellular module register automatically.
Scan Approach	Auto is selected by default.	If the Manually option is selected, a Network Provider List screen appears. Press Scan button to scan for the nearest base stations. Select (check the box) the preferred base stations then click Apply button to apply settings.
Save	N/A	Click Save to save the settings

The second window is the "Network Provider List" window and it appears when the **Manually** Scan Approach is

5G NR M2M Gateway

selected in the Configuration window. By clicking on the "Scan" button and wait for 1 to 3 minutes, the found mobile operator system will be displayed for you to choose. Click again on the "Apply" button to drive system to connect to that mobile operator system for the dedicated 3G/4G interface.

Network Provider List <input type="button" value="Scan"/> <input type="button" value="Apply"/>			
Provider Name	Mobile System	Network Status	Action

5G NR M2M Gateway

Chapter 8 Status

8.1 Dashboard

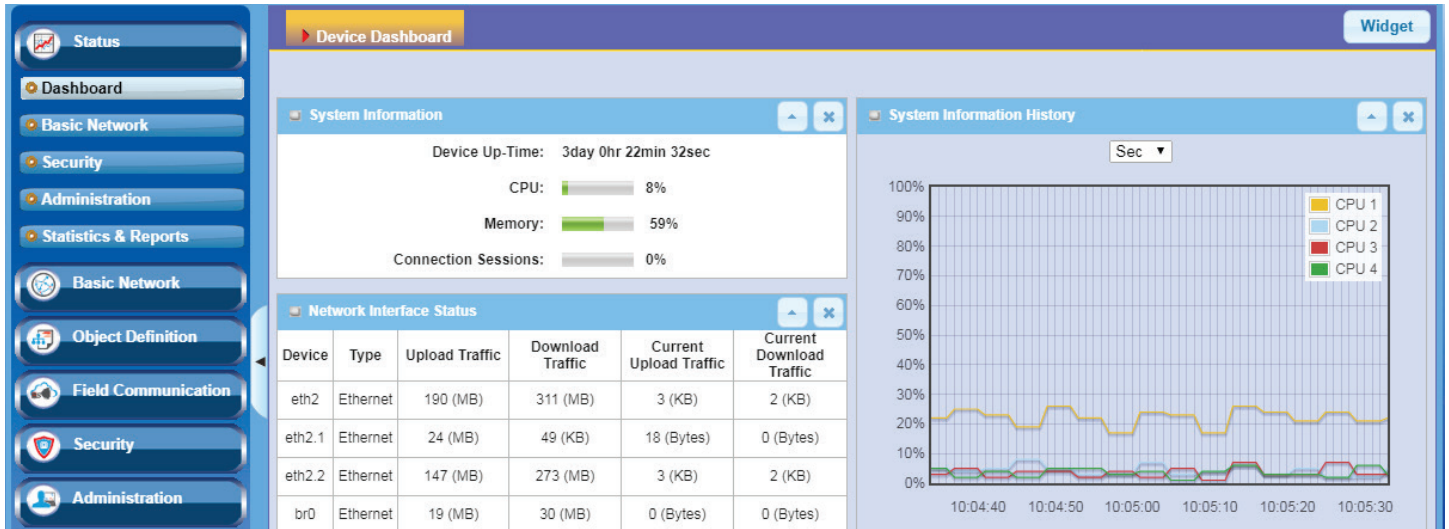

8.1.1 Device Dashboard

The **Device Dashboard** window shows the current status in graph or tables for quickly understanding the operation status for the gateway. They are the System Information, System Information History, and Network Interface Status. The display will be refreshed once per second.

From the menu on the left, select **Status > Dashboard > Device Dashboard** tab.

System Information Status

The **System Information** screen shows the device Up-time and the resource utilization for the CPU, Memory, and Connection Sessions.

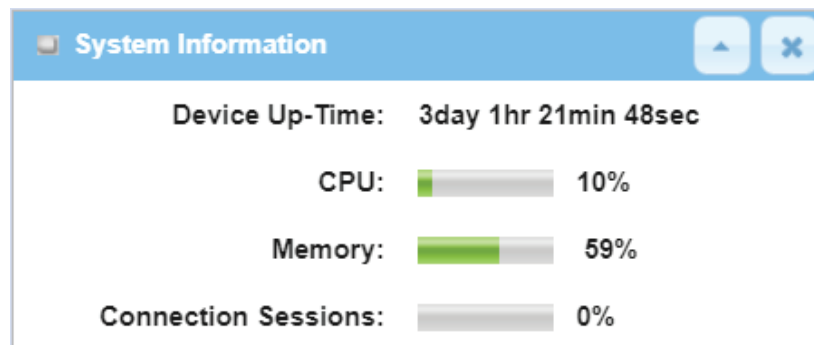

5G NR M2M Gateway

System Information History

The **System Information History** screen shows the statistic graphs for the CPU and memory.

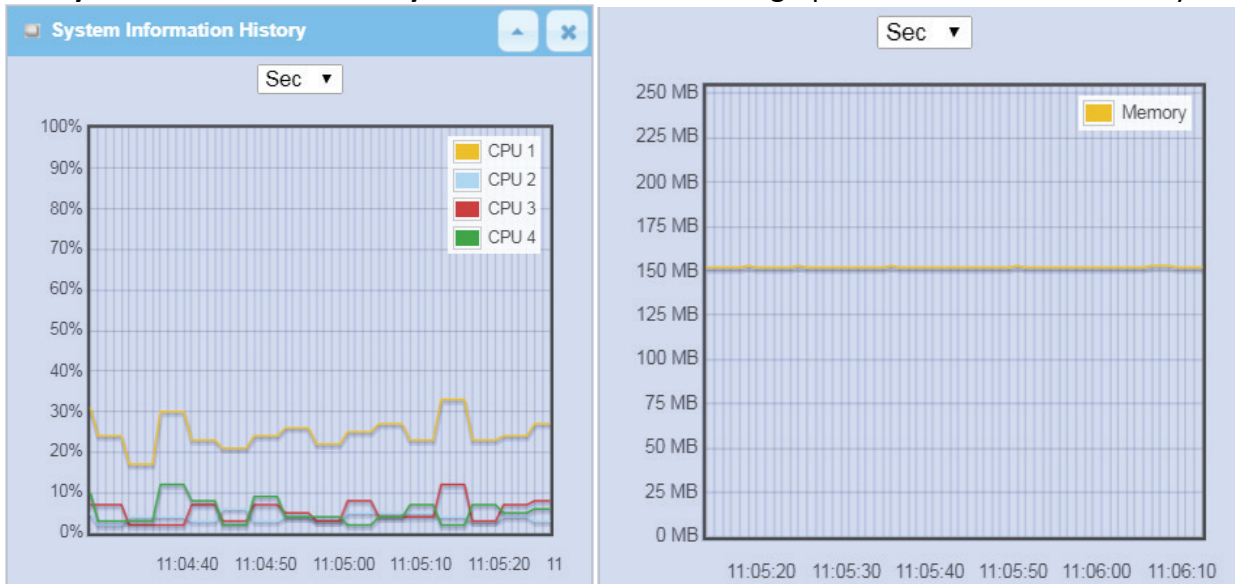

Network Interface Status

The **Network Interface Status** screen shows the statistic information for each network interface of the gateway. The statistic information includes the Interface Type, Upload Traffic, Download Traffic, and Current Upload / Download Traffic.

Device	Type	Upload Traffic	Download Traffic	Current Upload Traffic	Current Download Traffic
eth2	Ethernet	211 (MB)	321 (MB)	3 (KB)	3 (KB)
eth2.1	Ethernet	24 (MB)	71 (KB)	64 (Bytes)	0 (Bytes)
eth2.2	Ethernet	168 (MB)	283 (MB)	3 (KB)	3 (KB)
br0	Ethernet	19 (MB)	31 (MB)	42 (Bytes)	0 (Bytes)
ra0	Wireless LAN	1 (MB)	1 (MB)	0 (Bytes)	0 (Bytes)
rai0	Wireless LAN	21 (MB)	42 (MB)	0 (Bytes)	0 (Bytes)
ra1	Wireless LAN	0 (Bytes)	0 (Bytes)	0 (Bytes)	0 (Bytes)
rai1	Wireless LAN	362 (Bytes)	4 (KB)	0 (Bytes)	0 (Bytes)
tun0	Ethernet	0 (Bytes)	0 (Bytes)	0 (Bytes)	0 (Bytes)

5G NR M2M Gateway

8.2 Basic Network

8.2.1 WAN & Uplink Status

Go to **Status > Basic Network > WAN & Uplink** tab.

The **WAN & Uplink Status** window shows the current status for different network type, including network configuration, connecting information, modem status and traffic statistics. The display will be refreshed on every five seconds.

WAN interface IPv4 Network Status

WAN interface IPv4 Network Status screen shows status information for IPv4 network.

WAN Interface IPv4 Network Status										
ID	Interface	WAN Type	Network Type	IP Addr.	Subnet Mask	Gateway	DNS	MAC Address	Conn. Status	Action
WAN-1	Cellular	Cellular	NAT	0.0.0.0	0.0.0.0	0.0.0.0	0.0.0.0, 0.0.0.0	N/A	Disconnected	Edit
WAN-2		Disable								Edit
WAN-3		Disable								Edit

WAN interface IPv4 Network Status		
Item	Value setting	Description
ID	N/A	It displays corresponding WAN interface WAN IDs.
Interface	N/A	It displays the type of WAN physical interface. Depending on the model purchased, it can be Ethernet, or Cellular.
WAN Type	N/A	It displays the method which public IP address is obtained from your ISP. Depending on the model purchased, it can be Static IP, Dynamic IP, PPPoE, PPTP, L2TP, Cellular.
Network Type	N/A	It displays the network type for the WAN interface(s). Depending on the model purchased, it can be NAT, Routing, Bridge, or IP Pass-through.
IP Addr.	N/A	It displays the public IP address obtained from your ISP for Internet connection. Default value is 0.0.0.0 if left unconfigured.
Subnet Mask	N/A	It displays the Subnet Mask for public IP address obtained from your ISP for Internet connection. Default value is 0.0.0.0 if left unconfigured.
Gateway	N/A	It displays the Gateway IP address obtained from your ISP for Internet connection. Default value is 0.0.0.0 if left unconfigured.
DNS	N/A	It displays the IP address of DNS server obtained from your ISP for Internet connection. Default value is 0.0.0.0 if left unconfigured.
MAC Address	N/A	It displays the MAC Address for your ISP to allow you for Internet access. Note: Not all ISP may require this field.
Conn. Status	N/A	It displays the connection status of the device to your ISP.

5G NR M2M Gateway

		Status are Connected or disconnected.
		This area provides functional buttons.
		Renew button allows user to force the device to request an IP address from the DHCP server. Note: Renew button is available when DHCP WAN Type is used and WAN connection is disconnected.
		Release button allows user to force the device to clear its IP address setting to disconnect from DHCP server. Note: Release button is available when DHCP WAN Type is used and WAN connection is connected.
Action	N/A	Connect button allows user to manually connect the device to the Internet. Note: Connect button is available when Connection Control in WAN Type setting is set to Connect Manually (Refer to Edit button in Basic Network > WAN & Uplink > Internet Setup) and WAN connection status is disconnected.
		Disconnect button allows user to manually disconnect the device from the Internet. Note: Connect button is available when Connection Control in WAN Type setting is set to Connect Manually (Refer to Edit button in Basic Network > WAN & Uplink > Internet Setup) and WAN connection status is connected.

WAN interface IPv6 Network Status

WAN interface IPv6 Network Status screen shows status information for IPv6 network.

WAN Interface IPv6 Network Status						
ID	Interface	WAN Type	Link-local IP Address	Global IP Address	Conn. Status	Action
WAN-1	Cellular	IPv6		/64	Disconnected	<input type="button" value="Edit"/>

WAN interface IPv6 Network Status		
Item	Value setting	Description
ID	N/A	It displays corresponding WAN interface WAN IDs.
Interface	N/A	It displays the type of WAN physical interface. Depending on the model purchased, it can be Ethernet, Cellular, etc...
WAN Type	N/A	It displays the method which public IP address is obtained from your ISP. WAN type setting can be changed from Basic Network > IPv6 > Configuration .
Link-local IP Address	N/A	It displays the LAN IPv6 Link-Local address.
Global IP Address	N/A	It displays the IPv6 global IP address assigned by your ISP for your Internet connection.
Conn. Status	N/A	It displays the connection status. The status can be connected, disconnected and connecting.

5G NR M2M Gateway

Action	N/A	This area provides functional buttons. Edit Button when pressed, web-based utility will take you to the IPv6 configuration page. (Basic Network > IPv6 > Configuration.)
---------------	-----	---

LAN Interface Network Status

LAN Interface Network Status screen shows IPv4 and IPv6 information of LAN network.

LAN Interface Network Status					
IPv4 Address	IPv4 Subnet Mask	IPv6 Link-local Address	IPv6 Global Address	MAC Address	Action
192.168.123.254	255.255.255.0	fe80::250:18ff:fe00:ffe	/64	00:50:18:00:0F:FE	<input type="button" value="Edit IPv4"/> <input type="button" value="Edit IPv6"/>

LAN Interface Network Status		
Item	Value setting	Description
IPv4 Address	N/A	It displays the current IPv4 IP Address of the gateway This is also the IP Address user use to access Router's Web-based Utility.
IPv4 Subnet Mask	N/A	It displays the current mask of the subnet.
IPv6 Link-local Address	N/A	It displays the current LAN IPv6 Link-Local address. This is also the IPv6 IP Address user use to access Router's Web-based Utility.
IPv6 Global Address	N/A	It displays the current IPv6 global IP address assigned by your ISP for your Internet connection.
MAC Address	N/A	It displays the LAN MAC Address of the gateway
Action	N/A	This area provides functional buttons. Edit IPv4 Button when press, web-based utility will take you to the Ethernet LAN configuration page. (Basic Network > LAN & VLAN > Ethernet LAN tab.) Edit IPv6 Button when press, web-based utility will take you to the IPv6 configuration page. (Basic Network > IPv6 > Configuration.)

Cellular Modem Status

Cellular Modem Status List screen shows status information for Cellular WAN network(s).

Cellular Modem Status List					
Interface	Card Information	Link Status	Signal Strength	Network Name	Action
Cellular	334	Disconnected	N/A	N/A	<input type="button" value="Detail"/>

3G/4G Modem Status List		
Item	Value setting	Description
Physical Interface	N/A	It displays the type of WAN physical interface..
Card Information	N/A	It displays the vendor's cellular modem model name.

5G NR M2M Gateway

Link Status	N/A	It displays the cellular connection status. The status can be Connecting, Connected, Disconnecting, and Disconnected.
Signal Strength	N/A	It displays the cellular wireless signal level.
Network Name	N/A	It displays the name of the service network carrier.
Refresh	N/A	Click the Refresh button to renew the information.
Action	N/A	This area provides functional buttons. Detail Button when press, windows of detail information will appear. They are the Modem Information, SIM Status, and Service Information. Refer to next page for more.

When the **Detail** button is pressed, cellular modem information windows such as Modem Information, SIM Status, Service Information, Signal Strength / Quality, and Error Message will appear.

Interface Traffic Statistics

Interface Traffic Statistics screen displays the Interface's total transmitted packets.

Interface Traffic Statistics				
ID	Interface	Received Packets(Mb)	Transmitted Packets(Mb)	Action
WAN-1	Cellular	0	0	Reset
WAN-2		-	-	
WAN-3		-	-	

Interface Traffic Statistics		
Item	Value setting	Description
ID	N/A	It displays corresponding WAN interface WAN IDs.
Interface	N/A	It displays the type of WAN physical interface. Depending on the model purchased, it can be Ethernet, Cellular, etc...
Received Packets (Mb)	N/A	It displays the downstream packets (Mb). It is reset when the device is rebooted.
Transmitted Packets (Mb)	N/A	It displays the upstream packets (Mb). It is reset when the device is rebooted.

5G NR M2M Gateway

8.2.2 LAN & VLAN Status

Go to **Status > Basic Network > LAN & VLAN** tab.

Client List

The **Client List** shows you the LAN Interface, IP address, Host Name, MAC Address, and Remaining Lease Time of each device that is connected to this gateway.

LAN Client List				
LAN Interface	IP Address	Host Name	MAC Address	Remaining Lease Time
Ethernet	Dynamic / 192.168.66.100	amit25613572	00-13-3B-0E-5B-1D	00:15:00

LAN Client List		
Item	Value setting	Description
LAN Interface	N/A	Client record of LAN Interface. String Format.
IP Address	N/A	Client record of IP Address Type and the IP Address. Type is String Format and the IP Address is IPv4 Format.
Host Name	N/A	Client record of Host Name. String Format.
MAC Address	N/A	Client record of MAC Address. MAC Address Format.
Remaining Lease Time	N/A	Client record of Remaining Lease Time. Time Format.

5G NR M2M Gateway

8.2.3 WiFi Status

Go to **Status > Basic Network > WiFi** tab.

The **WiFi Status** window shows the overall statistics of WiFi VAP entries.

WiFi Virtual AP List

The WiFi Virtual AP List shows all of the virtual AP information on each WiFi module. The **Edit** button allows for quick configuration changes.

WiFi Module One Virtual AP List									
Op. Band	ID	WiFi Enable	Op. Mode	SSID	Channel	WiFi System	Auth.&Security	MAC Address	Action
2.4G	VAP-1	<input checked="" type="checkbox"/>	AP Router	Staff_2.4G	Auto(3)	b/g/n Mixed	WPA2-PSK(AES)	00:50:18:00:07:F0	Edit QR Code
2.4G	VAP-2	<input type="checkbox"/>	AP Router	default	Auto(3)	b/g/n Mixed	WPA2-PSK(AES)	02:50:18:10:07:F0	Edit QR Code
2.4G	VAP-3	<input type="checkbox"/>	AP Router	default	Auto(3)	b/g/n Mixed	WPA2-PSK(AES)	02:50:18:20:07:F0	Edit QR Code
2.4G	VAP-4	<input type="checkbox"/>	AP Router	default	Auto(3)	b/g/n Mixed	WPA2-PSK(AES)	02:50:18:30:07:F0	Edit QR Code
2.4G	VAP-5	<input type="checkbox"/>	AP Router	default	Auto(3)	b/g/n Mixed	WPA2-PSK(AES)	02:50:18:40:07:F0	Edit QR Code
2.4G	VAP-6	<input type="checkbox"/>	AP Router	default	Auto(3)	b/g/n Mixed	WPA2-PSK(AES)	02:50:18:50:07:F0	Edit QR Code
2.4G	VAP-7	<input type="checkbox"/>	AP Router	default	Auto(3)	b/g/n Mixed	WPA2-PSK(AES)	02:50:18:60:07:F0	Edit QR Code
2.4G	VAP-8	<input type="checkbox"/>	AP Router	Guest_2.4G	Auto(3)	b/g/n Mixed	WPA2-PSK(AES)	02:50:18:70:07:F0	Edit QR Code

WiFi Virtual AP List		
Item	Value setting	Description
Op. Band	N/A	It displays the WiFi Operation Band (2.4G or 5G) of VAP.
ID	N/A	It displays the ID of VAP.
WiFi Enable	N/A	It displays whether the VAP wireless signal is enabled or disabled.
Op. Mode	N/A	It displays the WiFi Operation Mode of VAP.
SSID	N/A	It displays the network ID of VAP.
Channel	N/A	It displays the wireless channel used.
WiFi System	N/A	The WiFi System of VAP.
Auth. & Security	N/A	It displays the authentication and encryption type used.
MAC Address	N/A	It displays MAC Address of VAP.
Action	N/A	Click the Edit button to make a quick access to the WiFi configuration page. (Basic Network > WiFi > Configuration tab) The QR Code button allow you to generate QR code for quick connect to the VAP by scanning the QR code.

WiFi IDS Status

5G NR M2M Gateway

The WiFi IDS Status shows all the WIDS statistics on each WiFi module.

WiFi Module One IDS Status								▲	✕
Authentication Frame	Association Request Frame	Re-association Request Frame	Probe Request Frame	Disassociation Frame	Deauthentication Frame	EAP Request Frame	Malicious Data Frame	Action	
0	0	0	0	0	0	0	0	Reset	

WiFi IDS Status		
Item	Value setting	Description
Authentication Frame	N/A	It displays the receiving Authentication Frame count.
Association Request Frame	N/A	It displays the receiving Association Request Frame count.
Re-association Request Frame	N/A	It displays the receiving Re-association Request Frame count.
Probe Request Frame	N/A	It displays the receiving Probe Request Frame count.
Disassociation Frame	N/A	It displays the receiving Disassociation Frame count.
Deauthentication Frame	N/A	It displays the receiving Deauthentication Frame count.
EAP Request Frame	N/A	It displays the receiving EAP Request Frame count.
Malicious Data Frame	N/A	It displays the number of receiving unauthorized wireless packets.
Action	N/A	Click the Reset button to clear the entire statistic and reset counter to 0.

Ensure WIDS function is enabled

Go to **Basic Network > WiFi > Advanced Configuration tab**

Note that the WIDS of **2.4GHz** or **5GHz WiFi** should be configured **separately**.

5G NR M2M Gateway

WiFi Traffic Statistic

The WiFi Traffic Statistic shows all the received and transmitted packets on each WiFi module.

WiFi Module One Traffic Statistics				
Op. Band	ID	Received Packets	Transmitted Packets	Action
2.4G	VAP-1	11592	3617	Reset
2.4G	VAP-2	0	0	Reset
2.4G	VAP-3	0	0	Reset
2.4G	VAP-4	0	0	Reset
2.4G	VAP-5	0	0	Reset
2.4G	VAP-6	0	0	Reset
2.4G	VAP-7	0	0	Reset
2.4G	VAP-8	0	0	Reset

WiFi Traffic Statistic		
Item	Value setting	Description
Op. Band	N/A	It displays the Wi-Fi Operation Band (2.4G or 5G) of VAP.
ID	N/A	It displays the VAP ID.
Received Packets	N/A	It displays the number of received packets.
Transmitted Packet	N/A	It displays the number of transmitted packets.
Action	N/A	Click the Reset button to clear individual VAP statistics.
Refresh Button	N/A	Click the Refresh button to update the entire VAP Traffic Statistic instantly.

5G NR M2M Gateway

8.2.4 DDNS Status

Go to **Status > Basic Network > DDNS** tab.

The **DDNS Status** window shows the current DDNS service in use, the last update status, and the last update time to the DDNS service server.

DDNS Status

DDNS Status List				
Host Name	Provider	Effective IP	Last Update Status	Last Update Time

DDNS Status		
Item	Value Setting	Description
Host Name	N/A	It displays the name you entered to identify DDNS service provider
Provider	N/A	It displays the DDNS server of DDNS service provider
Effective IP	N/A	It displays the public IP address of the device updated to the DDNS server
Last Update Status	N/A	It displays whether the last update of the device public IP address to the DDNS server has been successful (Ok) or failed (Fail).
Last Update Time	N/A	It displays time stamp of the last update of public IP address to the DDNS server.
Refresh	N/A	The refresh button allows user to force the display to refresh information.

5G NR M2M Gateway

8.3 Security

ID	Tunnel Name	Tunnel Scenario	Local Subnets	Remote IP/FQDN	Remote Subnets	Conn. Time	Status
----	-------------	-----------------	---------------	----------------	----------------	------------	--------

ID	User Name	Remote IP/FQDN	Virtual IP/Mac	Conn. Time	Status
----	-----------	----------------	----------------	------------	--------

ID	OpenVPN Client Name	Interface	Remote IP/FQDN	Remote Subnet	Virtual IP	Conn. Time	Conn. Status
1	Master_client	WAN 1	m2mcluster.de	/	172.17.0.190	00:00:00:44	Connected

ID	User Name	Remote IP	Remote Virtual IP	Remote Call ID	Conn. Time	Status
----	-----------	-----------	-------------------	----------------	------------	--------

ID	L2TP Client Name	Interface	Virtual IP	Remote IP/FQDN	Default Gateway/Remote Subnet	Conn. Time	Status
----	------------------	-----------	------------	----------------	-------------------------------	------------	--------

8.3.1 VPN Status

Go to **Status > Security > VPN** tab.

The **VPN Status** window shows the overall VPN tunnel status. The display will be refreshed on every five seconds.

IPSec Tunnel Status

IPSec Tunnel Status windows show the configuration for establishing IPSec VPN connection and current connection status.

ID	Tunnel Name	Tunnel Scenario	Local Subnets	Remote IP/FQDN	Remote Subnets	Conn. Time	Status
----	-------------	-----------------	---------------	----------------	----------------	------------	--------

IPSec Tunnel Status Item	Value setting	Description
Tunnel Name	N/A	It displays the tunnel name you have entered to identify.
Tunnel Scenario	N/A	It displays the Tunnel Scenario specified.
Local Subnets	N/A	It displays the Local Subnets specified.
Remote IP/FQDN	N/A	It displays the Remote IP/FQDN specified.
Remote Subnets	N/A	It displays the Remote Subnets specified.

5G NR M2M Gateway

Conn. Time	N/A	It displays the connection time for the IPsec tunnel.
Status	N/A	It displays the Status of the VPN connection. The status displays are Connected, Disconnected, Wait for traffic, and Connecting.
Edit Button	N/A	Click on Edit Button to change IPsec setting, web-based utility will take you to the IPsec configuration page. (Security > VPN > IPsec tab)

OpenVPN Server Status

According to OpenVPN configuration, the **OpenVPN Server/Client Status** shows the status and statistics for the OpenVPN connection from the server side or client side.

OpenVPN Server Status Edit					
ID	User Name	Remote IP/FQDN	Virtual IP/Mac	Conn. Time	Status
OpenVPN Server Status					
Item	Value setting	Description			
User Name	N/A	It displays the Client name you have entered for identification.			
Remote IP/FQDN	N/A	It displays the public IP address (the WAN IP address) of the connected OpenVPN Client			
Virtual IP/MAC	N/A	It displays the virtual IP/MAC address assigned to the connected OpenVPN client.			
Conn. Time	N/A	It displays the connection time for the corresponding OpenVPN tunnel.			
Status	N/A	It displays the connection status of the corresponding OpenVPN tunnel. The status can be Connected, or Disconnected.			

OpenVPN Client Status

OpenVPN Client Status Edit Detail							
ID	OpenVPN Client Name	Interface	Remote IP/FQDN	Remote Subnet	Virtual IP	Conn. Time	Conn. Status
OpenVPN Client Status							
Item	Value setting	Description					
OpenVPN Client Name	N/A	It displays the Client name you have entered for identification.					
Interface	N/A	It displays the WAN interface specified for the OpenVPN client connection.					
Remote IP/FQDN	N/A	It displays the peer OpenVPN Server's Public IP address (the WAN IP address) or FQDN.					
Remote Subnet	N/A	It displays the Remote Subnet specified.					
TUN/TAP Read(bytes)	N/A	It displays the TUN/TAP Read Bytes of OpenVPN Client.					
TUN/TAP Write(bytes)	N/A	It displays the TUN/TAP Write Bytes of OpenVPN Client.					
TCP/UDP Read(bytes)	N/A	It displays the TCP/UDP Read Bytes of OpenVPN Client.					
TCP/UDP Write(bytes)	N/A	It displays the TCP/UDP Write Bytes of OpenVPN Client. Connection					
Conn. Time	N/A	It displays the connection time for the corresponding OpenVPN tunnel.					

5G NR M2M Gateway

Conn. Status

N/A

It displays the connection status of the corresponding OpenVPN tunnel.
The status can be Connected, or Disconnected.

5G NR M2M Gateway

L2TP Server/Client Status

L2TP Server/Client Status shows the configuration for establishing L2TP tunnel and current connection status.

ID	User Name	Remote IP	Remote Virtual IP	Remote Call ID	Conn. Time	Status
----	-----------	-----------	-------------------	----------------	------------	--------

L2TP Server Status		
Item	Value setting	Description
User Name	N/A	It displays the login name of the user used for the connection.
Remote IP	N/A	It displays the public IP address (the WAN IP address) of the connected L2TP client.
Remote Virtual IP	N/A	It displays the IP address assigned to the connected L2TP client.
Remote Call ID	N/A	It displays the L2TP client Call ID.
Conn. Time	N/A	It displays the connection time for the L2TP tunnel.
Status	N/A	It displays the Status of each of the L2TP client connection. The status displays Connected, Disconnect, Connecting
Edit	N/A	Click on Edit Button to change L2TP server setting, web-based utility will take you to the L2TP server page. (Security > VPN > L2TP tab)

ID	L2TP Client Name	Interface	Virtual IP	Remote IP/FQDN	Default Gateway/Remote Subnet	Conn. Time	Status
----	------------------	-----------	------------	----------------	-------------------------------	------------	--------

L2TP Client Status		
Item	Value setting	Description
Client Name	N/A	It displays Name for the L2TP Client specified.
Interface	N/A	It displays the WAN interface with which the gateway will use to request PPTP tunneling connection to the PPTP server.
Virtual IP	N/A	It displays the IP address assigned by Virtual IP server of L2TP server.
Remote IP/FQDN	N/A	It displays the L2TP Server's Public IP address (the WAN IP address) or FQDN.
Default Gateway/Remote Subnet	N/A	It displays the specified IP address of the gateway device used to connect to the internet to connect to the L2TP server –the default gateway. Or other specified subnet if the default gateway is not used to connect to the L2TP server –the remote subnet.
Conn. Time	N/A	It displays the connection time for the L2TP tunnel.
Status	N/A	It displays the Status of the VPN connection. The status displays Connected, Disconnect, and Connecting.
Edit	N/A	Click on Edit Button to change L2TP client setting, web-based utility will take you to the L2TP client page. (Security > VPN > L2TP tab)

5G NR M2M Gateway

PPTP Server/Client Status

PPTP Server/Client Status shows the configuration for establishing PPTP tunnel and current connection status.

PPTP Server Status Edit						
ID	User Name	Remote IP	Remote Virtual IP	Remote Call ID	Conn. Time	Status
PPTP Server Status						
Item	Value setting	Description				
User Name	N/A	It displays the login name of the user used for the connection.				
Remote IP	N/A	It displays the public IP address (the WAN IP address) of the connected PPTP client.				
Remote Virtual IP	N/A	It displays the IP address assigned to the connected PPTP client.				
Remote Call ID	N/A	It displays the PPTP client Call ID.				
Conn. Time	N/A	It displays the connection time for the PPTP tunnel.				
Status	N/A	It displays the Status of each of the PPTP client connection. The status displays Connected, Disconnect, and Connecting.				
Edit Button	N/A	Click on Edit Button to change PPTP server setting, web-based utility will take you to the PPTP server page. (Security > VPN > PPTP tab)				

PPTP Client Status Edit							
ID	PPTP Client Name	Interface	Virtual IP	Remote IP/FQDN	Default Gateway/Remote Subnet	Conn. Time	Status
PPTP Client Status							
Item	Value setting	Description					
Client Name	N/A	It displays Name for the PPTP Client specified.					
Interface	N/A	It displays the WAN interface with which the gateway will use to request PPTP tunneling connection to the PPTP server.					
Virtual IP	N/A	It displays the IP address assigned by Virtual IP server of PPTP server.					
Remote IP/FQDN	N/A	It displays the PPTP Server's Public IP address (the WAN IP address) or FQDN.					
Default Gateway / Remote Subnet	N/A	It displays the specified IP address of the gateway device used to connect to the internet to connect to the PPTP server –the default gateway. Or other specified subnet if the default gateway is not used to connect to the PPTP server –the remote subnet.					
Conn. Time	N/A	It displays the connection time for the PPTP tunnel.					
Status	N/A	It displays the Status of the VPN connection. The status displays Connected, Disconnect, and Connecting.					
Edit Button	N/A	Click on Edit Button to change PPTP client setting, web-based utility will take you to the PPTP server page. (Security > VPN > PPTP tab)					

5G NR M2M Gateway

8.3.2 Firewall Status

Go to **Status > Security > Firewall Status** Tab.

The **Firewall Status** provides user a quick view of the firewall status and current firewall settings. It also keeps the log history of the dropped packets by the firewall rule policies, and includes the administrator remote login settings specified in the Firewall Options. The display will be refreshed on every five seconds.

By clicking the icon [+], the status table will be expanded to display log history. Clicking the **Edit** button the screen will be switched to the configuration page.

Packet Filter Status

Packet Filters Edit			
Activated Filter Rule	Detected Contents	IP	Time

Packet Filter Status		
Item	Value setting	Description
Activated Filter Rule	N/A	This is the Packet Filter Rule name.
Detected Contents	N/A	This is the logged packet information, including the source IP, destination IP, protocol, and destination port –the TCP or UDP. String format: Source IP to Destination IP : Destination Protocol (TCP or UDP)
IP	N/A	The Source IP (IPv4) of the logged packet.
Time	N/A	The Date and Time stamp of the logged packet. Date & time format. ("Month" "Day" "Hours":"Minutes":"Seconds")

Note: Ensure Packet Filter Log Alert is enabled.

*Refer to **Security > Firewall > Packet Filter** tab. Check Log Alert and save the setting.*

URL Blocking Status

URL Blocking Edit			
Activated Blocking Rule	Blocked URL	IP	Time

URL Blocking Status		
Item	Value setting	Description
Activated Blocking Rule	N/A	This is the URL Blocking Rule name.
Blocked URL	N/A	This is the logged packet information.
IP	N/A	The Source IP (IPv4) of the logged packet.

5G NR M2M Gateway

Time	N/A	The Date and Time stamp of the logged packet. Date & time format. ("Month" "Day" "Hours":"Minutes":"Seconds")
-------------	-----	---

Note: Ensure URL Blocking Log Alert is enabled.

Refer to **Security > Firewall > URL Blocking** tab. Check Log Alert and save the setting.

Web Content Filter Status

Web Content Filters Edit			
Activated Filter Rule	Detected Contents	IP	Time

Web Content Filter Status		
Item	Value setting	Description
Activated Filter Rule	N/A	Logged packet of the rule name. String format.
Detected Contents	N/A	Logged packet of the filter rule. String format.
IP	N/A	Logged packet of the Source IP. IPv4 format.
Time	N/A	Logged packet of the Date Time. Date time format ("Month" "Day" "Hours":"Minutes":"Seconds")

Note: Ensure Web Content Filter Log Alert is enabled.

Refer to **Security > Firewall > Web Content Filter** tab. Check Log Alert and save the setting.

MAC Control Status

MAC Control Edit			
Activated Control Rule	Blocked MAC Addresses	IP	Time

MAC Control Status		
Item	Value setting	Description
Activated Control Rule	N/A	This is the MAC Control Rule name.
Blocked MAC Addresses	N/A	This is the MAC address of the logged packet.
IP	N/A	The Source IP (IPv4) of the logged packet.
Time	N/A	The Date and Time stamp of the logged packet. Date & time format. ("Month" "Day" "Hours":"Minutes":"Seconds")

Note: Ensure MAC Control Log Alert is enabled.

Refer to **Security > Firewall > MAC Control** tab. Check Log Alert and save the setting.

5G NR M2M Gateway

Application Filters Status

Application Filters			
Filtered Application Category	Filtered Application Name	IP	Time
Application Filters Status			
Item	Value setting	Description	
Filtered Application Category	N/A	The name of the Application Category being blocked.	
Filtered Application Name	N/A	The name of the Application being blocked.	
IP	N/A	The Source IP (IPv4) of the logged packet.	
Time	N/A	The Date and Time stamp of the logged packet. Date & time format. ("Month" "Day" "Hours":"Minutes":"Seconds")	

Note: Ensure Application Filter Log Alert is enabled.

Refer to **Security > Firewall > Application Filter** tab. Check Log Alert and save the setting.

IPS Status

IPS			
Detected Intrusion		IP	Time
IPS Firewall Status			
Item	Value setting	Description	
Detected Intrusion	N/A	This is the intrusion type of the packets being blocked.	
IP	N/A	The Source IP (IPv4) of the logged packet.	
Time	N/A	The Date and Time stamp of the logged packet. Date & time format. ("Month" "Day" "Hours":"Minutes":"Seconds")	

Note: Ensure IPS Log Alert is enabled.

Refer to **Security > Firewall > IPS** tab. Check Log Alert and save the setting.

5G NR M2M Gateway

Firewall Options Status

Options Edit			
Stealth Mode	SPI	Discard Ping from WAN	Remote Administrator Management
Disable	Disable	Disable	IP: 192.168.121.54, User Name: admin, Time: Apr 1 11:14:54

Firewall Options Status		
Item	Value setting	Description
Stealth Mode	N/A	Enable or Disable setting status of Stealth Mode on Firewall Options. String Format: Disable or Enable
SPI	N/A	Enable or Disable setting status of SPI on Firewall Options. String Format : Disable or Enable
Discard Ping from WAN	N/A	Enable or Disable setting status of Discard Ping from WAN on Firewall Options. String Format: Disable or Enable
Remote Administrator Management	N/A	Enable or Disable setting status of Remote Administrator. If Remote Administrator is enabled, it shows the currently logged in administrator's source IP address and login user name and the login time. Format: IP : "Source IP", User Name: "Login User Name", Time: "Date time" Example: IP: 192.168.127.39, User Name: admin, Time: Mar 3 01:34:13

Note: Ensure Firewall Options Log Alert is enabled.

Refer to **Security > Firewall > Options** tab. Check Log Alert and save the setting.

5G NR M2M Gateway

8.4 Administration

8.4.1 Configure & Manage Status

Go to **Status > Administration > Configure & Manage** tab.

The **Configure & Manage Status** window shows the status for managing remote network devices. The type of management available in your device is depended on the device model purchased. The commonly used ones are the SNMP, TR-069, and UPnP. The display will be refreshed on every five seconds.

SNMP Linking Status

SNMP Link Status screen shows the status of current active SNMP connections.

SNMP Linking Status						
User Name	IP Address	Port	Community	Auth. Mode	Privacy Mode	SNMP Version

SNMP Link Status		
Item	Value setting	Description
User Name	N/A	It displays the user name for authentication. This is only available for SNMP version 3.
IP Address	N/A	It displays the IP address of SNMP manager.
Port	N/A	It displays the port number used to maintain connection with the SNMP manager.
Community	N/A	It displays the community for SNMP version 1 or version 2c only.
Auth. Mode	N/A	It displays the authentication method for SNMP version 3 only.
Privacy Mode	N/A	It displays the privacy mode for version 3 only.
SNMP Version	N/A	It displays the SNMP Version employed.

SNMP Trap Information

SNMP Trap Information screen shows the status of current received SNMP traps.

SNMP Trap Information		
Trap Level	Time	Trap Event

SNMP Trap Information		
Item	Value setting	Description
Trap Level	N/A	It displays the trap level.
Time	N/A	It displays the timestamp of trap event.
Trap Event	N/A	It displays the IP address of the trap sender and event type.

5G NR M2M Gateway

TR-069 Status

TR-069 Status screen shows the current connection status with the TR-068 server.

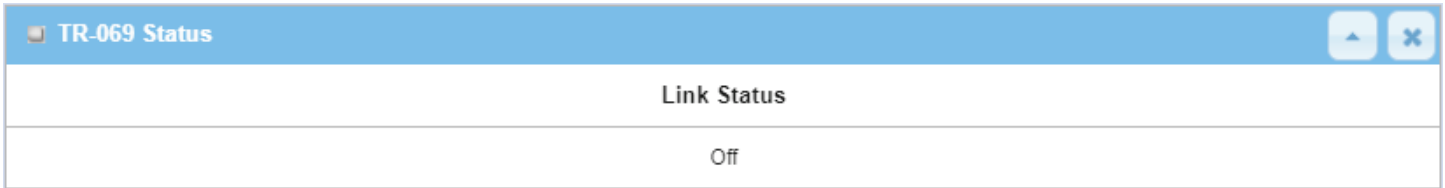

TR-069 Status	Value setting	Description
Item		
Link Status	N/A	It displays the current connection status with the TR-068 server. The connection status is either On when the device is connected with the TR-068 server or Off when disconnected.

5G NR M2M Gateway



8.4.2 Log Storage Status

Go to **Status > Administration > Log Storage** tab.

The **Log Storage Status** screen shows the status for selected device storage.

Log Storage Status

Log Storage Status screen shows the status of current the selected device storage. The status includes Device Description, Usage, File System, Speed, and status.

Storage Information  					
Device Select	Device Description	Usage	File System	Speed	Status

5G NR M2M Gateway

8.5 Statistics & Report

8.5.1 Connection Session

Go to **Status > Statistics & Reports > Connection Session** tab.

Internet Surfing Statistic shows the connection tracks on this router.

Connection Session List (2 entries) Previous Next First Last Export (.xml) Export (.csv)							
Refresh							
User Name	Protocol	Internal IP & Port	MAC	NAT-host IP & Port	External IP & Port	Duration Time	State
	TCP	192.168.123.173:51464			192.168.123.254:80	2020/10/29 03:57~	
	UDP	192.168.123.173:68			192.168.123.254:67	2020/10/29 03:57~	

Internet Surfing Statistic		
Item	Value setting	Description
Previous	N/A	Click the Previous button; you will see the previous page of track list.
Next	N/A	Click the Next button; you will see the next page of track list.
First	N/A	Click the First button; you will see the first page of track list.
Last	N/A	Click the Last button; you will see the last page of track list.
Export (.xml)	N/A	Click the Export (.xml) button to export the list to xml file.
Export (.csv)	N/A	Click the Export (.csv) button to export the list to csv file.
Refresh	N/A	Click the Refresh button to refresh the list.

5G NR M2M Gateway

8.5.2 Network Traffic

Go to **Status > Statistics & Reports > Network Traffic** tab.

Network Traffic Statistics screen shows the historical graph for the selected network interface.

You can change the interface drop list and select the interface and sampling time interval you want to monitor.

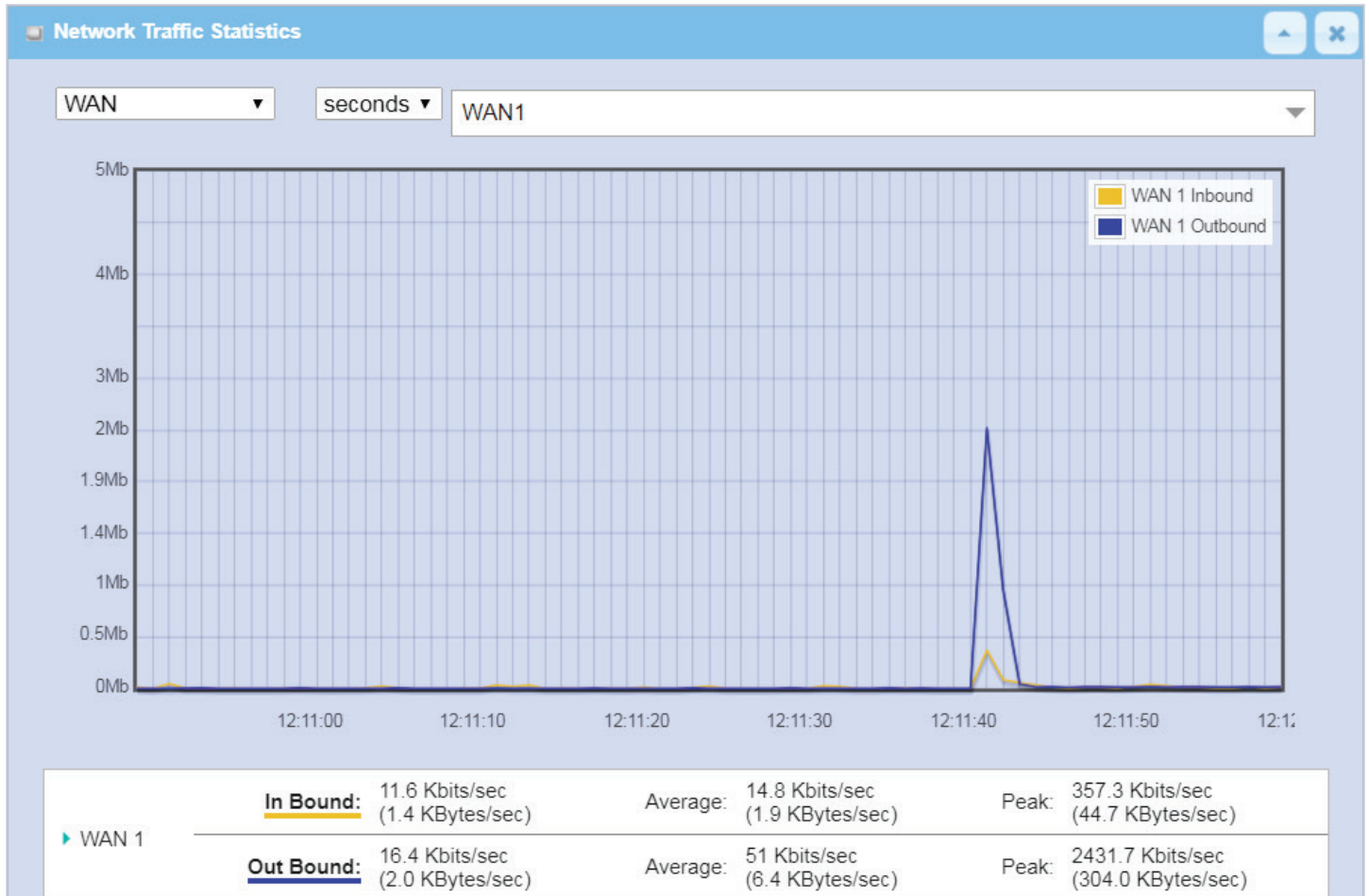

5G NR M2M Gateway

8.5.3 Login Statistics

Go to **Status > Statistics & Reports > Login Statistics**

Login Statistics shows the login information.

Device Manager Login Statistics				
Previous Next First Last Export (.xml) Export (.csv)				
Refresh				
User Name	Protocol Type	IP Address	Info	Duration Time
admin	HTTP	192.168.123.190	Admin	2018/01/01 00:00~
admin	HTTP	192.168.123.190	Admin	2018/01/01 00:02~
admin	HTTP	192.168.123.190	Login Fail	2019/06/05 16:30~
admin	HTTP	192.168.123.190	Admin	2019/06/05 16:30~

Device Manager Login Statistic Item	Value setting	Description
Previous	N/A	Click the Previous button; you will see the previous page of login statistics.
Next	N/A	Click the Next button; you will see the next page of login statistics.
First	N/A	Click the First button; you will see the first page of login statistics.
Last	N/A	Click the Last button; you will see the last page of login statistics.
Export (.xml)	N/A	Click the Export (.xml) button to export the login statistics to xml file.
Export (.csv)	N/A	Click the Export (.csv) button to export the login statistics to csv file.
Refresh	N/A	Click the Refresh button to refresh the login statistics.

5G NR M2M Gateway

8.5.4 Cellular Usage

Go to **Status > Statistics & Reports > Cellular Usage** tab.

Cellular Usage screen shows data usage statistics for the selected cellular interface. The cellular data usage can be accumulated per hour or per day.

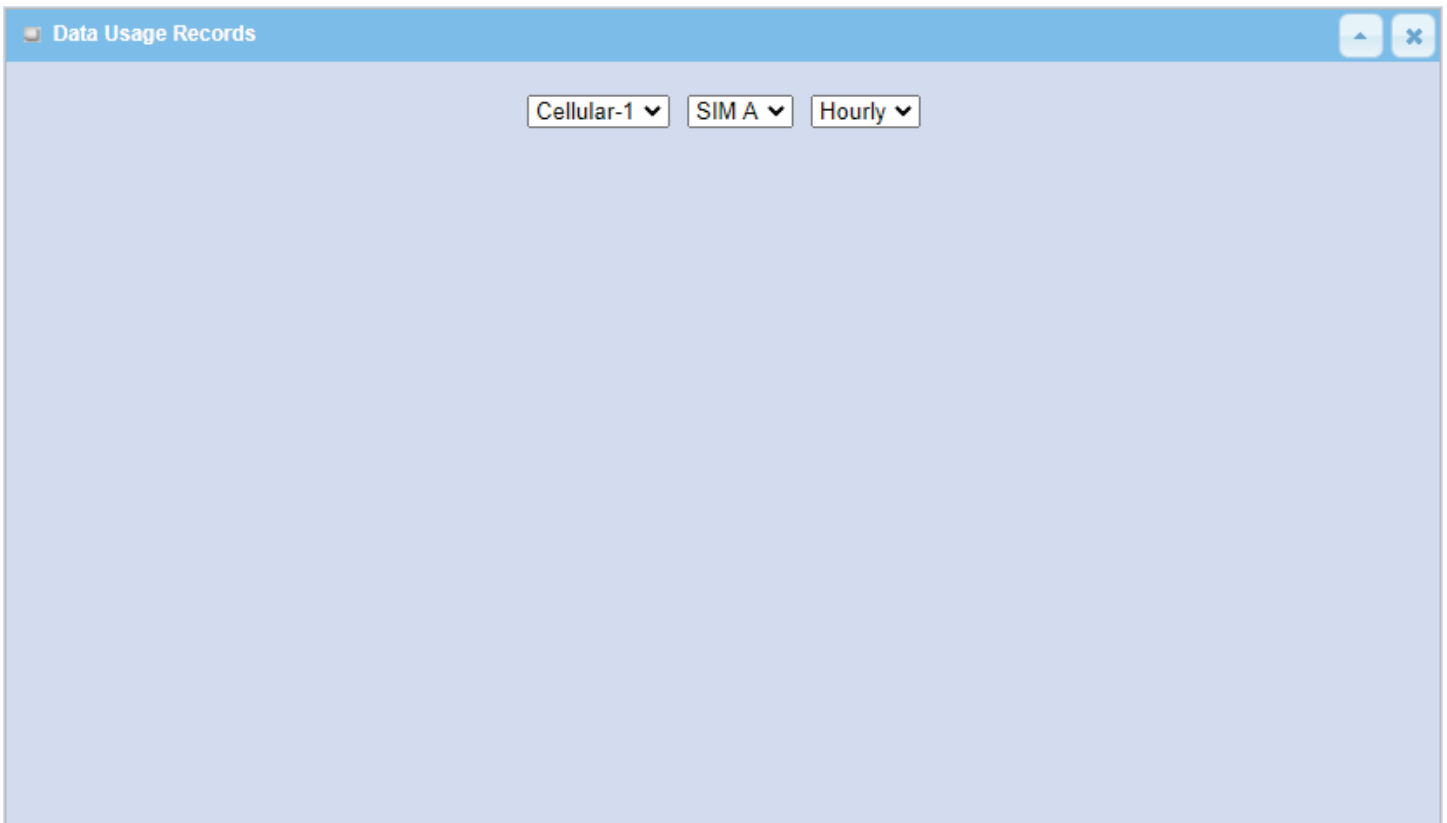

5G NR M2M Gateway

Technical Specifications	
Hardware/Port	
Device Interfaces	1 x 10/100/1000 Ethernet WAN/LAN Ports, 2 x 10/100/1000 Ethernet LAN port
LED	<p>Serial: Blue Fast Flashing: Data packets transferred via serial port</p> <p>Status: Blue OFF: Host disconnected Fast Flashing: WAN Ethernet or LTE connection established, obtaining IP</p> <p>PWR: Blue OFF: Device is powered OFF or in standby mode Steady ON: Device is powered ON Flashing once per second: Device is at "Delay OFF" mode Fast Flashing: Firmware is upgrading or device is in recovery mode</p> <p>Wi-Fi 2.4 GHz: Blue OFF: 2.4 GHz Wi-Fi is disabled Steady ON: 2.4 GHz Wi-Fi is enabled Fast Flashing: Data is being transmitted/received via 2.4 GHz Wi-Fi</p> <p>Wi-Fi 5 GHz: Blue OFF: 5 GHz Wi-Fi is disabled Steady ON: 5 GHz Wi-Fi is enabled Fast Flashing: Data is being transmitted/received via 5 GHz Wi-Fi</p> <p>5G NR & 4G LTE Cellular: Blue 5G LED Steady ON: 5G NR enabled 4G LED Steady ON: 4G LTE enabled SIM-A LED Steady ON: SIM-A is inserted for 3G/4G/5G connection SIM-A LED OFF: SIM-A is not inserted or not in use SIM-B LED Steady ON: SIM-B is inserted for 3G/4G/5G connection SIM-B LED OFF: SIM-B is not inserted or not in use SIGNAL LED Steady ON: 3G/4G/5G signal strength is at high level (>60%) SIGNAL LED Flashing: 3G/4G/5G signal strength is at low level (<60%)</p> <p>WAN/LAN1 - 3: Green Steady ON: Ethernet LAN or WAN connection is established Flash: data packets are transferring</p>
Power Supply	DC 9V / 2.7A ~ 36V / 0.7A
Ethernet	1 x 10/100/1000 Ethernet WAN/LAN port 2 x 10/100/1000 Ethernet LAN ports
SMA Antenna	4 x Female type jack for 5G NR/LTE 2 x Male type jack for Wi-Fi
Communication Bus	1 x RS-232 (Tx/Rx) 1 x RS-485 (D+(B), D-(A))
Digital I/O	2 x DI (Isolated, "Logic 0": 0~2V, "Logic 1": 5V ~ 30V) 2 x DO (Isolated, Non-Relayed Output, 24V/300 mA for each port)
Analog I/O	2 x AI (0~10V, 12 bit ADC, sampling rate up to 125 KHz)
5G NR/4G LTE Modem	
5G NR	5G NR, Sub-6 GHz, 100 MHz (BW)
4G LTE	LTE support up to Cat.20
Operating Bands	<p>5G NR Refarmed Sub-6: n1, n2, n3, n5, n7, n8, n12, n20, n28, n41, n66, n71 New Sub-6: n77, n78, n79</p> <p>LTE FDD: B1, B2, B3, B4, B5, B7, B8, B12, B13, B14, B17, B18, B19, B20, B25, B26, B28, B29, B30, B32, B66, B71</p> <p>LTE TDD: B34, B38, B39, B40, B41, B42, B46, B48</p> <p>WCDMA/HSPA+: B1, B2, B3/9, B4, B5/6/19, B8</p>
Maximum Cellular	5G NR: 900 Mbps (DL, Ethernet) / 150 Mbps (UL, Ethernet)

5G NR M2M Gateway

Data Throughput	
Interface	USB 3.0 miniPCIe
Dual SIM Slots	3V/1.8V 6-pin standard (3FF Micro SIM)
Software Specifications	
Wi-Fi (802.11)	
Standards	IEEE 802.11 ac/n/g/b/a, 2.4 GHz/5 GHz
Wi-Fi Data Rates	Up to 866 Mbps with 802.11ac clients Up to 300 Mbps with 802.11n clients
Web UI	
Web Management	English (default)
LAN Default IP Address	192.168.0.1
Default Subnet Mask	255.255.255.0
Wireless WAN	
5G NR/4G LTE	5G NR/4G LTE modem to connect to Internet
WAN Control	
WAN	Cellular & Config Ether-WAN; Failover
Cellular	3GPP, 5G NR/4G LTE, IPv4/v6
Ether-WAN	Dynamic IP, Static IP, PPPoP, PPTP, L2TP
Network Monitor	ICMP/DNS Query
Dual SIM slots for CELL	SIM A, SIM B failover
Wi-Fi	
Standard	802.11 ac/n/g/b
Mode	AP router, WDS, WDS hybrid modes
Functions	Multi-SSID, WMM
Security	WEP, WPA, WPA2, WPA-PSK, WPA2-PSK, 802.1x
Captive Portal	External web portal
2.4 GHz SSID	DWM-3010-XXXX (XXXX is last four random digits based on MAC address)
5 GHz SSID	DWM-3010-5G-XXXX (XXXX is last four random digits based on MAC address)
Auto Channel Scan	Enabled
Pre-shared Key	Random 8-character key (alphanumeric case sensitive)
Protocol	
LAN & VLAN	DHCP server/relay, port/tag based VLAN
IPv6	Dual stack, IPv4/IPv6
Port Forwarding	NAT 1-1, 1-many, transversal, DMZ, Virtual Server & Computer, VPN passthrough
Routing	Static, Dynamic - RIP1/RIP2, OSPF, BGP
QoS	Policy-based, 802.1q and TOS for priority queues
Service	
Cellular Toolkit	Data usage, SMS, SIM PIN, USSD, Network Scan
Event Handling	User-defined mgmt/notify event; action & trigger by SMS, mail, syslog, SNMP trap, Modbus, I/O
D-ECS (D-Link Edge Cloud Solution)	Remote Management of Devices, Zero Touch Deployment, Device GPS Location
Security	
VPN Tunneling	IPSec, OpenVPN, PPTP, L2TP, GRE
Scenario	Site/host to site/host; dynamic VPN
VPN Capability	IPSec up to 16 tunnels
Firewall	SPI firewall iwth stealth mode, IPS
Access Control	Packet filter, URL blocking, MAC filter
Field Com	
Virtual COM	RFC2217, TCP client, TCP server, UDP
Modbus	Gateway for Modbus TCP/RTU/ASCII Master/Slave Access; Slave for Device Status/Information Access

5G NR M2M Gateway

Administration	
Configuration	Web UI, CLI, Command Script, D-ECS (D-Link Edge Cloud Solution)
Management	SNMPv3 Std. & D-ECS (D-Link Edge Cloud Solution)
System	Upgrade, backup & restore, reboot & reset, Syslog
Diagnostics	Packet analyzer, diagnostic tools
Electrical Characteristics	
Power	
Power Input	DC 9V/2A - 36V/0.7A +/- 5%
Environmental Requirements	
Temperature	
Operating Temp./Humidity	Temperature: -30°C ~ 60°C, Humidity: 10%~95% non-condensing
Storage Temp.	Temperature: -40°C ~ 85°C, Humidity: 0%~95% non-condensing
RoHS	RoHS compliant
ID/Mechanical	
Dimensions	62 x 125 x 160 mm (w/o mounting kit)
Weight	1.15 kg
Order Information	
DWM-3010	5G NR M2M Gateway

5G NR M2M Gateway

Regulatory Information

CE EMI Class A Warning

This equipment is compliant with Class A of CISPR 32. In a residential environment this equipment may cause radio interference.

European Community Declaration of Conformity:

Česky [Czech]	Tímto D-Link Corporation prohlašuje, že tento produkt, jeho příslušenství a software jsou v souladu se směrnicí 2014/53/EU. Celý text ES prohlášení o shodě vydaného EU a o firmwaru produktu lze stáhnout na stránkách k produktu www.dlink.com .
Dansk [Danish]	D-Link Corporation erklærer herved, at dette produkt, tilbehør og software er i overensstemmelse med direktiv 2014/53/EU. Den fulde tekst i EU-overensstemmelseserklæringen og produktfirmware kan wnloades fra produksiden hos www.dlink.com .
Deutsch [German]	Hiermit erklärt die D-Link Corporation, dass dieses Produkt, das Zubehör und die Software der Richtlinie 2014/53/EU entsprechen. Der vollständige Text der Konformitätserklärung der Europäischen Gemeinschaft sowie die Firmware zum Produkt stehen Ihnen zum Herunterladen von der Produktseite im Internet auf www.dlink.com zur Verfügung.
Eesti [Estonian]	Käesolevaga kinnitab D-Link Corporation, et see toode, tarvikud ja tarkvara on kooskõlas direktiiviga 2014/53/EL. Euroopa Liidu vastavusdeklaratsiooni täistekst ja toote püsivara on allalaadimiseks saadaval tootelehel www.dlink.com .
English	Hereby, D-Link Corporation, declares that this product, accessories, and software are in compliance with directive 2014/53/EU. The full text of the EU Declaration of Conformity and product firmware are available for download from the product page at www.dlink.com
Español [Spanish]	Por la presente, D-Link Corporation declara que este producto, accesorios y software cumplen con las directivas 2014/53/UE. El texto completo de la declaración de conformidad de la UE y el firmware del producto están disponibles y se pueden descargar desde la página del producto en www.dlink.com .
Ελληνική [Greek]	Με την παρούσα, η D-Link Corporation δηλώνει ότι αυτό το προϊόν, τα αξεσουάρ και το λογισμικό συμμορφώνονται με την Οδηγία 2014/53/ΕΕ. Το πλήρες κείμενο της δήλωσης συμμόρφωσης της ΕΕ και το υλικολογισμικό του προϊόντος είναι διαθέσιμα για λήψη από τη σελίδα του προϊόντος στην τοποθεσία www.dlink.com .
Français [French]	Par les présentes, D-Link Corporation déclare que ce produit, ces accessoires et ce logiciel sont conformes aux directives 2014/53/UE. Le texte complet de la déclaration de conformité de l'UE et le microprogramme du produit sont disponibles au téléchargement sur la page des produits à www.dlink.com .
Italiano [Italian]	Con la presente, D-Link Corporation dichiara che questo prodotto, i relativi accessori e il software sono conformi alla direttiva 2014/53/UE. Il testo completo della dichiarazione di conformità UE e il firmware del prodotto sono disponibili per il download dalla pagina del prodotto su www.dlink.com .

5G NR M2M Gateway

Latviski [Latvian]	Ar šo uzņēmums D-Link Corporation apliecina, ka šis produkts, piederumi un programmatūra atbilst direktīvai 2014/53/ES. ES atbilstības deklarācijas pilno tekstu un produkta aparātprogrammatūru var lejupielādēt attiecīgā produkta lapā vietnē www.dlink.com .
Lietuvių [Lithuanian]	Šiuo dokumentu „D-Link Corporation“ pareiškia, kad šis gaminys, priedai ir programinė įranga atitinka direktyvą 2014/53/ES. Visą ES atitikties deklaracijos tekstą ir gaminio programinę aparatinę įrangą galima atsisiųsti iš gaminio puslapio adresu www.dlink.com .
Nederlands [Dutch]	Hierbij verklaart D-Link Corporation dat dit product, accessoires en software voldoen aan de richtlijnen 2014/53/EU. De volledige tekst van de EU conformiteitsverklaring en productfirmware is beschikbaar voor download van de productpagina op www.dlink.com .
Malti [Maltese]	Bil-preżenti, D-Link Corporation tiddikjara li dan il-prodott, l-aċċessorji, u s-software huma konformi mad-Direttiva 2014/53/UE. Tista' tniżżel it-test s'hiñ tad-dikjarazzjoni ta' konformità tal-UE u l-firmware tal-prodott mill-paġna tal-prodott fuq www.dlink.com .
Magyar [Hungarian]	Ezennel a D-Link Corporation kijelenti, hogy a jelen termék, annak tartozékai és szoftvere megfelelnek a 2014/53/EU sz. rendeletnek rendelkezéseinek. Az EU Megfelelőségi nyilatkozat teljes szövege és a termék firmware a termék oldaláról tölthető le a www.dlink.com címen.
Polski [Polish]	D-Link Corporation niniejszym oświadcza, że ten produkt, akcesoria oraz oprogramowanie są zgodne z dyrektywami 2014/53/EU. Pełen tekst deklaracji zgodności UE oraz oprogramowanie sprzętowe do produktu można pobrać na stronie produktu w witrynie www.dlink.com .
Português [Portuguese]	Desta forma, a D-Link Corporation declara que este produto, os acessórios e o software estão em conformidade com a diretiva 2014/53/UE. O texto completo da declaração de conformidade da UE e do firmware
Slovensko[Slovenian]	Podjetje D-Link Corporation s tem izjavlja, da so ta izdelki, dodatna oprema in programska oprema skladni z direktivami 2014/53/EU. Celotno besedilo izjave o skladnosti EU in vdelana programska oprema sta na voljo za prenos na strani izdelka na www.dlink.com .
Slovensky [Slovak]	Spoločnosť D-Link týmto vyhlasuje, že tento produkt, príslušenstvo a softvér sú v súlade so smernicou 2014/53/EÚ. Úplné znenie vyhlásenia EÚ o zhode a firmvéri produktu sú k dispozícii na prevzatie zo stránky produktu www.dlink.com .
Suomi [Finnish]	D-Link Corporation täten vakuuttaa, että tämä tuote, lisävarusteet ja ohjelmisto ovat direktiivin 2014/53/EU vaatimusten mukaisia. Täydellinen EU-vaatimustenmukaisuusvakuutus samoin kuin tuotteen laiteohjelmisto ovat ladattavissa osoitteesta www.dlink.com .
Svenska[Swedish]	D-Link Corporation försäkrar härmed att denna produkt, tillbehör och programvara överensstämmer med direktiv 2014/53/EU. Hela texten med EU-försäkran om överensstämmelse och produkt-firmware kan hämtas från produktsidan på www.dlink.com .
Íslenska [Icelandic]	Hér með lýsir D-Link Corporation því yfir að þessi vara, fylgihlutir og hugbúnaður eru í samræmi við tilskipun 2014/53/EB. Sækja má ESB-samræmisýfirlýsinguna í heild sinni og fastbúnað vörunnar af vefsíðu vörunnar á www.dlink.com .

5G NR M2M Gateway

Norsk [Norwegian]

Herved erklærer D-Link Corporation at dette produktet, tilbehøret og programvaren er i samsvar med direktivet 2014/53/EU. Den fullstendige teksten i EU-erklæring om samsvar og produktets fastvare er tilgjengelig for nedlasting fra produktsiden på www.dlink.com.