



Quick Installation Guide

Full HD Mini Fixed Dome Network Camera

This document will guide you through the basic installation process for your new D-Link Network Camera.

DCS-6210

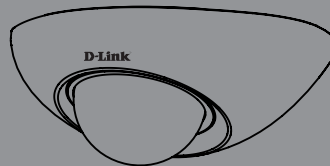

Quick Installation Guide
Руководство по быстрой установке
Guía de Instalación Rápida
Guia de Instalação Rápida
快速安裝指南
Petunjuk Pemasangan Cepat

Documentation also available on
CD and via the D-Link Website



DCS-6210 Quick Install Guide

This installation guide provides basic instructions for installing the DCS-6210 Network Camera on your network. For additional information about how to use the camera, please see the User's Manual which is available on the CD included in this package or from the D-Link support website.

Installation Steps

1. Verify the package contents against the list below.
2. Hardware Overview
3. SD Card Installation
4. Hardware Installation
5. Configuration with Wizard
6. Adjusting the lens 3-axis angle

1. Package Contents

- DCS-6210 Network camera
- Manual and Software on CD-ROM
- Quick Installation Guide
- Power Adaptor
- CAT-5 Ethernet cable
- Screwdriver and Screws for installation
- Alignment Sticker
- Rubbers

If any of the above items are missing, please contact your reseller.

Safety Notice:

Installation and servicing should be done by certified technicians so as to conform to all local codes and prevent voiding your warranty.

2. Hardware Overview

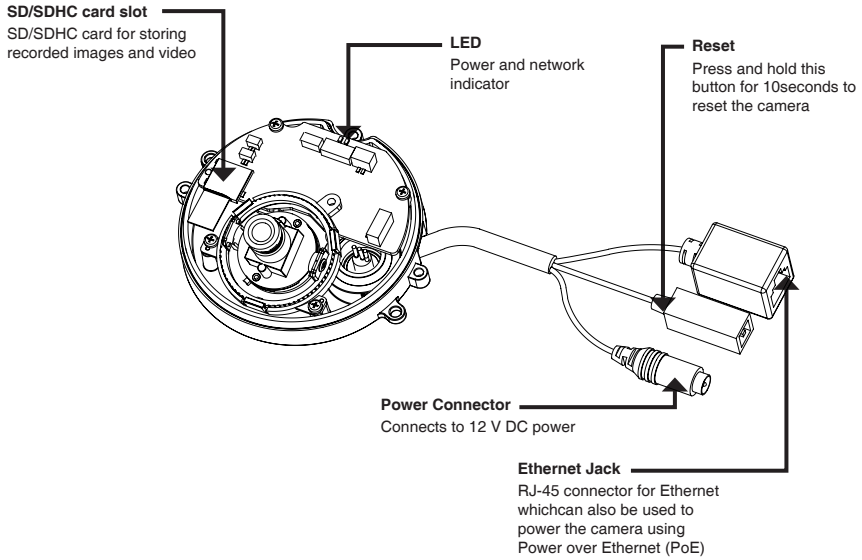

3. SD Card Installation

Disassemble the Camera

Open the camera enclosure by loosening the 3 screws. Lift the dome off the base of the camera.

Install the SD Card

Push the SD card into the camera with the gold contacts oriented towards the base of the camera. To eject the SD card, push the SD card into the slot.

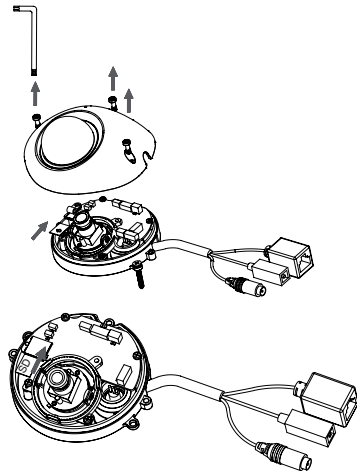

4. Hardware Installation

Mounting Installation

Please see the User Manual for detailed instructions regarding installation and mounting of the camera.

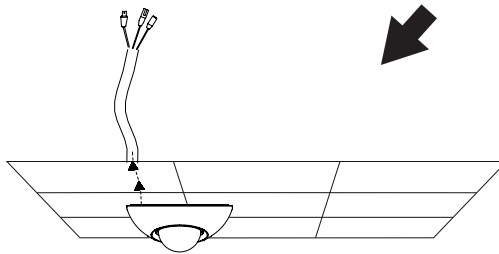
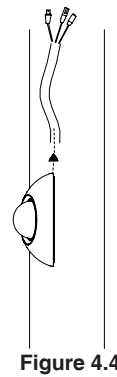
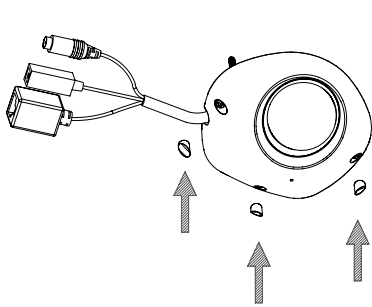
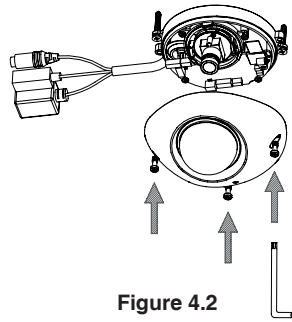
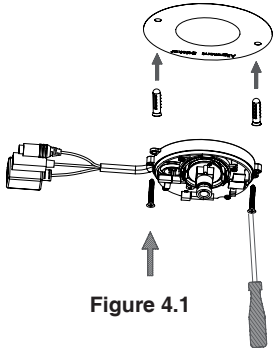

General Connection Using 12 V DC Power Adapter

1. Connect the network camera to a hub via an Ethernet cable.
2. Connect the supplied power cable from the camera to a power outlet.

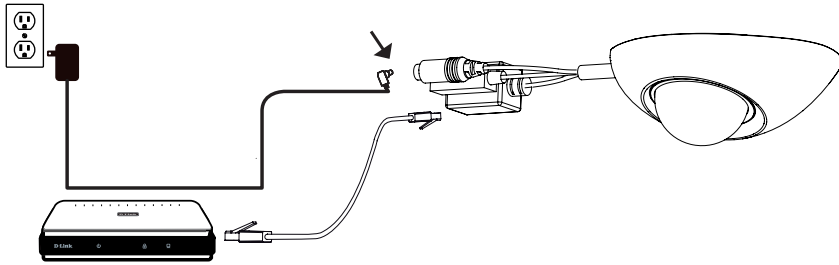

Connection with a PoE Hub

If you are using a PoE hub, connect the IP camera to the hub via an Ethernet cable, which will provide transmission of both power and data over a single cable.

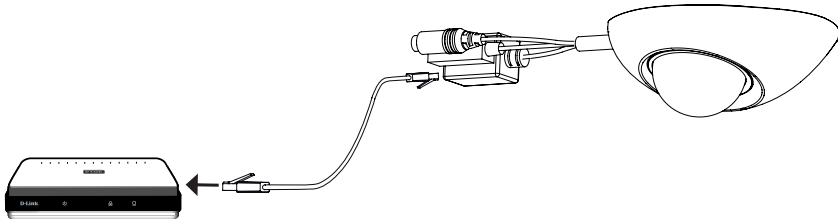

5. Configuration with Wizard

Insert the DCS-6210 CD into your computer's CD-ROM drive to begin the installation. If the Autorun function on your computer is disabled, or if the D-Link Launcher fails to start automatically, click **Start > Run**. Type **D:\autorun.exe**, where D: represents the drive letter of your CD-ROM drive.

Click **Setup Wizard** to begin the installation.



After clicking Setup Wizard, the following window will open.

Click **Next** to continue.

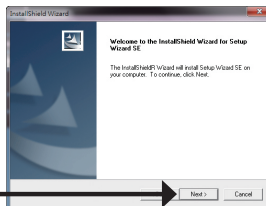

Click **Yes** to accept the License Agreement.

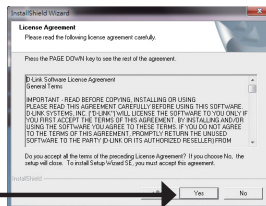

To start the installation process, click **Next**.

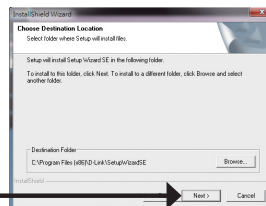

Note: The installation may take several minutes to finish.

Click **Finish** to complete the installation.

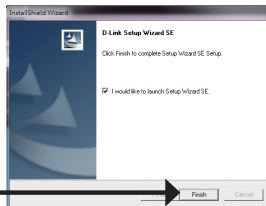

Click on the **D-Link Setup Wizard SE** icon that was created in your Windows Start menu.

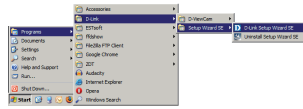

Start > D-Link > Setup Wizard SE

The Setup Wizard will appear and display the MAC address and IP address of your camera(s). If you have a DHCP server on your network, a valid IP Address will be displayed. If your network does not use a DHCP server, the network camera's default static IP **192.168.0.20** will be displayed.

Click the **Wizard** button to continue.

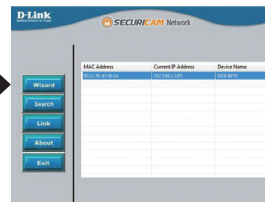

Enter the Admin ID and password. When logging in for the first time, the default Admin ID is **admin** with the password left blank.

Click **Next**, to proceed to the next page.



Select DHCP if your camera obtains an IP address automatically when it boots up. Select static IP if the camera will use the same IP address each time it is started.

Click **Next**, to proceed to the next page.

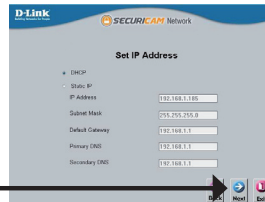

Take a moment to confirm your settings and click **Restart**.

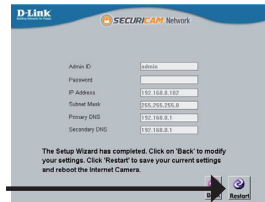

Viewing Camera via Web Browser

Click on the **D-Link Setup Wizard SE** icon that was created in your Windows Start menu.

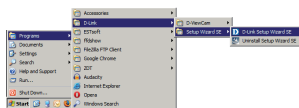

Start > D-Link > Setup Wizard SE

Select the camera and click the button labeled **"Link"** to access the web configuration.

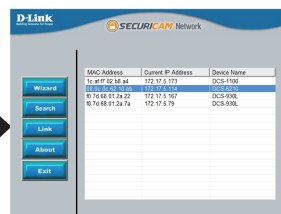

The Setup Wizard will automatically open your web browser to the IP address of the camera.

Enter **admin** as the default username and leave the password blank. Click **OK** to continue.

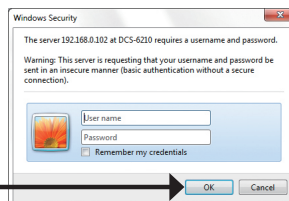

This section shows your camera's live video. You can select your video profile and view or operate the camera. For additional information about web configuration, please refer to the user manual included on the CD-ROM or the D-Link website.



6. Adjusting the lens 3-axis angel

Adjust the Viewing Angle of the 3-axis Mechanism

Turn the lens module left and right until the desired position is achieved.

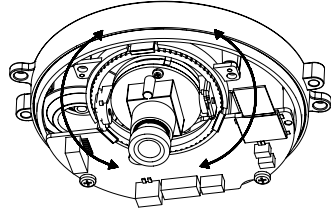

Turn the lens up and down until the desired position is achieved.

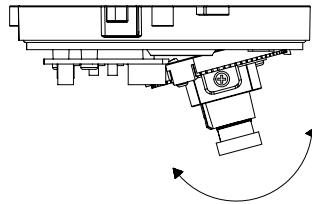

Turn the lens to adjust the IP camera's image until the desired orientation is achieved.

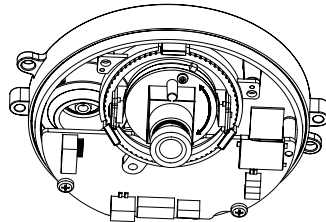

TECHNICAL SUPPORT

You can find software updates and user documentation on the D-Link website.

Tech Support for customers in

Australia:

Tel: 1300-766-868
24/7 Technical Support
Web: <http://www.dlink.com.au>
E-mail: support@dlink.com.au

India:

Tel: +91-22-27626600
Toll Free 1800-22-8998
Web: www.dlink.co.in
E-Mail: helpdesk@dlink.co.in

Singapore, Thailand, Indonesia, Malaysia, Philippines, Vietnam:

Singapore - www.dlink.com.sg
Thailand - www.dlink.co.th
Indonesia - www.dlink.co.id
Malaysia - www.dlink.com.my
Philippines - www.dlink.com.ph
Vietnam - www.dlink.com.vn

Korea:

Tel : +82-2-2028-1810
Monday to Friday 9:00am to 6:00pm
Web : <http://d-link.co.kr>
E-mail : g2b@d-link.co.kr

New Zealand:

Tel: 0800-900-900
24/7 Technical Support
Web: <http://www.dlink.co.nz>
E-mail: support@dlink.co.nz

South Africa and Sub Sahara Region:

Tel: +27 12 661 2025
08600 DLINK (for South Africa only)
Monday to Friday 8:30am to 9:00pm South Africa Time
Web: <http://www.d-link.co.za>
E-mail: support@d-link.co.za

Saudi Arabia [KSA]:

Tel: +966 01 217 0008
Fax: +966 01 217 0009
Saturday to Wednesday 9.30AM to 6.30PM
Thursdays 9.30AM to 2.00 PM
E-mail: Support.sa@dlink-me.com

D-Link Middle East - Dubai, U.A.E.

Plot No. S31102,
Jebel Ali Free Zone South,
P.O.Box 18224, Dubai, U.A.E.
Tel: +971-4-8809022
Fax: +971-4-8809066 / 8809069
Technical Support: +971-4-8809033
General Inquiries: info.me@dlink-me.com
Tech Support: support.me@dlink-me.com

Egypt

1, Makram Ebeid Street - City Lights Building
Nasrcity - Cairo, Egypt
Floor 6, office C2
Tel.: +2 02 26718375 - +2 02 26717280
Technical Support: +2 02 26738470
General Inquiries: info.eg@dlink-me.com
Tech Support: support.eg@dlink-me.com

Kingdom of Saudi Arabia

Office # 84 ,
Al Khaleej Building (Mujamathu Al-Khaleej)
Opp. King Fahd Road, Olaya
Riyadh - Saudi Arabia
Tel: +966 1 217 0008
Technical Support:
+966 1 2170009 / +966 2 6522951
General Inquiries: info.sa@dlink-me.com
Tech Support: support.sa@dlink-me.com

Pakistan

Islamabad Office:
61-A, Jinnah Avenue, Blue Area,
Suite # 11, EBC, Saudi Pak Tower,
Islamabad - Pakistan
Tel.: +92-51-2800397, 2800398
Fax: +92-51-2800399

Karachi Office:

D-147/1, KDA Scheme # 1,
Opposite Mudassir Park, Karsaz Road,
Karachi - Pakistan
Phone: +92-21-34548158, 34326649
Fax: +92-21-4375727
Technical Support: +92-21-34548310, 34305069
General Inquiries: info.pk@dlink-me.com
Tech Support: support.pk@dlink-me.com

TECHNICAL SUPPORT

Iran

Unit 5, 5th Floor, No. 20, 17th Alley , Bokharest
 St. , Argentine Sq. ,
 Tehran IRAN
 Postal Code : 1513833817
 Tel: +98-21-88880918,19
 +98-21-88706653,54
 General Inquiries: info.ir@dlink-me.com
 Tech Support: support.ir@dlink-me.com

Morocco

M.I.T.C
 Route de Nouaceur angle RS et CT 1029
 Bureau N° 312 ET 337
 Casablanca , Maroc
 Phone : +212 663 72 73 24
 Email: support.na@dlink-me.com

Lebanon RMA center

Dbayeh/Lebanon
 PO Box:901589
 Tel: +961 4 54 49 71 Ext:14
 Fax: +961 4 54 49 71 Ext:12
 Email: taoun@dlink-me.com

Bahrain

Technical Support: +973 1 3332904

Kuwait:

Technical Support: + 965 22453939 / +965
 22453949

Türkiye Merkez İrtibat Ofisi

Ayazağa Maslak yolu
 Erdebil Cevahir İş Merkezi No: 5/A Ayazağa /
 Maslak İstanbul
 Tel: +90 212 2895659
 Ücretsiz Müşteri Destek Hattı: 0 800 211 00 65
 Web:www.dlink.com.tr
 Teknik Destek: support.tr@dlink.com.tr

ISRAEL

מטלון סנטר
 רח' המגשימים 20
 קרית מטלון, פ"ת 49348
 ת.ד. 7060
 טלפון: 073-796-2797
 אי-מאיל כללי: info@dlink.co.il
 אי-מאיל תמיכה: support@dlink.co.il

Руководство по быстрой установке

Руководство по установке содержит основные инструкции по установке новой сетевой камеры DCS-6210. За дополнительной информацией по установке камеры, пожалуйста, обратитесь к руководству пользователя на CD-диске, входящем в комплект поставки, или на сайте технической поддержки D-Link.

Шаги установки

1. Проверьте содержимое комплекта поставки по списку ниже.
2. Обзор устройства
3. Установка SD-карты
4. Установка устройства
5. Настройка с помощью мастера по установке
6. Регулировка 3-х осевой линзы

1. Комплект поставки

- Сетевая камера DCS-6210
- Руководство пользователя и программное обеспечение на CD-диске
- Краткое руководство по установке
- Адаптер питания
- Ethernet-кабель 5 категории
- Отвертка и винты для установки
- Выравнивающий стикер
- Резиновые уплотнители

Если что-либо из перечисленного отсутствует, пожалуйста, обратитесь к продавцу.

Примечание по безопасности:

Установка и обслуживание устройства должны выполняться сертифицированным специалистом в соответствии с местными законами и с сохранением гарантии.

2. Обзор устройства

Слот для карты SD/SDHC

Карта SD/SDHC для хранения записанных изображений и видео

Индикаторы
дикатор питания
и сети

Сброс

Нажмите и удерживайте эту кнопку в течение 10 секунд, чтобы сбросить камеру к настройкам по умолчанию

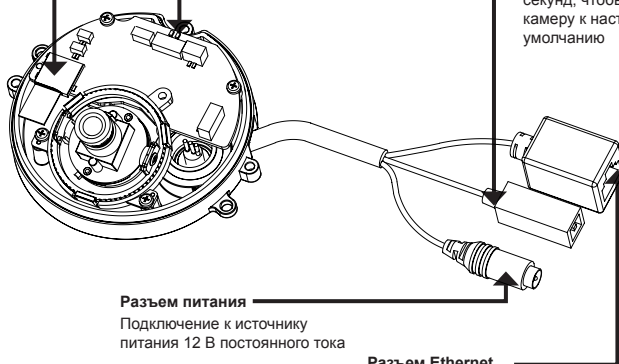

Разъем питания
Подключение к источнику
питания 12 В постоянного тока

Разъем Ethernet
Разъем RJ-45 для Ethernet,
который также может
использоваться для питания
камеры с помощью технологии
Power over Ethernet (PoE)

3. Установка SD-карты

Демонтируйте камеру

Откройте корпус камеры, ослабив 3 винта. Снимите купол с основания камеры.

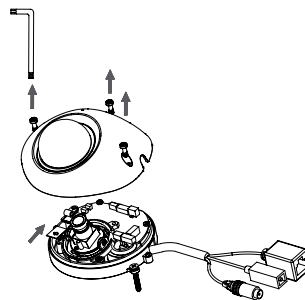

Установка SD-карты

Установите SD-карту в слот для карты золотыми контактами вверх. Чтобы извлечь SD-карту, нажмите на нее.

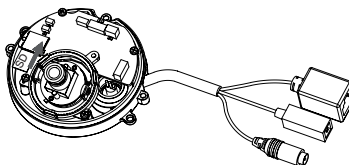

4. Аппаратная установка

Монтаж

За подробной информацией относительно установки и монтажа камеры с помощью монтажного кронштейна, пожалуйста, обратитесь к руководству пользователя.



Рисунок 4.1



Рисунок 4.2

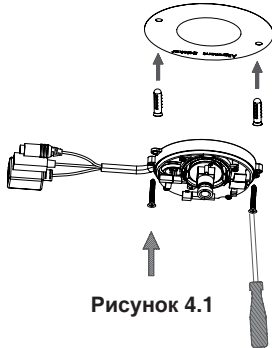

Рисунок 4.3

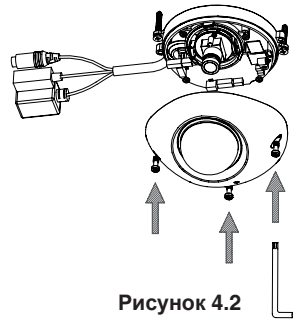

Рисунок 4.4

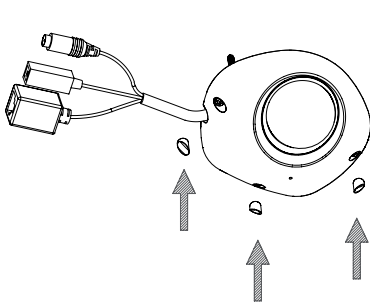

Рисунок 4.5

Основное подключение с помощью адаптера питания постоянного тока 12 В

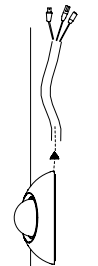
1. Подключите сетевую камеру к концентратору через кабель Ethernet.
2. Подключите кабель питания от камеры к настенной розетке.

**Подключение к концентратору PoE**

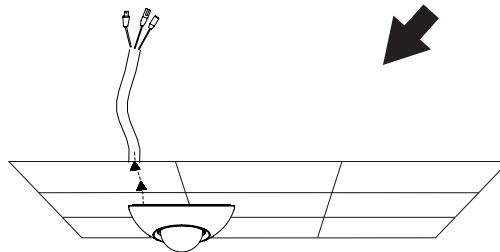
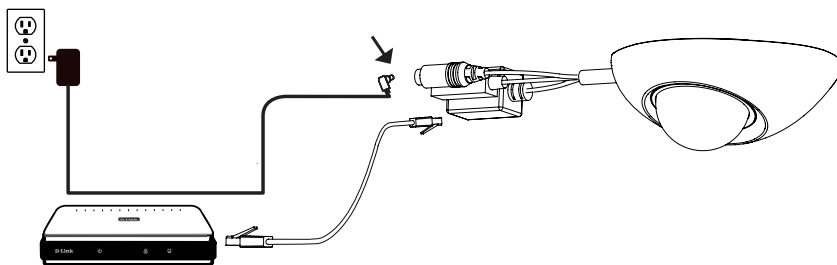
Если используется концентратор PoE, то подключите IP-камеру к концентратору с помощью Ethernet-кабеля, который обеспечивает передачу питания и данных по одному кабелю.

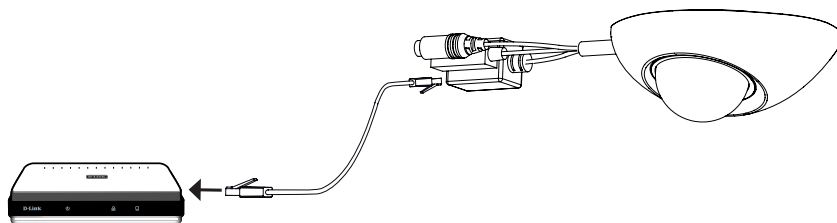

5. Настройка с помощью мастера по установке

Разместите CD-диск DCS-6210 в привод CD-ROM. Если на компьютере отключена функция автоматического запуска или запуск не произошел автоматически, нажмите **Пуск > Выполнить**. Введите **D:\autorun.exe**, где D: - имя привода CD-ROM.

Нажмите **Setup Wizard**, чтобы начать установку.



После нажатия на Setup Wizard появится следующее окно.

Нажмите **Next** для продолжения.

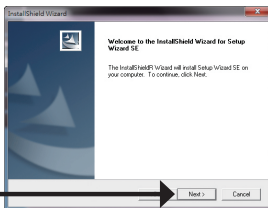

Нажмите **Yes**, чтобы принять условия лицензионного соглашения.

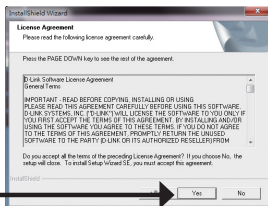

Чтобы начать процесс установки, нажмите **Next**.

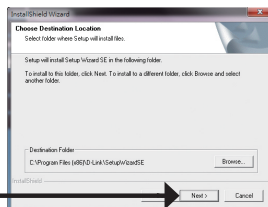

Примечание: Установка может занять несколько минут.

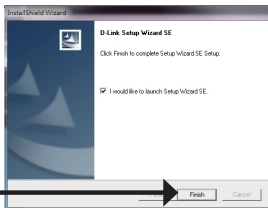

Нажмите **Finish** для завершения установки.

РУССКИЙ

Нажмите на иконку **D-Link Setup Wizard SE**, которая была создана в стартовом меню Windows.

Пуск > D-Link > Setup Wizard SE

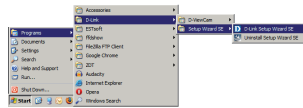

РУССКИЙ

Появится окно мастера установки с MAC-адресом и IP-адресом камеры (камер). Если в сети используется DHCP-сервер, то будет отображен действительный IP-адрес. Если же в сети не используется DHCP-сервер, то отобразится статический IP-адрес камеры по умолчанию: **192.168.0.20**.

Нажмите кнопку **Wizard** для продолжения.



Введите Admin ID и пароль. Для первой регистрации значение Admin ID по умолчанию **admin**, пароль оставьте пустым.

Нажмите **Next** для перехода на следующую страницу.

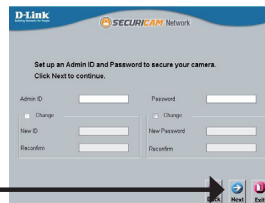

Выберите DHCP, если камера автоматически получает IP-адрес при загрузке. Выберите статический IP-адрес, если камера использует постоянный IP-адрес при каждой загрузке.

Нажмите **Next** для перехода на следующую страницу.



Подождите несколько минут для сохранения настроек и нажмите кнопку **Restart**.

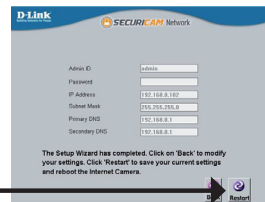

Обзор камеры через web-браузер

Нажмите иконку **D-Link Setup Wizard SE** в стартовом меню Windows.

Пуск > D-Link > Setup Wizard SE

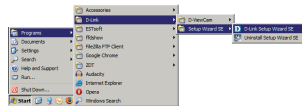

Выберите камеру и нажмите кнопку **"Link" (Соединение)** для доступа к web-настройкам.

Мастер установки автоматически откроет web-браузер с IP-адресом камеры.



Введите **admin** имени пользователя по умолчанию и оставьте поле с паролем пустым. Нажмите **ОК** для продолжения.

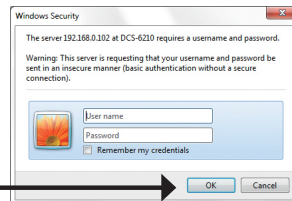

В данном разделе доступен просмотр изображений с камеры в реальном времени. Можно выбрать профиль видео для просмотра или управления камерой. Для получения дополнительной информации о web-настройках, пожалуйста, обратитесь к руководству пользователя на CD-диске или web-сайте D-Link.



РУССКИЙ

6. Регулировка 3-х осевой линзы

Регулировка угла обзора 3-х осевого механизма

Поворачивайте объектив влево и вправо, пока он не будет установлен в требуемом положении.

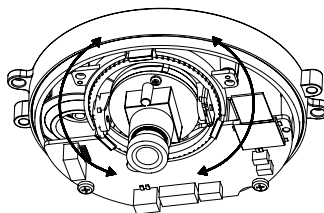

Поворачивайте объектив вверх и вниз, пока он не будет установлен в требуемом положении.

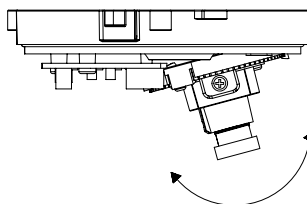

Поворачивайте объектив, чтобы отрегулировать захватываемое IP-камерой изображение, пока не будет достигнута требуемая ориентация.

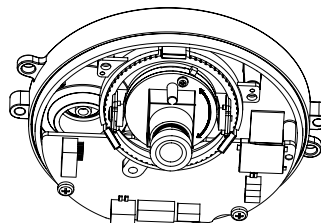

ТЕХНИЧЕСКАЯ ПОДДЕРЖКА

Обновления программного обеспечения и документация доступны на Интернет-сайте D-Link. D-Link предоставляет бесплатную поддержку для клиентов в течение гарантийного срока.

Клиенты могут обратиться в группу технической поддержки D-Link по телефону или через Интернет.

Техническая поддержка D-Link:

+7(495) 744-00-99

Техническая поддержка через Интернет

<http://www.dlink.ru>

e-mail: support@dlink.ru

РУССКИЙ

ОФИСЫ

Украина,

04080 г. Киев , ул. Межигорская, 87-А, офис 18

Тел.: +38 (044) 545-64-40

E-mail: kiev@dlink.ru

Беларусь

220114, г. Минск, проспект Независимости, 169, БЦ "XXI Век"

Тел.: +375(17) 218-13-65

E-mail: minsk@dlink.ru

Казахстан,

050008, г. Алматы, ул. Курмангазы, дом 143

(ул. Муканова)

Тел./факс: +7 727 378-55-90

E-mail: almaty@dlink.ru

Узбекистан

100015, г.Ташкент, ул. Нукусская, 89

Тел./Факс: +998 (71) 120-3770, 150-2646

E-mail: tashkent@dlink.ru

Армения

0038, г. Ереван, ул. Абеяна, 6/1, 4 этаж

Тел./Факс: + 374 (10) 398-667

E-mail: erevan@dlink.ru

Грузия

0162, г. Тбилиси,

проспект Чавчавадзе 74, 10 этаж

Тел./Факс: + 995 (32) 244-563

Lietuva

09120, Vilnius, Žirmūnų 139-303

Tel./faks. +370 (5) 236-3629

E-mail: info@dlink.lt

Eesti

Peterburi tee 46-205

11415, Tallinn, Eesti , Susi Bürookeskus

tel +372 613 9771

e-mail: info@dlink.ee

Latvija

Mazā noietņu 45/53 (ieeja no Nāras ielas)

LV-1002, Rīga

tel.: +371 6 7618703 +371 6 7618703

e-pasts: info@dlink.lv

Guía de Instalación Rápida DCS-6210

Esta guía de instalación entrega instrucciones básicas para la instalación de la cámara DCS-6210 en su Red. Para información adicional sobre cómo usar la cámara, por favor refiérase al Manual de Usuario el cual se encuentra disponible en el CD incluido en este empaque o desde el sitio Web de Soporte D-Link.

Pasos de Instalación

1. Verifique el contenido del empaque con la siguiente lista:
2. Descripción de Hardware
3. Instalación de Tarjeta SD
4. Instalación de Hardware
5. Configuración con Asistente
6. Ajustando el Ángulo del Lente 3-axis

1. Contenido del empaque

- Cámara de Red DCS-6210
- Manual y Software en CD-ROM
- Guía de instalación Rápida
- Fuente de alimentación
- Cable Ethernet CAT-5
- Destornillador y Tornillos para instalación
- Etiqueta para alineación
- Gomas

Si alguno de los ítems no se encuentra, por favor contacte a su vendedor.

Aviso de Seguridad:

La Instalación y servicio debe ser realizado por técnicos certificados con el fin de cumplir todas las normas locales y no invalidar la garantía.

2. Descripción de Hardware

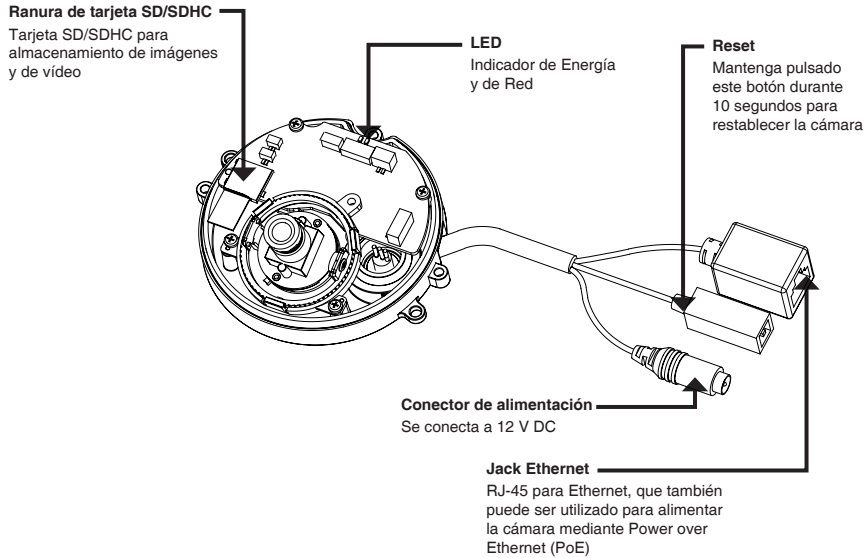

ESPAÑOL

3. Instalación de Tarjeta SD

Desmontar la cámara

Abra la cubierta de la cámara aflojando los 3 tornillos. Levantar la cúpula de la base de la cámara.

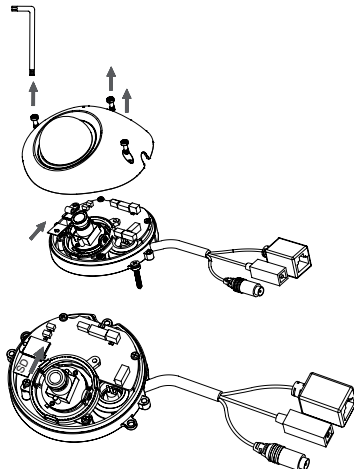

Instalar la Tarjeta SD

Presione la tarjeta SD en la cámara con los contactos dorados orientados a la base de la cámara. Para quitar la tarjeta SD, presione la tarjeta y la podrá sacar.

4. Instalación de Hardware

Instalación del Montaje

Por favor vea el Manual de Usuario para instrucciones detalladas para la instalación y montaje de la cámara usando el soporte de montaje.

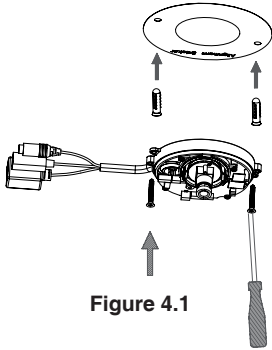

Figure 4.1

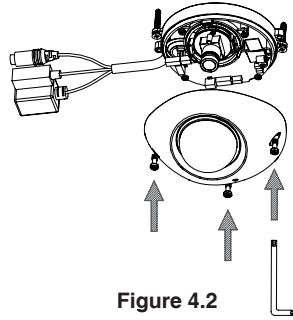

Figure 4.2

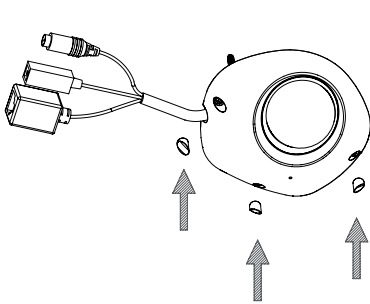

Figure 4.3

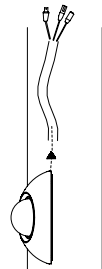

Figure 4.4

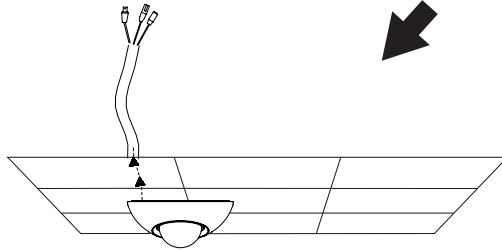
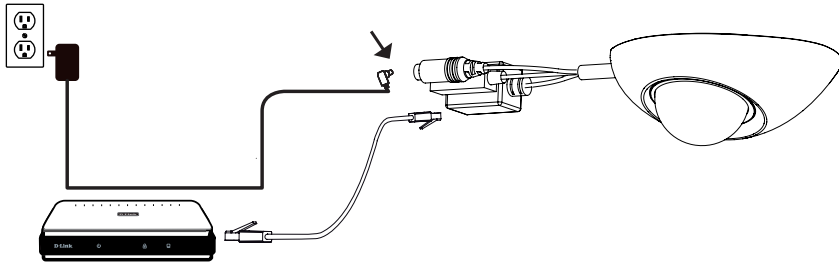

Figure 4.5

Conexión General Usando un Adaptador de Energía DC 12V

1. Conecte la cámara a un hub vía cable Ethernet.
2. Conecte el cable de energía incluido desde la cámara a la toma de corriente.



ESPAÑOL

Conexión con un Hub PoE

Si está utilizando un hub PoE, conecte la cámara IP al hub vía cable Ethernet, el cual le entregará transmisión de energía y datos a través de un solo cable.

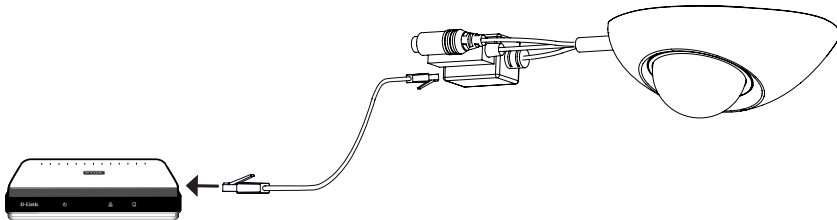

5. Configuración con Asistente

Inserte el CD de DCS-6210 en el lector de CD-ROM de su computador para comenzar la instalación. Si la función Auto-Ejecutar en su computador esta deshabilitada, o si al ejecutar el Programa de D-Link falla al iniciar, haga clic en **Inicio>Ejecutar** y escriba **D:\autorun.exe**, donde D representa la letra de la Unidad de su Lector de CD-ROM.

Haga clic en **Asistente de Configuración** para comenzar la instalación.



Después de hacer clic en **Asistente de Configuración**, la siguiente ventana aparecerá. Haga clic en **Siguiente** para continuar.

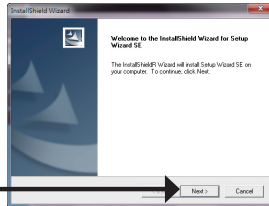

Haga clic en **SI** para aceptar el Acuerdo de Licencia.

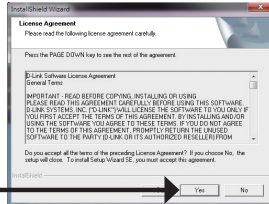

Para comenzar el proceso de instalación, haga clic en **Siguiente**.

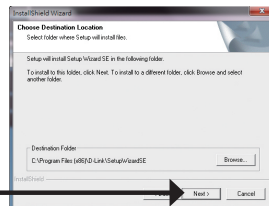

Nota: La instalación podría tomar varios minutos para finalizar.

Haga clic en **Finalizar** para completar la instalación.

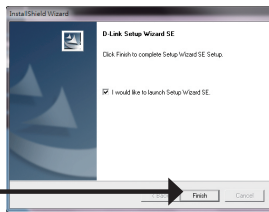

Haga clic en el icono **Asistente de Configuración D-Link** que fue creado en su Menú de Inicio de Windows.

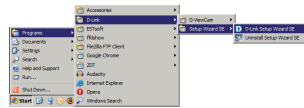

Inicio>D-Link>Asistente de Configuración

El Asistente de Configuración aparecerá y mostrará la dirección MAC y la dirección IP de su cámara(s). Si usted tiene un servidor DHCP en la red, una dirección IP válida será mostrada. Si la red no utiliza un servidor DHCP, por defecto la cámara de red mostrará la siguiente dirección IP **192.168.0.20**

Haga clic en el Botón **Asistente** para continuar.



ESPAÑOL

Ingrese el ID de admin y la Contraseña. Cuando ingresa por primera vez, el ID de admin por defecto es **admin** y la contraseña debe quedar en blanco.

Haga clic en **Siguiente**, para pasar a la siguiente página.

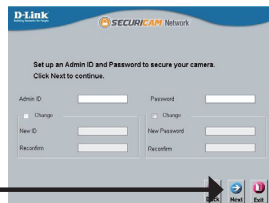

Seleccione DHCP si su cámara obtiene una dirección IP automáticamente cuando se inicia. Seleccione IP Estática si la cámara utilizará la misma dirección IP cada vez que se inicie.

Haga clic en **Siguiente** para pasar a la siguiente página.



Tome un momento para confirmar la configuración y haga clic en **Reiniciar**.

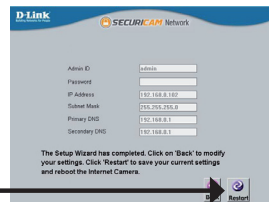

Ver Cámara vía Navegador Web

Haga clic en el icono Asistente de Configuración SE D-Link que fue creado en su menú de inicio de Windows.

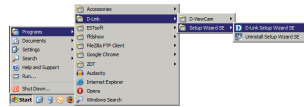

Inicio>D-Link>Asistente de Configuración SE

ESPAÑOL

Seleccione la cámara y haga clic en el botón etiquetado como “Link” para acceder a la configuración Web.

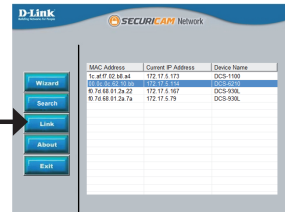

El Asistente de Configuración automáticamente abrirá su Navegador Web en la dirección IP de la cámara.

Ingrese **admin** como nombre de usuario por defecto y la contraseña dejar en blanco. Haga clic en **OK** para continuar.



En esta sección se muestra vídeo en vivo de su cámara. Se puede seleccionar el perfil de video y ver o manejar la cámara. Para obtener información adicional acerca de la configuración web, por favor consulte el manual de usuario incluido en el CD-ROM o en el sitio web de D-Link.



6. Ajustando el Angulo del lente 3-Axis

Ajustar el Angulo de Visión del Mecanismo 3-Axis

Gire el módulo del lente a la izquierda y la derecha hasta lograr la posición deseada

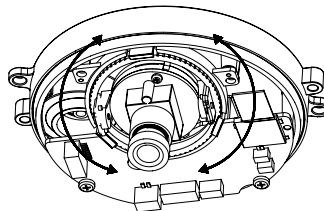

Gire el lente hacia arriba y hacia abajo hasta la posición deseada.

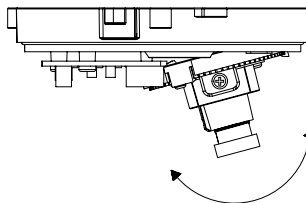

Girar el lente para ajustar la imagen de la cámara IP hasta la orientación deseada.

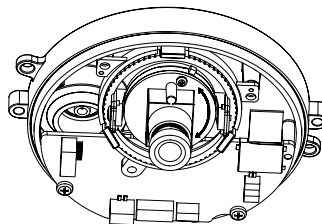

SOPORTE TÉCNICO

Usted puede encontrar actualizaciones de softwares o firmwares y documentación para usuarios a través de nuestro sitio www.dlinkla.com

SOPORTE TÉCNICO PARA USUARIOS EN LATINO AMERICA

Soporte técnico a través de los siguientes teléfonos de D-Link

PAIS	NUMERO
Argentina	0800 - 12235465
Chile	800 260200
Colombia	01800 - 510070
Costa Rica	0800 - 0521478
Ecuador	1800 - 035465
El Salvador	800 - 6335
Guatemala	1800 - 8350255
México	01800 - 0626270
Panamá	011 008000525465
Perú	0800 - 00968
Venezuela	0800 - 1005767

ESPAÑOL

Soporte Técnico de D-Link a través de Internet

Horario de atención Soporte Técnico en www.dlinkla.com

e-mail: soporte@dlinkla.com & consultas@dlinkla.com

Guia rápido de Instalação

Este guia de instalação fornece instruções básicas para instalar a Câmera de rede DCS-6210 em sua rede. Para obter informações adicionais sobre como usar a câmera, consulte o Manual do Usuário, disponível no CD incluído neste pacote ou a partir do site de suporte da D-Link.

Etapas para Instalação

1. Verifique o conteúdo da embalagem através da lista abaixo.
2. Visão geral do Hardware
3. Instalação do SD Card
4. Instalação do Hardware
5. Configuração com o Assistente Wizard
6. Ajuste da lente de 3 eixos

1. Conteúdo da Embalagem

- Câmera IP DCS-6210
- CD-Rom com Manual e Software
- Guia de instalação rápida
- Fonte de Alimentação
- Cabo Ethernet CAT-5
- Chave de fenda e parafusos para a instalação
- Adesivo de alinhamento
- orrachas

Se algum dos itens acima estiver faltando, favor contatar o seu revendedor.

Alerta de segurança:

A instalação e manutenção deve ser feita por técnicos certificados, a fim de atender a todos as regras locais e evitar a anulação da sua garantia.

2. Visão Geral do Hardware

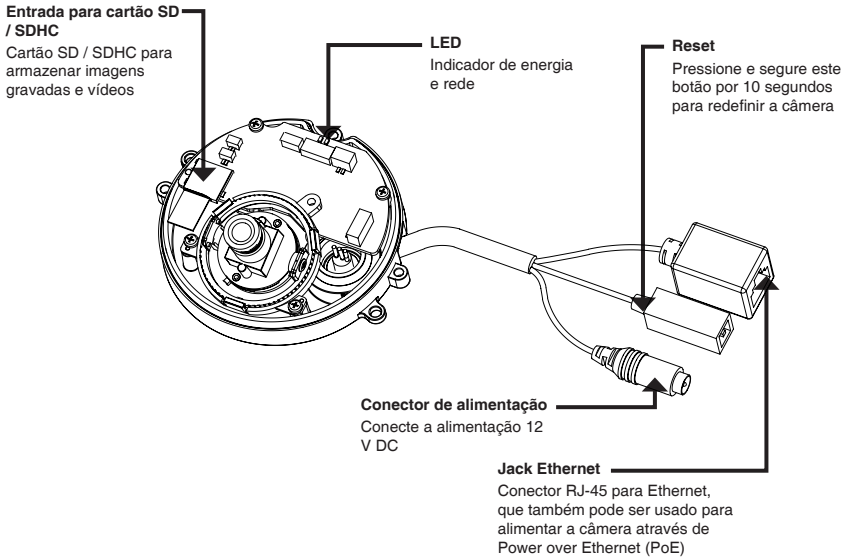

3. Instalação do SD card

Desmonte a Câmara

Abra a caixa da câmara e solte os três parafusos. Levante a cúpula para fora da base da câmara.

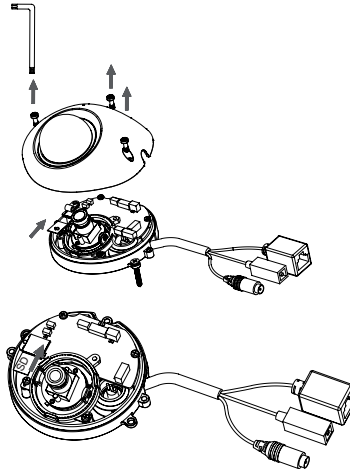

Instale o cartão SD

Empurre o cartão SD no slot da câmara com os contactos dourados voltados para a base da câmara. Para retirar o cartão SD, empurre o cartão SD que está dentro do slot.

4. Instalação de hardware

Montagem para instalação

Por favor, consulte o Manual do Usuário para obter instruções detalhadas sobre a instalação e a montagem da câmara através de um suporte de montagem.

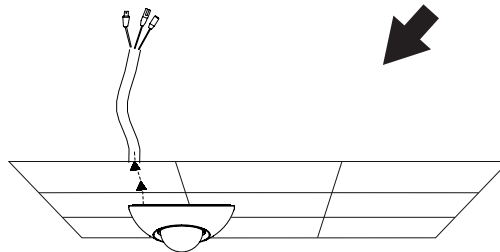
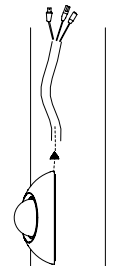
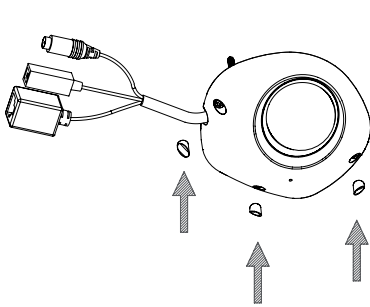
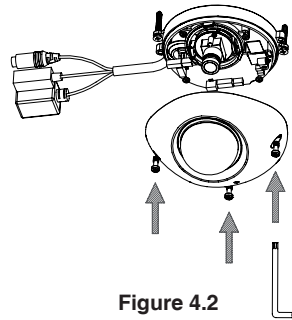
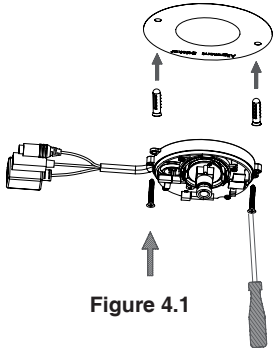

Conexão geral usando fonte de alimentação 12 V DC

1. Ligue a câmera de rede a um switch através de um cabo Ethernet.
2. Conecte o cabo de alimentação fornecido pela câmera a uma tomada elétrica.

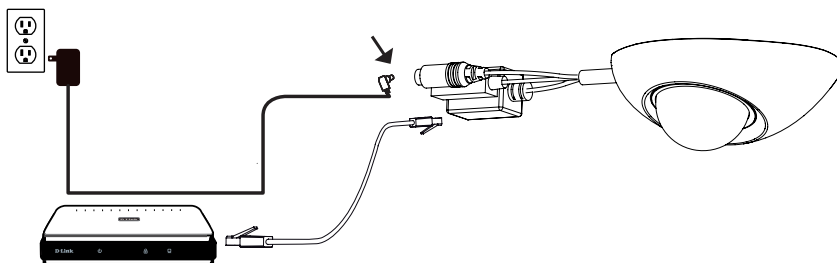

PORTUGUÊS

Conexão com um switch PoE

Se você estiver usando um switch PoE, ligue a câmara IP ao switch através de um cabo Ethernet, o que proporcionará a transmissão de energia e dados através de um único cabo.

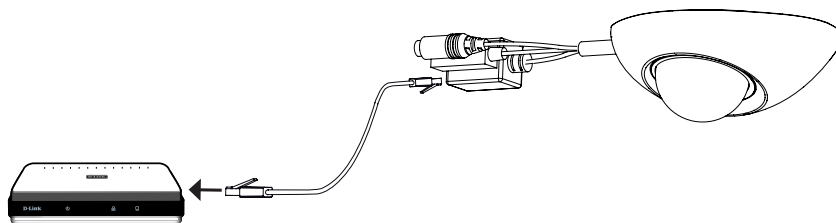

5. Configuração com o Assistente Wizard

Insira o CD da DCS-6210 na unidade de CD-ROM do seu computador para iniciar a instalação. Se a função Autorun do seu computador estiver desativada, ou se o D-Link Launcher não iniciar automaticamente, clique em **Iniciar > Executar**. Como exemplo, **autorun.exe D: **, onde D: representa a letra da sua unidade de CD-ROM.

Clique em **Setup Wizard** para inicializar a instalação. →



Após clicar no Setup Wizard, a seguinte janela irá aparecer.

Clique em **Next** para continuar. →

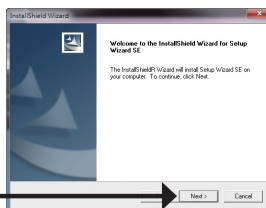

Clique em **Yes** para aceitar o contrato de licença. →

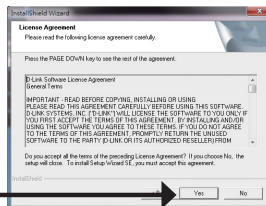

Para iniciar a instalação, clique em **Next**.

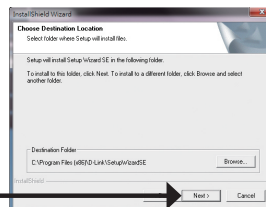

Nota: A instalação pode demorar alguns minutos para finalizar.

Clique em **Finish** para completar a instalação. →

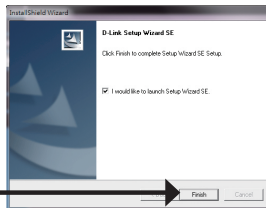

Clique no ícone do **Setup Wizard D-Link SE** que foi criado no seu menu Iniciar do Windows.

Iniciar > D-Link > Setup Wizard SE

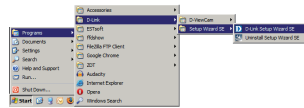

O Setup Wizard irá aparecer e mostrar o endereço MAC e o endereço IP de sua câmera(s). Se você tem um servidor DHCP em sua rede, um endereço IP válido será exibido. Se sua rede não usa um servidor DHCP, o padrão IP estático da câmera de rede IP, **192.168.0.20** será exibido.

Clique em **Wizard** para continuar.

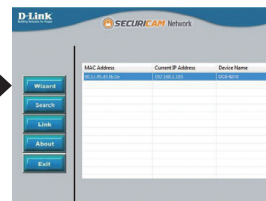

Digite o Admin(usuário) e a senha. Quando você acessar o equipamento pela primeira vez, o padrão é **Admin (usuário)** admin com a senha em branco.

Clique em **Next** para prosseguir para a próxima página.



Selecione DHCP se sua câmera irá obter um endereço IP automaticamente quando ela inicia. Selecione IP estático se a câmera usará o mesmo endereço de IP cada vez que ela for iniciada.

Clique em **Next** para prosseguir para a próxima página.

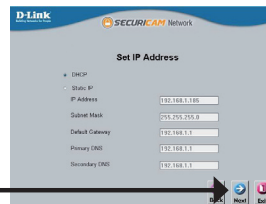

Aguarde um momento para confirmar suas configurações e clique em **Reiniciar**.

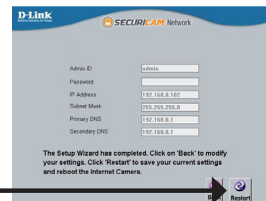

Acessando a câmera via navegador de Internet

Clique no ícone **D-Link Setup Wizard SE** que foi criado no seu menu Iniciar do Windows.

Iniciar > D-Link > Setup Wizard SE

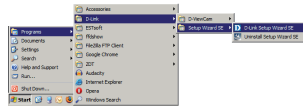

Selecione a câmera e clique no botão **"Link"** para acessar à configuração web.

O Assistente de instalação irá abrir automaticamente o navegador da Web no endereço IP da câmera.



Digite **admin** para o nome do usuário padrão e deixe a senha em branco. Clique em **OK** para continuar.



Esta seção mostra o vídeo ao vivo da câmera. Você pode selecionar o seu perfil e ver ou operar a câmera. Para obter informações adicionais sobre a configuração Web, consulte o manual incluído no CD-ROM ou no site da D-Link.



PORTUGUÊS

6. Ajuste da lente de 3 eixos

Ajuste o ângulo de visão através do mecanismo de 3 eixos

Mova o módulo da lente para a direita e esquerda até a posição desejada.

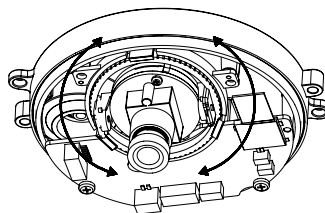

PORTUGUÊS

Mova a lente para cima e para baixo até a posição desejada.

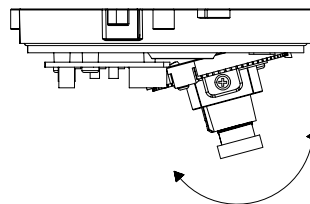

Gire a lente para ajustar a imagem da Câmara IP até a posição desejada.

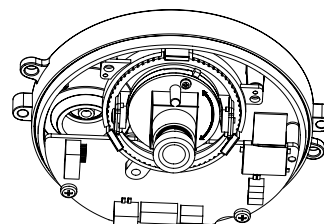

SUPOORTE TÉCNICO

Caso tenha dúvidas na instalação do produto, entre em contato com o Suporte Técnico D-Link.

Acesse o site: www.dlink.com.br/suporte

PORTUGUÊS

DCS-6210 快速安裝手冊

快速安裝手冊提供基本的安裝說明，讓DCS-6210網路攝影機連線至您的網路環境。詳細的網路攝影機操作說明，請參考光碟中產品操作手冊，相關文件可至D-Link技術支援網站下載。

安裝步驟

1. 確認包裝清單
2. 硬體檢視
3. SD記憶卡安裝
4. 硬體安裝
5. 設定精靈導引設定
6. 調整攝影機鏡頭

1. 包裝清單

- DCS-6210網路攝影機
- 內附使用手冊和軟體的光碟片
- 快速安裝說明
- 電源變壓器
- CAT5以太網路線
- 安裝用的螺絲起子和螺絲
- 校準貼紙
- 橡皮墊

中
文

假如有缺少任何配件，敬請與您購買的經銷商聯繫。

安全注意事項：

安裝與設定必須經由通過認證的技術人員進行安裝，以符合當地法規並確保產品保固。

2. 硬體檢視

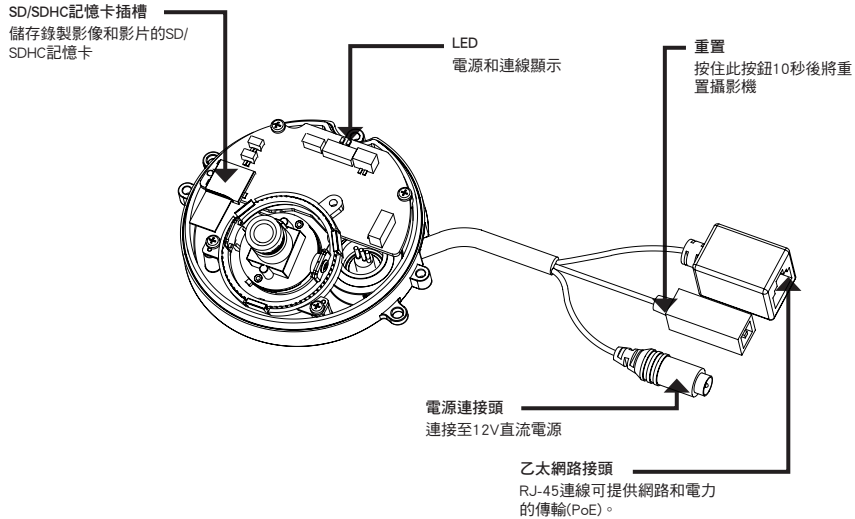

3. SD記憶卡安裝

拆解攝影機

移除三個螺絲後即可打開攝影機的外殼。將半球從底座移除。

安裝SD記憶卡

將SD記憶卡安裝至網路攝影機的記憶卡插槽，金屬面向向攝影機。若要移除記憶卡，請向內按壓記憶卡即可。

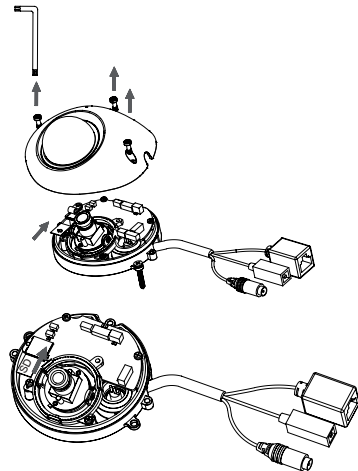

4. 硬體安裝

固定架安裝

網路攝影機的硬體設備安裝固定說明敬請參考產品操作手冊的詳細介紹。

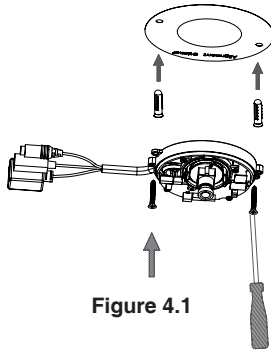

Figure 4.1

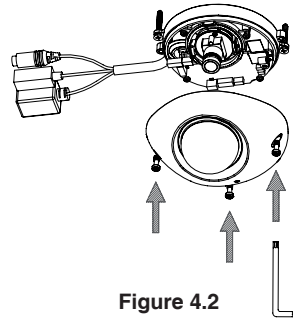

Figure 4.2

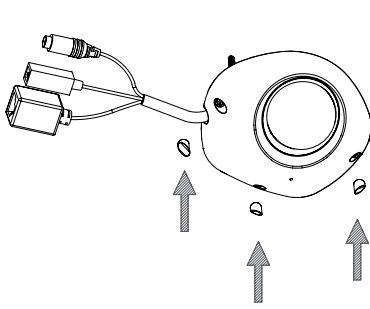

Figure 4.3

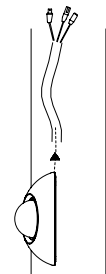

Figure 4.4

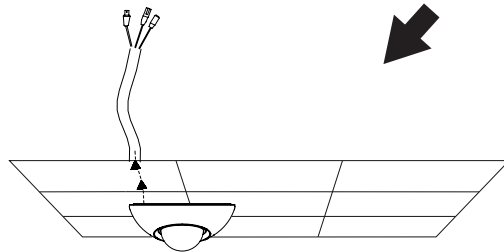
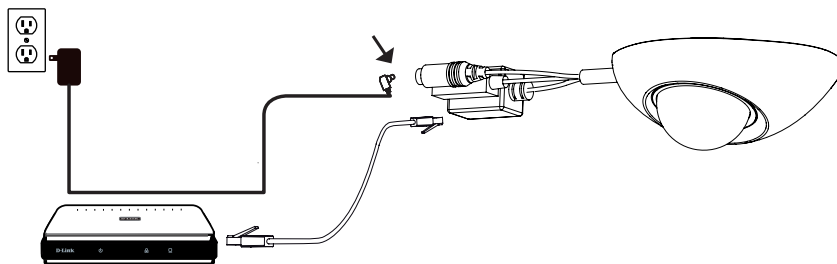

Figure 4.5

一般連接使用12V直流電源供應器

1. 透過網路線將網路攝影機連接至網路交換器。
2. 將網路攝影機的電源線連接至電源供應器的插頭。



透過PoE網路供電交換器提供電源

1. 假如您使用PoE網路供電交換器，透過乙太網路線將網路攝影機連接至PoE網路供電交換器，透過網路線將同時提供電源與資料傳輸。

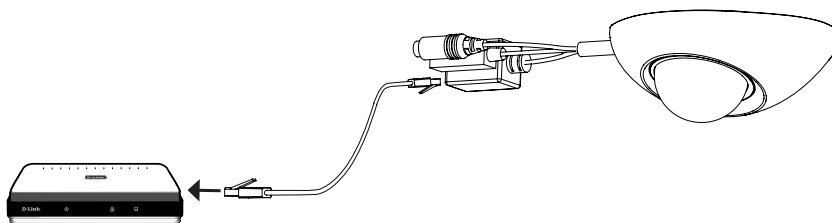

5. 設定精靈導引設定

將DCS-6210隨產品提供的光碟放入您電腦的光碟機中開始進行安裝。假如自動安裝功能在您的電腦是關閉的或是D-Link程式無法背自動開啟，點擊開始>執行。輸入D:\autorun.exe當D代表您電腦光碟機識別字母時。

點擊Setup Wizard開始進行安裝。



在完成點擊Setup Wizard後，以下的視窗將會顯示。

點擊下一步繼續進行安裝。

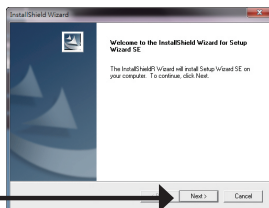

點擊Yes同意接受許可協議。

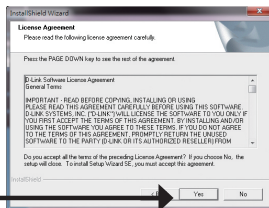

開始進行安裝程序，請點擊下一步。

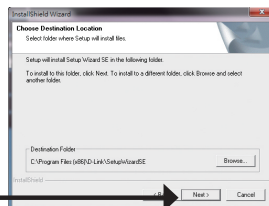

備註：安裝將會需要幾分鐘的時間才能完成。

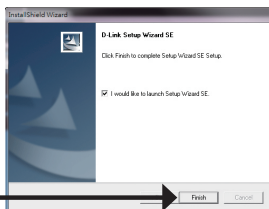

點擊結束完成安裝程序。

點擊您電腦開始的所有程式中D-Link Setup Wizard SE的圖示。

開始>所有程式>D-Link>Setup Wizard SE

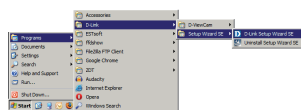

設定精靈程式畫面將會顯示網路攝影機的MAC位址與IP位址。假如您的網路具備DHCP伺服器，將會顯示指派的IP位址。假如您的網路沒有DHCP伺服器，將會顯示網路攝影機的預設IP位址192.168.0.20。

點擊Wizard按鍵繼續進行設定。



輸入管理者帳號與密碼。網路攝影機預設的帳號為admin，密碼欄位保持空白。

點擊下一步，繼續下一頁的設定程序。

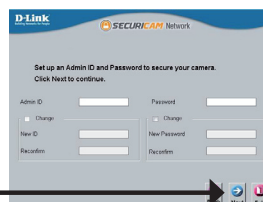

當選擇DHCP時，每次網路攝影機重新開機將會重新取得IP位址。當選擇Static IP則網路攝影機每次重新開機都會取得相同的IP位址。

點擊下一步，繼續下一頁的設定程序。



重新確認一下您的相關設定，然後點擊Restart重新開機。

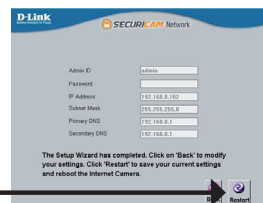

中
文

透過網頁瀏覽器觀看網路攝影機

點擊您電腦開始的所有程式中D-Link Setup Wizard SE的圖示。

開始>所有程式>D-Link>Setup Wizard SE

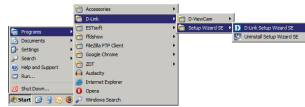

選擇網路攝影機並且點擊” Link” 開啟網頁瀏覽器。

設定精靈將會自動開啟電腦網頁瀏覽器並輸入網路攝影機的IP位址。

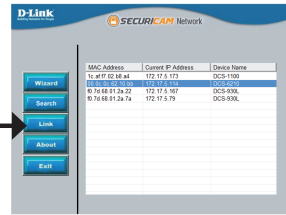

中文

預設的使用者名稱請輸入admin，密碼欄位保持空白。點擊OK繼續。



透過此步驟即可以觀看您網路攝影機的即時影像。您可以選擇您網路攝影機所有顯示的影像尺寸或是進行網路攝影機的設定，更多詳細的網路攝影機設定說明請參考光碟內產品操作手冊。



6. 調整網路攝影機鏡頭

調整攝影機三個向位的角度

將鏡頭模組左右調整至您希望的角度。

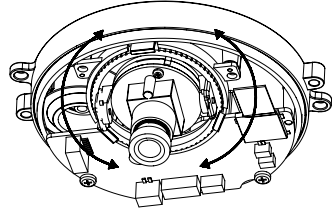

將鏡頭模組上下調整至您希望的角度。

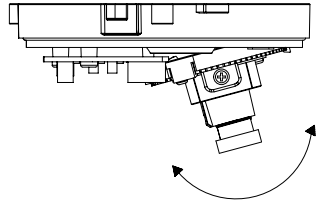

調整網路攝影機的鏡頭模組至您希望的方向。

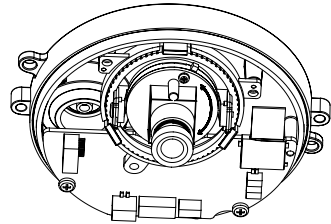

中
文

D-Link 友訊科技 台灣分公司 技術支援資訊

如果您還有任何本使用手冊無法協助您解決的產品相關問題，台灣地區用戶可以透過我們的網站、電子郵件或電話等方式與D-Link台灣地區技術支援工程師聯絡。

D-Link 免付費技術諮詢專線

0800-002-615

服務時間：週一至週五，早上9:00到晚上9:00
(不含周六、日及國定假日)

網 站：<http://www.dlink.com.tw>

電子郵件：dssqa_service@dlink.com.tw

如果您是台灣地區以外的用戶，請參考**D-Link**網站，全球各地分公司的聯絡資訊以取得相關支援服務。

產品保固期限、台灣區維修據點查詢，請參考以下網頁說明：
<http://www.dlink.com.tw>

產品維修：

使用者可直接送至全省聯強直營維修站或請洽您的原購買經銷商。

Petunjuk Pemasangan Cepat DCS-6210

Petunjuk Pemasangan ini menyediakan instruksi-instruksi dasar untuk memasang kamera jaringan DCS-6210 pada jaringan anda. Untuk informasi lebih lanjut mengenai cara menggunakan kamera, silahkan mengacu pada Petunjuk Penggunaan yang ada dalam CD yang termasuk dalam paket penjualan atau dari website bantuan D-Link.

Langkah-langkah Pemasangan

1. Periksa isi paket apakah sesuai dengan daftar dibawah
2. Pengenalan Perangkat Keras
3. Pemasangan Kartu SD
4. Pemasangan Perangkat Keras
5. Pengaturan menggunakan Bantuan
6. Menyesuaikan sudut lensa 3-axis

1. Isi Paket

- Kamera Jaringan DCS-6210
- Manual dan Software dalam CD-ROM
- Panduan Instalasi Cepat
- Adaptor Daya
- Kabel Ethernet CAT-5
- Obeng dan Sekrup untuk Instalasi
- Stiker untuk menjajarkan
- Karet-karet

Jika ada item-item diatas yang hilang, hubungi penjual

Catatan Keamanan:

Pemasangan dan perbaikan seharusnya dilakukan oleh teknisi yang bersertifikat sehingga sesuai dengan regulasi lokal yang ada dan mencegah batalnya garansi anda.

2. Pengenalan Perangkat Keras

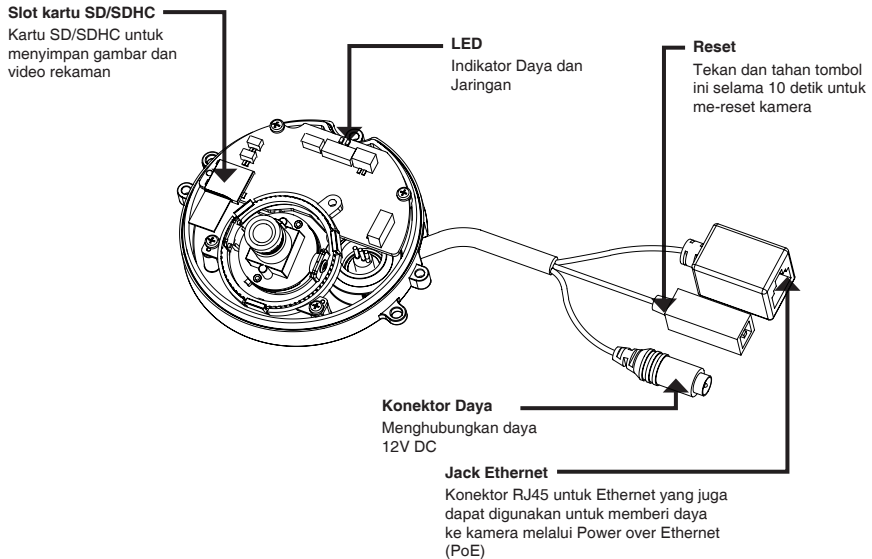

3. Pemasangan Kartu SD

Membongkar Kamera

Buka penutup kamera dengan melonggarkan 3 mur. Angkat kubah dari dasar kamera

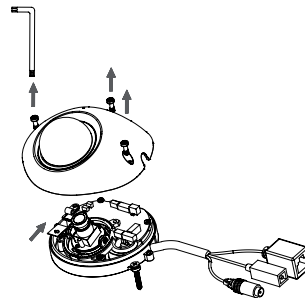

Memasang Kartu SD

Masukkan kartu SD ke kamera dimana bagian emasnya menghadap ke bagian dasar kamera. Untuk mengeluarkan kartu SD, tekan kartu SD ke dalam slot-nya.

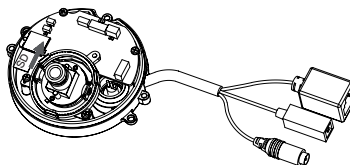

4. Instalasi Perangkat Keras

Pemasangan Pengait

Silahkan mengacu ke Petunjuk Pemasangan untuk petunjuk lebih rinci dalam hal pemasangan dan mengaitkan kamera ke braket pemasangan.

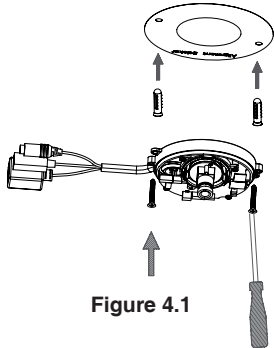

Figure 4.1

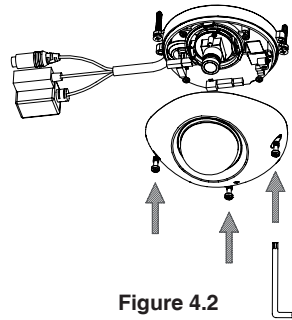

Figure 4.2

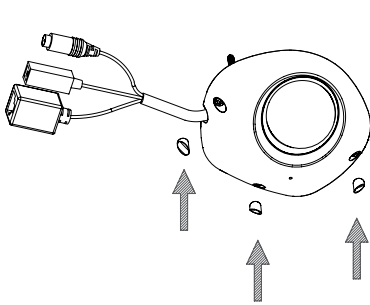

Figure 4.3

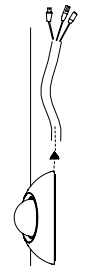

Figure 4.4

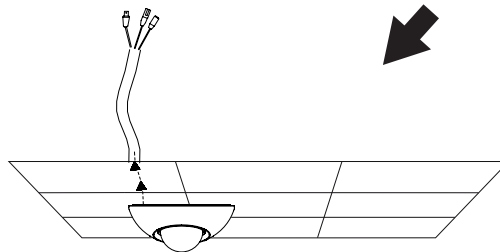
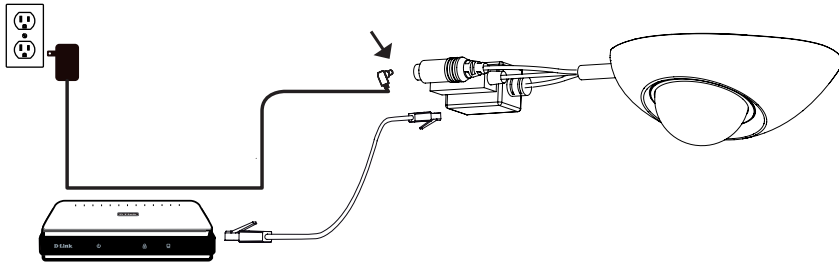

Figure 4.5

Koneksi umum menggunakan Power Adapter 12VDC

1. Hubungkan kamera jaringan ke sebuah switch menggunakan kabel Ethernet.
2. Hubungkan kabel power yang disediakan dari kamera ke colokan listrik.



Koneksi menggunakan Switch PoE

Jika anda menggunakan sebuah switch PoE, hubungkan kamera IP ke switch menggunakan kabel Ethernet yang akan menyediakan tenaga dan data melalui kabel tunggal.

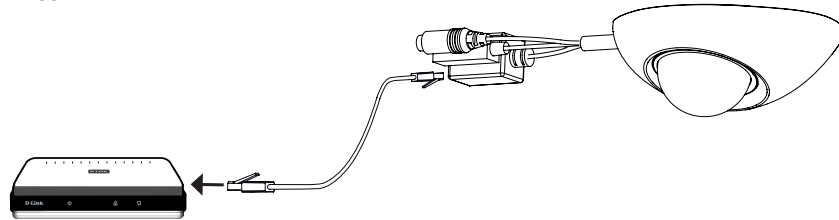

5. Pengaturan menggunakan Bantuan

Masukkan CD DCS-6210 kedalam drive CD-ROM komputer anda untuk memulai pemasangan. Jika fungsi Autorun pada komputer anda tidak aktif, atau jika aplikasi D-Link gagal untuk beroperasi secara otomatis, klik **Start > Run**. Ketik **D:\autorun.exe**, dimana **D:** menandakan huruf drive dari drive CD-ROM anda.

Klik **Setup Wizard** untuk memulai pemasangan.



Setelah klik Setup Wizard, jendela berikut akan muncul.

Klik **Next** untuk melanjutkan.

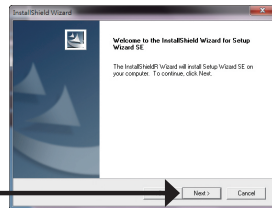

Klik **Yes** untuk menerima Persetujuan Lisensi.

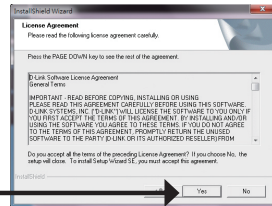

Untuk memulai proses pemasangan, klik **Next**.

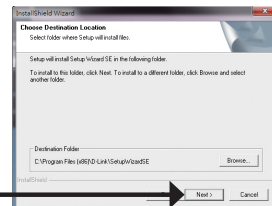

Catatan: Pemasangan membutuhkan beberapa menit untuk selesai.

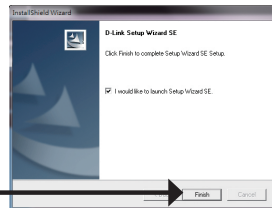

Klik **Finish** untuk menyelesaikan pemasangan.

Klik pada ikon **D-Link Setup Wizard SE** yang telah dibuat pada Start Menu Windows anda.

Start > D-Link > Setup Wizard SE

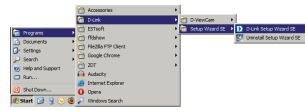

Bantuan Pemasangan akan muncul dan menampilkan alamat MAC dan alamat IP dari kamera anda. Jika anda mempunyai server DHCP pada jaringan anda, sebuah alamat IP yang berlaku akan muncul. Jika jaringan anda tidak menggunakan sebuah server DHCP, alamat IP statis default dari kamera jaringan **192.168.0.20** akan muncul.

Klik tombol **Wizard** untuk melanjutkan.

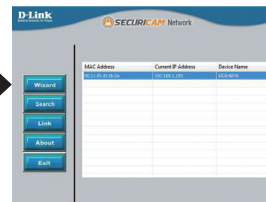

Masukkan ID admin dan password. Ketika masuk untuk pertama kali, ID admin default adalah **admin** dengan password biarkan kosong.

Klik **Next**, untuk proses ke halaman berikutnya.



Pilih DHCP jika kamera anda mendapat sebuah alamat IP secara otomatis ketika hidup. Pilih alamat IP statis jika kamera akan menggunakan alamat IP yang sama setiap kali hidup.

Klik **Next**, untuk proses ke halaman berikutnya.



Periksa sejenak setingan anda dan klik **Restart**.

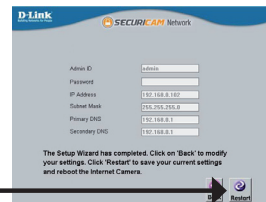

Melihat kamera menggunakan Browser Web

Klik pada ikon **D-Link Setup Wizard SE** yang telah dibuat pada Start Menu Windows anda.

Start > D-Link > Setup Wizard SE

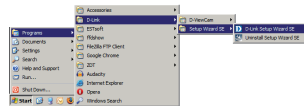

Pilih kamera dan klik tombol dengan label **“Link”** untuk mengakses konfigurasi berbasis web.

Bantuan Pemasangan akan membuka browser web anda secara otomatis ke alamat IP kamera.

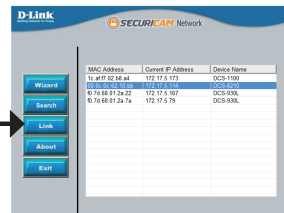

Masukkan **admin** sebagai username default dan biarkan password dalam keadaan kosong. Klik **OK** untuk melanjutkan.

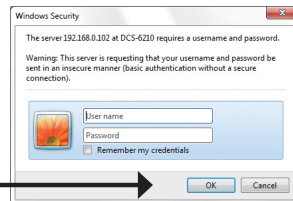

Bagian ini akan menunjukkan video dari kamera anda secara langsung. Anda dapat memilih profil video anda dan melihat atau mengoperasikan kamera. Untuk informasi tambahan mengenai konfigurasi berbasis web, silahkan mengacu pada Petunjuk Penggunaan yang ada dalam CD-ROM atau dari website D-Link.



BAHASA INDONESIA

6. Menyesuaikan sudut lensa 3-axis

Menyesuaikan mekanisme 3-axis dari sudut penglihatan

Putar modul lensa ke kiri dan kanan sampai posisi yang diinginkan tercapai.

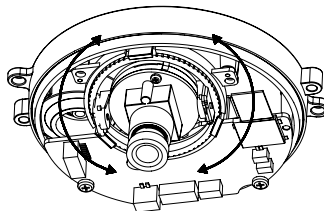

Putar lensa ke atas dan bawah sampai posisi yang diinginkan tercapai.

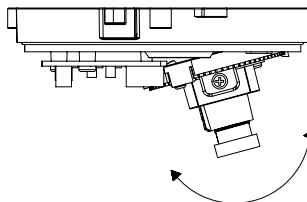

Putar lensa untuk menyesuaikan gambar yang dihasilkan IP kamera sampai orientasi yang diinginkan tercapai.

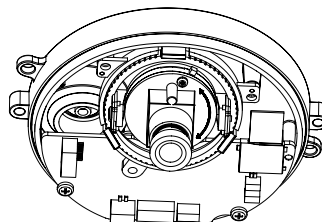

DUKUNGAN TEKNIS

Update perangkat lunak dan dokumentasi pengguna dapat diperoleh pada situs web D-Link.
Dukungan Teknis untuk pelanggan:

Dukungan Teknis D-Link melalui telepon:

Tel: +62-21-5731610

Dukungan Teknis D-Link melalui Internet:

Email : support@dlink.co.id

Website : <http://support.dlink.co.id>

NOTES

NOTES

NOTES

NOTES

NOTES



D-Link[®]



Ver.1.00(DI)
2012/09/21
RMN0100931