

X S T A C K[®] **USER MANUAL**

PRODUCT MODEL: **xStack**[®] **DGS-3600 SERIES**

LAYER 3 GIGABIT ETHERNET MANAGED SWITCH

RELEASE 2.5



Information in this document is subject to change without notice.

© 2009 D-Link Corporation. All rights reserved.

Reproduction in any manner whatsoever without the written permission of D-Link Corporation is strictly forbidden.

Trademarks used in this text: D-Link and the D-LINK logo are trademarks of D-Link Corporation; Microsoft and Windows are registered trademarks of Microsoft Corporation.

Other trademarks and trade names may be used in this document to refer to either the entities claiming the marks and names or their products. D-Link Corporation disclaims any proprietary interest in trademarks and trade names other than its own.

April 2009 P/N 651GS3600045G

FCC Warning

This equipment has been tested and found to comply with the limits for a Class A digital device, pursuant to Part 15 of the FCC Rules. These limits are designed to provide reasonable protection against harmful interference when the equipment is operated in a commercial environment. This equipment generates, uses, and can radiate radio frequency energy and, if not installed and used in accordance with this manual, may cause harmful interference to radio communications. Operation of this equipment in a residential area is likely to cause harmful interference in which case the user will be required to correct the interference at their expense.

CE Mark Warning

This is a Class A product. In a domestic environment, this product may cause radio interference in which case the user may be required to take adequate measures.

Warnung!

Dies ist ein Produkt der Klasse A. Im Wohnbereich kann dieses Produkt Funkstörungen verursachen. In diesem Fall kann vom Benutzer verlangt werden, angemessene Massnahmen zu ergreifen.

Precaución!

Este es un producto de Clase A. En un entorno doméstico, puede causar interferencias de radio, en cuyo caso, puede requerirse al usuario para que adopte las medidas adecuadas.

Attention!

Ceci est un produit de classe A. Dans un environnement domestique, ce produit pourrait causer des interférences radio, auquel cas l'utilisateur devrait prendre les mesures adéquates.

Attenzione!

Il presente prodotto appartiene alla classe A. Se utilizzato in ambiente domestico il prodotto può causare interferenze radio, nel cui caso è possibile che l'utente debba assumere provvedimenti adeguati.

VCCI Warning

この装置は、情報処理装置等電波障害自主規制協議会（VCCI）の基準に基づくクラスA情報技術装置です。この装置を家庭環境で使用すると電波妨害を引き起こすことがあります。この場合には使用者が適切な対策を講ずるよう要求されることがあります。

Table of Contents

| | |
|---|-----------|
| Preface | xii |
| Intended Readers | xiii |
| Typographical Conventions | xiii |
| Notes, Notices, and Cautions | xiii |
| Safety Instructions | xiv |
| Safety Cautions | xiv |
| General Precautions for Rack-Mountable Products | xv |
| Protecting Against Electrostatic Discharge | xvi |
| Introduction..... | 1 |
| xStack® DGS-3600 Series | 1 |
| Gigabit Ethernet Technology | 1 |
| Switch Description | 1 |
| Features | 2 |
| Ports | 3 |
| Front-Panel Components | 2 |
| LEDs | 3 |
| Rear Panel Description | 4 |
| Side Panel Description | 5 |
| 10GE Uplink Modules | 7 |
| Installing the SFP ports | 8 |
| Installation..... | 9 |
| Package Contents | 9 |
| Before You Connect to the Network | 9 |
| Installing the Switch without the Rack | 10 |
| Installing the Switch in a Rack | 10 |
| Mounting the Switch in a Standard 19" Rack | 11 |
| RPS Installation | 12 |
| Connecting the Switch..... | 16 |
| Switch to End Node | 16 |
| Switch to Hub or Switch | 17 |
| Connecting To Network Backbone or Server | 18 |
| Introduction to Switch Management | 19 |
| Management Options | 19 |
| Web-based Management Interface | 19 |
| SNMP-Based Management | 19 |
| Connecting the Console Port (RS-232 DCE) | 19 |
| First Time Connecting to the Switch | 21 |
| Password Protection | 21 |
| SNMP Settings | 22 |
| IP Address Assignment | 23 |
| Web-based Switch Configuration..... | 25 |

| | |
|---|-----------|
| Introduction..... | 25 |
| Login to Web Manager | 25 |
| Web-based User Interface | 26 |
| Web Pages..... | 27 |
| Administration | 28 |
| Device Information | 29 |
| IP Address..... | 31 |
| IP MTU Settings | 33 |
| Stacking | 34 |
| Port Configuration..... | 38 |
| Port Configuration..... | 38 |
| Port Error Disabled | 39 |
| Port Description | 40 |
| Port Auto Negotiation Information | 40 |
| User Accounts | 41 |
| Port Mirroring | 43 |
| System Log | 44 |
| System Log Host..... | 44 |
| System Log Save Mode Settings..... | 45 |
| System Severity Settings..... | 46 |
| SNTP Settings..... | 47 |
| Time Settings | 47 |
| Time Zone and DST..... | 48 |
| MAC Notification Settings | 50 |
| TFTP Services..... | 50 |
| File System Services | 52 |
| System Boot Information | 52 |
| FS Information | 52 |
| Directory | 53 |
| Rename | 54 |
| Copy..... | 55 |
| Ping Test | 56 |
| IPv4 Ping Test..... | 56 |
| IPv6 Ping Test..... | 57 |
| IPv6 Neighbor..... | 58 |
| IPv6 Neighbor Settings | 58 |
| DHCP Auto Configuration Settings..... | 59 |
| BPDU Tunneling Settings..... | 59 |
| RSPAN..... | 60 |
| RSPAN State Settings | 61 |
| RSPAN Settings | 61 |
| SNMP Manager | 63 |
| SNMP Trap Settings | 64 |

| | |
|--|-----------|
| SNMP User Table | 65 |
| SNMP View Table | 67 |
| SNMP Group Table | 68 |
| SNMP Community Table | 69 |
| SNMP Host Table | 70 |
| SNMP Engine ID | 72 |
| sFlow | 72 |
| sFlow Global Settings | 73 |
| sFlow Analyzer Settings | 73 |
| sFlow Sampler Settings | 75 |
| sFlow Poller Settings | 76 |
| Single IP Management Settings | 78 |
| SIM Settings | 79 |
| Topology | 81 |
| Firmware Upgrade | 87 |
| Configuration File Backup/Restore | 87 |
| Upload Log File | 88 |
| L2 Features | 89 |
| VLAN | 89 |
| Static VLAN Entries | 94 |
| GVRP Settings | 96 |
| Double VLAN | 98 |
| PVID Auto Assign | 102 |
| MAC-based VLAN Settings | 102 |
| Protocol VLAN | 103 |
| Protocol VLAN Group Settings | 104 |
| Protocol VLAN Port Settings | 105 |
| Trunking | 106 |
| Link Aggregation | 107 |
| LACP Port Settings | 109 |
| IGMP Snooping | 109 |
| IGMP Snooping Settings | 109 |
| Router Port Settings | 112 |
| ISM VLAN Settings window | 114 |
| IP Multicast Address Range Settings | 116 |
| Limited Multicast Address Range Settings | 117 |
| MLD Snooping | 118 |
| MLD Snooping Settings | 118 |
| MLD Router Port Settings | 120 |
| Loopback Detection Global Settings | 122 |
| Spanning Tree | 124 |
| STP Bridge Global Settings | 126 |
| MST Configuration Identification | 128 |
| MSTP Port Information | 130 |

| | |
|---|------------|
| STP Instance Settings..... | 131 |
| STP Port Settings..... | 132 |
| Forwarding & Filtering..... | 134 |
| Unicast Forwarding..... | 134 |
| Multicast Forwarding..... | 136 |
| Multicast Filtering Mode..... | 137 |
| LLDP..... | 138 |
| LLDP Global Settings..... | 138 |
| Basic LLDP Port Settings..... | 139 |
| 802.1 Extension LLDP Port Settings..... | 141 |
| 802.3 Extension LLDP Port Settings..... | 142 |
| LLDP Management Address Settings..... | 143 |
| LLDP Statistics..... | 144 |
| LLDP Management Address Table..... | 145 |
| LLDP Local Port Table..... | 145 |
| LLDP Remote Port Table..... | 146 |
| QinQ..... | 146 |
| QinQ Global Settings..... | 147 |
| VLAN Translation Settings..... | 148 |
| L3 Features..... | 149 |
| Interface Settings..... | 155 |
| IPv4 Interface Settings..... | 155 |
| IPv6 Interface Settings..... | 156 |
| MD5 Key Settings..... | 160 |
| Route Redistribution Settings..... | 160 |
| Multicast Static Route Settings..... | 162 |
| Static/Default Route Settings..... | 163 |
| IPv4 Static/Default Route Settings..... | 163 |
| IPv6 Static/Default Route Settings..... | 164 |
| Route Preference Settings..... | 166 |
| Static ARP Settings..... | 168 |
| Gratuitous ARP Settings..... | 169 |
| Policy Route Settings..... | 171 |
| ECMP Algorithm Settings..... | 173 |
| RIP..... | 174 |
| RIP Global Settings..... | 175 |
| RIP Interface Settings..... | 176 |
| OSPF..... | 177 |
| OSPF Global Settings..... | 194 |
| OSPF Area Settings..... | 194 |
| OSPF Interface Settings..... | 196 |
| OSPF Virtual Link Settings..... | 198 |
| OSPF Area Aggregation Settings..... | 199 |
| OSPF Host Route Settings..... | 200 |

| | |
|--|------------|
| DHCP/BOOTP Relay | 201 |
| DHCP / BOOTP Relay Global Settings | 201 |
| DHCP/BOOTP Relay Interface Settings | 203 |
| DHCP Server | 205 |
| DHCP Server Global Settings | 205 |
| DHCP Server Exclude Address Settings | 206 |
| DHCP Server Pool Settings | 206 |
| DHCP Server Dynamic Binding | 209 |
| DHCP Server Manual Binding | 209 |
| Filter DHCP Server | 211 |
| Filter DHCP Server Global Settings | 211 |
| Filter DHCP Server Port Settings | 211 |
| DNS Relay | 213 |
| DNS Relay Global Settings | 213 |
| DNS Relay Static Settings | 214 |
| VRRP | 215 |
| VRRP Global Settings | 215 |
| VRRP Virtual Router Settings | 215 |
| VRRP Authentication Settings | 221 |
| IP Multicast Routing Protocol | 222 |
| IGMP Interface Settings | 224 |
| DVMRP Global Settings | 226 |
| DVMRP Interface Settings | 226 |
| PIM Global Settings | 229 |
| PIM Parameter Settings | 229 |
| PIM Interface Settings | 230 |
| PIM Candidate BSR Settings | 231 |
| PIM Candidate RP Settings | 232 |
| PIM Static RP Settings | 233 |
| PIM Register Checksum Settings | 234 |
| QoS | 235 |
| Bandwidth Control | 237 |
| QoS Scheduling Mechanism | 238 |
| QoS Output Scheduling | 238 |
| 802.1p Default Priority | 241 |
| 802.1p User Priority | 241 |
| ACL | 242 |
| Time Range | 242 |
| Access Profile Table | 243 |
| ACL Flow Meter | 259 |
| CPU Interface Filtering | 262 |
| CPU Interface Filtering State Settings | 262 |
| CPU Interface Filtering Table | 262 |

| | |
|---|------------|
| Security | 277 |
| Traffic Control | 277 |
| Port Security..... | 281 |
| Port Security Settings | 281 |
| Port Security Entries | 282 |
| IP-MAC-Port Binding..... | 283 |
| IMP Global Settings..... | 283 |
| IMP Port Settings..... | 283 |
| IMP Entry Settings..... | 285 |
| DHCP Snooping Entries | 286 |
| MAC Block List..... | 286 |
| 802.1X..... | 287 |
| Configure 802.1X Guest VLAN | 293 |
| Configure 802.1X Authenticator Parameter..... | 294 |
| 802.1X User | 297 |
| Initialize Port(s)..... | 297 |
| Reauthenticate Port(s)..... | 298 |
| Authentic RADIUS Server..... | 300 |
| Web Authentication | 301 |
| Conditions and Limitations | 301 |
| Web Authentication Control | 302 |
| User Account Management..... | 303 |
| Trust Host..... | 305 |
| Access Authentication Control | 306 |
| Authentication Policy and Parameter Settings | 307 |
| Application Authentication Settings..... | 307 |
| Authentication Server Group | 308 |
| Authentication Server Host..... | 309 |
| Login Method Lists..... | 311 |
| Enable Method Lists | 312 |
| Configure Local Enable Password | 314 |
| Enable Admin | 314 |
| MAC Based Access Control | 315 |
| MAC-based Access Control Global Settings | 315 |
| MAC-based Access Control Local MAC Settings | 317 |
| Safeguard Engine | 319 |
| Safeguard Engine Settings | 320 |
| Traffic Segmentation..... | 321 |
| SSL..... | 323 |
| SSH | 326 |
| SSH Server Configuration..... | 326 |
| SSH Authentication Mode and Algorithm Settings..... | 327 |
| SSH User Authentication | 329 |
| Monitoring..... | 330 |

| | |
|--|-----|
| Device Status | 331 |
| Stacking Information..... | 331 |
| Module Information | 331 |
| CPU Utilization..... | 332 |
| Port Utilization..... | 333 |
| Packets | 334 |
| Received (RX)..... | 334 |
| UMB_cast (RX) | 336 |
| Transmitted (TX) | 338 |
| Errors | 340 |
| Received (RX)..... | 340 |
| Transmitted (TX) | 342 |
| Packet Size | 344 |
| Browse Router Port..... | 346 |
| Browse MLD Router Port..... | 346 |
| VLAN Status..... | 347 |
| VLAN Status Port | 347 |
| Port Access Control | 348 |
| Authenticator State..... | 348 |
| Authenticator Statistics | 351 |
| Authenticator Session Statistics | 352 |
| Authenticator Diagnostics..... | 353 |
| RADIUS Authentication | 355 |
| RADIUS Account Client..... | 357 |
| MAC Address Table | 359 |
| IGMP Snooping Group | 360 |
| MLD Snooping Group | 361 |
| Trace Route..... | 362 |
| IGMP Snooping Forwarding..... | 363 |
| MLD Snooping Forwarding..... | 364 |
| IP Forwarding Table | 364 |
| Browse Routing Table | 365 |
| Browse IP Multicast Forwarding Table | 365 |
| Browse IP Multicast Interface Table..... | 365 |
| Browse IGMP Group Table | 366 |
| DVMRP Monitor | 366 |
| Browse DVMRP Routing Table..... | 366 |
| Browse DVMRP Neighbor Table | 366 |
| Browse DVMRP Routing Next Hop Table..... | 367 |
| PIM Monitor | 367 |
| Browse PIM Neighbor Table | 367 |
| Browse PIM IP Multicast Route Table | 368 |
| Browse PIM RP-Set Table | 368 |

| | |
|--|------------|
| OSPF Monitor | 368 |
| Browse OSPF LSDB Table..... | 368 |
| Browse OSPF Neighbor Table..... | 369 |
| Browse OSPF Virtual Neighbor Table..... | 370 |
| Switch Logs | 371 |
| Browse ARP Table | 371 |
| MAC Based Access Control Authentication..... | 372 |
| Switch Maintenance..... | 373 |
| Reset..... | 373 |
| Reboot System | 373 |
| Save Services | 374 |
| Save Changes | 374 |
| Current Configuration Settings | 375 |
| Logout..... | 375 |
| Technical Specifications | 376 |
| Cables and Connectors..... | 379 |
| System Log Entries | 380 |
| Cable Lengths..... | 392 |
| Glossary | 393 |
| Warranty and Support..... | 395 |

Preface

The *xStack® DGS-3600 Series User Manual* is divided into sections that describe the system installation and operating instructions with examples.

Section 1, Introduction - Describes the Switch and its features.

Section 2, Installation - Helps you get started with the basic installation of the Switch and also describes the front panel, rear panel, side panels, and LED indicators of the Switch.

Section 3, Connecting the Switch - Tells how you can connect the Switch to your Ethernet/Fast Ethernet/Gigabit Ethernet network.

Section 4, Introduction to Switch Management - Introduces basic Switch management features, including password protection, SNMP settings, IP address assignment, and connecting devices to the Switch.

Section 5, Introduction to Web-based Switch Management - Talks about connecting to and using the Web-based switch management feature on the Switch.

Section 6, Administration - A detailed discussion about configuring the basic functions of the Switch, including Device Information, IP Address, Stacking, Port Configuration, User Accounts, Port Mirroring, System Log, System Severity Settings, SNMP Settings, MAC Notification Settings, TFTP Services, File System Services, Ping Test, IPv6 Neighbor, DHCP Auto Configuration, SNMP Manager, IP-MAC-Port Binding, sFlow, and Single IP Management Settings.

Section 7, L2 Features - A discussion of Layer 2 features of the Switch, including VLAN, Trunking, IGMP Snooping, MLD Snooping, Spanning Tree, Forwarding & Filtering, and LLDP.

Section 8, L3 Features - A discussion of Layer 3 features of the Switch, including Interface Settings, MD5 Key Settings, Route Redistribution Settings, Static/Default Route Settings, Route Preference Settings, Static ARP Settings, Gratuitous ARP Settings, Policy Route Settings, RIP, OSPF, DCHP/BOOTP Relay, DNS Relay, VRRP, and IP Multicast Routing Protocol.

Section 9, QoS - Features information on QoS, including Bandwidth Control, QoS Scheduling Mechanism, QoS Output Scheduling, 802.1p Default Priority, and 802.1p User Priority.

Section 10, ACL - Discussion on the ACL function of the Switch, including Time Range, Access Profile Table, ACL Flow Meter, and CPU Interface Filtering.

Section 11, Security – A discussion on the Security functions on the Switch, including Traffic Control, Port Security, 802.1X, Web Authentication, Trust Host, Access Authentication Control, Safeguard Engine, Traffic Segmentation, SSL, and SSH.

Section 12, Monitoring – Features information on Monitoring including Device Status, Module Information, CPU Utilization, Port Utilization, Packets, Errors, Packet Size, Browse Router Port, Browse MLD Router Port, VLAN Status, VLAN Status Port, Port Access Control, MAC Address Table, IGMP Snooping Group, MLD Snooping Group, Trace Route, IGMP Snooping Forwarding, MLD Snooping Forwarding, IP Forwarding Table, Browse Routing Table, Browse IP Multicast Forwarding Table, Browse IP Multicast Interface Table, Browse IGMP Group Table, DVMRP Monitor, PIM Monitor, OSPF Monitor, Switch Logs, and Browse ARP Table.

Appendix A, Technical Specifications - Technical specifications for the DSG-3612, DGS-3612G, DGS-3627, DGS-3627G and the DGS-3650.

Appendix B, Cables and Connectors - Describes the RJ-45 receptacle/connector, straight through and crossover cables and standard pin assignments.

Appendix C, System Log Entries - Information on all possible entries and their corresponding meanings that appear in the System Log of this Switch.

Appendix D, Cable Lengths - Information on cable types and maximum distances.

Glossary - Lists definitions for terms and acronyms used in this document.

Intended Readers

The *xStack® DGS-3600 Series User Manual* contains information for setup and management of the Switch. The term, “the Switch” will be used when referring to all five switches. This manual is intended for network managers familiar with network management concepts and terminology.

Typographical Conventions

| Convention | Description |
|---------------------------------------|---|
| [] | In a command line, square brackets indicate an optional entry. For example: [copy filename] means that optionally you can type copy followed by the name of the file. Do not type the brackets. |
| Bold font | Indicates a button, a toolbar icon, menu, or menu item. For example: Open the File menu and choose Cancel . Used for emphasis. May also indicate system messages or prompts appearing on your screen. For example: You have mail. Bold font is also used to represent filenames, program names and commands. For example: use the copy command. |
| Boldface Typewriter Font | Indicates commands and responses to prompts that must be typed exactly as printed in the manual. |
| Initial capital letter | Indicates a window name. Names of keys on the keyboard have initial capitals. For example: Click Enter. |
| <i>Italics</i> | Indicates a window name or a field. Also can indicate a variables or parameter that is replaced with an appropriate word or string. For example: type <i>filename</i> means that you should type the actual filename instead of the word shown in italic. |
| Menu Name > Menu Option | Menu Name > Menu Option Indicates the menu structure. Device > Port > Port Properties means the Port Properties menu option under the Port menu option that is located under the Device menu. |

Notes, Notices, and Cautions



A **NOTE** indicates important information that helps you make better use of your device.



A **NOTICE** indicates either potential damage to hardware or loss of data and tells you how to avoid the problem.



A **CAUTION** indicates a potential for property damage, personal injury, or death.

Safety Instructions

Use the following safety guidelines to ensure your own personal safety and to help protect your system from potential damage. Throughout this document, the caution icon () is used to indicate cautions and precautions that you need to review and follow.



Safety Cautions

To reduce the risk of bodily injury, electrical shock, fire, and damage to the equipment, observe the following precautions.

- Observe and follow service markings.
 - Do not service any product except as explained in your system documentation.
 - Opening or removing covers that are marked with the triangular symbol with a lightning bolt may expose you to electrical shock.
 - Only a trained service technician should service components inside these compartments.
- If any of the following conditions occur, unplug the product from the electrical outlet and replace the part or contact your trained service provider:
 - The power cable, extension cable, or plug is damaged.
 - An object has fallen into the product.
 - The product has been exposed to water.
 - The product has been dropped or damaged.
 - The product does not operate correctly when you follow the operating instructions.
- Keep your system away from radiators and heat sources. Also, do not block cooling vents.
- Do not spill food or liquids on your system components, and never operate the product in a wet environment. If the system gets wet, see the appropriate section in your troubleshooting guide or contact your trained service provider.
- Do not push any objects into the openings of your system. Doing so can cause fire or electric shock by shorting out interior components.
- Use the product only with approved equipment.
- Allow the product to cool before removing covers or touching internal components.
- Operate the product only from the type of external power source indicated on the electrical ratings label. If you are not sure of the type of power source required, consult your service provider or local power company.
- To help avoid damaging your system, be sure the voltage on the power supply is set to match the power available at your location:
 - 115 volts (V)/60 hertz (Hz) in most of North and South America and some Far Eastern countries such as South Korea and Taiwan
 - 100 V/50 Hz in eastern Japan and 100 V/60 Hz in western Japan
 - 230 V/50 Hz in most of Europe, the Middle East, and the Far East
- Also, be sure that attached devices are electrically rated to operate with the power available in your location.
- Use only approved power cable(s). If you have not been provided with a power cable for your system or for any AC-powered option intended for your system, purchase a power cable that is approved for use in your country. The power cable must be rated for the product and for the voltage and current marked on the product's electrical ratings label. The voltage and current rating of the cable should be greater than the ratings marked on the product.
- To help prevent electric shock, plug the system and peripheral power cables into properly grounded electrical outlets. These cables are equipped with three-prong plugs to help ensure proper grounding. Do not use adapter plugs or remove the grounding prong from a cable. If you must use an extension cable, use a 3-wire cable with properly grounded plugs.
- Observe extension cable and power strip ratings. Make sure that the total ampere rating of all products plugged into the extension cable or power strip does not exceed 80 percent of the ampere ratings limit for the extension cable or power strip.

- To help protect your system from sudden, transient increases and decreases in electrical power, use a surge suppressor, line conditioner, or uninterruptible power supply (UPS).
- Position system cables and power cables carefully; route cables so that they cannot be stepped on or tripped over. Be sure that nothing rests on any cables.
- Do not modify power cables or plugs. Consult a licensed electrician or your power company for site modifications. Always follow your local/national wiring rules.
- When connecting or disconnecting power to hot-pluggable power supplies, if offered with your system, observe the following guidelines:
 - Install the power supply before connecting the power cable to the power supply.
 - Unplug the power cable before removing the power supply.
 - If the system has multiple sources of power, disconnect power from the system by unplugging all power cables from the power supplies.
- Move products with care; ensure that all casters and/or stabilizers are firmly connected to the system. Avoid sudden stops and uneven surfaces.



General Precautions for Rack-Mountable Products

Observe the following precautions for rack stability and safety. Also, refer to the rack installation documentation accompanying the system and the rack for specific caution statements and procedures.

- Systems are considered to be components in a rack. Thus, "component" refers to any system as well as to various peripherals or supporting hardware.
- Before working on the rack, make sure that the stabilizers are secured to the rack, extended to the floor, and that the full weight of the rack rests on the floor. Install front and side stabilizers on a single rack or front stabilizers for joined multiple racks before working on the rack.
- Always load the rack from the bottom up, and load the heaviest item in the rack first.
- Make sure that the rack is level and stable before extending a component from the rack.
- Use caution when pressing the component rail release latches and sliding a component into or out of a rack; the slide rails can pinch your fingers.
- After a component is inserted into the rack, carefully extend the rail into a locking position, and then slide the component into the rack.
- Do not overload the AC supply branch circuit that provides power to the rack. The total rack load should not exceed 80 percent of the branch circuit rating.
- Ensure that proper airflow is provided to components in the rack.
- Do not step on or stand on any component when servicing other components in a rack.



NOTE: A qualified electrician must perform all connections to DC power and to safety grounds. All electrical wiring must comply with applicable local, regional or national codes and practices.



CAUTION: Never defeat the ground conductor or operate the equipment in the absence of a suitably installed ground conductor. Contact the appropriate electrical inspection authority or an electrician if you are uncertain that suitable grounding is available.



CAUTION: The system chassis must be positively grounded to the rack cabinet frame. Do not attempt to connect power to the system until grounding cables are connected. A qualified electrical inspector must inspect completed power and safety ground wiring. An energy hazard will exist if the safety ground cable is omitted or disconnected.



CAUTION: Do not replace the battery with an incorrect type. The risk of explosion exists if the replacement battery is not the correct lithium battery type. Dispose of used batteries according to the instructions.

Protecting Against Electrostatic Discharge

Static electricity can harm delicate components inside your system. To prevent static damage, discharge static electricity from your body before you touch any of the electronic components, such as the microprocessor. You can do so by periodically touching an unpainted metal surface on the chassis.

You can also take the following steps to prevent damage from electrostatic discharge (ESD):

1. When unpacking a static-sensitive component from its shipping carton, do not remove the component from the antistatic packing material until you are ready to install the component in your system. Just before unwrapping the antistatic packaging, be sure to discharge static electricity from your body.
2. When transporting a sensitive component, first place it in an antistatic container or packaging.
3. Handle all sensitive components in a static-safe area. If possible, use antistatic floor pads, workbench pads and an antistatic grounding strap.

Section 1

Introduction

xStack® DGS-3600 Series

Gigabit Ethernet Technology

Switch Description

Features

Ports

Front-Panel Components

Side Panel Description

Rear Panel Description

xStack® DGS-3600 Series

The DGS-3600 Series is a member of the D-Link xStack® switch family. xStack® is a complete family of stackable devices that ranges from edge 10/100Mbps switches to core Gigabit switches. xStack® provides unsurpassed performance, fault tolerance, scalable flexibility, robust security, standard-based interoperability and an impressive support for 10 Gigabit technology to future-proof departmental and enterprise network deployments with an easy migration path.

The following manual describes the installation, maintenance and configurations concerning members of the D-Link DGS-3600 Series, including the DGS-3612, DGS-3612G, DGS-3627, DGS-3627G, and the DGS-3650. These five switches are identical in configurations and very similar in basic hardware and consequentially, most of the information in this manual will be universal to the total group of Switches. Corresponding screen pictures of the web manager may be taken from any one of these switches but the configuration will be identical, except for varying port counts.

Gigabit Ethernet Technology

Gigabit Ethernet is an extension of IEEE 802.3 Ethernet utilizing the same packet structure, format, and support for CSMA/CD protocol, full duplex, flow control, and management objects, but with a tenfold increase in theoretical throughput over 100Mbps Fast Ethernet and a one hundred-fold increase over 10Mbps Ethernet. Since it is compatible with all 10Mbps and 100Mbps Ethernet environments, Gigabit Ethernet provides a straightforward upgrade without wasting a company's existing investment in hardware, software, and trained personnel.

The increased speed and extra bandwidth offered by Gigabit Ethernet are essential to coping with the network bottlenecks that frequently develop as computers and their busses get faster and more users using applications that generate more traffic. Upgrading key components, such as your backbone and servers to Gigabit Ethernet can greatly improve network response times as well as significantly speed up the traffic between your sub networks.

Gigabit Ethernet enables fast optical fiber connections to support video conferencing, complex imaging, and similar data-intensive applications. Likewise, since data transfers occur 10 times faster than Fast Ethernet, servers outfitted with Gigabit Ethernet NIC's are able to perform 10 times the number of operations in the same amount of time.

In addition, the phenomenal bandwidth delivered by Gigabit Ethernet is the most cost-effective method to take advantage of today and tomorrow's rapidly improving switching and routing internetworking technologies.

Switch Description

The Switch is equipped with unshielded twisted-pair (UTP) cable ports providing dedicated 10, 100 or 1000 Mbps bandwidth. The DGS-3627 is equipped with twenty-four 10/100/1000BASE-T ports, and the DGS-3650 has forty-eight 10/100/1000BASE-T ports, all of which are Auto MDI-X/MDI-II convertible ports that can be used for uplinking to another switch. The DGS-3612G is equipped with twelve 100/1000Mbps SFP (Small Form Factor Portable) ports, in addition to four 1000BASE-T located on the front panel. These ports can be used for connecting PCs, printers, servers, hubs, routers, switches and other networking devices. The dual speed ports use standard twisted-pair cabling and are ideal for segmenting networks into small, connected sub networks for superior performance. Each 10/100/1000 port can support up to 2000 Mbps of throughput in full-duplex mode. In addition, the

Switch has four 1000Mbps SFP combo ports located on the front panel. These gigabit combo ports are ideal for connecting to a server or network backbone.

The DGS-3627G contains twenty-four 1000Mbps SFP (Small Form Factor Portable) ports, in addition to four 1000BASE-T located on the front panel. The DGS-3612 contains twelve 10/100/1000BASE-T ports, all of which are Auto MDI-X/MDI-II convertible ports that can be used for uplinking to another switch, and four 100/1000Mbps SFP (Small Form Factor Portable) ports. The SFP combo ports are to be used with fiber-optical transceiver cabling in order to uplink various other networking devices for a gigabit link that may span great distances. The SFP ports can also support full-duplex transmissions, have auto-negotiation and can be used with DEM-210 (100FX-LC), DEM-211 (100FX-LC), DEM-310GT (1000BASE-LX), DEM-311GT (1000BASE-SX), DEM-312GT2 (1000BASE-SX), DEM-314GT (1000BASE-LH), DEM-315GT (1000BASE-ZX), DEM-330T/R (WDM Transceiver) and the DEM-331T/R (WDM Transceiver) transceivers. These ports are referred to as “combo” ports. That means both the SFP ports and the 1000BASE-T ports are numbered the same and cannot be used simultaneously. Attempting to use the ports simultaneously will cause a link down status for the 1000BASE-T ports. SFP ports will always have priority over these 1000BASE-T ports.

The DGS-3627, DGS-3627G, and the DGS-3650 also contain open slots in the rear of the Switch, which are used to add optional single-port 10GE modules. Two available slots reside within the DGS-3650, while the DGS-3627 and DGS-3627G both contain three slots. These modules, the DEM-410CX CX4 and the DEM-410X XFP, are IEEE 802.3ae and IEEE 802.3ak compliant and support full-duplex mode only. More information will be provided on these modules later in this manual.

This Switch enables the network to use some of the most demanding multimedia and imaging applications concurrently with other user applications without creating bottlenecks. The built-in console interface can be used to configure the Switch's settings for priority queuing, VLANs, and port trunk groups, port monitoring, and port speed.

Features

- IEEE 802.3ad Link Aggregation Control Protocol support.
- IEEE 802.1X Port-based and MAC-based Access Control
- IEEE 802.1Q VLAN
- IEEE 802.1D Spanning Tree, IEEE 802.1w Rapid Spanning Tree, and IEEE 802.1s Multiple Spanning Tree support
- Access Control List (ACL) support
- Single IP Management support
- Access Authentication Control utilizing TACACS, XTACACS, and TACACS+
- Internal Flash Drive for saving configurations and firmware
- Simple Network Time Protocol support
- MAC Notification support
- System and Port Utilization support
- System Log Support
- Support port-based enable and disable
- Address table: Supports up to 16K MAC addresses per device
- Supports a packet buffer of up to 2M bytes
- Port Trunking with flexible load distribution and fail-over function
- IGMP Snooping support
- MLD Snooping support
- SNMP support
- Secure Sockets Layer (SSL) and Secure Shell (SSH) support
- Port Mirroring support
- Web-based Access Control
- MIB support for:
 - RFC1213 MIB II
 - RFC1493 Bridge
 - RFC2819 RMON
 - RFC2665 Ether-like MIB
 - RFC2863 Interface MIB
 - Private MIB
 - RFC2674 for 802.1p
 - IEEE 802.1X MIB

- IEEE 802.3x flow control in full duplex mode
- IEEE 802.1p Priority Queues
- IEEE 802.3u 100BASE-TX compliant
- RS-232 DCE console port for Switch management
- Provides parallel LED display for port status such as link/act, speed, etc.
- IEEE 802.3 10BASE-T compliant
- High performance switching engine performs forwarding and filtering at wire speed, maximum 14, 881 packets/sec on each 10Mbps Ethernet port, maximum 148,810 packet/sec on 100Mbps Fast Ethernet port and 1,488,100 for each Gigabit port.
- Full and half-duplex for both 10Mbps and 100Mbps connections. Full duplex allows the switch port to simultaneously transmit and receive data. It only works with connections to full-duplex-capable end stations and switches. Connections to a hub must take place at half-duplex
- Support broadcast storm filtering
- Non-blocking store and forward switching scheme capability to support rate adaptation and protocol conversion
- Supports by-port Egress/Ingress rate control.
- Efficient self-learning and address recognition mechanism enables forwarding rate at wire speed

Ports

The following table lists the relative ports that are present within each switch:

| DGS-3612 | DGS-3612G | DGS-3627 | DGS-3627G | DGS-3650 |
|--|--|--|--|--|
| <p>Twelve 10/100/1000BASE-T Ports</p> <p>Four SFP Combo Ports</p> <p>One female DCE RS-232 DB-9 console port</p> | <p>Twelve 100/1000Mbps SFP Ports</p> <p>Four 1000BASE-T Combo Ports</p> <p>One female DCE RS-232 DB-9 console port</p> | <p>Twenty-four 10/100/1000BASE-T</p> <p>Four SFP Combo Ports</p> <p>Three open slots used to add single-port 10GE modules</p> <p>One female DCE RS-232 DB-9 console port</p> | <p>Twenty-four 1000Mbps SFP Ports</p> <p>Four 1000BASE-T Combo Ports</p> <p>Three open slots used to add single-port 10GE modules</p> <p>One female DCE RS-232 DB-9 console port</p> | <p>Forty-eight 10/100/1000BASE-T</p> <p>Four SFP Combo Ports</p> <p>Two open slots used to add single-port 10GE modules</p> <p>One female DCE RS-232 DB-9 console port</p> |

The following table lists the features and compatibility for each type of port present in the xStack® DGS-3600 Series.

| 10/100/1000BASE-T | SFP Combo | 1000BASE-T Combo | 10GE Module |
|---|--|--|--|
| <p>IEEE 802.3 compliant</p> <p>IEEE 802.3u compliant</p> <p>IEEE 802.3x flow control support in full-duplex</p> <p>One connector in the rear to add an external Redundant Power Supply (DPS-500)*</p> <p>Auto MDI-X/MDI-II cross over support</p> | <p>Supports the following SFP transceivers:</p> <p>DEM-310GT (1000BASE-LX)</p> <p>DEM-311GT (1000BASE-SX)</p> <p>DEM-312GT2 (1000BASE-LX)</p> <p>DEM-314GT (1000BASE-LH)</p> <p>DEM-315GT (1000BASE-ZX)</p> <p>DEM-330T/R (WDM)</p> <p>DEM-331T/R (WDM)</p> <p>DEM-210* (100FX_LC SM 15Km)</p> <p>DEM-211* (100FX_LC MM 2Km)</p> <p>Takes priority over its 10/100/1000BASE-T combo ports</p> <p>IEEE 802.3z compliant</p> | <p>IEEE 802.3 compliant</p> <p>IEEE 802.3u compliant</p> <p>IEEE 802.3ab compliant</p> <p>IEEE 802.3z compliant</p> <p>IEEE 802.3x flow control support in full-duplex</p> | <p>IEEE 802.3ae compliant</p> <p>IEEE 802.3ak compliant</p> <p>Full-duplex only</p> <p>Supports the following modules:</p> <p>DEM-410CX Single-Port CX4</p> <p>DEM-410X Single-Port XFP</p> <p>One connector in the rear to add an external Redundant Power Supply (DPS-500)</p> |
| *DGS-3612 uses a DPS- | | | |

| | | | |
|----------------------------|----------------------------|--|--|
| 200 Redundant Power Supply | *DGS-3612 & DGS-3612G only | | |
|----------------------------|----------------------------|--|--|



NOTE: The SFP combo ports on the Switch cannot be used simultaneously with the corresponding 1000BASE-T ports. If both ports are in use at the same time (ex. port 1 of the SFP and port 1 of the 1000BASE-T), the SFP ports will take priority over the combo ports and render the 1000BASE-T ports inoperable.

Front-Panel Components

DGS-3612

- Twelve 10/100/1000BASE-T ports
- Four Combo SFP ports located to the right
- One female DCE RS -232 DB-9 console port
- LEDs for Power, Console, RPS, and Link/Act/Speed for each port

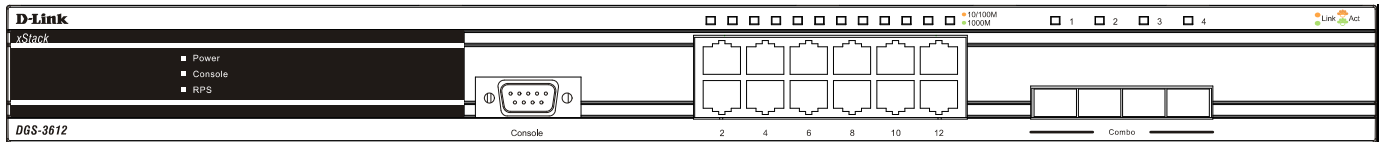

Figure 1- 1. Front Panel of the DGS-3612

DGS-3612G

- Twelve SFP 100/1000Mbps ports
- Four Combo 1000BASE-T ports located to the right
- One female DCE RS -232 DB-9 console port
- LEDs for Power, Console, RPS, and Link/Act/Speed for each port

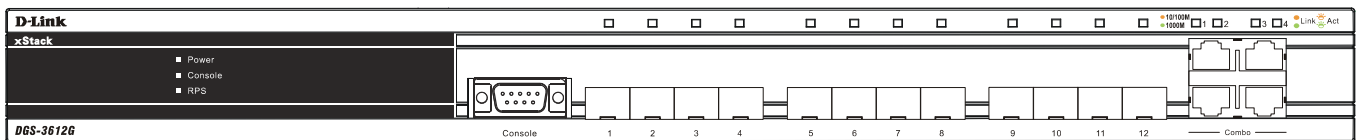

Figure 1- 2. Front Panel of the DGS-3612G

DGS-3627

- Twenty-four 10/100/1000BASE-T ports
- Four Combo SFP ports located to the right
- One female DCE RS-232 DB-9 console port
- LEDs for Power, Console, RPS, Link/Act/Speed and 10GE for each port
- Stacking Module Numbered LED

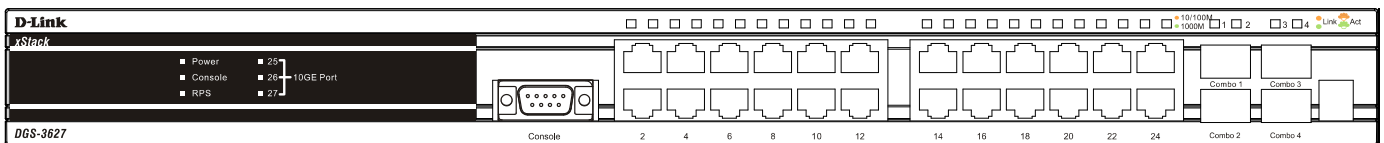

Figure 1- 3. Front Panel of the DGS-3627

DGS-3627G

- Twenty-four SFP 1000Mbps ports
- Four Combo 1000BASE-T ports located to the right
- One female DCE RS -232 DB-9 console port
- LEDs for Power, Console, RPS, Link/Act/Speed and 10GE for each port
- Stacking Module Numbered LED

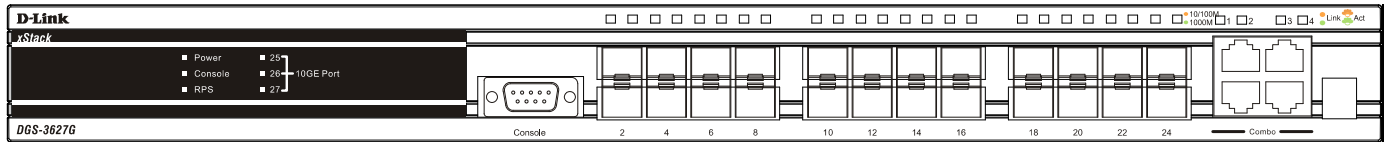

Figure 1- 4. Front Panel of the DGS-3627G

DGS-3650

- Forty-eight 10/100/1000BASE-T ports
- Four Combo SFP ports located to the right
- One female DCE RS -232 DB-9 console port
- LEDs for Power, Console, RPS, Link/Act/Speed and 10GE for each port
- Stacking Module Numbered LED

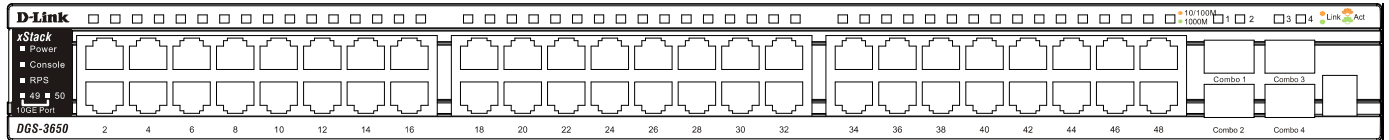

Figure 1- 5. Front Panel of the DGS-3650

LEDs

The following table lists the LEDs located on models of the xStack® DGS-3600 Series switches along with their corresponding description:

| LED Indicator | Color | Status | Description |
|---|--------------------------------------|---------------|---|
| Power | Green | Solid | Power On |
| | | Dark | Power Off |
| Console | Green | Solid | Console On |
| | | Dark | Console Off |
| RPS | Green | Solid | RPS in use |
| | | Dark | RPS not in use or not present |
| Stacking LED | Green | Numbered 1-12 | Box ID of the Switch in the switch stack. This field will read 1 for a switch in standalone mode. When the switch in question is a master of a switch stack, the number of the switch in the stack will be displayed, and the letter H will flash alternatively with this number. |
| Port LEDs (10/100/1000Mbps ports) | Green | Solid | Denotes an active connection at 1000Mbps. |
| | | Blinking | Denotes data transfer at 1000Mbps. |
| | Orange | Solid | Denotes an active connection at 10/100Mbps. |
| | | Blinking | Denotes data transfer at 10/100Mbps. |
| Dark | No Light | Link Down | |
| SFP Port LED | Green | Solid | Denotes an active connection at 1000Mbps. |
| | | Blinking | Denotes data transfer at 1000Mbps. |
| | Orange (DGS-3612 and DGS-3612G only) | Solid | Denotes an active connection at 100Mbps. |
| | | Blinking | Denotes data transfer at 100Mbps. |
| Dark | No Light | Link Down | |
| 10GE Module LEDs (Located on the front panel) | Green | Solid | Denotes an active connection. |
| | | Blinking | Denotes data transfer. |
| | Dark | No Light | Link Down |

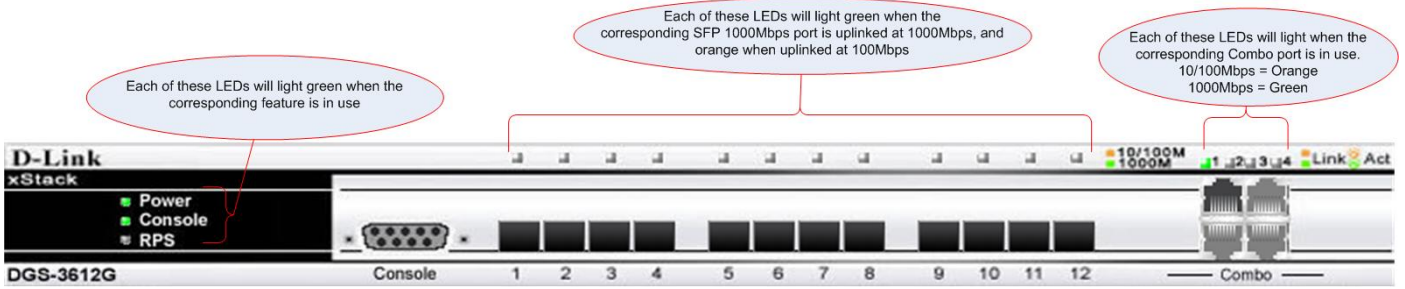

Figure 1- 6. DGS-3612G LEDs

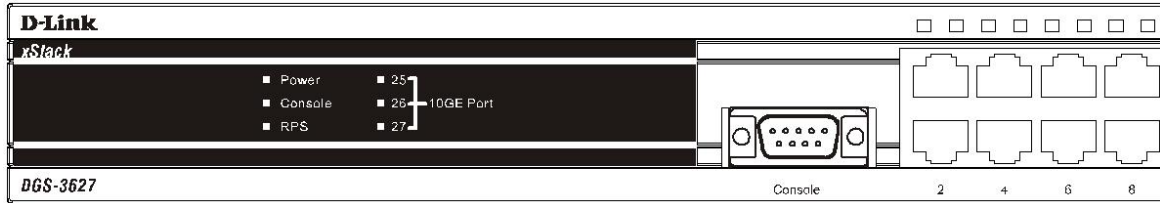

Figure 1- 7. DGS-3627 LEDs



Figure 1- 8. DGS-3627G LEDs

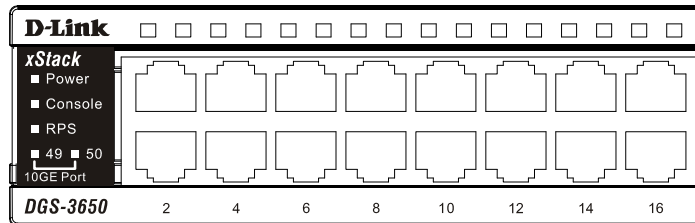

Figure 1- 9. DGS-3650 LEDs

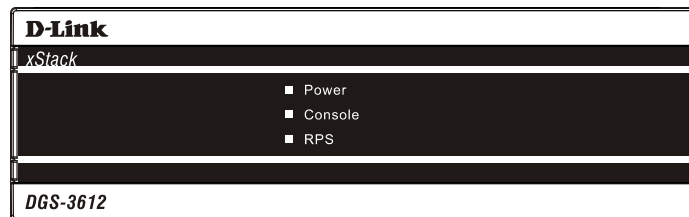

Figure 1- 10. DGS-3612 LEDs

Rear Panel Description

The rear panels of the DGS-3612, DGS-3612G, DGS-3627, DGS-3627G and the DGS-3650 are described below.

DGS-3612 and DGS-3612G

The rear panel of the DGS-3612 and the DGS-3612G contains an AC power connector, and an outlet for an optional external RPS.



Figure 1- 11. Rear panel view of the DGS-3612

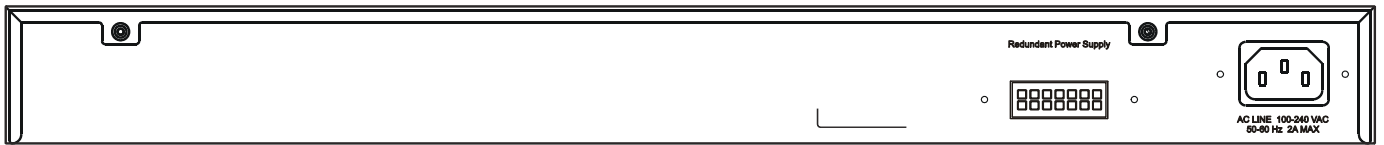

Figure 1- 12. Rear panel view of the DGS-3612G

DGS-3627 and DGS-3627G

The rear panel of DGS-3627 and DGS-3627G contain an AC power connector, an outlet for an optional external RPS, and three slots for additional 10GE optional modules.

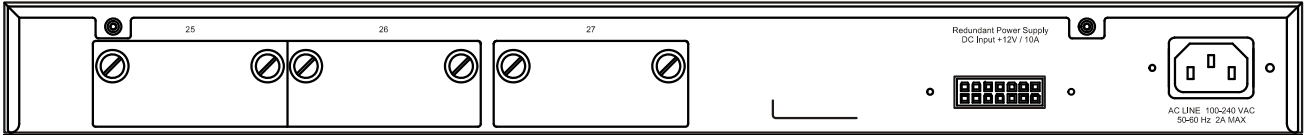

Figure 1- 13. Rear panel view of the DGS-3627 and DGS-3627G

DGS-3650

The rear panel of DGS-3650 contains an AC power connector, an outlet for an optional external RPS, a DCE RS-232 console port, and two slots for additional 10GE optional modules.

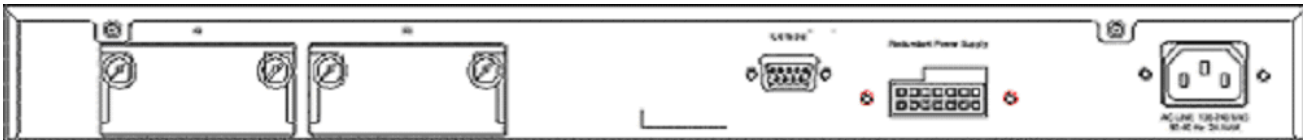

Figure 1- 14. Rear Panel view of DGS-3650

The rear panel includes an outlet for an optional external redundant power supply. When power fails, the optional external RPS will take over all the power immediately and automatically. The AC power connector is a standard three-pronged connector that supports the power cord. Plug-in the female connector of the provided power cord into this socket, and the male side of the cord into a power outlet. The Switch automatically adjusts its power setting to any supply voltage in the range from 100 ~ 240 VAC at 50 ~ 60 Hz.

Side Panel Description

The right-hand side panel of the Switch contains a system fan and ventilation along the entire right side. The left hand panel includes a system fan and a heat vent. The system fans are used to dissipate heat. Do not block these openings on either side of the Switch. Leave at least 6 inches of space at the rear and sides of the Switch for proper ventilation. Be reminded that without proper heat dissipation and air circulation, system components might overheat, which could lead to system failure.

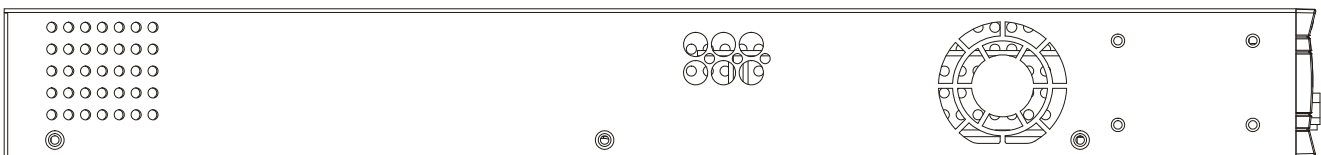

Figure 1- 15. Side Panel of the DGS-3612G

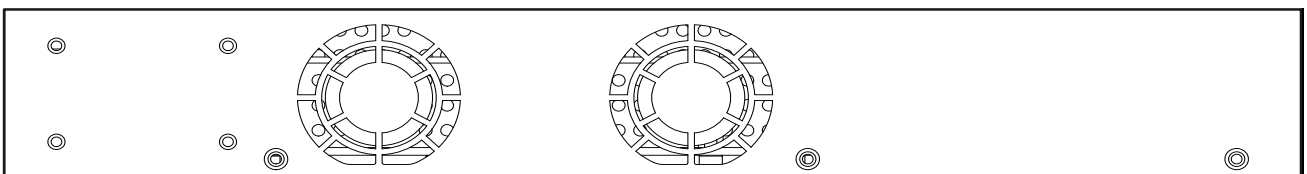

Figure 1- 16. Side Panel of the DGS-3612

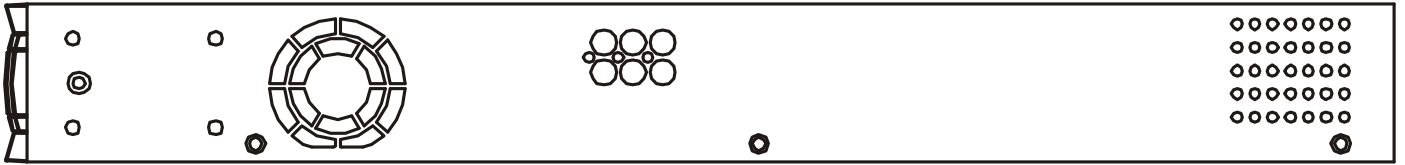

Figure 1- 17. Side Panels of the DGS-3627

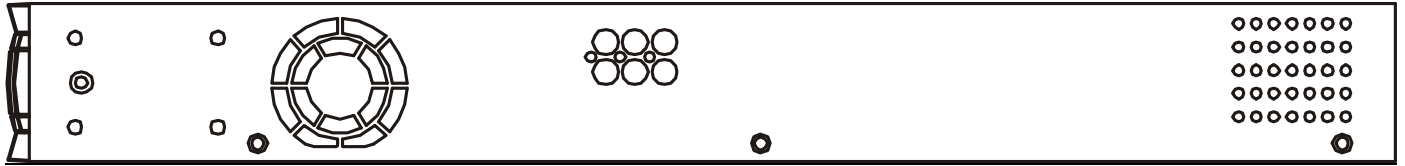

Figure 1- 18. Side Panels of the DGS-3627G

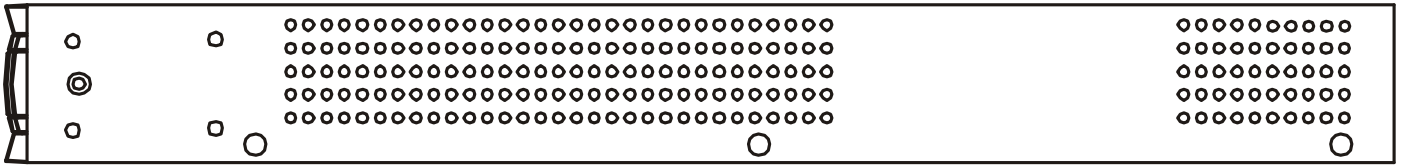
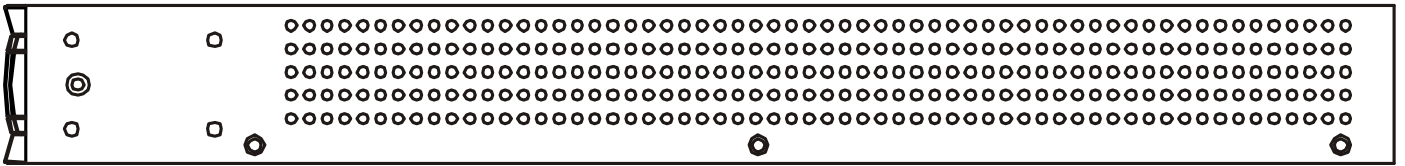

Figure 1- 19. Side Panels of the DGS-3650

10GE Uplink Modules

At the rear of the xStack® DGS-3600 Series switches reside optional module slots. This slot may be equipped with the DEM-410X single-port 10GE XFP uplink module, or a DEM-410CX single-port 10GE CX4 uplink module, both sold separately.

Adding the DEM-410X optional module will allow the administrator to add a single-port 10GE stacking module which will transmit information at a rate of ten gigabits a second. This port is compliant with standard IEEE 802.3ae, supports full-duplex transmissions only and is to be used with XFP MSA compliant transceivers.

The DEM-410CX will transfer information at a rate of ten gigabits a second but is used as an uplink module to a network device. Compliant with the IEEE802.3ak standard, this module will use a 4-laned copper connector to transfer information in full-duplex mode, quickly and accurately. User beware, the cable and connector port used for this module is nearly identical to the stacking ports and cables used for stacking in the xStack® Series, but can in no way be interchangeable.

To install these modules, follow the simple steps listed below.



CAUTION: Before adding the optional module, make sure to disconnect all power sources connected to the Switch. Failure to do so may result in an electrical shock, which may cause damage, not only to the individual but to the Switch as well.

At the back of the Switch to the left is the slot for the optional module, as shown in Figure 1-18 and Figure 1-19. This slot should be covered with a faceplate that can be easily removed by loosening the screws and pulling off the plate.

Optional Module Slots

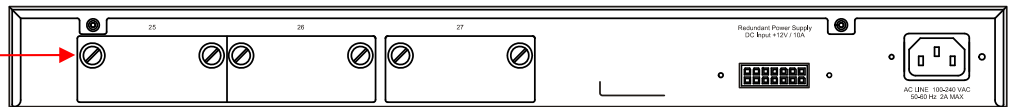

Figure 1- 20. Optional Module slots at the rear of the DGS-3627 (or DGS-3627G)

Optional Module Slots

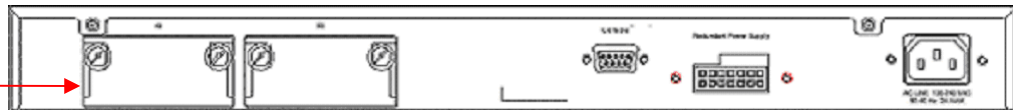

Figure 1- 21. Optional Module slots at the rear of the DGS-3650

After removing the faceplate, remove the DEM-410X or DEM-410CX optional module from its box. The front panel should resemble the drawings represented here.

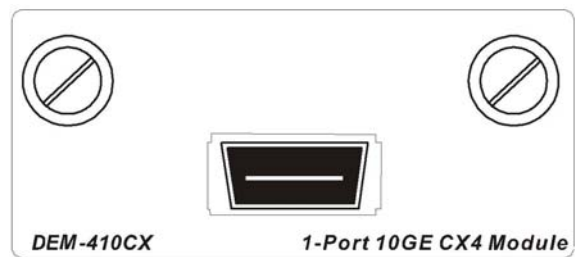
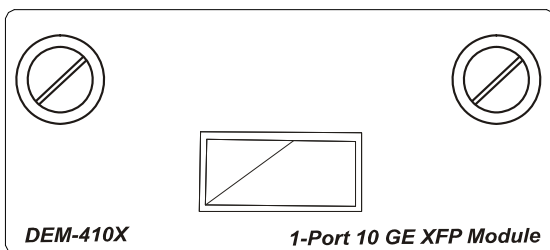

Figure 1- 22. Front Panel of the DEM-410X and the DEM-410CX

Take the module and gently slide it in to the available slot at the rear of the Switch until it reaches the back, as shown in the following figure. At the back of the slot are two sets of plugs that must be connected to the module. Gently, but firmly push in on the module to secure it to the Switch. The module should fit snugly into the corresponding receptors.

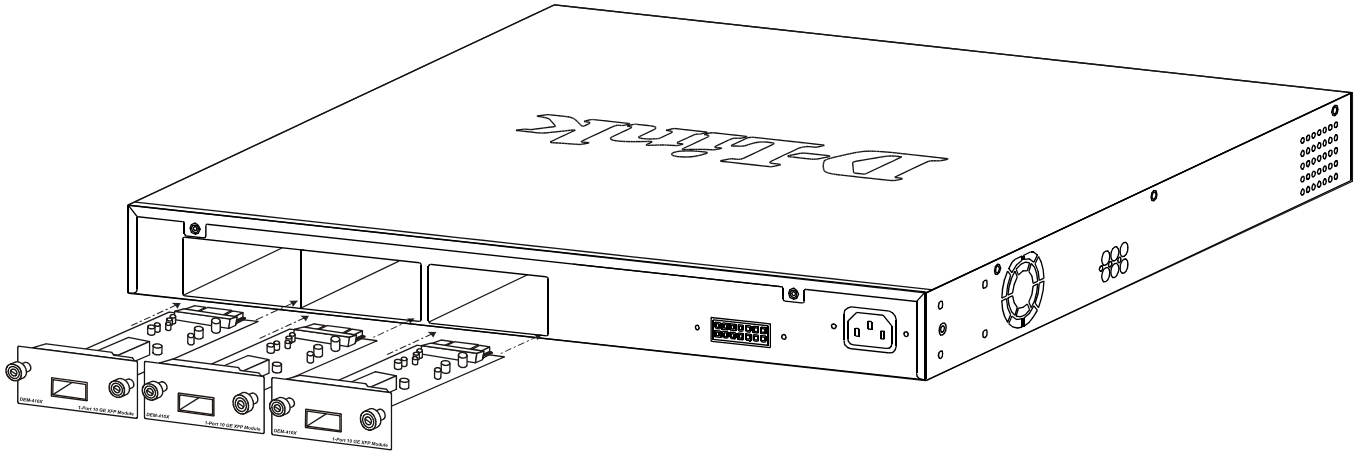

Figure 1- 23. Inserting the optional modules into the Switch.

Now tighten the two screws at adjacent ends of the module into the available screw holes on the Switch. The upgraded DGS-3627/DGS-3627G/DGS-3650 is now ready for use.

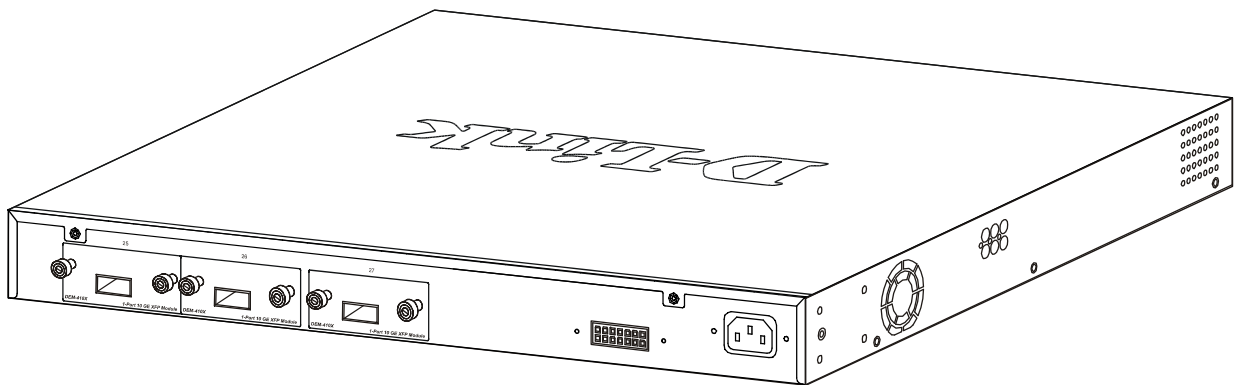

Figure 1- 24. DGS-3627 with optional module installed.

Installing the SFP ports

The xStack® DGS-3600 Series switches are equipped with SFP (Small Form Factor Portable) ports, which are to be used with fiber-optical transceiver cabling in order to uplink various other networking devices for a gigabit link that may span great distances. These SFP ports support full-duplex transmissions, have auto-negotiation and can be used with the DEM-210 (100FX-LC), DEM-211 (100FX-LC), DEM-310GT (1000BASE-LX), DEM-311GT (1000BASE-SX), DEM-312GT2 (1000BASE-LX), DEM-314GT (1000BASE-LH), DEM-315GT (1000BASE-ZX), DEM-330T/R (WDM) and DEM-331T/R (WDM) transceivers. See the figure below for installing the SFP ports in the Switch.

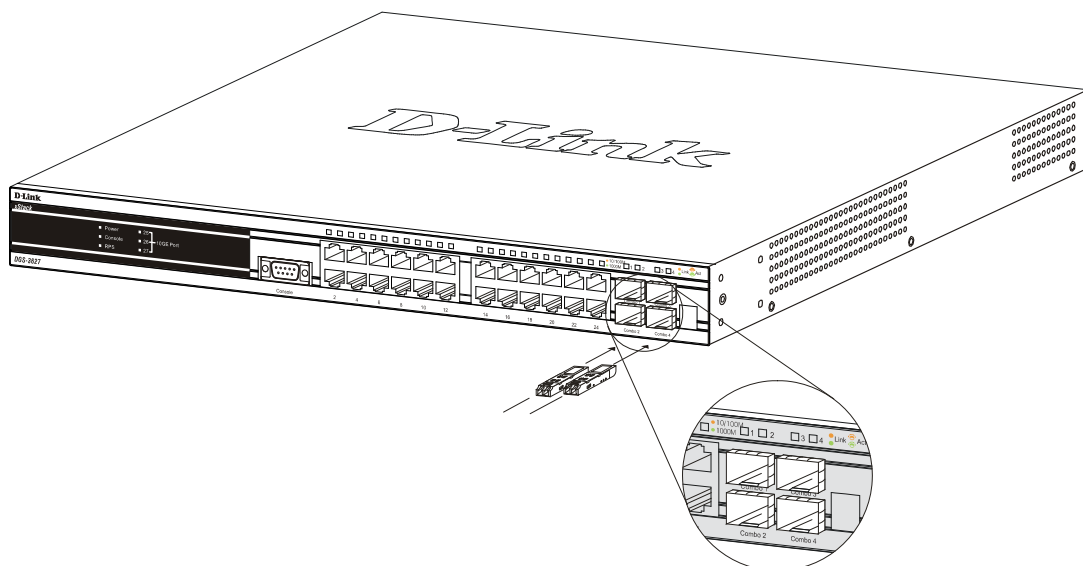

Figure 1- 25. Inserting the fiber-optic transceivers into the DGS-3600 Series switch

SECTION 2

Installation

Package Contents

Before You Connect to the Network

Installing the Switch without the Rack

Rack Installation

Power On

RPS Installation

Package Contents

Open the shipping carton of the Switch and carefully unpack its contents. The carton should contain the following items:

- One Stand-alone Switch
- One AC power cord
- This Manual on CD
- Mounting kit (two brackets and screws)
- Four rubber feet with adhesive backing
- DCE RS-232 console cable

If any item is missing or damaged, please contact your local D-Link Reseller for replacement.

Before You Connect to the Network

The site where you install the Switch may greatly affect its performance. Please follow these guidelines for setting up the Switch.

- Install the Switch on a sturdy, level surface that can support at least 4.24kg (9.35lbs) of weight for the DGS-3612/DGS-3612G/DGS-3627/DGS-3627G, or 6.02kg (13.27lbs) for DGS-3650. Do not place heavy objects on the Switch.
- The power outlet should be within 1.82 meters (6 feet) of the Switch.
- Visually inspect the power cord and see that it is fully secured to the AC/DC power port.
- Make sure that there is proper heat dissipation from and adequate ventilation around the Switch. Leave at least 10 cm (4 inches) of space at the front and rear of the Switch for ventilation.
- Install the Switch in a fairly cool and dry place for the acceptable temperature and humidity operating ranges.
- Install the Switch in a site free from strong electromagnetic field generators (such as motors), vibration, dust, and direct exposure to sunlight.
- When installing the Switch on a level surface, attach the rubber feet to the bottom of the device. The rubber feet cushion the Switch, protect the casing from scratches and prevent it from scratching other surfaces.

Installing the Switch without the Rack

When installing the Switch on a desktop or shelf, the rubber feet included with the Switch should first be attached. Attach these cushioning feet on the bottom at each corner of the device. Allow enough ventilation space between the Switch and any other objects in the vicinity.

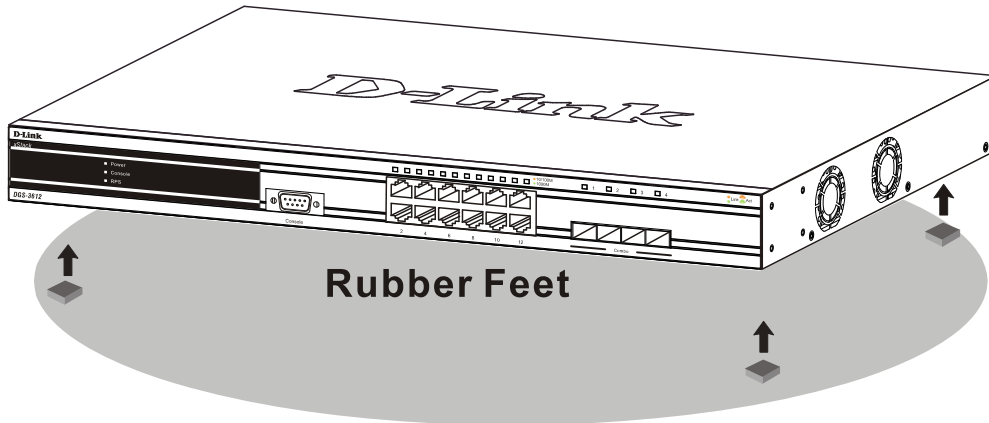

Figure 2 - 1. Prepare Switch for installation on a desktop or shelf

Installing the Switch in a Rack

The Switch can be mounted in a standard 19" rack. Use the following diagrams to guide you.

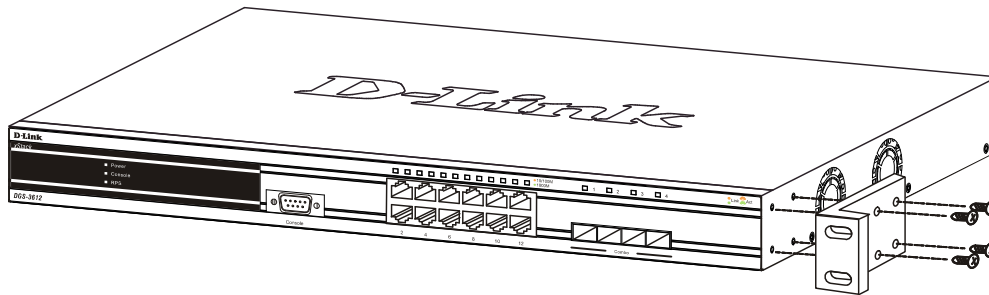

Figure 2 - 2. Fasten mounting brackets to Switch

Fasten the mounting brackets to the Switch using the screws provided. With the brackets attached securely, users can mount the Switch in a standard rack as shown in Figure 2-3 below.

Mounting the Switch in a Standard 19" Rack



CAUTION: Installing systems in a rack without the front and side stabilizers installed could cause the rack to tip over, potentially resulting in bodily injury under certain circumstances. Therefore, always install the stabilizers before installing components in the rack. After installing components in a rack, do not pull more than one component out of the rack on its slide assemblies at one time. The weight of more than one extended component could cause the rack to tip over and may result in injury.

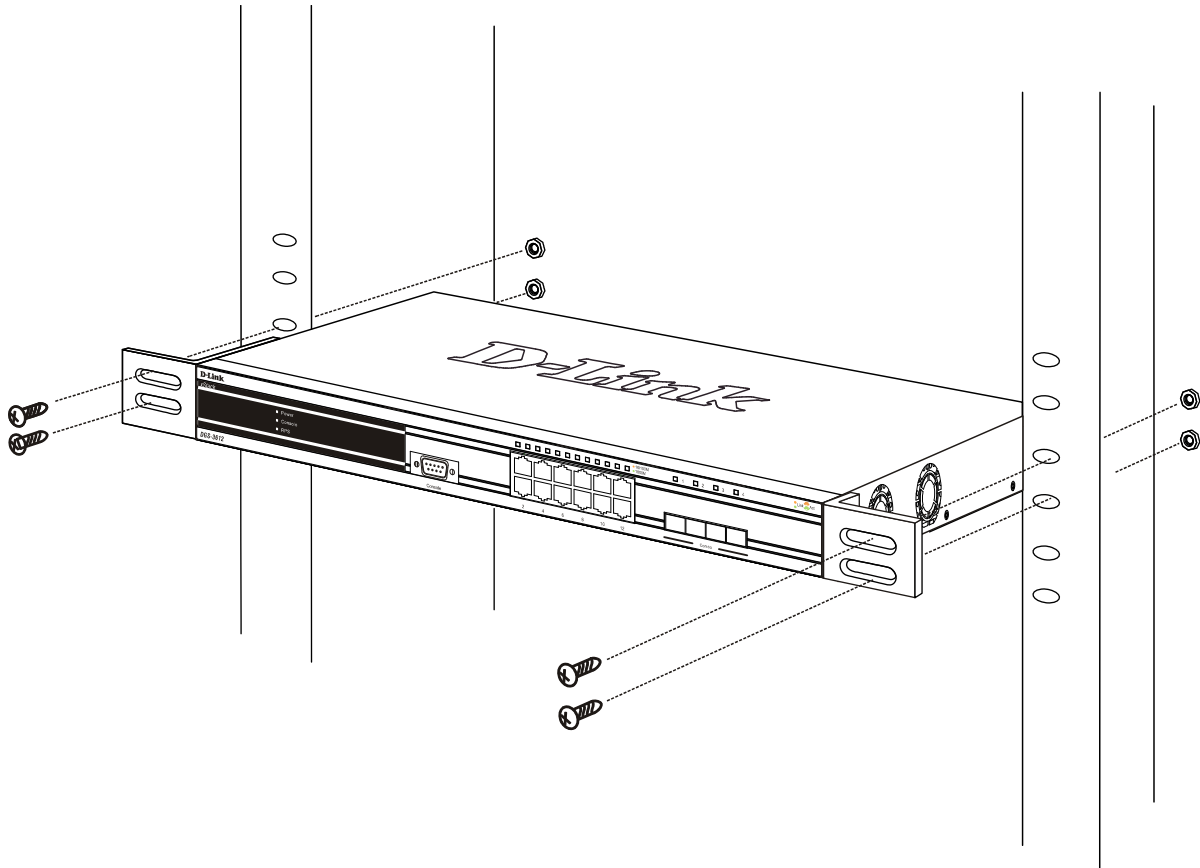

Figure 2 - 3. Installing Switch in a rack

Power on AC Power

Plug one end of the AC power cord into the power connector of the Switch and the other end into the local power source outlet.

After the Switch is powered on, the LED indicators will momentarily blink. This blinking of the LED indicators represents a reset of the system.

Power Failure

For AC power supply units, as a precaution, in the event of a power failure, unplug the Switch. When power has resumed, plug the Switch back in.

RPS Installation

The xStack® DGS-3600 Series switches are equipped with a redundant power supply feature. Follow the instructions below to connect a RPS power supply (DPS-500) to the DGS-3627/DGS-3627G/DGS-3612G/DGS-3650. The DPS-500 is a redundant power-supply unit designed to conform to the voltage requirements of the switches being supported. DPS-500 can be installed into the DPS-900, or DPS-800.



CAUTION: The AC power cord for the Switch should be disconnected before proceeding with installation of the DPS-500.

DGS-3627

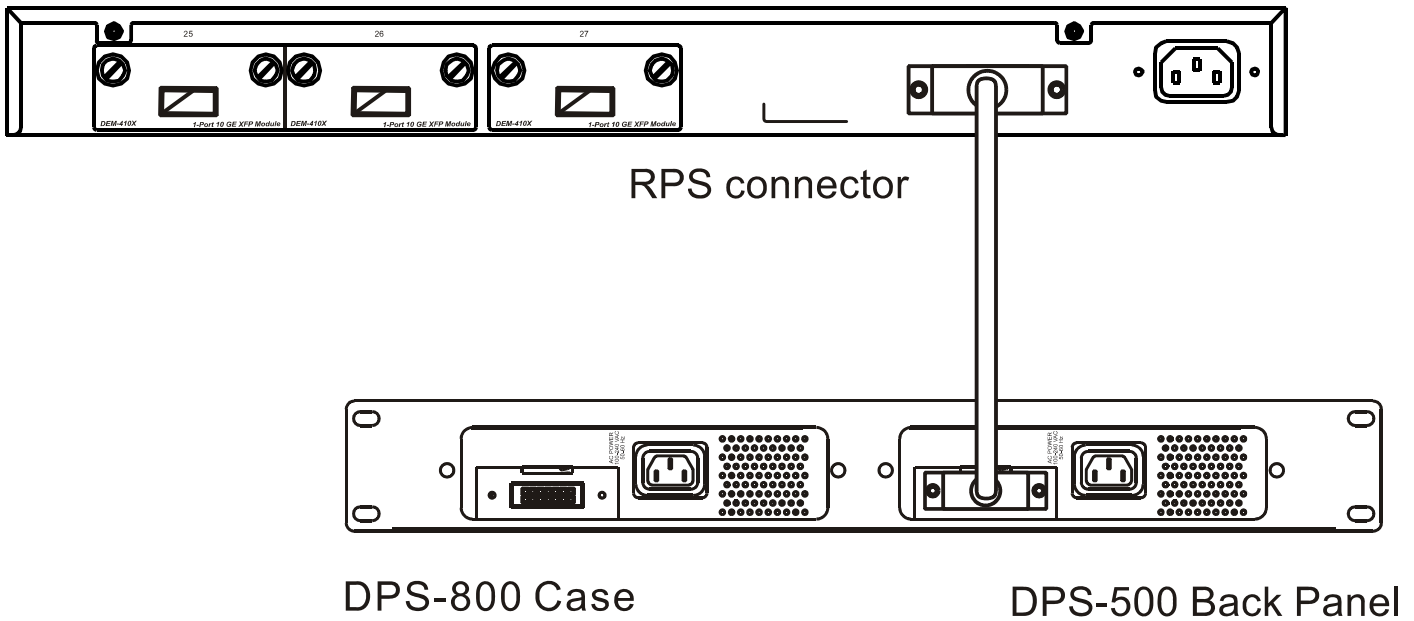

Figure 2 - 4. Installing the DPS-500



CAUTION: Installing systems in a rack without the front and side stabilizers installed could cause the rack to tip over, potentially resulting in bodily injury under certain circumstances. Therefore, always install the stabilizers before installing components in the rack. After installing components in a rack, do not pull more than one component out of the rack on its slide assemblies at one time. The weight of more than one extended component could cause the rack to tip over and may result in injury.

Connect to RPS

The DPS-500 is connected to the Master Switch using a 14-pin DC power cable. A standard, three-pronged AC power cable connects the redundant power supply to the main power source.

DGS-3627

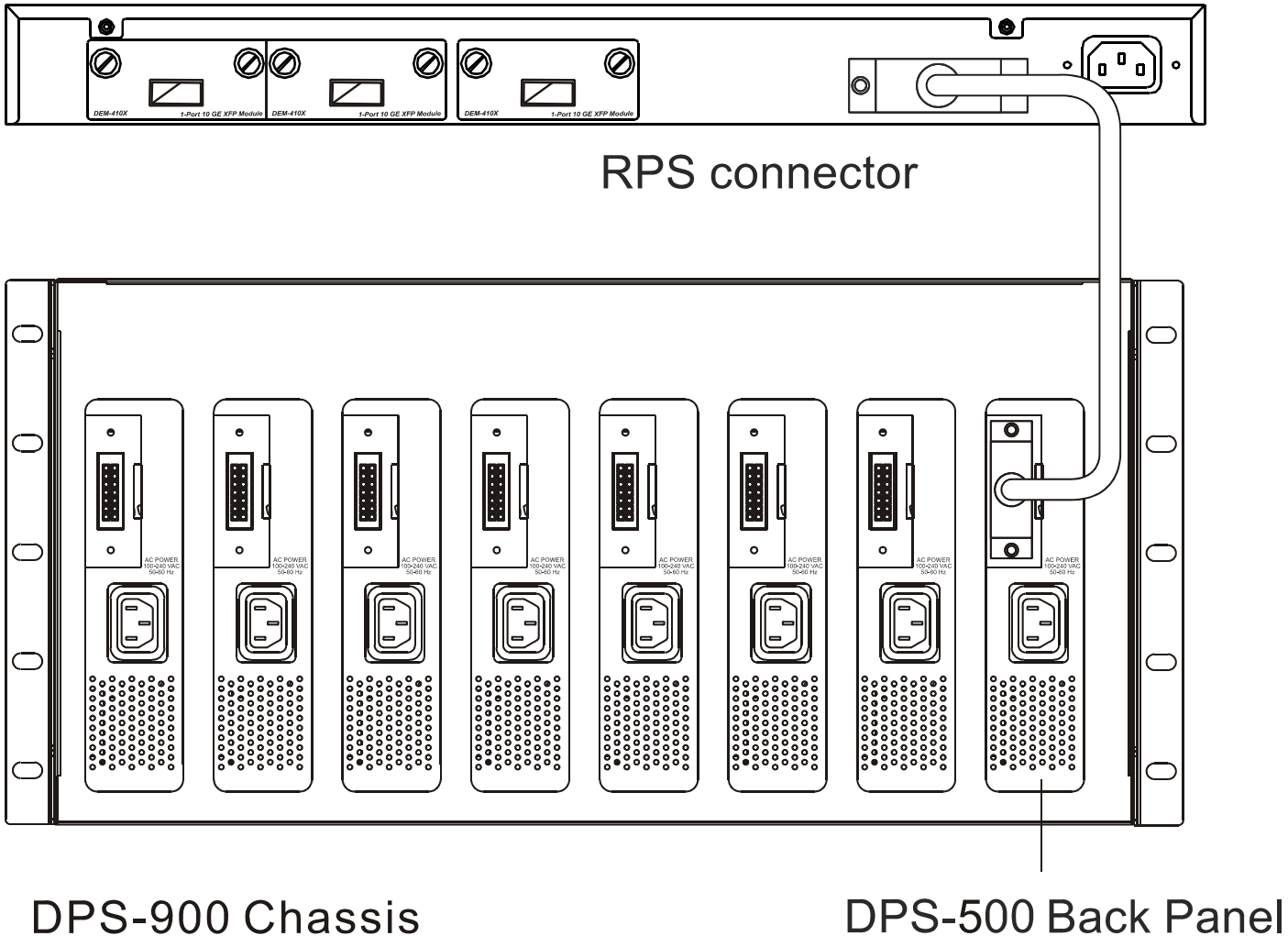

DPS-900 Chassis

DPS-500 Back Panel

Figure 2 - 5. The DGS-3627 with the DPS-500 chassis RPS

1. Insert one end of the 14-pin DC power cable into the receptacle on the switch and the other end into the redundant power supply.
2. Using a standard AC power cable, connect the redundant power supply to the main AC power source. A green LED on the front of the DPS-500 will glow to indicate a successful connection.
3. Re-connect the switch to the AC power source. A LED indicator will show that a redundant power supply is now in operation.
4. No change in switch configuration is necessary for this installation.



NOTE: See the DPS-500 documentation for more information.



CAUTION: Do not use the Switch with any redundant power system other than the DPS-500.

DPS-200

The xStack® DGS-3612 switch can connect an RPS power supply to the Switch (DPS-200) redundant power-supply unit designed to conform to the voltage requirements of the switches being supported. The DPS-200 is a redundant power-supply unit designed to conform to the voltage requirements of the switches being supported. DPS-200 can be installed into DPS-900, or DPS-800.



CAUTION: The AC power cord for the Switch should be disconnected before proceeding with installation of the DPS-200.

DPS-900

The DPS-900 is a standard-size rack mount (5 standard units in height) designed to hold up to eight DPS-200 redundant power supplies.

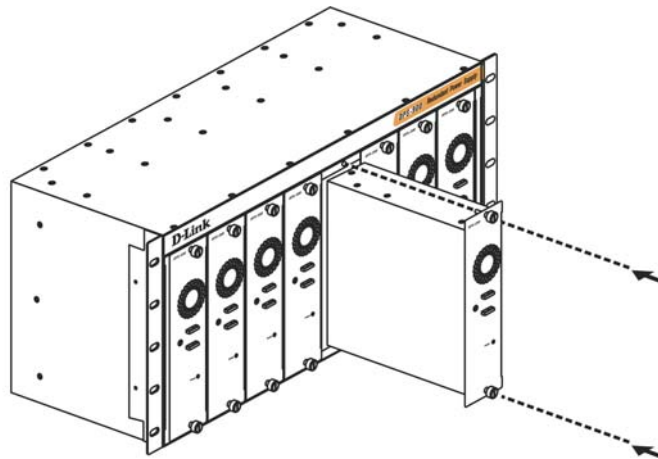

Figure 2 - 6. Installing the DPS-200 into the DPS-900

The RPS can be mounted in a standard 19" rack. Use the following diagram to guide you.

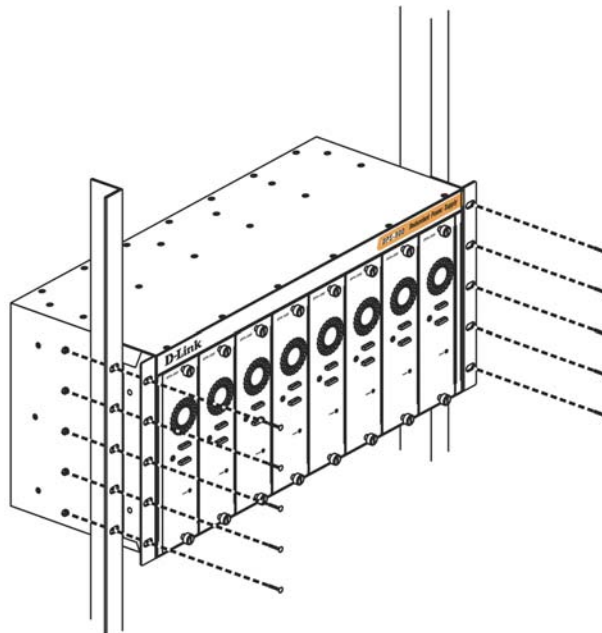

Figure 2 - 7. Installing the DPS-900 into the equipment rack



CAUTION: Installing systems in a rack without the front and side stabilizers installed could cause the rack to tip over, potentially resulting in bodily injury under certain circumstances. Therefore, always install the stabilizers before installing components in the rack. After installing components in a rack, do not pull more than one component out of the rack on its slide assemblies at one time. The weight of more than one extended component could cause the rack to tip over and may result in injury.

DPS-800

The DPS-800 is a standard-size rack mount (1 standard unit in height) designed to hold up to two DPS-200 redundant power supplies.

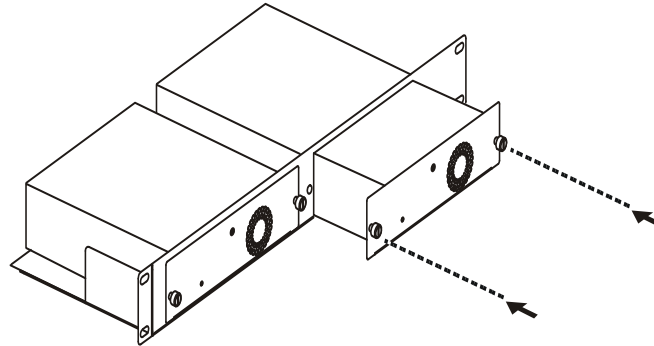

Figure 2 - 8. Install DPS-200 in DPS-800

The RPS can be mounted in a standard 19" rack. Use the following diagram to guide you.

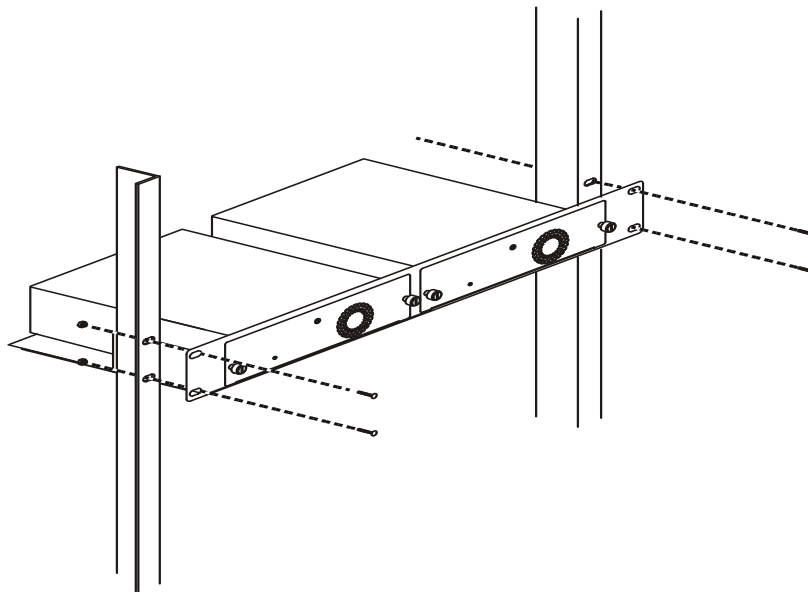

Figure 2 - 9. Install DPS-800 in an Equipment Rack

Section 3

Connecting the Switch

Switch to End Node

Switch to Hub or Switch

Connecting to Network Backbone or Server



NOTE: All 10/100/1000Mbps NWay Ethernet ports can support both MDI-II and MDI-X connections.

Switch to End Node

End nodes include PCs outfitted with a 10, 100 or 1000 Mbps RJ 45 Ethernet/Fast Ethernet Network Interface Card (NIC) and most routers. An end node can be connected to the Switch via a twisted-pair Category 3, 4, or 5 UTP/STP cable. The end node should be connected to any of the ports of the Switch.

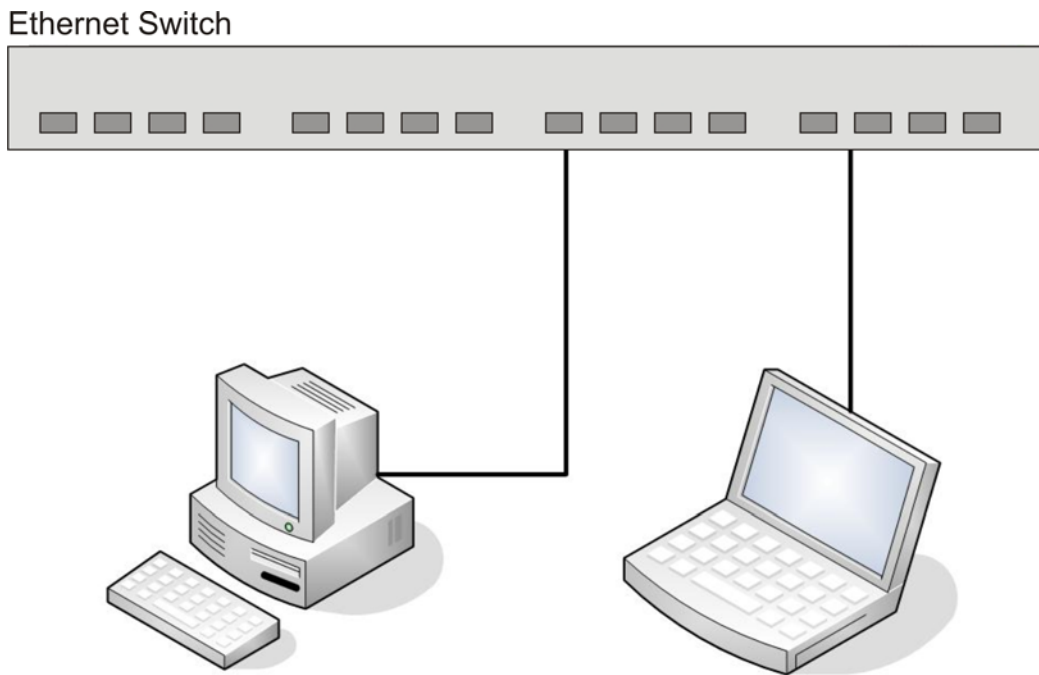

Figure 3- 1. Switch connected to an end node

The Link/Act LEDs for each UTP port will light green or amber when the link is valid. A blinking LED indicates packet activity on that port.

Switch to Hub or Switch

These connections can be accomplished in a number of ways using a normal cable.

- A 10BASE-T hub or switch can be connected to the Switch via a twisted-pair Category 3, 4 or 5 UTP/STP cable.
- A 100BASE-TX hub or switch can be connected to the Switch via a twisted-pair Category 5 UTP/STP cable.
- A 1000BASE-T switch can be connected to the Switch via a twisted pair Category 5e UTP/STP cable.
- A switch supporting a fiber-optic uplink can be connected to the Switch's SFP ports via fiber-optic cabling.

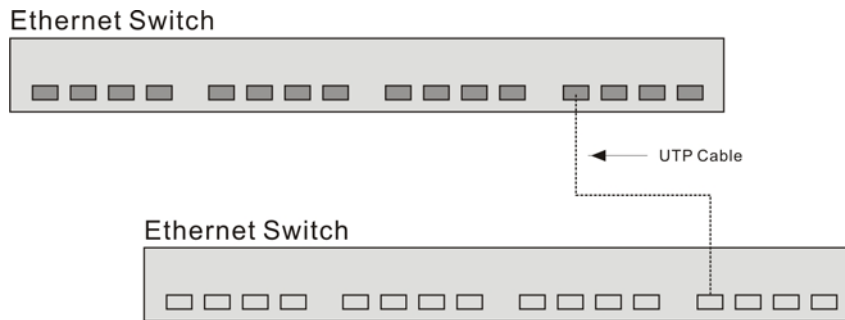

Figure 3- 2. Switch connected to a normal (non-Uplink) port on a hub or switch using a straight or crossover cable



NOTICE: When the SFP transceiver acquires a link, the associated integrated 10/100/1000BASE-T port is disabled.

Connecting To Network Backbone or Server

The two Mini-GBIC combo ports are ideal for uplinking to a network backbone or server. The copper ports operate at a speed of 1000, 100, or 10Mbps in full duplex mode. The fiber optic ports can operate at 1000Mbps in full duplex mode. Connections to the Gigabit Ethernet ports are made using fiber optic cable or Category 5 copper cable, depending on the type of port. A valid connection is indicated when the Link LED is lit.

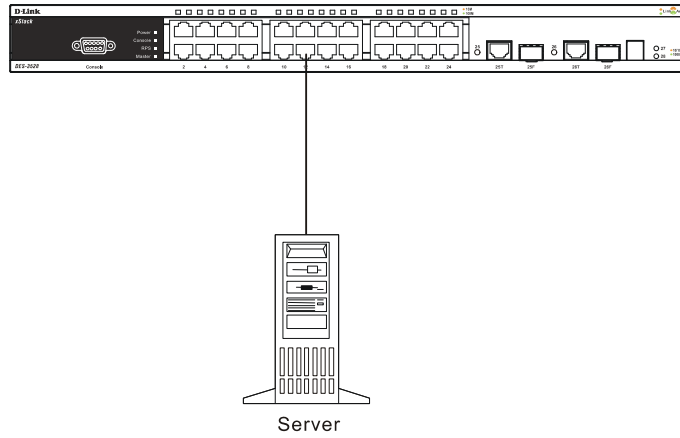

Figure 3- 3. Uplink Connection to a server, PC or switch stack

Section 4

Introduction to Switch Management

Management Options

Web-based Management Interface

SNMP-Based Management

Managing User Accounts

Command Line Console Interface through the Serial Port

Connecting the Console Port (RS-232 DCE)

First Time Connecting to the Switch

Password Protection

SNMP Settings

IP Address Assignment

Management Options

This system may be managed out-of-band through the console port on the front panel or in-band using Telnet. The user may also choose the web-based management, accessible through a web browser.

Web-based Management Interface

After you have successfully installed the Switch, you can configure the Switch, monitor the LED panel, and display statistics graphically using a web browser, such as Netscape Navigator (version 6.2 and higher) or Microsoft® Internet Explorer (version 5.0).

SNMP-Based Management

You can manage the Switch with an SNMP-compatible console program. The Switch supports SNMP version 1.0, version 2.0 and version 3.0. The SNMP agent decodes the incoming SNMP messages and responds to requests with MIB objects stored in the database. The SNMP agent updates the MIB objects to generate statistics and counters.

Connecting the Console Port (RS-232 DCE)

The Switch provides an RS-232 serial port that enables a connection to a computer or terminal for monitoring and configuring the Switch. This port is a female DB-9 connector, implemented as a Data Communication Equipment (DCE) connection.

To use the console port, you need the following equipment:

- A terminal or a computer with both a serial port and the ability to emulate a terminal.
- A null modem or straight RS-232 cable with a female DB-9 connector for the console port on the Switch.

To connect a terminal to the console port:

1. Connect the female connector of the RS-232 cable directly to the console port on the Switch, and tighten the captive retaining screws.
2. Connect the other end of the cable to a terminal or to the serial connector of a computer running terminal emulation software. Set the terminal emulation software as follows:
3. Select the appropriate serial port (COM port 1 or COM port 2).
4. Set the data rate to 115200 baud.
5. Set the data format to 8 data bits, 1 stop bit, and no parity.
6. Set flow control to none.

7. Under Properties, select VT100 for Emulation mode.
8. Select Terminal keys for Function, Arrow, and Ctrl keys. Ensure that you select Terminal keys (not Windows keys).



NOTE: When you use HyperTerminal with the Microsoft® Windows® 2000 operating system, ensure that you have Windows 2000 Service Pack 2 or later installed. Windows 2000 Service Pack 2 allows you to use arrow keys in HyperTerminal's VT100 emulation. See www.microsoft.com for information on Windows 2000 service packs.

9. After you have correctly set up the terminal, plug the power cable into the power receptacle on the back of the Switch. The boot sequence appears in the terminal.
10. After the boot sequence completes, the console login screen displays.
11. If you have not logged into the command line interface (CLI) program, press the Enter key at the User name and password prompts. There is no default user name and password for the Switch. The administrator must first create user names and passwords. If you have previously set up user accounts, log in and continue to configure the Switch.
12. Enter the commands to complete your desired tasks. Many commands require administrator-level access privileges. Read the next section for more information on setting up user accounts. See the *xStack® DGS-3600 Series CLI Manual* on the documentation CD for a list of all commands and additional information on using the CLI.
13. When you have completed your tasks, exit the session with the logout command or close the emulator program.
14. Make sure the terminal or PC you are using to make this connection is configured to match these settings.

If you are having problems making this connection on a PC, make sure the emulation is set to VT-100. You will be able to set the emulation by clicking on the **File** menu in your HyperTerminal window, clicking on **Properties** in the drop-down menu, and then clicking the **Settings** tab. This is where you will find the **Emulation** options. If you still do not see anything, try rebooting the Switch by disconnecting its power supply.

Once connected to the console, the screen below will appear on your console screen. This is where the user will enter commands to perform all the available management functions. The Switch will prompt the user to enter a user name and a password. Upon the initial connection, there is no user name or password and therefore just press enter twice to access the command line interface.

```
DGS-3627G Gigabit Ethernet Switch
Command Line Interface

Firmware: Build 2.50.B15
Copyright(C) 2009 D-Link Corporation. All rights reserved.
```

Figure 4- 1. Initial screen after first connection

First Time Connecting to the Switch

The Switch supports user-based security that can allow you to prevent unauthorized users from accessing the Switch or changing its settings. This section tells how to log onto the Switch.



NOTE: The passwords used to access the Switch are case-sensitive; therefore, "S" is not the same as "s."

When you first connect to the Switch, you will be presented with the first login screen.



NOTE: Press Ctrl+R to refresh the screen. This command can be used at any time to force the console program in the Switch to refresh the console screen.

Press **Enter** in both the Username and Password fields. You will be given access to the command prompt **DGS-3627G:5#** shown below:

There is no initial username or password. Leave the Username and Password fields blank.

```
DGS-3627G Gigabit Ethernet Switch
Command Line Interface

Firmware: Build 2.50.B15
Copyright(C) 2009 D-Link Corporation. All rights reserved.

UserName:
PassWord:

DGS-3627G:5#_
```

Figure 4- 2. Command Prompt



NOTE: The first user automatically gets Administrator level privileges. It is recommended to create at least one Admin-level user account for the Switch.

Password Protection

The Switch does not have a default user name and password. One of the first tasks when settings up the Switch is to create user accounts. Once logged in using a predefined administrator-level user name, users will have privileged access to the Switch's management software.

After your initial login, define new passwords for both default user names to prevent unauthorized access to the Switch, and record the passwords for future reference.

To create an administrator-level account for the Switch, follow these steps:

- At the CLI login prompt, enter **create account admin** followed by the *<user name>* and press the Enter key.

- The switch will then prompt the user for a password. Type the *<password>* used for the administrator account being created and press the **Enter** key.
- Again, the user will be prompted to enter the same password again to verify it. Type the same password and press the Enter key.
- Successful creation of the new administrator account will be verified by a Success message.



NOTE: Passwords are case sensitive. User names and passwords can be up to 15 characters in length.

The sample below illustrates a successful creation of a new administrator-level account with the user name "newmanager".

```
DGS-3627G:5#create account admin newmanager
Command: create account admin newmanager

Enter a case-sensitive new password:*****
Enter the new password again for confirmation:*****

Success.

DGS-3627G:5#
```

Figure 4- 3. Creating a new account



NOTICE: CLI configuration commands only modify the running configuration file and are not saved when the Switch is rebooted. To save all your configuration changes in nonvolatile storage, you must use the save command to copy the running configuration file to the startup configuration.

SNMP Settings

Simple Network Management Protocol (SNMP) is an OSI Layer 7 (Application Layer) designed specifically for managing and monitoring network devices. SNMP enables network management stations to read and modify the settings of gateways, routers, switches, and other network devices. Use SNMP to configure system features for proper operation, monitor performance and detect potential problems in the Switch, switch group or network.

Managed devices that support SNMP include software (referred to as an agent), which runs locally on the device. A defined set of variables (managed objects) is maintained by the SNMP agent and used to manage the device. These objects are defined in a Management Information Base (MIB), which provides a standard presentation of the information controlled by the on-board SNMP agent. SNMP defines both the format of the MIB specifications and the protocol used to access this information over the network.

The Switch supports SNMP versions 1, 2c, and 3. You can specify which version of SNMP you want to use to monitor and control the Switch. The three versions of SNMP vary in the level of security provided between the management station and the network device.

In SNMP v.1 and v.2, user authentication is accomplished using 'community strings', which function like passwords. The remote user SNMP application and the Switch SNMP must use the same community string. SNMP packets from any station that has not been authenticated are ignored (dropped).

The default community strings for the Switch used for SNMP v.1 and v.2 management access are:

- public - Allows authorized management stations to retrieve MIB objects.
- private - Allows authorized management stations to retrieve and modify MIB objects.

SNMP v.3 uses a more sophisticated authentication process that is separated into two parts. The first part is to maintain a list of users and their attributes that are allowed to act as SNMP managers. The second part describes what each user on that list can do as an SNMP manager.

The Switch allows groups of users to be listed and configured with a shared set of privileges. The SNMP version may also be set for a listed group of SNMP managers. Thus, you may create a group of SNMP managers that are allowed to view read-only information or receive traps using SNMP v.1 while assigning a higher level of security to another group, granting read/write privileges using SNMP v.3.

Using SNMP v.3 individual users or groups of SNMP managers can be allowed to perform or be restricted from performing specific SNMP management functions. The functions allowed or restricted are defined using the Object Identifier (OID) associated with a specific MIB. An additional layer of security is available for SNMP v.3 in that SNMP messages may be encrypted. To read more about how to configure SNMP v.3 settings for the Switch read the section entitled Management.

Traps

Traps are messages that alert network personnel of events that occur on the Switch. The events can be as serious as a reboot (someone accidentally turned OFF the Switch), or less serious like a port status change. The Switch generates traps and sends them to the trap recipient (or network manager). Typical traps include trap messages for Authentication Failure, Topology Change and Broadcast\Multicast Storm.

MIBs

The Switch in the Management Information Base (MIB) stores management and counter information. The Switch uses the standard MIB-II Management Information Base module. Consequently, values for MIB objects can be retrieved from any SNMP-based network management software. In addition to the standard MIB-II, the Switch also supports its own proprietary enterprise MIB as an extended Management Information Base. Specifying the MIB Object Identifier may also retrieve the proprietary MIB. MIB values can be either read-only or read-write.

IP Address Assignment

Each Switch must be assigned its own IP Address, which is used for communication with an SNMP network manager or other TCP/IP application (for example BOOTP, TFTP). The Switch's default IP address is 10.90.90.90. You can change the default Switch IP address to meet the specification of your networking address scheme.

The Switch is also assigned a unique MAC address by the factory. This MAC address cannot be changed, and can be found by entering the command "show switch" into the command line interface, as shown below.

```
DGS-3627:5#show switch
Command: show switch

Device Type       : DGS-3612 Gigabit Ethernet Switch
MAC Address       : 00-1C-F0-B5-40-00
IP Address        : 10.24.73.21 (Manual)
VLAN Name         : default
Subnet Mask       : 255.0.0.0
Default Gateway   : 0.0.0.0
Boot PROM Version : Build 1.10-B09
Firmware Version  : Build 2.50.B15
Hardware Version  : A1
Serial Number     : P4F7191000001
System Name       :
System Location   :
System Contact    :
Spanning Tree     : Disabled
GVRP              : Disabled
IGMP Snooping    : Disabled
```

```

MLD Snooping      : Disabled
RIP               : Disabled
DVMRP            : Disabled
PIM              : Disabled
OSPF             : Disabled
TELNET           : Enabled (TCP 23)

CTRL+C ESC q Quit SPACE n Next Page ENTER Next Entry a All

```

Figure 4- 4. Show switch command

The Switch's MAC address can also be found from the Web management program on the **Switch Information (Basic Settings)** window on the **Configuration** folder.

The IP address for the Switch must be set before it can be managed with the Web-based manager. The Switch IP address can be automatically set using BOOTP or DHCP protocols, in which case the actual address assigned to the Switch must be known.

The IP address may be set using the Command Line Interface (CLI) over the console serial port as follows:

Starting at the command line prompt, enter the commands

```
config ipif System ipaddress xxx.xxx.xxx.xxx/yyy.yyy.yyy.yyy
```

Where the x's represent the IP address to be assigned to the IP interface named System and the y's represent the corresponding subnet mask.

Alternatively, you can enter **config ipif System ipaddress xxx.xxx.xxx.xxx/z**. Where the x's represent the IP address to be assigned to the IP interface named System and the z represents the corresponding number of subnets in CIDR notation.

The IP interface named System on the Switch can be assigned an IP address and subnet mask, and then be used to connect a management station to the Switch's Telnet or Web-based management agent.

```

DGS-3627G:5#config ipif System ipaddress 10.73.21.33/255.0.0.0
Command: config ipif System ipaddress 10.73.21.33/8

Success.

DGS-3627G:5#

```

Figure 4- 5. Assigning the Switch an IP Address

In the above example, the Switch was assigned an IP address of 10.73.21.33 with a subnet mask of 255.0.0.0. The user may also use the CIDR form to set the address (10.73.21.33/8). The system message **Success** indicates that the command was executed successfully. The Switch can now be configured and managed via Telnet and the CLI or via the Web-based management.

Section 5

Web-based Switch Configuration

Introduction

Login to Web manager

Web-Based User Interface

Web Pages

Introduction

All software functions of the Switch can be managed, configured and monitored via the embedded web-based (HTML) interface. The Switch can be managed from remote stations anywhere on the network through a standard browser such as Opera, Netscape Navigator/Communicator, or Microsoft Internet Explorer. The browser acts as a universal access tool and can communicate directly with the Switch using the HTTP protocol.

The Web-based management module and the Console program (and Telnet) are different ways to access the same internal switching software and configure it. Thus, all settings encountered in web-based management are the same as those found in the console program.

Login to Web Manager

To begin managing the Switch, simply run the browser you have installed on your computer and point it to the IP address you have defined for the device. The URL in the address bar should read something like: `http://123.123.123.123`, where the numbers 123 represent the IP address of the Switch.



NOTE: The Factory default IP address for the Switch is 10.90.90.90.

This opens the management module's user authentication window, as seen below.

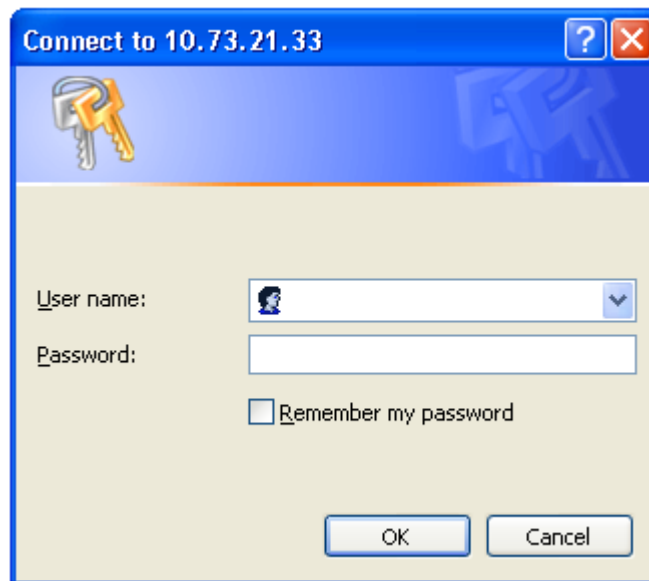

Figure 5- 1. Enter Network Password window

Leave both the User Name field and the Password field blank and click **OK**. This will open the Web-based user interface. The Switch management features available in the web-based manager are explained below.

Web-based User Interface

The user interface provides access to various Switch configuration and management windows, allows you to view performance statistics, and permits you to graphically monitor the system status.

Areas of the User Interface

The figure below shows the user interface. The user interface is divided into three distinct areas as described in the table.



Figure 5- 2. Main Web-Manager page

| Area | Function |
|--------|---|
| Area 1 | Select the folder or window to be displayed. The folder icons can be opened to display the hyper-linked window buttons and subfolders contained within them. Click the D-Link logo to go to the D-Link website. |
| Area 2 | Presents a graphical near real-time image of the front panel of the Switch. This area displays the Switch's ports and expansion modules, showing port activity, duplex mode, or flow control, depending on the specified mode. Various areas of the graphic can be selected for performing management functions, including port configuration. |
| Area 3 | Presents switch information based on your selection and the entry of configuration data. |



NOTICE: Any changes made to the Switch configuration during the current session must be saved in the Save Changes window (explained below) or use the command line interface (CLI) command save.

Web Pages

When you connect to the management mode of the Switch with a web browser, a login window is displayed. Enter a user name and password to access the Switch's management mode.

Below is a list and description of the main folders and windows available in the web interface:

Administration – Contains windows concerning configuring the basic functions of the Switch, including Device Information, IP Address, IP MTU Settings, Stacking, Port Configuration, User Accounts, Port Mirroring, System Log, System Severity Settings, SNMP Settings, MAC Notification Settings, TFTP Services, File System Services, Ping Test, IPv6 Neighbor, DHCP Auto Configuration, BPDU Tunneling Settings, RSPAN, SNMP Manager, sFlow and Single IP Management Settings.

Layer 2 Features – Contains windows concerning Layer 2 features of the Switch, including VLAN, Trunking, IGMP Snooping, MLD Snooping, Loopback Detection Global Settings, Spanning Tree, Forwarding & Filtering, LLDP and QinQ.

Layer 3 Features – A discussion of Layer 3 features of the Switch, including Interface Settings, MD5 Key Settings, Route Redistribution Settings, Multicast Static Route Settings, Static/Default Route Settings, Route Preference Settings, Static ARP Settings, Gratuitous ARP Settings, Policy Route Settings, ECMP Algorithm Settings, RIP, OSPF, DHCP/BOOTP Relay, DHCP Server, Filter DHCP Server, DNS Relay, VRRP, and IP Multicast Routing Protocol.

QoS – Contains windows concerning Bandwidth Control, QoS Scheduling Mechanism, QoS Output Scheduling, 802.1p Default Priority, and 802.1p User Priority.

ACL – Contains windows for Time Range, Access Profile Table, ACL Flow Meter, and CPU Interface Filtering.

Security – Contains windows for Traffic Control, Port Security, IP-MAC-Port Binding, 802.1X, Web Authentication, Trust Host, Access Authentication Control, MAC Based Access Control, Safeguard Engine, Traffic Segmentation, SSL, and SSH.

Monitoring – Contains windows for Device Status, Module Information, CPU Utilization, Port Utilization, Packets, Errors, Packet Size, Browse Router Port, Browse MLD Router Port, VLAN Status, VLAN Status Port, Port Access Control, MAC Address Table, IGMP Snooping Group, MLD Snooping Group, Trace Route, IGMP Snooping Forwarding, MLD Snooping Forwarding, IP Forwarding Table, Browse Routing Table, Browse IP Multicast Forwarding Table, Browse IP Multicast Interface Table, Browse IGMP Group Table, DVMRP Monitor, PIM Monitor, OSPF Monitor, Switch Logs, Browse ARP Table and MAC Based Access Control Authentication Status.

Miscellaneous – Contains windows for Reset, Reboot System, Save Services, and Logout.



NOTE: Be sure to configure the user name and password in the User Accounts window before connecting the Switch to the greater network.

Section 6

Administration

Device Information (DGS-3600 Web Management Tool)

IP Address

IP MTU Settings

Stacking

Port Configuration

User Accounts

Port Mirroring

System Log

System Severity Settings

SNTP Settings

MAC Notification Settings

TFTP Services

File System Services

Ping Test

IPv6 Neighbor

DHCP Auto Configuration Settings

BPDU Tunneling Settings

RSPAN

SNMP Manager

sFlow

Single IP Management Settings

Device Information

This window contains the main settings for all major functions of the Switch and appears automatically when you log on. To return to the **Device Information** window, click the **DGS-3600 Web Management Tool** folder. The **Device Information** window shows the Switch's **MAC Address** (assigned by the factory and unchangeable), the **Boot PROM**, **Firmware Version**, **Hardware Version** and **Serial Number**. This information is helpful to keep track of PROM and firmware updates and to obtain the Switch's MAC address for entry into another network device's address table, if necessary. The user may also enter a **System Name**, **System Location** and **System Contact** to aid in defining the Switch. In addition, this window displays the status of functions on the Switch to quickly assess their current global status. Some functions are hyper-linked to their configuration window for easy access from the **Device Information** window.



NOTE: DGS-3612/DGS-3612G/DGS-3627/DGS-3627G/DGS-3650 Switch series will display the serial number in the **Device Information** window for Firmware version Build 2.50.B25.

| Device Information | |
|-------------------------------------|--|
| Device Type | DGS-3612 Gigabit Ethernet Switch |
| MAC Address | 00-1C-F0-B5-40-00 |
| IP Address | 10.24.73.21 (Manual) |
| VLAN Name | default |
| Subnet Mask | 255.0.0.0 |
| Default Gateway | 0.0.0.0 |
| Boot PROM Version | Build 1.10-B09 |
| Firmware Version | Build 2.50.B15 |
| Hardware Version | A1 |
| Serial Number | P4F7191000001 |
| System Name | <input type="text"/> |
| System Location | <input type="text"/> |
| System Contact | <input type="text"/> |
| Spanning Tree | Disabled Detail Settings |
| CLI Paging | Enabled |
| MAC Notification | Disabled Detail Settings |
| Port Mirror | Disabled Detail Settings |
| SNTP | Disabled Detail Settings |
| DHCP Relay | Disabled Detail Settings |
| DNSR Status | Disabled Detail Settings |
| VRRP | Disabled Detail Settings |
| Single IP Management | Disabled Detail Settings |
| Serial Port Auto Logout | Never <input type="text"/> |
| Serial Port Baud Rate | 115200 <input type="text"/> |
| MAC Address Aging Time (10-1000000) | 300 <input type="text"/> |
| IGMP Snooping | Disabled Detail Settings |
| IGMP Multicast Router Only | Disabled <input type="text"/> |
| MLD Snooping | Disabled Detail Settings |
| MLD Multicast Router Only | Disabled <input type="text"/> |
| GVRP Status | Disabled <input type="text"/> |
| Telnet Status | Enabled <input type="text"/> |
| Telnet TCP Port Number (1-65535) | 23 <input type="text"/> |
| Web Status | Enabled <input type="text"/> |
| Web TCP Port Number(1-65535) | 80 <input type="text"/> |
| SNMP Status | Enabled <input type="text"/> |
| RMON Status | Disabled <input type="text"/> |
| Link Aggregation Algorithm | IP Source <input type="text"/> |
| Switch 802.1X | Disabled <input type="text"/> |
| Auth Protocol | RADIUS EAP <input type="text"/> |
| HOL Prevention | Enabled <input type="text"/> |
| Jumbo Frame | Disabled <input type="text"/> Maximum Frame Size: 1536 bytes |
| Syslog State | Disabled <input type="text"/> |
| ARP Aging Time(0-65535) | 20 <input type="text"/> |
| DVMRP State | Disabled Detail Setting |
| PIM State | Disabled Detail Settings |
| RIP State | Disabled Detail Settings |
| OSPF State | Disabled Detail Settings |

Figure 6- 1. Device Information window

The fields that can be configured are described below:

| Parameter | Description |
|------------------------|--|
| System Name | Enter a system name for the Switch, if so desired. This name will identify it in the Switch network. |
| System Location | Enter the location of the Switch, if so desired. |
| System Contact | Enter a contact name for the Switch, if so desired. |

| | |
|--|--|
| Serial Port Auto Logout | Select the logout time used for the console interface. This automatically logs the user out after an idle period of time, as defined. Choose from the following options: <i>2 Minutes</i> , <i>5 Minutes</i> , <i>10 Minutes</i> , <i>15 Minutes</i> or <i>Never</i> . The default setting is <i>10 minutes</i> . |
| Serial Port Baud Rate | This field specifies the baud rate for the serial port on the Switch. There are four possible baud rates to choose from, <i>9600</i> , <i>19200</i> , <i>38400</i> and <i>115200</i> . For a connection to the Switch using the CLI interface, the baud rate must be set to <i>115200</i> , which is the default setting. |
| MAC Address Aging Time (10-1000000) | This field specifies the length of time a learned MAC Address will remain in the forwarding table without being accessed (that is, how long a learned MAC Address is allowed to remain idle). To change this, type in a different value representing the MAC address age-out time in seconds. The MAC Address Aging Time can be set to any value between <i>10</i> and <i>1,000,000</i> seconds. The default setting is <i>300</i> seconds. |
| IGMP Snooping | To enable system-wide IGMP Snooping capability select <i>Enabled</i> . IGMP snooping is <i>Disabled</i> by default. Enabling IGMP snooping allows you to specify use of a multicast router only (see below). To configure IGMP Snooping for individual VLANs, use the IGMP Snooping Settings window located in the IGMP Snooping folder contained in the L2 Features folder. |
| IGMP Multicast Router Only | This field specifies that the Switch should only forward all multicast traffic to a multicast-enabled router, if enabled. Otherwise, the Switch will forward all multicast traffic to any IP router. The default is <i>Disabled</i> . |
| MLD Snooping | To enable system-wide MLD Snooping capability, select <i>Enabled</i> . MLD snooping is <i>Disabled</i> by default. Enabling MLD snooping allows you to specify use of a multicast router only (see below). To configure MLD Snooping for individual VLANs, use the MLD Snooping window under the MLD Snooping folder. |
| MLD Multicast Router Only | This field specifies that the Switch should only forward all multicast traffic to a multicast-enabled router, if enabled. Otherwise, the Switch will forward all multicast traffic to any IP router. The default is <i>Disabled</i> . |
| GVRP Status | Use this pull-down menu to enable or disable GVRP on the Switch. |
| Telnet Status | Telnet configuration is <i>Enabled</i> by default. If you do not want to allow configuration of the system through Telnet choose <i>Disabled</i> . |
| Telnet TCP Port Number (1-65535) | The TCP port number. TCP ports are numbered between <i>1</i> and <i>65535</i> . The “well-known” TCP port for the Telnet protocol is <i>23</i> . |
| Web Status | Web-based management is <i>Enabled</i> by default. If you choose to disable this by selecting <i>Disabled</i> , you will lose the ability to configure the system through the web interface as soon as these settings are applied. |
| Web TCP Port Number (1-65535) | The web (GUI) port number. TCP ports are numbered between <i>1</i> and <i>65535</i> . The “well-known” TCP port for the Web protocol is <i>80</i> . |
| SNMP Status | Use this pull-down menu to enable or disable Simple Network Management Protocol (SNMP) on the Switch. |
| RMON Status | Remote monitoring (RMON) of the Switch is <i>Enabled</i> or <i>Disabled</i> here. |
| Link Aggregation Algorithm | The algorithm that the Switch uses to balance the load across the ports that make up the port trunk group is defined by this definition. Choose <i>MAC Source</i> , <i>MAC Destination</i> , <i>MAC Src & Dest</i> , <i>IP Source</i> , <i>IP Destination</i> or <i>IP Src & Dest</i> (See the Link Aggregation section of this manual). |
| Switch 802.1X | MAC Address may enable by port or the Switch’s 802.1X function; the default is <i>Disabled</i> . This field must be enabled to view and configure certain windows for 802.1X. Port-Based 802.1X specifies that ports configured for 802.1X are initialized based on the port number only and are subject to any authorization parameters configured. MAC-based Authorization specifies that ports configured for 802.1X are initialized based on the port number and the MAC address of the computer being authorized and are then subject to any authorization parameters configured. |
| Auth Protocol | The 802.1X authentication protocol on the Switch is set to RADIUS Eap and can be configured to local. |

| | |
|---------------------------------|--|
| HOL Prevention | If this option is enabled it prevents the forwarding of data to a port that is blocked. Traffic that would normally be sent to the buffer memory of the Switch's TX queue is dropped so that memory usage is conserved and performance across all ports remains high. |
| Jumbo Frame | This field will enable or disable the Jumbo Frame function on the Switch. The default is Disabled. When enabled, jumbo frames (frames larger than the Ethernet frame size of 1536 bytes) of up to 9216 bytes (tagged) can be transmitted by the Switch. |
| Syslog State | Enables or disables Syslog State; default is <i>Disabled</i> . |
| ARP Aging Time (0-65535) | The user may globally set the maximum amount of time, in minutes, that an Address Resolution Protocol (ARP) entry can remain in the Switch's ARP table, without being accessed, before it is dropped from the table. The value may be set in the range of 0 to 65535 minutes with a default setting of 20 minutes. |
| DVMRP State | The user may globally enable or disable the Distance Vector Multicast Routing Protocol (DVMRP) function by using the pull-down menu. |
| PIM State | The user may globally enable or disable the Protocol Independent Multicast - Dense Mode (PIM-DM) function by using the pull-down menu. |
| RIP State | The user may globally enable or disable the Routing Information Protocol (RIP) function by using the pull-down menu. |
| OSPF State | The user may globally enable or disable the Open Shortest Path first (OSPF) function by using the pull-down menu. |

Click **Apply** to implement changes made.

IP Address

The IP Address may initially be set using the console interface prior to connecting to it through the Ethernet. If the Switch IP address has not yet been changed, read the introduction of the *Command Line Interface Reference Manual* or return to Section 4 of this manual for more information.

To configure the Switch's IP address:

To view the Switch's current IP settings, click **Administration > IP Address**, as shown below.

Figure 6- 2. IP Address window

To manually assign the Switch's IP address, subnet mask, and default gateway address:

1. Select *Manual* from the Get IP From drop-down menu.
2. Enter the appropriate IP Address and Subnet Mask.
3. If you will manage the Switch from the subnet on which it is installed, you can leave the default address (0.0.0.0) in this field.

- If no VLANs have been previously configured on the Switch, you can use the *default* VLAN Name. The *default* VLAN contains all of the Switch ports as members. If VLANs have been previously configured on the Switch, you will need to enter the VLAN Name of the VLAN that contains the port connected to the management station that will access the Switch. The Switch will allow management access from stations with the same VID listed here.



NOTE: The Switch's factory default IP address is 10.90.90.90 with a subnet mask of 255.0.0.0 and a default gateway of 0.0.0.0.

To use the BOOTP or DHCP protocols to assign the Switch an IP address, subnet mask, and default gateway address:

Use the Get IP From pull-down menu to choose from *BOOTP* or *DHCP*. This selects how the Switch will be assigned an IP address.

The IP Address Settings options are:

| Parameter | Description |
|-------------------------------|---|
| BOOTP | The Switch will send out a BOOTP broadcast request when it is powered up. The BOOTP protocol allows IP addresses, network masks, and default gateways to be assigned by a central BOOTP server. If this option is set, the Switch will first look for a BOOTP server to provide it with this information before using the default or previously entered settings. |
| DHCP | The Switch will send out a DHCP broadcast request when it is powered up. The DHCP protocol allows IP addresses, network masks, and default gateways to be assigned by a DHCP server. If this option is set, the Switch will first look for a DHCP server to provide it with this information before using the default or previously entered settings. |
| Manual | Allows the entry of an IP address, Subnet Mask, and a Default Gateway for the Switch. These fields should be of the form xxx.xxx.xxx.xxx , where each xxx is a number (represented in decimal form) between 0 and 255. This address should be a unique address on the network assigned for use by the network administrator. |
| Subnet Mask | A Bitmask that determines the extent of the subnet that the Switch is on. Should be of the form xxx.xxx.xxx.xxx, where each xxx is a number (represented in decimal) between 0 and 255. The value should be 255.0.0.0 for a Class A network, 255.255.0.0 for a Class B network, and 255.255.255.0 for a Class C network, but custom subnet masks are allowed. |
| Default Gateway | IP address that determines where packets with a destination address outside the current subnet should be sent. This is usually the address of a router or a host acting as an IP gateway. If your network is not part of an intranet, or you do not want the Switch to be accessible outside your local network, you can leave this field unchanged. |
| VLAN Name | This allows the entry of a VLAN Name from which a management station will be allowed to manage the Switch using TCP/IP (in-band via web manager or Telnet). Management stations that are on VLANs other than the one entered here will not be able to manage the Switch in-band unless their IP addresses are entered in the Security IP window (Security > Trust Host). If VLANs have not yet been configured for the Switch, the default VLAN contains all of the Switch's ports. There are no entries in the Security IP Management table, by default, so any management station that can connect to the Switch can access the Switch until a management VLAN is specified or Management Station IP Addresses are assigned. |
| Link-Local Address | This read-only field displays the current link-local address, if applicable. |
| Global Unicast Address | This read-only field displays the current global unicast address, if applicable. |

Click **Apply** to implement changes made.

Setting the Switch's IP Address using the Console Interface

Each Switch must be assigned its own IP Address, which is used for communication with an SNMP network manager or other TCP/IP application (for example BOOTP, TFTP). The Switch's default IP address is 10.90.90.90. You can change the default Switch IP address to meet the specification of your networking address scheme.

The IP address for the Switch must be set before it can be managed with the Web-based manager. The Switch IP address can be automatically set using BOOTP or DHCP protocols, in which case the actual address assigned to the Switch must be known. The IP address may be set using the Command Line Interface (CLI) over the console serial port as follows:

- Starting at the command line prompt, enter the commands **config ipif System ipaddress xxx.xxx.xxx.xxx/yyy.yyy.yyy.yyy**. Where the x's represent the IP address to be assigned to the IP interface named System and the y's represent the corresponding subnet mask.
- Alternatively, you can enter **config ipif System ipaddress xxx.xxx.xxx.xxx/z**. Where the x's represent the IP address to be assigned to the IP interface named System and the z represents the corresponding number of subnets in CIDR notation.

The IP interface named System on the Switch can be assigned an IP address and subnet mask, which can then be used to connect a management station to the Switch's Telnet or Web-based management agent.

The system message **Success** indicates that the command was executed successfully. The Switch can now be configured and managed via Telnet and the CLI or via the Web-based management agent using the above IP address to connect to the Switch.

IP MTU Settings

The IP MTU Settings window is used to configure the IP layer MTU settings on the Switch. The MTU is the largest size of IP datagram which may be transferred using a specific data link connection. The MTU value is a design parameter of a LAN and is a mutually agreed value (i.e. both ends of a link agree to use the same specific value) for most WAN links. The size of MTU may vary greatly between different links. Instead of making routers fragment packets, an end system could try to find out the largest IP packet that may be sent to a specific destination.

When one IP host wants to transmit an IP datagram, it is usually preferable that the datagrams be of the largest size that does not require fragmentation anywhere along the path from the source to the destination. The path MTU is equal to the minimum MTUs of each hop in the path.

Path MTU discovery is intended to dynamically discover the PMTU of a path. Basically a source host initially assumes that the PMTU of a path is the (known) MTU of its first hop, and sends all datagrams on that path with the DF bit set. If any of the datagrams are too large to be forwarded without fragmentation by some router along the path, that router will discard them and return ICMP Destination Unreachable messages with a code meaning "fragmentation needed and DF set". Upon receipt of such a message (we can call this message "Datagram Too Big" message), the source host reduces its assumed PMTU for the path. The PMTU discovery process ends when the host's estimate of the PMTU is low enough that its datagrams can be delivered without fragmentation or the host may elect to end the discovery process by ceasing to set the DF bit in the datagram headers.

To configure the Switch's current IP MTU settings, click **Administration > IP MTU Settings**, as shown below.

| IP MTU Settings | |
|--------------------------------------|----------------------|
| IP Interface Name | <input type="text"/> |
| IP MTU (512-1712) | <input type="text"/> |
| <input type="button" value="Apply"/> | |
| IP MTU Table | |
| IP Interface Name | IP MTU |
| System | 1500 |

Figure 6- 3. IP MTU Settings window

The following fields can be configured:

| Parameter | Description |
|--------------------------|---|
| IP Interface Name | Specifies the name of the IP Interface to be used. |
| IP MTU (512-1712) | The user can configure each interface's IP MTU. If the user does not designate an MTU value when creating an interface, the default value of 1500 will be used. |

Stacking

From firmware release v2.00 of this Switch, the xStack® DGS-3600 Series now supports switch stacking, where a set of twelve switches can be combined to be managed by one IP address through Telnet, the GUI interface (web), the console port or through SNMP. Each switch of this series has two stacking slots located at the rear of the device, which can be used to add 10-gigabit DEM-410CX or DEM-410X stacking modules, sold separately. After adding these stacking ports, the user may connect these ports together using copper or fiber stacking cables (also sold separately) in one of two possible topologies.

Duplex Chain – As shown in Figure 6-2, The Duplex Chain topology stacks switches together in a chain-link format. Using this method, data transfer is only possible in one direction and if there is a break in the chain, then data transfer will obviously be affected.

Duplex Ring – As shown in Figure 6-3, the Duplex Ring stacks switches in a ring or circle format where data can be transferred in two directions. This topology is very resilient due to the fact that if there is a break in the ring, data can still be transferred through the stacking cables between switches in the stack.

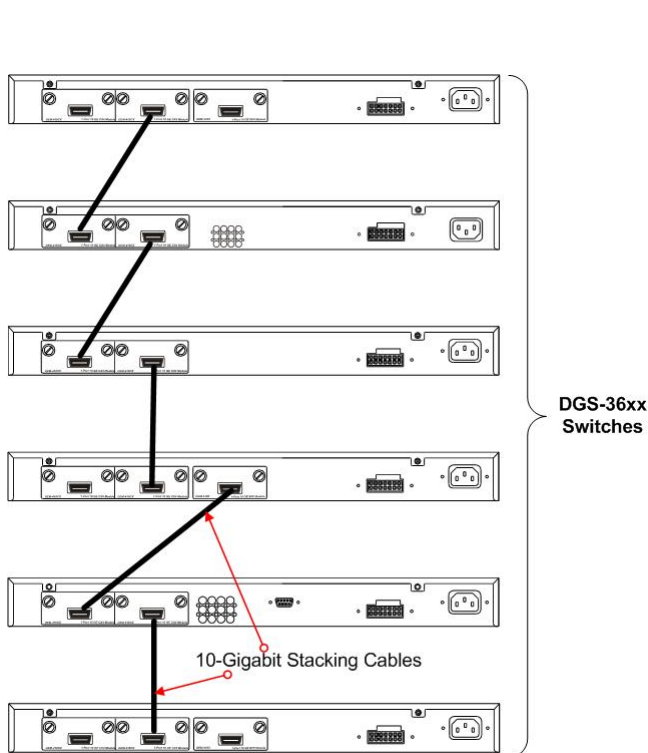

Figure 6- 4. Switches stacked in a Duplex Chain

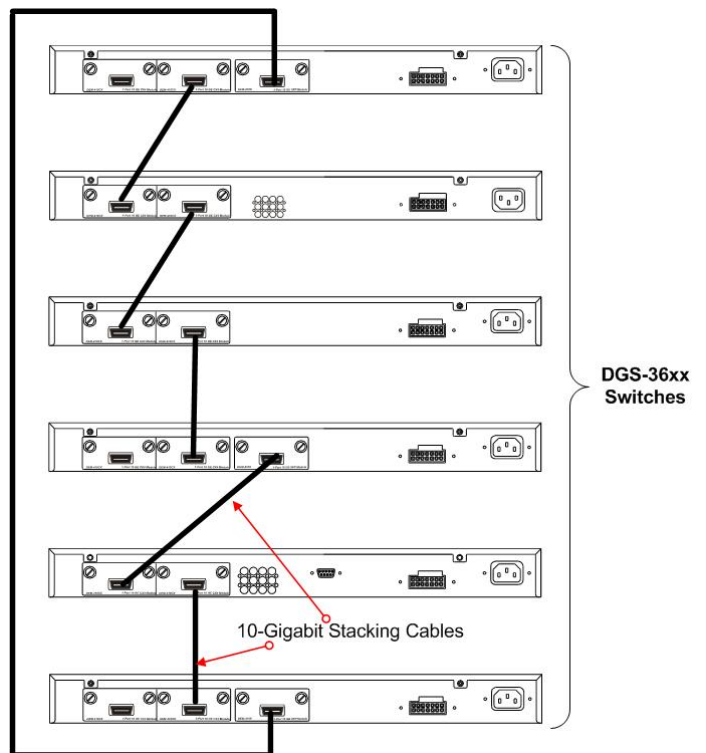

Figure 6- 5. Switches stacked in a Duplex Ring

Within each of these topologies, each switch plays a role in the Switch stack. These roles can be set by the user per individual Switch, or if desired, can be automatically determined by the Switch stack. Three possible roles exist when stacking with the xStack® DGS-3600 Series.



NOTE: Only ports 26 and 27 of the DGS-3627 support stacking. Port 25 cannot be used for stacking, and is to be used only as a 10-Gigabit uplink port.

Primary Master – The Primary Master is the leader of the stack. It will maintain normal operations, monitor operations and the running topology of the Stack. This switch will also assign Stack Unit IDs, synchronize configurations and transmit commands to

remaining switches in the switch stack. The Primary Master can be manually set by assigning this Switch the highest priority (a lower number denotes a higher priority) before physically assembling the stack, or it can be determined automatically by the stack through an election process which determines the lowest MAC address and then will assign that switch as the Primary Master, if all priorities are the same. The Primary master are physically displayed by the seven segment LED to the far right on the front panel of the switch where this LED will flash between its given Box ID and 'H'.

Backup Master – The Backup Master is the backup to the Primary Master, and will take over the functions of the Primary Master if the Primary Master fails or is removed from the Stack. It also monitors the status of neighboring switches in the stack, will perform commands assigned to it by the Primary Master and will monitor the running status of the Primary Master. The Backup Master can be set by the user by assigning this Switch the second highest priority before physically assembling the stack, or it can be determined automatically by the stack through an election process which determines the second lowest MAC address and then will assign that switch as the Backup Master, if all priorities are the same.

Slave – Slave switches constitute the rest of the switch stack and although not Primary or Backup Masters, they can be placed into these roles when these other two roles fail or are removed from the stack. Slave switches perform operations requested by the master, monitor the status of neighbor switches in the stack and the stack topology and adhere to the Backup Master's commands once it becomes a Primary Master. Slave switches will do a self-check to determine if it is to become the Backup Master if the Backup Master is promoted to the Primary Master, or if the Backup Master fails or is removed from the switch stack. If both Primary and Backup masters fail, or are removed from the Switch stack, it will determine if it is to become the Primary Master. These roles will be determined, first by priority and if the priority is the same, the lowest MAC address.

Once switches have been assembled in the topology desired by the user and powered on, the stack will undergo three processes until it reaches a functioning state.

Initialization State – This is the first state of the stack, where the runtime codes are set and initialized and the system conducts a peripheral diagnosis to determine each individual switch is functioning properly.

Master Election State – Once the codes are loaded and initialized, the stack will undergo the Master Election State where it will discover the type of topology used, elect a Primary Master and then a Backup Master.

Synchronization State – Once the Primary Master and the Backup Master have been established, the Primary Master will assign Stacking Unit IDs to switches in the stack, synchronize configurations for all switches and then transmit commands to the rest of the switches based on the users configurations of the Primary Master.

Once these steps have been completed, the switch stack will enter a normal operating mode.

Stack Switch Swapping

The stacking feature of the xStack® DGS-3600 supports “hot swapping” of switches in and out of the running stack. Users may remove or add switches to the stack without powering down or largely affecting the transfer of data between switches in the stack, with a few minor provisions.

When switches are “hot inserted” into the running stack, the new switch may take on the Backup Master or Slave role, depending on configurations set on the newly added switch, such as configured priority or MAC address. The new device will not be the Primary Master, if adding one switch at a time to the Stack. Yet, if adding two stacks together that have both previously undergone the election process, and therefore both have a Primary Master and a Backup master, a new Primary Master will be elected from one of the already existing Primary Masters, based on priority or MAC address. This Primary Master will take over all of the Primary Master's roles for all new switches that were hot inserted. This process is done using discovery packets that circulate through the switch stack every 1.5 seconds until the discovery process has been completed.

The “hot remove” action means removing a device from the stack while the stack is still running. The hot removal is detected by the stack when it fails to receive heartbeat packets during its specified interval from a device, or when one of the stacking ports links is down. Once the device has been removed, the remaining switches will update their stacking topology database to reflect the change. Any one of the three roles, Primary Master, Backup Master or Slave, may be removed from the stack, yet different processes occur for each specific device removal.

If a Slave device has been removed, the Primary Master will inform other switches of the hot remove of this device through the use of unit leave messages. Switches in the stack will clear the configurations of the unit removed, and dynamically learned databases, such as ARP, will be cleared as well.

If the Backup Master has been hot removed, a new Backup Master will be chosen through the election process previously described. Switches in the stack will clear the configurations of the unit removed, and dynamically learned databases, such as ARP, will be cleared as well. Then the Backup Master will begin backing up the Primary Master when the database synchronization has been completed by the stack.

If the Primary Master is removed, the Backup Master will assume the Primary Master's role and a new Backup Master will be chosen using the election process. Switches in the stack will clear the configurations of the unit removed, and dynamically learned databases, such as ARP, will be cleared as well. The new Primary Master will inherit the MAC and IP address of the previous Primary Master to avoid conflict within the stack and the network itself.

If both the Primary Master and the Backup Master are removed, the election process is immediately processed and a new Primary Master and Backup Master is determined. Switches in the stack will clear the configurations of the units removed, and dynamically learned databases, such as ARP, will be cleared as well. Static switch configurations still remain in the database of the remaining switches in the stack and those functions will not be affected.



NOTE: If there is a Box ID conflict when the stack is in the discovery phase, the device will enter a special standalone topology mode. Users can only get device information, configure Box IDs, save and reboot. All stacking ports will be disabled and an error message will be produced on the local console port of each device in the stack. Users must reconfigure Box IDs and reboot the stack.

Stacking Mode Settings

To begin the stacking process, users must first enable this device for stacking by using the following window.

To view this window, click **Administration > Stacking > Mode Settings**, as shown below.

Figure 6- 6. Stacking Mode Settings window

Use the pull-down menu, choose Enabled and click Apply to allow stacking of this Switch.

Box Information

This window is used to configure stacking parameters associated with all switches in the xStack® DGS-3600 Series. The user may configure parameters such as box ID, box priority and pre-assigning model names to switches to be entered into the switch stack.

To view this window click, **Administration > Stacking > Box Information**, as shown below.

Figure 6- 7. Box Information window

| Parameter | Description |
|-----------------------|--|
| Current Box ID | The Box ID of the switch in the stack to be configured. |
| New Box ID | The new box ID of the selected switch in the stack that was selected in the Current Box ID field. The user may choose any number between 1 and 12 to identify the switch in the switch stack. <i>Auto</i> will automatically assign a box number to the switch in the switch stack. |
| Priority | Displays the priority ID of the Switch. The lower the number, the higher the priority. The box (switch) with the lowest priority number in the stack is the Primary Master switch. The Primary Master switch will be used to configure applications of the switch stack. |

Information configured in this window is found in the **Monitoring** folder under **Stack Information**.



NOTE: Configured box priority settings will not be implemented until users physically save it using the Web GUI or the CLI.

IP Interface Setup

Each VLAN must be configured prior to setting up the VLAN's corresponding IP interface.

An example is presented below:

| VLAN Name | VID | Switch Ports |
|------------------|-----|----------------------------|
| System (default) | 1 | 5, 6, 7, 8, 21, 22, 23, 24 |
| Engineer | 2 | 9, 10, 11, 12 |
| Marketing | 3 | 13, 14, 15, 16 |
| Finance | 4 | 17, 18, 19, 20 |
| Sales | 5 | 1, 2, 3, 4 |
| Backbone | 6 | 25, 26 |

Table 6- 1. VLAN Example - Assigned Ports

In this case, six IP interfaces are required, so a CIDR notation of 10.32.0.0/11 (or a 11-bit) addressing scheme will work. This addressing scheme will give a subnet mask of 11111111.11100000.00000000.00000000 (binary) or 255.224.0.0 (decimal).

Using a 10.xxx.xxx.xxx IP address notation, the above example would give six network addresses and six subnets.

Any IP address from the allowed range of IP addresses for each subnet can be chosen as an IP address for an IP interface on the switch.

For this example, we have chosen the next IP address above the network address for the IP interface's IP Address:

| VLAN Name | VID | Network Number | IP Address |
|------------------|-----|----------------|------------|
| System (default) | 1 | 10.32.0.0 | 10.32.0.1 |
| Engineer | 2 | 10.64.0.0 | 10.64.0.1 |
| Marketing | 3 | 10.96.0.0 | 10.96.0.1 |
| Finance | 4 | 10.128.0.0 | 10.128.0.1 |
| Sales | 5 | 10.160.0.0 | 10.160.0.1 |
| Backbone | 6 | 10.192.0.0 | 10.192.0.1 |

Table 6- 2. VLAN Example - Assigned IP Interfaces

The six IP interfaces, each with an IP address (listed in the table above), and a subnet mask of 255.224.0.0 can be entered into the **Setup IP Interface** window.

Port Configuration

This section contains information for configuring various attributes and properties for individual physical ports, including port speed and flow control.

Port Configuration

To display the following window, click **Administration > Port Configuration > Port Configuration**, as shown below.

To configure switch ports:

1. Choose the port or sequential range of ports using the From...To... port pull-down menus.
2. Use the remaining pull-down menus to configure the parameters described below:

| Port Configuration | | | | | | | |
|--|---------|----------------------------------|----------------------------------|-----------------------------------|-----------------------------------|------------------------------------|---------------------------------------|
| Unit | From | To | State | Flow Control | Learning | Medium Type | |
| 1 | Port 1 | Port 1 | Enabled | Disabled | Enabled | Copper | |
| Speed/Duplex | | Capability Advertised | | | Auto Negotiation | Apply | |
| Auto | | <input type="checkbox"/> 10 Half | <input type="checkbox"/> 10 Full | <input type="checkbox"/> 100 Half | <input type="checkbox"/> 100 Full | <input type="checkbox"/> 1000 Full | <input type="checkbox"/> Restart Auto |
| Port Auto Negotiation Information Table-Unit 1 | | | | | | | |
| Port | State | Speed/Duplex | Flow Control | Connection | Learning | | |
| 1 | Enabled | Auto | Disabled | Link Down | Enabled | | |
| 2 | Enabled | Auto | Disabled | Link Down | Enabled | | |
| 3 | Enabled | Auto | Disabled | Link Down | Enabled | | |
| 4 | Enabled | Auto | Disabled | Link Down | Enabled | | |
| 5 | Enabled | Auto | Disabled | Link Down | Enabled | | |
| 6 | Enabled | Auto | Disabled | Link Down | Enabled | | |
| 7 | Enabled | Auto | Disabled | Link Down | Enabled | | |
| 8 | Enabled | Auto | Disabled | Link Down | Enabled | | |
| 9 | Enabled | Auto | Disabled | Link Down | Enabled | | |
| 10 | Enabled | Auto | Disabled | Link Down | Enabled | | |
| 11 | Enabled | Auto | Disabled | Link Down | Enabled | | |
| 12 | Enabled | Auto | Disabled | Link Down | Enabled | | |
| 13 | Enabled | Auto | Disabled | Link Down | Enabled | | |
| 14 | Enabled | Auto | Disabled | Link Down | Enabled | | |
| 15 | Enabled | Auto | Disabled | Link Down | Enabled | | |
| 16 | Enabled | Auto | Disabled | Link Down | Enabled | | |
| 17 | Enabled | Auto | Disabled | Link Down | Enabled | | |
| 18 | Enabled | Auto | Disabled | Link Down | Enabled | | |
| 19 | Enabled | Auto | Disabled | Link Down | Enabled | | |
| 20 | Enabled | Auto | Disabled | Link Down | Enabled | | |
| 21 (C) | Enabled | Auto | Disabled | 100M/Full/None | Enabled | | |
| 21 (F) | Enabled | Auto | Disabled | Link Down | Enabled | | |
| 22 (C) | Enabled | Auto | Disabled | Link Down | Enabled | | |
| 22 (F) | Enabled | Auto | Disabled | Link Down | Enabled | | |
| 23 (C) | Enabled | Auto | Disabled | 1000M/Full/None | Enabled | | |
| 23 (F) | Enabled | Auto | Disabled | Link Down | Enabled | | |
| 24 (C) | Enabled | Auto | Disabled | Link Down | Enabled | | |
| 24 (F) | Enabled | Auto | Disabled | Link Down | Enabled | | |
| 25 | Enabled | Auto | Disabled | Link Down | Enabled | | |

Figure 6- 8. Port Configuration window

The following parameters can be configured:

| Parameter | Description |
|---------------------|---|
| From.... To | Use the pull-down menus to select the port or range of ports to be configured. |
| State | Toggle this field to either enable or disable a given port or group of ports. |
| Speed/Duplex | <p>Toggle the Speed/Duplex field to either select the speed and duplex/half-duplex state of the port. <i>Auto</i> denotes auto-negotiation between 10 and 100 Mbps devices, in full- or half-duplex. The <i>Auto</i> setting allows the port to automatically determine the fastest settings the device the port is connected to can handle, and then to use those settings. The other options are <i>Auto</i>, <i>10M/Half</i>, <i>10M/Full</i>, <i>100M/Half</i> and <i>100M/Full</i>, <i>1000M/Full_M</i> and <i>1000M/Full_S</i>. There is no automatic adjustment of port settings with any option other than <i>Auto</i>.</p> <p>The Switch allows the user to configure two types of gigabit connections; <i>1000M/Full_M</i> and <i>1000M/Full_S</i>. Gigabit connections only support full duplex connections and take on certain characteristics that are different from the other choices listed.</p> <p>The <i>1000M/Full_M</i> (master) and <i>1000M/Full_S</i> (slave) parameters refer to connections running a 1000BASE-T cable for connection between the Switch port and other device capable of a gigabit connection. The master setting (<i>1000M/Full_M</i>) will allow the port to advertise capabilities related to duplex, speed and physical layer type. The master setting will also determine the master and slave relationship between the two connected physical layers. This relationship is necessary for establishing the timing control between the two physical layers. The timing control is set on a master physical layer by a local source. The slave setting (<i>1000M/Full_S</i>) uses loop timing, where the timing comes from a data stream received from the master. If one connection is set for <i>1000M/Full_M</i>, the other side of the connection must be set for <i>1000M/Full_S</i>. Any other configuration will result in a link down status for both ports.</p> |
| Flow Control | Displays the flow control scheme used for the various port configurations. Ports configured for full-duplex use 802.3x flow control, half-duplex ports use backpressure flow control, and <i>Auto</i> ports use an automatic selection of the two. The default is <i>Disabled</i> . |
| Learning | Enable or disable MAC address learning for the selected ports. When <i>Enabled</i> , source MAC addresses are automatically listed in the forwarding table. When learning is <i>Disabled</i> , MAC addresses must be manually entered into the forwarding table. This is sometimes done for security or efficiency. See the section on Forwarding/Filtering for information on entering MAC addresses into the forwarding table. The default setting is <i>Enabled</i> . |
| Medium Type | This applies only to the Combo ports. If configuring the Combo ports this defines the type of transport medium used. SFP ports should be set at <i>Fiber</i> and the Combo 1000BASE-T ports should be set at <i>Copper</i> . |

Click **Apply** to implement the new settings on the Switch.

Port Error Disabled

The following window will display the information about ports that have had their connection status disabled, for reasons such as STP loopback detection or link down status.

To view this window, click **Administration > Port Configuration > Port Error Disabled**, as shown below.

| Port Error Disabled Table | | | |
|---------------------------|-------|------------|--------|
| Port | State | Connection | Reason |
| | | | |

Figure 6- 9. Port Error Disabled Table window

The following parameters are displayed:

| Parameter | Description |
|--------------|---|
| Port | Displays the port that has been error disabled. |
| State | Describes the current running state of the port, whether enabled or disabled. |

| | |
|-------------------|---|
| Connection | This field will read the uplink status of the individual ports, whether enabled or disabled. |
| Reason | Describes the reason why the port has been error-disabled, such as a STP loopback occurrence. |

Port Description

The Switch supports a port description feature where the user may name various ports on the Switch. Use the From and To pull-down menu to choose a port or range of ports to describe, and then enter a description of the port(s). Click **Apply** to set the descriptions in the Port Description Table.

The Medium Type applies only to the Combo ports. If configuring the Combo ports this defines the type of transport medium used. SFP ports should be nominated *Fiber* and the Combo 100BASE-T ports should be nominated *Copper*. The result will be displayed in the appropriate switch port number slot (C for copper ports and F for fiber ports).

To assign names to various ports, click **Administration > Port Configuration > Port Description**, as shown.

The screenshot shows the 'Port Description' configuration window. At the top, there is a header 'Port Description' in a blue bar. Below it is a configuration table with columns: Unit, From, To, Medium Type, Description, and Apply. The 'Unit' dropdown is set to '1', 'From' and 'To' are both set to 'Port 1', and 'Medium Type' is set to 'Copper'. The 'Description' field is empty, and the 'Apply' button is visible. Below this is another blue header 'Port Description Table-Unit 1'. Underneath is a table with two columns: 'Port' and 'Description'. The 'Port' column lists ports from 1 to 25, with the last four rows (21-24) including '(C)' or '(F)' to denote copper or fiber ports. The 'Description' column is currently empty for all rows.

| Unit | From | To | Medium Type | Description | Apply |
|------|--------|--------|-------------|-------------|-------|
| 1 | Port 1 | Port 1 | Copper | | Apply |

| Port | Description |
|--------|-------------|
| 1 | |
| 2 | |
| 3 | |
| 4 | |
| 5 | |
| 6 | |
| 7 | |
| 8 | |
| 9 | |
| 10 | |
| 11 | |
| 12 | |
| 13 | |
| 14 | |
| 15 | |
| 16 | |
| 17 | |
| 18 | |
| 19 | |
| 20 | |
| 21 (C) | |
| 21 (F) | |
| 22 (C) | |
| 22 (F) | |
| 23 (C) | |
| 23 (F) | |
| 24 (C) | |
| 24 (F) | |
| 25 | |

Figure 6- 10. Port Description window

Port Auto Negotiation Information

The Port Auto Negotiation Information window displays the current configurations of a range of ports. Use the drop down menu to select the unit you wish to view and the relevant port information will be displayed in the table below.

To view this window, click **Administration > Port Configuration > Port Auto Negotiation Information**, as shown below.

| Unit 1 | | | | |
|--|------------------|--|--|--|
| Port Auto Negotiation Information Table-Unit 1 | | | | |
| Port | Auto Negotiation | Capability Bits | Capability Advertised Bits | Capability Received Bits |
| 1 | Enabled | 1000M_Full | 1000M_Full | |
| 2 | Enabled | 1000M_Full | 1000M_Full | |
| 3 | Enabled | 1000M_Full | 1000M_Full | |
| 4 | Enabled | 1000M_Full | 1000M_Full | |
| 5 | Enabled | 1000M_Full | 1000M_Full | |
| 6 | Enabled | 1000M_Full | 1000M_Full | |
| 7 | Enabled | 1000M_Full | 1000M_Full | |
| 8 | Enabled | 1000M_Full | 1000M_Full | |
| 9 | Enabled | 1000M_Full | 1000M_Full | |
| 10 | Enabled | 1000M_Full | 1000M_Full | |
| 11 | Enabled | 1000M_Full | 1000M_Full | |
| 12 | Enabled | 1000M_Full | 1000M_Full | |
| 13 | Enabled | 1000M_Full | 1000M_Full | |
| 14 | Enabled | 1000M_Full | 1000M_Full | |
| 15 | Enabled | 1000M_Full | 1000M_Full | |
| 16 | Enabled | 1000M_Full | 1000M_Full | |
| 17 | Enabled | 1000M_Full | 1000M_Full | |
| 18 | Enabled | 1000M_Full | 1000M_Full | |
| 19 | Enabled | 1000M_Full | 1000M_Full | |
| 20 | Enabled | 1000M_Full | 1000M_Full | |
| 21 | Enabled | 10M_Half,10M_Full ,100M_Half,100M_Full ,1000M_Full | 10M_Half,10M_Full ,100M_Half,100M_Full ,1000M_Full | 10M_Half,10M_Full ,100M_Half,100M_Full |
| 22 | Enabled | 1000M_Full | 1000M_Full | |
| 23 | Enabled | 10M_Half,10M_Full ,100M_Half,100M_Full ,1000M_Full | 10M_Half,10M_Full ,100M_Half,100M_Full ,1000M_Full | 10M_Half,10M_Full ,100M_Half,100M_Full ,1000M_Full |
| 24 | Enabled | 1000M_Full | 1000M_Full | |

Figure 6- 11. Port Auto Negotiation Information window

User Accounts

Use the **User Account Management** window to control user privileges. Any existing User Accounts will be displayed in the table below.

To view this window, click **Administration > User Accounts**, as shown below.

| User Accounts | | |
|---------------|--------------|--------|
| User Name | Access Right | Add |
| RG | Admin | Modify |

Figure 6- 12. User Accounts window

To add a new user, click on the **Add** button. To modify or delete an existing user, click on the **Modify** button for that user.

| User Account Add Table | |
|---|--|
| User Name | <input type="text"/> |
| New Password | <input type="text"/> |
| Confirm New Password | <input type="text"/> |
| Access Right | Admin <input type="button" value="v"/> |
| <input type="button" value="Apply"/> | |
| Show All User Account Entries | |

Figure 6- 13. User Account Add Table window

Add a new user by typing in a User Name, and New Password and retype the same password in the Confirm New Password. Choose the level of privilege (*Admin, Operator* or *User*) from the Access Right drop-down menu.

| User Account Modify Table | |
|--|----------------------|
| User Name | RG |
| Old Password | <input type="text"/> |
| New Password | <input type="text"/> |
| Confirm New Password | <input type="text"/> |
| Access Right | Admin |
| <input type="button" value="Apply"/> <input type="button" value="Delete"/> | |
| Show All User Account Entries | |

Figure 6- 14. User Account Modify Table window

Modify or delete an existing user account in the **User Account Modify Table** window. To delete the user account, click on the **Delete** button. To change the password, type in the New Password and retype it in the Confirm New Password entry field. The level of privilege (Admin, Operator or User) can be viewed in the Access Right field.

Port Mirroring

The Switch allows you to copy frames transmitted and received on a port and redirect the copies to another port. You can attach a monitoring device to the mirrored port, such as a sniffer or an RMON probe, to view details about the packets passing through the first port. This is useful for network monitoring and troubleshooting purposes.

To view the **Port Mirroring** window, click **Administration > Port Mirroring**, as shown below.

Port Mirroring

Target Unit: Port:

Status:

Source Unit:

| Port | 1 | 2 | 3 | 4 | 5 | 6 | 7 | 8 | 9 | 10 | 11 | 12 | 13 | 14 | 15 | 16 | 17 | 18 | 19 | 20 | 21 | 22 | 23 | 24 | 25 |
|---------|----------------------------------|----------------------------------|----------------------------------|----------------------------------|----------------------------------|----------------------------------|----------------------------------|----------------------------------|----------------------------------|----------------------------------|----------------------------------|----------------------------------|----------------------------------|----------------------------------|----------------------------------|----------------------------------|----------------------------------|----------------------------------|----------------------------------|----------------------------------|----------------------------------|----------------------------------|----------------------------------|----------------------------------|----------------------------------|
| None | <input checked="" type="radio"/> | <input checked="" type="radio"/> | <input checked="" type="radio"/> | <input checked="" type="radio"/> | <input checked="" type="radio"/> | <input checked="" type="radio"/> | <input checked="" type="radio"/> | <input checked="" type="radio"/> | <input checked="" type="radio"/> | <input checked="" type="radio"/> | <input checked="" type="radio"/> | <input checked="" type="radio"/> | <input checked="" type="radio"/> | <input checked="" type="radio"/> | <input checked="" type="radio"/> | <input checked="" type="radio"/> | <input checked="" type="radio"/> | <input checked="" type="radio"/> | <input checked="" type="radio"/> | <input checked="" type="radio"/> | <input checked="" type="radio"/> | <input checked="" type="radio"/> | <input checked="" type="radio"/> | <input checked="" type="radio"/> | <input checked="" type="radio"/> |
| Ingress | <input type="radio"/> | <input type="radio"/> | <input type="radio"/> | <input type="radio"/> | <input type="radio"/> | <input type="radio"/> | <input type="radio"/> | <input type="radio"/> | <input type="radio"/> | <input type="radio"/> | <input type="radio"/> | <input type="radio"/> | <input type="radio"/> | <input type="radio"/> | <input type="radio"/> | <input type="radio"/> | <input type="radio"/> | <input type="radio"/> | <input type="radio"/> | <input type="radio"/> | <input type="radio"/> | <input type="radio"/> | <input type="radio"/> | <input type="radio"/> | <input type="radio"/> |
| Egress | <input type="radio"/> | <input type="radio"/> | <input type="radio"/> | <input type="radio"/> | <input type="radio"/> | <input type="radio"/> | <input type="radio"/> | <input type="radio"/> | <input type="radio"/> | <input type="radio"/> | <input type="radio"/> | <input type="radio"/> | <input type="radio"/> | <input type="radio"/> | <input type="radio"/> | <input type="radio"/> | <input type="radio"/> | <input type="radio"/> | <input type="radio"/> | <input type="radio"/> | <input type="radio"/> | <input type="radio"/> | <input type="radio"/> | <input type="radio"/> | <input type="radio"/> |
| Both | <input type="radio"/> | <input type="radio"/> | <input type="radio"/> | <input type="radio"/> | <input type="radio"/> | <input type="radio"/> | <input type="radio"/> | <input type="radio"/> | <input type="radio"/> | <input type="radio"/> | <input type="radio"/> | <input type="radio"/> | <input type="radio"/> | <input type="radio"/> | <input type="radio"/> | <input type="radio"/> | <input type="radio"/> | <input type="radio"/> | <input type="radio"/> | <input type="radio"/> | <input type="radio"/> | <input type="radio"/> | <input type="radio"/> | <input type="radio"/> | <input type="radio"/> |
| Port | - | - | - | - | - | - | - | - | - | - | - | - | - | - | - | - | - | - | - | - | - | - | - | - | - |
| None | - | - | - | - | - | - | - | - | - | - | - | - | - | - | - | - | - | - | - | - | - | - | - | - | - |
| Ingress | - | - | - | - | - | - | - | - | - | - | - | - | - | - | - | - | - | - | - | - | - | - | - | - | - |
| Egress | - | - | - | - | - | - | - | - | - | - | - | - | - | - | - | - | - | - | - | - | - | - | - | - | - |
| Both | - | - | - | - | - | - | - | - | - | - | - | - | - | - | - | - | - | - | - | - | - | - | - | - | - |

Note(1): The "Source Port" and "Target Port" should be different, or the setup will be invalid.

Note(2): The target port should be a non-trunked port.

Figure 6- 15. Port Mirroring window

To configure a mirror port:

1. Select the Source Port from where you want to copy frames and the Target Port, which receives the copies from the source port.
2. Select the Source Direction, Ingress, Egress, or Both and change the Status drop-down menu to *Enabled*.
3. Click **Apply** to let the changes take effect.



NOTE: You cannot mirror a fast port onto a slower port. For example, if you try to mirror the traffic from a 100 Mbps port onto a 10 Mbps port, this can cause throughput problems. The port you are copying frames from should always support an equal or lower speed than the port to which you are sending the copies. Also, the target port for the mirroring cannot be a member of a trunk group. Please note a target port and a source port cannot be the same port.



NOTE: When the device with the source port has been removed from a stack, the configuration will be disabled temporarily until another device has been installed in its place. If configurations are saved to NVR RAM during this period the configuration will be removed forever.

System Log

The System log on the Switch can record event information in its own logs, to designated SNMP trap receiving stations, and to the PC connected to the console manager. The **System Log** folder contains two main windows **System Log Host** and **System Log Save Mode Settings**.

System Log Host

The Switch can send Syslog messages to up to four designated servers using the System Log Server.

To view this window, click **Administration > System Log > System Log Host**, as shown below.

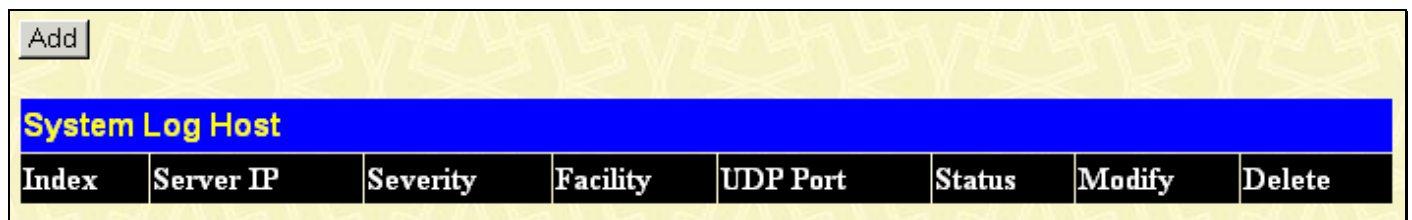

Figure 6- 16. System Log Host window

The parameters configured for adding and editing **System Log Server** settings are the same. See the table below for a description.

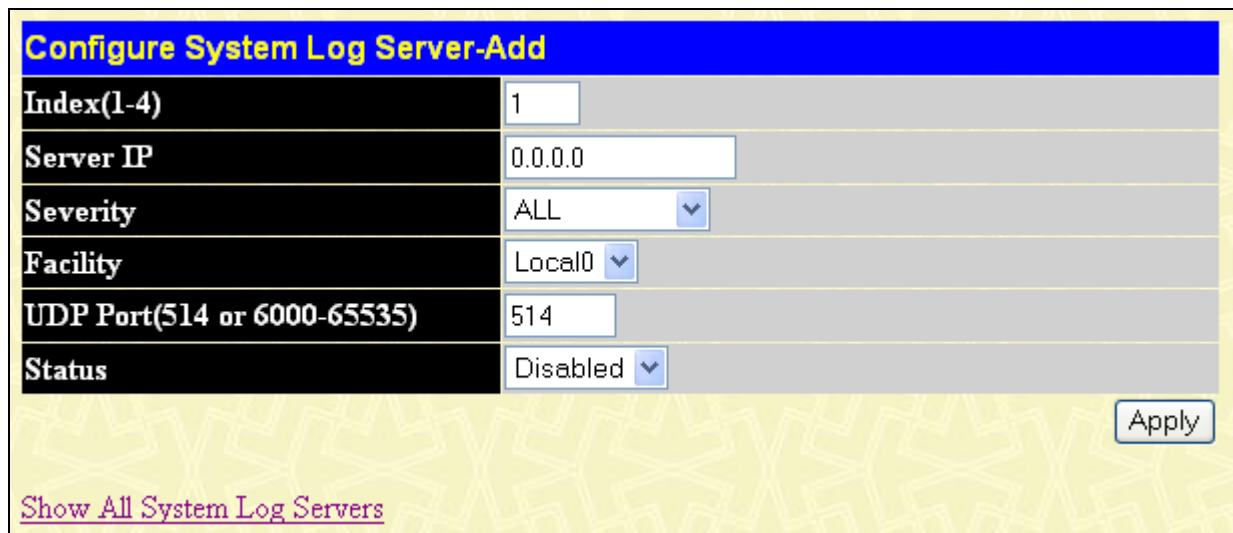

Figure 6- 17. Configure System Log Server – Add window

To set the System Log Server configuration, click **Apply**. To delete an entry from the **System Log Host** window, click the corresponding under the Delete heading of the entry to delete. To return to the **System Log Host** window, click the [Show All System Log Servers](#) link.

The following parameters can be set:

| Parameter | Description |
|------------------|--|
| Index | Syslog server settings index (1 to 4). |
| Server IP | The IP address of the Syslog server. |
| Severity | This drop-down menu allows you to select the level of messages that will be sent. The options are <i>Warning</i> , <i>Informational</i> , and <i>All</i> . |

| Facility | <p>Some of the operating system daemons and processes have been assigned Facility values. Processes and daemons that have not been explicitly assigned a Facility may use any of the "local use" facilities or they may use the "user-level" Facility. Those Facilities that have been designated are shown in the following: Bold font indicates the facility values that the Switch is currently employing.</p> <table border="1"> <thead> <tr> <th data-bbox="368 331 523 389">Numerical Code</th> <th data-bbox="523 331 1505 389">Facility</th> </tr> </thead> <tbody> <tr><td>0</td><td>kernel messages</td></tr> <tr><td>1</td><td>user-level messages</td></tr> <tr><td>2</td><td>mail system</td></tr> <tr><td>3</td><td>system daemons</td></tr> <tr><td>4</td><td>security/authorization messages</td></tr> <tr><td>5</td><td>messages generated internally by syslog line printer subsystem</td></tr> <tr><td>6</td><td>network news subsystem</td></tr> <tr><td>7</td><td>UUCP subsystem</td></tr> <tr><td>8</td><td>clock daemon</td></tr> <tr><td>9</td><td>security/authorization messages</td></tr> <tr><td>10</td><td>FTP daemon</td></tr> <tr><td>11</td><td>NTP subsystem</td></tr> <tr><td>12</td><td>log audit</td></tr> <tr><td>13</td><td>log alert</td></tr> <tr><td>14</td><td>clock daemon</td></tr> <tr><td>15</td><td>local use 0 (local0)</td></tr> <tr><td>16</td><td>local use 1 (local1)</td></tr> <tr><td>17</td><td>local use 2 (local2)</td></tr> <tr><td>18</td><td>local use 3 (local3)</td></tr> <tr><td>19</td><td>local use 4 (local4)</td></tr> <tr><td>20</td><td>local use 5 (local5)</td></tr> <tr><td>21</td><td>local use 6 (local6)</td></tr> <tr><td>22</td><td>local use 7 (local7)</td></tr> </tbody> </table> | Numerical Code | Facility | 0 | kernel messages | 1 | user-level messages | 2 | mail system | 3 | system daemons | 4 | security/authorization messages | 5 | messages generated internally by syslog line printer subsystem | 6 | network news subsystem | 7 | UUCP subsystem | 8 | clock daemon | 9 | security/authorization messages | 10 | FTP daemon | 11 | NTP subsystem | 12 | log audit | 13 | log alert | 14 | clock daemon | 15 | local use 0 (local0) | 16 | local use 1 (local1) | 17 | local use 2 (local2) | 18 | local use 3 (local3) | 19 | local use 4 (local4) | 20 | local use 5 (local5) | 21 | local use 6 (local6) | 22 | local use 7 (local7) |
|-------------------------------------|--|----------------|----------|---|-----------------|---|---------------------|---|-------------|---|----------------|---|---------------------------------|---|--|---|------------------------|---|----------------|---|--------------|---|---------------------------------|----|------------|----|---------------|----|-----------|----|-----------|----|--------------|----|-----------------------------|----|-----------------------------|----|-----------------------------|----|-----------------------------|----|-----------------------------|----|-----------------------------|----|-----------------------------|----|-----------------------------|
| Numerical Code | Facility | | | | | | | | | | | | | | | | | | | | | | | | | | | | | | | | | | | | | | | | | | | | | | | | |
| 0 | kernel messages | | | | | | | | | | | | | | | | | | | | | | | | | | | | | | | | | | | | | | | | | | | | | | | | |
| 1 | user-level messages | | | | | | | | | | | | | | | | | | | | | | | | | | | | | | | | | | | | | | | | | | | | | | | | |
| 2 | mail system | | | | | | | | | | | | | | | | | | | | | | | | | | | | | | | | | | | | | | | | | | | | | | | | |
| 3 | system daemons | | | | | | | | | | | | | | | | | | | | | | | | | | | | | | | | | | | | | | | | | | | | | | | | |
| 4 | security/authorization messages | | | | | | | | | | | | | | | | | | | | | | | | | | | | | | | | | | | | | | | | | | | | | | | | |
| 5 | messages generated internally by syslog line printer subsystem | | | | | | | | | | | | | | | | | | | | | | | | | | | | | | | | | | | | | | | | | | | | | | | | |
| 6 | network news subsystem | | | | | | | | | | | | | | | | | | | | | | | | | | | | | | | | | | | | | | | | | | | | | | | | |
| 7 | UUCP subsystem | | | | | | | | | | | | | | | | | | | | | | | | | | | | | | | | | | | | | | | | | | | | | | | | |
| 8 | clock daemon | | | | | | | | | | | | | | | | | | | | | | | | | | | | | | | | | | | | | | | | | | | | | | | | |
| 9 | security/authorization messages | | | | | | | | | | | | | | | | | | | | | | | | | | | | | | | | | | | | | | | | | | | | | | | | |
| 10 | FTP daemon | | | | | | | | | | | | | | | | | | | | | | | | | | | | | | | | | | | | | | | | | | | | | | | | |
| 11 | NTP subsystem | | | | | | | | | | | | | | | | | | | | | | | | | | | | | | | | | | | | | | | | | | | | | | | | |
| 12 | log audit | | | | | | | | | | | | | | | | | | | | | | | | | | | | | | | | | | | | | | | | | | | | | | | | |
| 13 | log alert | | | | | | | | | | | | | | | | | | | | | | | | | | | | | | | | | | | | | | | | | | | | | | | | |
| 14 | clock daemon | | | | | | | | | | | | | | | | | | | | | | | | | | | | | | | | | | | | | | | | | | | | | | | | |
| 15 | local use 0 (local0) | | | | | | | | | | | | | | | | | | | | | | | | | | | | | | | | | | | | | | | | | | | | | | | | |
| 16 | local use 1 (local1) | | | | | | | | | | | | | | | | | | | | | | | | | | | | | | | | | | | | | | | | | | | | | | | | |
| 17 | local use 2 (local2) | | | | | | | | | | | | | | | | | | | | | | | | | | | | | | | | | | | | | | | | | | | | | | | | |
| 18 | local use 3 (local3) | | | | | | | | | | | | | | | | | | | | | | | | | | | | | | | | | | | | | | | | | | | | | | | | |
| 19 | local use 4 (local4) | | | | | | | | | | | | | | | | | | | | | | | | | | | | | | | | | | | | | | | | | | | | | | | | |
| 20 | local use 5 (local5) | | | | | | | | | | | | | | | | | | | | | | | | | | | | | | | | | | | | | | | | | | | | | | | | |
| 21 | local use 6 (local6) | | | | | | | | | | | | | | | | | | | | | | | | | | | | | | | | | | | | | | | | | | | | | | | | |
| 22 | local use 7 (local7) | | | | | | | | | | | | | | | | | | | | | | | | | | | | | | | | | | | | | | | | | | | | | | | | |
| UDP Port (514 or 6000-65535) | Type the UDP port number used for sending Syslog messages. The default is 514. | | | | | | | | | | | | | | | | | | | | | | | | | | | | | | | | | | | | | | | | | | | | | | | | |
| Status | Choose <i>Enabled</i> or <i>Disabled</i> to activate or deactivate. | | | | | | | | | | | | | | | | | | | | | | | | | | | | | | | | | | | | | | | | | | | | | | | | |

System Log Save Mode Settings

The **System Log Save Mode Settings** window may be used to choose a method for which to save the switch log to the flash memory of the Switch.

To view this window, click **Administration > System Log > System Log Save Mode Settings**, as shown below.

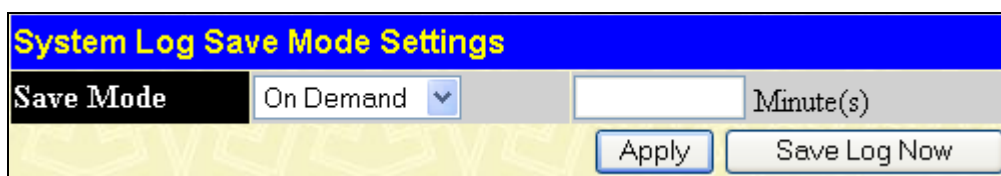

Figure 6- 18. System Log Save Mode Settings window

Use the pull-down menu to choose the method for saving the switch log to the Flash memory. The user has three options:

Time Interval – Users who choose this method can configure a time interval by which the switch will save the log files, in the box adjacent to this configuration field. The user may set a time between 1 and 65535 minutes. The default setting is one minute.

On Demand – Users who choose this method will only save log files when they manually tell the Switch to do so, using the **Save Changes** window.

On Trigger – Users who choose this method will have log files saved to the Switch every time a log event occurs on the Switch.

The default setting is *On Demand*. Click **Apply** to save changes made. Click **Save Log Now** to immediately save log files currently on the switch.

System Severity Settings

The Switch can be configured to allow alerts be logged or sent as a trap to an SNMP agent or both. The level at which the alert triggers either a log entry or a trap message can be set as well. Use the System Severity Settings menu to set the criteria for alerts. The current settings are displayed below the Settings menu.

To view this window, click **Administration > System Severity Settings**, as shown below.

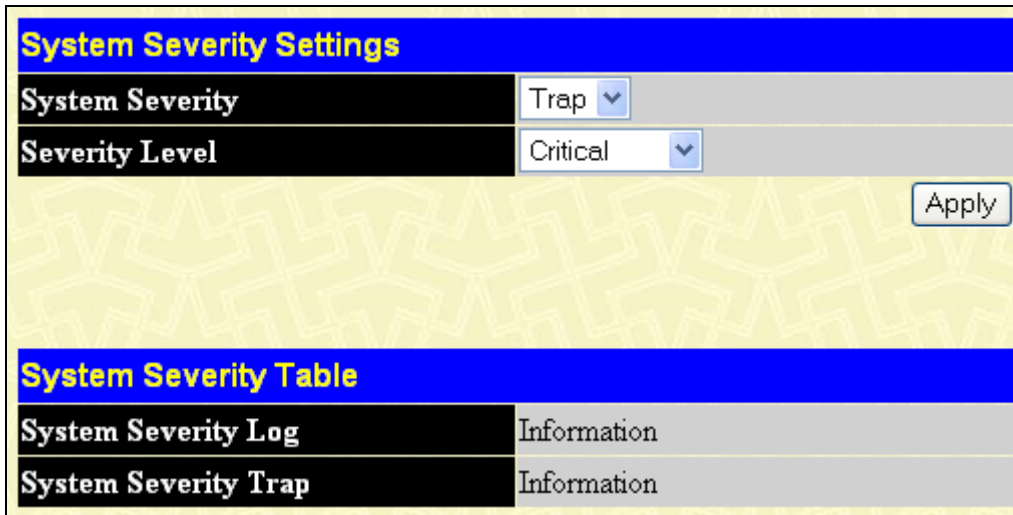

Figure 6- 19. System Severity Settings window

Use the drop-down menus to configure the parameters described below.

| Parameter | Description |
|------------------------|--|
| System Severity | Choose how the alerts are used from the drop-down menu. Select <i>Log</i> to send the alert of the Severity Type configured to the Switch’s log for analysis. Choose <i>Trap</i> to send it to an SNMP agent for analysis. Select <i>All</i> to send the chosen alert type to an SNMP agent and the Switch’s log for analysis. |
| Severity Level | Choose what level of alert will trigger sending the log entry or trap message as defined by the Severity Name. Select <i>Critical</i> to send only critical events to the Switch’s log or SNMP agent. Choose <i>Warning</i> to send critical and warning events to the Switch’s log or SNMP agent. Select <i>Information</i> to send informational, warning and critical events to the Switch’s log or SNMP agent. |

Click **Apply** to implement the new System Severity Settings.

SNTP Settings

Time Settings

This window is used to configure the time settings for the Switch.

To view this window, click **Administration > SNTP Settings > Time Settings**, as shown below.

| Time Settings-Current Time | |
|---|---|
| System Boot Time | 8 Dec 2008 09:18:08 |
| Current Time | 8 Dec 2008 09:31:59 |
| Time Source | System Clock |
| SNTP Settings | |
| SNTP State | Disabled <input type="button" value="v"/> |
| SNTP Primary Server | 0.0.0.0 <input type="text"/> |
| SNTP Secondary Server | 0.0.0.0 <input type="text"/> |
| SNTP Poll Interval in Seconds(30-99999) | 720 <input type="text"/> |
| <input type="button" value="Apply"/> | |
| Time Settings - Set Current Time | |
| Year | 2002 <input type="button" value="v"/> |
| Month | January <input type="button" value="v"/> |
| Day | 01 <input type="button" value="v"/> |
| Time in HH MM SS | 00 <input type="button" value="v"/> 00 <input type="button" value="v"/> 00 <input type="button" value="v"/> |
| <input type="button" value="Apply"/> | |

Figure 6- 20. Time Settings window

The following parameters can be set or are displayed:

| Parameter | Description |
|--|---|
| Current Time | |
| System Boot Time | Displays the time when the Switch was initially started for this session. |
| Current Time | Displays the Current Time set on the Switch. |
| Time Source | Displays the time source for the system. |
| SNTP Settings | |
| SNTP State | Use this pull-down menu to <i>Enabled</i> or <i>Disabled</i> SNTP. |
| SNTP Primary Server | This is the IP address of the primary server the SNTP information will be taken from. |
| SNTP Secondary Server | This is the IP address of the secondary server the SNTP information will be taken from. |
| SNTP Poll Interval in Seconds (30-99999) | This is the interval, in seconds, between requests for updated SNTP information. |
| Set Current Time | |
| Year | Enter the current year, if you would like to update the system clock. |
| Month | Enter the current month, if you would like to update the system clock. |

| | |
|-------------------------|--|
| Day | Enter the current day, if you would like to update the system clock. |
| Time in HH MM SS | Enter the current time in hours, minutes, and seconds. |

Click **Apply** to implement changes made.

Time Zone and DST

The following are windows used to configure time zones and Daylight Savings time settings for SNTP.

To view this window, click **Administration > SNTP Settings > Time Zone and DST**, as shown below.

Time Zone and DST

Daylight Saving Time State: Disabled

Daylight Saving Time Offset in Minutes: 60

Time Zone Offset: From GMT in +/-HH:MM: + 00 00

DST Repeating Settings

From: Which Week: First

From: Day of Week: Sunday

From: Month: April

From: Time in HH MM: 00 00

To: Which Week: Last

To: Day of Week: Sunday

To: Month: October

To: Time in HH MM: 00 00

DST Annual Settings

From: Month: April

From: Day: 29

From: Time in HH MM: 00 00

To: Month: October

To: Day: 12

To: Time in HH MM: 00 00

Apply

Figure 6- 21. Time Zone and DST window

The following parameters can be set:

| Parameter | Description |
|---|--|
| Time Zone and DST | |
| Daylight Saving Time State | Use this pull-down menu to enable or disable the DST Settings. |
| Daylight Saving Time Offset in Minutes | Use this pull-down menu to specify the amount of time that will constitute your local DST offset - 30, 60, 90, or 120 minutes. |
| Time Zone Offset from GMT | Use these pull-down menus to specify your local time zone's offset from Greenwich |

| | |
|--|---|
| in +/- HH:MM | Mean Time (GMT.) |
| DST Repeating Settings | |
| Using repeating mode will enable DST seasonal time adjustment. Repeating mode requires that the DST beginning and ending date be specified using a formula. For example, specify to begin DST on Saturday during the second week of April and end DST on Sunday during the last week of October. | |
| From: Which Week | Enter the week of the month that DST will start on. |
| From: Day of Week | Enter the day of the week that DST will start on. |
| From: Month | Enter the month that DST will start on. |
| From: Time in HH MM | Enter the time of day that DST will start on. |
| To: Which Week | Enter the week of the month the DST will end. |
| To: Day of Week | Enter the day of the week that DST will end. |
| To: Month | Enter the month that DST will end. |
| To: Time in HH MM | Enter the time of day that DST will end. |
| DST Annual Settings | |
| Using annual mode will enable DST seasonal time adjustment. Annual mode requires that the DST beginning and ending date be specified concisely. For example, specify to begin DST on April 3 and end DST on October 14. | |
| From: Month | Enter the month DST will start on, each year. |
| From: Day | Enter the day of the week DST will start on, each year. |
| From: Time in HH MM | Enter the time of day DST will start on, each year. |
| To: Month | Enter the month DST will end on, each year. |
| To: Day | Enter the day of the week DST will end on, each year. |
| To: Time in HH MM | Enter the time of day that DST will end on, each year. |

Click **Apply** to implement changes made to the **Time Zone and DST** window.

MAC Notification Settings

MAC Notification is used to monitor MAC addresses learned and entered into the forwarding database.

To globally set MAC notification on the Switch, click **Administration > MAC Notification Settings**, as shown.

Global Settings

The following parameters may be viewed and modified:

| Parameter | Description |
|------------------------------------|--|
| State | Enable or disable MAC notification globally on the Switch |
| Interval (1-2147483647 sec) | The time in seconds between notifications. |
| History Size (1-500) | The maximum number of entries listed in the history log used for notification. Up to 500 entries can be specified. |

Port Settings

To change MAC notification settings for a port or group of ports on the Switch, configure the following parameters.

| Parameter | Description |
|----------------|---|
| Unit | Select the unit you wish to configure. |
| From/To | Select a port or group of ports to enable for MAC notification using the pull-down menus. |
| State | Enable or disable MAC Notification. |

Click **Apply** to implement changes made.

The screenshot shows the MAC Notification Settings window with three main sections:

- MAC Notification Global Settings:** A table with three rows: State (Disabled), Interval (1-2147483647 sec) (1), and History Size (1-500) (1).
- New MAC Notification Global Settings:** A form with three rows: State (Disabled with a dropdown arrow), Interval (1-2147483647 sec) (1 with a text input), and History Size (1-500) (1 with a text input). An Apply button is at the bottom right.
- MAC Notification Port Settings:** A table with columns: Unit (1 with a dropdown), From (Port 1 with a dropdown), To (Port 1 with a dropdown), State (Disabled with a dropdown), and Apply (Apply button).
- MAC Notification Port State Table-Unit 1:** A table with columns: Port (1-25) and State (Disabled).

Figure 6- 22. MAC Notification Settings window

TFTP Services

Trivial File Transfer Protocol (TFTP) services allow the Switch's firmware to be upgraded by transferring a new firmware file from a TFTP server to the Switch. A configuration file can also be loaded into the Switch from a TFTP server. Switch settings can be saved to the TFTP server, and a history log can be uploaded from the Switch to the TFTP server. The TFTP server must be running TFTP server software to perform the file transfer.

The user also has the option of transferring firmware and configuration files to and from the internal Flash drive, located on the Switch. Using this window, the user can receive a configuration or firmware file from a TFTP server, or transfer that firmware or configuration file to a TFTP server. More about configuring the internal Flash drive can be found in the next section entitled Flash File Services. TFTP server software is a part of many network management software packages – such as NetSight, or can be obtained as a separate program.

To update the Switch's firmware or configuration file, click **Administration > TFTP Services**, as shown below.

Figure 6- 23. TFTP Services window

The following parameters can be configured:

| Parameter | Description |
|------------------------------------|--|
| Operation | <p>Select a service for the TFTP server to perform from the drop down window:</p> <ul style="list-style-type: none"> • <i>Download Firmware</i> - Enter the IP address of the TFTP server and specify the location of the new firmware on the TFTP server. Click Start to record the IP address of the TFTP server and to initiate the file transfer. • <i>Download Configuration</i> - Enter the IP address of the TFTP server, and the path and filename for the Configuration file on the TFTP server. Click Start to record the IP address of the TFTP server and to initiate the file transfer. • <i>Upload Configuration</i> - Enter the IP address of the TFTP server and the path and filename for the switch settings on the TFTP server. Click Start to record the IP address of the TFTP server and to initiate the file transfer. • <i>Upload Log</i> - Enter the IP address of the TFTP server and the path and filename for the history log on the TFTP server. Click Start to record the IP address of the TFTP server and to initiate the file transfer. • <i>Upload Attack Log</i> - Enter the IP address of the TFTP server and the path and filename for the attack log on the TFTP server. Click Start to record the IP address of the TFTP server and to initiate the file transfer. • <i>Upload Firmware</i> - Enter the IP address of the TFTP server and the path and filename for the place to put this firmware on the TFTP server. Click Start to record the IP address of the TFTP server and to initiate the file transfer. |
| Server IPv4 Address | Enter the IPv4 address of the server from which to upload or download firmware and configuration. |
| Server IPv6 Address | Enter the IPv6 address of the server from which to upload or download firmware and configuration. |
| Local File Name | Enter the path and filename of the firmware or configuration file to upload or download, located on the TFTP server. |
| Unit Number | Select the unit you wish to configure, or click the ALL check box to select all available units. |
| Image File in Flash | To select a firmware file from the internal Flash drive to be transferred, or to load a firmware file on to the Flash drive, enter the path and filename here and click the corresponding check box. Remember, the only path that can be used on the flash is named C:\ (ex. C:\runtime.had) |
| Configuration File in Flash | To select a configuration file from the internal Flash drive to be transferred, or to load a configuration file on to the Flash drive, enter the path and filename here and click the corresponding check box. Remember, the only path that can be used on the flash is named C:\ (ex. C:\configuration.had) |

Click **Start** to initiate the file transfer.

File System Services

The Switch contains a 15-megabyte Flash memory where the user may store files for further use on the Switch. The user may place over 200 re-nameable files on the FAT 16 mode Flash memory, of which the user has the option of setting firmware images and configuration files as boot up files, upon the next reboot of the Switch.

The Switch automatically assigns default names to the default boot up files located in the flash memory. The default firmware files are named RUN.HAD while the default boot up configuration file is named STARTUP.CFG. After the system has powered up or has been reset, the Switch will check the Flash memory for these files. If no corruption or other problems exist on the Flash, the Switch will use the files set as the boot up files and load them into the Switch. If a problem occurs, the Switch will use the PROM (programmable read-only memory) will provide the FAT 16 re-building function, which will format the Flash as FAT 16 and enter the Z-modem download mode where the user will download firmware, saved as RUN.HAD and then boot from this firmware image. To configure the files located on the Flash memory, use the following windows to guide you.

System Boot Information

This window is used to view and configure boot up firmware images and configuration files. To set a file as a boot up file, enter the file name and path into the File Name field under the Boot Image Settings heading and click **Apply**. The Switch will recognize .HAD files as firmware images and .CFG files as configuration files when being set as the boot up file. Newly configured boot up files will be displayed in the System Boot Info Table.

To view this table, click **Administration > File System Services > System Boot Information**, as shown below.

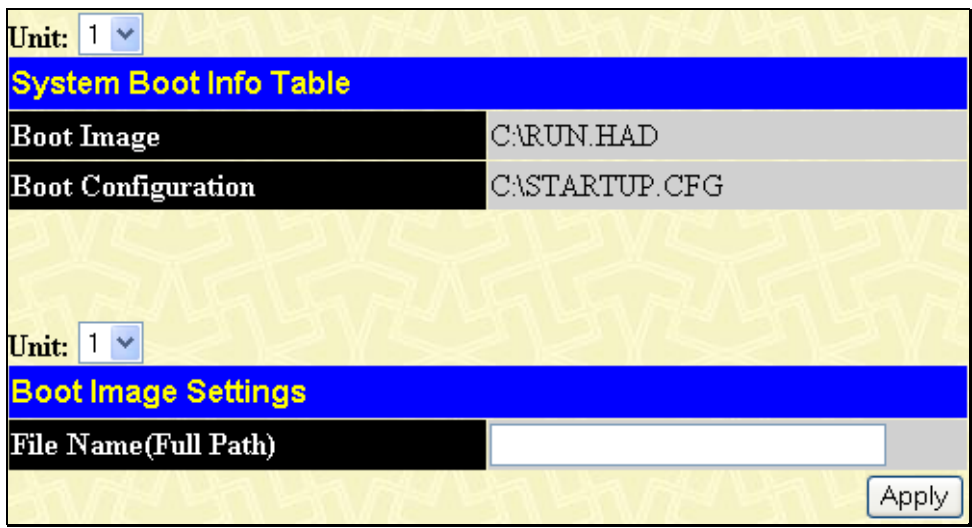

Figure 6- 24. System Boot Info Table window

FS Information

This window allows users to view the settings of the Flash Drive in the Switch. This information is read-only and is just a description of the internal Flash memory.

To view this window, click **Administration > File System Services > FS Information**, as shown below.

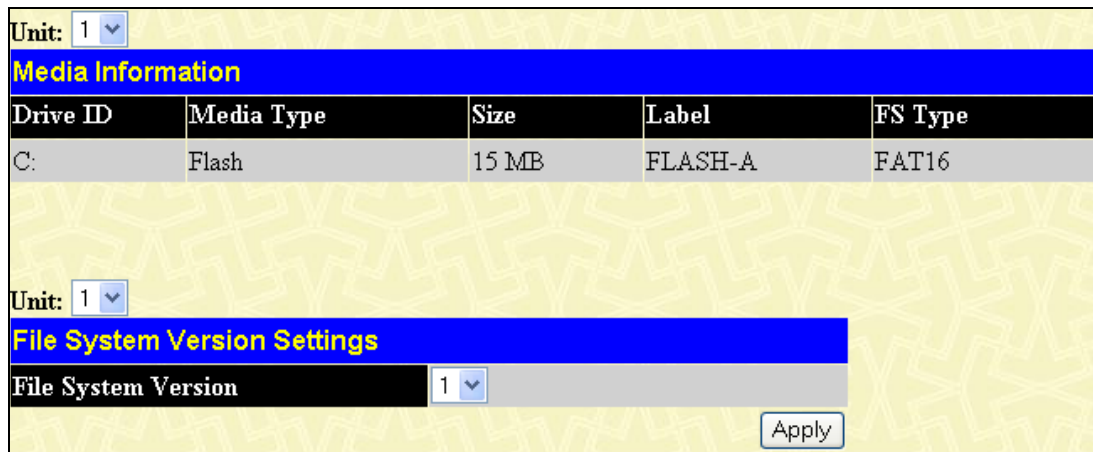

Figure 6- 25. Media Information window

This window offers the following information about the internal Flash Drive.

| Parameter | Description |
|----------------------------|--|
| Drive ID | The name of the drive of the memory. There is only one drive in the Flash and it is named C:. |
| Media Type | The type of storage media present in this Switch, which is a Flash memory system. |
| Size | Denotes the size of the flash memory, which is 15 megabytes. |
| Label | The label that has been factory set for this Flash memory. |
| FS Type | The type of File System present in the Switch. For this release, only a FAT16 file system is used in the Switch. |
| File System Version | Use the drop down menu to select the File System version you wish to use on the Switch. |

Directory

The **Directory** window allows users to view files stored in the flash memory of the Switch. In future releases, more than one drive may be located in the Flash drive, but for this release, the only drive located on the Flash memory of the Switch is C:. Therefore, to view files located on C:, the user should enter C: into the Drive ID field and click **Find**. Saved files will appear in the Directory table. This window will also display the total number of files (Total Files), the amount of free bytes left (Total free size), and the amount of memory space used for normal running of the Switch (System reserved flash size).

To view this window, click **Administration > File System Services > Directory**, as shown below.

Unit: 1 ▾

Directory

Drive ID

Directory Table

| Name | Size | Date | Boot up | Delete |
|-------------|---------------|------------------|---------|----------------------------------|
| LOG.TXT | 851968 bytes | 2008-11-19 10:07 | | <input type="button" value="X"/> |
| RUN.HAD | 3529208 bytes | 2008-11-19 10:02 | * | <input type="button" value="X"/> |
| STARTUP.CFG | 5939 bytes | 2008-12-03 09:50 | * | <input type="button" value="X"/> |

Total Files : 3 file(s)
Total Size : 4387115 bytes
Free Space : 11141120 bytes
'*' means boot up section.

Figure 6- 26. Directory window

The previous window contains the following information:

| Parameter | Description |
|-----------------|---|
| Unit | Use the drop down menu to select the unit you wish to configure. |
| Drive ID | Enter the name of the drive located on the Flash memory. There is only one drive in the Flash and it is named C:\. |
| Name | Denotes the name of the file located on the Switch's Flash memory. The default firmware image is called RUN.HAD, while the default configuration file is specified as STARTUP.CFG. |
| Size | Denotes the size of the save file, in bytes. |
| Date | Displays the date that the file was loaded onto the Switch. |
| Boot up | An '*' in this field denotes that the corresponding file is a boot up configuration file or firmware image. |
| Delete | Click the <input type="button" value="X"/> in this field corresponding to the file to be deleted from the Flash memory. Remember, once deleted, it cannot be restored by the switch unless downloaded again from an outside source. |

Rename

The following window is used to rename files that are presently located in the Flash memory of the Switch. To rename a file, simply type the path and name of the current file (ex. c:/triton) into the Old File Name field, and then the new file and path into the New File Name field and click **Apply**. Remember, the path must be included in both fields, which is c:/ on this Switch. Users may return to the **Directory** window to view changes made in the file names.

To view this window, click **Administration > File System Services > Rename**, as shown below.

Figure 6- 27. Rename window

Copy

This window is used to copy a directory located within the Flash memory of the switch.

To view this window, click **Administration > File System Services > Copy**, as shown below.

Figure 6- 28. Copy File window

This window offers the following fields to aid the user in copying files located in the Flash memory of the Switch.

| Parameter | Description |
|--------------------------------|--|
| Unit | Use the drop down menu to select the unit you wish to configure. |
| Source File (Full Path) | Enter the full path and file name of the directory to be copied. This entry cannot exceed 64 characters in length. |
| Target File (Full Path) | Enter the file name of the directory and the path to place the copy. This entry cannot exceed 64 characters in length. |

Click **Copy** to initiate copying the file.

Ping Test

Ping is a small program that sends ICMP Echo packets to the IP address you specify. The destination node then responds to or "echoes" the packets sent from the Switch. This is very useful to verify connectivity between the Switch and other nodes on the network.

IPv4 Ping Test

The following window is used to Ping an IPv4 address.

To view this window, click **Administration > Ping Test > IPv4 Ping Test**, as shown below.

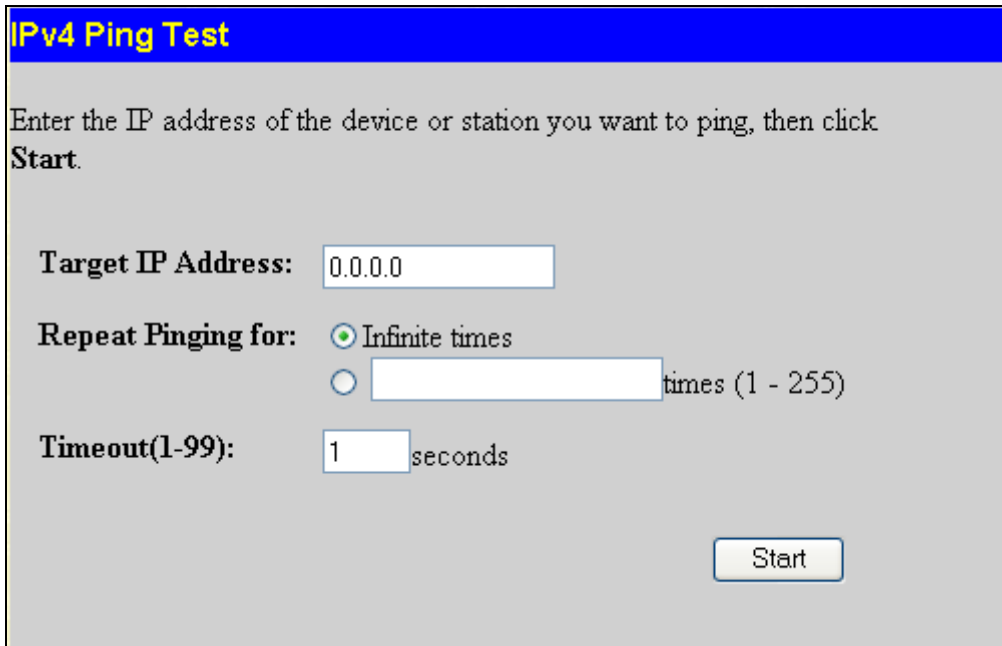

Figure 6- 29. IPv4 Ping Test window

This window allows the following parameters to be configured to ping an IPv4 address.

| Parameter | Description |
|---------------------------|--|
| Target IP Address | Enter an IPv4 address to be pinged. |
| Repeat Pinging for | Either click the Infinite times radio button or enter the number of times desired to attempt to ping the IPv4 address configured in this window. Users may enter a number of times between 1 and 255. |
| Timeout (1-99) | Select a timeout period between 1 and 99 seconds for this Ping message to reach its destination. If the packet fails to find the IPv4 address in this specified time, the Ping packet will be dropped. |

Click **Start** to initialize the Ping program.

IPv6 Ping Test

The following window is used to Ping an IPv6 address.

To view this window, click **Administration > Ping Test > IPv6 Ping Test**, as shown below.

Figure 6- 30. IPv6 Ping Test window

This window allows the following parameters to be configured to ping an IPv6 address.

| Parameter | Description |
|-----------------------------|--|
| IPv6 Address | Enter an IPv6 address to be pinged. |
| Interface | The Interface field is used for addresses on the link-local network. It is recommended that the user enter the specific interface for a link-local IPv6 address. For Global IPv6 addresses, this field may be omitted. |
| Repeat Times (0-255) | Enter the number of times desired to attempt to ping the IPv6 address configured in this window. Users may enter a number of times between 0 and 255. |
| Size (1-6000) | Use this field to set the datagram size of the packet, or in essence, the number of bytes in each ping packet. Users may set a size between 1 and 6000 bytes with a default setting of 100 bytes. |
| Timeout (1-10) | Select a timeout period between 1 and 10 seconds for this Ping message to reach its destination. If the packet fails to find the IPv6 address in this specified time, the Ping packet will be dropped. |

Click **Start** to initialize the Ping program.

IPv6 Neighbor

IPv6 neighbors are devices on the link-local network that have been detected as being IPv6 devices. These devices can forward packets and keep track of the reachability of routers, as well as if changes occur within link-layer addresses of nodes on the network or if identical unicast addresses are present on the local link. The following two windows are used to view IPv6 neighbors, and add or delete them from the Neighbor cache.

IPv6 Neighbor Settings

The following window is used to view and configure current IPv6 neighbors of the Switch.

To view this window, click **Administration > IPv6 Neighbor > IPv6 Neighbor Settings**, as shown below.

| Neighbor | Link Layer Address | Interface | State | Delete |
|--------------------------|--------------------|-----------|-------|--------|
| FE80::203:93FF:FEDA:5CBA | 00-03-93-DA-5C-BA | System | Stale | ✕ |
| FE80::20E:A6FF:FE01:D5BC | 00-0E-A6-01-D5-BC | System | Stale | ✕ |
| FE80::250:BAFF:FE00:59E | 00-50-BA-00-05-9E | System | Stale | ✕ |
| FE80::2D0:BAFF:FEF4:3282 | 00-D0-BA-F4-32-82 | System | Stale | ✕ |

Total Entries: 4

Figure 6- 31. IPv6 Neighbor Settings window

The following fields can be viewed or configured:

| Parameter | Description |
|------------------------------|--|
| Interface Name | Enter the Interface Name of the device for which to search IPv6 neighbors. Click Find to begin the search. |
| Neighbor IPv6 Address | Enter the IPv6 address of the neighbor of the IPv6 device to be searched. Click Find to begin the search. |
| State | Users may also search by running state of the IPv6 neighbor. Tick the State check box and choose to search for Static IPv6 neighbors or Dynamic IPv6 neighbors. Click Find to begin the search. |
| Neighbor | Displays the IPv6 address of the neighbor device. |
| Link Layer Address | Displays the MAC Address of the corresponding IPv6 device. |
| Interface | Displays the Interface name associated with this IPv6 address. |
| State | Displays the running state of the corresponding IPv6 neighbor. The user may see six possible entries in this field, which are Incomplete, Stale, Probe, Reachable, Delay or Static. |

To remove an entry, click the corresponding Delete icon. To completely clear the IPv6 Neighbor Settings, click the **Clear All** button. To add a new entry, click the **Add** button, revealing the following window to configure:

Figure 6- 32. IPv6 Neighbor Settings – Add window

The following fields can be set or viewed:

| Parameter | Description |
|------------------------|---|
| Interface Name | Enter the name of the Interface associated with this entry, if any. |
| Neighbor IPv6 Address | The IPv6 address of the neighbor entry. Specify the address using the hexadecimal IPv6 Address (IPv6 Address is hexadecimal number, for example 1234::5D7F/32). |
| Link Layer MAC Address | The MAC address of the IPv6 neighbor entry. |

After entering the IPv6 Address and MAC Address of the Static IPv6 Neighbor entry, click **Apply** to implement the new entry. To return to the **IPv6 Neighbor Settings** window, click the [Show All IPv6 Neighbor Entries](#) link.

DHCP Auto Configuration Settings

This window is used to enable the DHCP Autoconfiguration feature on the Switch. When enabled, the Switch is instructed to receive a configuration file from a TFTP server, which will set the Switch to become a DHCP client automatically on boot up. To employ this method, the DHCP server must be set up to deliver the TFTP server IP address and configuration file name information in the DHCP reply packet. The TFTP server must be up and running and hold the necessary configuration file stored in its base directory when the request is received from the Switch. For more information about loading a configuration file for use by a client, see the DHCP server and/or TFTP server software instructions. The user may also consult the Upload screen description located in the Maintenance section of this manual.

If the Switch is unable to complete the DHCP auto configuration, the previously saved configuration file present in the Switch’s memory will be used.

To view this window, click **Administration > DHCP Auto Configuration Settings**, as shown below.

Figure 6- 33. DHCP Auto Configuration Settings window

To enable the **DHCP Auto Configuration State**, use the pull-down menu to choose Enabled and click the **Apply** button.

BPDU Tunneling Settings

The BPDU (Bridge Protocol Data Unit) Tunneling function supports traffic of multiple customers across service provider networks. BPDU Tunneling enables the BPDU’s of the same customer’s network to be multicast over specific VLANs in the service provider’s network, which in turn will ensure the same geographically dispersed customer network can implement consistent spanning tree calculations across the service provider network.

To view this window, click **Administration > BPDU Tunneling Settings**, as shown below.

Figure 6- 34. BPDU Tunneling Settings window

The following fields can be configured:

| Parameter | Description |
|-----------------------------|---|
| BPDU Tunneling State | Use the drop down menu to <i>Enable</i> or <i>Disable</i> the BPDU state. |
| Unit | Select the unit you wish to configure. |
| From....To | Specify the ports on which the BPDU Tunneling will be enabled or disabled. |
| Type | Use the drop down menu to select the configuration type. <i>Tunnel</i> – Specifies that the BPDU is received from a tunnel port, this packets DA will be replaced by a reserved multicast address and then sent out to a providers network through the uplink port. <i>Uplink</i> – Specifies that the port is a normal switch port which connects to the network provider. The encapsulated PDU received on the uplink port shall be terminated and the DA is replaced with the STP/GVRP MAC address, the packet is then sent to the tunnel port in the same VLAN. <i>None</i> – When selected an encapsulated PDU is received on a port and the forwarding behavior follows the forwarding of general multicast addresses. <i>None</i> is the default. |
| STP/GVRP | Select the type of tunnel multicast address to be applied to the ports either <i>STP</i> or <i>GVRP</i> . An STP enabled port can not be configured as an STP tunnel port. A GVRP enabled port can not be configured as a GVRP tunnel port. |

Click **Apply** to implement changes made.

RSPAN

RSPAN (Remote Switched Port Analyzer) is a feature used to monitor and analyze the traffic passing through ports. The character ‘R’ is short for ‘Remote’ which means that the mirror source ports and the destination port are not on the same Switch. So a remote mirror session consists of at least two switches. To achieve the remote mirroring function, the mirrored traffic is tagged with a reserved VLAN which is called an RSPAN VLAN, the RSPAN VLAN is reserved in such a way that traffic tagged with RSPAN will be mirrored toward the associated destination port.

There are three roles for switches in RSPAN.

Source switch – The switch which has the monitored ports or VLANs on it is the source switch. All packets on the source ports or VLANs are copied and sent to the destination switch. When the mirrored packets are sent out from the source switch, an RSPAN VLAN tag is added to every packet. The incoming port on the source switch for the mirrored packets is referred to as the **source port**.

Intermediate switch The function of the intermediate switch is to mirror traffic flowing in the RSPAN VLAN toward the RSAPN destination. A switch can be have the role of an RSAPN VLAN intermediate switch as well as the role of source switch for another RSPAN VLAN.

Destination Switch The port which is directly connected to a network analyzer, other monitoring, or security device is called the **destination port**. The switch which has a destination port is called the **destination switch**. The destination switch removes the RSPAN VLAN tags from the mirrored packets when the destination port is an untagged port in the RSPAN VLAN. If the destination port is a tagged port, the tags will be reserved.

RSPAN State Settings

This window allows the user to enable or disable the RSPAN settings on the Switch. The purpose of the RSPAN function is to mirror the packets to the remote switch. The packet travels from the switch where the monitored packet is received, through the intermediate switch, then to the switch where the sniffer is attached. The first switch is also named the source switch.

To view this window, click **Administration > RSPAN > RSPAN State Settings**, as shown below.



Figure 6- 35. RSPAN State Settings window

Use the drop down menu to *Enable* or *Disable* the **RSPAN State** on the Switch and click **Apply** to implement the changes made.

RSPAN Settings

This window allows the user to search for a previously created VLAN and to view the RSPAN settings for it.

To view this window, click **Administration > RSPAN > RSPAN Settings**, as shown below.

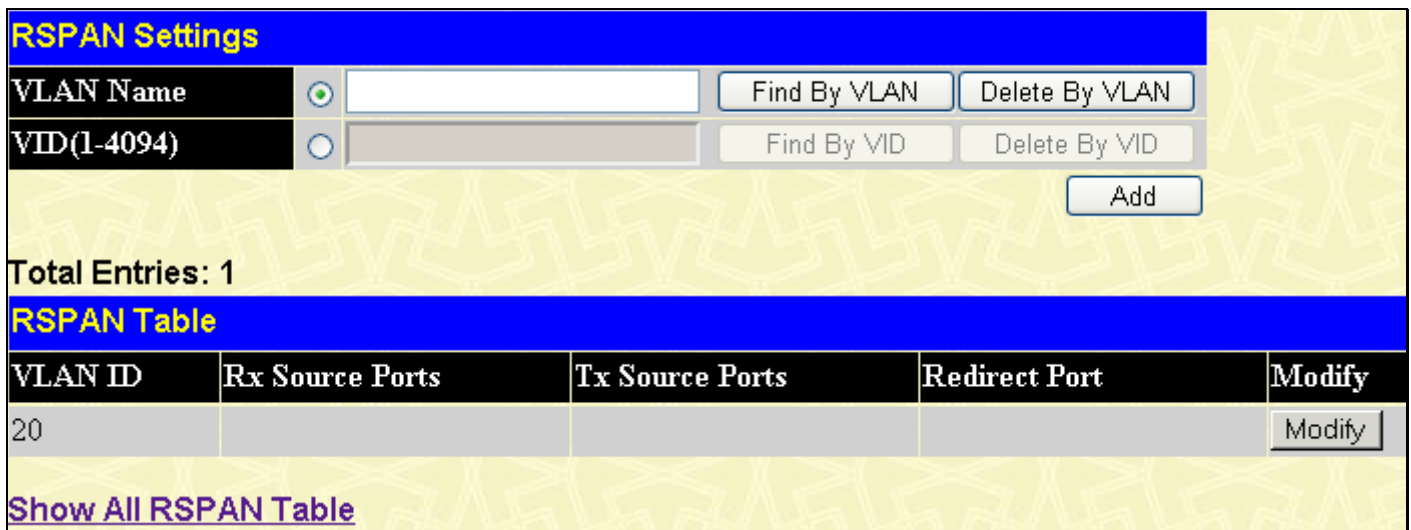

Figure 6- 36. RSPAN Settings window

The following fields can be configured:

| Parameter | Description |
|-----------|--|
| VLAN Name | Enter the name of the VLAN you wish to Add, Find or Delete. |

| | |
|------------------------|---|
| VID (1-4094) | Enter the VLAN ID of the VLAN you wish to Add Find or Delete. |
| Rx Source Ports | The goal of Rx source ports is to monitor as much as possible all the packets received by the source interface or VLAN before any modification or processing is performed by the switch. A copy of each packet received by the source is sent to the destination port for that RSPAN session. |
| Tx Source Ports | The goal of Tx source ports is to monitor as much as possible all the packets sent by the source interface after all modification and processing is performed by the switch. |
| Redirect Port | RSPAN redirect function will work when RSPAN is enabled and at least one RSPAN VLAN has been configured with redirect ports. |
| Modify | Click on the corresponding Modify button to edit the entries. |

To remove an entry, click the corresponding **Delete by VLAN** icon. To search for an entry enter the appropriate information and click the **Find by VLAN** button. To modify an existing entry, click the corresponding **Modify** button, revealing the following window to configure:

Figure 6- 37. RSPAN Settings – Edit window

The following fields can be configured:

| Parameter | Description |
|-----------------------------|---|
| VLAN Name | This is the VLAN Name that, along with the VLAN ID, identifies the VLAN which will modify the RSPAN Entries. |
| VID (1-4094) | This is the VLAN ID that, along with the VLAN Name, identifies the VLAN which will to modify the RSPAN Entries. |
| Source Ports Action | Use the drop down menu to select the configuration Source Ports Action. <i>None</i> –neither configure Rx Source Port nor Tx Source Port. |
| Rx Source Ports | The goal of Rx source ports is to monitor as much as possible all the packets received by the source interface or VLAN before any modification or processing is performed by the switch. A copy of each packet received by the source is sent to the destination port for that RSPAN session. |
| Tx Source Ports | The goal of Tx source ports is to monitor as much as possible all the packets sent by the source interface after all modification and processing is performed by the switch. |
| Redirect Port Action | Use the drop down menu to select the configuration Redirect Ports Action. Add – Add Redirect ports. Delete – Delete Redirect ports. |
| Redirect Port | RSPAN redirect function will work when RSPAN is enabled and at least one RSPAN VLAN has been configured with redirect ports. |

SNMP Manager

SNMP Settings

Simple Network Management Protocol (SNMP) is an OSI Layer 7 (Application Layer) designed specifically for managing and monitoring network devices. SNMP enables network management stations to read and modify the settings of gateways, routers, switches, and other network devices. Use SNMP to configure system features for proper operation, monitor performance and detect potential problems in the Switch, switch group or network.

Managed devices that support SNMP include software (referred to as an agent), which runs locally on the device. A defined set of variables (managed objects) is maintained by the SNMP agent and used to manage the device. These objects are defined in a Management Information Base (MIB), which provides a standard presentation of the information controlled by the on-board SNMP agent. SNMP defines both the format of the MIB specifications and the protocol used to access this information over the network.

The Switch supports the SNMP versions 1, 2c, and 3. The default SNMP setting is disabled. You must enable SNMP. Once SNMP is enabled you can choose which version you want to use to monitor and control the Switch. The three versions of SNMP vary in the level of security provided between the management station and the network device.

In SNMP v.1 and v.2, user authentication is accomplished using 'community strings', which function like passwords. The remote user SNMP application and the Switch SNMP must use the same community string. SNMP packets from any station that has not been authenticated are ignored (dropped).

The default community strings for the Switch used for SNMP v.1 and v.2 management access are:

- **public** - Allows authorized management stations to retrieve MIB objects.
- **private** - Allows authorized management stations to retrieve and modify MIB objects.

SNMPv3 uses a more sophisticated authentication process that is separated into two parts. The first part is to maintain a list of users and their attributes that are allowed to act as SNMP managers. The second part describes what each user on that list can do as an SNMP manager.

The Switch allows groups of users to be listed and configured with a shared set of privileges. The SNMP version may also be set for a listed group of SNMP managers. Thus, you may create a group of SNMP managers that are allowed to view read-only information or receive traps using SNMPv1 while assigning a higher level of security to another group, granting read/write privileges using SNMPv3.

Using SNMPv3 individual users or groups of SNMP managers can be allowed to perform or be restricted from performing specific SNMP management functions. The functions allowed or restricted are defined using the Object Identifier (OID) associated with a specific MIB. An additional layer of security is available for SNMPv3 in that SNMP messages may be encrypted. To read more about how to configure SNMPv3 settings for the Switch read the next section.

Traps

Traps are messages that alert network personnel of events that occur on the Switch. The events can be as serious as a reboot (someone accidentally turned OFF the Switch), or less serious like a port status change. The Switch generates traps and sends them to the trap recipient (or network manager). Typical traps include trap messages for Authentication Failure, Topology Change and Broadcast/Multicast Storm.

MIBs

The Switch in the Management Information Base (MIB) stores management and counter information. The Switch uses the standard MIB-II Management Information Base module. Consequently, values for MIB objects can be retrieved from any SNMP-based network management software. In addition to the standard MIB-II, the Switch also supports its own proprietary enterprise MIB as an extended Management Information Base. Specifying the MIB Object Identifier may also retrieve the proprietary MIB. MIB values can be either read-only or read-write.

The Switch incorporates a flexible SNMP management for the switching environment. SNMP management can be customized to suit the needs of the networks and the preferences of the network administrator. Use the SNMP V3 menus to select the SNMP version used for specific tasks.

The Switch supports the Simple Network Management Protocol (SNMP) versions 1, 2c, and 3. The administrator can specify the SNMP version used to monitor and control the Switch. The three versions of SNMP vary in the level of security provided between the management station and the network device.

SNMP settings are configured using the menus located on the SNMP V3 folder of the web manager. Workstations on the network that are allowed SNMP privileged access to the Switch can be restricted with the Management Station IP Address menu.

SNMP Trap Settings

The following window is used to enable and disable trap settings for the SNMP function on the Switch.

To view this window for configuration, click **Administration > SNMP Manager > SNMP Trap Settings**, as shown below.

SNMP Traps Settings

| | |
|--------------------------------|-----------|
| Traps State | Enabled ▾ |
| Authenticate Trap State | Enabled ▾ |
| Linkchange Trap State | Enabled ▾ |

Linkchange Trap Settings

| Unit | From | To | State | Apply |
|------|----------|----------|-----------|--------------------------------------|
| 1 ▾ | Port 1 ▾ | Port 1 ▾ | Enabled ▾ | <input type="button" value="Apply"/> |

Linkchange Trap Table

| Port | State |
|------|---------|
| 1 | Enabled |
| 2 | Enabled |
| 3 | Enabled |
| 4 | Enabled |
| 5 | Enabled |
| 6 | Enabled |
| 7 | Enabled |
| 8 | Enabled |
| 9 | Enabled |
| 10 | Enabled |
| 11 | Enabled |
| 12 | Enabled |
| 13 | Enabled |
| 14 | Enabled |
| 15 | Enabled |
| 16 | Enabled |
| 17 | Enabled |
| 18 | Enabled |
| 19 | Enabled |
| 20 | Enabled |
| 21 | Enabled |
| 22 | Enabled |
| 23 | Enabled |
| 24 | Enabled |
| 25 | Enabled |

Figure 6- 38. SNMP Trap Settings window

To enable or disable the Traps State, Authenticate Trap State, and/or Linkchange Trap State use the corresponding pull-down menu to change and click **Apply**.

To enable or disable linkchange trap settings for individual ports, select the ports using the From and To drop-down menus, enable State using the drop-down menu, and then click **Apply**.

SNMP User Table

This window displays all of the SNMP users currently configured on the Switch.

To view this window, click **Administration > SNMP Manager > SNMP User Table**, as shown below.

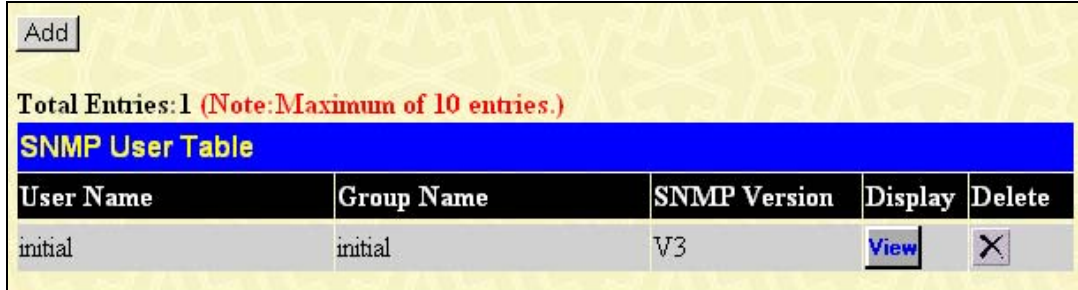



Figure 6- 39. SNMP User Table window

To delete an existing **SNMP User Table** entry, click the  below the Delete heading corresponding to the entry you wish to delete.

To display the detailed entry for a given user, click the **View** button under the Display heading. This will open the **SNMP User Table Display** window, as shown below.

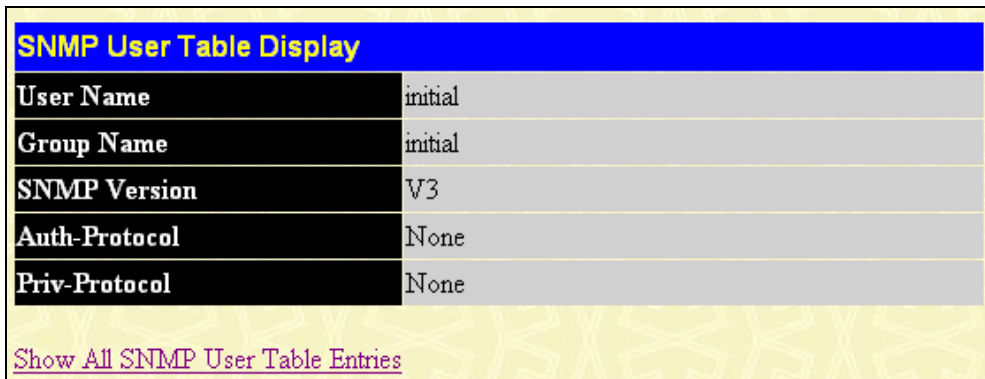

Figure 6- 40. SNMP User Table Display window

The following parameters are displayed:

| Parameter | Description |
|----------------------|--|
| User Name | An alphanumeric string of up to 32 characters. This is used to identify the SNMP users. |
| Group Name | This name is used to specify the SNMP group created can request SNMP messages. |
| SNMP Version | V3 - Indicates that SNMP version 3 is in use. |
| Auth-Protocol | <i>None</i> - Indicates that no authentication protocol is in use. <i>MD5</i> - Indicates that the HMAC-MD5-96 authentication level will be used. <i>SHA</i> - Indicates that the HMAC-SHA authentication protocol will be used. |
| Priv-Protocol | <i>None</i> - Indicates that no privacy (encryption) protocol is in use. <i>DES</i> - Indicates that DES 56-bit encryption is in use based on the CBC-DES (DES-56) standard. |

To return to the SNMP User Table, click the [Show All SNMP User Table Entries](#) link. To add a new entry to the SNMP User Table, click the **Add** button on the **SNMP User Table** window. This will open the **SNMP User Table Configuration** window, as shown below.

The image shows a configuration window titled "SNMP User Table Configuration". It contains several input fields and dropdown menus:

- User Name:** A text input field.
- Group Name:** A text input field.
- SNMP Version:** A dropdown menu with "V3" selected.
- SNMP V3 Encryption:** A dropdown menu with "None" selected.
- Auth-Protocol by Password:** A dropdown menu with "MD5" selected, followed by a "Password" label and a text input field.
- Priv-Protocol by Password:** A dropdown menu with "None" selected, followed by a "Password" label and a text input field.
- Auth-Protocol by Key:** A dropdown menu with "MD5" selected, followed by a "Key" label and a text input field.
- Priv-Protocol by key:** A dropdown menu with "None" selected, followed by a "Key" label and a text input field.

At the bottom right, there is an "Apply" button. At the bottom left, there is a link that says "Show All SNMP User Table Entries".

Figure 6- 41. SNMP User Table Configuration window

The following parameters can set:

| Parameter | Description |
|--|--|
| User Name | Enter an alphanumeric string of up to 32 characters. This is used to identify the SNMP user. |
| Group Name | This name is used to specify the SNMP group created can request SNMP messages. |
| SNMP Version | V3 - Specifies that SNMP version 3 will be used. |
| SNMP V3 Encryption | SNMP v3 provides secure access to devices through a combination of authentication and encrypting packets over the network. Use the drop down menu to select the type of SNMP V3 encryption to be applied. The user can choose between <i>None</i> , <i>Password</i> or <i>Key</i> . |
| Auth-Protocol Password / Key by | <p><i>MD5</i> - Specifies that the HMAC-MD5-96 authentication level will be used. This is only operable when V3 is selected in the SNMP Version field and the Encrypted check box has been ticked. This field will require the user to enter a password.</p> <p><i>SHA</i> - Specifies that the HMAC-SHA authentication protocol will be used. This is only operable when V3 is selected in the SNMP Version field and the Encrypted check box has been ticked. This field will require the user to enter a password between 8 and 16 alphanumeric characters.</p> |
| Priv-Protocol Password / Key by | <p><i>None</i> - Specifies that no privacy (encryption) protocol is in use.</p> <p><i>DES</i> - Specifies that DES 56-bit encryption is in use, based on the CBC-DES (DES-56) standard. This field is only operable when V3 is selected in the SNMP Version field and the Encrypted check box has been ticked. This field will require the user to enter a password between 8 and 16 alphanumeric characters.</p> |

To implement changes made, click **Apply**. To return to the SNMP User Table, click the [Show All SNMP User Table Entries](#) link.

SNMP View Table

This window is used to assign views to community strings that define which MIB objects can be accessed by a remote SNMP manager.

To view this window, click **Administration > SNMP Manager > SNMP View Table**, as shown below.

| SNMP View Table | | | |
|-----------------|--------------------|-----------|--------|
| View Name | Subtree | View Type | Delete |
| restricted | 1.3.6.1.2.1.1 | Included | X |
| restricted | 1.3.6.1.2.1.11 | Included | X |
| restricted | 1.3.6.1.6.3.10.2.1 | Included | X |
| restricted | 1.3.6.1.6.3.11.2.1 | Included | X |
| restricted | 1.3.6.1.6.3.15.1.1 | Included | X |
| CommunityView | 1 | Included | X |
| CommunityView | 1.3.6.1.6.3 | Excluded | X |
| CommunityView | 1.3.6.1.6.3.1 | Included | X |

Figure 6- 42. SNMP View Table window

To delete an existing SNMP View Table entry, click the corresponding button in the Delete column. To create a new entry, click the **Add** button which will reveal a new window.

| SNMP View Table Configuration | |
|--|---|
| View Name | <input type="text"/> |
| Subtree OID | <input type="text"/> |
| View Type | Included <input type="button" value="v"/> |
| <input type="button" value="Apply"/> | |
| Show All SNMP View Table Entries | |

Figure 6- 43. SNMP View Table Configuration window

The SNMP View created with this table maps SNMP users (identified in the SNMP User Table) to the views created in the previous window.

The following parameters can set:

| Parameter | Description |
|--------------------|--|
| View Name | Type an alphanumeric string of up to 32 characters. This is used to identify the new SNMP view being created. |
| Subtree OID | Type the Object Identifier (OID) Subtree for the view. The OID identifies an object tree (MIB tree) that will be included or excluded from access by an SNMP manager. |
| View Type | Select <i>Included</i> to ensure this object is included in the list of objects that an SNMP manager can access. Select <i>Excluded</i> to exclude this object from the list of objects that an SNMP manager can access. |

To implement your new settings, click **Apply**. To return to the **SNMP View Table** window, click the [Show All SNMP View Table Entries](#) link.

SNMP Group Table

An SNMP Group created with this table maps SNMP users (identified in the SNMP User Table) to the views created in the previous menu.

To view the **SNMP Group Table** window, click **Administration > SNMP Manager > SNMP Group Table**, as shown below.

| Add | | | | |
|---|----------------|----------------|----------------------|--------------------------|
| Total Entries:9 (Note:Maximum of 30 entries.) | | | | |
| SNMP Group Table | | | | |
| Group Name | Security Model | Security Level | Display | Delete |
| public | SNMPv1 | NoAuthNoPriv | View | <input type="checkbox"/> |
| public | SNMPv2 | NoAuthNoPriv | View | <input type="checkbox"/> |
| initial | SNMPv3 | NoAuthNoPriv | View | <input type="checkbox"/> |
| private | SNMPv1 | NoAuthNoPriv | View | <input type="checkbox"/> |
| private | SNMPv2 | NoAuthNoPriv | View | <input type="checkbox"/> |
| ReadGroup | SNMPv1 | NoAuthNoPriv | View | <input type="checkbox"/> |
| ReadGroup | SNMPv2 | NoAuthNoPriv | View | <input type="checkbox"/> |
| WriteGroup | SNMPv1 | NoAuthNoPriv | View | <input type="checkbox"/> |
| WriteGroup | SNMPv2 | NoAuthNoPriv | View | <input type="checkbox"/> |

Figure 6- 44. SNMP Group Table window

To delete an existing SNMP Group Table entry, click the corresponding under the Delete heading.

To display the current settings for an existing **SNMP Group Table** entry, click the **View** button located under the Display heading, which will show the following window.

| SNMP Group Table Display | |
|---|---------------|
| Group Name | public |
| Read View Name | CommunityView |
| Write View Name | |
| Notify View Name | CommunityView |
| Security Model | SNMPv1 |
| Security Level | NoAuthNoPriv |
| Show All SNMP Group Table Entries | |

Figure 6- 45. SNMP Group Table Display window

To add a new entry to the Switch's SNMP Group Table, click the **Add** button in the upper left-hand corner of the **SNMP Group Table** window. This will open the **SNMP Group Table Configuration** window, as shown below.

The image shows a configuration window titled "SNMP Group Table Configuration". It contains several input fields and dropdown menus. The fields are: Group Name, Read View Name, Write View Name, and Notify View Name, all of which are empty text boxes. The Security Model dropdown is set to "SNMPv1" and the Security Level dropdown is set to "NoAuthNoPriv". There is an "Apply" button on the right side of the form. Below the form, there is a link that says "Show All SNMP Group Table Entries".

Figure 6- 46. SNMP Group Table Configuration window

The following parameters can set:

| Parameter | Description |
|-------------------------|--|
| Group Name | Type an alphanumeric string of up to 32 characters. This is used to identify the new SNMP group of SNMP users. |
| Read View Name | This name is used to specify the SNMP group created can request SNMP messages. |
| Write View Name | Specify a SNMP group name for users that are allowed SNMP write privileges to the Switch's SNMP agent. |
| Notify View Name | Specify a SNMP group name for users that can receive SNMP trap messages generated by the Switch's SNMP agent. |
| Security Model | <p><i>SNMPv1</i> - Specifies that SNMP version 1 will be used.</p> <p><i>SNMPv2</i> - Specifies that SNMP version 2c will be used. The SNMPv2 supports both centralized and distributed network management strategies. It includes improvements in the Structure of Management Information (SMI) and adds some security features.</p> <p><i>SNMPv3</i> - Specifies that the SNMP version 3 will be used. SNMPv3 provides secure access to devices through a combination of authentication and encrypting packets over the network.</p> |
| Security Level | <p>The Security Level settings only apply to SNMPv3.</p> <p><i>NoAuthNoPriv</i> - Specifies that there will be no authorization and no encryption of packets sent between the Switch and a remote SNMP manager.</p> <p><i>AuthNoPriv</i> - Specifies that authorization will be required, but there will be no encryption of packets sent between the Switch and a remote SNMP manager.</p> <p><i>AuthPriv</i> - Specifies that authorization will be required, and that packets sent between the Switch and a remote SNMP manger will be encrypted.</p> |

To implement your new settings, click **Apply**. To return to the SNMP Group Table, click the [Show All SNMP Group Table Entries](#) link.

SNMP Community Table

Use this table to create an SNMP community string to define the relationship between the SNMP manager and an agent. The community string acts like a password to permit access to the agent on the Switch. One or more of the following characteristics can be associated with the community string:

- An Access List of IP addresses of SNMP managers that are permitted to use the community string to gain access to the Switch's SNMP agent.
- Any MIB view that defines the subset of all MIB objects will be accessible to the SNMP community.
- Read/write or read-only level permission for the MIB objects accessible to the SNMP community.

To view this window, click **Administration > SNMP Manager > SNMP Community Table**, as shown below.

| SNMP Community Table | | | |
|--|----------------------|--|----------------------------------|
| Community Name | View Name | Access Right | |
| <input type="text"/> | <input type="text"/> | Read Only <input type="button" value="v"/> | |
| <input type="button" value="Apply"/> | | | |
| Total Entries: 2 (Note: Maximum of 10 entries.) | | | |
| SNMP Community Table | | | |
| Community Name | View Name | Access Right | Delete |
| private | CommunityView | Read Write | <input type="button" value="X"/> |
| public | CommunityView | Read Only | <input type="button" value="X"/> |

Figure 6- 47. SNMP Community Table window

The following parameters can set:

| Parameter | Description |
|-----------------------|---|
| Community Name | Type an alphanumeric string of up to 32 characters that is used to identify members of an SNMP community. This string is used like a password to give remote SNMP managers access to MIB objects in the Switch's SNMP agent. |
| View Name | Type an alphanumeric string of up to 32 characters that is used to identify the group of MIB objects that a remote SNMP manager is allowed to access on the Switch. The view name must exist in the SNMP View Table. |
| Access Right | <i>Read Only</i> - Specifies that SNMP community members using the community string created can only read the contents of the MIBs on the Switch. <i>Read Write</i> - Specifies that SNMP community members using the community string created can read from, and write to the contents of the MIBs on the Switch. |

To implement the new settings, click **Apply**. To delete an entry from the SNMP Community Table, click the corresponding button under the Delete heading.

SNMP Host Table

Use this window to set up SNMP trap recipients. To delete an existing SNMP Host Table entry, click the corresponding button under the Delete heading.

To view this window, click **Administration > SNMP Manager > SNMP Host Table**, as shown below.

| <input type="button" value="Add IPv4 Host"/> | <input type="button" value="Add IPv6 Host"/> | | |
|--|--|---------------------------------|--------|
| Total Entries: 0 (Note: Maximum of 10 entries.) | | | |
| SNMP Host Table | | | |
| Host IP Address | SNMP Version | Community Name/SNMPv3 User Name | Delete |

Figure 6- 48. SNMP Host Table window

Users now have the choice of adding an IPv4 or an IPv6 host to the SNMP host table. To add a new IPv4 entry to the Switch's SNMP Host Table, click the **Add IPv4 Host** button in the upper left-hand corner of the window. This will open the **SNMP Host Table Configuration** window, as shown below.

Figure 6- 49. SNMP Host Table Configuration window for IPv4

The following parameters can set:

| Parameter | Description |
|--|---|
| Host IPv4 Address | Type the IPv4 address of the remote management station that will serve as the SNMP host for the Switch. |
| SNMP Version | <p>V1 - This specifies that SNMP version 1 will be used.</p> <p>V2 - To specify that SNMP version 2 will be used.</p> <p>V3-NoAuth-NoPriv - To specify that the SNMP version 3 will be used, with a NoAuth-NoPriv security level.</p> <p>V3-Auth-NoPriv - To specify that the SNMP version 3 will be used, with an Auth-NoPriv security level.</p> <p>V3-Auth-Priv - To specify that the SNMP version 3 will be used, with an Auth-Priv security level.</p> |
| Community String or SNMP V3 User Name | Type in the community string or SNMP V3 user name as appropriate. |

To add a new IPv6 entry to the Switch's SNMP Host Table, click the **Add IPv6 Host** button in the upper left-hand corner of the window. This will open the **SNMP Host Table Configuration** window, as shown below.

Figure 6- 50. SNMP Host Table Configuration window for IPv6

The following parameters can set:

| Parameter | Description |
|--------------------------|--|
| Host IPv6 Address | Type the IPv6 address of the remote management station that will serve as the SNMP host for the Switch. |
| SNMP Version | <p>V1 - To specifies that SNMP version 1 will be used.</p> <p>V2 - To specify that SNMP version 2 will be used.</p> <p>V3-NoAuth-NoPriv - To specify that the SNMP version 3 will be used, with a NoAuth-NoPriv security level.</p> <p>V3-Auth-NoPriv - To specify that the SNMP version 3 will be used, with an Auth-NoPriv security level.</p> <p>V3-Auth-Priv - To specify that the SNMP version 3 will be used, with an Auth-Priv security</p> |

| | |
|--|---|
| | level. |
| Community String or SNMP V3 User Name | Type in the community string or SNMP V3 user name as appropriate. |

To implement your new settings, click **Apply**. To return to the **SNMP Host Table** window, click the [Show All SNMP Host Table Entries](#) link.

SNMP Engine ID

The Engine ID is a unique identifier used for SNMP V3 implementations. This is an alphanumeric string used to identify the SNMP engine on the Switch.

To display the Switch's SNMP Engine ID, click **Administration > SNMP Manager > SNMP Engine ID**, as shown.

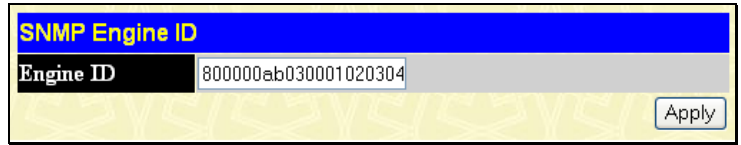

Figure 6- 51. SNMP Engine ID window

To change the Engine ID, enter the new Engine ID in the space provided and click the **Apply** button.

sFlow

sFlow is a feature on the Switch that allows users to monitor network traffic running through the switch to identify network problems through packet sampling and packet counter information of the Switch. The Switch itself is the sFlow agent where packet data is retrieved and sent to an sFlow Analyzer where it can be scrutinized and utilized to resolve the problem.

The Switch can configure the settings for the sFlow Analyzer but the remote sFlow Analyzer device must have an sFlow utility running on it to retrieve and analyze the data it receives from the sFlow agent.

The Switch itself will collect three types of packet data:

1. It will take sample packets from the normal running traffic of the Switch based on a sampling interval configured by the user.
2. The Switch will take a poll of the IF counters located on the switch.
3. The Switch will also take a part of the packet header. The length of the packet header can also be determined by the user.

Once this information has been gathered by the switch, it is packaged into a packet called an sFlow datagram, which is then sent to the sFlow Analyzer for analysis.

For a better understanding of the sFlow feature of this Switch, refer to the adjacent diagram.

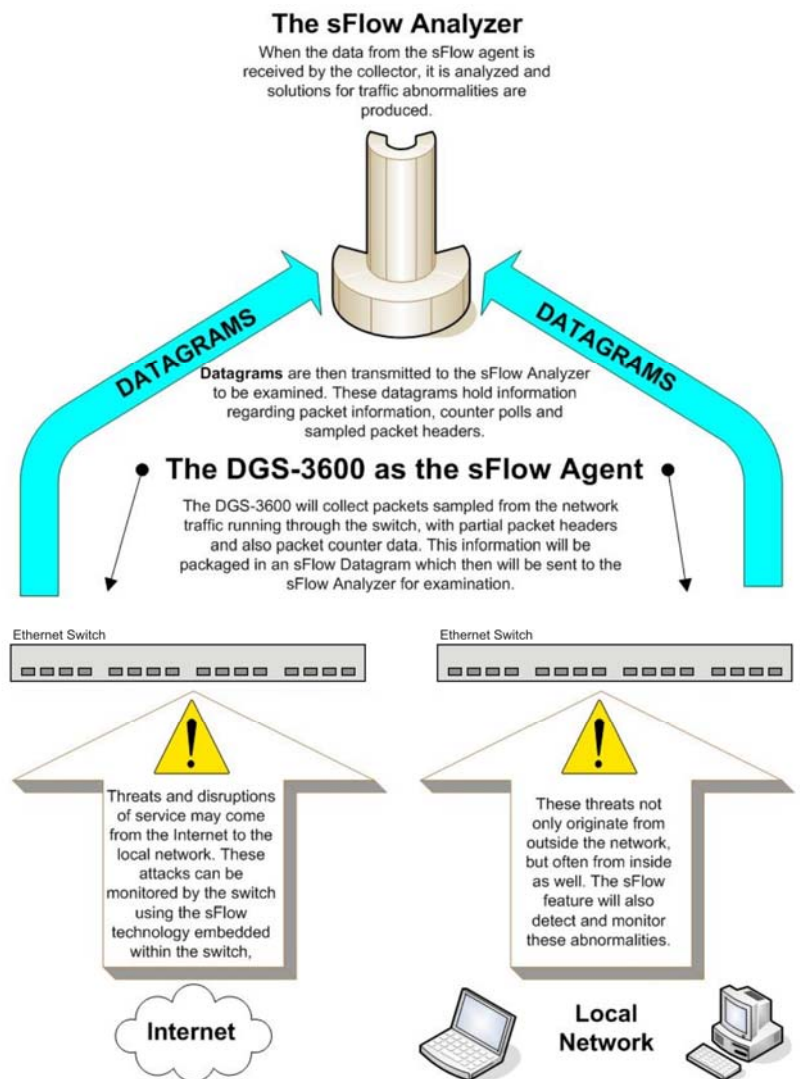

Figure 6- 52. sFlow Basic Setup

sFlow Global Settings

The following window is used to globally enable the sFlow feature for the Switch. Simply use the pull-down menu and click **Apply** to enable or disable sFlow. This window will also display the sFlow version currently being utilized by the Switch, along with the sFlow Address that is the Switch's IP address.

To view this window, click **Administration > sFlow > sFlow Global Settings**, as shown below.

Figure 6- 53. sFlow Global Settings window

The following fields are displayed:

| Parameter | Description |
|---------------|--|
| sFlow State | This field allows you to globally enable or disable sFlow. |
| sFlow Version | This displays the current sFlow version. |
| sFlow Address | This displays the sFlow IP address. |

sFlow Analyzer Settings

The following windows are used to configure the parameters for the remote sFlow Analyzer (collector) that will be used to gather and analyze sFlow Datagrams that originate from the Switch. Users must have the proper sFlow software set on the Analyzer in order to receive datagrams from the switch to be analyzed, and to analyze these datagrams. Users may specify up to four unique analyzers to receive datagrams, yet the virtual port used must be unique to each entry.

To configure the settings for the sFlow analyzer, click **Administration > sFlow > sFlow Analyzer Settings**, as shown below.

Figure 6- 54. sFlow Analyzer Settings window

The following fields are displayed:

| Parameter | Description |
|-----------|--|
| Server ID | This field denotes the ID of the Analyzer Server that has been added to the sFlow settings. Up to four entries can be added with the same UDP port. |
| Owner | Displays the owner of the entry made here. The user that added this sFlow analyzer configured this name. |
| Timeout | Displays the configured time, in seconds, after which the Analyzer server will time out. When the server times out, all sFlow samples and counter polls associated with this server will be deleted. |

| | |
|--------------------------|--|
| Countdown Time | Displays the current time remaining before this Analyzer server times out. When the server times out, all sFlow samples and counter polls associated with this server will be deleted. |
| Address | Displays the IP address of the sFlow Analyzer Server. This IP address is where sFlow datagrams will be sent for analysis. |
| Port | Displays the previously configured UDP port where sFlow datagrams will be sent for analysis. |
| Max Datagram Size | This field displays the maximum number of data bytes in a single sFlow datagram that will be sent to this sFlow Analyzer Server. |
| Modify | Click the Modify button to display the sFlow Counter Analyzer Edit window, so that users may edit the settings for this server. |
| Delete | Click the corresponding <input type="checkbox"/> button of the entry to be deleted. |

To add a new sFlow Analyzer, click the **Add** button in the previous window that will display the following window to be configured:

Figure 6- 55. sFlow Counter Analyzer – Add window

The following fields can be set or modified:

| Parameter | Description |
|---------------------------------|--|
| Analyzer Server (1-4) | Enter an integer from 1 to 4 to denote the sFlow Analyzer to be added. Up to four entries can be added. |
| Owner | Users may enter an alphanumeric string of up to 16 characters to define the owner of this entry. Users are encouraged to give this field a name that will help them identify this entry. When an entry is made in this field, the following Timeout field is automatically set to 400 seconds, unless the user alters the Timeout field. |
| Timeout (1-2000000 sec) | This field is used to specify the timeout for the Analyzer server. When the server times out, all sFlow samples and counter polls associated with this server will be deleted. The user may set a time between 1 and 2000000 seconds with a default setting of 400 seconds. <i>Infinite</i> can be selected to ensure that it never times out. |
| Collector Address | The IP address of the sFlow Analyzer Server. If this field is not specified, the entry will become 0.0.0.0 and therefore the entry will be inactive. Users must set this field. |
| Collector Port (1-65535) | The destination UDP port where sFlow datagrams will be sent. The default setting for this field is 6343. |
| Max Datagram Size | This field will specify the maximum number of data bytes that can be packaged into a single |

| | |
|-------------------|---|
| (300-1400) | sFlow datagram. Users may select a value between 300 and 1400 bytes with a default setting of 1400 bytes. |
|-------------------|---|

Click **Apply** to save changes made.

sFlow Sampler Settings

This window will allow users to configure the Switch's settings for taking sample packets from the network, including the sampling rate and the amount of the packet header to be extracted.

To configure the settings for the sFlow Sampler, click **Administration > sFlow > sFlow Sampler Settings**, as shown below.

| Add Clear All | | | | | | |
|-------------------------------|--------------------|-----------------|-------------|-----------------|--------|--------|
| sFlow Sampler Settings | | | | | | |
| Port | Analyzer Server ID | Configured Rate | Active Rate | Max Header Size | Modify | Delete |
| Total Entries: 0 | | | | | | |

Figure 6- 56. sFlow Sampler Settings window

The following fields are displayed:

| Parameter | Description |
|---------------------------|--|
| Port | Displays the port from which packet samples are being extracted. |
| Analyzer Server ID | Displays the ID of the Analyzer Server where datagrams, containing the packet sampling information taken using this sampling mechanism, will be sent. |
| Configured Rate | Displays the configured rate of packet sampling for this port based on a multiple of 256. For example, if a figure of 20 is in this field, the switch will sample one out of every 5120 packets (20 x 256 = 5120) that pass through the individual port. |
| Active Rate | Displays the current rate of packet sampling being performed by the Switch for this port, based on a multiple of 256. For example, if a figure of 20 is in this field, the switch will sample one out of every 5120 packets (20 x 256 = 5120) that pass through the individual port. |
| Max Header Size | Displays the number of leading bytes of the sampled packet header. This sampled header will be encapsulated with the datagram to be forwarded to the Analyzer Server. |
| Modify | Click this button to modify the settings for this entry. The sFlow Sampler Edit window will be produced for the user to configure. |
| Delete | Click the  of the corresponding entry to be deleted. |
| Clear All | Click this button to reset the information in this window. |

To add a new sFlow Sampler entry, click the **Add** button which will display the following window to be configured:

The screenshot shows the 'sFlow Sampler Add' configuration window. It contains the following fields:

- Unit:** A dropdown menu with '1' selected.
- From:** A dropdown menu with 'Port 1' selected.
- To:** A dropdown menu with 'Port 1' selected.
- Analyzer Server ID (1-4):** A text input field containing '1'.
- Rate (0-65535):** A text input field containing '0'.
- Max Header Size (18-256):** A text input field containing '128'.

At the bottom right, there is an 'Apply' button. At the bottom left, there is a link that says 'Show All sFlow Sampler Entries'.

Figure 6- 57. sFlow Sampler Add window

The following fields may be set:

| Parameter | Description |
|---------------------------------|---|
| Unit | Select the unit you wish to configure. |
| From... To | Choose the beginning and ending range of ports to be configured for packet sampling. |
| Analyzer Server ID (1-4) | Enter the previously configured Analyzer Server ID to state the device that will be receiving datagrams from the Switch. These datagrams will include the sample packet information taken using the sampling mechanism configured here. |
| Rate (0-65535) | Users can set the rate of packet sampling here. The value entered here is to be multiplied by 256 to get the percentage of packets sampled. For example, if the user enters a figure of 20 into this field, the switch will sample one out of every 5120 packets (20 x 256 = 5120) that pass through the individual port. Users may enter a value between 1 and 65535. An entry of 0 disables the packet sampling. Since this is the default setting, users are reminded to configure a rate here, otherwise this function will not function. |
| Max Header Size (18-256) | This field will set the number of leading bytes of the sampled packet header. This sampled header will be encapsulated with the datagram to be forwarded to the Analyzer Server. The user may set a value between 18 and 256 bytes. The default setting is 128 bytes. |

Click **Apply** to implement the changes made.

sFlow Poller Settings

The following windows will allow the user to configure the settings for the Switch’s counter poller. This mechanism will take a poll of the IF counters of the Switch and then package them with the other previously mentioned data into a datagram which will be sent to the sFlow Analyzer Server for examination.

To configure the settings for the sFlow Counter Poller, click **Administration > sFlow > sFlow Poller Settings**, as shown below.

The screenshot shows the 'sFlow Counter Poller Settings' window. At the top, there are 'Add' and 'Clear All' buttons. Below them is a table with the following columns:

| Port | Analyzer Server ID | Polling Interval (sec) | Modify | Delete |
|------------------|--------------------|------------------------|--------|--------|
| Total Entries: 0 | | | | |

Figure 6- 58. sFlow Counter Poller Settings window

The following fields are displayed:

| Parameter | Description |
|-------------------------------|--|
| Port | Displays the port from which packet counter samples are being taken. |
| Analyzer Server ID | Displays the ID of the Analyzer Server where datagrams, containing the packet counter polling information taken using this polling mechanism, will be sent. |
| Polling Interval (sec) | The Polling Interval displayed here, is measured in seconds and will take a poll of the IF counters for the corresponding port, every time the interval reaches 0 seconds. |
| Modify | Click this button to modify the settings for this entry. The sFlow Sampler Settings Edit window will be produced for the user to configure. |
| Delete | Click the corresponding  button of the entry to be deleted. |

To delete all the entries in the table click the **Clear All** button. To add a new sFlow Counter Poller setting, click the **Add** button which will display the following window to be configured.

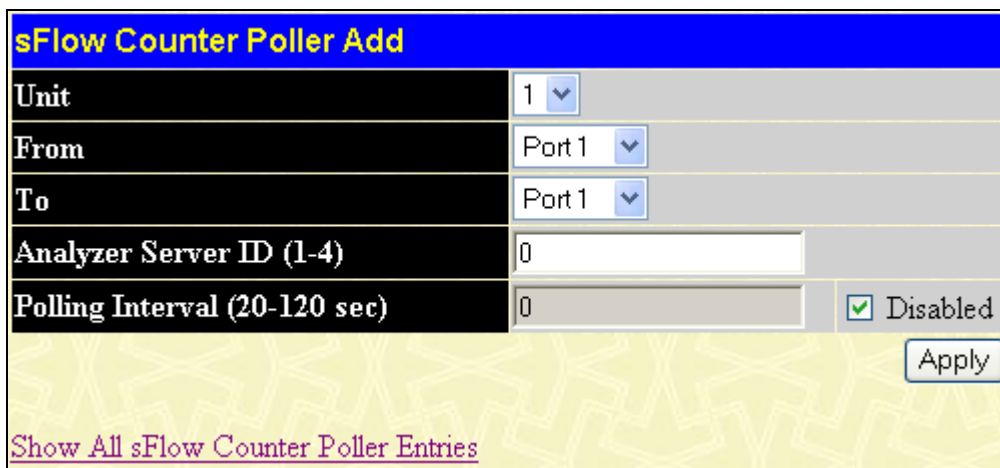

The image shows a window titled "sFlow Counter Poller Add" with a blue header. It contains the following fields:

- Unit:** A dropdown menu with "1" selected.
- From:** A dropdown menu with "Port 1" selected.
- To:** A dropdown menu with "Port 1" selected.
- Analyzer Server ID (1-4):** A text input field containing "0".
- Polling Interval (20-120 sec):** A text input field containing "0" and a checked "Disabled" checkbox.

 At the bottom right is an "Apply" button. At the bottom left is a link: "Show All sFlow Counter Poller Entries".

Figure 6- 59. sFlow Counter Poller Add window

The following fields may be set:

| Parameter | Description |
|--------------------------------------|---|
| Unit | Select the unit you wish to configure. |
| From...To | Choose the beginning and ending range of ports to be configured for counter polling. |
| Analyzer Server ID (1-4) | Enter the previously configured Analyzer Server ID to state the device that will be receiving datagrams from the Switch. These datagrams will include the counter poller information taken using the polling mechanism configured here. |
| Polling Interval (20-120 sec) | Users may configure the Polling Interval here. The switch will take a poll of the IF counters every time this interval reaches 0, and this information will be included in the sFlow datagrams that will be sent to the sFlow Analyzer for examination. Ticking the Disabled check box will disable the counter polling for this entry. |

Click **Apply** to implement the changes made.

Single IP Management Settings

Single IP Management (SIM) Overview

D-Link Single IP Management is a concept that stacks switches together over Ethernet instead of using stacking ports or modules. There are some advantages in implementing the "Single IP Management" feature:

1. SIM can simplify management of small workgroups or wiring closets while scaling the network to handle increased bandwidth demand.
2. SIM can reduce the number of IP address needed in your network.
3. SIM can eliminate any specialized cables for stacking connectivity and remove the distance barriers that typically limit your topology options when using other stacking technology.

Switches using D-Link Single IP Management (labeled here as SIM) must conform to the following rules:

- SIM is an optional feature on the Switch and can easily be enabled or disabled through the Command Line Interface or Web Interface. SIM grouping has no effect on the normal operation of the Switch in the user's network.
- There are three classifications for SIM. The Commander Switch (CS), which is the master switch of the group, Member Switch (MS), which is a switch that is recognized by the CS a member of a SIM group, and a Candidate Switch (CaS), which is a Switch that has a physical link to the SIM group but has not been recognized by the CS as a member of the SIM group.
- A SIM group can only have one Commander Switch (CS).
- All switches in a particular SIM group must be in the same IP subnet (broadcast domain). Members of a SIM group cannot cross a router.
- A SIM group accepts up to 33 switches (numbered 1-32), including the Commander Switch (numbered 0).

There is no limit to the number of SIM groups in the same IP subnet (broadcast domain), however a single switch can only belong to one group.

If multiple VLANs are configured, the SIM group will only utilize the management VLAN on any switch.

SIM allows intermediate devices that do not support SIM. This enables the user to manage switches that are more than one hop away from the CS.

The SIM group is a group of switches that are managed as a single entity. SIM switches may take on three different roles:

1. **Commander Switch (CS)** - This is a switch that has been manually configured as the controlling device for a group, and takes on the following characteristics:
 - It has an IP Address.
 - It is not a commander switch or member switch of another Single IP group.
 - It is connected to the member switches through its management VLAN.
2. **Member Switch (MS)** - This is a switch that has joined a single IP group and is accessible from the CS, and it takes on the following characteristics:
 - It is not a CS or MS of another Single IP group.
 - It is connected to the CS through the CS management VLAN.
3. **Candidate Switch (CaS)** - This is a switch that is ready to join a SIM group but is not yet a member of the SIM group. The Candidate Switch may join the SIM group of a switch by manually configuring it to be a MS of a SIM group. A switch configured as a CaS is not a member of a SIM group and will take on the following characteristics:
 - It is not a CS or MS of another Single IP group.
 - It is connected to the CS through the CS management VLAN

After configuring one switch to operate as the CS of a SIM group, additional switches may join the group through a direct connection to the Commander switch. Only the Commander switch will allow entry to the candidate switch enabled for SIM. The CS will then serve as the in band entry point for access to the MS. The CS's IP address will become the path to all MS's of the group and the CS's Administrator's password, and/or authentication will control access to all MS's of the SIM group.

With SIM enabled, the applications in the CS will redirect the packet instead of executing the packets. The applications will decode the packet from the administrator, modify some data, then send it to the MS. After execution, the CS may receive a response packet from the MS, which it will encode and send it back to the administrator.

When a CaS becomes a MS, it automatically becomes a member of the first SNMP community (include read/write and read only) to which the CS belongs. However, if a MS has its own IP address, it can belong to SNMP communities to which other switches in the group, including the CS, do not belong.

The Upgrade to v1.61

To better improve SIM management, the Switch has been upgraded to version 1.61 in this release. Many improvements have been made, including:

1. The Commander Switch (CS) now has the capability to automatically rediscover member switches that have left the SIM group, either through a reboot or web malfunction. This feature is accomplished through the use of Discover packets and Maintain packets that previously set SIM members will emit after a reboot. Once a MS has had its MAC address and password saved to the CS's database, if a reboot occurs in the MS, the CS will keep this MS information in its database and when a MS has been rediscovered, it will add the MS back into the SIM tree automatically. No configuration will be necessary to rediscover these switches.

There are some instances where pre-saved MS switches cannot be rediscovered. For example, if the Switch is still powered down, if it has become the member of another group, or if it has been configured to be a Commander Switch, the rediscovery process cannot occur.

2. The topology map now includes new features for connections that are a member of a port trunking group. It will display the speed and number of Ethernet connections creating this port trunk group, as shown in the adjacent picture.

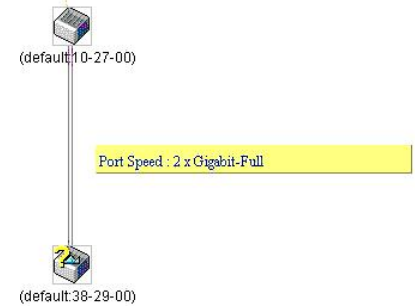

NOTE: For more details regarding improvements made in SIMv1.61, please refer to the **D-Link Single IP Management** White Paper located on the D-Link website.

3. This version will support switch upload and downloads for firmware, configuration files and log files, as follows:

- Firmware – The switch now supports MS firmware downloads from a TFTP server.
- Configuration Files – This switch now supports downloading and uploading of configuration files both to (for configuration restoration) and from (for configuration backup) MS's, using a TFTP server.
- Log – The switch now supports uploading MS log files to a TFTP server.

4. The user may zoom in and zoom out when utilizing the topology window to get a better, more defined view of the configurations.

SIM Settings

All switches are set as Candidate (CaS) switches as their factory default configuration and Single IP Management will be disabled.

To view this window, click **Administration > Sim Settings > Single IP Management Settings**, as shown below.

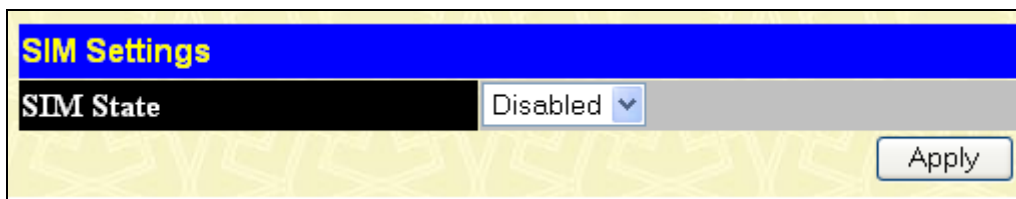

Figure 6- 60. SIM Settings window (Disabled)

Change the SIM State to *Enabled* using the pull-down menu and click **Apply**. The window will then refresh and the **SIM Settings** window will look like this:

Figure 6- 61. SIM Settings window (Enabled)

If the Switch Administrator wishes to configure the Switch as a Commander Switch (CS), select commander from the Role State field and click **Apply**.

The following parameters can be set:

| Parameters | Description |
|---------------------------|--|
| SIM State | Use the pull-down menu to either enable or disable the SIM state on the Switch. <i>Disabled</i> will render all SIM functions on the Switch inoperable. |
| Role State | Use the pull-down menu to change the SIM role of the Switch. The two choices are: <ul style="list-style-type: none"> • <i>Candidate</i> - A Candidate Switch (CaS) is not the member of a SIM group but is connected to a Commander Switch. This is the default setting for the SIM role. • <i>Commander</i> - Choosing this parameter will make the Switch a Commander Switch (CS). The user may join other switches to this Switch, over Ethernet, to be part of its SIM group. Choosing this option will also enable the Switch to be configured for SIM. |
| Group Name | Enter a group name in this field. |
| Discovery Interval | The user may set the discovery protocol interval, in seconds that the Switch will send out discovery packets. Returning information to a Commander Switch will include information about other switches connected to it. (Ex. MS, CaS). The user may set the Discovery Interval from 30 to 90 seconds. |
| Holdtime | This parameter may be set for the time, in seconds the Switch will hold information sent to it from other switches, utilizing the Discovery Interval. The user may set the hold time from 100 to 255 seconds. |

Click **Apply** to implement the settings changed.

After enabling the Switch to be a Commander Switch (CS), the **Single IP Management Settings** folder will then contain four added links to aid the user in configuring SIM through the web, including **Topology**, **Firmware Upgrade**, **Configuration Backup/Restore** and **Upload Log**.

Topology

The **Topology** window will be used to configure and manage the Switch within the SIM group and requires Java script to function properly on your computer.

The Java Runtime Environment on your server should initiate and lead you to the topology window, as seen below.

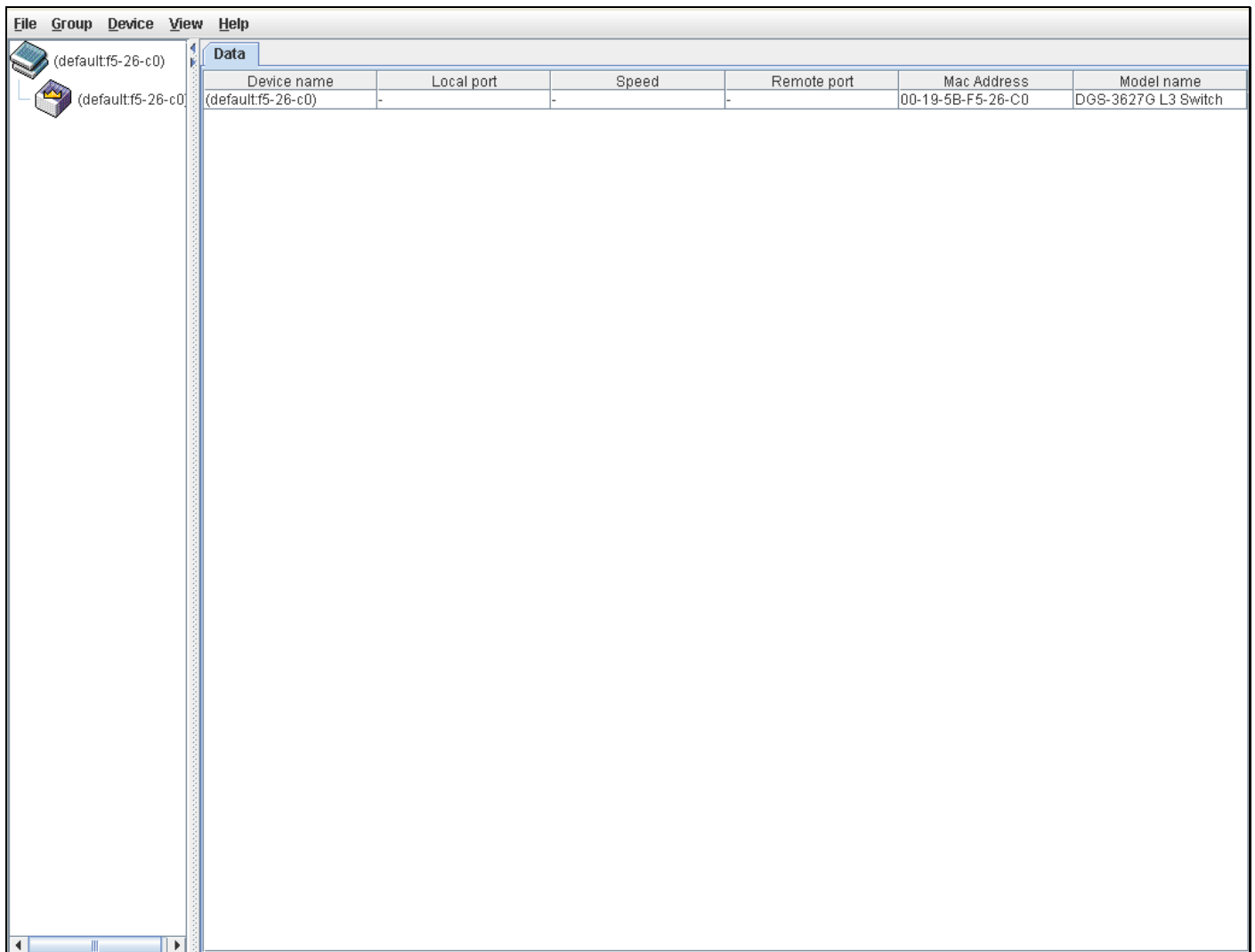

Figure 6- 62. Topology window

This window holds the following information under the **Data** tab:

| Parameter | Description |
|--------------------|--|
| Device Name | This field will display the Device Name of the switches in the SIM group configured by the user. If no Device Name is configured by the name, it will be given the name default and tagged with the last six digits of the MAC Address to identify it. |
| Local Port | Displays the number of the physical port on the CS that the MS or CaS is connected to. The CS will have no entry in this field. |
| Speed | Displays the connection speed between the CS and the MS or CaS. |
| Remote Port | Displays the number of the physical port on the MS or CaS that the CS is connected to. The CS will have no entry in this field. |
| MAC Address | Displays the MAC Address of the corresponding Switch. |
| Model Name | Displays the full Model Name of the corresponding Switch. |

To view the Topology Map, click the **View** menu in the toolbar and then **Topology**, which will produce the following window. The Topology View will refresh itself periodically (20 seconds by default).

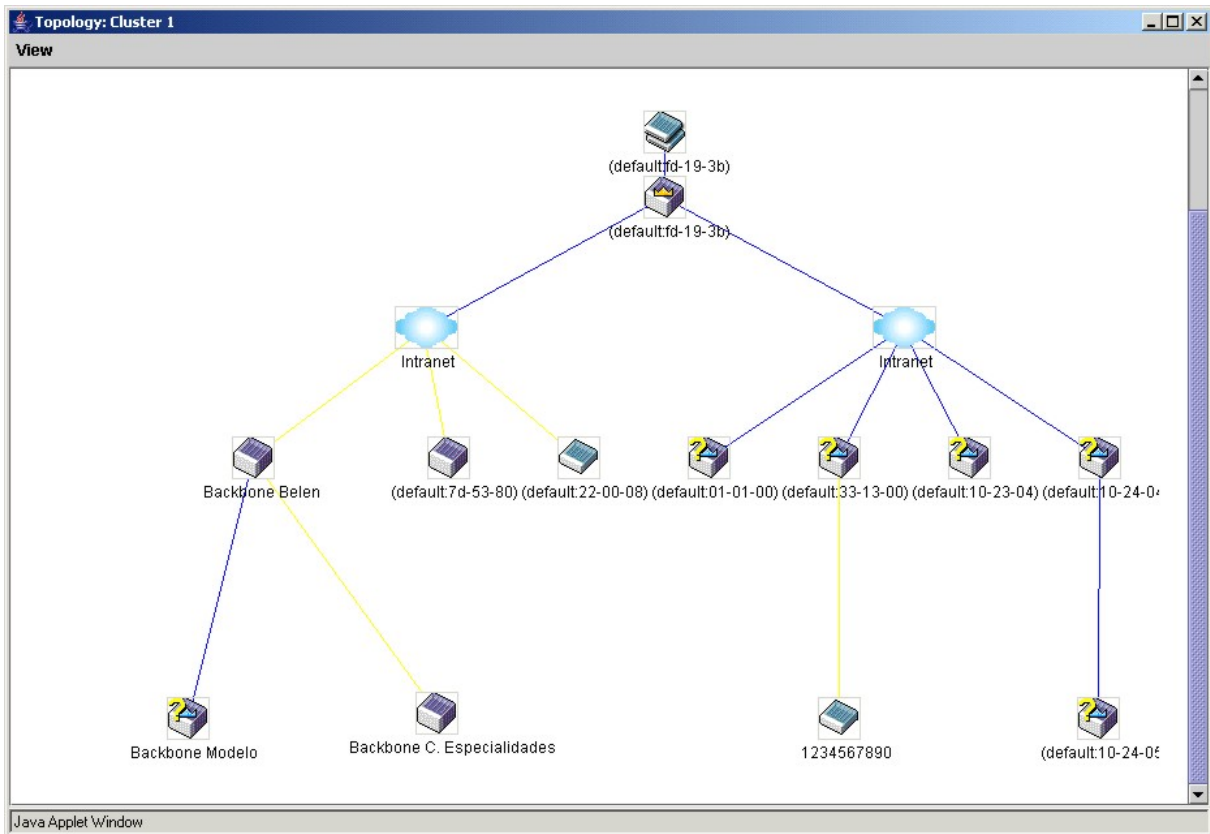

Figure 6- 63. Topology View window

This window will display how the devices within the Single IP Management Group are connected to other groups and devices. Possible icons in this window are as follows:

| Icon | Description |
|------|---------------------------------|
| | Group |
| | Layer 2 commander switch |
| | Layer 3 commander switch |
| | Commander switch of other group |
| | Layer 2 member switch |
| | Layer 3 member switch |
| | Member switch of other group |
| | Layer 2 candidate switch |
| | Layer 3 candidate switch |
| | Unknown device |

| | |
|---|-----------------|
|  | Non-SIM devices |
|---|-----------------|

Tool Tips

In the **Topology View** window, the mouse plays an important role in configuration and in viewing device information. Setting the mouse cursor over a specific device in the topology window (tool tip) will display the same information about a specific device as the Tree view does. See the window below for an example.

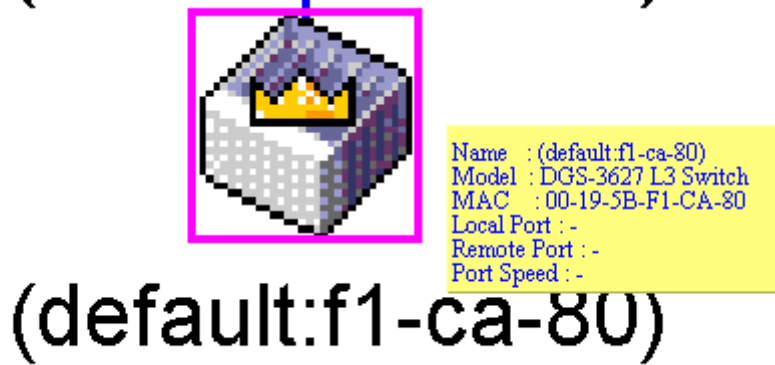

Figure 6- 64. Device Information Utilizing the Tool Tip

Setting the mouse cursor over a line between two devices will display the connection speed between the two devices, as shown below.

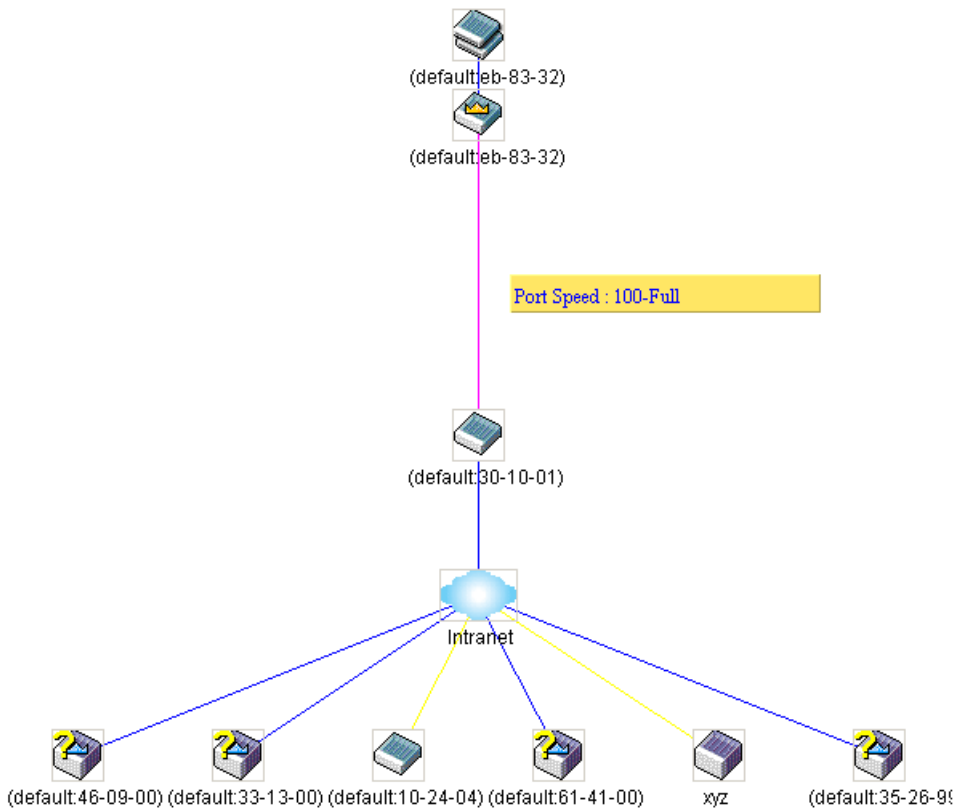

Figure 6- 65. Port Speed Utilizing the Tool Tip

Right-Click

Right-clicking on a device will allow the user to perform various functions, depending on the role of the Switch in the SIM group and the icon associated with it.

Group Icon

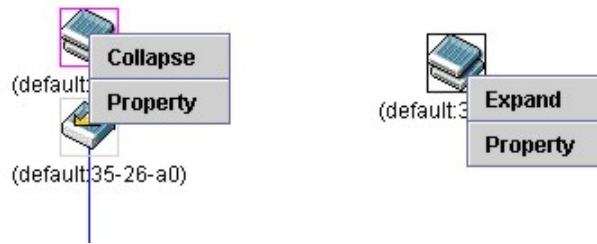

Figure 6- 66. Right-Clicking a Group Icon

The following options may appear for the user to configure:

- **Collapse** - To collapse the group that will be represented by a single icon.
- **Expand** - To expand the SIM group, in detail.
- **Property** - To pop up a window to display the group information.

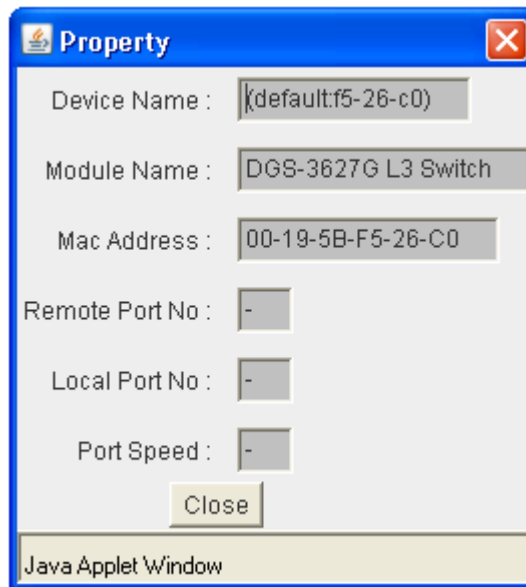

Figure 6- 67. Property window

This window holds the following information:

| Parameter | Description |
|------------------------|--|
| Device Name | This field will display the Device Name of the switches in the SIM group configured by the user. If no Device Name is configured by the name, it will be given the name default and tagged with the last six digits of the MAC Address to identify it. |
| Module Name | Displays the full module name of the switch that was right-clicked. |
| MAC Address | Displays the MAC Address of the corresponding Switch. |
| Remote Port No. | Displays the number of the physical port on the MS or CaS that the CS is connected to. The CS will have no entry in this field. |
| Local Port No. | Displays the number of the physical port on the CS that the MS or CaS is connected to. The CS will have no entry in this field. |
| Port Speed | Displays the connection speed between the CS and the MS or CaS |

Click **Close** to close the **Property** window.

Commander Switch Icon

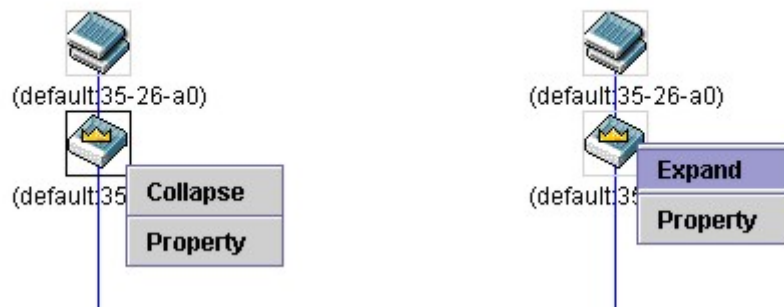

Figure 6- 68. Right-Clicking a Commander Icon

The following options may appear for the user to configure:

- **Collapse** - To collapse the group that will be represented by a single icon.
- **Expand** - To expand the SIM group, in detail.
- **Property** - To pop up a window to display the group information.

Member Switch Icon

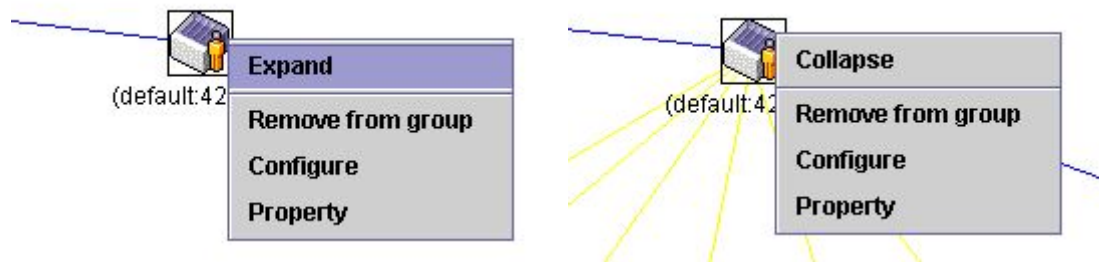

Figure 6- 69. Right-Clicking a Member icon

The following options may appear for the user to configure:

- **Collapse** - To collapse the group that will be represented by a single icon.
- **Expand** - To expand the SIM group, in detail.
- **Remove from group** - Remove a member from a group.
- **Configure** - Launch the web management to configure the Switch.
- **Property** - To pop up a window to display the device information.

Candidate Switch Icon

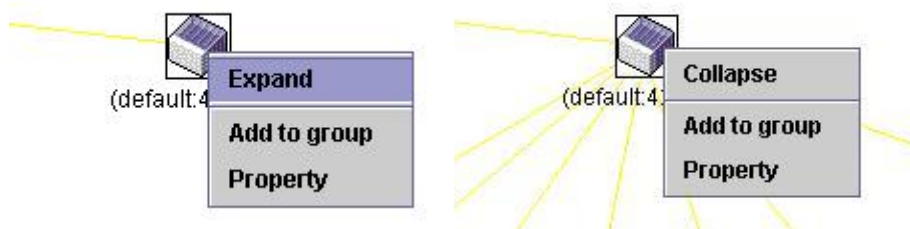

Figure 6- 70. Right-Clicking a Candidate icon

The following options may appear for the user to configure:

- **Collapse** - To collapse the group that will be represented by a single icon.
- **Expand** - To expand the SIM group, in detail.

- **Add to group** - Add a candidate to a group. Clicking this option will reveal the following window for the user to enter a password for authentication from the Candidate Switch before being added to the SIM group. Click **OK** to enter the password or **Cancel** to exit the window.

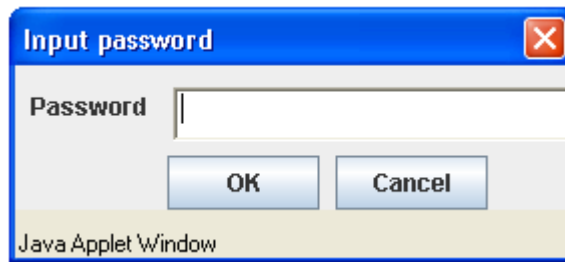

Figure 6- 71. Input password window

- **Property** - To pop up a window to display the device information.

Menu Bar

The **Single IP Management** window contains a menu bar for device configurations, as seen below.



Figure 6- 72. Menu Bar of the Topology View

The five menus on the menu bar are as follows.

File

- **Print Setup** - Will view the image to be printed.
- **Print Topology** - Will print the topology map.
- **Preference** - Will set display properties, such as polling interval, and the views to open at SIM startup.

Group

- **Add to group** - Add a candidate to a group. Clicking this option will reveal the following screen for the user to enter a password for authentication from the Candidate Switch before being added to the SIM group. Click **OK** to enter the password or **Cancel** to exit the window.

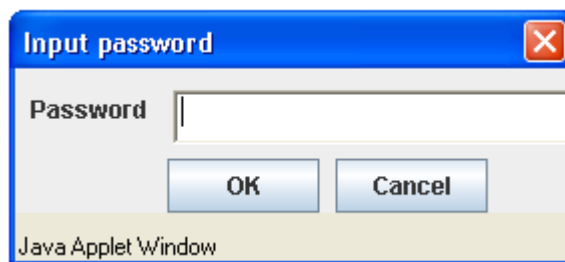

Figure 6- 73. Input password window

- **Remove from Group** - Remove an MS from the group.

Device

- **Configure** - Will open the web manager for the specific device.

View

- **Refresh** - Update the views with the latest status.
- **Topology** - Display the Topology view.

Help

- **About** - Will display the SIM information, including the current SIM version.



NOTE: Upon this firmware release, some functions of the SIM can only be configured through the Command Line Interface. See the **DGS-3600 Series CLI Manual** for more information on SIM and its configurations.

Firmware Upgrade

This screen is used to upgrade firmware from the Commander Switch to the Member Switch. Member Switches will be listed in the table and will be specified by Port (port on the CS where the MS resides), MAC Address, Model Name and Version. To specify a certain Switch for firmware download, click its corresponding check box under the Port heading. To update the firmware, enter the Server IP Address where the firmware resides and enter the Path/File name of the firmware. Click **Download** to initiate the file transfer.

To view this window, click **Administration > Single IP Management Settings > Firmware Upgrade**, as shown below.

| ID | Port | MAC Address | Model Name | Version |
|----|------|-------------|------------|---------|
| | | | | |

Server IP Address 0 . 0 . 0 . 0
Path \ File name

Figure 6- 74. Firmware Upgrade window

Configuration File Backup/Restore

This screen is used to upgrade configuration files from the Commander Switch to the Member Switch using a TFTP server. Member Switches will be listed in the table and will be specified by Port (port on the CS where the MS resides), MAC Address, Model Name and Version. To specify a certain Switch for upgrading configuration files, click its corresponding radio button under the Port heading. To update the configuration file, enter the Server IP Address where the file resides and enter the Path/File name of the configuration file. Click **Download** to initiate the file transfer from a TFTP server to the Switch. Click **Upload** to backup the configuration file to a TFTP server.

| Configuration File Backup/Restore | | | | |
|-----------------------------------|------|--------------------------------|--------------------------------|---|
| ID | Port | MAC Address | Model Name | Version |
| Server IP Address | | <input type="text" value="0"/> | <input type="text" value="0"/> | <input type="text" value="0"/> |
| Path \ Filename | | <input type="text"/> | | |
| | | | | <input type="button" value="Upload"/> <input type="button" value="Download"/> |

Figure 6- 75. Configuration File Backup/Restore window

Upload Log File

The following window is used to upload log files from SIM member switches to a specified PC. To upload a log file, enter the IP address of the SIM member switch and then enter a path on your PC where you wish to save this file. Click **Upload** to initiate the file transfer.

| Upload Log File | | | | |
|-------------------|------|--------------------------------|--------------------------------|---------------------------------------|
| ID | Port | MAC Address | Model Name | Version |
| Server IP Address | | <input type="text" value="0"/> | <input type="text" value="0"/> | <input type="text" value="0"/> |
| Path \ Filename | | <input type="text"/> | | |
| | | | | <input type="button" value="Upload"/> |

Figure 6- 76. Upload Log File window

Section 7

L2 Features

VLAN

Trunking

IGMP Snooping

MLD Snooping

Loopback Detection Global Settings

Spanning Tree

Forwarding & Filtering

LLDP

QinQ

The following section will aid the user in configuring security functions for the Switch all functions are discussed in detail in the following section.

VLAN

Understanding IEEE 802.1p Priority

Priority tagging is a function defined by the IEEE 802.1p standard designed to provide a means of managing traffic on a network where many different types of data may be transmitted simultaneously. It is intended to alleviate problems associated with the delivery of time critical data over congested networks. The quality of applications that are dependent on such time critical data, such as video conferencing, can be severely and adversely affected by even very small delays in transmission.

Network devices that are in compliance with the IEEE 802.1p standard have the ability to recognize the priority level of data packets. These devices can also assign a priority label or tag to packets. Compliant devices can also strip priority tags from packets. This priority tag determines the packet's degree of expeditiousness and determines the queue to which it will be assigned.

Priority tags are given values from 0 to 7 with 0 being assigned to the lowest priority data and 7 assigned to the highest. The highest priority tag 7 is generally only used for data associated with video or audio applications, which are sensitive to even slight delays, or for data from specified end users whose data transmissions warrant special consideration.

The Switch also allows further tailoring of how priority tagged data packets are handled on your network. Using queues to manage priority tagged data allows users to specify its relative priority to suit the needs of your network. There may be circumstances where it would be advantageous to group two or more differently tagged packets into the same queue. Generally, however, it is recommended that the highest priority queue, Queue 7, be reserved for data packets with a priority value of 7. Packets that have not been given any priority value are placed in Queue 0 and thus given the lowest priority for delivery.

Strict mode and weighted round robin system are employed on the Switch to determine the rate at which the queues are emptied of packets. The ratio used for clearing the queues is 4:1. This means that the highest priority queue, Queue 7, will clear 4 packets for every 1 packet cleared from Queue 0.

Remember, the priority queue settings on the Switch are for all ports, and all devices connected to the Switch will be affected. This priority queuing system will be especially beneficial if your network employs switches with the capability of assigning priority tags.

VLAN Description

A Virtual Local Area Network (VLAN) is a network topology configured according to a logical scheme rather than the physical layout. VLANs can be used to combine any collection of LAN segments into an autonomous user group that appears as a single LAN. VLANs also logically segment the network into different broadcast domains so that packets are forwarded only between ports within the VLAN. Typically, a VLAN corresponds to a particular subnet, although not necessarily.

VLANs can enhance performance by conserving bandwidth, and improve security by limiting traffic to specific domains.

A VLAN is a collection of end nodes grouped by logic instead of physical location. End nodes that frequently communicate with each other are assigned to the same VLAN, regardless of where they are physically on the network. Logically, a VLAN can be equated to a broadcast domain, because broadcast packets are forwarded to only members of the VLAN on which the broadcast was initiated.

Notes About VLANs on the Switch

No matter what basis is used to uniquely identify end nodes and assign these nodes VLAN membership, packets cannot cross VLANs without a network device performing a routing function between the VLANs.

The Switch supports IEEE 802.1Q VLANs. The port untagging function can be used to remove the 802.1Q tag from packet headers to maintain compatibility with devices that are tag-unaware.

The Switch's default is to assign all ports to a single 802.1Q VLAN named "default."

The "default" VLAN has a VID = 1.

IEEE 802.1Q VLANs

Some relevant terms:

- **Tagging** - The act of putting 802.1Q VLAN information into the header of a packet.
- **Untagging** - The act of stripping 802.1Q VLAN information out of the packet header.
- **Ingress port** - A port on a switch where packets are flowing into the Switch and VLAN decisions must be made.
- **Egress port** - A port on a switch where packets are flowing out of the Switch, either to another switch or to an end station, and tagging decisions must be made.

IEEE 802.1Q (tagged) VLANs are implemented on the Switch. 802.1Q VLANs require tagging, which enables them to span the entire network (assuming all switches on the network are IEEE 802.1Q-compliant).

VLANs allow a network to be segmented in order to reduce the size of broadcast domains. All packets entering a VLAN will only be forwarded to the stations (over IEEE 802.1Q enabled switches) that are members of that VLAN, and this includes broadcast, multicast and unicast packets from unknown sources.

VLANs can also provide a level of security to your network. IEEE 802.1Q VLANs will only deliver packets between stations that are members of the VLAN.

Any port can be configured as either tagging or untagging. The untagging feature of IEEE 802.1Q VLANs allows VLANs to work with legacy switches that don't recognize VLAN tags in packet headers. The tagging feature allows VLANs to span multiple 802.1Q-compliant switches through a single physical connection and allows Spanning Tree to be enabled on all ports and work normally.

The IEEE 802.1Q standard restricts the forwarding of untagged packets to the VLAN of which the receiving port is a member.

The main characteristics of IEEE 802.1Q are as follows:

- Assigns packets to VLANs by filtering.
- Assumes the presence of a single global spanning tree.
- Uses an explicit tagging scheme with one-level tagging.
- 802.1Q VLAN Packet Forwarding
- Packet forwarding decisions are made based upon the following three types of rules:
- Ingress rules - rules relevant to the classification of received frames belonging to a VLAN.
- Forwarding rules between ports - decides whether to filter or forward the packet.
- Egress rules - determines if the packet must be sent tagged or untagged.

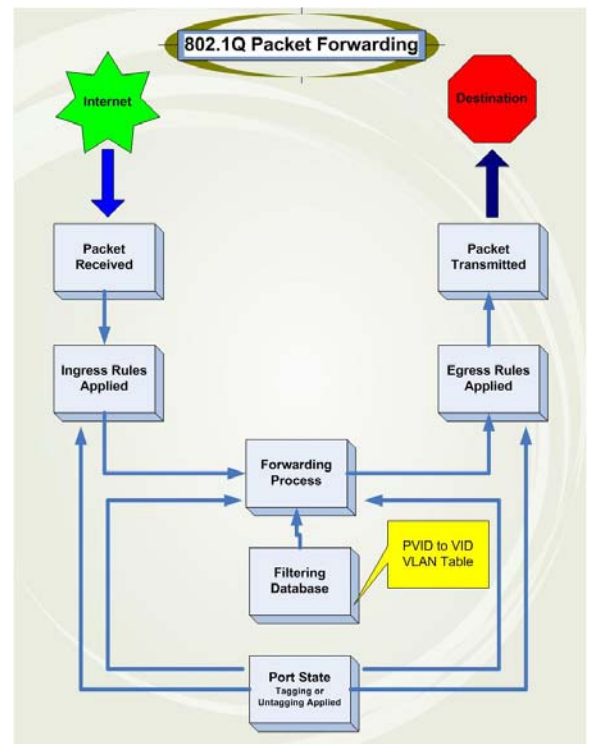

Figure 7- 1. IEEE 802.1Q Packet Forwarding

802.1Q VLAN Tags

The figure below shows the 802.1Q VLAN tag. There are four additional octets inserted after the source MAC address. Their presence is indicated by a value of 0x8100 in the EtherType field. When a packet's EtherType field is equal to 0x8100, the packet carries the IEEE 802.1Q/802.1p tag. The tag is contained in the following two octets and consists of 3 bits of user priority, 1 bit of Canonical Format Identifier (CFI - used for encapsulating Token Ring packets so they can be carried across Ethernet backbones), and 12 bits of VLAN ID (VID). The 3 bits of user priority are used by 802.1p. The VID is the VLAN identifier and is used by the 802.1Q standard. Because the VID is 12 bits long, 4094 unique VLANs can be identified.

The tag is inserted into the packet header making the entire packet longer by 4 octets. All of the information originally contained in the packet is retained.

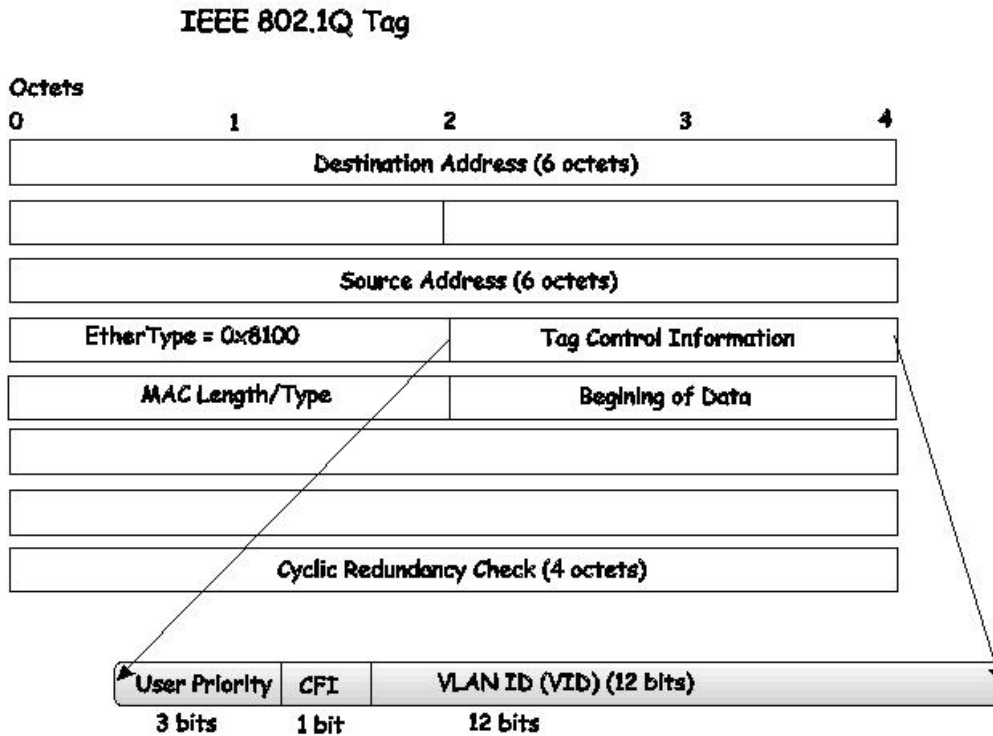

Figure 7- 2. IEEE 802.1Q Tag

The EtherType and VLAN ID are inserted after the MAC source address, but before the original EtherType/Length or Logical Link Control. Because the packet is now a bit longer than it was originally, the Cyclic Redundancy Check (CRC) must be recalculated.

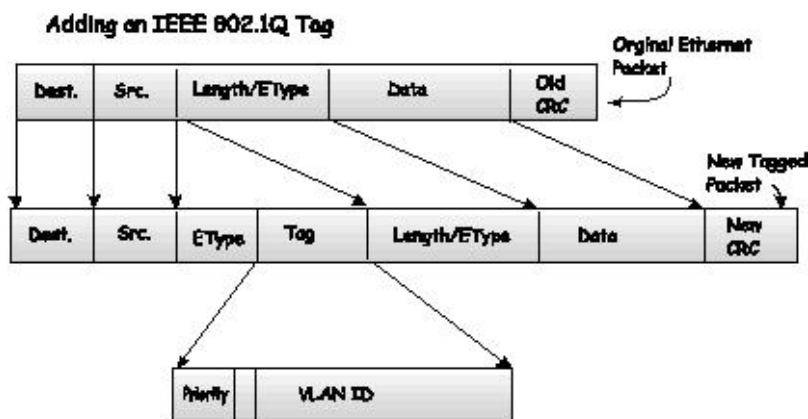

Figure 7- 3. Adding an IEEE 802.1Q Tag

Port VLAN ID

Packets that are tagged (are carrying the 802.1Q VID information) can be transmitted from one 802.1Q compliant network device to another with the VLAN information intact. This allows 802.1Q VLANs to span network devices (and indeed, the entire network, if all network devices are 802.1Q compliant).

Unfortunately, not all network devices are 802.1Q compliant. These devices are referred to as tag-unaware. 802.1Q devices are referred to as tag-aware.

Prior to the adoption of 802.1Q VLANs, port-based and MAC-based VLANs were in common use. These VLANs relied upon a Port VLAN ID (PVID) to forward packets. A packet received on a given port would be assigned that port's PVID and then be forwarded to the port that corresponded to the packet's destination address (found in the Switch's forwarding table). If the PVID of the port that received the packet is different from the PVID of the port that is to transmit the packet, the Switch will drop the packet.

Within the Switch, different PVIDs mean different VLANs (remember that two VLANs cannot communicate without an external router). So, VLAN identification based upon the PVIDs cannot create VLANs that extend outside a given switch (or switch stack).

Every physical port on a switch has a PVID. 802.1Q ports are also assigned a PVID, for use within the Switch. If no VLANs are defined on the Switch, all ports are then assigned to a default VLAN with a PVID equal to 1. Untagged packets are assigned the PVID of the port on which they were received. Forwarding decisions are based upon this PVID, in so far as VLANs are concerned. Tagged packets are forwarded according to the VID contained within the tag. Tagged packets are also assigned a PVID, but the PVID is not used to make packet-forwarding decisions, the VID is.

Tag-aware switches must keep a table to relate PVIDs within the Switch to VIDs on the network. The Switch will compare the VID of a packet to be transmitted to the VID of the port that is to transmit the packet. If the two VIDs are different, the Switch will drop the packet. Because of the existence of the PVID for untagged packets and the VID for tagged packets, tag-aware and tag-unaware network devices can coexist on the same network.

A switch port can have only one PVID, but can have as many VIDs as the Switch has memory in its VLAN table to store them.

Because some devices on a network may be tag-unaware, a decision must be made at each port on a tag-aware device before packets are transmitted - should the packet to be transmitted have a tag or not? If the transmitting port is connected to a tag-unaware device, the packet should be untagged. If the transmitting port is connected to a tag-aware device, the packet should be tagged.

Tagging and Untagging

Every port on an 802.1Q compliant switch can be configured as tagging or untagging.

Ports with tagging enabled will put the VID number, priority and other VLAN information into the header of all packets that flow into and out of it. If a packet has previously been tagged, the port will not alter the packet, thus keeping the VLAN information intact. Other 802.1Q compliant devices on the network to make packet-forwarding decisions can then use the VLAN information in the tag.

Ports with untagging enabled will strip the 802.1Q tag from all packets that flow into and out of those ports. If the packet doesn't have an 802.1Q VLAN tag, the port will not alter the packet. Thus, all packets received by and forwarded by an untagging port will have no 802.1Q VLAN information. (Remember that the PVID is only used internally within the Switch). Untagging is used to send packets from an 802.1Q-compliant network device to a non-compliant network device.

Ingress Filtering

A port on a switch where packets are flowing into the Switch and VLAN decisions must be made is referred to as an ingress port. If ingress filtering is enabled for a port, the Switch will examine the VLAN information in the packet header (if present) and decide whether or not to forward the packet.

If the packet is tagged with VLAN information, the ingress port will first determine if the ingress port itself is a member of the tagged VLAN. If it is not, the packet will be dropped. If the ingress port is a member of the 802.1Q VLAN, the Switch then determines if the destination port is a member of the 802.1Q VLAN. If it is not, the packet is dropped. If the destination port is a member of the 802.1Q VLAN, the packet is forwarded and the destination port transmits it to its attached network segment.

If the packet is not tagged with VLAN information, the ingress port will tag the packet with its own PVID as a VID (if the port is a tagging port). The Switch then determines if the destination port is a member of the same VLAN (has the same VID) as the ingress port. If it does not, the packet is dropped. If it has the same VID, the packet is forwarded and the destination port transmits it on its attached network segment.

This process is referred to as ingress filtering and is used to conserve bandwidth within the Switch by dropping packets that are not on the same VLAN as the ingress port at the point of reception. This eliminates the subsequent processing of packets that will just be dropped by the destination port.

Default VLANs

The Switch initially configures one VLAN, VID = 1, called "default." The factory default setting assigns all ports on the Switch to the "default." As new VLANs are configured in Port-based mode, their respective member ports are removed from the "default."

Packets cannot cross VLANs. If a member of one VLAN wants to connect to another VLAN, the link must be through an external router.



NOTE: If no VLANs are configured on the Switch, then all packets will be forwarded to any destination port. Packets with unknown source addresses will be flooded to all ports. Broadcast and multicast packets will also be flooded to all ports.

An example is presented below:

| VLAN Name | VID | Switch Ports |
|------------------|-----|--------------|
| System (default) | 1 | 5, 6, 7, 8, |
| Engineering | 2 | 9, 10 |
| Marketing | 3 | 3, 4 |
| Finance | 4 | 11, 12 |
| Sales | 5 | 1, 2, 3, 4 |

Figure 7- 4. VLAN Example - Assigned Ports

VLAN Segmentation

Take for example a packet that is transmitted by a machine on Port 1 that is a member of VLAN 2. If the destination lies on another port (found through a normal forwarding table lookup), the Switch then looks to see if the other port (Port 10) is a member of VLAN 2 (and can therefore receive VLAN 2 packets). If Port 10 is not a member of VLAN 2, then the packet will be dropped by the Switch and will not reach its destination. If Port 10 is a member of VLAN 2, the packet will go through. This selective forwarding feature based on VLAN criteria is how VLANs segment networks. The key point being that Port 1 will only transmit on VLAN 2.

Network resources such as printers and servers can be shared across VLANs. This is achieved by setting up overlapping VLANs. That is ports can belong to more than one VLAN group. For example, setting VLAN 1 members to ports 1, 2, 3, and 4 and VLAN 2 members to ports 1, 5, 6, and 7. Port 1 belongs to two VLAN groups. Ports 8, 9, and 10 are not configured to any VLAN group. This means ports 8, 9, and 10 are in the same VLAN group.

VLAN and Trunk Groups

The members of a trunk group have the same VLAN setting. Any VLAN setting on the members of a trunk group will apply to the other member ports.



NOTE: In order to use VLAN segmentation in conjunction with port trunk groups, you can first set the port trunk group(s), and then you may configure VLAN settings. If users wish to change the port trunk grouping with VLANs already in place, there will be no need to reconfigure the VLAN settings after changing the port trunk group settings. VLAN settings will automatically change in conjunction with the change of the port trunk group settings.

Static VLAN Entries

This window is used to create static VLAN entries on the switch.

To view this window, click **L2 Features > VLAN > Static VLAN Entries**, as shown below.

| Add | | | | | |
|-----------------------------|-----------|----------|---------------|--------|--------|
| Total Entries: 2 | | | | | |
| Current Static VLAN Entries | | | | | |
| VID | VLAN Name | Ports | Advertisement | Modify | Delete |
| 1 | default | 1:1-1:25 | Enabled | Modify | X |
| 3 | RG | 1:11 | Enabled | Modify | X |

Figure 7- 5. Current Static VLAN Entries window

The **Current Static VLAN Entries** window lists all previously configured VLANs by VLAN ID and VLAN Name. To delete an existing 802.1Q VLAN, click the corresponding **X** button under the Delete heading.

To create a new 802.1Q VLAN, click the **Add** button, a new window will appear, as shown below. To configure the port settings and to assign a unique name and number to the new VLAN see the table below.

| Static VLAN | | | | | | | | | | | | | | | | | | | | | | | | | | | |
|--|-----|----------------------------------|----------------------------------|----------------------------------|----------------------------------|----------------------------------|----------------------------------|----------------------------------|----------------------------------|----------------------------------|----------------------------------|----------------------------------|----------------------------------|----------------------------------|----------------------------------|----------------------------------|----------------------------------|----------------------------------|----------------------------------|----------------------------------|----------------------------------|----------------------------------|----------------------------------|----------------------------------|----------------------------------|----------------------------------|---------------|
| Unit | VID | VLAN Name | | | | | | | | | | | | | | | | | | | | | | | | | Advertisement |
| 1 | | | | | | | | | | | | | | | | | | | | | | | | | | | Disabled |
| Port Settings | | 1 | 2 | 3 | 4 | 5 | 6 | 7 | 8 | 9 | 10 | 11 | 12 | 13 | 14 | 15 | 16 | 17 | 18 | 19 | 20 | 21 | 22 | 23 | 24 | 25 | |
| Tag | | <input type="checkbox"/> | <input type="checkbox"/> | <input type="checkbox"/> | <input type="checkbox"/> | <input type="checkbox"/> | <input type="checkbox"/> | <input type="checkbox"/> | <input type="checkbox"/> | <input type="checkbox"/> | <input type="checkbox"/> | <input type="checkbox"/> | <input type="checkbox"/> | <input type="checkbox"/> | <input type="checkbox"/> | <input type="checkbox"/> | <input type="checkbox"/> | <input type="checkbox"/> | <input type="checkbox"/> | <input type="checkbox"/> | <input type="checkbox"/> | <input type="checkbox"/> | <input type="checkbox"/> | <input type="checkbox"/> | <input type="checkbox"/> | <input type="checkbox"/> | |
| None | | <input checked="" type="radio"/> | <input checked="" type="radio"/> | <input checked="" type="radio"/> | <input checked="" type="radio"/> | <input checked="" type="radio"/> | <input checked="" type="radio"/> | <input checked="" type="radio"/> | <input checked="" type="radio"/> | <input checked="" type="radio"/> | <input checked="" type="radio"/> | <input checked="" type="radio"/> | <input checked="" type="radio"/> | <input checked="" type="radio"/> | <input checked="" type="radio"/> | <input checked="" type="radio"/> | <input checked="" type="radio"/> | <input checked="" type="radio"/> | <input checked="" type="radio"/> | <input checked="" type="radio"/> | <input checked="" type="radio"/> | <input checked="" type="radio"/> | <input checked="" type="radio"/> | <input checked="" type="radio"/> | <input checked="" type="radio"/> | <input checked="" type="radio"/> | |
| Egress | | <input type="radio"/> | <input type="radio"/> | <input type="radio"/> | <input type="radio"/> | <input type="radio"/> | <input type="radio"/> | <input type="radio"/> | <input type="radio"/> | <input type="radio"/> | <input type="radio"/> | <input type="radio"/> | <input type="radio"/> | <input type="radio"/> | <input type="radio"/> | <input type="radio"/> | <input type="radio"/> | <input type="radio"/> | <input type="radio"/> | <input type="radio"/> | <input type="radio"/> | <input type="radio"/> | <input type="radio"/> | <input type="radio"/> | <input type="radio"/> | <input type="radio"/> | |
| Forbidden | | <input type="radio"/> | <input type="radio"/> | <input type="radio"/> | <input type="radio"/> | <input type="radio"/> | <input type="radio"/> | <input type="radio"/> | <input type="radio"/> | <input type="radio"/> | <input type="radio"/> | <input type="radio"/> | <input type="radio"/> | <input type="radio"/> | <input type="radio"/> | <input type="radio"/> | <input type="radio"/> | <input type="radio"/> | <input type="radio"/> | <input type="radio"/> | <input type="radio"/> | <input type="radio"/> | <input type="radio"/> | <input type="radio"/> | <input type="radio"/> | <input type="radio"/> | |
| Port Settings | | - | - | - | - | - | - | - | - | - | - | - | - | - | - | - | - | - | - | - | - | - | - | - | - | - | |
| Tag | | - | - | - | - | - | - | - | - | - | - | - | - | - | - | - | - | - | - | - | - | - | - | - | - | - | |
| None | | - | - | - | - | - | - | - | - | - | - | - | - | - | - | - | - | - | - | - | - | - | - | - | - | - | |
| Egress | | - | - | - | - | - | - | - | - | - | - | - | - | - | - | - | - | - | - | - | - | - | - | - | - | - | |
| Forbidden | | - | - | - | - | - | - | - | - | - | - | - | - | - | - | - | - | - | - | - | - | - | - | - | - | - | |
| Apply | | | | | | | | | | | | | | | | | | | | | | | | | | | |
| Show All Static VLAN Entries | | | | | | | | | | | | | | | | | | | | | | | | | | | |

Figure 7- 6. Static VLAN window - Add

To return to the **Current Static VLAN Entries** window, click the [Show All Static VLAN Entries](#) link. To change an existing 802.1Q VLAN entry, click the corresponding **Modify** button, a new window will appear which will allow the user to configure the port settings and assign a unique name and number to the new VLAN.



NOTE: The Switch supports up to 4k static VLAN entries.



NOTE: When the PVID Auto Assign function is disabled, users must manually configure the PVID for untagged ports or the host may not connect to the Switch correctly.

The following fields can then be set in either the **Add** or **Modify** 802.1Q Static VLANs windows:

| Parameter | Description |
|---|--|
| Unit | Select the unit you wish to configure. |
| VID (VLAN ID) | Allows the entry of a VLAN ID in the Add window, or displays the VLAN ID of an existing VLAN in the Modify window. VLANs can be identified by either the VID or the VLAN name. |
| VLAN Name | Allows the entry of a name for the new VLAN in the Add window, or displays the VLAN name in the Modify window. |
| Advertisement | Enabling this function will allow the Switch to send out GVRP packets to outside sources, notifying that they may join the existing VLAN. |
| Port Settings - Allows an individual port to be specified as member of a VLAN. | |
| Tag | Specifies the port as either 802.1Q tagging or 802.1Q untagged. Checking the box will designate the port as Tagged. |
| None | Allows an individual port to be specified as a non-VLAN member. |
| Egress | Select this to specify the port as a static member of the VLAN. Egress member ports are ports that will be transmitting traffic for the VLAN. These ports can be either tagged or untagged. |
| Forbidden | Select this to specify the port as not being a member of the VLAN and that the port is forbidden from becoming a member of the VLAN dynamically. |

Click **Apply** to implement changes made.

GVRP Settings

This window allows you to determine whether the Switch will share its VLAN configuration information with other GARP VLAN Registration Protocol (GVRP) enabled switches. In addition, Ingress Checking can be used to limit traffic by filtering incoming packets whose VID does not match the PVID of the port. Results can be seen in the table under the configuration settings, as seen below.

To view this window, click **L2 Features > VLAN > GVRP Settings**, as shown below.

GVRP Settings

| Unit | From | To | GVRP | Ingress Check | Acceptable Frame Type | PVID | Apply |
|------|--------|--------|----------|---------------|-----------------------|------|-------|
| 1 | Port 1 | Port 1 | Disabled | Enabled | Admit All | | Apply |

GVRP Table

| Port | PVID | GVRP | Ingress Check | Acceptable Frame Type |
|------|------|----------|---------------|-----------------------|
| 1 | 1 | Disabled | Enabled | All Frames |
| 2 | 1 | Disabled | Enabled | All Frames |
| 3 | 1 | Disabled | Enabled | All Frames |
| 4 | 1 | Disabled | Enabled | All Frames |
| 5 | 1 | Disabled | Enabled | All Frames |
| 6 | 1 | Disabled | Enabled | All Frames |
| 7 | 1 | Disabled | Enabled | All Frames |
| 8 | 1 | Disabled | Enabled | All Frames |
| 9 | 1 | Disabled | Enabled | All Frames |
| 10 | 1 | Disabled | Enabled | All Frames |
| 11 | 3 | Disabled | Enabled | All Frames |
| 12 | 1 | Disabled | Enabled | All Frames |
| 13 | 1 | Disabled | Enabled | All Frames |
| 14 | 1 | Disabled | Enabled | All Frames |
| 15 | 1 | Disabled | Enabled | All Frames |
| 16 | 1 | Disabled | Enabled | All Frames |
| 17 | 1 | Disabled | Enabled | All Frames |
| 18 | 1 | Disabled | Enabled | All Frames |
| 19 | 1 | Disabled | Enabled | All Frames |
| 20 | 1 | Disabled | Enabled | All Frames |
| 21 | 1 | Disabled | Enabled | All Frames |
| 22 | 1 | Disabled | Enabled | All Frames |
| 23 | 1 | Disabled | Enabled | All Frames |
| 24 | 1 | Disabled | Enabled | All Frames |
| 25 | 1 | Disabled | Enabled | All Frames |

Figure 7- 7. GVRP Settings window

The following parameters may be configured.

| Parameter | Description |
|-------------|-------------------------------|
| Unit | Select you wish to configure. |

| | |
|------------------------------|--|
| From...To | These two fields allow you to specify the range of ports that will be included in the Port-based VLAN that you are creating using the 802.1Q Port Settings window. |
| PVID | The read-only field in the 802.1Q Port Table shows the current PVID assignment for each port, which may be manually assigned to a VLAN when created in the 802.1Q Port Settings table. The Switch's default is to assign all ports to the default VLAN with a VID of 1. The PVID is used by the port to tag outgoing, untagged packets, and to make filtering decisions about incoming packets. If the port is specified to accept only tagged frames - and the tagging packet is forwarded to the port for transmission, then the untagged packets will be dropped. When the packet arrives at its destination, the receiving device will use the PVID to make VLAN forwarding decisions. If the port receives a packet, and Ingress filtering is enabled, the port will compare the VID of the incoming packet to its PVID. If the two are unequal, the port will drop the packet. If the two are equal, the port will receive the packet. |
| GVRP | The GARP VLAN Registration Protocol (GVRP) enables the port to dynamically become a member of a VLAN. GVRP is <i>Disabled</i> by default. |
| Ingress Check | This field can be toggled using the space bar between <i>Enabled</i> and <i>Disabled</i> . <i>Enabled</i> enables the port to compare the VID tag of an incoming packet with the PVID number assigned to the port. If the two are different, the port filters (drops) the packet. <i>Disabled</i> disables ingress filtering. Ingress Checking is <i>Enabled</i> by default. |
| Acceptable Frame Type | This field denotes the type of frame that will be accepted by the port. The user may choose between <i>Tagged Only</i> , which means only VLAN tagged frames will be accepted, and <i>Admit_All</i> , which mean both tagged and untagged frames will be accepted. <i>Admit_All</i> is enabled by default. |

Click **Apply** to implement changes made.

Double VLAN

Double or Q-in-Q VLANs allow network providers to expand their VLAN configurations to place customer VLANs within a larger inclusive VLAN, which adds a new layer to the VLAN configuration. This basically lets large ISP's create L2 Virtual Private Networks and also create transparent LANs for their customers, which will connect two or more customer LAN points without over-complicating configurations on the client's side. Not only will over-complication be avoided, but also now the administrator has over 4000 VLANs in which over 4000 VLANs can be placed, therefore greatly expanding the VLAN network and enabling greater support of customers utilizing multiple VLANs on the network.

Double VLANs are basically VLAN tags placed within existing IEEE 802.1Q VLANs which we will call SPVIDs (Service Provider VLAN IDs). These VLANs are marked by a TPID (Tagged Protocol ID), configured in hex form to be encapsulated within the VLAN tag of the packet. This identifies the packet as double-tagged and segregates it from other VLANs on the network, therefore creating a hierarchy of VLANs within a single packet.

Here is an example Double VLAN tagged packet.

| Destination Address | Source Address | SPVLAN (TPID + Service Provider VLAN Tag) | 802.1Q CEVLAN Tag (TPID + Customer VLAN Tag) | Ether Type | Payload |
|---------------------|----------------|---|--|------------|---------|
|---------------------|----------------|---|--|------------|---------|

Consider the example below:

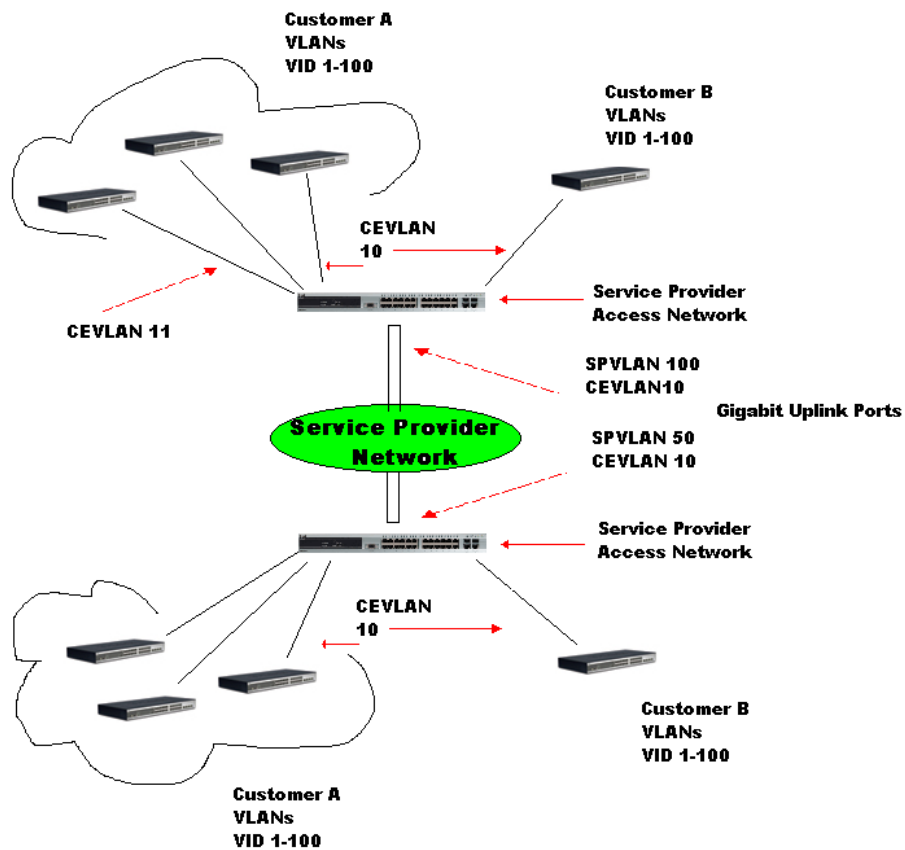

Figure 7- 8. Double VLAN Example

In this example, the Service Provider Access Network switch (Provider edge switch) is the device creating and configuring Double VLANs. Both CEVLANS (Customer VLANs), 10 and 11, are tagged with the SPVID 100 on the Service Provider Access Network and therefore belong to one VLAN on the Service Provider’s network, thus being a member of two VLANs. In this way, the Customer can retain its normal VLAN and the Service Provider can congregate multiple Customer VLANs within one SPVLAN, thus greatly regulating traffic and routing on the Service Provider switch. This information is then routed to the Service Provider’s main network and regarded there as one VLAN, with one set of protocols and one routing behavior.

Regulations for Double VLANs

Some rules and regulations apply with the implementation of the Double VLAN procedure.

1. All ports must be configured for the SPVID and its corresponding TPID on the Service Provider's edge switch.
2. All ports must be configured as Access Ports or Uplink ports. Access ports can only be Ethernet ports while Uplink ports must be Gigabit ports.
3. Provider Edge switches must allow frames of at least 1522 bytes or more, due to the addition of the SPVID tag.
4. Access Ports must be an un-tagged port of the service provider VLANs. Uplink Ports must be a tagged port of the service provider VLANs.
5. The switch cannot have both double and normal VLANs co-existing. Once the change of VLAN is made, all Access Control lists are cleared and must be reconfigured.
6. Once Double VLANs are enabled, GVRP must be disabled.
7. All packets sent from the CPU to the Access ports must be untagged.
8. The following functions will not operate when the switch is in Double VLAN mode:
 - Guest VLANs
 - Web-based Access Control
 - IP Multicast Routing
 - GVRP
 - All Regular 802.1Q VLAN functions

Double VLAN Settings

This window is used to enable the double VLAN settings on the Switch.

To view this window, click **L2 Features > VLAN > Double VLAN**, as shown below.



Figure 7- 9. Double VLAN State Settings window

Choose *Enabled* using the pull-down menu and click **Apply**. The user will be prompted with the following warning window. Click **OK** to continue.

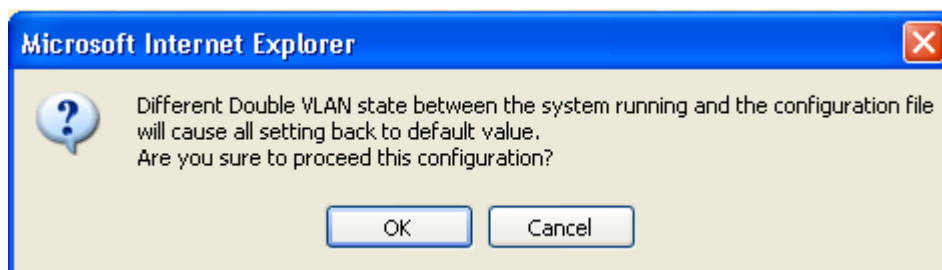

After being prompted with a success message, the user will be presented with this window to configure for Double VLANs.

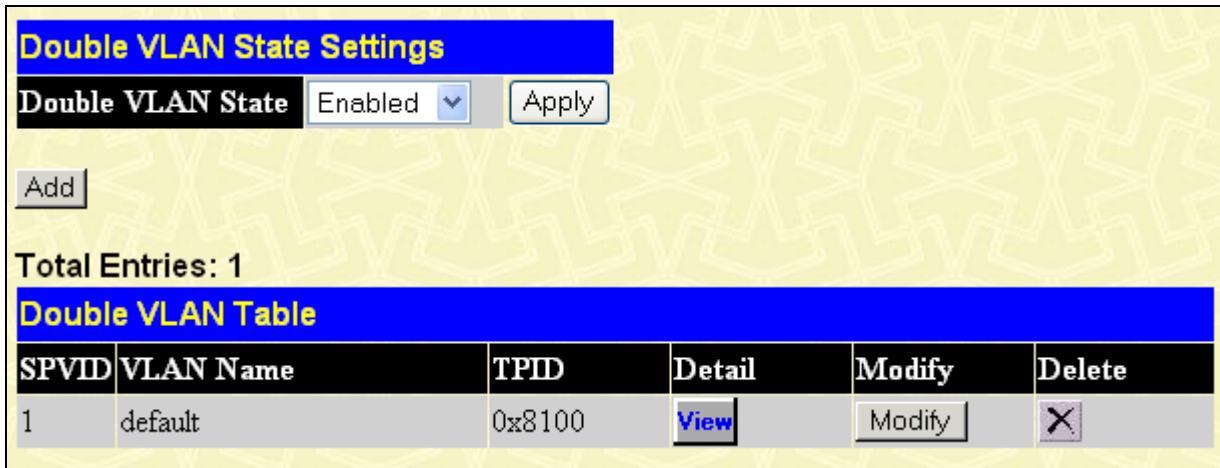



Figure 7- 10. Double VLAN State Settings window (Enabled)

Parameters shown in the previous window are explained below:

| Parameter | Description |
|--------------------------|--|
| Double VLAN State | Use the pull-down menu to enable or disable the Double VLAN function on this Switch. Enabling the Double VLAN will return all previous VLAN configurations to the factory default settings and remove Static VLAN configurations from the GUI. |
| SPVID | The VLAN ID number of this potential Service Provider VLAN. |
| VLAN Name | The name of the VLAN on the Switch. |
| TPID | The tagged protocol ID of the corresponding VLAN that will be used in identification of this potential Double VLAN, written in hex form. |

The user may view configurations for a Double VLAN by clicking its corresponding  button, which will display the following read-only window.

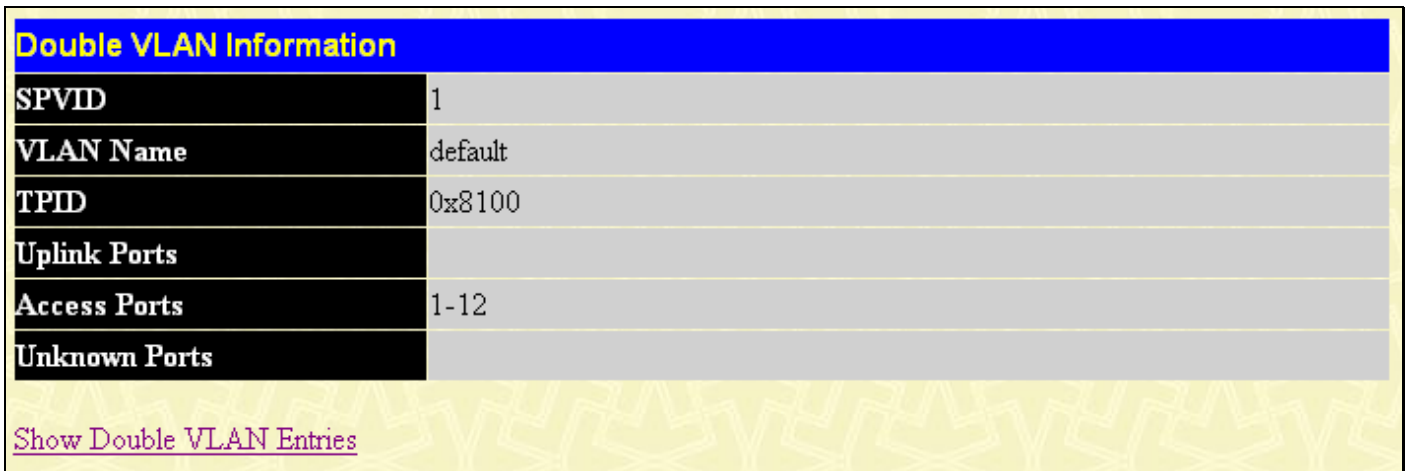

Figure 7- 11. Double VLAN Information window

Parameters shown in the previous window are explained below:

| Parameter | Description |
|---------------------|---|
| SPVID | The VLAN ID number of this potential Service Provider VLAN. |
| VLAN Name | The name of the VLAN on the Switch. |
| TPID | The tagged protocol ID of the corresponding VLAN that will be used in identification of this potential Double VLAN, written in hex form. |
| Uplink Ports | These ports are set as uplink ports on the Switch. Uplink ports are for connecting Switch VLANs to the Service Provider VLANs on a remote source. Only gigabit ports can be configured as uplink ports. |

| | |
|----------------------|---|
| Access Ports | These are the ports that are set as access ports on the Switch. Access ports are for connecting Switch VLANs to customer VLANs. Gigabit ports cannot be configured as access ports. |
| Unknown Ports | These are the ports that are a part of the VLAN but have yet to be defined as Access or Uplink ports. |

To create a Double VLAN, click the **Add** button, revealing the following window for the user to configure.

Figure 7- 12. Double VLAN Creation window

To create a Double VLAN, enter the following parameters and click **Apply**.

| Parameter | Description |
|------------------|--|
| VLAN Name | Enter the pre-configured VLAN name to create as a Double VLAN. |
| SPVID | Enter the VID for the Service Provider VLAN with an integer between 1 and 4094. |
| TPID | Enter the TPID in hex form to aid in packet identification of the Service Provider VLAN. |

Click **Apply** to implement changes made.

To configure the parameters for a previously created Service Provider VLAN, click the **Modify** button of the corresponding SPVID in the Double VLAN Table. The following window will appear for the user to configure.

Figure 7- 13. Double VLAN Configuration window

To configure a Double VLAN, enter the following parameters and click **Apply**.

| Parameter | Description |
|--------------------------|--|
| VLAN Name | The name of the pre-configured VLAN name to be configured. |
| TPID (0x0-0xffff) | The tagged protocol ID. Enter the new TPID in hex form to aid in packet identification of the Service Provider VLAN. |
| Operation | Allows one of the following three acts to be performed: <i>Add Ports</i> – Will allow users to add ports to this Service Provider VLAN using the Port List field below. |

| | |
|------------------|--|
| | <p><i>Delete Ports</i> – Will allow users to remove ports from the Service Provider VLAN configured, using the Port List field below.</p> <p><i>Config TPID</i> – Will allow users to configure the Tagged Protocol ID of the Service Provider VLAN, in hex form.</p> |
| Port Type | <p>Allows the user to choose the type of port being utilized by the Service Provider VLAN. The user may choose:</p> <p><i>Access</i> - Access ports are for connecting Switch VLANs to customer VLANs. Gigabit ports cannot be configured as access ports.</p> <p><i>Uplink</i> - Uplink ports are for connecting Switch VLANs to the Provider VLANs on a remote source. Only gigabit ports can be configured as uplink ports.</p> |
| Port List | <p>Use the From and To fields to set a list of ports to be placed in, or removed from, the Service Provider VLAN. The beginning and end of the port list range are separated by a dash.</p> |

PVID Auto Assign

This enables the PVID Auto Assign features on the switch.

To view this table, click **L2 Features > VLAN > PVID Auto Assign**, as shown below.

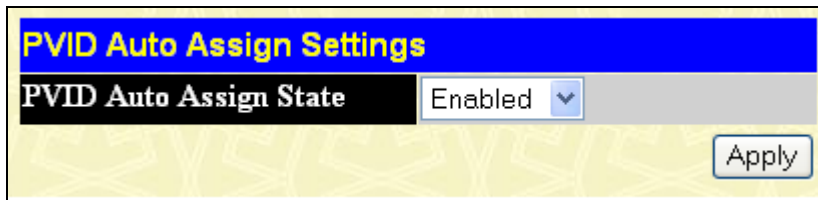

Figure 7- 14. PVID Auto Assign Settings window

When *Enabled*, PVID will be automatically assigned when adding a port to a VLAN as an untagged member port.

MAC-based VLAN Settings

This table is used to create MAC-based VLAN entries on the switch. A MAC Address can be mapped to any existing static VLAN and multiple MAC addresses can be mapped to the same VLAN. When a static MAC-based VLAN entry is created for a user, the traffic from this user is able to be serviced under the specified VLAN regardless of the authentication function operated on the port.

To view this window, click **L2 Features > VLAN > MAC-based VLAN Settings**, as shown below.

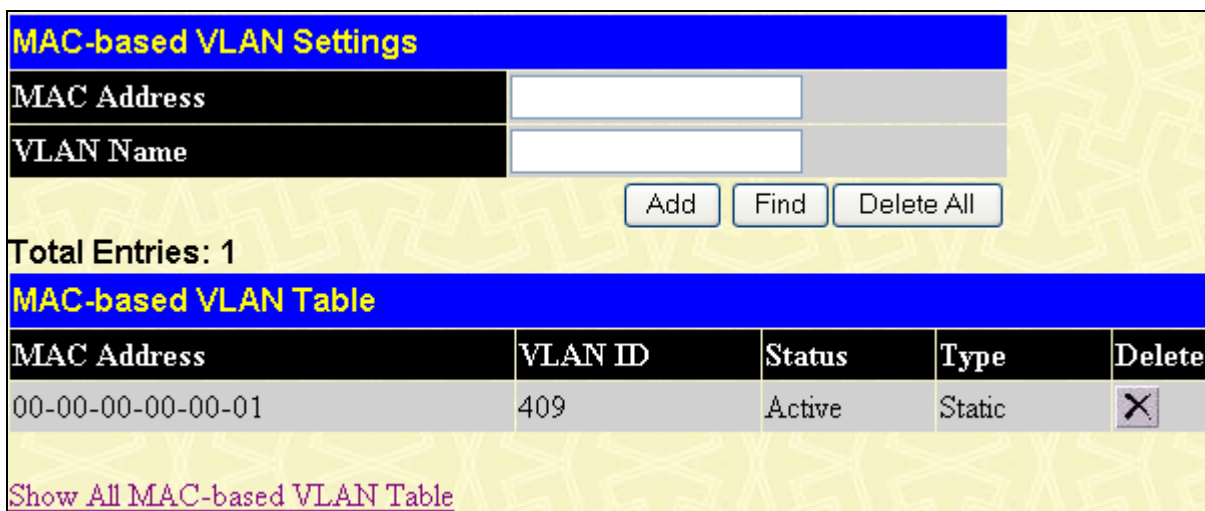

Figure 7- 15. MAC-based VLAN Settings window

The following parameters can be configured

| Parameter | Description |
|--------------------|--|
| MAC Address | Specifies the MAC Address of the entry you wish to Add or Find . |
| VLAN Name | Specifies the VLAN to be associated with the MAC Address. |

To delete a specific entry click the corresponding  button, to clear all entries click **Delete All**.

Protocol VLAN

The Switch incorporates the idea of protocol-based VLANs. This standard, defined by the IEEE 802.1v standard maps packets to protocol-defined VLANs by examining the type octet within the packet header to discover the type of protocol associated with it. After assessing the protocol, the Switch will forward the packets to all ports within the protocol-assigned VLAN. This feature will benefit the administrator by better balancing load sharing and enhancing traffic classification. The Switch supports fourteen pre-defined protocols for configuration. The user can define a protocol by properly configuring the protocol value.

The following is a list of protocol values for some common protocols.

| Protocol | Type Header in Hexadecimal Form |
|--------------------|---------------------------------|
| IP over Ethernet | 0x0800 |
| IPX 802.3 | 0xFFFF |
| IPX 802.2 | 0xE0E0 |
| IPX SNAP | 0x8137 |
| IPX over Ethernet2 | 0x8137 |
| decLAT | 0x6004 |
| SNA 802.2 | 0x0404 |
| netBios | 0xF0F0 |
| XNS | 0x0600 |
| VINES | 0x0BAD |
| IPV6 | 0x86DD |
| AppleTalk | 0x809B |
| RARP | 0x8035 |
| SNA over Ethernet2 | 0x80D5 |

Table 7- 1. Protocol VLAN and the corresponding protocol value

The following windows are used to create Protocol VLAN groups on the switch. The purpose of these Protocol VLAN groups is to identify ingress untagged packets and quickly and accurately send them to their destination. Ingress untagged packets can be identified by a protocol value in the packet header, which has been stated here by the user. Once identified, these packets can be tagged with the appropriate tags for VLAN and priority and then relayed to their destination.

To achieve this goal, users must first properly set the type of protocol, along with the identifying value located in the packet header and apply it to a protocol group, which is identified by an ID number. Once the group has been created and configured, then users must add it to a port or set of ports using the **Protocol VLAN Port Settings** window, and configure the appropriate VLAN and priority tags for these untagged packets. When these actions are completed and saved to the switch, then the ingress and untagged packets can be appropriately dealt with and forwarded through the switch.

Protocol VLAN Group Settings

This window is used to begin the Protocol Group VLAN configurations.

To view this window, click **L2 Features > VLAN > Protocol VLAN > Protocol VLAN Group Settings**, as shown below.

Figure 7- 16. Protocol VLAN Group Settings window

Click the **Add** button to reveal the following window for the user to configure:

Figure 7- 17. Protocol VLAN Group – Add window

The Add and Modify windows of the **Protocol VLAN Group** hold the following fields to be configured:

| Parameter | Description |
|------------------------|--|
| Group ID (1-16) | Enter an integer from 1 to 16 to identify the protocol VLAN group being created here. For the Modify window, this field will display the Protocol Group ID number of the group being configured. |
| Action | Use the pull-down menu to add or delete the protocol to this group. This protocol is identified using the following Protocol field. |
| Protocol | Use the pull-down menu to select the frame type to be added or deleted from this profile. The frame type indicates the frame format. The user has three choices for frame type: <ul style="list-style-type: none"> • <i>Ethernet II</i> – Choose this parameter if you wish this protocol group to employ the Ethernet II frame type. In this frame type, the protocol is identified by the 16-bit (2 octet) IEEE802.3 type field in the packet header, which is to be stated using the following Protocol Value. • <i>IEEE802.3 SNAP</i> – Choose this parameter if you wish this protocol group to employ the Sub Network Access Protocol (SNAP) frame type. For this frame type, the protocol is identified by the 16-bit (2 octet) IEEE802.3 type field in the packet header, which is to be stated using the following Protocol Value. • <i>IEEE802.3 LLC</i> – Choose this parameter if you wish this protocol group to employ the Link Logical Control (LLC) frame type. For this frame type, the protocol is identified by the 2-octet IEEE802.3 Link Service Access Point (LSAP) pair field in the packet header, which is to be stated using the following Protocol Value. The first octet defines the Destination Service Access Point value and the second octet is the Source Service Access Point (SSAP) value. |
| Protocol Value | Enter the corresponding protocol value of the protocol identified in the previous field. This value must be stated in a hexadecimal form. |

Click **Apply** to implement changes made.

Protocol VLAN Port Settings

The following window is used to add a Protocol VLAN Group profile to a port or list of ports and adjust the tags for incoming untagged packets before being relayed through the Switch.

To view this window, click **L2 Features > VLAN > Protocol VLAN > Protocol VLAN Port Settings**, as shown below.

Figure 7- 18. Protocol VLAN Port Settings window

The following fields may be configured:

| Parameter | Description |
|----------------------------|--|
| Port List | Use this parameter to assign ports to a Protocol VLAN Group or remove them from the Protocol VLAN Group. Ticking the Select All Ports check box will configure this Protocol VLAN Group to all ports on the switch. |
| Action | Use the pull-down menu to add or delete the following Group ID to or from the ports selected in the previous field. |
| Group ID (1-16) | Enter the ID number of the Protocol VLAN Group for which to add or remove from the selected ports. Ticking the Select All Groups check box will apply all Protocol VLAN groups to the ports listed in the Port List field. |
| VLAN ID / VLAN Name | Use this field to add a VLAN to be associated with this configuration. Select the correct radio button if you are using a VLAN Name or a VID (VLAN ID). |

Click **Apply** to implement changes made. The Protocol VLAN Port Table in the bottom half of the window will display correctly configured ports to Protocol Group configurations, along with associated VLANs and priorities. Users may use the Port List Search in the middle of the window to display configurations based on ports on the switch. Clicking the [Show All Protocol VLAN Port Table Entries](#) link will display all Protocol VLAN Port Table entries.

Trunking

Understanding Port Trunk Groups

Port trunk groups are used to combine a number of ports together to make a single high-bandwidth data pipeline. The Switch supports this function on all its 10/100/1000 Ethernet Ports and on all its 10G interfaces. The 10/100/1000 ports support up to 32 port trunk groups with 2 to 8 ports in each group. A potential bit rate of 8000 Mbps can be achieved when using the 10/100/1000Mbps Ethernet ports. The 10G interfaces also support port trunk groups with 2 interfaces in each group.

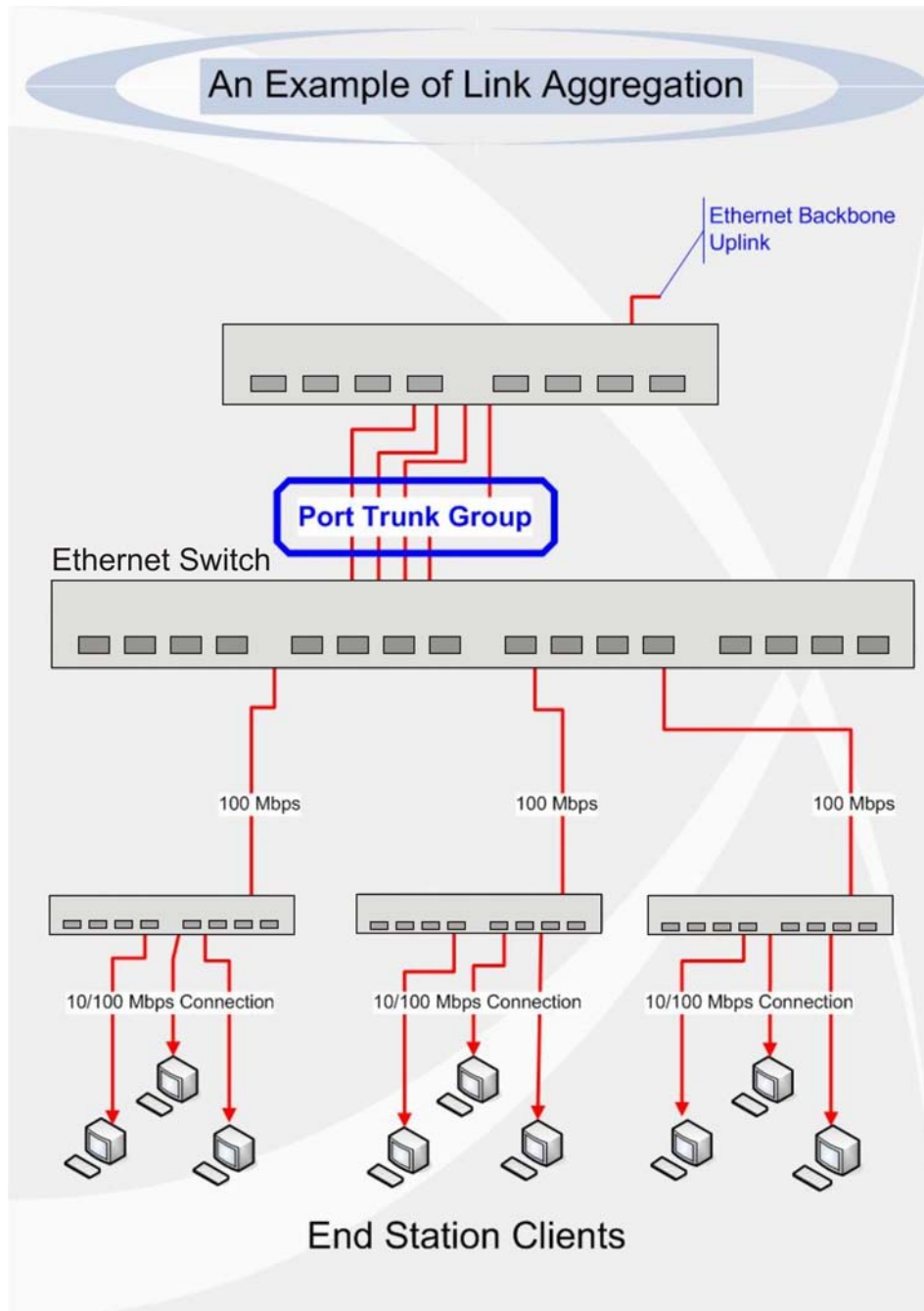

Figure 7- 19. Example of Port Trunk Group

The Switch treats all ports in a trunk group as a single port. Data transmitted to a specific host (destination address) will always be transmitted over the same port in a trunk group. This allows packets in a data stream to arrive in the same order they were sent.



NOTE: If any ports within the trunk group become disconnected, packets intended for the disconnected port will be load shared among the other linked ports of the link aggregation group.

Link aggregation allows several ports to be grouped together and to act as a single link. This gives a bandwidth that is a multiple of a single link's bandwidth.

Link aggregation is most commonly used to link a bandwidth intensive network device or devices, such as a server, to the backbone of a network.

The Switch allows the creation of up to 32 link aggregation groups, each group consisting of two to eight links (ports). All of the ports in the group must be members of the same VLAN, and their STP status, static multicast, traffic control, traffic segmentation, port bandwidth and 802.1p default priority configurations must be identical. Port security, port mirroring and 802.1X must not be enabled on the trunk group. Further, the aggregated links must all be of the same speed when in the LACP state and should be configured as full duplex.

The Master Port of the group is to be configured by the user, and all configuration options, including the VLAN configuration that can be applied to the Master Port, are applied to the entire link aggregation group.

Load balancing is automatically applied to the ports in the aggregated group, and a link failure within the group causes the network traffic to be directed to the remaining links in the group.

The Spanning Tree Protocol will treat a link aggregation group as a single link, on the switch level. On the port level, the STP will use the port parameters of the Master Port in the calculation of port cost and in determining the state of the link aggregation group. If two redundant link aggregation groups are configured on the Switch, STP will block one entire group; in the same way STP will block a single port that has a redundant link.

Link Aggregation

This table is used to configure port trunking on the switch.

To view this table, click **L2 Features > Trunking > Link Aggregation**, as shown below.

| Link Aggregation Group Entries | | | | |
|--------------------------------|-------|-------|--------|--------|
| Group ID | State | Ports | Modify | Delete |
| Total Entries: 0 | | | | |

Figure 7- 20. Link Aggregation Group Entries window

To configure port trunk groups, add a new trunk group and use the **Link Aggregation Group Configuration** window (see example below). To modify a port trunk group, click the Hyperlinked Group ID. To delete a port trunk group, click the corresponding  under the Delete heading in the **Link Aggregation Group Entries** window.

Link Aggregation Group Configuration

| Group ID | <input type="text"/> | | | | | | | | | | | | | | | | | | | | | | | | | | | | | | | | | | | | | | | | | | | | | | | | | | | | | | | | | | | | | | | | | | | | | | | | | | | | | | | | | | | | | | | | | | | | | | | | | | | | |
|--------------------------------------|--|--------------------------|--------------------------|--------------------------|--------------------------|--------------------------|--------------------------|--------------------------|--------------------------|--------------------------|--------------------------|--------------------------|--------------------------|--------------------------|--------------------------|--------------------------|--------------------------|--------------------------|--------------------------|--------------------------|--------------------------|--------------------------|--------------------------|--------------------------|--------------------------|----|--------------------------|--------------------------|--------------------------|--------------------------|--------------------------|--------------------------|--------------------------|--------------------------|--------------------------|--------------------------|--------------------------|--------------------------|--------------------------|--------------------------|--------------------------|--------------------------|--------------------------|--------------------------|--------------------------|--------------------------|--------------------------|--------------------------|--------------------------|--------------------------|--------------------------|---|---|---|---|---|---|---|---|---|---|---|---|---|---|---|---|---|---|---|---|---|---|---|---|---|---|---|---|---|---|---|---|---|---|---|---|---|---|---|---|---|---|---|---|---|---|---|---|---|---|
| Type | LACP ▾ | | | | | | | | | | | | | | | | | | | | | | | | | | | | | | | | | | | | | | | | | | | | | | | | | | | | | | | | | | | | | | | | | | | | | | | | | | | | | | | | | | | | | | | | | | | | | | | | | | | | |
| State | Disabled ▾ | | | | | | | | | | | | | | | | | | | | | | | | | | | | | | | | | | | | | | | | | | | | | | | | | | | | | | | | | | | | | | | | | | | | | | | | | | | | | | | | | | | | | | | | | | | | | | | | | | | | |
| Master Port | 1 ▾ Port 1 ▾ | | | | | | | | | | | | | | | | | | | | | | | | | | | | | | | | | | | | | | | | | | | | | | | | | | | | | | | | | | | | | | | | | | | | | | | | | | | | | | | | | | | | | | | | | | | | | | | | | | | | |
| Unit | 1 ▾ | | | | | | | | | | | | | | | | | | | | | | | | | | | | | | | | | | | | | | | | | | | | | | | | | | | | | | | | | | | | | | | | | | | | | | | | | | | | | | | | | | | | | | | | | | | | | | | | | | | | |
| Member Ports | <table border="1" style="width: 100%; text-align: center; border-collapse: collapse;"> <tr> <th>1</th><th>2</th><th>3</th><th>4</th><th>5</th><th>6</th><th>7</th><th>8</th><th>9</th><th>10</th><th>11</th><th>12</th><th>13</th><th>14</th><th>15</th><th>16</th><th>17</th><th>18</th><th>19</th><th>20</th><th>21</th><th>22</th><th>23</th><th>24</th><th>25</th> </tr> <tr> <td><input type="checkbox"/></td><td><input type="checkbox"/></td><td><input type="checkbox"/></td><td><input type="checkbox"/></td><td><input type="checkbox"/></td><td><input type="checkbox"/></td><td><input type="checkbox"/></td><td><input type="checkbox"/></td><td><input type="checkbox"/></td><td><input type="checkbox"/></td><td><input type="checkbox"/></td><td><input type="checkbox"/></td><td><input type="checkbox"/></td><td><input type="checkbox"/></td><td><input type="checkbox"/></td><td><input type="checkbox"/></td><td><input type="checkbox"/></td><td><input type="checkbox"/></td><td><input type="checkbox"/></td><td><input type="checkbox"/></td><td><input type="checkbox"/></td><td><input type="checkbox"/></td><td><input type="checkbox"/></td><td><input type="checkbox"/></td><td><input type="checkbox"/></td> </tr> <tr> <td>-</td><td>-</td><td>-</td><td>-</td><td>-</td><td>-</td><td>-</td><td>-</td><td>-</td><td>-</td><td>-</td><td>-</td><td>-</td><td>-</td><td>-</td><td>-</td><td>-</td><td>-</td><td>-</td><td>-</td><td>-</td><td>-</td><td>-</td><td>-</td><td>-</td> </tr> <tr> <td>-</td><td>-</td><td>-</td><td>-</td><td>-</td><td>-</td><td>-</td><td>-</td><td>-</td><td>-</td><td>-</td><td>-</td><td>-</td><td>-</td><td>-</td><td>-</td><td>-</td><td>-</td><td>-</td><td>-</td><td>-</td><td>-</td><td>-</td><td>-</td><td>-</td> </tr> </table> | 1 | 2 | 3 | 4 | 5 | 6 | 7 | 8 | 9 | 10 | 11 | 12 | 13 | 14 | 15 | 16 | 17 | 18 | 19 | 20 | 21 | 22 | 23 | 24 | 25 | <input type="checkbox"/> | <input type="checkbox"/> | <input type="checkbox"/> | <input type="checkbox"/> | <input type="checkbox"/> | <input type="checkbox"/> | <input type="checkbox"/> | <input type="checkbox"/> | <input type="checkbox"/> | <input type="checkbox"/> | <input type="checkbox"/> | <input type="checkbox"/> | <input type="checkbox"/> | <input type="checkbox"/> | <input type="checkbox"/> | <input type="checkbox"/> | <input type="checkbox"/> | <input type="checkbox"/> | <input type="checkbox"/> | <input type="checkbox"/> | <input type="checkbox"/> | <input type="checkbox"/> | <input type="checkbox"/> | <input type="checkbox"/> | <input type="checkbox"/> | - | - | - | - | - | - | - | - | - | - | - | - | - | - | - | - | - | - | - | - | - | - | - | - | - | - | - | - | - | - | - | - | - | - | - | - | - | - | - | - | - | - | - | - | - | - | - | - | - | - |
| | 1 | 2 | 3 | 4 | 5 | 6 | 7 | 8 | 9 | 10 | 11 | 12 | 13 | 14 | 15 | 16 | 17 | 18 | 19 | 20 | 21 | 22 | 23 | 24 | 25 | | | | | | | | | | | | | | | | | | | | | | | | | | | | | | | | | | | | | | | | | | | | | | | | | | | | | | | | | | | | | | | | | | | | | | | | | | | | |
| | <input type="checkbox"/> | <input type="checkbox"/> | <input type="checkbox"/> | <input type="checkbox"/> | <input type="checkbox"/> | <input type="checkbox"/> | <input type="checkbox"/> | <input type="checkbox"/> | <input type="checkbox"/> | <input type="checkbox"/> | <input type="checkbox"/> | <input type="checkbox"/> | <input type="checkbox"/> | <input type="checkbox"/> | <input type="checkbox"/> | <input type="checkbox"/> | <input type="checkbox"/> | <input type="checkbox"/> | <input type="checkbox"/> | <input type="checkbox"/> | <input type="checkbox"/> | <input type="checkbox"/> | <input type="checkbox"/> | <input type="checkbox"/> | <input type="checkbox"/> | | | | | | | | | | | | | | | | | | | | | | | | | | | | | | | | | | | | | | | | | | | | | | | | | | | | | | | | | | | | | | | | | | | | | | | | | | | | |
| - | - | - | - | - | - | - | - | - | - | - | - | - | - | - | - | - | - | - | - | - | - | - | - | - | | | | | | | | | | | | | | | | | | | | | | | | | | | | | | | | | | | | | | | | | | | | | | | | | | | | | | | | | | | | | | | | | | | | | | | | | | | | | |
| - | - | - | - | - | - | - | - | - | - | - | - | - | - | - | - | - | - | - | - | - | - | - | - | - | | | | | | | | | | | | | | | | | | | | | | | | | | | | | | | | | | | | | | | | | | | | | | | | | | | | | | | | | | | | | | | | | | | | | | | | | | | | | |
| Flooding Port | <input checked="" type="checkbox"/> | | | | | | | | | | | | | | | | | | | | | | | | | | | | | | | | | | | | | | | | | | | | | | | | | | | | | | | | | | | | | | | | | | | | | | | | | | | | | | | | | | | | | | | | | | | | | | | | | | | | |
| <input type="button" value="Apply"/> | | | | | | | | | | | | | | | | | | | | | | | | | | | | | | | | | | | | | | | | | | | | | | | | | | | | | | | | | | | | | | | | | | | | | | | | | | | | | | | | | | | | | | | | | | | | | | | | | | | | | |

Note(1): It is only valid to set up at most 8 member ports of any one trunk group and a port can be a member of only one trunk group at a time.

[Show All Link Aggregation Group Entries](#)

Figure 7- 21. Link Aggregation Group Configuration window

The user-changeable parameters are as follows:

| Parameter | Description |
|----------------------|---|
| Group ID | Select an ID number for the group, between 1 and 32. |
| Type | This pull-down menu allows you to select between <i>Static</i> and <i>LACP</i> (Link Aggregation Control Protocol). LACP allows for the automatic detection of links in a Port Trunking Group. |
| State | Trunk groups can be toggled between <i>Enabled</i> and <i>Disabled</i> . This is used to turn a port trunking group on or off. This is useful for diagnostics, to quickly isolate a bandwidth intensive network device or to have an absolute backup aggregation group that is not under automatic control. |
| Master Port | Choose the Master Port for the trunk group using the pull-down menu. |
| Unit | Select the unit you wish to configure. |
| Member Ports | Choose the members of a trunked group. Up to eight ports per group can be assigned to a group. |
| Flooding Port | A trunking group must designate one port to allow transmission of broadcasts and unknown unicasts. |

After setting the parameters, click **Apply** to allow changes to be implemented. Successfully created trunk groups will be shown in the **Link Aggregation Group Entries** table.

LACP Port Settings

This window is used in conjunction with the **Link Aggregation** window to create port trunking groups on the Switch. The user may set which ports will be active and passive in processing and sending LACP control frames.

To view this window, click **L2 Features > Trunking > LACP Port Settings**, as shown.

The user may set the following parameters:

| Parameter | Description |
|------------------|---|
| Unit | Select the unit you wish to configure. |
| From...To | A consecutive group of ports may be configured starting with the selected port. |
| Mode | <p><i>Active</i> - Active LACP ports are capable of processing and sending LACP control frames. This allows LACP compliant devices to negotiate the aggregated link so the group may be changed dynamically as needs require. In order to utilize the ability to change an aggregated port group, that is, to add or subtract ports from the group, at least one of the participating devices must designate LACP ports as active. Both devices must support LACP.</p> <p><i>Passive</i> - LACP ports that are designated as passive cannot initially send LACP control frames. In order to allow the linked port group to negotiate adjustments and make changes dynamically, one end of the connection must have "active" LACP ports (see above).</p> |

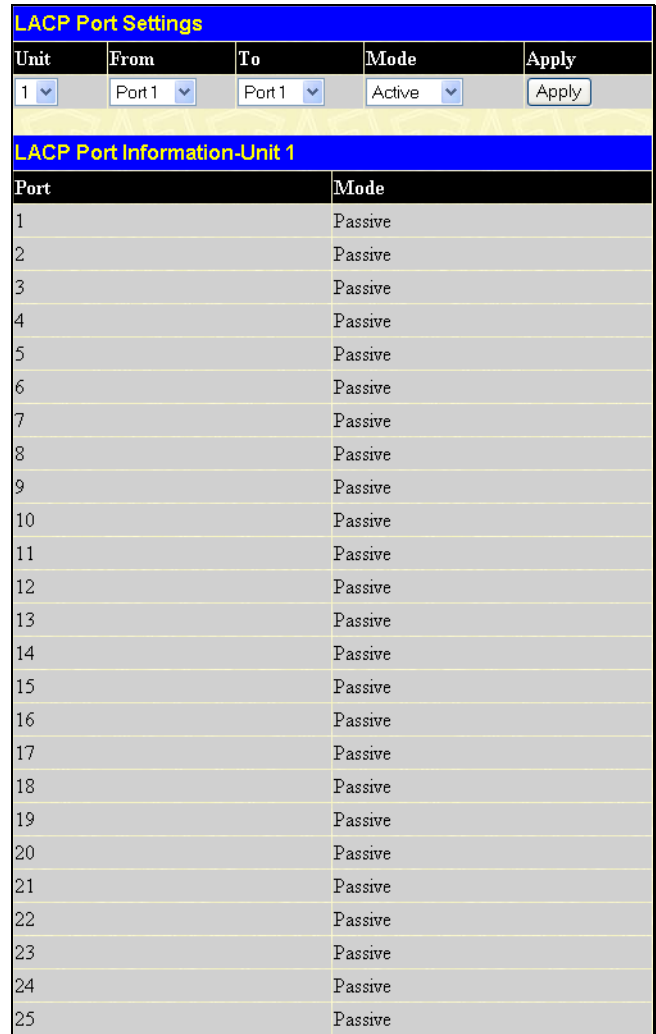

Figure 7- 22. LACP Port Settings window

After setting the previous parameters, click **Apply** to allow your changes to be implemented.

IGMP Snooping

Internet Group Management Protocol (IGMP) snooping allows the Switch to recognize IGMP queries and reports sent between network stations or devices and an IGMP host. When enabled for IGMP snooping, the Switch can open or close a port to a specific device based on IGMP messages passing through the Switch.

In order to use IGMP Snooping it must first be enabled for the entire Switch (see the **DGS-3600 Web Management Tool**). You may then fine-tune the settings for each VLAN using the **IGMP Snooping** link in the **L2 Features** folder. When enabled for IGMP snooping, the Switch can open or close a port to a specific multicast group member based on IGMP messages sent from the device to the IGMP host or vice versa. The Switch monitors IGMP messages and discontinues forwarding multicast packets when there are no longer hosts requesting that they continue.

IGMP Snooping Settings

Use the **IGMP Snooping Settings** window to view **IGMP Snooping** configurations.

To view this window, click **L2 Features > IGMP Snooping > IGMP Snooping Settings**, as shown below.

| Total Entries: 1 | | | | |
|-------------------------------|-----------|----------|---------------|---------------------------------------|
| IGMP Snooping Settings | | | | |
| VLAN ID | VLAN Name | State | Querier State | Modify |
| 1 | default | Disabled | Disabled | <input type="button" value="Modify"/> |

Figure 7- 23. IGMP Snooping Settings window

Clicking the **Modify** button will open the **IGMP Snooping Settings – Edit** window, shown below:

| | |
|--|---|
| IGMP Snooping Settings-Edit | |
| VLAN ID | <input type="text" value="1"/> |
| VLAN Name | <input type="text" value="default"/> |
| Query Interval (1-65535 sec) | <input type="text" value="125"/> |
| Max Response Time (1-25 sec) | <input type="text" value="10"/> |
| Robustness Variable (1-255) | <input type="text" value="2"/> |
| Last Member Query Interval (1-25 sec) | <input type="text" value="1"/> |
| Version (1-3) | <input type="text" value="3"/> |
| Host Timeout (1-16711450 sec) | <input type="text" value="260"/> |
| Router Timeout (1-16711450 sec) | <input type="text" value="260"/> |
| Leave Timer (1-16711450 sec) | <input type="text" value="2"/> |
| Querier State | <input type="button" value="Disabled"/> ▾ |
| Querier Router Behavior | Non-Querier |
| State | <input type="button" value="Disabled"/> ▾ |
| Fast Leave | <input type="button" value="Disabled"/> ▾ |
| <input type="button" value="Apply"/> | |
| Show All IGMP Snooping Entries | |

Figure 7- 24. IGMP Snooping Settings – Edit window

The following parameters may be viewed or modified:

| Parameter | Description |
|-------------------------------------|---|
| VLAN ID | This is the VLAN ID that, along with the VLAN Name, identifies the VLAN for which to modify the IGMP Snooping Settings. |
| VLAN Name | This is the VLAN Name that, along with the VLAN ID, identifies the VLAN for which to modify the IGMP Snooping Settings. |
| Query Interval (1-65535) | The Query Interval field is used to set the time (in seconds) between transmitting IGMP queries. Entries between 1 and 65535 seconds are allowed. Default = 125. |
| Max Response Time (1-25 sec) | This determines the maximum amount of time in seconds allowed before sending an IGMP response report. The Max Response Time field allows an entry between 1 and 25 (seconds). Default = 10. |
| Robustness Variable (1-255) | Adjust this variable according to expected packet loss. If packet loss on the VLAN is expected to be high, the Robustness Variable should be increased to accommodate |

| | |
|--|--|
| | increased packet loss. This entry field allows an entry of 1 to 255. Default = 2. |
| Last Member Query Interval (1-25 sec) | This field specifies the maximum amount of time between group-specific query messages, including those sent in response to leave group messages. Default = 1. |
| Version (1-3) | Configure the IGMP version of the query packet which will be sent by the router. |
| Host Timeout (1-16711450 sec) | This is the maximum amount of time in seconds allowed for a host to continue membership in a multicast group without the Switch receiving a host membership report. Default = 260. |
| Router Timeout (1-16711450 sec) | This is the maximum amount of time in seconds a router is kept in the forwarding table without receiving a membership report. Default = 260. |
| Leave Timer (1-16711450 sec) | This specifies the maximum amount of time in seconds between the Switch receiving a leave group message from a host, and the Switch issuing a group membership query. If no response to the membership query is received before the Leave Timer expires, the (multicast) forwarding entry for that host is deleted. The default setting is 2 seconds. |
| Querier State | Choose <i>Enabled</i> to enable transmitting IGMP Query packets or <i>Disabled</i> to disable. The default is <i>Disabled</i> . |
| Querier Router Behavior | This read-only field describes the behavior of the router for sending query packets. <i>Querier</i> will denote that the router is sending out IGMP query packets. <i>Non-Querier</i> will denote that the router is not sending out IGMP query packets. This field will only read <i>Querier</i> when the Querier State and the State fields have been Enabled. |
| State | Select <i>Enabled</i> to implement IGMP Snooping. This field is <i>Disabled</i> by default. |
| Fast Leave | This parameter allows the user to enable the <i>Fast Leave</i> function. Enabled, this function will allow members of a multicast group to leave the group immediately (without the implementation of the Last Member Query Timer) when an IGMP Leave Report Packet is received by the Switch. The default is <i>Disabled</i> . |

Click **Apply** to implement the new settings. Click the [Show All IGMP Group Entries](#) link to return to the **IGMP Snooping Settings** window.

Router Port Settings

A static router port is a port that has a multicast router attached to it. Generally, this router would have a connection to a WAN or to the Internet. Establishing a router port will allow multicast packets coming from the router to be propagated through the network, as well as allowing multicast messages (IGMP) coming from the network to be propagated to the router.

A router port has the following behavior:

- All IGMP Report packets will be forwarded to the router port.
- IGMP queries (from the router port) will be flooded to all ports.
- All UDP multicast packets will be forwarded to the router port. Because routers do not send IGMP reports or implement IGMP snooping, a multicast router connected to the router port of a Layer 3 switch would not be able to receive UDP data streams unless the UDP multicast packets were all forwarded to the router port.

A router port will be dynamically configured when IGMP query packets, RIPv2 multicast, DVMRP multicast or PIM-DM multicast packets are detected flowing into a port.

IGMP query packets – Internet Group Management Protocol query packets work by controlling the flow of multicast traffic. The IGMP query packets works by sending messages out to determine which devices are members of a particular multicast group, the devices will respond to the query and inform the querier of its membership status.

RIPv2 multicast – Routing Information Protocol Version 2 can be used for small networks or on the periphery of larger networks where VLSM is required. RIPv2 is used to support route authentication and multicasting of route updates. RIPv2 sends updates every 30 seconds and it uses triggered updates to carry out loop-prevention and poison reverse or counting to infinity.

DVMRP multicast – Distance Vector Multicast Routing Protocol uses reverse path flooding. Messages are flooded out of all interfaces except the one that returns to the source, this is to prevent any packets traveling to members of the multicast VLAN. The DVMRP uses periodic flooding so as to establish if there are other or potentially new group members.

PIM-DM multicast – Protocol Independent Multicast Dense Mode works by flooding the multicast packets to all routers and eliminates groups or members of groups that don't have an efficient path or route to their members. This mode is generally used if the volume of multicast traffic is large and constant.

To view this window click **L2 Features > IGMP Snooping > Router Ports Settings**, as shown below.

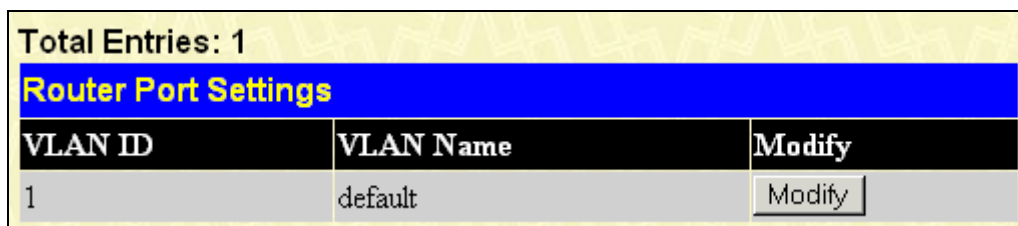

| Total Entries: 1 | | |
|----------------------|-----------|--------|
| Router Port Settings | | |
| VLAN ID | VLAN Name | Modify |
| 1 | default | Modify |

Figure 7- 25. Router Port Settings window

The previous window displays all of the current entries to the Switch's static router port table. To modify an entry, click the **Modify** button. This will open the **Router Port** window, as shown below.

| Router Port | | | | | | | | | | | | | | | | | | | | | | | | | |
|--|----------------------------------|----------------------------------|----------------------------------|----------------------------------|----------------------------------|----------------------------------|----------------------------------|----------------------------------|----------------------------------|----------------------------------|----------------------------------|----------------------------------|----------------------------------|----------------------------------|----------------------------------|----------------------------------|----------------------------------|----------------------------------|----------------------------------|----------------------------------|----------------------------------|----------------------------------|----------------------------------|----------------------------------|----------------------------------|
| VID | 1 | | | | | | | | | | | | | | | | | | | | | | | | |
| VLAN Name | default | | | | | | | | | | | | | | | | | | | | | | | | |
| Unit | 1 ▾ | | | | | | | | | | | | | | | | | | | | | | | | |
| Member Ports | | | | | | | | | | | | | | | | | | | | | | | | | |
| Port | 1 | 2 | 3 | 4 | 5 | 6 | 7 | 8 | 9 | 10 | 11 | 12 | 13 | 14 | 15 | 16 | 17 | 18 | 19 | 20 | 21 | 22 | 23 | 24 | 25 |
| None | <input checked="" type="radio"/> | <input checked="" type="radio"/> | <input checked="" type="radio"/> | <input checked="" type="radio"/> | <input checked="" type="radio"/> | <input checked="" type="radio"/> | <input checked="" type="radio"/> | <input checked="" type="radio"/> | <input checked="" type="radio"/> | <input checked="" type="radio"/> | <input checked="" type="radio"/> | <input checked="" type="radio"/> | <input checked="" type="radio"/> | <input checked="" type="radio"/> | <input checked="" type="radio"/> | <input checked="" type="radio"/> | <input checked="" type="radio"/> | <input checked="" type="radio"/> | <input checked="" type="radio"/> | <input checked="" type="radio"/> | <input checked="" type="radio"/> | <input checked="" type="radio"/> | <input checked="" type="radio"/> | <input checked="" type="radio"/> | <input checked="" type="radio"/> |
| Static | <input type="radio"/> | <input type="radio"/> | <input type="radio"/> | <input type="radio"/> | <input type="radio"/> | <input type="radio"/> | <input type="radio"/> | <input type="radio"/> | <input type="radio"/> | <input type="radio"/> | <input type="radio"/> | <input type="radio"/> | <input type="radio"/> | <input type="radio"/> | <input type="radio"/> | <input type="radio"/> | <input type="radio"/> | <input type="radio"/> | <input type="radio"/> | <input type="radio"/> | <input type="radio"/> | <input type="radio"/> | <input type="radio"/> | <input type="radio"/> | <input type="radio"/> |
| Forbidden | <input type="radio"/> | <input type="radio"/> | <input type="radio"/> | <input type="radio"/> | <input type="radio"/> | <input type="radio"/> | <input type="radio"/> | <input type="radio"/> | <input type="radio"/> | <input type="radio"/> | <input type="radio"/> | <input type="radio"/> | <input type="radio"/> | <input type="radio"/> | <input type="radio"/> | <input type="radio"/> | <input type="radio"/> | <input type="radio"/> | <input type="radio"/> | <input type="radio"/> | <input type="radio"/> | <input type="radio"/> | <input type="radio"/> | <input type="radio"/> | <input type="radio"/> |
| Both | <input type="radio"/> | <input type="radio"/> | <input type="radio"/> | <input type="radio"/> | <input type="radio"/> | <input type="radio"/> | <input type="radio"/> | <input type="radio"/> | <input type="radio"/> | <input type="radio"/> | <input type="radio"/> | <input type="radio"/> | <input type="radio"/> | <input type="radio"/> | <input type="radio"/> | <input type="radio"/> | <input type="radio"/> | <input type="radio"/> | <input type="radio"/> | <input type="radio"/> | <input type="radio"/> | <input type="radio"/> | <input type="radio"/> | <input type="radio"/> | <input type="radio"/> |
| Port | - | - | - | - | - | - | - | - | - | - | - | - | - | - | - | - | - | - | - | - | - | - | - | - | - |
| None | - | - | - | - | - | - | - | - | - | - | - | - | - | - | - | - | - | - | - | - | - | - | - | - | - |
| Static | - | - | - | - | - | - | - | - | - | - | - | - | - | - | - | - | - | - | - | - | - | - | - | - | - |
| Forbidden | - | - | - | - | - | - | - | - | - | - | - | - | - | - | - | - | - | - | - | - | - | - | - | - | - |
| Both | - | - | - | - | - | - | - | - | - | - | - | - | - | - | - | - | - | - | - | - | - | - | - | - | - |
| <input type="button" value="Apply"/> | | | | | | | | | | | | | | | | | | | | | | | | | |
| Show All Router Port Entries | | | | | | | | | | | | | | | | | | | | | | | | | |

Figure 7- 26. Router Port – Modify window

The following parameters can be set:

| Parameter | Description |
|----------------------|--|
| VID (VLAN ID) | This is the VLAN ID that, along with the VLAN Name, identifies the VLAN where the multicast router is attached. |
| VLAN Name | This is the name of the VLAN where the multicast router is attached. |
| Unit | This is the stacking unit where the VLAN is located where the multicast router is attached. |
| Member Ports | <p>Ports on the Switch that will have a multicast router attached to them. There are three options for which to configure these ports:</p> <p><i>None</i> – Click this option to not set these ports as router ports</p> <p><i>Static</i> – Click this option to designate a range of ports as being connected to a multicast-enabled router. This command will ensure that all packets with this router as its destination will reach the multicast-enabled router.</p> <p><i>Forbidden</i> – Click this option to designate a port or range of ports as being forbidden from being connected to multicast enabled routers. This ensures that these configured forbidden ports will not send out routing packets.</p> <p><i>Both</i> - Click this option to designate a port or range of ports as being both forbidden from being connected to multicast enabled routers. This ensures that these configured forbidden ports will not send out routing packets.</p> |

Click **Apply** to implement the new settings, Click the [Show All Router Port Entries](#) link to return to the **Router Port Settings** window.

ISM VLAN Settings window

In a switching environment, multiple VLANs may exist. Every time a multicast query passes through the Switch, the switch must forward separate different copies of the data to each VLAN on the system, which, in turn, increases data traffic and may clog up the traffic path. To lighten the traffic load, multicast VLANs may be incorporated. These multicast VLANs will allow the Switch to forward this multicast traffic as one copy to recipients of the multicast VLAN, instead of multiple copies.

Regardless of other normal VLANs that are incorporated on the Switch, users may add any ports to the multicast VLAN where they wish multicast traffic to be sent. Users are to set up a source port, where the multicast traffic is entering the switch, and then set the ports where the incoming multicast traffic is to be sent. The source port cannot be a recipient port and if configured to do so, will cause error messages to be produced by the switch. Once properly configured, the stream of multicast data will be relayed to the receiver ports in a much more timely and reliable fashion.

Restrictions and Provisos

The Multicast VLAN feature of this switch does have some restrictions and limitations, such as:

1. Multicast VLANs can be implemented on edge and non-edge switches.
2. Member ports and source ports can be used in multiple ISM VLANs. But member ports and source ports cannot be the same port in a specific ISM VLAN.
3. The Multicast VLAN is exclusive with normal 802.1q VLANs, which means that VLAN IDs (VIDs) and VLAN Names of 802.1q VLANs and ISM VLANs cannot be the same. Once a VID or VLAN Name is chosen for any VLAN, it cannot be used for any other VLAN.
4. The normal display of configured VLANs will not display configured Multicast VLANs.
5. Once an ISM VLAN is enabled, the corresponding IGMP snooping state of this VLAN will also be enabled. Users cannot disable the IGMP feature for an enabled ISM VLAN.
6. One IP multicast address cannot be added to multiple ISM VLANs, yet multiple Ranges can be added to one ISM VLAN.

The following windows will allow users to create and configure multicast VLANs for the switch.

To view this windows, click **L2 Features > IGMP Snooping > ISM VLAN Settings**, as shown below.

| VID | VLAN Name | Replace Source IP | State | Modify | Group List | Delete |
|-----|-----------|-------------------|----------|--------|------------|--------|
| 2 | DG | 0.0.0.0 | Disabled | Modify | Modify | X |

Total Entries: 1

Figure 7- 27. IGMP Snooping Multicast VLAN Table window

The previous window displays the settings for previously created Multicast VLANs. To view the settings for a previously created multicast VLAN, click the **Modify** button of the corresponding ISM VLAN you wish to modify. To create a new Multicast VLAN, click the **Add** button in the top left-hand corner of the screen, which will produce the following window to be configured.

IGMP Snooping Multicast VLAN Settings

VLAN Name

VID (2-4094)

Apply

[Show IGMP Snooping Multicast VLAN Entries](#)

Figure 7- 28. IGMP Snooping Multicast VLAN Settings – Add window

Enter a name for the ISM VLAN into the **VLAN Name** field and choose a **VID** between 2 and 4094. Entries in these two fields must not have been previously configured on the switch or an error message will be prompted to the user. Once these two fields have been filled, click the **Apply** button, which will automatically adjust the current window to resemble the following window.

Figure 7- 29. IGMP Snooping Multicast VLAN Settings – Add/Modify window

Both the **Add** and **Modify** windows of the **IGMP Multicast VLAN Settings** have the following configurable fields.

| Parameter | Description |
|--------------------------|--|
| VLAN Name | Enter the name of the new Multicast VLAN to be created. This name can be up to 32 characters in length. This field will display the pre-created name of a Multicast VLAN in the Modify window. |
| VID | Add or edit the corresponding VLAN ID of the Multicast VLAN. Users may enter a value between 2 and 4094. |
| State | Use the pull-down menu to enable or disable the selected Multicast VLAN. |
| Member Port | Enter a port or list of ports to be added to the Multicast VLAN. Member ports will become the untagged members of the multicast VLAN. |
| Source Port | Enter a port or list of ports to be added to the Multicast VLAN. Source ports will become the tagged members of the multicast VLAN. |
| Replace Source IP | This field is used to replace the source IP address of incoming packets sent by the host before being forwarded to the source port. |

Click **Apply** to implement settings made.

To configure the new Multicast VLAN Group List, click the corresponding **Modify** button in the **IGMP Snooping Multicast VLAN Table** which will reveal the following window to be configured.

Figure 7- 30. IGMP Snooping Multicast VLAN Group List Settings

Enter an existing **Range Name** and click **Add**. To remove all entries click the **Remove All** button.

IP Multicast Address Range Settings

Users can configure the range of multicast addresses that will be accepted by the source port to be forwarded to the receiver ports. The following window will be displayed for the user.

To view this window, click **L2 Features > IGMP Snooping > IP Multicast Address Range Settings**, as shown below.

| Range Name | From | To | Delete |
|------------|------|----|--------|
|------------|------|----|--------|

Figure 7- 31. IP Multicast Address Range Table window

To display a previously created IP Multicast Address enter the Range Name and click **Find**, the information will be displayed on the **IP Multicast Address Range Table**. To create a new range, click the **Add** button which will display the following window.

Figure 7- 32. IP Multicast Address Range Setting – Add window

The following parameters can be set:

| Parameter | Description |
|-------------------|--|
| Range Name | Enter an alphanumeric name of no more than 32 characters to define the Multicast Address range. This name will be used to define the multicast address range when it is added to a multicast port. |
| From...To | Enter the range of multicast addresses that will be accepted by the multicast port using this range name. A range of multicast addresses may be separated by a dash (Ex. 224.0.0.0-239.255.255.255). |

Click **Apply** to set this Range Name with these multicast addresses.

Limited Multicast Address Range Settings

The **Limited IP Multicast Range** window allows the user to specify which multicast address(es) reports are to be received on specified ports on the Switch. This function will therefore limit the number of reports received and the number of multicast groups configured on the Switch. The user may set an IP address or range of IP addresses, by entering a pre-configured Range Name, to accept reports (*Permit*) or deny reports (*Deny*) coming into the specified switch ports.

To view this window, click **L2 Features > IGMP Snooping > Limited Multicast Address Range Settings**, as shown.

To configure Limited IP Multicast Range:

Use the remaining pull-down menus to configure the parameters described below:

| Parameter | Description |
|---|---|
| Limited IP Multicast Address Range Port Settings (Click Apply to save changes) | |
| Unit | Enter the unit you wish to configure. |
| From...To | Select a range of ports to be granted access or denied access from receiving multicast information. |
| Access | Toggle the Access field to either <i>Permit</i> or <i>Deny</i> to limit or grant access to a specified range of Multicast addresses on a particular port or range of ports. |
| Limited IP Multicast Address Range Settings | |
| From...To | Select a port or range of ports to be allowed access to multicast information from a specific multicast IP range. |
| Range Name | Enter the pre-configured Range Name denoting a range of multicast IP addresses for the ports listed in the previous fields. |
| Add | Click this button to add the Range Name to these ports. |
| Delete | Click this button to delete this range name from the list of ports. |
| Delete All | Click this button to delete all configured range names from the list of ports. |

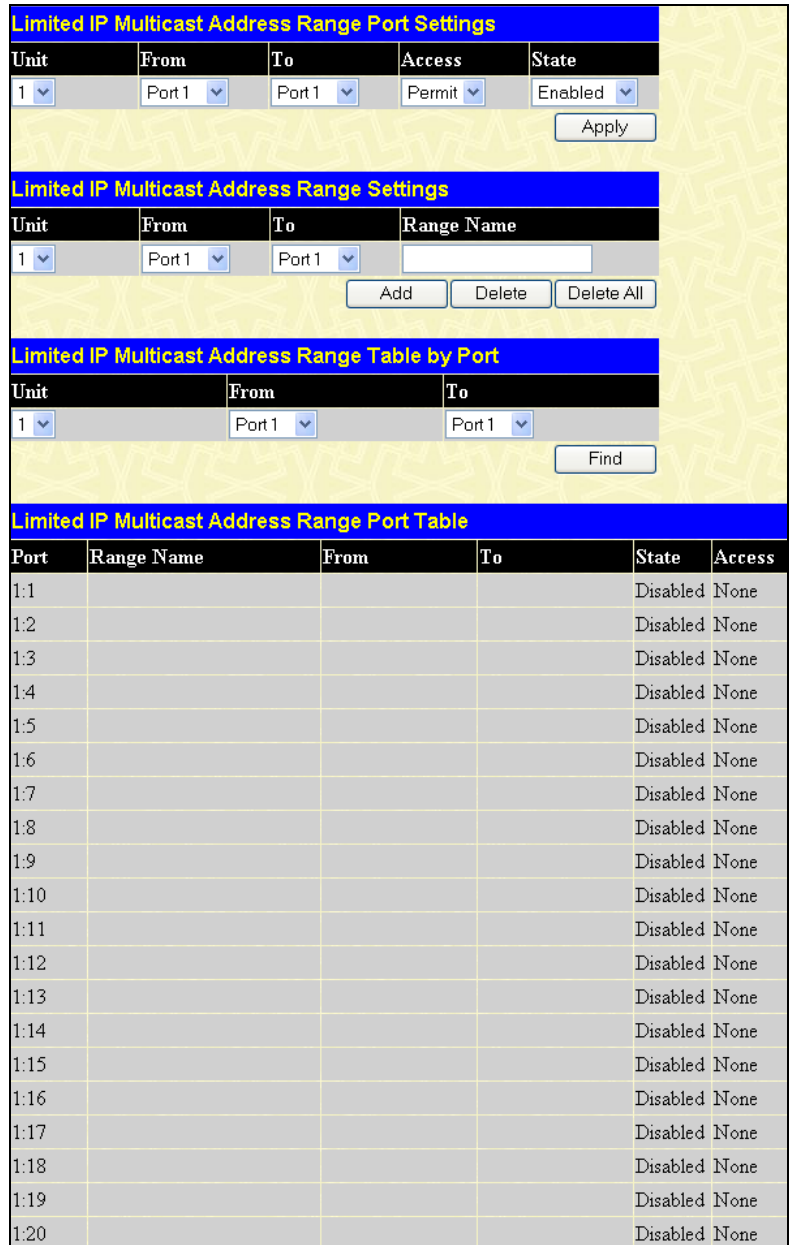

Figure 7- 33. Limited IP Multicast Address Range Port Settings window

Users may view the Limited Multicast IP Range settings on a port-by-port basis using the pull-down menus under Limited IP Multicast Address Range Table by Port. Configured entries will be displayed in the Limited IP Multicast Address Range Port Table at the bottom of the window.

MLD Snooping

Multicast Listener Discovery (MLD) Snooping is an IPv6 function used similarly to IGMP snooping in IPv4. It is used to discover ports on a VLAN that are requesting multicast data. Instead of flooding all ports on a selected VLAN with multicast traffic, MLD snooping will only forward multicast data to ports that wish to receive this data through the use of queries and reports produced by the requesting ports and the source of the multicast traffic.

MLD snooping is accomplished through the examination of the layer 3 part of an MLD control packet transferred between end nodes and a MLD router. When the Switch discovers that this route is requesting multicast traffic, it adds the port directly attached to it into the correct IPv6 multicast table, and begins the process of forwarding multicast traffic to that port. This entry in the multicast routing table records the port, the VLAN ID and the associated multicast IPv6 multicast group address and then considers this port to be a active listening port. The active listening ports are the only ones to receive multicast group data.

MLD Control Messages

Three types of messages are transferred between devices using MLD snooping. These three messages are all defined by three ICMPv6 packet headers, labeled 130, 131 and 132.

1. **Multicast Listener Query** – Similar to the IGMPv2 Host Membership Query for IPv4, and labeled as 130 in the ICMPv6 packet header, this message is sent by the router to ask if any link is requesting multicast data. There are two types of MLD query messages emitted by the router. The General Query is used to advertise all multicast addresses that are ready to send multicast data to all listening ports, and the Multicast Specific query, which advertises a specific multicast address that is also ready. These two types of messages are distinguished by a multicast destination address located in the IPv6 header and a multicast address in the Multicast Listener Query Message.
2. **Multicast Listener Report** – Comparable to the Host Membership Report in IGMPv2, and labeled as 131 in the ICMP packet header, this message is sent by the listening port to the Switch stating that it is interested in receiving multicast data from a multicast address in response to the Multicast Listener Query message.
3. **Multicast Listener Done** – Akin to the Leave Group Message in IGMPv2, and labeled as 132 in the ICMPv6 packet header, this message is sent by the multicast listening port stating that it is no longer interested in receiving multicast data from a specific multicast group address, therefore stating that it is “done” with the multicast data from this address. Once this message is received by the Switch, it will no longer forward multicast traffic from a specific multicast group address to this listening port.

MLD Snooping Settings

This window is used to configure the settings for MLD snooping.

To view this window, click **L2 Features > MLD Snooping > MLD Snooping Settings**, as shown below.

| Total Entries: 1 | | | | |
|-----------------------|-----------|----------|---------------|---------------------------------------|
| MLD Snooping Settings | | | | |
| VLAN ID | VLAN Name | State | Querier State | Modify |
| 1 | default | Disabled | Disabled | <input type="button" value="Modify"/> |

Figure 7- 34. MLD Snooping Settings window

This window displays the current MLD Snooping settings set on the Switch, defined by VLAN. To configure a specific VLAN for MLD snooping, click the VLAN’s corresponding **Modify** button, which will display the following window for the user to configure.

| MLD Snooping Settings-Edit | |
|---|-------------|
| VLAN ID | 1 |
| VLAN Name | default |
| Query Interval (1-65535 sec) | 125 |
| Max Response Time (1-25 sec) | 10 |
| Robustness Variable (1-255) | 2 |
| Last Listener Query Interval (1-25 sec) | 1 |
| Version (1-2) | 2 |
| Node Timeout (1-16711450 sec) | 260 |
| Router Timeout (1-16711450 sec) | 260 |
| Done Timer (1-16711450 sec) | 2 |
| Querier State | Disabled ▾ |
| Querier Router Behavior | Non-Querier |
| State | Disabled ▾ |
| Fast Done | Disabled ▾ |
| Apply | |
| Show All MLD Snooping Entries | |

Figure 7- 35. MLD Snooping Settings - Edit window

The following parameters may be viewed or modified:

| Parameter | Description |
|--|---|
| VLAN ID | This is the VLAN ID that, along with the VLAN Name, identifies the VLAN for which to modify the MLD Snooping Settings. |
| VLAN Name | This is the VLAN Name that, along with the VLAN ID, identifies the VLAN for which to modify the MLD Snooping Settings. |
| Query Interval (1-65535 sec) | The Query Interval field is used to set the time (in seconds) between transmitting MLD queries. Entries between 1 and 65535 seconds are allowed. Default = 125. |
| Max Response Time (1-25 sec) | This determines the maximum amount of time in seconds allowed to wait for a response for MLD port listeners. The Max Response Time field allows an entry between 1 and 25 (seconds). Default = 10. |
| Robustness Variable (1-255) | Provides fine-tuning to allow for expected packet loss on a subnet. The user may choose a value between 1 and 255 with a default setting of 2. If a subnet is expected to be lossy, the user may wish to increase this interval. |
| Last Listener Query Interval (1-25 sec) | The maximum amount of time to be set between group-specific query messages. This interval may be reduced to lower the amount of time it takes a router to detect the loss of a last listener group. The user may set this interval between 1 and 25 seconds with a default setting of 1 second. |
| Version <value 1-2> | Configure the MLD version of the query packet which will be sent by the router. |
| Node Timeout (1-16711450 sec) | Specifies the link node timeout, in seconds. After this timer expires, this node will no longer be considered as listening node. The user may specify a time between 1 and 16711450 with a default setting of 260 seconds. |
| Router Timeout (1-16711450 sec) | Specifies the maximum amount of time a router can remain in the Switch's routing table as a listening node of a multicast group without the Switch receiving a node |

| | |
|------------------------------------|--|
| | listener report. The user may specify a time between 1 and 16711450 with a default setting of 260 seconds. |
| Done Timer (1-16711450 sec) | Specifies the maximum amount of time a router can remain in the Switch after receiving a done message from the group without receiving a node listener report. The user may specify a time between 1 and 16711450 with a default setting of 2 seconds. |
| Querier State | Choose <i>Enabled</i> to enable transmitting MLD Snooping Query packets or <i>Disabled</i> to disable. The default is <i>Disabled</i> . |
| Querier Router Behavior | This read-only field describes the current querier state of the Switch, whether Querier, which will send out Multicast Listener Query Messages to links, or Non-Querier, which will not send out Multicast Listener Query Messages. |
| State | Used to enable or disable MLD snooping for the specified VLAN. This field is <i>Disabled</i> by default. |
| Fast Done | This parameter allows the user to enable the <i>fast done</i> function. Enabled, this function will allow members of a multicast group to leave the group immediately when a <i>done</i> message is received by the Switch. |

NOTE: The robustness variable of the MLD snooping querier is used in creating the following MLD message intervals:



Group Listener Interval – The amount of time that must pass before a multicast router decides that there are no more listeners present of a group on a network. Calculated as (robustness variable * query interval) + (1 * query response interval).

Querier Present Interval – The amount of time that must pass before a multicast router decides that there are no other querier devices present. Calculated as (robustness variable * query interval) + (0.5 * query response interval).

Last Listener Query Count – The amount of group-specific queries sent before the router assumes there are no local listeners in this group. The default value is the value of the robustness variable.

Click **Apply** to implement changes made. Click the [Show All MLD Snooping Entries](#) link to return to the MLD Snooping Settings window.

MLD Router Port Settings

The following window is used to designate a port or range of ports as being connected to multicast enabled routers. When IPv6 routing control packets, such as OSPFv3 or MLD Query packets are found in an Ethernet port or specified VLAN, the Switch will set these ports as dynamic router ports. Once set, this will ensure that all packets with a multicast router as its destination will arrive at the multicast-enabled router, regardless of protocol. If the Router’s Aging Time expires and no routing control packets or query packets are received by the port, that port will be removed from being a router port.

To configure these settings, click **L2 Features > MLD Snooping > MLD Router Port Settings**, as shown below.

| Total Entries: 1 | | |
|---------------------------------|-----------|--------|
| MLD Router Port Settings | | |
| VLAN ID | VLAN Name | Modify |
| 1 | default | Modify |

Figure 7- 36. MLD Router Port Settings window

To configure the router ports settings for a specified VLAN, click its corresponding **Modify** button, which will produce the following window for the user to configure.

| Router Port | | | | | | | | | | | | | | | | | | | | | | | | | |
|--|----------------------------------|----------------------------------|----------------------------------|----------------------------------|----------------------------------|----------------------------------|----------------------------------|----------------------------------|----------------------------------|----------------------------------|----------------------------------|----------------------------------|----------------------------------|----------------------------------|----------------------------------|----------------------------------|----------------------------------|----------------------------------|----------------------------------|----------------------------------|----------------------------------|----------------------------------|----------------------------------|----------------------------------|----------------------------------|
| VID | 1 | | | | | | | | | | | | | | | | | | | | | | | | |
| VLAN Name | default | | | | | | | | | | | | | | | | | | | | | | | | |
| Unit | 1 | | | | | | | | | | | | | | | | | | | | | | | | |
| Member Ports | | | | | | | | | | | | | | | | | | | | | | | | | |
| Port | 1 | 2 | 3 | 4 | 5 | 6 | 7 | 8 | 9 | 10 | 11 | 12 | 13 | 14 | 15 | 16 | 17 | 18 | 19 | 20 | 21 | 22 | 23 | 24 | 25 |
| None | <input checked="" type="radio"/> | <input checked="" type="radio"/> | <input checked="" type="radio"/> | <input checked="" type="radio"/> | <input checked="" type="radio"/> | <input checked="" type="radio"/> | <input checked="" type="radio"/> | <input checked="" type="radio"/> | <input checked="" type="radio"/> | <input checked="" type="radio"/> | <input checked="" type="radio"/> | <input checked="" type="radio"/> | <input checked="" type="radio"/> | <input checked="" type="radio"/> | <input checked="" type="radio"/> | <input checked="" type="radio"/> | <input checked="" type="radio"/> | <input checked="" type="radio"/> | <input checked="" type="radio"/> | <input checked="" type="radio"/> | <input checked="" type="radio"/> | <input checked="" type="radio"/> | <input checked="" type="radio"/> | <input checked="" type="radio"/> | <input checked="" type="radio"/> |
| Static | <input type="radio"/> | <input type="radio"/> | <input type="radio"/> | <input type="radio"/> | <input type="radio"/> | <input type="radio"/> | <input type="radio"/> | <input type="radio"/> | <input type="radio"/> | <input type="radio"/> | <input type="radio"/> | <input type="radio"/> | <input type="radio"/> | <input type="radio"/> | <input type="radio"/> | <input type="radio"/> | <input type="radio"/> | <input type="radio"/> | <input type="radio"/> | <input type="radio"/> | <input type="radio"/> | <input type="radio"/> | <input type="radio"/> | <input type="radio"/> | <input type="radio"/> |
| Forbidden | <input type="radio"/> | <input type="radio"/> | <input type="radio"/> | <input type="radio"/> | <input type="radio"/> | <input type="radio"/> | <input type="radio"/> | <input type="radio"/> | <input type="radio"/> | <input type="radio"/> | <input type="radio"/> | <input type="radio"/> | <input type="radio"/> | <input type="radio"/> | <input type="radio"/> | <input type="radio"/> | <input type="radio"/> | <input type="radio"/> | <input type="radio"/> | <input type="radio"/> | <input type="radio"/> | <input type="radio"/> | <input type="radio"/> | <input type="radio"/> | <input type="radio"/> |
| Both | <input type="radio"/> | <input type="radio"/> | <input type="radio"/> | <input type="radio"/> | <input type="radio"/> | <input type="radio"/> | <input type="radio"/> | <input type="radio"/> | <input type="radio"/> | <input type="radio"/> | <input type="radio"/> | <input type="radio"/> | <input type="radio"/> | <input type="radio"/> | <input type="radio"/> | <input type="radio"/> | <input type="radio"/> | <input type="radio"/> | <input type="radio"/> | <input type="radio"/> | <input type="radio"/> | <input type="radio"/> | <input type="radio"/> | <input type="radio"/> | <input type="radio"/> |
| Port | - | - | - | - | - | - | - | - | - | - | - | - | - | - | - | - | - | - | - | - | - | - | - | - | - |
| None | - | - | - | - | - | - | - | - | - | - | - | - | - | - | - | - | - | - | - | - | - | - | - | - | - |
| Static | - | - | - | - | - | - | - | - | - | - | - | - | - | - | - | - | - | - | - | - | - | - | - | - | - |
| Forbidden | - | - | - | - | - | - | - | - | - | - | - | - | - | - | - | - | - | - | - | - | - | - | - | - | - |
| Both | - | - | - | - | - | - | - | - | - | - | - | - | - | - | - | - | - | - | - | - | - | - | - | - | - |
| <input type="button" value="Apply"/> | | | | | | | | | | | | | | | | | | | | | | | | | |
| Show All Router Port Entries | | | | | | | | | | | | | | | | | | | | | | | | | |

Figure 7- 37. Router Port window (Modify)

The following parameters can be set:

| Parameter | Description |
|----------------------|--|
| VID (VLAN ID) | This is the VLAN ID that, along with the VLAN Name, identifies the VLAN where the MLD multicast router is attached. |
| VLAN Name | This is the name of the VLAN where the MLD multicast router is attached. |
| Unit | Select the unit you wish to configure. |
| Member Ports | <p>Ports on the Switch that will have a multicast router attached to them. There are three options for which to configure these ports:</p> <p><i>None</i> – Click this option to not set these ports as router ports</p> <p><i>Static</i> – Click this option to designate a range of ports as being connected to a multicast-enabled router. This command will ensure that all packets with this router as its destination will reach the multicast-enabled router.</p> <p><i>Forbidden</i> – Click this option to designate a port or range of ports as being forbidden from being connected to multicast enabled routers. This ensures that these configured forbidden ports will not send out routing packets.</p> <p><i>Both</i> - Click this option to designate a port or range of ports as being both forbidden from being connected to multicast enabled routers. This ensures that these configured forbidden ports will not send out routing packets.</p> |

Click **Apply** to implement the new settings.

Loopback Detection Global Settings

The Loopback Detection function is used to detect the loop created by a specific port. This feature is used to temporarily shutdown a port on the Switch when a CTP (Configuration Testing Protocol) packet has been looped back to the switch. When the Switch detects CTP, packets are received from a port it signifies a loop on the network. The Switch will automatically block the port and send an alert to the administrator. The Loopback Detection port will restart (change to discarding state) when the Loopback Detection **Recover Time** times out. The Loopback Detection function can be implemented on a range of ports at a time. The user may enable or disable this function using the pull-down menu.

To view this window, click **L2 Features > Loopback Detection Global Settings**, as shown below.

Loopback Detection Global Settings

| | |
|---------------------------------------|-----------------------------|
| Loopdetect Status | Disabled ▾ |
| Loopdetect Trap | None ▾ |
| Interval (1-32767) | 10 <input type="text"/> sec |
| Recover Time (0 or 60-1000000) | 60 <input type="text"/> sec |
| Mode | Port Based ▾ |

Loopback Detection Port Settings

| Unit | From | To | State | Apply |
|------|----------|----------|------------|--------------------------------------|
| 1 ▾ | Port 1 ▾ | Port 1 ▾ | Disabled ▾ | <input type="button" value="Apply"/> |

Loopback Detection Port Based Table

| Port | Loopdetect State | Loop Status |
|------|------------------|-------------|
| 1 | Disabled | Normal |
| 2 | Disabled | Normal |
| 3 | Disabled | Normal |
| 4 | Disabled | Normal |
| 5 | Disabled | Normal |
| 6 | Disabled | Normal |
| 7 | Disabled | Normal |
| 8 | Disabled | Normal |
| 9 | Disabled | Normal |
| 10 | Disabled | Normal |
| 11 | Disabled | Normal |
| 12 | Disabled | Normal |
| 13 | Disabled | Normal |
| 14 | Disabled | Normal |
| 15 | Disabled | Normal |
| 16 | Disabled | Normal |
| 17 | Disabled | Normal |
| 18 | Disabled | Normal |
| 19 | Disabled | Normal |
| 20 | Disabled | Normal |
| 21 | Disabled | Normal |
| 22 | Disabled | Normal |
| 23 | Disabled | Normal |
| 24 | Disabled | Normal |
| 25 | Disabled | Normal |

Figure 7- 38. Loopback Detection window

The following parameters can be configured.

| Parameter | Description |
|---------------------------------------|---|
| Loopdetect Status | Use the drop-down menu to enable or disable loopback detection. The default is <i>Disabled</i> . |
| Loopdetect Trap | <p>None – The trap will not be sent in any situation.</p> <p>Loop Detected – The trap is sent when the loop condition is detected.</p> <p>Loop Cleared – The trap is sent when the loop condition is cleared.</p> <p>Both – The trap will be sent for both conditions.</p> |
| Interval (1-32767) | Set a Loopdetect Interval between 1 and 32767 seconds. The default is 10 seconds. |
| Recover Time (0 or 60-1000000) | Time allowed (in seconds) for recovery when a Loopback is detected. The Loopdetect Recover Time can be set at 0 seconds, or 60 to 1000000 seconds. Entering 0 will disable the Loopdetect Recover Time. The default is 60 seconds. |
| Mode | <p>Select the mode you wish to use either <i>Port Based</i> or <i>VLAN Based</i>.</p> <p><i>Port Based</i> – This mode can detect loopback based on the Port. If the Switch detects loopback on the Port, the loopback detection will only block the traffic which belongs to this Port. Other VLAN traffic should not be affected by this.</p> <p><i>VLAN Based</i> – This mode can detect loopback based on the VLAN. If the Switch detects loopback on the VLAN, the loopback detection will only block the traffic which belongs to this VLAN. Other VLAN traffic should not be affected by this. Loopback detection will send the CPT packets periodically per port per VLAN in VLAN based mode.</p> |
| Unit | Select the unit you wish to configure. |
| From...To | Use the drop-down menu to select a port or range of ports to be configured. |
| State | Use the drop-down menu to toggle between <i>Enabled</i> and <i>Disabled</i> . |

Click **Apply** to implement changes made.

Spanning Tree

This Switch supports three versions of the Spanning Tree Protocol; 802.1D STP, 802.1w Rapid STP and 802.1s MSTP. 802.1D STP will be familiar to most networking professionals. However, since 802.1w RSTP and 802.1s MSTP has been recently introduced to D-Link managed Ethernet switches, a brief introduction to the technology is provided below followed by a description of how to set up 802.1D STP, 802.1w RSTP and 802.1s MSTP.

802.1s MSTP

Multiple Spanning Tree Protocol, or MSTP, is a standard defined by the IEEE community that allows multiple VLANs to be mapped to a single spanning tree instance, which will provide multiple pathways across the network. Therefore, these MSTP configurations will balance the traffic load, preventing wide scale disruptions when a single spanning tree instance fails. This will allow for faster convergences of new topologies for the failed instance. Frames designated for these VLANs will be processed quickly and completely throughout interconnected bridges utilizing any of the three spanning tree protocols (STP, RSTP or MSTP).

This protocol will also tag BPDU packets so receiving devices can distinguish spanning tree instances, spanning tree regions and the VLANs associated with them. An MSTI ID will classify these instances. MSTP will connect multiple spanning trees with a Common and Internal Spanning Tree (CIST). The CIST will automatically determine each MSTP region, its maximum possible extent and will appear as one virtual bridge that runs a single spanning tree. Consequentially, frames assigned to different VLANs will follow different data routes within administratively established regions on the network, continuing to allow simple and full processing of frames, regardless of administrative errors in defining VLANs and their respective spanning trees.

Each switch utilizing the MSTP on a network will have a single MSTP configuration that will have the following three attributes:

1. A configuration name defined by an alphanumeric string of up to 32 characters (defined in the **MST Configuration Identification** window in the Configuration Name field).
2. A configuration revision number (named here as a Revision Level and found in the **MST Configuration Identification** window) and;
3. A 4096-element table (defined here as a VID List in the **MST Configuration Identification** window), which will associate each of the possible 4096 VLANs supported by the Switch for a given instance.

To utilize the MSTP function on the Switch, three steps need to be taken:

1. The Switch must be set to the MSTP setting (found in the **STP Bridge Global Settings** window in the STP Version field).
2. The correct spanning tree priority for the MSTP instance must be entered (defined here as a Priority in the **STP Instance Settings** window when configuring an MSTI ID settings).
3. VLANs that will be shared must be added to the MSTP Instance ID (defined here as a VID List in the **MST Configuration Identification** window when configuring an MSTI ID settings).

802.1w Rapid Spanning Tree

The Switch implements three versions of the Spanning Tree Protocol, the Multiple Spanning Tree Protocol (MSTP) as defined by the IEEE 802.1s, the Rapid Spanning Tree Protocol (RSTP) as defined by the IEEE 802.1w specification and a version compatible with the IEEE 802.1D STP. RSTP can operate with legacy equipment implementing IEEE 802.1D, however the advantages of using RSTP will be lost.

The IEEE 802.1w Rapid Spanning Tree Protocol (RSTP) evolved from the 802.1D STP standard. RSTP was developed in order to overcome some limitations of STP that impede the function of some recent switching innovations, in particular, certain Layer 3 functions that are increasingly handled by Ethernet switches. The basic function and much of the terminology is the same as STP. Most of the settings configured for STP are also used for RSTP. This section introduces some new Spanning Tree concepts and illustrates the main differences between the two protocols.

Port Transition States

An essential difference between the three protocols is in the way ports transition to a forwarding state and in the way this transition relates to the role of the port (forwarding or not forwarding) in the topology. MSTP and RSTP combine the transition states disabled, blocking and listening used in 802.1D and creates a single state Discarding. In either case, ports do not forward packets. In the STP port transition states disabled, blocking or listening or in the RSTP/MSTP port state discarding, there is no functional difference, the port is not active in the network topology. Table 7-1 below compares how the three protocols differ regarding the port state transition.

All three protocols calculate a stable topology in the same way. Every segment will have a single path to the root bridge. All bridges listen for BPDU packets. However, BPDU packets are sent more frequently - with every Hello packet. BPDU packets are sent even if a BPDU packet was not received. Therefore, each link between bridges is sensitive to the status of the link. Ultimately

this difference results in faster detection of failed links, and thus faster topology adjustment. A drawback of 802.1D is this absence of immediate feedback from adjacent bridges.

| 802.1s MSTP | 802.1w RSTP | 802.1D STP | Forwarding | Learning |
|-------------|-------------|------------|------------|----------|
| Disabled | Disabled | Disabled | No | No |
| Discarding | Discarding | Blocking | No | No |
| Discarding | Discarding | Listening | No | No |
| Learning | Learning | Learning | No | Yes |
| Forwarding | Forwarding | Forwarding | Yes | Yes |

Table 7- 2. Comparing Port States

RSTP is capable of a more rapid transition to a forwarding state - it no longer relies on timer configurations - RSTP compliant bridges are sensitive to feedback from other RSTP compliant bridge links. Ports do not need to wait for the topology to stabilize before transitioning to a forwarding state. In order to allow this rapid transition, the protocol introduces two new variables: the edge port and the point-to-point (P2P) port.

Edge Port

The edge port is a configurable designation used for a port that is directly connected to a segment where a loop cannot be created. An example would be a port connected directly to a single workstation. Ports that are designated as edge ports transition to a forwarding state immediately without going through the listening and learning states. An edge port loses its status if it receives a BPDU packet, immediately becoming a normal spanning tree port.

P2P Port

A P2P port is also capable of rapid transition. P2P ports may be used to connect to other bridges. Under RSTP/MSTP, all ports operating in full-duplex mode are considered to be P2P ports, unless manually overridden through configuration.

802.1D/802.1w/802.1s Compatibility

MSTP or RSTP can interoperate with legacy equipment and is capable of automatically adjusting BPDU packets to 802.1D format when necessary. However, any segment using 802.1D STP will not benefit from the rapid transition and rapid topology change detection of MSTP or RSTP. The protocol also provides for a variable used for migration in the event that legacy equipment on a segment is updated to use RSTP or MSTP.

The Spanning Tree Protocol (STP) operates on two levels:

1. On the switch level, the settings are globally implemented.
2. On the port level, the settings are implemented on a per user-defined group of ports basis.

STP Loopback Detection

When connected to other switches, STP is an important configuration in consistency for delivering packets to ports and can greatly improve the throughput of your switch. Yet, even this function can malfunction with the emergence of STP BPDU packets that occasionally loop back to the Switch, such as BPDU packets looped back from an unmanaged switch connected to a DGS-3600 Series switch. To maintain the consistency of the throughput, the DGS-3600 Series switch implements the STP Loopback Detection function.

When the STP Loopback Detection function is enabled, the Switch will be protected against a loop occurring between switches. Once a BPDU packet returns to the Switch, this function will detect that there is an anomaly occurring and will place the receiving port in an error-disabled state. Consequentially, a message will be placed in the Switch's Syslog and will be defined there as "BPDU Loopback on Port #".

Setting the Loopback Timer

The Loopback timer plays a key role in the next step the switch will take to resolve this problem. Choosing a non-zero value on the timer will enable the Auto-Recovery Mechanism. When the timer expires, the switch will again look for its returning BPDU packet on the same port. If no returning packet is received, the switch will recover the port as a Designated Port in the Discarding State. If another returning BPDU packet is received, the port will remain in a blocked state, the timer will reset to the specified value, restart, and the process will begin again.

For those who choose not to employ this function, the Loopback Recovery time must be set to zero. In this case, when a BPDU packet is returned to the Switch, the port will be placed in a blocking state and a message will be sent to the Syslog of the switch. To recover the port, the administrator must disable the state of the problematic port and enable it again. This is the only method available to recover the port when the Loopback Recover Time is set to 0.

Regulations and Restrictions for the Loopback Detection Function

- All three versions of STP (STP, RSTP and MSTP) can enable this feature.
- May be configured globally (STP Global Bridge Settings), or per port (MSTP Port Information).
- Neighbor switches of the Switch must have the capability to forward BPDU packets. Switches that fail to meet this requirement will disable this function for the port in question on the Switch.
- Loopback Detection is globally enabled for the switch, yet the port-by-port default setting is disabled.
- The default setting for the Loopback timer is 60 seconds.
- This setting will only be operational if the interface is STP-enabled.

The Loopback Detection feature can only prevent BPDU loops on the Switch designated ports. It can detect a loop condition occurring on the user’s side connected to the edge port, but it cannot detect the Loopback condition on the elected root port of STP on another switch.

STP Bridge Global Settings

To view the following window, click **L2 Features > Spanning Tree > STP Bridge Global Settings**, as shown below.

| STP Bridge Global Settings | |
|----------------------------|----------|
| STP Status | Disabled |
| STP Version | RSTP |
| Hello Time(1-10 Sec) | 2 |
| Max Age(6-40 Sec) | 20 |
| Forward Delay(4-30 Sec) | 15 |
| Max Hops(1-20) | 20 |
| TX Hold Count(1-10) | 3 |
| Forwarding BPDU | Disabled |
| Loopback Detection | Enabled |
| LBD Recover Time | 60 |
| Apply | |

Figure 7- 39. STP Bridge Global Settings window – RSTP (default)

| STP Bridge Global Settings | |
|----------------------------|----------|
| STP Status | Disabled |
| STP Version | MSTP |
| Max Age(6-40 Sec) | 20 |
| Forward Delay(4-30 Sec) | 15 |
| Max Hops(1-20) | 20 |
| TX Hold Count(1-10) | 3 |
| Forwarding BPDU | Disabled |
| Loopback Detection | Enabled |
| LBD Recover Time | 60 |
| Apply | |

Figure 7- 40. STP Bridge Global Settings window - MSTP

| STP Bridge Global Settings | |
|----------------------------|------------------|
| STP Status | Disabled ▾ |
| STP Version | STP compatible ▾ |
| Hello Time(1-10 Sec) | 2 |
| Max Age(6-40 Sec) | 20 |
| Forward Delay(4-30 Sec) | 15 |
| Max Hops(1-20) | 20 |
| TX Hold Count(1-10) | 3 |
| Forwarding BPDU | Disabled ▾ |
| Loopback Detection | Enabled ▾ |
| LBD Recover Time | 60 |
| Apply | |

Figure 7- 41. STP Bridge Global Settings – STP Compatible window



NOTE: The Hello Time cannot be longer than the Max. Age. Otherwise, a configuration error will occur. Observe the following formulas when setting the above parameters:

Max. Age <= 2 x (Forward Delay - 1 second)

Max. Age >= 2 x (Hello Time + 1 second)

The following parameters can be set:

| Parameter | Description |
|---------------------------------|--|
| STP Status | Use the pull-down menu to enable or disable STP globally on the Switch. The default is <i>Disabled</i> . |
| Hello Time (1-10 Sec) | The Hello Time can be set from 1 to 10 seconds. This is the interval between two transmissions of BPDU packets sent by the Root Bridge to tell all other switches that it is indeed the Root Bridge. |
| Max Age (6-40 Sec) | The Max Age may be set to ensure that old information does not endlessly circulate through redundant paths in the network, preventing the effective propagation of the new information. Set by the Root Bridge, this value will aid in determining that the Switch has spanning tree configuration values consistent with other devices on the bridged LAN. If the value ages out and a BPDU has still not been received from the Root Bridge, the Switch will start sending its own BPDU to all other switches for permission to become the Root Bridge. If it turns out that your switch has the lowest Bridge Identifier, it will become the Root Bridge. The user may choose a time between 6 and 40 seconds. The default value is 20. |
| Forward Delay (4-30 Sec) | The Forward Delay can be from 4 to 30 seconds. Any port on the Switch spends this time in the listening state while moving from the blocking state to the forwarding state. |
| Max Hops (1-20) | Used to set the number of hops between devices in a spanning tree region before the BPDU (bridge protocol data unit) packet sent by the Switch will be discarded. Each switch on the hop count will reduce the hop count by one until the value reaches zero. The Switch will then discard the BPDU packet and the information held for the port will age out. The user may set a hop count from 1 to 20. The default is 20. |
| TX Hold Count (1-10) | Used to set the maximum number of Hello packets transmitted per interval. The count can be specified from 1 to 10. The default is 3. |
| Forwarding BPDU | This field can be <i>Enabled</i> or <i>Disabled</i> . When <i>Enabled</i> , it allows the forwarding of STP BPDU packets from other network devices. The default is Disabled. |

| | |
|---------------------------|--|
| Loopback Detection | This feature is used to temporarily shutdown a port on the Switch when a BPDU packet has been looped back to the switch. When the Switch detects its own BPDU packet coming back, it signifies a loop on the network. STP will automatically be blocked and an alert will be sent to the administrator. The LBD STP port will restart (change to discarding state) when the LBD Recover Time times out. The Loopback Detection function will only be implemented on one port at a time. The user may enable or disable this function using the pull-down menu. The default is Enabled. |
| LBD Recover Time | This field will set the time the STP port will wait before recovering the STP state set. 0 will denote that the LBD will never time out or restart until the administrator personally changes it. The user may also set a time between 60 and 1000000 seconds. The default is 60 seconds. |



NOTE: The Loopback Detection function can only be implemented on the Switch if it is configured both on the **STP Global Settings** window, and on the **STP Port Settings** window. Enabling this feature through only one of these windows will not fully enable the Loopback Detection function.

Click **Apply** to implement changes made.

MST Configuration Identification

The **MST Configuration Identification** window allows the user to configure a MSTI instance on the Switch. These settings will uniquely identify a multiple spanning tree instance set on the Switch. The Switch initially possesses one CIST or Common Internal Spanning Tree of which the user may modify the parameters for but cannot change the MSTI ID for, and cannot be deleted.

To view this window, click **L2 Features > Spanning Tree > MST Configuration Identification**, as shown below.

The screenshot shows the 'MST Configuration Identification' window. At the top left is an 'Add' button. Below it is a table with the following data:

| Configuration Name | Revision Level | |
|--------------------|----------------|--------|
| 00:19:5B:F5:26:C0 | 0 | |
| MSTI ID | VID List | Delete |
| CIST | 1-4094 | X |

Below the table is the 'MST Configuration Identification Settings' section, which includes:

- Configuration Name:** 00:19:5B:F5:26:C0
- Revision Level(0-65535):** 0
- Apply** button

Figure 7- 42. MST Configuration Identification and Settings window

The window above contains the following information:

| Parameter | Description |
|---------------------------|--|
| Configuration Name | A previously configured name set on the Switch to uniquely identify the MSTI (Multiple Spanning Tree Instance). If a configuration name is not set, this field will show the MAC address to the device running MSTP. This field can be set in the STP Bridge Global Settings window. |
| Revision Level (0- | This value, along with the Configuration Name will identify the MSTP region configured on |

| | |
|-----------------|--|
| 65535) | the Switch. The user may choose a value between 0 and 65535 with a default setting of 0. |
| MSTI ID | This field shows the MSTI IDs currently set on the Switch. This field will always have the CIST MSTI, which may be configured but not deleted. Clicking the hyperlinked name will open a new window for configuring parameters associated with that particular MSTI. |
| VID List | This field displays the VLAN IDs associated with the specific MSTI. |

Clicking the **Add** button will reveal the following window to configure:

Figure 7- 43. Instance ID Settings window – Add

The user may configure the following parameters to create a MSTI in the Switch.

| Parameter | Description |
|--------------------------|---|
| MSTI ID | Enter a number between 1 and 15 to set a new MSTI on the Switch. |
| Type | <i>Create</i> is selected to create a new MSTI. No other choices are available for this field when creating a new MSTI. |
| VID List (1-4094) | This field is used to specify the VID range from configured VLANs set on the Switch. Supported VIDs on the Switch range from ID number 1 to 4094. |

Click **Apply** to implement changes made.

To configure the settings for the CIST, click on its hyperlinked name in the **MST Configuration Identification** window, which will reveal the following window to configure:

Figure 7- 44. Instance ID Settings window - CIST modify

The user may configure the following parameters to configure the CIST on the Switch.

| Parameter | Description |
|----------------|--|
| MSTI ID | The MSTI ID of the CIST is 0 and cannot be altered. |
| Type | This field allows the user to choose a desired method for altering the MSTI settings. The user has 2 choices. <ul style="list-style-type: none"> <i>Add VID</i> - Select this parameter to add VIDs to the MSTI ID, in conjunction with the VID List parameter. |

| | |
|--------------------------|---|
| | <ul style="list-style-type: none"> • <i>Remove VID</i> - Select this parameter to remove VIDs from the MSTI ID, in conjunction with the VID List parameter. |
| VID List (1-4094) | This field is used to specify the VID range from configured VLANs set on the Switch. Supported VIDs on the Switch range from ID number 1 to 4094. This field is inoperable when configuring the CIST. |

Click **Apply** to implement changes made.

To configure the parameters for a previously set MSTI, click on its hyperlinked MSTI ID number, which will reveal the following window for configuration.

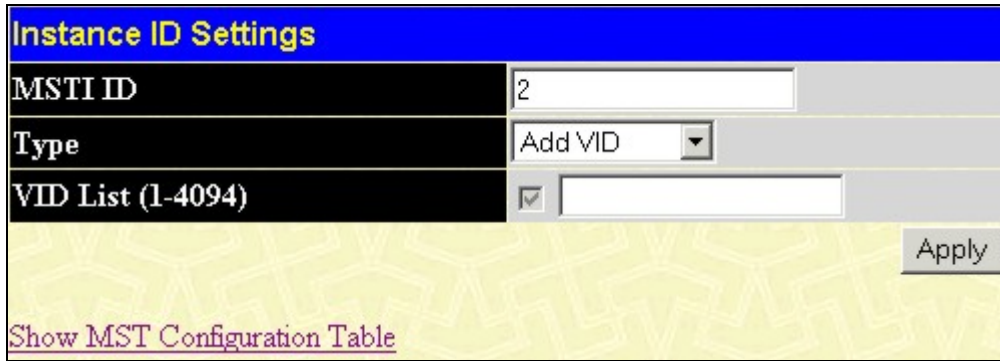

Figure 7- 45. Instance ID Settings window – Modify

The user may configure the following parameters for a MSTI on the Switch.

| Parameter | Description |
|--------------------------|--|
| MSTI ID | Displays the MSTI ID previously set by the user. |
| Type | <p>This field allows the user to choose a desired method for altering the MSTI settings. The user has four choices.</p> <ul style="list-style-type: none"> • <i>Add VID</i> - Select this parameter to add VIDs to the MSTI ID, in conjunction with the VID List parameter. • <i>Remove VID</i> - Select this parameter to remove VIDs from the MSTI ID, in conjunction with the VID List parameter. |
| VID List (1-4094) | This field is used to specify the VID range from configured VLANs set on the Switch that the user wishes to add to this MSTI ID. Supported VIDs on the Switch range from ID number 1 to 4094. This parameter can only be utilized if the Type chosen is <i>Add</i> or <i>Remove</i> . |

Click **Apply** to implement changes made.

MSTP Port Information

This window displays the current MSTP Port Information and can be used to update the port configuration for an MSTI ID. If a loop occurs, the MSTP function will use the port priority to select an interface to put into the forwarding state. Set a higher priority value for interfaces to be selected for forwarding first. In instances where the priority value is identical, the MSTP function will implement the lowest MAC address into the forwarding state and other interfaces will be blocked. Remember that lower priority values mean higher priorities for forwarding packets.

To view the following window, click **L2 Features > Spanning Tree > MSTP Port Information**, as shown below.

| Unit | Port | Apply |
|------|--------|-------|
| 1 | Port 1 | Apply |

| MSTP Port Information-Port 1 of Unit 1 | | | | | |
|--|-------------------|-------------------|------|----------|----------|
| MSTI | Designated Bridge | Internal PathCost | Prio | Status | Role |
| 0 | N/A | 200000 | 128 | Disabled | Disabled |

Figure 7- 46. MSTP Port Information window

To view the MSTI settings for a particular port, select the Port number, located in the top left hand corner of the screen and click **Apply**. To modify the settings for a particular MSTI Instance, click on its hyperlinked MSTI ID, which will reveal the following window.

| MSTI Settings-Port 1 of Unit 1 | |
|---|-------------------------------------|
| Instance ID | <input type="text" value="0"/> |
| Internal Cost(0=Auto) | <input type="text" value="200000"/> |
| Priority (0-240) | <input type="text" value="128"/> |
| <input type="button" value="Apply"/> | |
| Show MSTP Port Information Table-Port 1 of Unit 1 | |

Figure 7- 47. MSTI Settings window

The user may configure the following parameters.

| Parameter | Description |
|-------------------------------|---|
| Instance ID | Displays the MSTI ID of the instance being configured. An entry of 0 in this field denotes the CIST (default MSTI). |
| Internal cost (0=Auto) | <p>This parameter is set to represent the relative cost of forwarding packets to specified ports when an interface is selected within a STP instance. The default setting is 0 (auto). There are two options:</p> <ul style="list-style-type: none"> <i>0 (auto)</i> - Selecting this parameter for the <i>internalCost</i> will set quickest route automatically and optimally for an interface. The default value is derived from the media speed of the interface. <i>value 1-200000000</i> - Selecting this parameter with a value in the range of 1-200000000 will set the quickest route when a loop occurs. A lower Internal cost represents a quicker transmission. |
| Priority (0-240) | Enter a value between 0 and 240 to set the priority for the port interface. A higher priority will designate the interface to forward packets first. A lower number denotes a higher priority. |

Click **Apply** to implement changes made.

STP Instance Settings

The following window displays MSTIs currently set on the Switch.

To view the following table, click **L2 Features > Spanning Tree > STP Instance Settings**, as shown below.

| Instance Type | Instance Status | Instance Priority | Priority |
|---------------|-----------------|--|---------------------------------------|
| CIST | Disabled | 32768(Bridge Priority : 32768, SYS ID Ext : 0) | <input type="button" value="Modify"/> |

Figure 7- 48. STP Instance Settings window

The following information is displayed:

| Parameter | Description |
|--------------------------|---|
| Instance Type | Displays the instance type(s) currently configured on the Switch. Each instance type is classified by a MSTI ID. CIST refers to the default MSTI configuration set on the Switch. |
| Instance Status | Displays the current status of the corresponding MSTI ID |
| Instance Priority | Displays the priority of the corresponding MSTI ID. The lowest priority will be the root bridge. |

Click **Apply** to implement changes made.

Click the **Modify** button to change the priority of the MSTI. This will open the Instance ID Settings window to configure.

Figure 7- 49. Instance ID Settings - Modify priority window

| Parameter | Description |
|---------------------------|---|
| MSTI ID | Displays the MSTI ID of the instance being modified. An entry of 0 in this field denotes the CIST (default MSTI). |
| Type | The Type field in this window will be permanently set to <i>Set Priority Only</i> . |
| Priority (0-61440) | Enter the new priority in the Priority field. The user may set a priority value between 0 and 61440. |

Click **Apply** to implement the new priority setting.

STP Port Settings

STP can be set up on a port per port basis. In addition to setting Spanning Tree parameters for use on the switch level, the Switch allows for the configuration of groups of ports, each port-group of which will have its own spanning tree, and will require some of its own configuration settings. An STP Group will use the switch-level parameters entered above, with the addition of Port Priority and Port Cost. An STP Group spanning tree works in the same way as the switch-level spanning tree, but the root bridge concept is replaced with a root port concept. A root port is a port of the group that is elected based on port priority and port cost, to be the connection to the network for the group. Redundant links will be blocked, just as redundant links are blocked on the switch level. The STP on the switch level blocks redundant links between switches (and similar network devices). The port level STP will block redundant links within an STP Group.

It is advisable to define an STP Group to correspond to a VLAN group of ports.

To view the STP Port Settings window click **L2 Features > Spanning Tree > STP Port Settings**, as shown below.

STP Port Settings

| Unit | From | To | External Cost (0=Auto) | Hello Time | Migrate | Edge | P2P | State | LBD | BPDU | Apply |
|------|--------|--------|---------------------------|------------|---------|-------|------|---------|----------|---------|-------|
| 1 | Port 1 | Port 1 | 0 | 0 | Yes | False | True | Enabled | Disabled | Enabled | Apply |

STP Port Settings Table-Unit 1

| Port | External Cost | Hello Time | Edge | P2P | Port STP | LBD | BPDU |
|------|---------------|------------|-------|----------|----------|----------|----------|
| 1 | Auto/200000 | 2/2 | No/No | Auto/Yes | Enabled | Disabled | Disabled |
| 2 | Auto/200000 | 2/2 | No/No | Auto/Yes | Enabled | Disabled | Disabled |
| 3 | Auto/200000 | 2/2 | No/No | Auto/Yes | Enabled | Disabled | Disabled |
| 4 | Auto/200000 | 2/2 | No/No | Auto/Yes | Enabled | Disabled | Disabled |
| 5 | Auto/200000 | 2/2 | No/No | Auto/Yes | Enabled | Disabled | Disabled |
| 6 | Auto/200000 | 2/2 | No/No | Auto/Yes | Enabled | Disabled | Disabled |
| 7 | Auto/200000 | 2/2 | No/No | Auto/Yes | Enabled | Disabled | Disabled |
| 8 | Auto/200000 | 2/2 | No/No | Auto/Yes | Enabled | Disabled | Disabled |
| 9 | Auto/200000 | 2/2 | No/No | Auto/Yes | Enabled | Disabled | Disabled |
| 10 | Auto/200000 | 2/2 | No/No | Auto/Yes | Enabled | Disabled | Disabled |
| 11 | Auto/200000 | 2/2 | No/No | Auto/Yes | Enabled | Disabled | Disabled |
| 12 | Auto/200000 | 2/2 | No/No | Auto/Yes | Enabled | Disabled | Disabled |
| 13 | Auto/200000 | 2/2 | No/No | Auto/Yes | Enabled | Disabled | Disabled |
| 14 | Auto/200000 | 2/2 | No/No | Auto/Yes | Enabled | Disabled | Disabled |
| 15 | Auto/200000 | 2/2 | No/No | Auto/Yes | Enabled | Disabled | Disabled |
| 16 | Auto/200000 | 2/2 | No/No | Auto/Yes | Enabled | Disabled | Disabled |
| 17 | Auto/200000 | 2/2 | No/No | Auto/Yes | Enabled | Disabled | Disabled |
| 18 | Auto/200000 | 2/2 | No/No | Auto/Yes | Enabled | Disabled | Disabled |
| 19 | Auto/200000 | 2/2 | No/No | Auto/Yes | Enabled | Disabled | Disabled |
| 20 | Auto/200000 | 2/2 | No/No | Auto/Yes | Enabled | Disabled | Disabled |
| 21 | Auto/200000 | 2/2 | No/No | Auto/Yes | Enabled | Disabled | Disabled |
| 22 | Auto/200000 | 2/2 | No/No | Auto/Yes | Enabled | Disabled | Disabled |
| 23 | Auto/200000 | 2/2 | No/No | Auto/Yes | Enabled | Disabled | Disabled |
| 24 | Auto/200000 | 2/2 | No/No | Auto/Yes | Enabled | Disabled | Disabled |
| 25 | Auto/200000 | 2/2 | No/No | Auto/Yes | Enabled | Disabled | Disabled |

Figure 7- 50. STP Port Settings window

The following STP Port Settings fields can be set:

| Parameter | Description |
|----------------------|--|
| Unit | Select the unit you wish to configure. |
| From...To | A consecutive group of ports may be configured starting with the selected port. |
| External Cost | <p>This defines a metric that indicates the relative cost of forwarding packets to the specified port list. Port cost can be set automatically or as a metric value. The default value is 0 (auto).</p> <p>0 (auto) - Setting 0 for the external cost will automatically set the speed for forwarding packets to the specified port(s) in the list for optimal efficiency. Default port cost: 100Mbps port = 200000. Gigabit port = 20000.</p> <p>value 1-200000000 - Define a value between 1 and 200000000 to determine the external cost. The lower the number, the greater the probability the port will be chosen to forward packets.</p> |
| Hello Time | The time interval between transmissions of configuration messages by the designated port, to other devices on the bridged LAN. The user may choose a time between 1 and 10 seconds. |

| | |
|------------------|---|
| | The default is 2 seconds. This field is only operable when the Switch is enabled for MSTP. |
| Migration | When operating in RSTP mode, selecting yes forces the port that has been selected to transmit RSTP BPDUs. |
| Edge | Choosing the <i>True</i> parameter designates the port as an edge port. Edge ports cannot create loops, however an edge port can lose edge port status if a topology change creates a potential for a loop. An edge port normally should not receive BPDUs. If a BPDUs packet is received, it automatically loses edge port status. Choosing the <i>False</i> parameter indicates that the port does not have edge port status. |
| P2P | Choosing the <i>True</i> parameter indicates a point-to-point (P2P) shared link. P2P ports are similar to edge ports, however they are restricted in that a P2P port must operate in full duplex. Like edge ports, P2P ports transition to a forwarding state rapidly thus benefiting from RSTP. A P2P value of <i>False</i> indicates that the port cannot have P2P status. <i>Auto</i> allows the port to have P2P status whenever possible and operate as if the P2P status were true. If the port cannot maintain this status, (for example if the port is forced to half-duplex operation) the P2P status changes to operate as if the P2P value were <i>False</i> . The default setting for this parameter is <i>True</i> . |
| State | This drop-down menu allows you to enable or disable STP for the selected group of ports. The default is <i>Enabled</i> . |
| LBD | Use the pull-down menu to enable or disable the Loopback Detection function on the Switch for the ports configured above. For more information on this function, see the Loopback Detection field in the STP Bridge Global Settings window, mentioned earlier in this section. |
| BPDUs | Choosing <i>Enabled</i> will allow the forwarding of BPDUs packets in the specified ports from other network devices. This will go into effect only if STP is globally disabled AND Forwarding BPDUs is globally enabled (See the STP Bridge Global Settings window above). The default setting <i>Disabled</i> , does not forward BPDUs packets when STP is disabled. |

Click **Apply** to implement changes made.



NOTE: If you want to enable Forwarding BPDUs on a per port basis, the following settings must first be in effect: 1. STP must be globally disabled and 2. Forwarding BPDUs must be globally enabled. These are the default settings configurable in the **STP Bridge Global Settings** window discussed previously.

Forwarding & Filtering

Unicast Forwarding

The following window is used to set up unicast forwarding on the Switch.

To view this window, click **L2 Features > Forwarding & Filtering > Unicast Forwarding**, as shown below.

| Unicast Forwarding Table | | | | | |
|---------------------------------|-------------------|-----------|------------------------------------|------|----------------------------------|
| VLAN ID | MAC Address | Unit | Port | | |
| 1 | 00-00-00-00-00-0F | 1 | Port 2 | | |
| | | | <input type="button" value="Add"/> | | |
| Static Unicast Forwarding Table | | | | | |
| MAC Address | VID | VLAN Name | Unit | Port | Delete |
| 00-00-00-00-00-0F | 1 | default | 1 | 2 | <input type="button" value="X"/> |
| Total Entries:1 | | | | | |

Figure 7- 51. Unicast Forwarding Table window

To add or edit an entry, define the following parameters and then click **Add**:

| Parameter | Description |
|----------------------|--|
| VLAN ID (VID) | The VLAN ID number of the VLAN on which the above Unicast MAC address resides. |
| MAC Address | The MAC address to which packets will be statically forwarded. This must be a unicast MAC address. |
| Unit | Enter the unit you wish to configure. |
| Port | Allows the selection of the port number on which the MAC address entered above resides. |

To delete an entry in the Unicast Forwarding Table, click the corresponding under the Delete heading.

Multicast Forwarding

The following window is used to set up multicast forwarding on the Switch.

To view this window, click **L2 Features > Forwarding & Filtering > Multicast Forwarding**, as shown below.

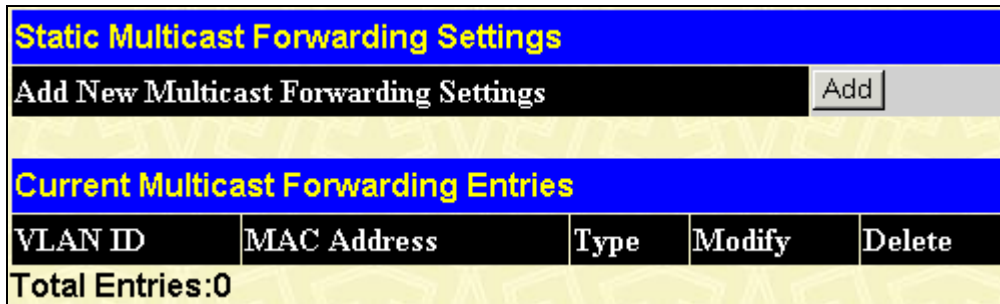

Figure 7- 52. Static Multicast Forwarding Settings window

The **Static Multicast Forwarding Settings** window displays all of the entries made into the Switch's static multicast forwarding table. Click the **Add** button to open the **Setup Static Multicast Forwarding Table** window, as shown below:

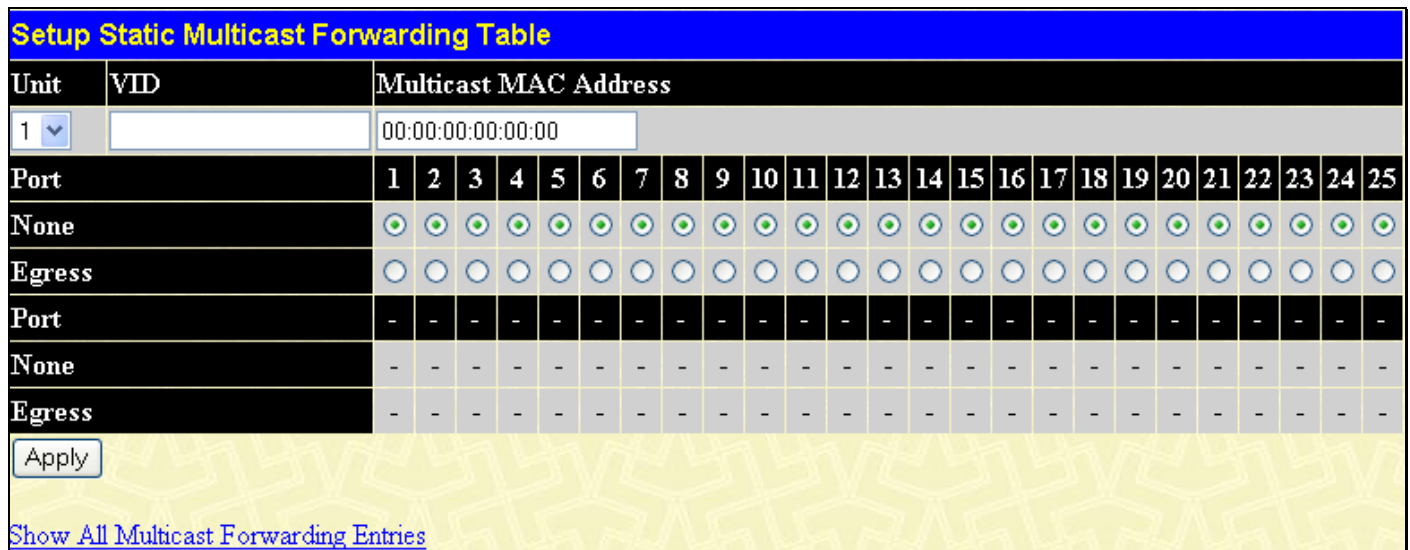

Figure 7- 53. Setup Static Multicast Forwarding Table window

The following parameters can be set:

| Parameter | Description |
|------------------------------|---|
| Unit | Select the unit you wish to configure. |
| VID | The VLAN ID of the VLAN to which the corresponding MAC address belongs. |
| Multicast MAC Address | The MAC address of the static source of multicast packets. This must be a multicast MAC address. |
| Port Settings | <p>Allows the selection of ports that will be members of the static multicast group and ports that are either forbidden from joining dynamically, or that can join the multicast group dynamically, using GMRP. The options are:</p> <p><i>None</i> - No restrictions on the port dynamically joining the multicast group. When None is chosen, the port will not be a member of the Static Multicast Group.</p> <p><i>Egress</i> - The port is a static member of the multicast group.</p> |

Click **Apply** to implement the changes made. To delete an entry in the Static Multicast Forwarding Table, click the corresponding under the Delete heading. Click the [Show All Multicast Forwarding Entries](#) link to return to the **Static Multicast Forwarding Settings** window.

Multicast Filtering Mode

To view this window, click **L2 Features > Forwarding & Filtering > Multicast Filtering Mode**, as shown below.

| Multicast Filtering Mode Settings | | |
|--|--------------------|-------|
| VLAN Name | Filtering Mode | Apply |
| <input type="text" value="All"/> <input checked="" type="checkbox"/> | Forward All Groups | Apply |

| Multicast Filtering Mode Table | |
|--------------------------------|-----------------------------|
| VLAN Name | Multicast Filtering Mode |
| default | Forward Unregistered Groups |

Figure 7- 54. Multicast Filtering Mode Settings window

The following parameters can be set:

| Parameter | Description |
|-----------------------|--|
| VLAN Name | The VLAN to which the specified filtering action applies. Tick the All check box to apply the action to all VLANs on the Switch. |
| Filtering Mode | <p>This drop-down menu allows you to select the action the Switch will take when it receives a multicast packet that requires forwarding to a port in the specified VLAN.</p> <ul style="list-style-type: none"> <i>Forward All Groups</i> – This will instruct the Switch to forward a multicast packet to all multicast groups residing within the range of ports specified above. <i>Forward Unregistered Groups</i> – This will instruct the Switch to forward a multicast packet whose destination is an unregistered multicast group residing within the range of ports specified above. <i>Filter Unregistered Groups</i> – This will instruct the Switch to filter any multicast packets whose destination is an unregistered multicast group residing within the range of ports specified above. |

Click **Apply** to implement changes made.

LLDP

The Link Layer Discovery Protocol (LLDP) allows stations attached to a LAN to advertise, to other stations attached to the same LAN segment, the connectivity and management information necessary to identify, to those management entities, the station's point of attachment to the LAN or network. The information distributed via this protocol is stored by its recipients in a standard management information base (MIB), making it possible for the information to be accessed by a network management system (NMS) using a management protocol such as the Simple Network Management Protocol (SNMP).

LLDP standard specifies the necessary protocol and management elements to:

1. Facilitate multi-vendor inter-operability and the use of standard management tools to discover and make available physical topology information for network management
2. Make it possible for network management to discover certain configuration inconsistencies or malfunctions that can result in impaired communication at higher layers.
3. Provide information to assist network management in making resource changes and/or reconfigurations that correct configuration inconsistencies or malfunctions identified above.

LLDP is a one way protocol (transmit and receive are separated). An LLDP agent can transmit information about the capabilities and current status of the system associated with its MSAP identifier. The LLDP agent can also receive information about the capabilities and current status of the system associated with a remote MSAP identifier. However, LLDP agents are not provided any means of soliciting information from other LLDP agents via this protocol.

LLDP allows the transmitter and the receiver to be separately enabled, making it possible to configure an implementation to restrict the local LLDP agent either to transmit only or receive only, or to allow the local LLDP agent to both transmit and receive LLDP information

LLDP Global Settings

The following window is used to set up LLDP on the Switch.

To view this window, click **L2 Features > LLDP > LLDP Global Settings**, as shown below.

| LLDP Operation State Settings | |
|--------------------------------------|---|
| LLDP Operation State | Disabled <input type="button" value="v"/> |
| <input type="button" value="Apply"/> | |
| LLDP Global Settings | |
| LLDP Forward Message State | Disabled <input type="button" value="v"/> |
| Message TX Interval(5-32768) | <input type="text" value="30"/> |
| Message TX Hold Multiplier(2-10) | <input type="text" value="4"/> |
| ReInit Delay(1-10) | <input type="text" value="2"/> |
| TX Delay(1-8192) | <input type="text" value="2"/> |
| Notification Interval(5-3600) | <input type="text" value="5"/> |
| Chassis ID Subtype | MAC Address |
| Chassis ID | 00-19-5B-F5-26-C0 |
| System Name | |
| System Description | Gigabit Ethernet Switch |
| System Capabilities | |
| <input type="button" value="Apply"/> | |

Figure 7- 55. LLDP Operation State Settings window

The following parameters can be set:

| Parameter | Description |
|--|---|
| LLDP Operation State | When this function is <i>Enabled</i> , the switch can start to transmit LLDP packets and receive and process the LLDP packets. The specific function of each port will depend on the per port LLDP setting. For the advertisement of LLDP packets, the switch announces the information to its neighbor through ports. For the receiving of LLDP packets, the switch will learn the information from the LLDP packets advertised from the neighbor in the neighbor table. |
| LLDP Forward Message State | Use the drop-down menu to disable or enable the LLDP forward message state. |
| Message TX Interval (5-32768) | This parameter indicates the interval at which LLDP frames are transmitted on behalf of this LLDP agent. The default value is 30 seconds. |
| Message TX Hold Multiplier (2-10) | This parameter is a multiplier that determines the actual TTL value used in an LLDPDU. The default value is 4. |
| ReInit Delay (1-10) | This parameter indicates the amount of delay from when adminStatus becomes "disabled" until re-initialization will be attempted. The default value is 2 seconds. |
| TX Delay (1-8192) | This parameter indicates the delay between successive LLDP frame transmissions initiated by value or status changes in the LLDP local systems MIB. The value for txDelay is set by the following range formula: $1 < txDelay < (0.25 \times msgTxInterval)$ The default value is 2 seconds. |
| Notification Interval (5-3600) | Used to configure the timer of notification interval for sending notification to configured SNMP trap receiver(s). The default value is 5 seconds. |

Click **Apply** to implement changes made.

Basic LLDP Port Settings

The following window is used to set up LLDP on individual port(s) on the Switch.

To view this window, click **L2 Features > LLDP > Basic LLDP Port Settings**, as shown below.

| Basic LLDP Port Settings | | | | | | | | | |
|--------------------------|--------|--------|--------------------|--------------|------------------|-------------|--------------------|---------------------|-------|
| Unit | From | To | Notification State | Admin Status | Port Description | System Name | System Description | System Capabilities | Apply |
| 1 | Port 1 | Port 1 | Disabled | TX_Only | Disabled | Disabled | Disabled | Disabled | Apply |

| Basic LLDP Port Settings Table | | | | | | |
|--------------------------------|--------------------|--------------|------------------|-------------|--------------------|---------------------|
| Port ID | Notification State | Admin Status | Port Description | System Name | System Description | System Capabilities |
| 1 | Disabled | TX_and_RX | Disabled | Disabled | Disabled | Disabled |
| 2 | Disabled | TX_and_RX | Disabled | Disabled | Disabled | Disabled |
| 3 | Disabled | TX_and_RX | Disabled | Disabled | Disabled | Disabled |
| 4 | Disabled | TX_and_RX | Disabled | Disabled | Disabled | Disabled |
| 5 | Disabled | TX_and_RX | Disabled | Disabled | Disabled | Disabled |
| 6 | Disabled | TX_and_RX | Disabled | Disabled | Disabled | Disabled |
| 7 | Disabled | TX_and_RX | Disabled | Disabled | Disabled | Disabled |
| 8 | Disabled | TX_and_RX | Disabled | Disabled | Disabled | Disabled |
| 9 | Disabled | TX_and_RX | Disabled | Disabled | Disabled | Disabled |
| 10 | Disabled | TX_and_RX | Disabled | Disabled | Disabled | Disabled |
| 11 | Disabled | TX_and_RX | Disabled | Disabled | Disabled | Disabled |
| 12 | Disabled | TX_and_RX | Disabled | Disabled | Disabled | Disabled |
| 13 | Disabled | TX_and_RX | Disabled | Disabled | Disabled | Disabled |
| 14 | Disabled | TX_and_RX | Disabled | Disabled | Disabled | Disabled |
| 15 | Disabled | TX_and_RX | Disabled | Disabled | Disabled | Disabled |
| 16 | Disabled | TX_and_RX | Disabled | Disabled | Disabled | Disabled |
| 17 | Disabled | TX_and_RX | Disabled | Disabled | Disabled | Disabled |
| 18 | Disabled | TX_and_RX | Disabled | Disabled | Disabled | Disabled |
| 19 | Disabled | TX_and_RX | Disabled | Disabled | Disabled | Disabled |
| 20 | Disabled | TX_and_RX | Disabled | Disabled | Disabled | Disabled |
| 21 | Disabled | TX_and_RX | Disabled | Disabled | Disabled | Disabled |
| 22 | Disabled | TX_and_RX | Disabled | Disabled | Disabled | Disabled |
| 23 | Disabled | TX_and_RX | Disabled | Disabled | Disabled | Disabled |
| 24 | Disabled | TX_and_RX | Disabled | Disabled | Disabled | Disabled |
| 25 | Disabled | TX_and_RX | Disabled | Disabled | Disabled | Disabled |

Figure 7- 56. Basic LLDP Port Settings window

The following parameters can be set or displayed:

| Parameter | Description |
|---------------------------|---|
| Unit | Select the desired stacking unit, if applicable. |
| From...To | Select a port or group of ports using the pull-down menus. |
| Notification State | Used to configure each port for sending notification to configured SNMP trap receiver(s). Enable or disable each port for sending change notification to configured SNMP trap receiver(s) if an LLDP data change is detected in an advertisement received on the port from an LLDP neighbor. The definition of change includes new available information, information timeout, and information update. In addition, the changed type includes any data update /insert/remove. |
| Admin Status | Use the drop-down menu to choose: <i>TX_Only</i> , <i>RX_Only</i> , <i>TX_and_RX</i> , or <i>Disabled</i> . |
| Port Description | Use the drop-down menu to toggle Port Description between <i>Enabled</i> and <i>Disabled</i> . |
| System Name | Use the drop-down menu to toggle System Name between <i>Enabled</i> and <i>Disabled</i> . |

| | |
|----------------------------|---|
| System Description | Use the drop-down menu to toggle System Description between <i>Enabled</i> and <i>Disabled</i> . |
| System Capabilities | Use the drop-down menu to toggle System Capabilities between <i>Enabled</i> and <i>Disabled</i> . |

Click **Apply** to implement changes made.

802.1 Extension LLDP Port Settings

The following window is used to set up 802.1 Extension LLDP on individual port(s) on the Switch.

To view this window, click **L2 Features > LLDP > 802.1 Extension LLDP Port Settings**, as shown below.

802.1 Extension LLDP Port Settings

| | | | |
|--------------------------|------------|----------------------|------------|
| Unit | 1 ▾ | | |
| From | Port 1 ▾ | | |
| To | Port 1 ▾ | | |
| Port VLAN ID | Disabled ▾ | | |
| Protocol VLAN ID | VLAN ID ▾ | <input type="text"/> | Disabled ▾ |
| VLAN Name | VLAN ID ▾ | <input type="text"/> | Disabled ▾ |
| Protocol Identify | EAPOL ▾ | | Disabled ▾ |

802.1 Extension LLDP Port Settings Table

| Port ID | Port VLAN ID | Enabled Protocol VLAN ID | Enabled VLAN Name | Enabled Protocol Identity |
|---------|--------------|--------------------------|-------------------|---------------------------|
| 1 | Disabled | (None) | (None) | (None) |
| 2 | Disabled | (None) | (None) | (None) |
| 3 | Disabled | (None) | (None) | (None) |
| 4 | Disabled | (None) | (None) | (None) |
| 5 | Disabled | (None) | (None) | (None) |
| 6 | Disabled | (None) | (None) | (None) |
| 7 | Disabled | (None) | (None) | (None) |
| 8 | Disabled | (None) | (None) | (None) |
| 9 | Disabled | (None) | (None) | (None) |
| 10 | Disabled | (None) | (None) | (None) |
| 11 | Disabled | (None) | (None) | (None) |
| 12 | Disabled | (None) | (None) | (None) |
| 13 | Disabled | (None) | (None) | (None) |
| 14 | Disabled | (None) | (None) | (None) |
| 15 | Disabled | (None) | (None) | (None) |
| 16 | Disabled | (None) | (None) | (None) |
| 17 | Disabled | (None) | (None) | (None) |
| 18 | Disabled | (None) | (None) | (None) |
| 19 | Disabled | (None) | (None) | (None) |
| 20 | Disabled | (None) | (None) | (None) |
| 21 | Disabled | (None) | (None) | (None) |
| 22 | Disabled | (None) | (None) | (None) |
| 23 | Disabled | (None) | (None) | (None) |
| 24 | Disabled | (None) | (None) | (None) |
| 25 | Disabled | (None) | (None) | (None) |

Figure 7- 57. 802.1 Extension LLDP Port Settings Table window

The following parameters can be set or displayed:

| Parameter | Description |
|--------------------------|---|
| Unit | Select the desired stacking unit, if applicable. |
| From...To | Select a port or group of ports using the pull-down menus. |
| Port VLAN ID | Use the drop-down menu to toggle Port VLAN ID between <i>Enabled</i> and <i>Disabled</i> . |
| Protocol VLAN ID | Use the drop-down menu to toggle among <i>VLAN ID</i> , <i>VLAN Name</i> , and <i>All</i> . Use the drop-down menu to toggle between <i>Enabled</i> and <i>Disabled</i> . |
| VLAN Name | Use the drop-down menu to toggle among <i>VLAN ID</i> , <i>VLAN Name</i> , and <i>All</i> . Use the drop-down menu to toggle between <i>Enabled</i> and <i>Disabled</i> . |
| Protocol Identity | Use the drop-down menu to toggle among <i>EAPOL</i> , <i>LACP</i> , <i>GVRP</i> , <i>STP</i> , and <i>All</i> . Use the drop-down menu to toggle between <i>Enabled</i> and <i>Disabled</i> . |

Click **Apply** to implement changes made.

802.3 Extension LLDP Port Settings

The following window is used to set up 802.3 Extension LLDP on individual port(s) on the Switch.

To view this window, click **L2 Features > LLDP > 802.3 Extension LLDP Port Settings**, as shown below.

| 802.3 Extension LLDP Port Settings | | | | | | |
|--|------------------------------|--------|------------------------------|--------------------|--------------------|-------|
| Unit | From | To | MAC/PHY Configuration/Status | Link Aggregation | Maximum Frame Size | Apply |
| 1 | Port 1 | Port 1 | Disabled | Disabled | Disabled | Apply |
| 802.3 Extension LLDP Port Settings Table | | | | | | |
| Port ID | MAC/PHY Configuration/Status | | Link Aggregation | Maximum Frame Size | | |
| 1 | Disabled | | Disabled | Disabled | | |
| 2 | Disabled | | Disabled | Disabled | | |
| 3 | Disabled | | Disabled | Disabled | | |
| 4 | Disabled | | Disabled | Disabled | | |
| 5 | Disabled | | Disabled | Disabled | | |
| 6 | Disabled | | Disabled | Disabled | | |
| 7 | Disabled | | Disabled | Disabled | | |
| 8 | Disabled | | Disabled | Disabled | | |
| 9 | Disabled | | Disabled | Disabled | | |
| 10 | Disabled | | Disabled | Disabled | | |
| 11 | Disabled | | Disabled | Disabled | | |
| 12 | Disabled | | Disabled | Disabled | | |
| 13 | Disabled | | Disabled | Disabled | | |
| 14 | Disabled | | Disabled | Disabled | | |
| 15 | Disabled | | Disabled | Disabled | | |
| 16 | Disabled | | Disabled | Disabled | | |
| 17 | Disabled | | Disabled | Disabled | | |
| 18 | Disabled | | Disabled | Disabled | | |
| 19 | Disabled | | Disabled | Disabled | | |
| 20 | Disabled | | Disabled | Disabled | | |
| 21 | Disabled | | Disabled | Disabled | | |
| 22 | Disabled | | Disabled | Disabled | | |
| 23 | Disabled | | Disabled | Disabled | | |
| 24 | Disabled | | Disabled | Disabled | | |
| 25 | Disabled | | Disabled | Disabled | | |

Figure 7- 58. 802.3 Extension LLDP Port Settings Table window

The following parameters can be set or displayed:

| Parameter | Description |
|-------------------------------------|--|
| Unit | Select the desired stacking unit, if applicable. |
| From...To | Select a port or group of ports using the pull-down menus. |
| MAC/PHY Configuration/Status | Use the drop-down menu to toggle the MAC/PHY Configuration/Status between <i>Enabled</i> and <i>Disabled</i> . |
| Link Aggregation | Use the drop-down menu to toggle Link Aggregation between <i>Enabled</i> and <i>Disabled</i> . |
| Maximum Frame Size | Use the drop-down menu to toggle Maximum Frame Size between <i>Enabled</i> and <i>Disabled</i> . |

Click **Apply** to implement changes made.

LLDP Management Address Settings

The following window is used to set up LLDP management address settings on the Switch.

To view this window, click **L2 Features > LLDP > LLDP Management Address Settings**, as shown below.

| LLDP Management Address Settings | | | | | | |
|----------------------------------|----------------------------|--------|--------------|---------|------------|-------|
| Unit | From | To | Address Type | Address | Port State | Apply |
| 1 | Port 1 | Port 1 | IPv4 Address | | Disabled | Apply |
| Enabled Management Address Table | | | | | | |
| Port ID | Enabled Management Address | | | | | |
| 1 | (None) | | | | | |
| 2 | (None) | | | | | |
| 3 | (None) | | | | | |
| 4 | (None) | | | | | |
| 5 | (None) | | | | | |
| 6 | (None) | | | | | |
| 7 | (None) | | | | | |
| 8 | (None) | | | | | |
| 9 | (None) | | | | | |
| 10 | (None) | | | | | |
| 11 | (None) | | | | | |
| 12 | (None) | | | | | |
| 13 | (None) | | | | | |
| 14 | (None) | | | | | |
| 15 | (None) | | | | | |
| 16 | (None) | | | | | |
| 17 | (None) | | | | | |
| 18 | (None) | | | | | |
| 19 | (None) | | | | | |
| 20 | (None) | | | | | |
| 21 | (None) | | | | | |
| 22 | (None) | | | | | |
| 23 | (None) | | | | | |
| 24 | (None) | | | | | |
| 25 | (None) | | | | | |

Figure 7- 59. LLDP Management Address Settings window

The following parameters can be set or displayed:

| Parameter | Description |
|--------------|--|
| Unit | Select the desired stacking unit, if applicable. |
| From...To | Select a port or group of ports using the pull-down menus. |
| Address Type | Use the drop-down menu to toggle between <i>IPV4 Address</i> and <i>IPV6 Address</i> . |
| Address | Enter the LLDP management address in this field. |
| Port State | Use the drop-down menu to toggle the Port State between <i>Enabled</i> and <i>Disabled</i> . |

Click **Apply** to implement changes made.

LLDP Statistics

The following window is used to display LLDP statistics.

To view this window, click **L2 Features > LLDP > LLDP Statistics**, as shown below.

| LLDP Statistics System | | | | | | | |
|-------------------------|--------------------|-----------------------------|---------------------|--------------------|---------------------------|------------------------------|---------------------|
| Last Change Time | 4875 | | | | | | |
| Number of Table Insert | 0 | | | | | | |
| Number of Table Delete | 0 | | | | | | |
| Number of Table Drop | 0 | | | | | | |
| Number of Table Age Out | 0 | | | | | | |
| Unit | 1 | | | | | | |
| LLDP Statistics Ports | | | | | | | |
| Port ID | TxPort FramesTotal | RxPortFrames DiscardedTotal | RxPort FramesErrors | RxPort FramesTotal | RxPortTLVs DiscardedTotal | RxPortTLVs UnrecognizedTotal | RxPort AgeoutsTotal |
| 1 | 0 | 0 | 0 | 0 | 0 | 0 | 0 |
| 2 | 0 | 0 | 0 | 0 | 0 | 0 | 0 |
| 3 | 0 | 0 | 0 | 0 | 0 | 0 | 0 |
| 4 | 0 | 0 | 0 | 0 | 0 | 0 | 0 |
| 5 | 0 | 0 | 0 | 0 | 0 | 0 | 0 |
| 6 | 0 | 0 | 0 | 0 | 0 | 0 | 0 |
| 7 | 0 | 0 | 0 | 0 | 0 | 0 | 0 |
| 8 | 0 | 0 | 0 | 0 | 0 | 0 | 0 |
| 9 | 0 | 0 | 0 | 0 | 0 | 0 | 0 |
| 10 | 0 | 0 | 0 | 0 | 0 | 0 | 0 |
| 11 | 0 | 0 | 0 | 0 | 0 | 0 | 0 |
| 12 | 0 | 0 | 0 | 0 | 0 | 0 | 0 |
| 13 | 0 | 0 | 0 | 0 | 0 | 0 | 0 |
| 14 | 0 | 0 | 0 | 0 | 0 | 0 | 0 |
| 15 | 0 | 0 | 0 | 0 | 0 | 0 | 0 |
| 16 | 0 | 0 | 0 | 0 | 0 | 0 | 0 |
| 17 | 0 | 0 | 0 | 0 | 0 | 0 | 0 |
| 18 | 0 | 0 | 0 | 0 | 0 | 0 | 0 |
| 19 | 0 | 0 | 0 | 0 | 0 | 0 | 0 |
| 20 | 0 | 0 | 0 | 0 | 0 | 0 | 0 |
| 21 | 0 | 0 | 0 | 0 | 0 | 0 | 0 |
| 22 | 0 | 0 | 0 | 0 | 0 | 0 | 0 |
| 23 | 0 | 0 | 0 | 0 | 0 | 0 | 0 |
| 24 | 0 | 0 | 0 | 0 | 0 | 0 | 0 |
| 25 | 0 | 0 | 0 | 0 | 0 | 0 | 0 |

Figure 7- 60. LLDP Statistics System window

LLDP Management Address Table

The following window is used to make entries to and display the LLDP Management Address Table.

To view this window, click **L2 Features > LLDP > LLDP Management Address Table**, as shown below.

| Management Address | | IPv4 Address ▾ | <input type="text"/> | <input type="button" value="Find"/> | |
|--------------------------------------|---------|----------------|----------------------|-------------------------------------|-------------------|
| LLDP Management Address Table | | | | | |
| No. | Subtype | Address | IF Type | OID | Advertising Ports |
| 1 | IPv4 | 10.73.21.33 | Unknown | 1.3.6.1.4.1.171.10.70.8 | (None) |
| Total Entries:1 | | | | | |

Figure 7- 61. LLDP Management Address Table window

Use the drop-down menu to select the type of Management Address, enter an IP address in the field provided, and then click the **Find** button.

LLDP Local Port Table

The following window is used to display the LLDP Local Port Brief Table.

To view this window, click **L2 Features > LLDP > LLDP Local Port Table**, as shown below.

| Unit | | | | | |
|------------------------------------|-----------------|---------|------------------|----------------------|----------------------|
| 1 ▾ | | | | | |
| LLDP Local Port Brief Table | | | | | |
| No. | Port ID Subtype | Port ID | Port Description | Normal | Detailed |
| 1 | Local | 1/1 | | View | View |
| 2 | Local | 1/2 | | View | View |
| 3 | Local | 1/3 | | View | View |
| 4 | Local | 1/4 | | View | View |
| 5 | Local | 1/5 | | View | View |
| 6 | Local | 1/6 | | View | View |
| 7 | Local | 1/7 | | View | View |
| 8 | Local | 1/8 | | View | View |
| 9 | Local | 1/9 | | View | View |
| 10 | Local | 1/10 | | View | View |
| 11 | Local | 1/11 | | View | View |
| 12 | Local | 1/12 | | View | View |
| 13 | Local | 1/13 | | View | View |
| 14 | Local | 1/14 | | View | View |
| 15 | Local | 1/15 | | View | View |
| 16 | Local | 1/16 | | View | View |
| 17 | Local | 1/17 | | View | View |
| 18 | Local | 1/18 | | View | View |
| 19 | Local | 1/19 | | View | View |
| 20 | Local | 1/20 | | View | View |
| 21 | Local | 1/21 | | View | View |
| 22 | Local | 1/22 | | View | View |
| 23 | Local | 1/23 | | View | View |
| 24 | Local | 1/24 | | View | View |
| 25 | Local | 1/25 | | View | View |

Figure 7- 62. LLDP Local Port Brief Table window

Click the **View** button to display additional information about entries on the LLDP Local Port Brief Table.

LLDP Remote Port Table

The following window is used to display the LLDP Remote Port Brief Table.

To view this window, click **L2 Features > LLDP > LLDP Remote Port Table**, as shown below.

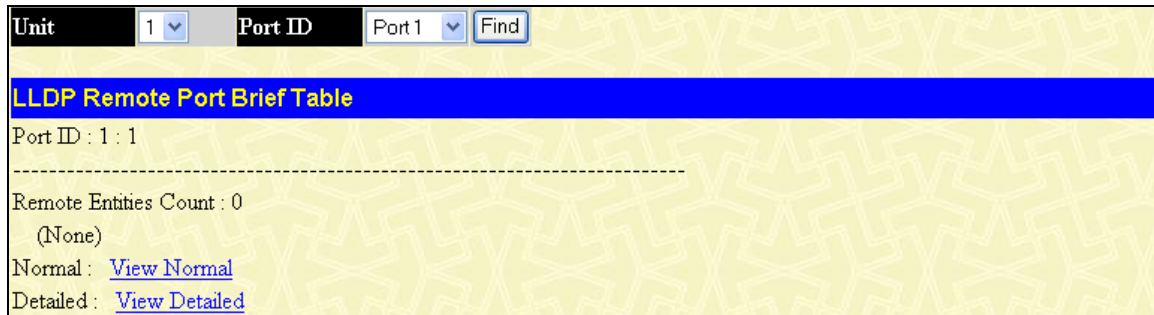

Figure 7- 63. LLDP Remote Port Brief Table window

Click the [View Normal](#) and [View Detailed](#) hyperlinks to display additional information.

QinQ

QinQ is designed for service providers to carry traffic from multiple users across a network. QinQ is used to maintain customer specific VLAN and Layer 2 protocol configurations even when the same VLAN ID is being used by different customers. This is achieved by inserting SPVLAN tags into the customer's frames when they enter the service provider's network, and then removing the tags when the frames leave the network.

Customers of a service provider may have different or specific requirements regarding their internal VLAN IDs and the number of VLANs that can be supported. Therefore customers in the same service provider network may have VLAN ranges that overlap, which might cause traffic to become mixed up. So assigning a unique range of VLAN IDs to each customer might cause restrictions on some of their configurations requiring intense processing of VLAN mapping tables which may exceed the VLAN mapping limit. QinQ uses a single service provider VLAN (SPVLAN) for customers who have multiple VLANs. Customer's VLAN IDs are segregated within the service provider's network even when they use the same customer specific VLAN ID. QinQ expands the VLAN space available while preserving the customer's original tagged packets and adding SPVLAN tags to each new frame.

QinQ Global Settings

This function allows the user to enable or disable the QinQ function.

To view this window click **L2 Features > QinQ > Global Settings**, as shown.

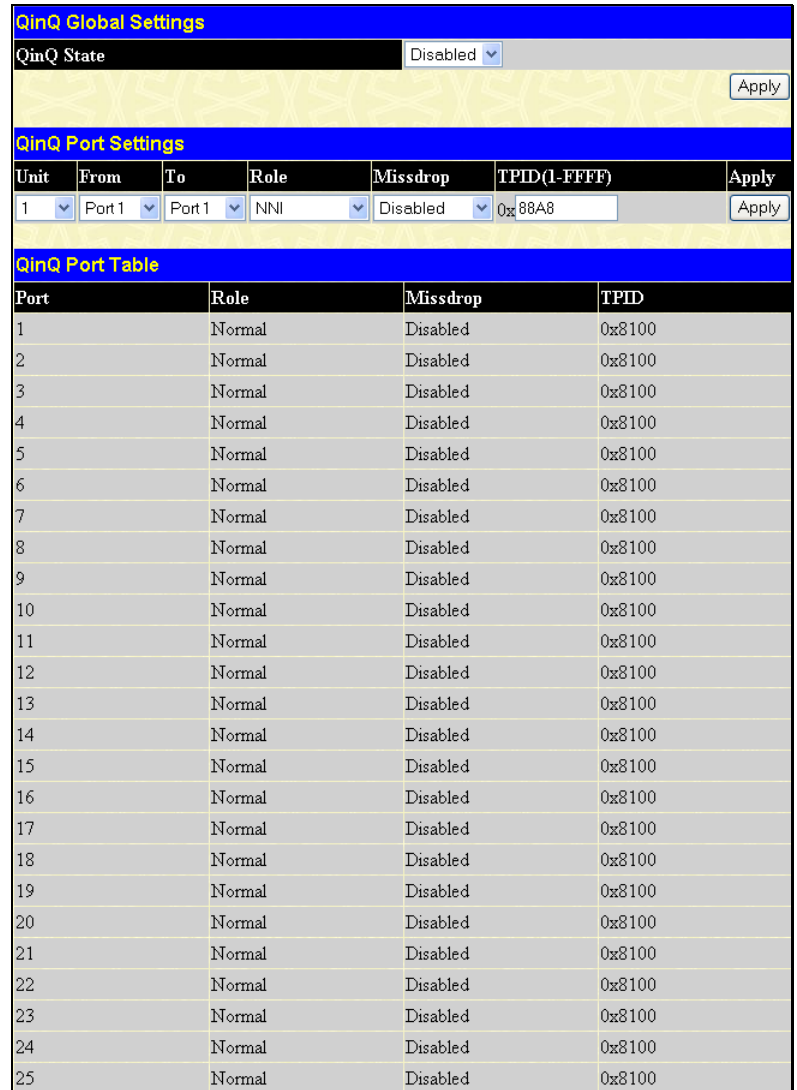

QinQ Global Settings

QinQ State: Disabled [Apply]

QinQ Port Settings

| Unit | From | To | Role | Missdrop | TPID(1-FFFF) | Apply |
|------|--------|--------|------|----------|--------------|---------|
| 1 | Port 1 | Port 1 | NNI | Disabled | 0x88A8 | [Apply] |

QinQ Port Table

| Port | Role | Missdrop | TPID |
|------|--------|----------|--------|
| 1 | Normal | Disabled | 0x8100 |
| 2 | Normal | Disabled | 0x8100 |
| 3 | Normal | Disabled | 0x8100 |
| 4 | Normal | Disabled | 0x8100 |
| 5 | Normal | Disabled | 0x8100 |
| 6 | Normal | Disabled | 0x8100 |
| 7 | Normal | Disabled | 0x8100 |
| 8 | Normal | Disabled | 0x8100 |
| 9 | Normal | Disabled | 0x8100 |
| 10 | Normal | Disabled | 0x8100 |
| 11 | Normal | Disabled | 0x8100 |
| 12 | Normal | Disabled | 0x8100 |
| 13 | Normal | Disabled | 0x8100 |
| 14 | Normal | Disabled | 0x8100 |
| 15 | Normal | Disabled | 0x8100 |
| 16 | Normal | Disabled | 0x8100 |
| 17 | Normal | Disabled | 0x8100 |
| 18 | Normal | Disabled | 0x8100 |
| 19 | Normal | Disabled | 0x8100 |
| 20 | Normal | Disabled | 0x8100 |
| 21 | Normal | Disabled | 0x8100 |
| 22 | Normal | Disabled | 0x8100 |
| 23 | Normal | Disabled | 0x8100 |
| 24 | Normal | Disabled | 0x8100 |
| 25 | Normal | Disabled | 0x8100 |

Figure 7- 64. QinQ Global Settings window

The following fields can be set:

| Parameter | Description |
|--------------------------|---|
| QinQ Global State | Use the pull down menu to <i>Enable</i> or <i>Disable</i> the QinQ Global State. When QinQ is <i>Enabled</i> , all network port roles will have NNI ports and their outer TPID set to 0x88a8. All existing static VLANs will run as SP-VLANs. All dynamically learned L2 addresses and all dynamically registered VLAN entries will be cleared, GVRP will be disabled. According 802.1ad, the address 01-80-c2-00-00-08 will be used for STP in the provider's network. So the user shall disable STP first, and then use the new address for STP state machine. The default setting is <i>Disabled</i> . |
| From...To | A consecutive group of ports that are part of the VLAN configuration starting with the selected port. |
| Role | The user can choose between UNI or NNI role. <i>UNI</i> – To select a user-to-network interface which specifies that communication between the specified user and a specified network will occur. <i>NNI</i> – To select a network-to-network interface specifies that communication between two specified networks will occur. |
| Missdrop | <i>Enable</i> or <i>Disable</i> C-VLAN based on SP-VLAN assignment miss drop. When enabled the |

| | |
|-------------------------|---|
| | <p>tagged packet will be dropped if the VLAN translation look up misses. When disabled the packet will not be dropped if the VLAN translation loop up misses. If VLAN translation table lookup misses, the packet can be either dropped or add an outer VLAN based on MAC/SUBNET/PROTOCOL/PORT based VLAN configuration. This will make the packet as a double tagged packet.</p> <p>Note: The result will be Transparent Mode behavior.</p> |
| TPID(0x1-0xffff) | The Outer TPID is used for learning and switching packets. The Outer TPID constructs and inserts the outer tag into the packet based on the VLAN ID. |

Click **Apply** to implement changes.

VLAN Translation Settings

The VLAN translation settings translates the VLAN ID carried in the data packets it receives from private networks into those used in the Service Providers network.

To view this window, click **L2 Features > QinQ > VLAN Translation Settings**, as shown below.

Figure 7- 65. VLAN Translation Settings window

The following fields can be set:

| Parameter | Description |
|----------------------|---|
| Unit | Select the unit you wish to configure. |
| From...To | A consecutive group of ports that are part of the VLAN configuration starting with the selected port. |
| CVID List | The customer VLAN ID List to which the tagged packets will be added. |
| Action | Specify if you want SPVID packets to be added or replaced. |
| SPVID(1-4094) | This configures the VLAN to join the Service Providers VLAN as a tagged member. |
| Priority | Select a priority for the VLAN ranging from 0-7. With 7 having the highest priority. |

Click **Apply** to create a new entry, click **Find By Ports** to view the current entries by ports and **Delete All** to remove a VLAN Translation entry. To view the VLAN translation table, click the hyperlinked [Show All VLAN Translation Table](#).

Section 8

L3 Features

Interface Settings

MD5 Key Settings

Route Redistribution Settings

Multicast Static Route Settings

Static/Default Route Settings

Route Preference Settings

Static ARP Settings

Gratuitous ARP Settings

Policy Route Settings

ECMP Algorithm Settings

RIP

OSPF

DCHP/BOOTP Relay

DHCP Server

DNS Relay

VRRP

IP Multicast Routing Protocol

The following section will aid the user in configuring security functions for the Switch. The Switch includes various functions for IP Interface Settings, MD5 Key Settings, Route Redistribution Settings, Multicast Static Route Settings, Static/Default Route Settings, Route Preference Settings, Policy Route Settings, Static ARP Settings, Gratuitous ARP Settings, Routing Table, RIP, OSPF, DCHP/BOOTP Relay, DNS Relay, VRRP, and IP Multicast Routing Protocol, all discussed in detail in the following section.

IPv6

The Switch has the capability to support the following:

IPv6 unicast, multicast and anycast addresses

Allow for IPv6 packet forwarding

IPv6 fragmentation and re-assembly

Processing of IPv6 packet and extension headers

Static IPv6 route configuration

IPv6 Neighbor Discovery

Link-Layer Address resolution, Neighbor Unreachability Detection and Duplicate Address Detection over broadcast mediums (ex: Ethernet)

Send Router Advertisement

ICMPv6 functionality

The following sections will briefly explain IPv6, its functionality and how IPv6 is implemented on this Switch.

Overview

IP version 6 is the logical successor to IP version 4. It was known that IPv4 could not support the amount of addresses that would eventually be needed for not only each person, but each device that would require an IP address, and therefore a system with a larger pool of IP addresses was required. IPv6 has addressed that issue, along with other issues that enhance routing over the network, provide better security and improve Quality of Service for Internet users. Some of the improvements made were:

Expanding the Capabilities for IP Addressing – IPv6 has increased the size of the IP address from 32 bits to 128 bits. As a result, the addressing hierarchy has been greatly expanded, more nodes now have the capability of having a unique IP address and the method of assigning an IP address to an interface has become cleaner and quicker. Unicast and multicast addresses still exist but in a purer form and multicast addresses now have a scope field that increases the scalability of multicast routing. Also, an anycast address has been added, which will send packets to the closest node that is a part of a group of nodes, thereby eliminating a specified device for a particular group.

Simplifying the Packet Header – The IPv6 packet header has been simplified from IPv4 as some headers have been modified or dropped altogether, which improves processing speed and cost. The IPv6 header now has a fixed length of 40 bytes consisting of an 8-byte header and two 16-byte IP addresses (source and destination).

Extensions and Options Enhancement – Packet header option fields encoding has been enhanced to allow for proficient forwarding of packets due to lesser restrictions on packet option length and encoding method. This enhancement will also allow new option fields to be integrated into the IPv6 system without hassles and limitations. These optional headers are placed between the header and the payload of a packet, if they are necessary at all.

Authentication and Privacy Extension Support – New authentication capabilities use extensions for data integrity and data confidentiality for IPv6.

Flow Labeling – This new capability allows packets to be streamlined into certain traffic “flows” if labeled by the sender. In this way, services such as “real time services or non-default quality of service can receive special attention for improved flow quality.

Packet Format

As in IPv4, the IPv6 packet consists of the packet header and the payload, but the difference occurs in the packet header that has been amended and improved for better packet flow and processing. The following will outline and detail the IPv6 enhancements and parts of the IPv6 packet, with special attention to the packet header.

IPv6 Header

The IPv6 packet header has been modified and simplified from IPv4. The header length, identification, flags, fragment offset and header checksum have all been removed in the IPv6 header due to lack of necessity or improvement to a better function of the header. The minimum header length is now 20 bytes but may be increased to as much as 60 bytes, using 4-byte increment extensions. The following picture is an example of an IPv6 packet header.

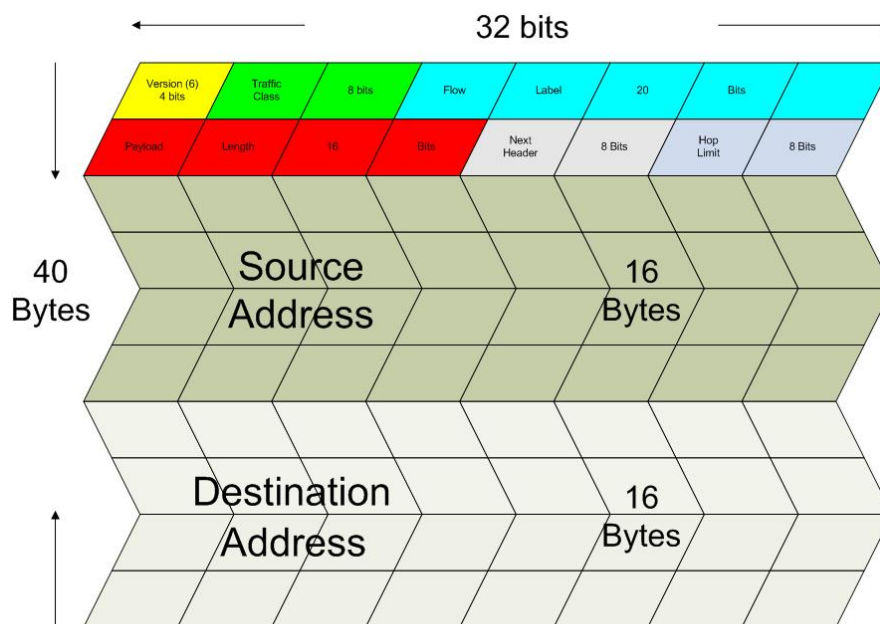

Standard IPv6 Packet Header

Eight fields make up the basic IPv6 packet header:

Version – This 4-bit field defines the packet version, which is IPv6 and is defined as the number 6.

Traffic Class – This 1-byte field replaces the Type of Service field used in IPv4 and is used to process real-time data and other data requiring special packet management. This field defines the Class of Service priority of an IPv6 packet.

Flow Label – This 20-bit field is used to facilitate the handling of real-time traffic. Hosts sending data can place a flow label into this field to identify a sequence of packets that have an identical set of options. In this way, router can process these packets more efficiently once the flow class has been identified and the rest of the packet header no longer needs to be fully processed, just the flow label and the source address. All flow label packets must have identical source and destination addresses.

Payload Length – Known as the datagram length in IPv4, this 16-bit field specifies the length of the IPv6 data carried after the header of the packet. Extension headers are considered part of the payload and are included in the length specified here.

Next Header – This 8-bit field is used to identify the header immediately following the IPv6 header. When this field is set after the hop-by-hop header, it defines the extension header that will appear after the destination address. Each extension header must be preceded by a Next Header field. Integers used to define extension headers in the next Header field use the same values as IPv4 (ex: 6=TCP, 17=UDP, etc.).

Hop Limit - Similar to the TTL field in IPv4, this 8-bit field defines the number of hops remaining after the packet has been processed by a node, instead of the number of seconds left to live as on an IPv4 network. This field will decrement by one after every node it passes and the packet will be discarded once this field reaches zero.

Source Address – This 16-byte field defines the IPv6 address of the source node sending the packet.

Destination Address – This 16-byte field defines the IPv6 address of the destination node receiving the packet. This may or may not be the final destination node of this packet, depending on the routing header, if present.

Extension Headers

Extension headers are used to identify optional parameters regarding IPv6 packets such as routing, fragmentation of packets or authentication parameters. The types of extension headers supported are Hop-by-Hop, Routing, Fragment, Destination Options, Authentication and Encapsulating Security Payload. These extension headers are placed between the IPv6 packet header and the payload and are linked together by the aforementioned Next Header, as shown below.

| | |
|--|--------------------------|
| IPv6 header Next Header = TCP | TCP header + data |
|--|--------------------------|

| | | |
|--|---|--------------------------|
| IPv6 header Next Header = Routing | Routing Header Next Header = TCP | TCP header + data |
|--|---|--------------------------|

| | | | |
|--|---|---|--------------------------|
| IPv6 header Next Header = Destination Options | Destination Options Header Next Header = Routing | Routing Header Next Header = TCP | TCP header + data |
|--|---|---|--------------------------|

Each header has a specific place in the header chain and must follow the following order:

- IPv6 Header
- Hop-By-Hop Header (Must follow the IPv6 header)
- Destination Options
- Routing Header
- Fragment Header
- Authentication Header
- Encapsulating Security Payload Header
- Destination Options Header
- Upper Layer Header

There may be zero, one or more extension headers in the IPv6 header, they must be processed in order and they are to be in increments of 8 octets in the IPv6 packet. Nodes that do not recognize the field of the extension header will discard the packet and send a relevant ICMPv6 message back to the source.

Packet Fragmentation

At times, packets are sent out to a destination that exceed the size of the Path MTU, so the source node is required to split these packets into fragments in individual packets which will be rebuilt when it reaches its final destination. Each of the packets that will be fragmented is given an Identification value, by the source node. It is essential that each of these Identification values is different than any other fragmented packet recently sent that include the same source and destination address. The original packet is divided into two parts, a fragmentable part and an unfragmentable part. The unfragmentable part of the packet consists of the IPv6 header and any extension headers present, up to the routing extension header. The fragmentable part has the payload plus any

main purpose of the anycast address is to identify a set of routers owned by an organization providing Internet service. It could also be used to identify a set of routers connected to a particular subnet or permitting entrance to a specific routing domain.

Two other special types of addresses exist in IPv6. The **unspecified address** has a value of 0:0:0:0:0:0:0:0 which is comparable to the 0.0.0.0 address in IPv4. This address is used to indicate the lack of a valid IP address on a node and may be used by a device when booting and requesting address configuration notification. In its IPv6 condensed form, it appears as “::” and should not be statically or dynamically assigned to an interface, nor should it be the destination address of an IPv6 packet, or located within the routing header.

The second type of special address is the **loopback address** which is represented by 0:0:0:0:0:0:0:1, or ::1 in its compressed form. It is akin to the 127.0.0.1 address in IPv4 and is used in troubleshooting and testing IP stacks. This address, like the unspecified address, and should not be statically or dynamically assigned to an interface.

ICMPv6

Network professionals are already very familiar with ICMP for IPv4, which is an essential tool in the IPv4 network, relaying messages about network problems and the general condition of the network. ICMPv6 is the successor to the IPv4 version and performs many of the same basic functions as its precursor, yet is not compatible with ICMPv4. ICMPv6 has made improvements over its forerunner, with such enhancements as managing multicast group memberships and allowing for neighbor discovery by resolving link-layer addresses attached to the same link and identifying changes in those addresses. ICMP can also discover routers, determine which neighbors can be reached and map IP addresses to MAC addresses within the network. ICMPv6 is a vital part of the IPv6 network and must be implemented on every IPv6 node for operations to function normally.

Two kinds of ICMP messages are apparent on the IPv6 network:

Error Messages – ICMP error messages are sent out on the network when packet sizes exceed the path MTU (Maximum Transfer Unit), when the hop count of the IPv6 packet has been surpassed, when messages cannot reach their intended destination and when there are parameter problems within the IPv6 packet.

Informational Messages – ICMP informational messages send out packets describing current network information valuable to devices on the network. A common and useful ICMPv6 informational message is the ping program use to discover the availability a device, by using a ping request and reply format. Other informational messages include Path MTU discovery that is used to determine the maximum size of data packets that can be allowed to be transferred, and Neighbor Discovery messages which discover routers that can forward packets on the network. Neighbor discovery will be discussed in greater detail later in the next section.

Neighbor Discovery

Neighbor discovery is a new feature incorporated in IPv6. In IPv4, no means were available to tell if a neighbor could be reached. Now, combining ICMP messages and ARP, neighbors can be detected and their layer 2 addresses (MAC Address) can be identified. This feature can also discover neighboring routers that can forward packets and keep track of the reachability of routers, as well as if changes occur within link-layer addresses of nodes on the network or identical unicast addresses are present on the local link.

The functionality of the Neighbor Discovery feature is based on ICMPv6 packets, Neighbor Solicitation and Router Advertisement messages circulating on the network. When a node wishes to determine link layer addresses of other nodes on the same link, it produces a Neighbor Solicitation message to be circulated on the local link. When received by a neighbor, this neighbor will produce Router Advertisements immediately to be returned. These Router Advertisements will contain a multicast address as the destination address and have an ICMP type of 134 (the specified number for Router Advertisements), as well as having the link-layer address of the node sending the advertisement. Router Advertisement messages may be periodic, specified in the advertisement by having the all-nodes multicast address FF02::1, or sent out as a result of receiving a Neighbor Solicitation message, specified in the advertisement by having the address of the interface that first sent the solicitation message. Once confirmation of the Neighbor has been reached, packets can now be exchanged on the link.

Neighbor Unreachability Detection

At times on the network, problems occur in reaching the Neighbor node or getting a response from the Neighbor. A neighbor is considered reachable when it has received and processed packets sent to it, and in return sends a packet back notifying a affirmative response. This response may come in the form of an indication from an upper-layer protocol, like TCP, noting that progress is being made, or in response from a Neighbor Solicitation message in the form of a Router Advertisement message. If responses are not received from the node, it is considered unreachable and a Destination Unreachable message is received in the form of an ICMP packet. This Destination Unreachable ICMP packet will contain the reason for the fault, located in the code field of the ICMP header. Five possible reasons for the failure can be stated:

1. There is no route or destination (Code 0).
2. Communication has been administratively prohibited, such as a firewall or filter (Code 1)
3. Beyond the scope of the source address, when the multicast scope of the source address is smaller than the scope of the destination address (Code 2)

4. The address is unreachable (Code 3)
5. The port is unreachable (Code 4)

Duplicate Address Detection (DAD)

DAD messages are used to specify that there is more than one node on a local link possessing the same IP address. IPv6 addresses are only leased for a defined period of time. When that time expires, the address will become invalid and another address must be addressed to the node. To ensure that this new address is unique on the local link, a node runs a DAD process to determine the uniqueness of the new address. This is done through the use of a Neighbor Solicitation message containing a Tentative address. This message will detect if another node on the local link has this Tentative address. If the Tentative address is found on another node, that node will send out a Neighbor Advertisement message, the process will be terminated, and manual configuration will be necessary. If no answer is forthcoming regarding this Neighbor Solicitation message containing the tentative address, the address is allotted to the node and connectivity is established.

Assigning IP Addresses

For IPv4 addresses, users may only assign one address per interface and only one address may be used on a particular VLAN. Yet, IPv6 addresses are different. All IPv6 interfaces on the switch must have at least one IPv6 link-local unicast address, if the user is employing the IPv6 addressing scheme. Multiple IPv6 addresses may be configured for IPv6 interfaces, regardless of type, whether it is unicast, multicast or anycast. The scope of the address has some bearing on the assigning multiple addresses to a single interface as well. If multiple physical interfaces are considered as one interface on the Internet layer, multiple unicast addresses may be allotted to multiple physical interfaces, which would be beneficial for load sharing on these interfaces. This is dependent on these unicast addresses having a scope smaller than the link-local address, if these unicast addresses are not the source or destination address for IPv6 packets to or from address that are not IPv6 neighbors of the interface in question.

IP Multinetting

IP Multinetting is a function that allows multiple IP interfaces to be assigned to the same VLAN. This is beneficial to the administrator when the number of IPs on the original interface is insufficient and the network administrator wishes not to resize the interface. IP Multinetting is capable of assigning another IP interface on the same VLAN without affecting the original stations or settings of the original interface.

Two types of interfaces are configured for IP multinetting, primary and secondary, and every IP interface must be classified as one of these. A primary interface refers to the first interface created on a VLAN, with no exceptions. All other interfaces created will be regarded as secondary only, and can only be created once a primary interface has been configured. There may be five interfaces per VLAN (one primary, and up to four secondary) and they are, in most cases, independent of each other. Primary interfaces cannot be deleted if the VLAN contains a secondary interface. Once the user creates multiple interfaces for a specified VLAN (primary and secondary), that set IP interface cannot be changed to another VLAN.



Application Limitation: A multicast router cannot be connected to IP interfaces that are utilizing the IP Multinetting function.



NOTE: Only the primary IP interface will support the BOOTP relay agent.

IP Multinetting is a valuable tool for network administrators requiring a multitude of IP addresses, but configuring the Switch for IP multinetting may cause troubleshooting and bandwidth problems, and should not be used as a long term solution. Problems may include:

- The Switch may use extra resources to process packets for multiple IP interfaces.
- The amount of broadcast data, such as RIP update packets and PIM hello packets, will be increased.

Interface Settings

The IP Address may initially be set using the console interface prior to connecting to it through the Ethernet. If the Switch IP address has not yet been changed, read the introduction of the *xStack® DGS-3600 Series CLI Manual* or return to Section 4 of this manual for more information. To change IP settings using the web manager users must access the **IP Address** window located in the **Administration** folder.

The web manager contains two folders for which to setup IP interfaces on the switch, one for IPv4 addresses, named **IPv4 Interface Settings**, and one for IPv6 addresses, named **IPv6 Interface Settings**.



NOTE: After properly configuring an IP interface on the Switch, each VLAN can be routed without any additional steps.

IPv4 Interface Settings

To view this window, click **L3 Features > Interface Settings > IPv4 Interface Settings**, as shown below.

| Interface Name | IP Address | Subnet Mask | VLAN Name | Secondary | Proxy ARP | Proxy Local ARP | Active | Modify | Delete |
|----------------|-------------|-------------|-----------|-----------|-----------|-----------------|---------|--------|--------|
| System | 10.73.21.33 | 255.0.0.0 | default | False | Disabled | Disabled | Enabled | Modify | X |

Figure 8- 1. IPv4 Interface Settings window

To manually assign the Switch's IPv4 address and its related configurations, click the **Add** button, revealing the following window to configure.

| IPv4 Interface Settings - Add | |
|---|---|
| Interface Name | <input type="text"/> |
| IP Address | <input type="text" value="0.0.0.0"/> |
| Subnet Mask | <input type="text" value="0.0.0.0"/> |
| VLAN Name | <input type="checkbox"/> <input type="text"/> |
| Interface Admin State | Disabled <input type="button" value="v"/> |
| Secondary | False <input type="button" value="v"/> |
| Proxy ARP | Disabled <input type="button" value="v"/> |
| Proxy Local ARP | Disabled <input type="button" value="v"/> |
| <input type="button" value="Apply"/> | |
| Show All IP Interface Entries | |

Figure 8- 2. IPv4 Interface Settings – Add window

To modify an existing Interface, click that interface's **Modify** button, which will produce this window:

Figure 8- 3. IPv4 Interface Settings – Edit window

Enter a name for the new interface to be added in the Interface Name field (if editing an IP interface, the Interface Name will already be in the top field as seen in the window above). Enter the interface’s IP address and subnet mask in the corresponding fields. Pull the Interface Admin State pull-down menu to *Enabled* and click **Apply** to enter to make the IP interface effective. To view entries in the **IPv4 Interface Settings** window, click the [Show All IP Interface Entries](#) hyperlink. Use the **Save Changes** window to enter the changes into NV-RAM.

The following fields can be set or modified:

| Parameter | Description |
|-------------------------------|--|
| Interface Name | This field displays the name for the IP interface or is used to add a new interface to be created by the user. The default IP interface is named “System”. |
| IP Address | This field allows the entry of an IPv4 address to be assigned to this IP interface. |
| Subnet Mask | This field allows the entry of a subnet mask to be applied to this IP interface. |
| VLAN Name | This field states the VLAN Name directly associated with this interface. |
| Interface Admin. State | Use the pull-down menu to enable or disable configuration on this interface. |
| Secondary | Use the pull-down menu to set the IP interface as <i>True</i> or <i>False</i> . <i>True</i> will set the interface as secondary and <i>False</i> will denote the interface as the primary interface of the VLAN entered above. <i>Secondary</i> interfaces can only be configured if a <i>primary</i> interface is first configured. |
| Proxy ARP | Use the pull-down menu to <i>Enable</i> or <i>Disable</i> the proxy ARP state on the IP interface. |
| Proxy Local ARP | Use the pull-down menu to <i>Enable</i> or <i>Disable</i> the proxy local ARP. This function allows the Switch to respond to the proxy ARP, if the source IP and destination IP are in the same interface. |

Click **Apply** to implement changes made.



NOTE: The Switch's factory default IP address is 10.90.90.90 with a subnet mask of 255.0.0.0 and a default gateway of 0.0.0.0.

IPv6 Interface Settings

The following window is used to setup IPv6 interfaces and addresses for the switch.

To view this window, click **Interface Settings > IPv6 Interface Settings**, as shown below.

| Interface Name | VLAN Name | Active | Modify | Delete |
|----------------|-----------|---------|--------|--------|
| System | default | Enabled | Modify | X |

Figure 8- 4. IPv6 Interface Settings window

To add a new IPv6 interface, click the **Add** button, which will display the following window.

Figure 8- 5. IPv6 Interface Settings – Add window

To add an Interface, enter an Interface Name in the field provided, along with a corresponding VLAN Name, set the Interface Admin. State to *Enabled* and click **Apply**. Newly created interfaces will appear in the **IPv6 Interface Settings** window.

To change the settings for a configured Interface, click the corresponding **Modify** button, which will display the following window for the user to configure.

| IPv6 Interface Settings - Edit | |
|---|----------|
| Interface Name | System |
| Automatic Link Local Address | Disabled |
| Link-Local Address | |
| Global Unicast Address | |
| VLAN Name | default |
| Interface Admin State | Enabled |
| Hop Limit | 64 |
| IPv6 Address | |
| NS Retransmit Time (ms) | 0 |
| Prefix Options | |
| Prefix | |
| Preferred Life Time | 0 |
| Valid Life Time | 0 |
| On Link Flag | Disabled |
| Autonomous Flag | Disabled |
| Router Advertisement Settings | |
| RA Router Advertisement | Disabled |
| RA Router Life Time (s) | 1800 |
| RA Reachable Time | 1200000 |
| RA Retransmit Time (ms) | 0 |
| RA Managed Flag | Disabled |
| RA Other Configure Flag | Disabled |
| RA Max Router AdvInterval (s) | 600 |
| RA Min Router AdvInterval (s) | 198 |
| <input type="button" value="Apply"/> | |
| Show All IPv6 Interface Entries | |

Figure 8- 6. IPv6 Interface Settings – Edit window

The following fields may be viewed or modified. Click **Apply** to set changes made.

| Parameter | Description |
|-------------------------------------|--|
| Interface Name | This field displays the name for the IP interface or is used to add a new interface or change an existing interface name. |
| Automatic Link Local Address | Use this pull-down menu to enable or disable this feature. When enabled, the switch will automatically create an IPv6 link-local address for the switch. Once the user enables this feature and clicks Apply , an IPv6 address will be produced based on the MAC address of the switch and the new entry will appear in the following Link-Local Address field. |
| Link-local Address | This field displays the IPv6 address created automatically by the Switch, based on the MAC Address of the Switch. This is a site local address used only for local routing. |
| Global Unicast Address | This field is the unicast address that will be used by the Switch for packets coming from outside the site-local address, or the public IPv6 address, when connected directly to the Internet. |
| VLAN Name | This field states the VLAN Name directly associated with this interface and may be modified by entering a new pre-configured VLAN Name. |
| Interface Admin State | Use the pull-down menu to enable or disable configuration on this interface. |
| Hop Limit | This field sets the number of nodes that this Router Advertisement packet will pass before being dropped. This number is set to depreciate by one after every node it reaches and will be dropped once the Hop Limit reaches 0. The user may set the Hop Limit between 1 |

| | |
|--------------------------------------|--|
| | and 255 with a default value of 64. |
| IPv6 Address | Use this field to set a Global Unicast Address for the Switch. This address will be used to access the network outside of the local link. |
| NS Retransmit Time (ms) | Use this field to set the interval, in seconds that this Switch will produce Neighbor Solicitation packets to be sent out over the local network. This is used to discover IPv6 neighbors on the local link. The user may select a time between 0 and 65535 milliseconds. Very fast intervals, represented by a low number, are not recommended for this field. |
| Prefix Options | |
| Prefix | Use this field to set a prefix for Global Unicast IPv6 addresses to be assigned to other nodes on the link-local network. This prefix is carried in the Router Advertisement message to be shared on the link-local network. The user must first have a Global Unicast Address set for the Switch. |
| Preferred Life Time | This field states the time that this prefix is advertised as being preferred on the link local network, when using stateless address configuration. The user may configure a time between 0 and 4294967295 milliseconds, with a default setting of 604800 milliseconds. |
| Valid Life Time | This field states the time that this prefix is advertised as valid on the link local network, when using stateless address configuration. The user may configure a time between 0 and 4294967295 milliseconds. |
| On Link Flag | Setting this field to <i>Enabled</i> will denote, within the IPv6 packet, that the IPv6 prefix configured here is assigned to this link-local network. Once traffic has been successfully sent to these nodes with this specific IPv6 prefix, the nodes will be considered reachable on the link-local network. |
| Autonomous Flag | Setting this field to <i>Enabled</i> will denote that this prefix may be used to autoconfigure IPv6 addresses on the link-local network. |
| Router Advertisement Settings | |
| RA Router Advertisement | Use this pull-down menu to enable or disable the switch as being capable of accepting solicitation from a neighbor, and thus becoming an IPv6 neighbor. Once enabled, this Switch is now capable of producing Router Advertisement messages to be returned to querying neighbors. |
| RA Router Life Time (s) | This time represents the validity of this interface to be the default router for the link-local network. A value of 0 represents that this Switch should not be recognized as the default router for this link-local network. The user may set a time between 0 and 9000 seconds with a default setting of 1800 seconds. |
| RA Reachable Time | This field will set the time that remote IPv6 nodes are considered reachable. In essence, this is the Neighbor Unreachability Detection field once confirmation of the access to this node has been made. The user may set a time between 0 and 3600000 milliseconds with a default setting of 1200000 milliseconds. A very low value is not recommended. |
| RA Retransmit Time (ms) | Used to set an interval time between 0 and 4294967295 milliseconds for the dispatch of router advertisements by this interface over the link-local network, in response to a Neighbor Solicitation message. If this Switch is set as the default router for this local link, this value should not exceed the value stated in the Life Time field previously mentioned. Setting this field to zero will specify that this switch will not specify the Retransmit Time for the link-local network. (and therefore will be specified by another router on the link-local network. The default value is 0 milliseconds. |
| RA Managed Flag | Use the pull-down menu to enable or disable the Managed flag. When enabled, this will trigger the router to use a stateful autoconfiguration process to get both Global and link-local IPv6 addresses for the Switch. The default setting is <i>Disabled</i> . |
| RA Other Configure Flag | Use the pull-down menu to enable or disable the Other Configure flag. When enabled, this will trigger the router to use a stateful autoconfiguration process to get configuration information that is not address information, yet is important to the IPv6 settings of the Switch. The default setting is <i>Disabled</i> . |

| | |
|--------------------------------------|---|
| RA Max Router AdvInterval (s) | Used to set the maximum interval time between the dispatch of router advertisements by this interface over the link-local network. This entry must be no less than 4 seconds (4000 milliseconds) and no more than 1800 seconds. The user may configure a time between 4 and 1800 seconds with a default setting of 600 seconds. |
| RA Min Router AdvInterval (s) | Used to set the minimum interval time between the dispatch of router advertisements by this interface over the link-local network. This entry must be no less than 3 seconds and no more than .75 (3/4) of the MaxRtrAdvInterval. The user may configure a time between 3 and 1350 seconds with a default setting of 198 seconds. |

Click **Apply** to save changes made.

MD5 Key Settings

This window allows the entry of a 16-character Message Digest – version 5 (MD5) key that can be used to authenticate every packet exchanged between OSPF routers. It is used as a security mechanism to limit the exchange of network topology information to the OSPF routing domain. MD5 Keys created here can be used in the OSPF windows below.

To configure an MD5 Key, click **L3 Features > MD5 Key Settings**, as shown below.

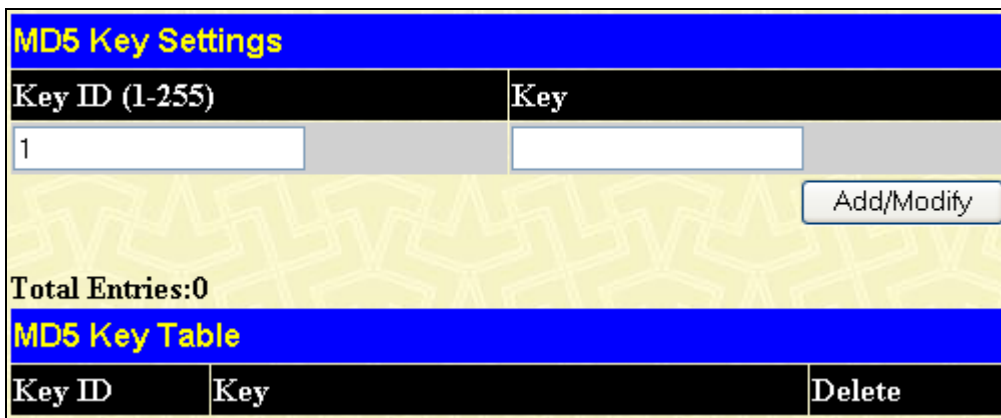



Figure 8- 7. MD5 Key Settings window

The following fields can be set:

| Parameter | Description |
|-----------------------|---|
| Key ID (1-255) | A number from 1 to 255 used to identify the MD5 Key. |
| Key | A alphanumeric string of between 1 and 16 case-sensitive characters used to generate the Message Digest which is in turn, used to authenticate OSPF packets within the OSPF routing domain. |

Click **Apply** to enter the new Key ID settings. To delete a Key ID entry, click the corresponding  under the Delete heading.

Route Redistribution Settings

Route redistribution allows routers on the network, which are running different routing protocols to exchange routing information. This is accomplished by comparing the routes stored in the various routers' routing tables and assigning appropriate metrics. This information is then exchanged among the various routers according to the individual router's current routing protocol. The Switch can redistribute routing information between the OSPF and RIP routing protocols to all routers on the network that are running OSPF or RIP. Routing information entered into the Static Routing Table on the local Switch is also redistributed.

Entering the metric 0 specifies transparency.

This window will redistribute routing information between the OSPF and RIP routing protocols to all routers on the network that are running OSPF or RIP.

To access the **Route Redistribution Settings** window, click **L3 Features > Route Redistribution Settings**, as shown below.

| Route Redistribution Settings | | | | |
|-------------------------------|---------------|------|---|--------|
| Dst. Protocol | Src. Protocol | Type | Metric (0-16) | |
| RIP | RIP | All | <input type="text"/> | |
| | | | <input type="button" value="Add/Modify"/> | |
| Route Redistribution Table | | | | |
| Src. Protocol | Dst. Protocol | Type | Metric | Delete |

Figure 8- 8. Route Redistribution Settings window

The following parameters may be set or viewed:

| Parameter | Description |
|----------------------|--|
| Dst. Protocol | Allows for the selection of the protocol for the destination device. Choose between <i>RIP</i> and <i>OSPF</i> . |
| Src. Protocol | Allows for the selection of the protocol for the source device. Choose between <i>RIP</i> , <i>OSPF</i> , <i>Static</i> and <i>Local</i> . |
| Type | Allows for the selection of one of six methods of calculating the metric value. The user may choose between <i>All</i> , <i>Internal</i> , <i>External</i> , <i>ExtType1</i> , <i>ExtType2</i> , <i>Inter-E1</i> , <i>Inter-E2</i> . |
| Metric (0-16) | Allows the entry of an OSPF interface cost. This is analogous to a Hop Count in the RIP routing protocol. The user may specify a cost between 0 and 16. |

Click **Add/Modify** to implement changes made.



NOTE: The source protocol (Src. Protocol) entry and the destination protocol (Dst. Protocol) entry cannot be the same.

Multicast Static Route Settings

This window is used to create an IP multicast static route configuration entry.

To access the **Multicast Static Route Settings** window, click **L3 Features > Multicast Static Route Settings**, as shown below.

Figure 8- 9. Multicast Static Route Settings window

The following parameters may be configured:

| Parameter | Description |
|-------------------|--|
| IP Address | Enter the IP address you wish to find. If the source IP address of the received IP multicast packet matches this address, the RPF address is used to complete the RPF check. |
| Netmask | Enter the subnet mask of the entry you wish to Find. |

Enter the appropriate information and click **Find**, the information will appear in the Multicast Static Route Settings table. To delete an entry click the corresponding **Delete** button. To clear all the entries click the **Clear All** button. To add a new entry click **Add**, the following window will be displayed for the user to configure.

Figure 8- 10. Multicast Static Route Settings - Add window

The following parameters may be configured:

| Parameter | Description |
|-----------------------|---|
| IP Address | Enter the IP address of the entry you wish to add. If the source IP address of the received IP multicast packet matches this address, the RPF address is used to complete the RPF check. |
| Subnet Mask | Enter the Subnet Mask of the entry you wish to add. |
| RFP IP Address | Enter the RFP IP Address of the entry you wish to add. This specifies that the IP address entered, uses the source IP address of the received IP multicast packet to match the network_address. The rpf_address will be used to check whether packets are received from a legal interface. If it is set to null, and the source IP address in the received IP multicast packet matches the network_address, the RPF check will always fail. |

Enter the appropriate information and click **Apply**. To return to the Multicast Static Route Entries table, click the hyperlinked [Show All Multicast Static Route Entries](#).

Static/Default Route Settings

The Switch supports static routing for IPv4 and IPv6 formatted addressing. Users can create up to 256 static route entries for IPv4 and IPv6 combined.

For IPv4 static routes, once a static route has been set, the Switch will send an ARP request packet to the next hop router that has been set by the user. Once an ARP response has been retrieved by the switch from that next hop, the route becomes enabled. However, if the ARP entry already exists, an ARP response will not be sent.

The Switch also supports a floating static route, which means that the user may create an alternative static route to a different next hop. This secondary next hop device route is considered as a backup static route for when the primary static route is down. If the primary route is lost, the backup route will uplink and its status will become Active.

IPv4 Static/Default Route Settings

Entries into the Switch’s forwarding table can be made using both an IP address subnet mask and a gateway. Static IP forwarding is accomplished by the entry of an IP address into the Switch’s **Static IP Routing Table**.

To view the following window, click **L3 Features > Static/Default Route Settings > IPv4 Static/Default Route Settings**, as shown below.

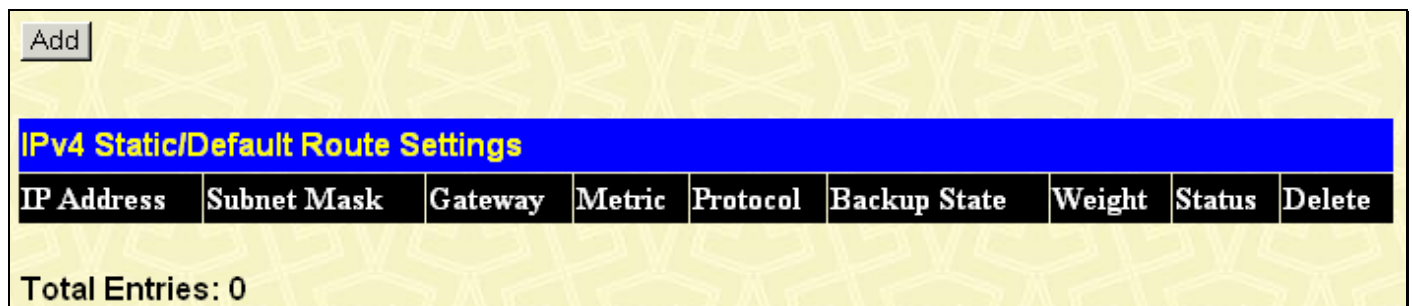



Figure 8- 11. IPv4 Static/Default Route Settings window

This window shows the following values:

| Parameter | Description |
|---------------------|--|
| IP Address | The IP address of the Static/Default Route. |
| Subnet Mask | The corresponding Subnet Mask of the IP address entered into the table. |
| Gateway | The corresponding Gateway of the IP route entered into the table. |
| Metric | Represents the metric value of the IP route entered into the table. This field may read a number between 1 and 65535. |
| Protocol | Represents the protocol used for the Routing Table entry of the IP route. |
| Backup State | Represents the Backup state that this IP route is configured for. This field may read Primary, Backup or Weight. |
| Weight | This field is used to add a weight to the IP route. The rate will determine the ratio for forwarding data packets to a destination. 1= low 4=high. |
| Status | This field denotes the current active state of this IP route. |
| Delete | Click the  to delete this entry from the Static/Default Route Settings table. |

To enter an IP route into the Switch’s **IPv4 Static/Default Route Settings** window, click the **Add** button, revealing the following window to configure.

Figure 8- 12. IPv4 Static/Default Route Settings – Add window

The following fields can be set:

| Parameter | Description |
|-------------------------|---|
| IP Address | Allows the entry of an IP address that will be a static entry into the Switch’s Routing Table. |
| Subnet Mask | Allows the entry of a subnet mask corresponding to the IP address above. |
| NULL Interface | Tick the checkbox to select the null interface. |
| Gateway | Allows the entry of an IP address of a gateway for the IP route above. |
| Metric (1-65535) | Allows the entry of a routing protocol metric representing the number of routers between the Switch and the IP address above. |
| Backup State | The user may choose among <i>Primary</i> , <i>Backup</i> , and <i>Weight</i> . If the Primary Static/Default Route fails, the Backup Route will support the entry. Please take note that the <i>Primary</i> and <i>Backup</i> entries cannot have the same Gateway. If <i>Weight</i> is selected, use the text box on the right to enter your own weight setting. |

Click **Apply** to implement changes made.

IPv6 Static/Default Route Settings

A static entry of an IPv6 address can be entered into the Switch’s routing table for IPv6 formatted addresses.

To view the following window, click **L3 Features > Static/Default Route Settings > IPv6 Static/Default Route Settings**, as shown below.

Figure 8- 13. IPv6 Static/Default Route Settings window

This window shows the following values:

| Parameter | Description |
|-------------------------------|--|
| IPv6 Address/PrefixLen | The IPv6 address and corresponding Prefix Length of the IPv6 static route entry. |

| | |
|-------------------------|--|
| Interface | The IP Interface where the static IPv6 route is created. |
| Next Hop Address | The corresponding IPv6 address for the next hop Gateway address in IPv6 format. |
| Metric (1-65535) | The metric of the IPv6 interface entered into the table representing the number of routers between the Switch and the IPv6 address above. Metric values allowed are between 1 and 65535. |
| Protocol | Represents the status for the IPv6 routing table entry. |
| Backup | This field will indicate the role of this interface for the IPv6 network connection for the switch, whether Primary or Backup. |
| Delete | Click the <input type="checkbox"/> button to delete this entry from the list. |

To enter an IPv6 Interface into the IPv6 Static Route list, click the **Add** button, revealing the following window to configure.

Figure 8- 14. IPv6 Static Route Settings – Add window

Tick the default check box if this will be the default IPv6 route. Choosing this option will allow the user to configure the default gateway for the next hop router only.

The following fields can be set:

| Parameter | Description |
|-----------------------------------|--|
| Interface Name | The IP Interface where the static IPv6 route is to be created. |
| IPv6 Address/Prefix Length | Specify the address and mask information using the format as IPv6 address / prefix length (IPv6 address is hexadecimal number, prefix length is decimal number, for example 1234:5D7F/32). Ticking the default check box will set the IPv6 address as unspecified and the Switch will automatically find the default route. This defines the entry as a 1 hop IPv6 default route. |
| Next Hop Address | Enter the IPv6 address for the next hop Gateway address in IPv6 format. |
| Metric (1-65535) | The metric representing the number of routers between the Switch and the IPv6 address above. |
| Backup State | The user may choose between <i>Primary</i> and <i>Backup</i> . If the Primary Static/Default Route fails, the Backup Route will support the entry. Please take note that the Primary and Backup entries cannot have the same Gateway. |

Click **Apply** to implement changes made.

Route Preference Settings

Route Preference is a way for routers to select the best path when there are two or more different routes to the same destination from two different routing protocols. The majority of routing protocols are not compatible when used in conjunction with each other. This Switch supports and may be configured for many routing protocols, as a stand-alone switch or more importantly, in utilizing the stacking function and Single IP Management of the Switch. Therefore, the ability to exchange route information and select the best path is essential to optimal use of the Switch and its capabilities.

The first decision the Switch will make in selecting the best path is to consult the Route Preference Settings table of the switch. This table holds the list of possible routing protocols currently implemented on the Switch, along with a Preference value which determines which routing protocol will be the most dependable to route packets. Below is a list of the default route preferences set on the Switch.

| Route Type | Validity Range | Default Value |
|------------|---|---------------|
| Local | 0 - Permanently set on the Switch and not configurable. | 0 |
| Static | 1 - 999 | 60 |
| OSPF Intra | 1 - 999 | 80 |
| OSPF Inter | 1 - 999 | 90 |
| RIP | 1 - 999 | 100 |
| OSPF ExtT1 | 1 - 999 | 110 |
| OSPF ExtT2 | 1 - 999 | 115 |

As shown above, Local will always be the first choice for routing purposes and the next most reliable path is **Static** due to the fact that its has the next lowest value. To set a higher reliability for a route, change its value to a number less than the value of a route preference that has a greater reliability value using the New Route Preference Settings window command. For example, if the user wishes to make RIP the most reliable route, the user can change its value to one that is less than the lowest value (Static - 60) or the user could change the other route values to more than 100.

The user should be aware of three points before configuring the route preference:

1. No two route preference values can be the same. Entering the same route preference may cause the Switch to crash due to indecision by the Switch.
2. If the user is not fully aware of all the features and functions of the routing protocols on the Switch, a change in the default route preference value may cause routing loops or black holes.
3. After changing the route preference value for a specific routing protocol, that protocol needs to be restarted because the previously learned routes have been dropped from the switch. The Switch must learn the routes again before the new settings can take affect.

To view the **Route Preference Settings** window, click **L3 Features > Route Preference Settings**, as shown below.

| Route Preference Settings | |
|---------------------------|------------|
| Route Type | Preference |
| RIP | 100 |
| OSPF Intra | 80 |
| STATIC | 60 |
| LOCAL | 0 |
| OSPF Inter | 90 |
| OSPF ExtT1 | 110 |
| OSPF ExtT2 | 115 |

| New Route Preference Settings | |
|-------------------------------|----------------------------------|
| Route Type | Preference |
| RIP(1-999) | <input type="text" value="100"/> |
| OSPF Intra(1-999) | <input type="text" value="80"/> |
| STATIC(1-999) | <input type="text" value="60"/> |
| OSPF Inter(1-999) | <input type="text" value="90"/> |
| OSPF ExtT1(1-999) | <input type="text" value="110"/> |
| OSPF ExtT2(1-999) | <input type="text" value="115"/> |

Figure 8- 15. Route Preference Settings window

The following fields can be viewed or set:

| Parameter | Description |
|---------------------------|--|
| RIP (1-999) | Enter a value between 1 and 999 to set the route preference for RIP. The lower the value, the higher the chance the specified protocol will be chosen as the best path for routing packets. The default value is 100. |
| OSPF Intra (1-999) | Enter a value between 1 and 999 to set the route preference for OSPF Intra. The lower the value, the higher the chance the specified protocol will be chosen as the best path for routing packets. The default value is 80. |
| STATIC (1-999) | Enter a value between 1 and 999 to set the route preference for Static. The lower the value, the higher the chance the specified protocol will be chosen as the best path for routing packets. The default value is 60. |
| OSPF Inter (1-999) | Enter a value between 1 and 999 to set the route preference for OSPF Inter. The lower the value, the higher the chance the specified protocol will be chosen as the best path for routing packets. The default value is 90. |
| OSPF ExtT1 (1-999) | Enter a value between 1 and 999 to set the route preference for OSPF ExtT1. The lower the value, the higher the chance the specified protocol will be chosen as the best path for routing packets. The default value is 110. |
| OSPF ExtT2 (1-999) | Enter a value between 1 and 999 to set the route preference for OSPF ExtT2. The lower the value, the higher the chance the specified protocol will be chosen as the best path for routing packets. The default value is 115. |

Click **Apply** to implement changes made.

Static ARP Settings

The Address Resolution Protocol (ARP) is a TCP/IP protocol that converts IP addresses into physical addresses. This table allows network managers to view, define, modify and delete ARP information for specific devices.

Static entries can be defined in the ARP Table. When static entries are defined, a permanent entry is entered and is used to translate IP address to MAC addresses.

To open the **Static ARP Settings** window, click **L3 Features > Static ARP Settings**, as shown below.

| Static ARP Settings | | | | | |
|--------------------------|----------------|-------------------|-------|---------------------------------------|----------------------------------|
| Interface Name | IP Address | MAC Address | Type | Modify | Delete |
| System | 10.0.0.0 | FF-FF-FF-FF-FF-FF | Local | <input type="button" value="Modify"/> | <input type="button" value="X"/> |
| System | 10.73.21.33 | 00-19-5B-F5-26-C0 | Local | <input type="button" value="Modify"/> | <input type="button" value="X"/> |
| System | 10.255.255.255 | FF-FF-FF-FF-FF-FF | Local | <input type="button" value="Modify"/> | <input type="button" value="X"/> |
| Total Entries : 3 | | | | | |

Figure 8- 16. Static ARP Settings window

To add a new entry, click the **Add** button, revealing the following screen to configure:

Static ARP Settings - Add

IP Address

MAC Address

[Show All Static ARP Entries](#)

Figure 8- 17. Static ARP Settings – Add window

To modify a current entry, click the corresponding **Modify** button of the entry to be modified, revealing the following window to configure:

Static ARP Settings - Edit

IP Address

MAC Address

[Show All Static ARP Entries](#)

Figure 8- 18. Static ARP Settings – Edit window

The following fields can be set or viewed:

| Parameter | Description |
|--------------------|---|
| IP Address | The IP address of the ARP entry. This field cannot be edited in the Static ARP Settings – Edit window. |
| MAC Address | The MAC address of the ARP entry. |

After entering the IP Address and MAC Address of the Static ARP entry, click **Apply** to implement the new entry. To completely clear the Static ARP Settings, click the **Clear All** button.

Gratuitous ARP Settings

An ARP announcement (also known as Gratuitous ARP) is a packet (usually an ARP Request) containing a valid SHA and SPA for the host which sent it, with TPA equal to SPA. Such a request is not intended to solicit a reply, but merely updates the ARP caches of other hosts which receive the packet.

This is commonly done by many operating systems on startup, and helps to resolve problems which would otherwise occur if, for example, a network card had recently been changed (changing the IP address to MAC address mapping) and other hosts still had the old mapping in their ARP cache

To open the **Gratuitous ARP Settings** window, click **L3 Features > Gratuitous ARP Settings**, as shown below.

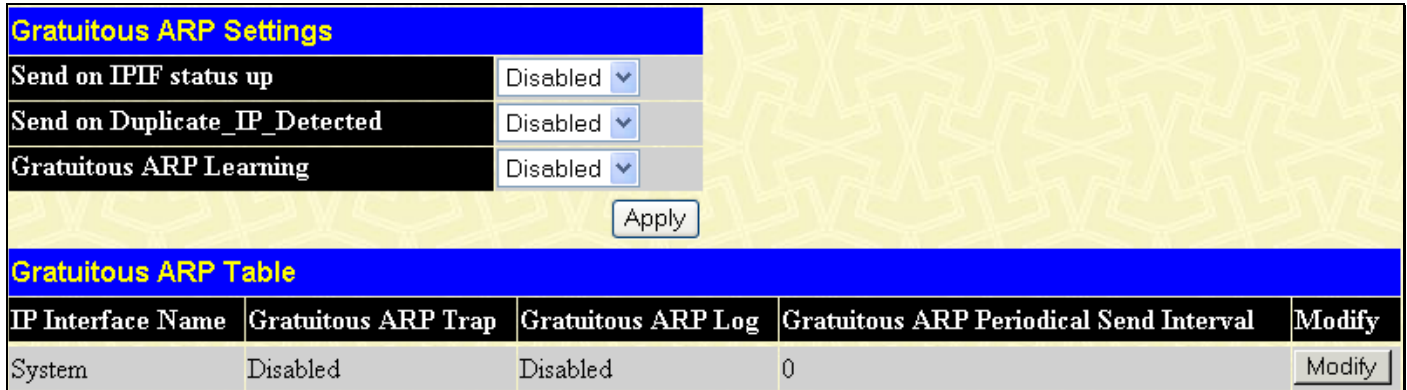

Figure 8- 19. Gratuitous ARP Settings window

Once you have made the desired gratuitous ARP setting changes, click **Apply**.

To modify a current entry, click the corresponding **Modify** button of the entry, which will reveal the following window to be configured:

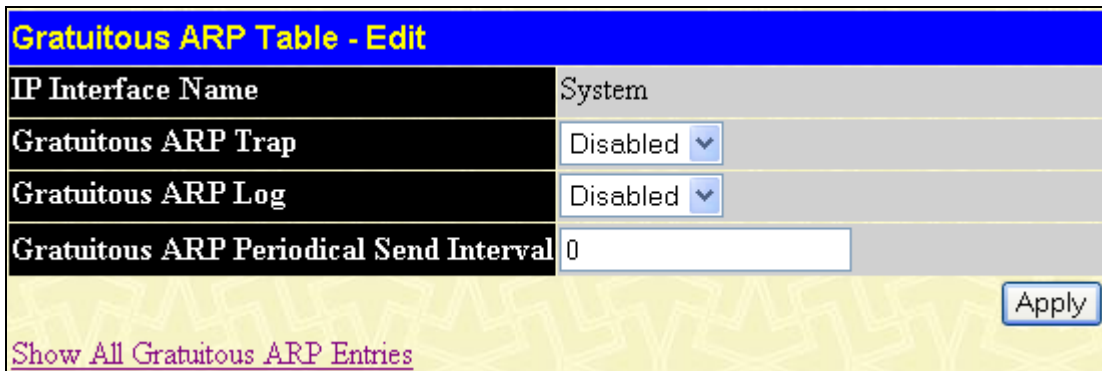

Figure 8- 20. Gratuitous ARP Table – Edit window

The following fields can be set or viewed:

| Parameter | Description |
|--------------------------------------|--|
| Send on IPIF status up | This is used to enable/disable the sending of gratuitous ARP request packets while an IPIF interface comes up. This is used to automatically announce the interface’s IP address to other nodes. By default, the state is <i>Disabled</i> , and only one ARP packet will be broadcast. |
| Send on Duplicate_IP-Detected | This is used to enable/disable the sending of gratuitous ARP request packets while a duplicate IP is detected. By default, the state is <i>Disabled</i> . Duplicate IP detected means that the system received an ARP request packet that is sent by an IP address that matches the system’s own IP address. |
| Gratuitous ARP Learning | This is used to enable/disable updating ARP cache based on the received gratuitous ARP packet. If a switch receives a gratuitous ARP packet, it should add or update the ARP entry. This is <i>Disabled</i> by default. |
| Gratuitous ARP | The switch can trap and log IP conflict events to inform the administrator. By default, trap is |

| | |
|--|---|
| Trap & Log | Disabled and event log is also disabled. |
| Gratuitous ARP Periodical Send Interval | This is used to configure the interval for the periodical sending of gratuitous ARP request packets. By default, the interval is 0. |

After making the desired changes, click **Apply** to implement the new Gratuitous ARP Table entry.

Policy Route Settings

Policy Based routing is a method used by the Switch to give specified devices a cleaner path to the Internet. Used in conjunction with the Access Profile feature, the Switch will identify traffic originating from a device using the Access Profile feature and forward it on to a next hop router that has a more direct connection to the Internet than the normal routing scheme of your network.

Take the example adjacent picture. Let's say that the PC with IP address 10.1.1.1 belongs to the manager of a company while the other PCs belong to employees. The network administrator hopes to circumvent network traffic by configuring the Policy Routing Switch to make a more direct connection to the Internet using a next hop router (10.2.2.2) that is directly attached to a Gateway router (10.3.3.3), thus totally avoiding the normal network and its related traffic. To accomplish this, the user must configure the Access Profile feature of the Switch to have the PC, with IP address 10.1.1.1 as the Source IP address and the Internet address as the destination IP address (learned through routing protocols), along with other pertinent information. Next, the administrator must configure the Policy Route window to be enabled for this Access Profile and its associated rule, and the Next Hop Router's IP address (10.2.2.2) must be set. Finally, this Policy Route entry must be enabled.

Once completed, the Switch will identify the IP address using the Access Profile function, recognize that it has a Policy Based route, and then forward the information on to the specified next hop router, that will, in turn, relay packets to the gateway router. Thus, the new, cleaner path to the Internet has been formed.

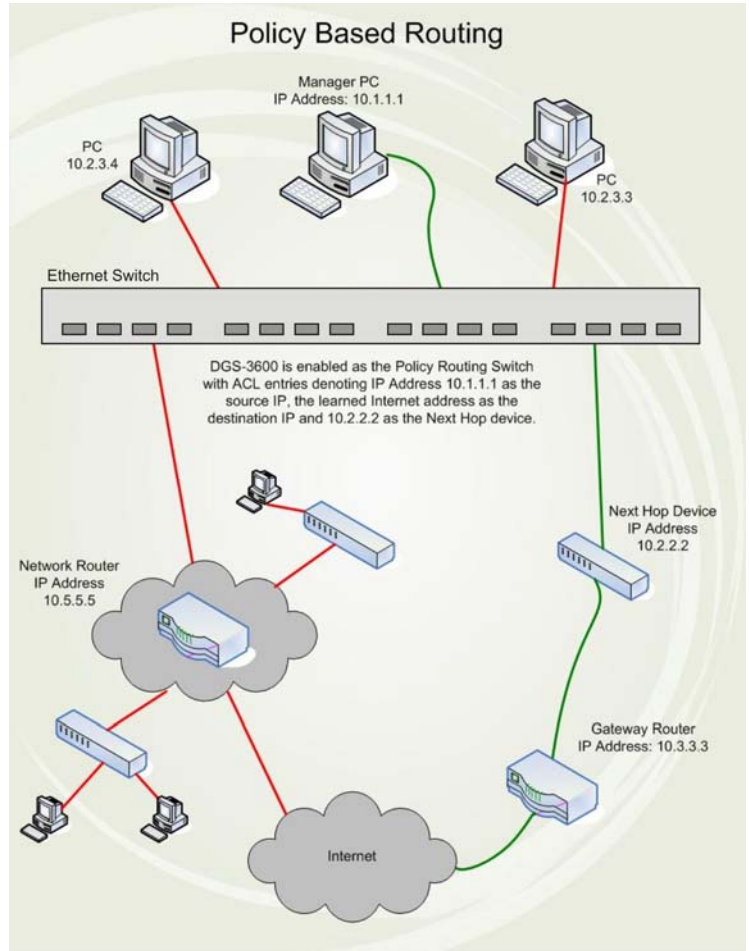

Figure 8- 21. Policy-based Routing example

There are some restrictions and cautions when implementing this feature:

1. The access profile must first be created, along with the accompanying rule. If the administrator attempts to enable this feature without the access profile, an error message will be produced.
2. If the access profile is configured as Deny, the packet will be dropped and not forwarded to the next hop destination.
3. If the administrator deletes a rule or profile that is directly linked to a configured policy route, and error message will be prompted to the administrator.

To configure the Policy Route feature, click **L3 Features > Policy Route Settings**, as shown below.



Figure 8- 22. Policy Routing Settings window

To add a new Policy Route, click the **Add** button, which will display the following window.

Figure 8- 23. Policy Routing – Add window

Adjust the following parameters and click **Apply** to set the new Policy Route, which will be displayed in the **Policy Routing Settings** window. Click [Show All Policy Route Entries](#) to return to the **Policy Routing Settings** window.

| Parameter | Description |
|--------------------------|---|
| Name | Enter a name of no more than 32 alphanumeric characters that will be used to identify this policy route. |
| Profile ID (1-14) | Enter the Profile ID number of the Access Profile, previously created, which will be used to identify packets as following this Policy Route. This access profile, along with the access rule, must first be constructed before this policy route can be created. |
| Access ID (1-128) | Enter the Access ID number of the Access Rule, previously created, which will be used to identify packets as following this Policy Route. This access rule, along with the access profile, must first be constructed before this policy route can be created. |
| Nexthop | This is the IP address of the Next Hop router that will have a direct connection to the Gateway router connected to the Internet. |
| State | Use the pull-down menu to enable or disable this Policy Route. |

ECMP Algorithm Settings

ECMP algorithm settings allow the user to set the ECMP load balance algorithm which makes it effective for ECMP routing. ECMP routing can be adopted by either OSPF dynamic routes or by static routes which are configured with equal cost. The OSPF protocol maintains multiple equal-cost routes to all destinations. Each one of the multiple routes will be of the same type (intra-area, inter-area, type 1 external or type 2 external), cost, and will have the same associated area. However, each route may specify a separate next hop and Advertising router.

There is no requirement that a router running OSPF can keep track of all possible equal-cost routes to a destination. An implementation may choose to keep only a fixed number of routes to any given destination. This does not affect any of the algorithms presented in this specification.

To configure these settings, click **L3 Features > ECMP Algorithm Settings**, as shown below.

| ECMP OSPF State Settings | |
|--------------------------------------|---|
| ECMP OSPF State | Enabled <input type="button" value="v"/> |
| <input type="button" value="Apply"/> | |
| ECMP Algorithm Settings | |
| Destination IP | <input type="checkbox"/> |
| Source IP/CRC Low/CRC High | <input type="checkbox"/> CRC Low <input type="button" value="v"/> |
| TCP/UDP Port | <input type="checkbox"/> |
| <input type="button" value="Apply"/> | |
| ECMP Load Balance Algorithm Table | |
| Destination IP | not used. |
| Source IP | not used. |
| CRC Low | used. |
| CRC High | not used. |
| TCP/UDP Port | not used. |

Figure 8- 24. ECMP Algorithm Settings window

The following settings can be configured:

| Parameter | Description |
|-----------------------------------|--|
| ECMP State | Use the drop down menu to <i>Enable</i> or <i>Disable</i> the ECMP OSPF State. |
| Destination IP | Check this box to include the Destination IP in the ECMP Algorithm. |
| Source IP/CRC Low/CRC High | <p><i>Source IP</i> – If set, ECMP algorithm will include the source IP. This attribution is mutually exclusive with CRC Low and CRC High. If it is set, CRC Low and CRC High will be excluded. It is not set by default.</p> <p><i>CRC Low</i> – If set, ECMP algorithm will include the lower 5 bits of CRC. This attribution is mutually exclusive from CRC High and IP source. If it is set, CRC High and IP source will be excluded. It is set by default.</p> <p><i>CRC High</i> – If set, ECMP algorithm will include the upper 5 bits of CRC. This attribution is mutually exclusive with IP source and CRC Low. If it is set, CRC Low and IP source will be excluded. It is not set by default.</p> |
| TCP/UDP Port | Check this box to include TCP/UDP Port in the ECMP Algorithm. |

Click **Apply** to implement changes made.

RIP

The Routing Information Protocol is a distance-vector routing protocol. There are two types of network devices running RIP - active and passive. Active devices advertise their routes to others through RIP messages, while passive devices listen to these messages. Both active and passive routers update their routing tables based upon RIP messages that active routers exchange. Only routers can run RIP in the active mode.

Every 30 seconds, a router running RIP broadcasts a routing update containing a set of pairs of network addresses and a distance (represented by the number of hops or routers between the advertising router and the remote network). So, the vector is the network address and the distance is measured by the number of routers between the local router and the remote network.

RIP measures distance by an integer count of the number of hops from one network to another. A router is one hop from a directly connected network, two hops from a network that can be reached through a router, etc. The more routers between a source and a destination, the greater the RIP distance (or hop count).

There are a few rules to the routing table update process that help to improve performance and stability. A router will not replace a route with a newly learned one if the new route has the same hop count (sometimes referred to as 'cost'). So learned routes are retained until a new route with a lower hop count is learned.

When learned routes are entered into the routing table, a timer is started. This timer is restarted every time this route is advertised. If the route is not advertised for a period of time (usually 180 seconds), the route is removed from the routing table.

RIP does not have an explicit method to detect routing loops. Many RIP implementations include an authorization mechanism (a password) to prevent a router from learning erroneous routes from unauthorized routers.

To maximize stability, the hop count RIP uses to measure distance must have a low maximum value. Infinity (that is, the network is unreachable) is defined as 16 hops. In other words, if a network is more than 16 routers from the source, the local router will consider the network unreachable.

RIP can also be slow to converge (to remove inconsistent, unreachable or looped routes from the routing table) because RIP messages propagate relatively slowly through a network.

Slow convergence can be solved by using split horizon update, where a router does not propagate information about a route back to the interface on which it was received. This reduces the probability of forming transient routing loops.

Hold down can be used to force a router to ignore new route updates for a period of time (usually 60 seconds) after a new route update has been received. This allows all routers on the network to receive the message.

A router can 'poison reverse' a route by adding an infinite (16) hop count to a route's advertisement. This is usually used in conjunction with triggered updates, which force a router to send an immediate broadcast when an update of an unreachable network is received.

RIP Version 1 Message Format

There are two types of RIP messages: routing information messages and information requests. Both types use the same format.

The Command field specifies an operation according the following table:

| Command | Meaning |
|---------|--|
| 1 | Request for partial or full routing information |
| 2 | Response containing network-distance pairs from sender's routing table |
| 3 | Turn on trace mode (obsolete) |
| 4 | Turn off trace mode (obsolete) |
| 5 | Reserved for Sun Microsystem's internal use |
| 9 | Update Request |
| 10 | Update Response |
| 11 | Update Acknowledgement |

RIP Command Codes

The field VERSION contains the protocol version number (1 in this case), and is used by the receiver to verify which version of RIP the packet was sent.

RIP 1 Message

RIP is not limited to TCP/IP. Its address format can support up to 14 octets (when using IP, the remaining 10 octets must be zeros). Other network protocol suites can be specified in the Family of Source Network field (IP has a value of 2). This will determine how the address field is interpreted.

RIP specifies that the IP address, 0.0.0.0, denotes a default route.

The distances, measured in router hops are entered in the Distance to Source Network, and Distance to Destination Network fields.

RIP 1 Route Interpretation

RIP was designed to be used with classed address schemes, and does not include an explicit subnet mask. An extension to version 1 does allow routers to exchange subnetted addresses, but only if the subnet mask used by the network is the same as the subnet mask used by the address. This means the RIP version 1 cannot be used to propagate classless addresses.

Routers running RIP version 1 must send different update messages for each IP interface to which it is connected. Interfaces that use the same subnet mask as the router's network can contain subnetted routes, other interfaces cannot. The router will then advertise only a single route to the network.

RIP Version 2 Extensions

RIP version 2 includes an explicit subnet mask entry, so RIP version 2 can be used to propagate variable length subnet addresses or CIDR classless addresses. RIP version 2 also adds an explicit next hop entry, which speeds convergence and helps prevent the formation of routing loops.

RIP2 Message Format

The message format used with RIP2 is an extension of the RIP1 format:

RIP version 2 also adds a 16-bit route tag that is retained and sent with router updates. It can be used to identify the origin of the route.

Because the version number in RIP2 occupies the same octet as in RIP1, both versions of the protocols can be used on a given router simultaneously without interference.

RIP Global Settings

To setup RIP for the IP interfaces configured on the Switch, the user must first globally enable RIP and then configure RIP settings for the individual IP interfaces.

To globally enable RIP on the Switch, click **L3 Features > RIP > RIP Global Settings**, as shown below.



Figure 8- 25. RIP Global Settings window

To enable RIP, simply use the pull-down menu, select *Enabled* and click **Apply**.

RIP Interface Settings

RIP settings are configured for each IP interface on the Switch. This window appears in table form listing settings for IP interfaces currently on the Switch. To configure RIP settings for an individual interface, click on the hyperlinked Interface Name.

To view this window, click **L3 Features > RIP > RIP Interface Settings**, as shown below.

| Total Entries:1 | | | | | |
|------------------------|-------------|----------|----------|----------|----------|
| RIP Interface Settings | | | | | |
| Interface Name | IP Address | TX Mode | RX Mode | Auth. | State |
| System | 10.73.21.33 | Disabled | Disabled | Disabled | Disabled |

Figure 8- 26. RIP Interface Settings window

Click the hyperlinked name of the interface to configure the settings for RIP, which will give access to the following window:

| RIP Interface Settings-Edit | |
|--|---|
| Interface Name | System |
| IP Address | 10.73.21.33 |
| TX Mode | Disabled <input type="button" value="v"/> |
| RX Mode | Disabled <input type="button" value="v"/> |
| Authentication | Disabled <input type="button" value="v"/> |
| Password | <input type="text"/> |
| State | Disabled <input type="button" value="v"/> |
| Interface Metric | 1 |
| <input type="button" value="Apply"/> | |
| Show All RIP Interface Entries | |

Figure 8- 27. RIP Interface Settings - Edit window

Refer to the table below for a description of the available parameters for RIP interface settings.

The following RIP settings can be applied to each IP interface:

| Parameter | Description |
|-----------------------|--|
| Interface Name | The name of the IP interface on which RIP is to be setup. This interface must be previously configured on the Switch. |
| IP Address | The IP address corresponding to the Interface Name showing in the field above. |
| TX Mode | Toggle among <i>Disabled</i> , <i>V1 Only</i> , <i>V1 Compatible</i> , and <i>V2 Only</i> . This entry specifies which version of the RIP protocol will be used to transmit RIP packets. <i>Disabled</i> prevents the transmission of RIP packets. |
| RX Mode | Toggle among <i>Disabled</i> , <i>V1 Only</i> , <i>V2 Only</i> , and <i>V1 or V2</i> . This entry specifies which version of the RIP protocol will be used to interpret received RIP packets. <i>Disabled</i> prevents the reception of RIP packets. |
| Authentication | Toggle between <i>Disabled</i> and <i>Enabled</i> to specify that routers on the network should use the Password above to authenticate router table exchanges. |
| Password | A password to be used to authenticate communication between routers on the network. |
| State | Toggle between <i>Disabled</i> and <i>Enabled</i> to disable or enable this RIP interface on the switch. |

| | |
|-------------------------|--|
| Interface Metric | A read only field that denotes the Metric value of the current IP Interface setting. |
|-------------------------|--|

Click **Apply** to implement changes made.

OSPF

The Open Shortest Path First (OSPF) routing protocol uses a link-state algorithm to determine routes to network destinations. A “link” is an interface on a router and the “state” is a description of that interface and its relationship to neighboring routers. The state contains information such as the IP address, subnet mask, type of network the interface is attached to, other routers attached to the network, etc. The collection of link-states is then collected in a link-state database that is maintained by routers running OSPF.

OSPF specifies how routers will communicate to maintain their link-state database and defines several concepts about the topology of networks that use OSPF.

To limit the extent of link-state update traffic between routers, OSPF defines the concept of Area. All routers within an area share the exact same link-state database, and a change to this database once one router triggers an update to the link-state database of all other routers in that area. Routers that have interfaces connected to more than one area are called Border Routers and take the responsibility of distributing routing information between areas.

One area is defined as Area 0 or the Backbone. This area is central to the rest of the network in that all other areas have a connection (through a router) to the backbone. Only routers have connections to the backbone and OSPF is structured such that routing information changes in other areas will be introduced into the backbone, and then propagated to the rest of the network.

When constructing a network to use OSPF, it is generally advisable to begin with the backbone (area 0) and work outward

Link-State Algorithm

An OSPF router uses a link-state algorithm to build a shortest path tree to all destinations known to the router. The following is a simplified description of the algorithm’s steps:

- When OSPF is started, or when a change in the routing information changes, the router generates a link-state advertisement. This advertisement is a specially formatted packet that contains information about all the link-states on the router.
- This link-state advertisement is flooded to all routers in the area. Each router that receives the link-state advertisement will store the advertisement and then forward a copy to other routers.
- When the link-state database of each router is updated, the individual routers will calculate a Shortest Path Tree to all destinations – with the individual router as the root. The IP routing table will then be made up of the destination address, associated cost, and the address of the next hop to reach each destination.
- Once the link-state databases are updated, Shortest Path Trees calculated, and the IP routing tables written – if there are no subsequent changes in the OSPF network (such as a network link going down) there is very little OSPF traffic.

Shortest Path Algorithm

The Shortest Path to a destination is calculated using the Dijkstra algorithm. Each router is placed at the root of a tree and then calculates the shortest path to each destination based on the cumulative cost to reach that destination over multiple possible routes. Each router will then have its own Shortest Path Tree (from the perspective of its location in the network area) even though every router in the area will have and use the exact same link-state database.

The following sections describe the information used to build the Shortest Path Tree.

OSPF Cost

Each OSPF interface has an associated cost (also called “metric”) that is representative of the overhead required to send packets over that interface. This cost is inversely proportional to the bandwidth of the interface (i.e. a higher bandwidth interface has a lower cost). There is then a higher cost (and longer time delays) in sending packets over a 56 Kbps dial-up connection than over a 10 Mbps Ethernet connection. The formula used to calculate the OSPF cost is as follows:

$$\text{Cost} = 100,000,000 / \text{bandwidth in bps}$$

As an example, the cost of a 10 Mbps Ethernet line will be 10 and the cost to cross a 1.544 Mbps T1 line will be 64.

Shortest Path Tree

To build Router A’s shortest path tree for the network diagramed below, Router A is put at the root of the tree and the smallest cost link to each destination network is calculated.

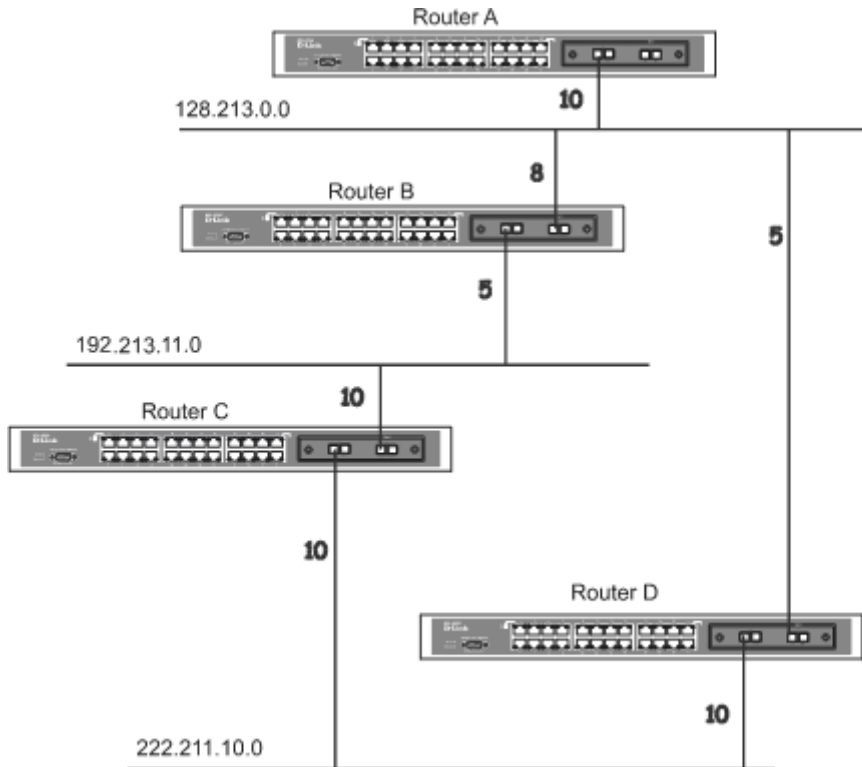

Figure 8- 28. Constructing a Shortest Path Tree

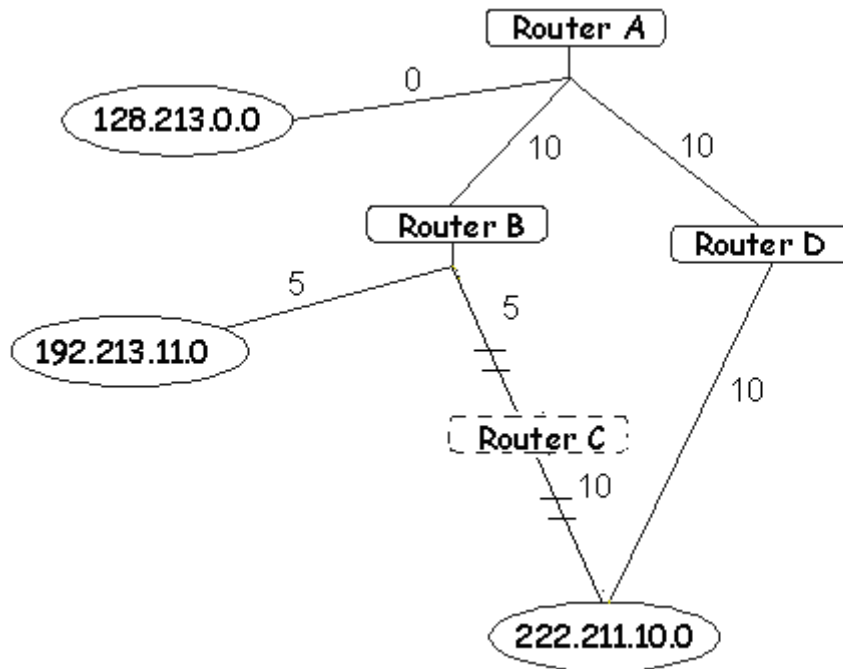

Figure 8- 29. Constructing a Shortest Path Tree

The diagram above shows the network from the viewpoint of Router A. Router A can reach 192.213.11.0 through Router B with a cost of $10 + 5 = 15$. Router A can reach 222.211.10.0 through Router C with a cost of $10 + 10 = 20$. Router A can also reach 222.211.10.0 through Router B and Router D with a cost of $10 + 5 + 10 = 25$, but the cost is higher than the route through Router C. This higher-cost route will not be included in the Router A's shortest path tree. The resulting tree will look like this:

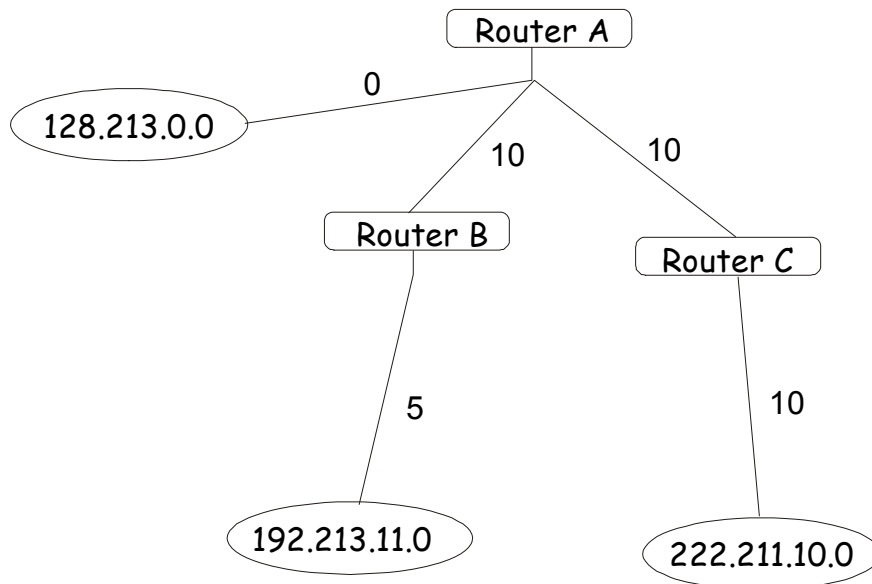

Figure 8- 30. Constructing a Shortest Path Tree - Completed

Note that this shortest path tree is only from the viewpoint of Router A. The cost of the link from Router B to Router A, for instance is not important to constructing Router A's shortest path tree, but is very important when Router B is constructing its shortest path tree.

Note also that directly connected networks are reached at a cost of zero, while other networks are reached at the cost calculated in the shortest path tree.

Router A can now build its routing table using the network addresses and costs calculated in building the above shortest path tree.

Areas and Border Routers

OSPF link-state updates are forwarded to other routers by flooding to all routers on the network. OSPF uses the concept of areas to define where on the network routers that need to receive particular link-state updates are located. This helps ensure that routing updates are not flooded throughout the entire network and will reduce the amount of bandwidth consumed by updating the various router's routing tables.

Areas establish boundaries beyond which link-state updates do not need to be flooded. So the exchange of link-state updates and the calculation of the shortest path tree are limited to the area that the router is connected to.

Routers that have connections to more than one area are called Border Routers (BR). The Border Routers have the responsibility of distributing necessary routing information and changes between areas.

Areas are specific to the router interface. A router that has all of its interfaces in the same area is called an Internal Router. A router that has interfaces in multiple areas is called a Border Router. Routers that act as gateways to other networks (possibly using other routing protocols) are called Autonomous System Border Routers (ASBRs).

Link-State Packets

There are a number of different types of link-state packets, four of which are illustrated below:

- Router Link-State Updates – These describe a router's links to destinations within an area.
- Summary Link-State Updates – Issued by Border Routers and describe links to networks outside the area but within the Autonomous System (AS).
- Network Link-State Updates – Issued by multi-access areas that have more than one attached router. One router is elected as the Designated Router (DR) and this router issues the network link-state updates describing every router on the segment.
- External Link-State Updates – Issued by an Autonomous System Border Router and describes routes to destinations outside the AS or a default route to the outside AS.

The format of these link-state updates is described in more detail below.

Router link-state updates are flooded to all routers in the current area. These updates describe the destinations reachable through all of the router's interfaces.

Summary link-state updates are generated by Border Routers to distribute routing information about other networks within the AS. Normally, all Summary link-state updates are forwarded to the backbone (area 0) and are then forwarded to all other areas in the

network. Border Routers also have the responsibility of distributing routing information from the Autonomous System Border Router in order for routers in the network to get and maintain routes to other Autonomous Systems.

Network link-state updates are generated by a router elected as the Designated Router on a multi-access segment (with more than one attached router). These updates describe all of the routers on the segment and their network connections.

External link-state updates carry routing information to networks outside the Autonomous System. The Autonomous System Border Router is responsible for generating and distributing these updates.

OSPF Authentication

OSPF packets can be authenticated as coming from trusted routers by the use of predefined passwords. The default for routers is to use no authentication.

There are two other authentication methods – simple password authentication (key) and Message Digest authentication (MD-5).

Message Digest Authentication (MD-5)

MD-5 authentication is a cryptographic method. A key and a key-ID are configured on each router. The router then uses an algorithm to generate a mathematical “message digest” that is derived from the OSPF packet, the key and the key-ID. This message digest (a number) is then appended to the packet. The key is not exchanged over the wire and a non-decreasing sequence number is included to prevent replay attacks.

Simple Password Authentication

A password (or key) can be configured on a per-area basis. Routers in the same area that participate in the routing domain must be configured with the same key. This method is possibly vulnerable to passive attacks where a link analyzer is used to obtain the password.

Backbone and Area 0

OSPF limits the number of link-state updates required between routers by defining areas within which a given router operates. When more than one area is configured, one area is designated as area 0 – also called the backbone.

The backbone is at the center of all other areas – all areas of the network have a physical (or virtual) connection to the backbone through a router. OSPF allows routing information to be distributed by forwarding it into area 0, from which the information can be forwarded to all other areas (and all other routers) on the network.

In situations where an area is required, but is not possible to provide a physical connection to the backbone, a virtual link can be configured.

Virtual Links

Virtual links accomplish two purposes:

- Linking an area that does not have a physical connection to the backbone.
- Patching the backbone in case there is a discontinuity in area 0.

Areas Not Physically Connected to Area 0

All areas of an OSPF network should have a physical connection to the backbone, but in some cases it is not possible to physically connect a remote area to the backbone. In these cases, a virtual link is configured to connect the remote area to the backbone. A virtual path is a logical path between two border routers that have a common area, with one border router connected to the backbone.

Partitioning the Backbone

OSPF also allows virtual links to be configured to connect the parts of the backbone that are discontinuous. This is the equivalent to linking different area 0s together using a logical path between each area 0. Virtual links can also be added for redundancy to protect against a router failure. A virtual link is configured between two border routers that both have a connection to their respective area 0s.

Neighbors

Routers that are connected to the same area or segment become neighbors in that area. Neighbors are elected via the Hello protocol. IP multicast is used to send out Hello packets to other routers on the segment. Routers become neighbors when they see themselves listed in a Hello packet sent by another router on the same segment. In this way, two-way communication is guaranteed to be possible between any two neighbor routers.

Any two routers must meet the following conditions before the become neighbors:

- **Area ID** – Two routers having a common segment – their interfaces have to belong to the same area on that segment. Of course, the interfaces should belong to the same subnet and have the same subnet mask.

- **Authentication** – OSPF allows for the configuration of a password for a specific area. Two routers on the same segment and belonging to the same area must also have the same OSPF password before they can become neighbors.
- **Hello and Dead Intervals** – The Hello interval specifies the length of time, in seconds, between the hello packets that a router sends on an OSPF interface. The dead interval is the number of seconds that a router's Hello packets have not been seen before its neighbors declare the OSPF router down. OSPF routers exchange Hello packets on each segment in order to acknowledge each other's existence on a segment and to elect a Designated Router on multi-access segments. OSPF requires these intervals to be exactly the same between any two neighbors. If any of these intervals are different, these routers will not become neighbors on a particular segment.
- **Stub Area Flag** – Any two routers also must have the same stub area flag in their Hello packets in order to become neighbors.

Adjacencies

Adjacent routers go beyond the simple Hello exchange and participate in the link-state database exchange process. OSPF elects one router as the Designated Router (DR) and a second router as the Backup Designated Router (BDR) on each multi-access segment (the BDR is a backup in case of a DR failure). All other routers on the segment will then contact the DR for link-state database updates and exchanges. This limits the bandwidth required for link-state database updates.

Designated Router Election

The election of the DR and BDR is accomplished using the Hello protocol. The router with the highest OSPF priority on a given multi-access segment will become the DR for that segment. In case of a tie, the router with the highest Router ID wins. The default OSPF priority is 1. A priority of zero indicates a router that cannot be elected as the DR.

Building Adjacency

Two routers undergo a multi-step process in building the adjacency relationship. The following is a simplified description of the steps required:

- **Down** – No information has been received from any router on the segment.
- **Attempt** – On non-broadcast multi-access networks (such as Frame Relay or X.25), this state indicates that no recent information has been received from the neighbor. An effort should be made to contact the neighbor by sending Hello packets at the reduced rate set by the Poll Interval.
- **Init** – The interface has detected a Hello packet coming from a neighbor but bi-directional communication has not yet been established.
- **Two-way** – Bi-directional communication with a neighbor has been established. The router has seen its address in the Hello packets coming from a neighbor. At the end of this stage the DR and BDR election would have been done. At the end of the Two-way stage, routers will decide whether to proceed in building an adjacency or not. The decision is based on whether one of the routers is a DR or a BDR or the link is a point-to-point or virtual link.
- **Exstart** – (Exchange Start) Routers establish the initial sequence number that is going to be used in the information exchange packets. The sequence number insures that routers always get the most recent information. One router will become the primary and the other will become secondary. The primary router will poll the secondary for information.
- **Exchange** – Routers will describe their entire link-state database by sending database description packets.
- **Loading** – The routers are finalizing the information exchange. Routers have link-state request list and a link-state retransmission list. Any information that looks incomplete or outdated will be put on the request list. Any update that is sent will be put on the retransmission list until it gets acknowledged.
- **Full** – The adjacency is now complete. The neighboring routers are fully adjacent. Adjacent routers will have the same link-state database.

Adjacencies on Point-to-Point Interfaces

OSPF Routers that are linked using point-to-point interfaces (such as serial links) will always form adjacencies. The concepts of DR and BDR are unnecessary.

OSPF Packet Formats

All OSPF packet types begin with a standard 24-byte header and there are five packet types. The header is described first, and each packet type is described in a subsequent section.

All OSPF packets (except for Hello packets) forward link-state advertisements. Link-State Update packets, for example, flood advertisements throughout the OSPF routing domain.

- OSPF packet header
- Hello packet

- Database Description packet
- Link-State Request packet
- Link-State Update packet
- Link-State Acknowledgment packet

OSPF Packet Header

Every OSPF packet is preceded by a common 24-byte header. This header contains the information necessary for a receiving router to determine if the packet should be accepted for further processing.

The format of the OSPF packet header is shown below:

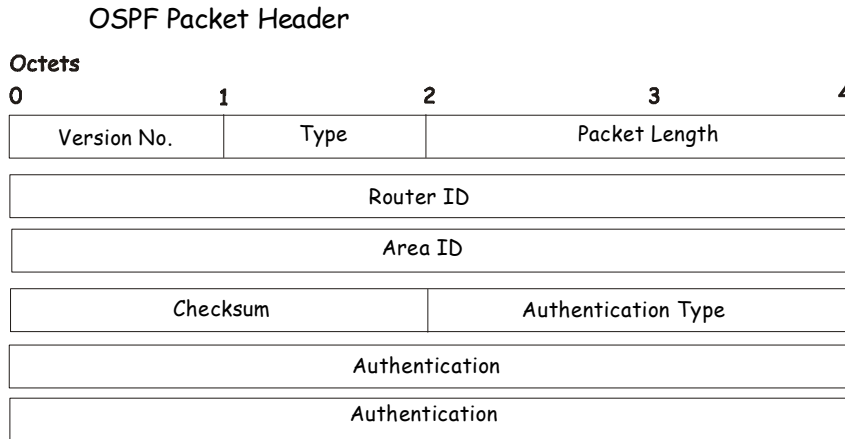

Figure 8- 31. OSPF Packet Header Format

| Field | Description |
|----------------------------|--|
| Version No. | The OSPF version number |
| Type | The OSPF packet type. The OSPF packet types are as follows: Type Description Hello Database Description Link-State Request Link-State Update Link-State Acknowledgment |
| Packet Length | The length of the packet in bytes. This length includes the 24-byte header. |
| Router ID | The Router ID of the packet's source. |
| Area ID | A 32-bit number identifying the area that this packet belongs to. All OSPF packets are associated with a single area. Packets traversing a virtual link are assigned the backbone Area ID of 0.0.0.0 |
| Checksum | A standard IP checksum that includes all of the packet's contents except for the 64-bit authentication field. |
| Authentication Type | The type of authentication to be used for the packet. |
| Authentication | A 64-bit field used by the authentication scheme. |

Hello Packet

Hello packets are OSPF packet type 1. They are sent periodically on all interfaces, including virtual links, in order to establish and maintain neighbor relationships. In addition, Hello Packets are multicast on those physical networks having a multicast or broadcast capability, enabling dynamic discovery of neighboring routers.

All routers connected to a common network must agree on certain parameters such as the Network Mask, the Hello Interval, and the Router Dead Interval. These parameters are included in the hello packets, so that differences can inhibit the forming of neighbor relationships. A detailed explanation of the receive process for Hello packets is necessary so that differences cannot inhibit the forming of neighbor relationships.

The format of the Hello packet is shown below:

Hello Packet

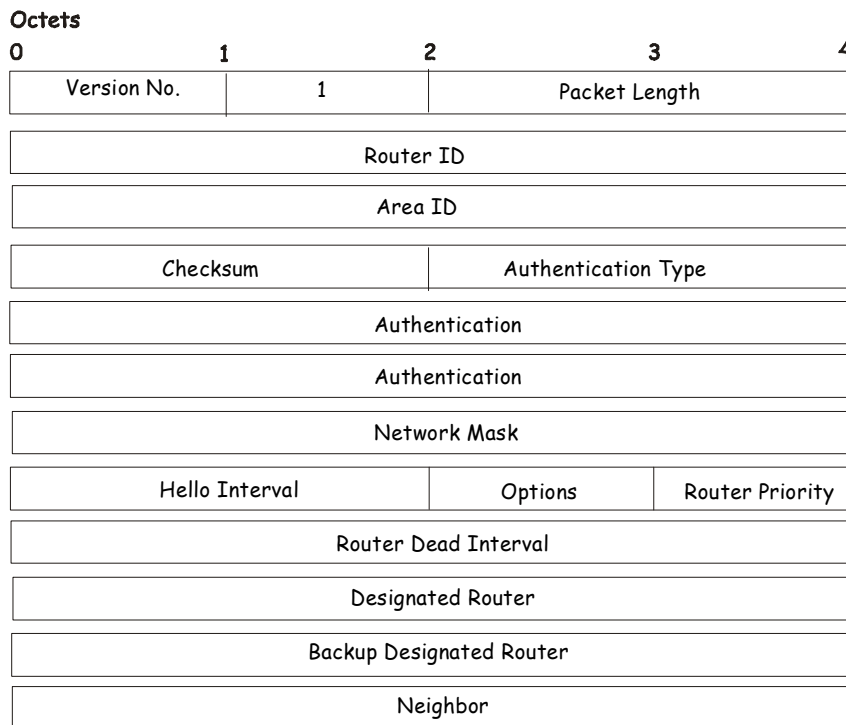

Figure 8- 32. Hello Packet

| Field | Description |
|--------------------------|--|
| Network Mask | The network mask associated with this interface. |
| Options | The optional capabilities supported by the router. |
| Hello Interval | The number of seconds between this router's Hello packets. |
| Router Priority | This router's Router Priority. The Router Priority is used in the election of the DR and BDR. If this field is set to 0, the router is ineligible to become the DR or the BDR. |
| Router Dead Interval | The number of seconds that must pass before declaring a silent router as down. |
| Designated Router | The identity of the DR for this network, in the view of the advertising router. The DR is identified here by its IP interface address on the network. |
| Backup Designated Router | The identity of the Backup Designated Router (BDR) for this network. The BDR is identified here by its IP interface address on the network. This field is set to 0.0.0.0 if there is no BDR. |
| Field | Description |
| Neighbor | The Router IDs of each router from whom valid Hello packets have been seen within the Router Dead Interval on the network. |

Database Description Packet

Database Description packets are OSPF packet type 2. These packets are exchanged when an adjacency is being initialized. They describe the contents of the topological database. Multiple packets may be used to describe the database. For this purpose, a poll-response procedure is used. One of the routers is designated to be master, the other a slave. The master sends Database Description packets (polls) that are acknowledged by Database Description packets sent by the slave (responses). The responses are linked to the polls via the packets' DD sequence numbers.

Database Description Packet

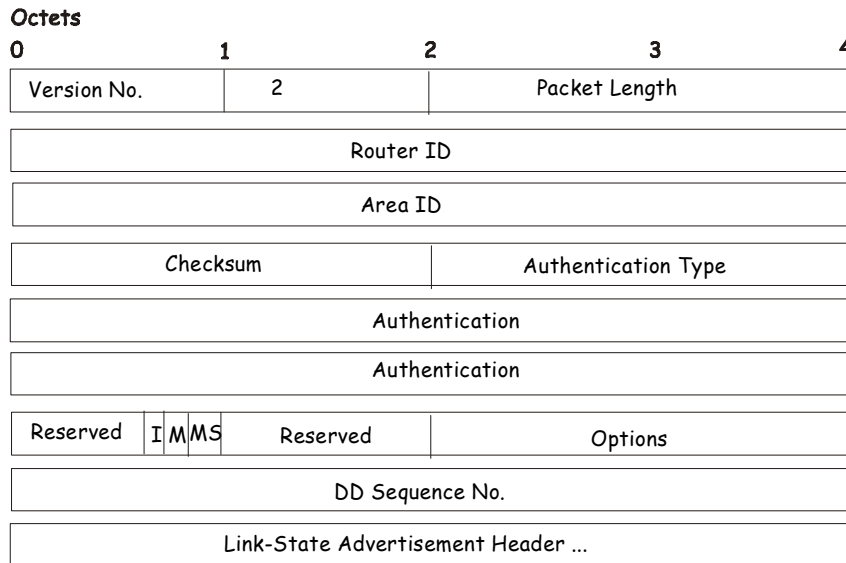

Figure 8- 33. Database Description Packet

| Field | Description |
|--------------------|---|
| Options | The optional capabilities supported by the router. |
| I - bit | The Initial bit. When set to 1, this packet is the first in the sequence of Database Description packets. |
| M - bit | The More bit. When set to 1, this indicates that more Database Description packets will follow. |
| MS - bit | The Master Slave bit. When set to 1, this indicates that the router is the master during the Database Exchange process. A zero indicates the opposite. |
| DD Sequence Number | User to sequence the collection of Database Description Packets. The initial value (indicated by the Initial bit being set) should be unique. The DD sequence number then increments until the complete database description has been sent. |

The rest of the packet consists of a list of the topological database's pieces. Each link state advertisement in the database is described by its link state advertisement header.

Link-State Request Packet

Link-State Request packets are OSPF packet type 3. After exchanging Database Description packets with a neighboring router, a router may find that parts of its topological database are out of date. The Link-State Request packet is used to request the pieces of the neighbor's database that are more up to date. Multiple Link-State Request packets may need to be used. The sending of Link-State Request packets is the last step in bringing up an adjacency.

A router that sends a Link-State Request packet has in mind the precise instance of the database pieces it is requesting, defined by LS sequence number, LS checksum, and LS age, although these fields are not specified in the Link-State Request packet itself. The router may receive even more recent instances in response.

The format of the Link-State Request packet is shown below:

Link-State Request Packet

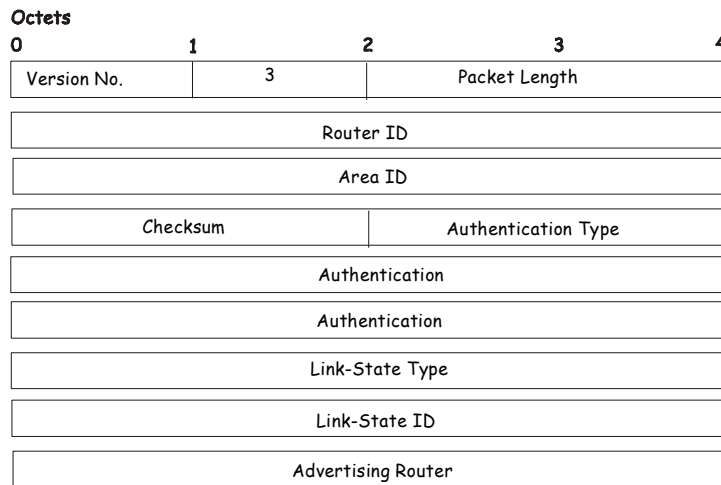

Figure 8- 34. Link-State Request Packet

Each advertisement requested is specified by its Link-State Type, Link-State ID, and Advertising Router. This uniquely identifies the advertisement, but not its instance. Link-State Request packets are understood to be requests for the most recent instance.

Link-State Update Packet

Link-State Update packets are OSPF packet type 4. These packets implement the flooding of link-state advertisements. Each Link-State Update packet carries a collection of link-state advertisements one hop further from its origin. Several link-state advertisements may be included in a single packet.

Link-State Update packets are multicast on those physical networks that support multicast/broadcast. In order to make the flooding procedure reliable, flooded advertisements are acknowledged in Link-State Acknowledgment packets. If retransmission of certain advertisements is necessary, the retransmitted advertisements are always carried by unicast Link-State Update packets.

The format of the Link-State Update packet is shown below:

Link-State Update Packet

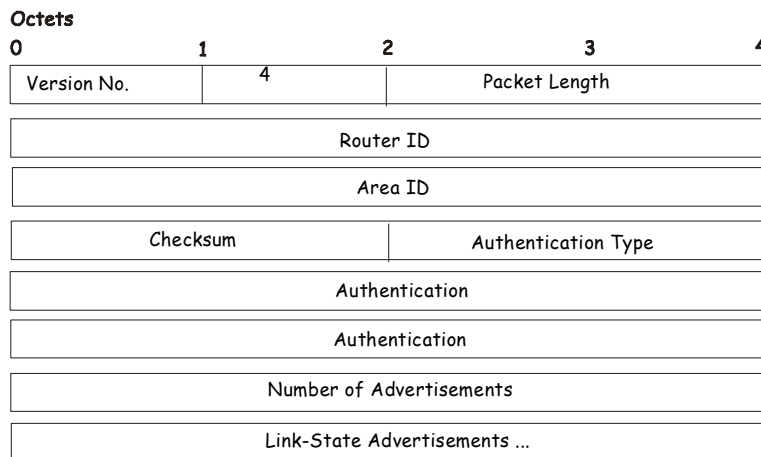

Figure 8- 35. Link-State Update Packet

The body of the Link-State Update packet consists of a list of link-state advertisements. Each advertisement begins with a common 20-byte header, the link-state advertisement header. Otherwise, the format of each of the five types of link-state advertisements is different.

Link-State Acknowledgment Packet

Link-State Acknowledgment packets are OSPF packet type 5. To make the flooding of link-state advertisements reliable, flooded advertisements are explicitly acknowledged. This acknowledgment is accomplished through the sending and receiving of Link-State Acknowledgment packets. Multiple link-state advertisements can be acknowledged in a single Link-State Acknowledgment packet.

Depending on the state of the sending interface and the source of the advertisements being acknowledged, a Link-State Acknowledgment packet is sent either to the multicast address AllSPFRouters, to the multicast address AllDRouters, or as a unicast packet.

The format of this packet is similar to that of the Data Description packet. The body of both packets is simply a list of link-state advertisement headers.

The format of the Link-State Acknowledgment packet is shown below:

Link-State Acknowledgment Packet

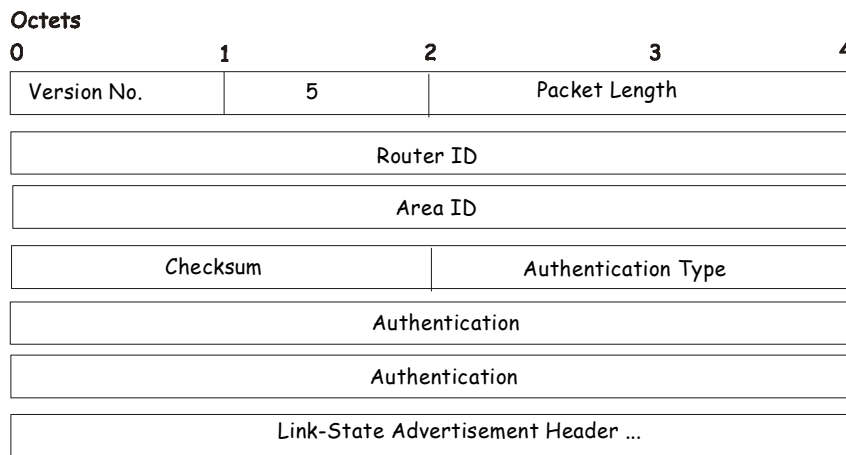

Figure 8- 36. Link State Acknowledge Packet

Each acknowledged link-state advertisement is described by its link-state advertisement header. It contains all the information required to uniquely identify both the advertisement and the advertisement’s current instance.

Link-State Advertisement Formats

There are five distinct types of link-state advertisements. Each link-state advertisement begins with a standard 20-byte link-state advertisement header. Succeeding sections then diagram the separate link-state advertisement types.

Each link-state advertisement describes a piece of the OSPF routing domain. Every router originates a router links advertisement. In addition, whenever the router is elected as the Designated Router, it originates a network links advertisement. Other types of link-state advertisements may also be originated. The flooding algorithm is reliable, ensuring that all routers have the same collection of link-state advertisements. The collection of advertisements is called the link-state (or topological) database.

From the link-state database, each router constructs a shortest path tree with itself as root. This yields a routing table.

There are four types of link state advertisements, each using a common link state header. These are:

- Router Links Advertisements
- Network Links Advertisements
- Summary Link Advertisements
- Autonomous System Link Advertisements

Link State Advertisement Header

All link state advertisements begin with a common 20-byte header. This header contains enough information to uniquely identify the advertisements (Link State Type, Link State ID, and Advertising Router). Multiple instances of the link state advertisement may exist in the routing domain at the same time. It is then necessary to determine which instance is more recent. This is accomplished by examining the link state age, link state sequence number and link state checksum fields that are also contained in the link state advertisement header.

The format of the Link State Advertisement Header is shown below:

Link-State Advertisement Header

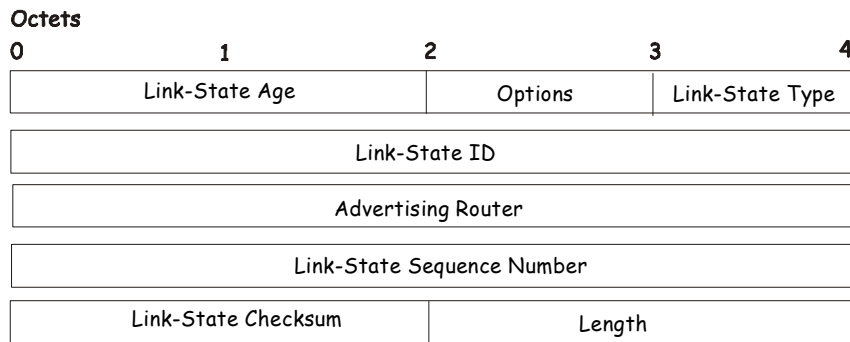

Figure 8- 37. Link State Advertisement Header

| Field | Description |
|-----------------------------------|--|
| Link State Age | The time in seconds since the link state advertisement was originated. |
| Options | The optional capabilities supported by the described portion of the routing domain. |
| Link State Type | The type of the link state advertisement. Each link state type has a separate advertisement format. The link state types are as follows: Router Links, Network Links, Summary Link (IP Network), Summary Link (ASBR), AS External Link. |
| Link State ID | This field identifies the portion of the internet environment that is being described by the advertisement. The contents of this field depend on the advertisement's Link State Type. |
| Advertising Router | The Router ID of the router that originated the Link State Advertisement. For example, in network links advertisements this field is set to the Router ID of the network's Designated Router. |
| Link State Sequence Number | Detects old or duplicate link state advertisements. Successive instances of a link state advertisement are given successive Link State Sequence numbers. |
| Link State Checksum | The Fletcher checksum of the complete contents of the link state advertisement, including the link state advertisement header by accepting the Link State Age field. |
| Length | The length in bytes of the link state advertisement. This includes the 20-byte link state advertisement header. |

Router Links Advertisements

Router links advertisements are type 1 link state advertisements. Each router in an area originates a router's links advertisement. The advertisement describes the state and cost of the router's links to the area. All of the router's links to the area must be described in a single router links advertisement.

The format of the Router Links Advertisement is shown below:

Routers Links Advertisements

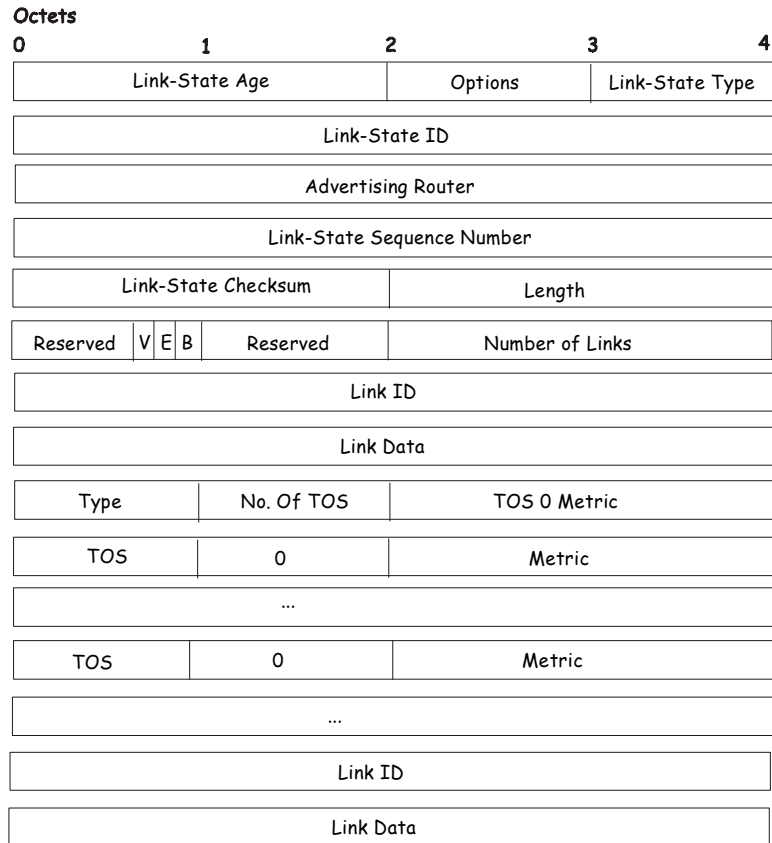

Figure 8- 38. Routers Links Advertisements

In router links advertisements, the Link State ID field is set to the router’s OSPF Router ID. The T-bit is set in the advertisement’s Option field if and only if the router is able to calculate a separate set of routes for each IP Type of Service (TOS). Router links advertisements are flooded throughout a single area only.

| Field | Description |
|-----------------|--|
| V - bit | When set, the router is an endpoint of an active virtual link that is using the described area as a Transit area (V is for Virtual link endpoint). |
| E - bit | When set, the router is an Autonomous System (AS) boundary router (E is for External). |
| B - bit | When set, the router is an area border router (B is for Border). |
| Number of Links | The number of router links described by this advertisement. This must be the total collection of router links to the area. |

The following fields are used to describe each router link. Each router link is typed. The Type field indicates the kind of link being described. It may be a link to a transit network, to another router or to a stub network. The values of all the other fields describing a router link depend on the link’s Type. For example, each link has an associated 32-bit data field. For links to stub networks, this field specifies the network’s IP address mask. For other link types, the Link Data specifies the router’s associated IP interface address.

| Field | Description |
|-------|--|
| Type | A quick classification of the router link. One of the following: Type Description: Point-to-point connection to another router. Connection to a transit network. Connection to a stub network. Virtual link. |

| | |
|---------------------|---|
| Link ID | Identifies the object that this router link connects to. Value depends on the link's Type. When connecting to an object that also originates a link state advertisement (i.e. another router or a transit network) the Link ID is equal to the neighboring advertisement's Link State ID. This provides the key for looking up an advertisement in the link state database. Type Link ID: Neighboring router's Router ID. IP address of Designated Router. IP network/subnet number. Neighboring router's Router ID |
| Link Data | Contents again depend on the link's Type field. For connections to stub networks, it specifies the network's IP address mask. For unnumbered point-to-point connection, it specifies the interface's MIB-II ifIndex value. For other link types it specifies the router's associated IP interface address. This latter piece of information is needed during the routing table build process, when calculating the IP address of the next hop. |
| No. of TOS | The number of different Type of Service (TOS) metrics given for this link, not counting the required metric for TOS 0. If no additional TOS metrics are given, this field should be set to 0. |
| TOS 0 Metric | The cost of using this router link for TOS 0. |

For each link, separate metrics may be specified for each Type of Service (ToS). The metric for ToS 0 must always be included, and was discussed above. Metrics for non-zero TOS are described below. Note that the cost for non-zero ToS values that are not specified defaults to the ToS 0 cost. Metrics must be listed in order of increasing TOS encoding. For example, the metric for ToS 16 must always follow the metric for ToS 8 when both are specified.

| Field | Description |
|---------------|--|
| ToS | IP Type of Service that this metric refers to. |
| Metric | The cost of using this outbound router link, for traffic of the specified TOS. |

Network Links Advertisements

Network links advertisements are Type 2 link state advertisements. A network links advertisement is originated for each transit network in the area. A transit network is a multi-access network that has more than one attached router. The network links advertisement is originated by the network's Designated Router. The advertisement describes all routers attached to the network, including the Designated Router itself. The advertisement's Link State ID field lists the IP interface address of the Designated Router.

The distance from the network to all attached routers is zero, for all ToS. This is why the ToS and metric fields need not be specified in the network links advertisement.

The format of the Network Links Advertisement is shown below:

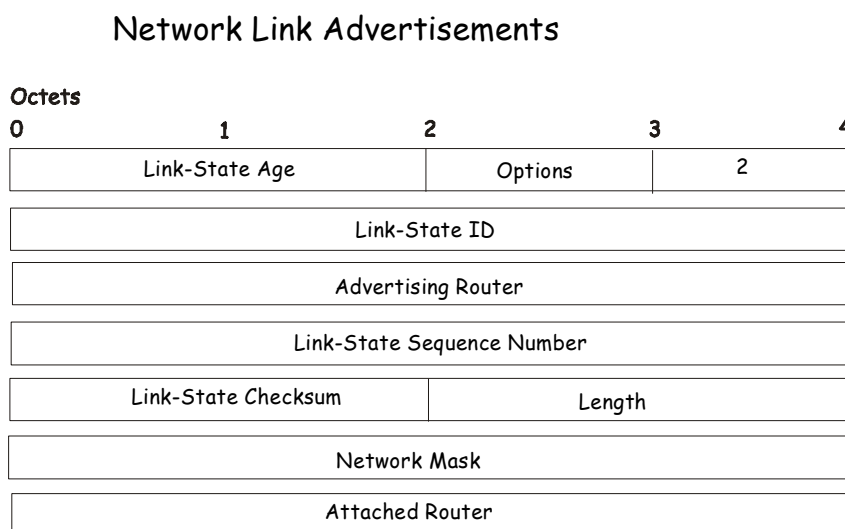

Figure 8- 39. Network Link Advertisements

| Field | Description |
|-----------------|--|
| Network Mask | The IP address mask for the network. |
| Attached Router | The Router IDs of each of the routers attached to the network. Only those routers that are fully adjacent to the Designated Router (DR) are listed. The DR includes itself in this list. |

Summary Link Advertisements

Summary link advertisements are Type 3 and 4 link state advertisements. These advertisements are originated by Area Border routers. A separate summary link advertisement is made for each destination known to the router that belongs to the Autonomous System (AS), yet is outside the area.

Type 3 link state advertisements are used when the destination is an IP network. In this case, the advertisement’s Link State ID field is an IP network number. When the destination is an AS boundary router, a Type 4 advertisement is used, and the Link State ID field is the AS boundary router’s OSPF Router ID. Other than the difference in the Link State ID field, the format of Type 3 and 4 link state advertisements is identical.

Summary Link Advertisements

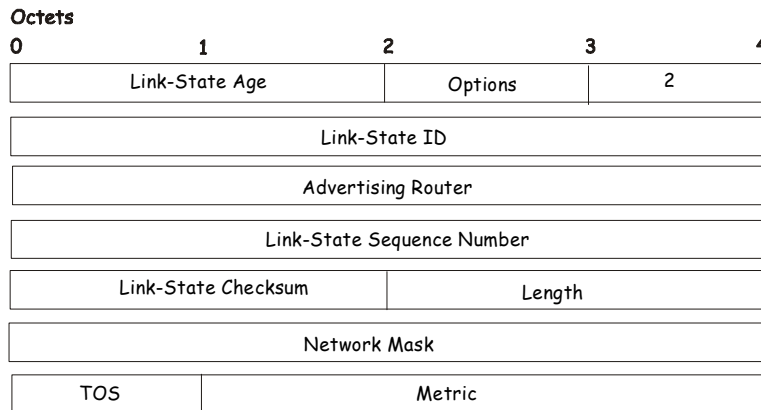

Figure 8- 40. Summary Link Advertisements

For stub area, Type 3 summary link advertisements can also be used to describe a default route on a per-area basis. Default summary routes are used in stub area instead of flooding a complete set of external routes. When describing a default summary route, the advertisement’s Link State ID is always set to the Default Destination – 0.0.0.0, and the Network Mask is set to 0.0.0.0.

Separate costs may be advertised for each IP Type of Service. Note that the cost for ToS 0 must be included, and is always listed first. If the T-bit is reset in the advertisement’s Option field, only a route for ToS 0 is described by the advertisement. Otherwise, routes for the other ToS values are also described. If a cost for a certain ToS is not included, its cost defaults to that specified for ToS 0.

| Field | Description |
|---------------------|---|
| Network Mask | For Type 3 link state advertisements, this indicates the destination network’s IP address mask. For example, when advertising the location of a class A network the value 0xff000000. |
| ToS | The Type of Service that the following cost is relevant to. |
| Metric | The cost of this route. Expressed in the same units as the interface costs in the router links advertisements. |

Autonomous Systems External Link Advertisements

Autonomous Systems (AS) link advertisements are Type 5 link state advertisements. These advertisements are originated by AS boundary routers. A separate advertisement is made for each destination known to the router that is external to the AS.

AS external link advertisements usually describe a particular external destination. For these advertisements the Link State ID field specifies an IP network number. AS external link advertisements are also used to describe a default route. Default routes are used

when no specific route exists to the destination. When describing a default route, the Link State ID is always set with the Default Destination address (0.0.0.0) and the Network Mask is set to 0.0.0.0.

The format of the AS External Link Advertisement is shown below:

AS External Link Advertisements

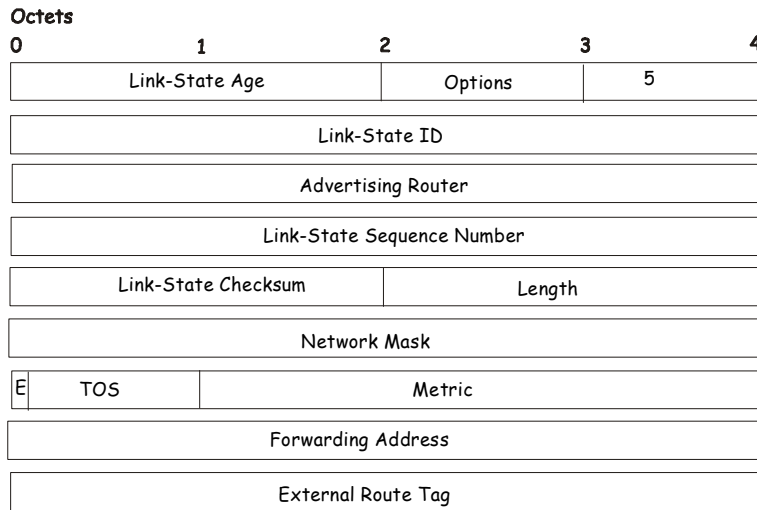

Figure 8- 41. AS External Link Advertisements

| Field | Description |
|---------------------------|---|
| Network Mask | The IP address mask for the advertised destination. |
| E - bit | The type of external metric. If the E-bit is set, the metric specified is a Type 2 external metric. This means the metric is considered larger than any link state path. If the E-bit is zero, the specified metric is a Type 1 external metric. This means that is comparable directly to the link state metric. |
| Forwarding Address | Data traffic for the advertised destination will be forwarded to this address. If the Forwarding Address is set to 0.0.0.0, data traffic will be forwarded instead to the advertisement's originator. |
| TOS | The Type of Service that the following cost is relevant to. |
| Metric | The cost of this route. The interpretation of this metric depends on the external type indication (the E - bit above). |
| External Route Tag | A 32-bit field attached to each external route. This is not used by the OSPF protocol itself. |

Including the NSSA

The NSSA or Not So Stubby Area is a feature that has been added to OSPF so external routes from ASs (Autonomous Systems) can be imported into the OSPF area. As an extension of stub areas, the NSSA feature uses a packet translation system used by BRs (Border Routers) to translate outside routes into the OSPF area. Consider the following example:

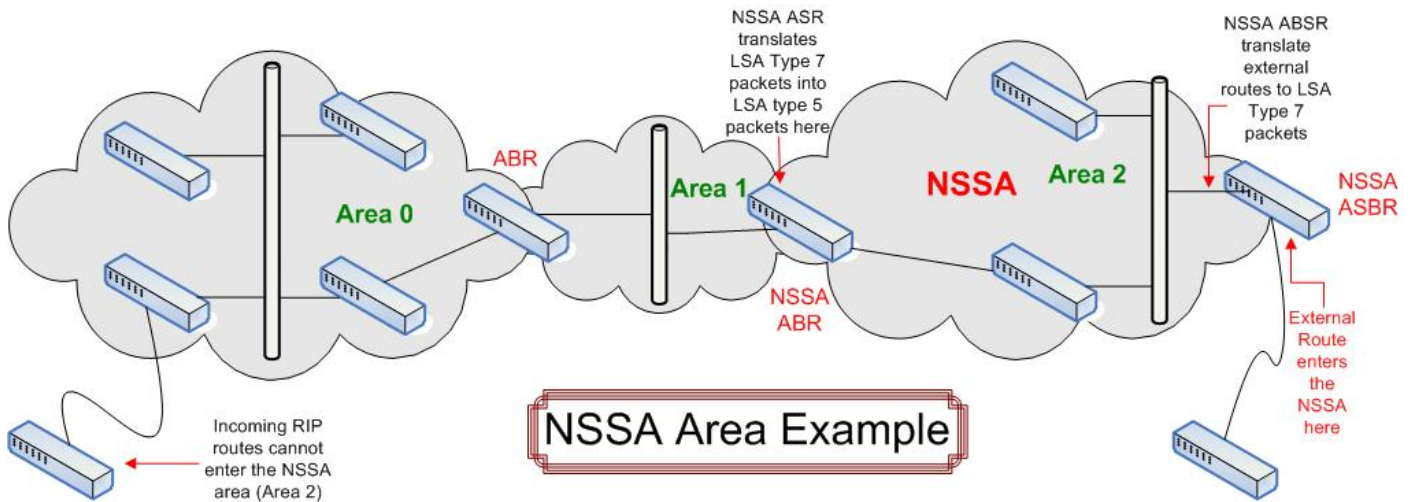

Figure 8- 42. NSSA Area example

The NSSA ASBR (Not So Stubby Area Autonomous System Border Router) is receiving External Route information and translating it as an LSA Type-7 packet that will be distributed ONLY to switches within the NSSA (Area 2 in the example above). For this route’s information to enter another area, the LSA Type-7 packet has to be translated into an LSA Type-5 packet by the NSSA ABR (Area Border Router) and then is distributed to other switches within the other OSPF areas (Area 1 and 2 in the example above). Once completed, new routes are learned and new shortest routes will be determined.

To alleviate any problems with OSPF summary routing due to new routes and packets, all NSSA area border routers (ABR) must support optional importing of LSA type-3 summary packets into the NSSA.

Type-7 LSA Packets

Type-7 LSA (Link State Advertisement) packets are used to import external routes into the NSSA. These packets can originate from NSSA ASBRs or NSSA ABRs and are defined by setting the P-Bit in the LSA type-7 packet header. Each destination network learned from external routes is converted into Type-7 LSA packets. These packets are specific for NSSA switches and the route information contained in these packets cannot leave the area unless translated into Type-5 LSA packets by Area Border Routers. See the following table for a better description of the LSA type-7 packet seen here.

Link-State Advertisement Type-7 Packet

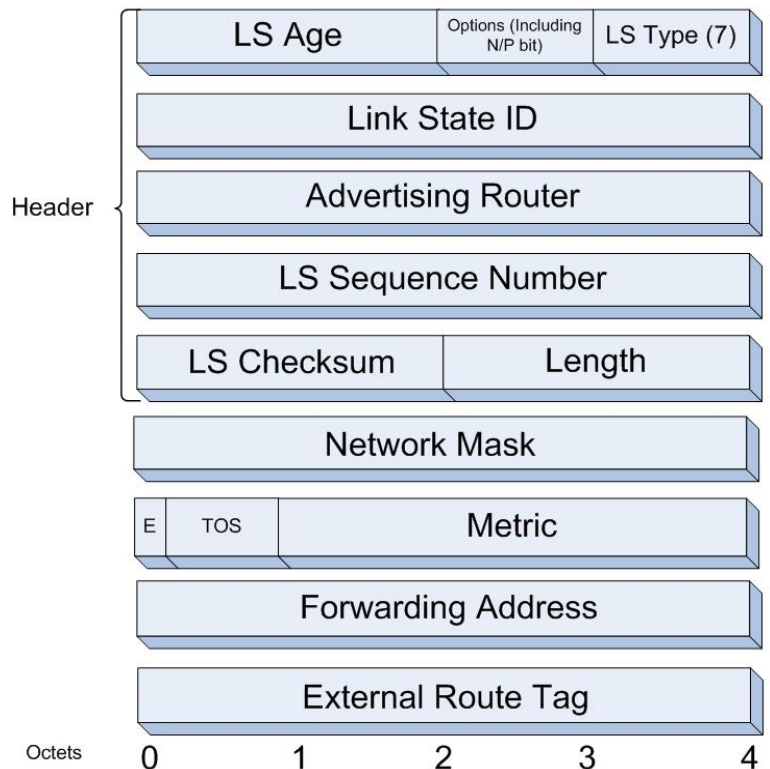

Figure 8- 43. LSA Type-7 Packet

| Field | Description |
|---------------------------------|---|
| Link State Packet Header | This field will hold information concerning information regarding the LS Checksum, length, LS sequence number, Advertising Router, Link State ID, LS age, the packet type (Type-7), and the options field. The Options byte contains information regarding the N-Bit and the P-Bit, which will be described later in this section. |
| Network Mask | The IP address mask for the advertised destination. |
| E - bit | The type of external metric. If the E-bit is set, the metric specified is a Type 2 external metric. This means the metric is considered larger than any link state path. If the E-bit is zero, the specified metric is a Type 1 external metric. This means that is comparable directly to the link state metric. |
| Forwarding Address | Data traffic for the advertised destination will be forwarded to this address. If the Forwarding Address is set to 0.0.0.0, data traffic will be forwarded instead to the advertisement's originator. Yet, if the network between the NSSA ASBR and the adjacent AS is advertised in the area as an internal OSPF route, this address will be the next hop address. Conversely, if the network is not advertised as internal, this field should be any of the router's active OSPF interfaces. |
| TOS | The Type of Service that the following cost is relevant to. |
| Metric | The cost of this route. The interpretation of this metric depends on the external type indication (the E-bit above). |
| External Route Tag | A 32-bit field attached to each external route. This is not used by the OSPF protocol itself. |

The N-Bit

Contained in the options field of the Link State Packet header, the N-Bit is used to ensure that all members of an NSSA agree on the area configurations. Used in conjunction with the E-Bit, these two bits represent the flooding capability of an external LSA. Because type-5 LSAs cannot be flooded into the NSSA, the N-Bit will contain information for sending and receiving LSA type-7 packets, while the E-bit is to be cleared. An additional check must be created for the function that accepts these packets to verify these two bits (N and E-Bit). Bits matching the checking feature will be accepted, while other bit combinations will be dropped.

The P-Bit

Also included in the Options field of the LSA type-7 packet, the P-Bit (propagate) is used to define whether or not to translate the LSA type-7 packet into an LSA type-5 packet for distribution outside the NSSA.

LSA Type-7 Packet Features

- LSA Type-7 address ranges for OSPF areas are defined as a pair, consisting of an IP address and a mask. The packet will also state whether or not to advertise and it will also contain an external route tag.
- The NSSA ASBR will translate external routes into type-7 LSAs to be distributed on the NSSA. NSSA ABRs will optionally translate these type-7 packets into type-5 packets to be distributed among other OSPF areas. These type-5 packets are indiscernible from other type-5 packets. The NSSA does not support type-5 LSAs.
- Once border routers of the NSSA have finished translating or grouping type-7 LSAs into type-5 LSAs, type-5 LSAs should be flushed or reset as a translation or an aggregation of other type-7 LSAs.
- The forwarding addresses contained in translated type-5 LSAs must be set, with the exception of an LSA address range match.

OSPF Global Settings

This window allows OSPF to be enabled or disabled on the Switch – without changing the Switch’s OSPF configuration. To enable OSPF, first supply an OSPF Route ID (see below), select *Enabled* from the State drop-down menu and click the **Apply** button.

To view the following window, click **L3 Features > OSPF > OSPF Global Settings**, as shown below.

Figure 8- 44. OSPF Global Settings window

The following parameters are used for general OSPF configuration:

| Parameter | Description |
|--------------------------|--|
| OSPF Router ID | A 32-bit number (in the same format as an IP address – xxx.xxx.xxx.xxx) that uniquely identifies the Switch in the OSPF domain. It is common to assign the highest IP address assigned to the Switch (router). In this case, it would be 10.24.22.200, but any unique 32-bit number will do. If 0.0.0.0 is entered, the highest IP address assigned to the Switch will become the OSPF Route ID. |
| Current Router ID | Displays the OSPF Route ID currently in use by the Switch. This Route ID is displayed as a convenience to the user when changing the Switch’s OSPF Route ID. |
| State | Allows OSPF to be enabled or disabled globally on the Switch without changing the OSPF configuration. |

OSPF Area Settings

This menu allows the configuration of OSPF Area IDs and to designate these areas as Normal, Stub or NSSA. Normal OSPF areas allow Link-State Database (LSDB) advertisements of routes to networks that are external to the area. Stub areas do not allow the LSDB advertisement of external routes. Stub areas use a default summary external route (0.0.0.0 or Area 0) to reach external destinations.

To set up an OSPF area configuration, click **Layer 3 Features > OSPF > OSPF Area Settings**, as shown below.

Figure 8- 45. OSPF Area Settings window

To add an OSPF Area to the table, type a unique Area ID (see below) select the Type from the drop-down menu. For a Stub type, choose *Enabled* or *Disabled* from the Stub Summary drop-down menu and determine the Metric. Click the **Add/Modify** button to add the area ID set to the table.

To remove an Area ID configuration set, simply click  in the Delete column for the configuration.

To change an existing set in the list, type the Area ID of the set you want to change, make the changes and click the **Add/Modify** button. The modified OSPF area ID will appear in the table.



| OSPF Area Settings | | | | | |
|-------------------------|--------|-------------------------|-------------------|-----------|---|
| Area ID | Type | Stub Summary | NSSA Summary | Translate | Metric |
| 0.0.0.0 | Normal | Disabled | Disabled | Disabled | 0 |
| | | | | | <input type="button" value="Add/Modify"/> |
| Total Entries: 3 | | | | | |
| OSPF Area Table | | | | | |
| Area ID | Type | Stub Import Summary LSA | Stub Default Cost | Translate | Delete |
| 0.0.0.0 | Normal | None | None | None |  |
| 32.0.0.0 | Normal | None | None | None |  |
| 244.0.0.6 | NSSA | Enabled | 2 | Enabled |  |

Figure 8- 46. OSPF Area Settings example window

See the parameter descriptions below for information on the **OSPF Area ID Settings** window.

The **Area ID** settings are as follows:

| Parameter | Description |
|---------------------|--|
| Area ID | A 32-bit number in the form of an IP address (xxx.xxx.xxx.xxx) that uniquely identifies the OSPF area in the OSPF domain. |
| Type | This field can be toggled between <i>Normal</i> , <i>Stub</i> and <i>NSSA</i> using the pull down menu. When it is toggled to <i>Stub</i> , the additional field Stub Summary, will then be capable to be configured. Choosing <i>NSSA</i> allows the <i>NSSA Summary</i> field and the <i>Translate</i> field to be configured. |
| Stub Summary | Displays whether or not the selected Area will allow Summary Link-State Advertisements (Summary LSAs) to be imported into the area from other areas. |
| NSSA Summary | Use the pull-down menu to enable or disable the importing of OSPF summary routes into the <i>NSSA</i> as Type-3 summary LSAs. The default is <i>Disabled</i> . This field can only be configured if <i>NSSA</i> is chosen in the Type field. |
| Translate | Use the pull-down menu to enable or disable the translating of Type-7 LSAs into Type-5 LSAs, so that they can be distributed outside of the <i>NSSA</i> . The default is <i>Disabled</i> . This field can only be configured if <i>NSSA</i> is chosen in the Type field. |
| Metric | Displays the default cost for the route to the stub of between 0 and 65,535. The default is 1. For <i>NSSA</i> areas, the metric field determines the cost of traffic entering the <i>NSSA</i> area. |

OSPF Interface Settings

This window is used to set up OSPF interfaces. If there are no IP interfaces configured (besides the default System interface), only the System interface settings will appear listed. To change settings for in IP interface, click on the hyperlinked name of the interface to see the configuration window for that interface.

To view this window, click **L3 Features > OSPF > OSPF Interface Settings**, as shown below.

| OSPF Interface Settings | | | | | |
|-------------------------|--------------|---------|------------|----------|--------|
| Interface Name | IP Address | Area ID | Auth. Type | State | Metric |
| System | 10.24.22.200 | 0.0.0.0 | None | Disabled | 1 |

Figure 8- 47. OSPF Interface Settings window

| OSPF Interface Settings - Edit | |
|---|---|
| Interface Name | System |
| IP Address | 10.73.21.33(Link Up) |
| Network Medium Type | BROADCAST |
| Area ID | <input type="text" value="0.0.0.0"/> |
| Router Priority(0-255) | <input type="text" value="1"/> |
| Hello Interval(1-65535) | <input type="text" value="10"/> |
| Dead Interval(1-65535) | <input type="text" value="40"/> |
| State | Disabled <input type="button" value="v"/> |
| Auth. Type | None <input type="button" value="v"/> |
| Password/Auth. Key ID | <input type="text"/> |
| Metric(1-65535) | <input type="text" value="1"/> |
| Passive | Disabled <input type="button" value="v"/> |
| DR State | DOWN |
| DR Address | 0.0.0.0 |
| Backup DR Address | 0.0.0.0 |
| Transmit Delay | 1 |
| Retransmit Time | 5 |
| <input type="button" value="Apply"/> | |
| Show All OSPF Interface Entries | |

Figure 8- 48. OSPF Interface Settings - Edit window

Configure each IP interface individually using the **OSPF Interface Settings - Edit** window. Click the **Apply** button when you have entered the settings. The new configuration appears listed in the **OSPF Interface Settings** window. To return to the **OSPF Interface Settings** window, click the [Show All OSPF Interface Entries](#) link.

OSPF interface settings are described below. Some OSPF interface settings require previously configured OSPF settings. Read the descriptions below for details.

| Parameter | Description |
|----------------|--|
| Interface Name | Displays the of an IP interface previously configured on the Switch. |
| Area ID | Allows the entry of an OSPF Area ID configured above. |

| | |
|---------------------------------|--|
| Router Priority (0-255) | Allows the entry of a number between 0 and 255 representing the OSPF priority of the selected area. If a Router Priority of 0 is selected, the Switch cannot be elected as the Designated Router for the network. |
| Hello Interval (1-65535) | Allows the specification of the interval between the transmissions of OSPF Hello packets, in seconds. Between 1 and 65535 seconds can be specified. The Hello Interval, Dead Interval, Authorization Type, and Authorization Key should be the same for all routers on the same network. |
| Dead Interval (1-65535) | Allows the specification of the length of time between the receipt of Hello packets from a neighbor router before the selected area declares that router down. An interval between 1 and 65535 seconds can be specified. The Dead Interval must be evenly divisible by the Hello Interval. |
| State | Allows the OSPF interface to be disabled for the selected area without changing the configuration for that area. |
| Auth. Type | <p>This field can be toggled between <i>None</i>, <i>Simple</i>, and <i>MD5</i> using the space bar. This allows a choice of authorization schemes for OSPF packets that may be exchanged over the OSPF routing domain.</p> <ul style="list-style-type: none"> • <i>None</i> specifies no authorization. • <i>Simple</i> uses a simple password to determine if the packets are from an authorized OSPF router. When <i>Simple</i> is selected, the Auth Key field allows the entry of an 8-character password that must be the same as a password configured on a neighbor OSPF router. • <i>MD5</i> uses a cryptographic key entered in the MD5 Key Settings window. When <i>MD5</i> is selected, the Auth Key ID field allows the specification of the Key ID as defined in the MD5 configuration above. This must be the same MD5 Key as used by the neighboring router. |
| Password/Auth. Key ID | Enter a Key ID of up to 5 characters to set the Auth. Key ID for either the Simple Auth Type or the MD5 Auth Type, as specified in the previous parameter. |
| Metric (1-65535) | This field allows the entry of a number between 1 and 65,535 that is representative of the OSPF cost of reaching the selected OSPF interface. The default metric is 1. |
| Passive | The user may select Active or Passive for this OSPF interface. Active interfaces actively advertise OSPF to routers on other Intranets that are not part of this specific OSPF group. Passive interface will not advertise to any other routers than those within its OSPF intranet. When this field is disabled, it denotes an active interface. |
| DR State | DR State is a read-only field describing the Designated Router state of the IP interface. This field may read DR if the interface is the designated router, or Backup DR if the interface is the Backup Designated Router. The highest IP address will be the Designated Router and is determined by the OSPF Hello Protocol of the Switch. |
| DR Address | The IP address of the aforementioned Designated Router. |
| Backup DR Address | The IP address of the aforementioned Backup Designated Router. |
| Transmit Delay | A read-only field that denotes the estimated time to transmit a Link State Update Packet over this interface, in seconds. |
| Retransmit Time | A read-only field that denotes the time between LSA retransmissions over this interface, in seconds. |

OSPF Virtual Link Settings

This window shows the current OSPF Virtual Interface Settings. There are no virtual interface settings configured by default, so the first time this table is viewed there will be no interfaces listed. To add a new OSPF virtual interface configuration set to the table, click the **Add** button. A new menu appears (see below). To change an existing configuration, click on the hyperlinked Transit Area ID for the set you want to change. The window to modify an existing set is the same as the window used to add a new one.

To view this window, click **L3 Features > OSPF > OSPF Virtual Link Settings**, as shown below.

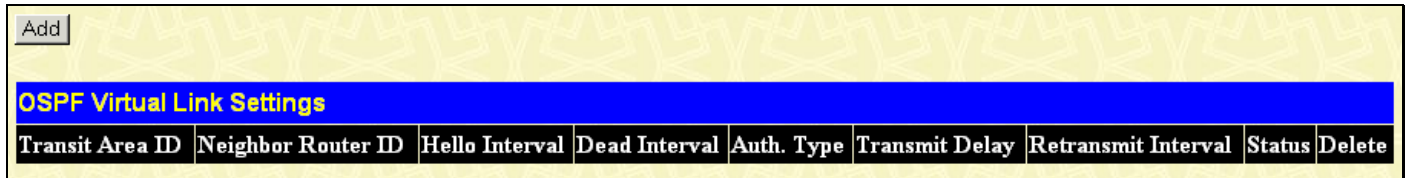

Figure 8- 49. OSPF Virtual Interface Settings window

To delete an existing configuration, click the corresponding button in the Delete column. The status of the virtual interface appears in the Status column.

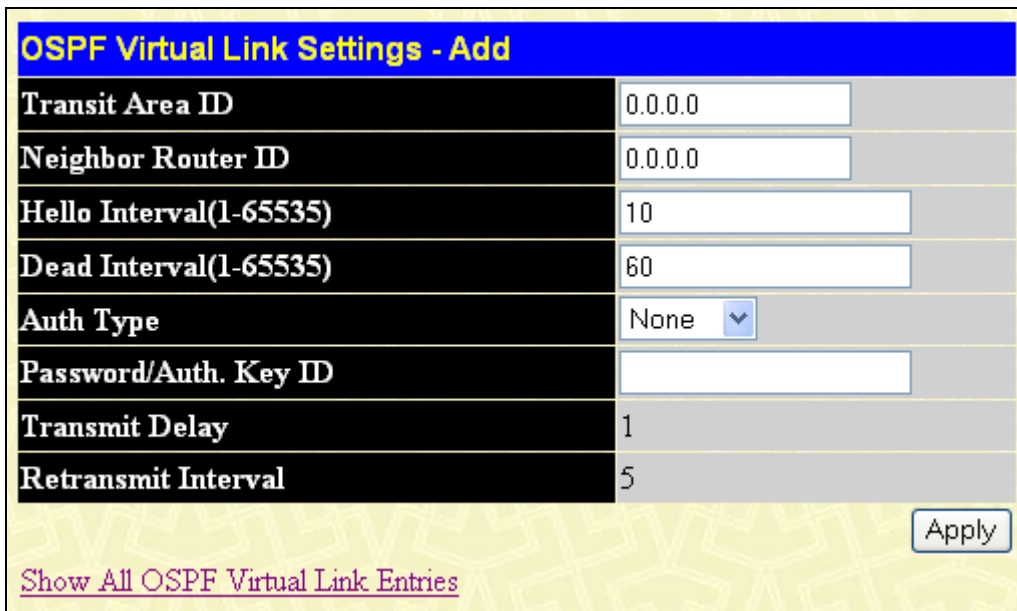

Figure 8- 50. OSPF Virtual Link Settings – Add window

Configure the following parameters if you are adding or changing an OSPF Virtual Interface:

| Parameter | Description |
|---------------------------------|--|
| Transit Area ID | Allows the entry of an OSPF Area ID – previously defined on the Switch – that allows a remote area to communicate with the backbone (area 0). A Transit Area cannot be a Stub Area or a Backbone Area. |
| Neighbor Router ID | The OSPF router ID for the remote router. This is a 32-bit number in the form of an IP address (xxx.xxx.xxx.xxx) that uniquely identifies the remote area’s Area Border Router. |
| Hello Interval (1-65535) | Specify the interval between the transmission of OSPF Hello packets, in seconds. Enter a value between 1 and 65535 seconds. The Hello Interval, Dead Interval, Authorization Type, and Authorization Key should have identical settings for all routers on the same network. |
| Dead Interval (1-65535) | Specify the length of time between (receiving) Hello packets from a neighbor router before the selected area declares that router down. Again, all routers on the network should use the same setting. |
| Auth Type | If using authorization for OSPF routers, select the type being used. MD5 key authorization must be set up in the MD5 Key Settings window. |

| | |
|------------------------------|---|
| Password/Auth. Key ID | Enter a case-sensitive password for simple authorization or enter the MD5 key you set in the MD5 Key Settings window. |
| Transmit Delay | The number of seconds required to transmit a link state update over this virtual link. Transit delay takes into account transmission and propagation delays. This field is fixed at 1 second. |
| Retransmit Interval | The number of seconds between link state advertisement retransmissions for adjacencies belonging to this virtual link. This field is fixed at 5 seconds. |

Click **Apply** to implement changes made.



NOTE: For OSPF to function properly some settings should be identical on all participating OSPF devices. These settings include the Hello Interval and Dead Interval. For networks using authorization for OSPF devices, the Authorization Type and Password or Key used must likewise be identical.

OSPF Area Aggregation Settings

Area Aggregation allows all of the routing information that may be contained within an area to be aggregated into a summary LSDB advertisement of just the network address and subnet mask. This allows for a reduction in the volume of LSDB advertisement traffic as well as a reduction in the memory overhead in the Switch used to maintain routing tables. There are no aggregation settings configured by default, so there will not be any listed the first accessing the window. To add a new OSPF Area Aggregation setting, click the **Add** button. A new window (pictured below) appears. To change an existing configuration, click on the corresponding **Modify** button for the set you want to change. The window to modify an existing configuration is the same as the window used to add a new one.

To view this window, click **L3 Features > OSPF > OSPF Area Aggregation Settings**, as shown below.

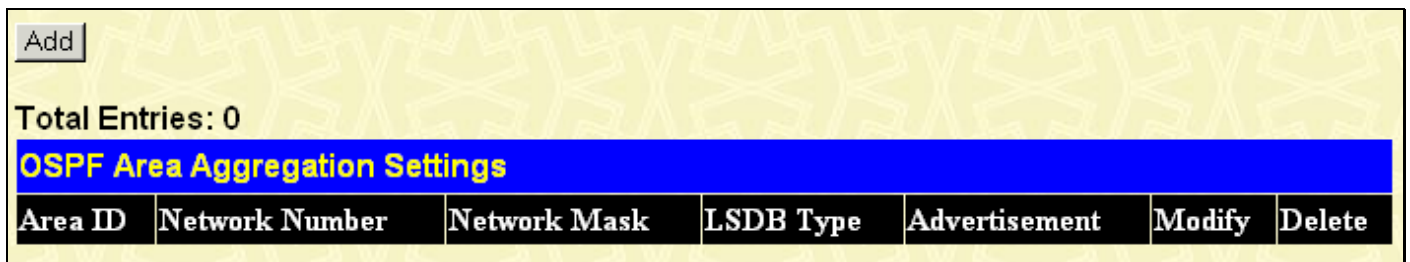

Figure 8- 51. OSPF Area Aggregation Settings window

Use the window below to change settings or add a new OSPF Area Aggregation setting.

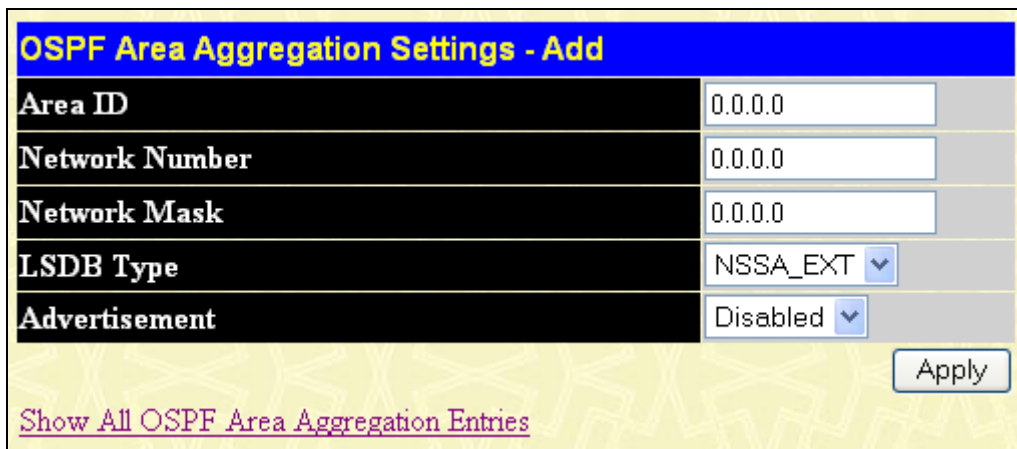

Figure 8- 52. OSPF Area Aggregation Settings – Add window

Specify the OSPF aggregation settings and click the **Apply** button to add or change the settings. The new settings will appear listed in the **OSPF Area Aggregation Settings** window. To view the table, click the [Show All OSPF Area Aggregation Entries](#) link to return to the previous window.

Use the following parameters to configure the following settings for OSPF Area Aggregation Settings:

| Parameter | Description |
|-----------------------|---|
| Area ID | Allows the entry the OSPF Area ID for which the routing information will be aggregated. This Area ID must be previously defined on the Switch. |
| Network Number | Sometimes called the Network Address. The 32-bit number in the form of an IP address that uniquely identifies the network that corresponds to the OSPF Area above. |
| Network Mask | The corresponding network mask for the Network Number specified above. |
| LSDB Type | Specifies the type of address aggregation. The user may choose <i>Summary</i> or <i>NSSA-EXT</i> , depending on the type of aggregation being configured. The default setting is <i>Summary</i> . |
| Advertisement | Select <i>Enabled</i> or <i>Disabled</i> to determine whether the selected OSPF Area will advertise its summary LSDB (Network-Number and Network-Mask). |

Click **Apply** to implement changes made.

OSPF Host Route Settings

OSPF host routes work in a way analogous to RIP, only this is used to share OSPF information with other OSPF routers. This is used to work around problems that might prevent OSPF information sharing between routers. To add a new OSPF Route, click the **Add** button. Configure the setting in the window that appears. The **Add** and **Modify** windows for OSPF host route settings are nearly identical. The difference between them is that if you are changing an existing configuration you will be unable to change the Host Address. To change an existing configuration, click on the corresponding **Modify** button in the list for the configuration to change and proceed to change the metric or area ID.

To configure OSPF host routes, click **L3 Features > OSPF > OSPF Host Route Settings**, as shown below.

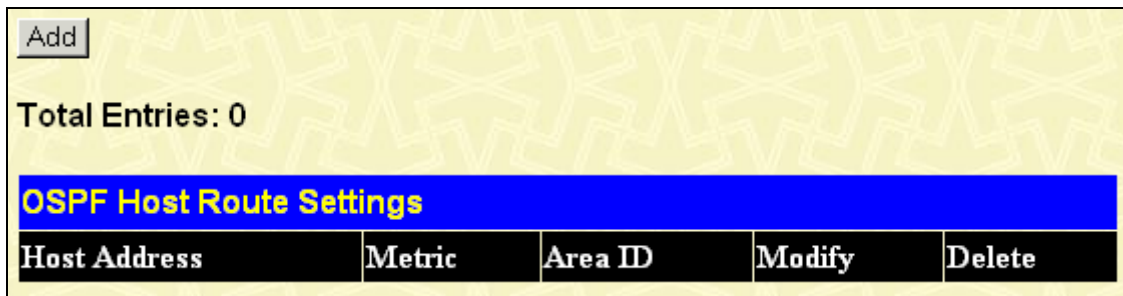

Figure 8- 53. OSPF Host Route Settings table

Use the window below to add an OSPF host route.

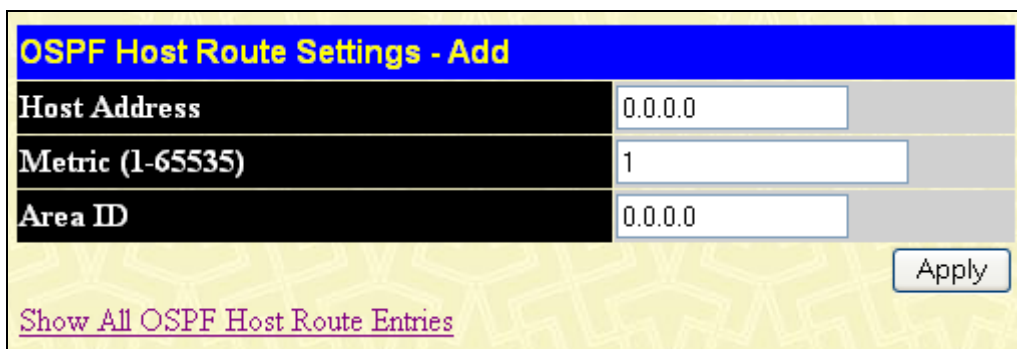

Figure 8- 54. OSPF Host Route Settings – Add window

Specify the host route settings and click the **Apply** button to add or change the settings. The new settings will appear listed in the **OSPF Host Route Settings** window. To view the previous window, click the [Show All OSPF Host Route Entries](#) link to return to the previous window.

The following fields are configured for OSPF host route:

| Parameter | Description |
|--------------|---|
| Host Address | The IP address of the OSPF host. |
| Metric | A value between 1 and 65535 that will be advertised for the route. |
| Area ID | A 32-bit number in the form of an IP address (xxx.xxx.xxx.xxx) that uniquely identifies the OSPF area in the OSPF domain. |

DHCP/BOOTP Relay

The *DHCP/BOOTP Relay Hops Count Limit* allows the maximum number of hops (routers) that the DHCP/BOOTP messages can be relayed through to be set. If a packet's hop count is more than the hop count limit, the packet is dropped. The range is between 1 and 16 hops, with a default value of 4. The relay time threshold sets the minimum time (in seconds) that the Switch will wait before forwarding a BOOTREQUEST packet. If the value in the seconds field of the packet is less than the relay time threshold, the packet will be dropped. The range is between 0 and 65,536 seconds, with a default value of 0 seconds.

DHCP / BOOTP Relay Global Settings

This table is used to enable and configure DHCP/BOOTP Relay global settings on the Switch.

To view this window, click **L3 Features > DHCP/BOOTP Relay > DHCP/BOOTP Relay Global Settings**, as shown below.

| DHCP/BOOTP Relay Global Settings | |
|---|------------|
| DHCP/BOOTP Relay State | Disabled ▾ |
| DHCP/BOOTP Relay Hops Count Limit (1-16) | 4 |
| DHCP/BOOTP Relay Time Threshold (0-65535) | 0 |
| DHCP Relay Agent Information Option 82 State | Disabled ▾ |
| DHCP Relay Agent Information Option 82 Check | Disabled ▾ |
| DHCP Relay Agent Information Option 82 Policy | Replace ▾ |

Apply

Figure 8- 55. DHCP/ BOOTP Relay Global Settings window

The following fields can be set:

| Parameter | Description |
|--|---|
| Relay State | This field can be toggled between <i>Enabled</i> and <i>Disabled</i> using the pull-down menu. It is used to enable or disable the DHCP/BOOTP Relay service on the Switch. The default is <i>Disabled</i> |
| Relay Hops Count Limit (1-16) | This field allows an entry between 1 and 16 to define the maximum number of router hops DHCP/BOOTP messages can be forwarded across. The default hop count is 4. |
| Relay Time Threshold (0-65535) | Allows an entry between 0 and 65535 seconds, and defines the maximum time limit for routing a DHCP/BOOTP packet. If a value of 0 is entered, the Switch will not process the value in the seconds field of the BOOTP or DHCP packet. If a non-zero value is entered, the Switch will use that value, along with the hop count to determine whether to forward a given BOOTP or DHCP packet. |
| DHCP Agent Information Option 82 State | This field can be toggled between <i>Enabled</i> and <i>Disabled</i> using the pull-down menu. It is used to enable or disable the DHCP Agent Information Option 82 on the Switch. The default is <i>Disabled</i> . |

| | |
|---|--|
| | <p><i>Enabled</i> – When this field is toggled to <i>Enabled</i> the relay agent will insert and remove DHCP relay information (option 82 field) in messages between DHCP servers and clients. When the relay agent receives the DHCP request, it adds the option 82 information, and the IP address of the relay agent (if the relay agent is configured), to the packet. Once the option 82 information has been added to the packet it is sent on to the DHCP server. When the DHCP server receives the packet, if the server is capable of option 82, it can implement policies like restricting the number of IP addresses that can be assigned to a single remote ID or circuit ID. Then the DHCP server echoes the option 82 field in the DHCP reply. The DHCP server unicasts the reply to the back to the relay agent if the request was relayed to the server by the relay agent. The switch verifies that it originally inserted the option 82 data. Finally, the relay agent removes the option 82 field and forwards the packet to the switch port that connects to the DHCP client that sent the DHCP request.</p> <p><i>Disabled</i>- If the field is toggled to <i>Disabled</i> the relay agent will not insert and remove DHCP relay information (option 82 field) in messages between DHCP servers and clients, and the check and policy settings will have no effect.</p> |
| <p>DHCP Agent Information Option 82 Check</p> | <p>This field can be toggled between <i>Enabled</i> and <i>Disabled</i> using the pull-down menu. It is used to enable or disable the Switches ability to check the validity of the packet’s option 82 field.</p> <p><i>Enabled</i> – When the field is toggled to <i>Enable</i>, the relay agent will check the validity of the packet’s option 82 field. If the switch receives a packet that contains the option-82 field from a DHCP client, the switch drops the packet because it is invalid. In packets received from DHCP servers, the relay agent will drop invalid messages.</p> <p><i>Disabled</i>- When the field is toggled to <i>Disabled</i>, the relay agent will not check the validity of the packet’s option 82 field.</p> |
| <p>DHCP Agent Information Option 82 Policy</p> | <p>This field can be toggled between <i>Replace</i>, <i>Drop</i>, and <i>Keep</i> by using the pull-down menu. It is used to set the Switches policy for handling packets when the DHCP Agent Information Option 82 Check is set to <i>Disabled</i>. The default is <i>Replace</i>.</p> <p><i>Replace</i> - The option 82 field will be replaced if the option 82 field already exists in the packet received from the DHCP client.</p> <p><i>Drop</i> - The packet will be dropped if the option 82 field already exists in the packet received from the DHCP client.</p> <p><i>Keep</i> - The option 82 field will be retained if the option 82 field already exists in the packet received from the DHCP client.</p> |

Click **Apply** to implement any changes that have been made.



NOTE: If the Switch receives a packet that contains the option-82 field from a DHCP client and the information-checking feature is enabled, the Switch drops the packet because it is invalid. However, in some instances, it is possible to configure a client with the option-82 field. In this situation, disable the information-check feature so that the Switch does not remove the option-82 field from the packet. Users can configure the action that the Switch takes when it receives a packet with existing option-82 information by configuring the DHCP Agent Information Option 82 Policy.

The Implementation of DHCP Information Option 82

The `config dhcp_relay option_82` command configures the DHCP relay agent information option 82 setting of the Switch. The formats for the circuit ID sub-option and the remote ID sub-option are as follows:



NOTE: For the circuit ID sub-option of a standalone switch, the module field is always zero.

Circuit ID sub-option format:

| | | | | | | |
|--------|--------|--------|--------|---------|--------|--------|
| 1. | 2. | 3. | 4. | 5. | 6. | 7. |
| 1 | 6 | 0 | 4 | VLAN | Module | Port |
| 1 byte | 1 byte | 1 byte | 1 byte | 2 bytes | 1 byte | 1 byte |

- a. Sub-option type
- b. Length
- c. Circuit ID type
- d. Length
- e. VLAN: the incoming VLAN ID of DHCP client packet.
- f. Module: For a standalone switch, the Module is always 0; For a stackable switch, the Module is the Unit ID.
- g. Port: The incoming port number of DHCP client packet, port number starts from 1.

Remote ID sub-option format:

| | | | | |
|--------|--------|--------|--------|-------------|
| 1. | 2. | 3. | 4. | 5. |
| 2 | 8 | 0 | 6 | MAC address |
| 1 byte | 1 byte | 1 byte | 1 byte | 6 bytes |

- 1. Sub-option type
- 2. Length
- 3. Remote ID type
- 4. Length
- 5. MAC address: The Switch's system MAC address.

Figure 8- 56. Circuit ID and Remote ID Sub-option Format

DHCP/BOOTP Relay Interface Settings

This window allows the user to set up a server, by IP address, for relaying DHCP/ BOOTP information to the Switch. The user may enter a previously configured IP interface on the Switch that will be connected directly to the DHCP/BOOTP client using the following window. Properly configured settings will be displayed in the table at the bottom of the following window, once the user clicks the **Add** button under the **Apply** heading. The user may add up to four server IPs per IP interface on the Switch.

To view this window, click **L3 Features > DHCP/BOOTP Relay > DHCP/BOOTP Relay Interface Settings**, as shown below.

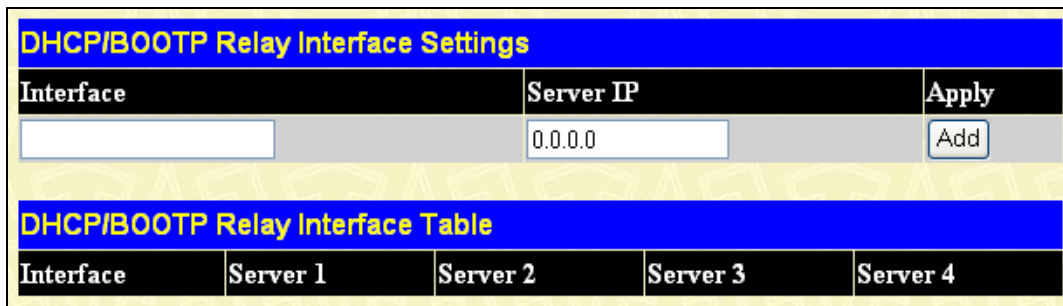

Figure 8- 57. DHCP/BOOTP Relay Interface Settings window

The following parameters may be configured or viewed.

| Parameter | Description |
|------------------|---|
| Interface | The IP interface on the Switch that will be connected directly to the Client. |
| Server IP | Enter the IP address of the DHCP/BOOTP server. Up to four server IPs can be configured per IP Interface |

DHCP Server

For this release, the Switch now has the capability to act as a DHCP server to devices within its locally attached network. DHCP, or Dynamic Host Configuration Protocol, allows the switch to delegate IP addresses, subnet masks, default gateways and other IP parameters to devices that request this information. This occurs when a DHCP enabled device is booted on or attached to the locally attached network. This device is known as the DHCP client and when enabled, it will emit query messages on the network before any IP parameters are set. When the DHCP server receives this request, it returns a response to the client, containing the previously mentioned IP information that the DHCP client then utilizes and sets on its local configurations.

The user can configure many DHCP related parameters that it will utilize on its locally attached network, to control and limit the IP settings of clients desiring an automatic IP configuration, such as the lease time of the allotted IP address, the range of IP addresses that will be allowed in its DHCP pool, the ability to exclude various IP addresses within the pool as not to make identical entries on its network, or to assign the IP address of an important device (such as a DNS server or the IP address of the default route) to another device on the network.

Users also have the ability to bind IP addresses within the DHCP pool to specific MAC addresses in order to keep consistent the IP addresses of devices that may be important to the upkeep of the network that require a static IP address.

To begin configuring the Switch as a DHCP Server, open the **L3 Features** folder, then the **DHCP Server** folder, which will display five links to aid the user in configuring the DHCP server.

DHCP Server Global Settings

The following window will allow users to globally enable the switch as a DHCP server and set the DHCP Ping Settings to test connectivity between the DHCP Server and Client.

To view this window, click **L3 Features > DHCP Server > DHCP Server Global Settings**, as shown below.

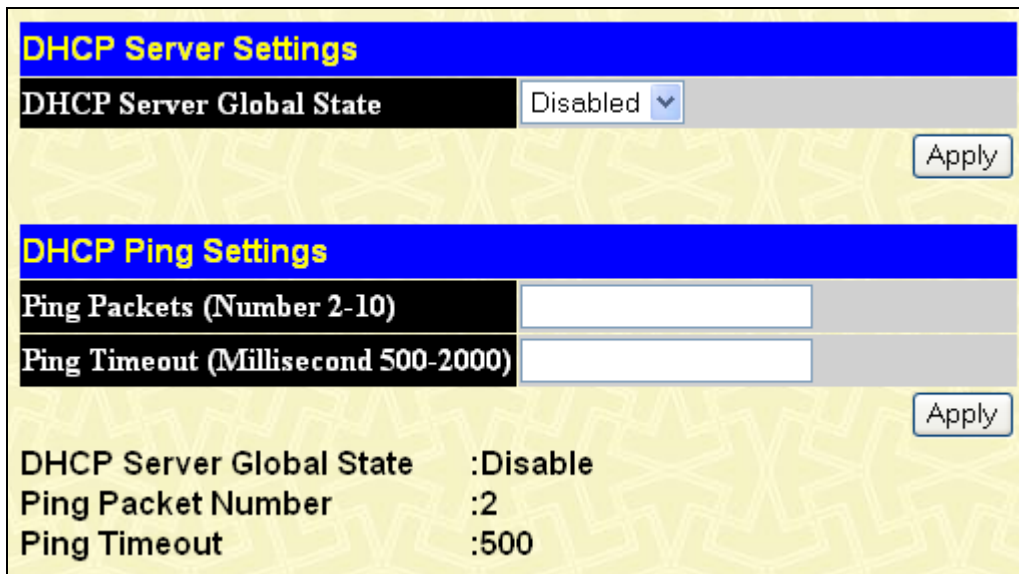

Figure 8- 58. DHCP Server Settings window

The following parameters may be configured.

| Parameter | Description |
|---------------------------------|---|
| DHCP Server Global State | Use the pull-down menu to globally enable or disable the switch as a DHCP server. |
| Ping Packets | Enter a number between 2 and 10 to denote the number of ping packets that the Switch will send out on the network containing the IP address to be allotted. If the ping request is not returned, the IP address is considered unique to the local network and then allotted to the requesting client. The default setting is 2 packets. |
| Ping Timeout | The user may set a time between 500 and 2000 milliseconds that the Switch will wait before timing out a ping packet. The default setting is 500 milliseconds. |

Click **Apply** to implement changes made.

DHCP Server Exclude Address Settings

The following window will allow the user to set an IP address, or a range of IP addresses that are NOT to be included in the range of IP addresses that the Switch will allot to clients requesting DHCP service. To set an IP address or range of IP addresses, enter the Begin Address of the range and then the End Address of the range and click **Apply**. Set address ranges will appear in the DHCP Exclude Address Table in the bottom half of the window, as shown below.

To view this window, click **L3 features > DHCP Server > DHCP Server Exclude Address Settings**, as shown below.

Figure 8- 59. Create DHCP Excluded Address window

DHCP Server Pool Settings

The following windows will allow users to create and then set the parameters for the DHCP Pool of the switch’s DHCP server. Users must first create the pool by entering a name of up to 12 alphanumeric characters into the Pool Name field and clicking **Apply**. Once created, users can modify the settings of a pool by clicking its corresponding **Modify** button.

To view the following window, click **L3 features > DHCP Server > DHCP Server Pool Settings**, as shown below.

Figure 8- 60. Create DHCP Pool window

Clicking the **Modify** button of a corresponding DHCP Pool will lead to the following window in which users can adjust the settings for the specific DHCP pool table.

| Config DHCP Pool | |
|--|---|
| Pool Name | RG |
| IP Address | <input type="text" value="0.0.0.0"/> |
| Netmask | <input type="text" value="0.0.0.0"/> |
| Domain Name | <input type="text"/> |
| DNS Server Address | <input type="text" value="0.0.0.0"/> |
| | <input type="text" value="0.0.0.0"/> |
| | <input type="text" value="0.0.0.0"/> |
| NetBIOS Name Server | <input type="text" value="0.0.0.0"/> |
| | <input type="text" value="0.0.0.0"/> |
| | <input type="text" value="0.0.0.0"/> |
| NetBIOS Node Type | Broadcast <input type="button" value="v"/> |
| Default Router | <input type="text" value="0.0.0.0"/> |
| | <input type="text" value="0.0.0.0"/> |
| | <input type="text" value="0.0.0.0"/> |
| Pool Lease | 1 <input type="text"/> Days <input type="button" value="v"/> 00 <input type="text"/> Hours <input type="button" value="v"/> 00 <input type="text"/> Minutes <input type="checkbox"/> Infinite |
| Boot File | <input type="text"/> |
| Next Server | <input type="text" value="0.0.0.0"/> |
| <input type="button" value="Apply"/> | |
| Show All DHCP Pool Entries | |

Figure 8- 61. Config DHCP Pool window

The following parameters may be configured or viewed.

| Parameter | Description |
|-----------------------------|--|
| Pool Name | Denotes the name of the DHCP pool for which you are currently adjusting the parameters. |
| IP Address | Enter the IP address to be assigned to requesting DHCP Clients. This address will not be chosen but the first 3 sets of numbers in the IP address will be used for the IP address of requesting DHCP Clients. (ex. If this entry is given the IP address 10.10.10.2, then assigned addresses to DHCP Clients will resemble 10.10.10.x, where x is a number between 1 and 255 but does not include the assigned 10.10.10.2) |
| Netmask | Enter the corresponding Netmask of the IP address assigned above. |
| Domain Name | Enter the domain name for the DHCP client. This domain name represents a general group of networks that collectively make up the domain. The Domain Name may be an alphanumeric string of up to 64 characters. |
| DNS Server Address | Enter the IP address of a DNS server that is available to the DHCP client. The DNS Server correlates IP addresses to host names when queried. Users may add up to three DNS Server addresses. |
| Net BIOS Name Server | Enter the IP address of a Net BIOS Name Server that will be available to a Microsoft DHCP Client. This Net BIOS Name Server is actually a WINS (Windows Internet Naming Service) Server that allows Microsoft DHCP clients to correlate host names to IP addresses within a general grouping of networks. The user may establish up to three Net BIOS Name Servers. |

| | |
|--------------------------|---|
| NetBIOS Node Type | This field will allow users to set the type of node server for the previously configured Net BIOS Name server. Using the pull-down menu, the user has four node type choices: <i>Broadcast</i> , <i>Peer to Peer</i> , <i>Mixed</i> , and <i>Hybrid</i> . |
| Default Router | Enter the IP address of the default router for a DHCP Client. Users must configure at least one address here, yet up to three IP addresses can be configured for this field. The IP address of the default router must be on the same subnet as the DHCP client. |
| Pool Lease | Using this field, the user can specify the lease time for the DHCP client. This time represents the amount of time that the allotted address is valid on the local network. Users may set the time by entering the days into the open field and then use the pull-down menus to precisely set the time by hours and minutes. Users may also use the Infinite check box to set the allotted IP address to never be timed out of its lease. The default setting is 1 day. |
| Boot File | This field is used to specify the Boot File that will be used as the boot image of the DHCP client. This image is usually the operating system that the client uses to load its IP parameters. |
| Next Server | This field is used to identify the IP address of the device that has the previously stated boot file. |

Click **Apply** to implement changes made.

To view the set parameters for configured DHCP Pool, click the **View** button of a configured entry in the DHCP Server Pool Table in the **Create DHCP Pool** window, which will produce the following window:

| DHCP Server Pool Display | |
|---|----------------------------|
| Pool Name | RG |
| IP Address | 0.0.0.0 |
| Netmask | 0.0.0.0 |
| Domain Name | |
| DNS Server Address | 0.0.0.0 |
| | 0.0.0.0 |
| NetBIOS Name Server | 0.0.0.0 |
| | 0.0.0.0 |
| NetBIOS Node Type | Broadcast |
| | 0.0.0.0 |
| Default Router | 0.0.0.0 |
| | 0.0.0.0 |
| Pool Lease | 1 Days, 0 Hours, 0 Minutes |
| Boot File | |
| Next Server | 0.0.0.0 |
| Show All DHCP Server Pool Entries | |

Figure 8- 62. DHCP Server Pool Display window

DHCP Server Dynamic Binding

The following window will allow users to view dynamically bound IP addresses of the DHCP server. These IP addresses are ones that were allotted to clients on the local network and are now bound to the device stated by its MAC address.

To view this window, click **L3 Features > DHCP Server > DHCP Server Dynamic Binding**, as shown below.

Figure 8- 63. DHCP Server Dynamic Binding Table window

The following parameters may be configured or viewed.

| Parameter | Description |
|-------------------------|---|
| Pool Name | To find the dynamically bound entries of a specific pool, enter the Pool Name into the field and click Find . Dynamically bound entries of this pool will be displayed in the table. To clear the corresponding Pool Name entries of this table, click Clear . To clear all entries, click Clear All . |
| Pool Name | This field will denote the Pool Name of the displayed dynamically bound DHCP entry. |
| IP Address | This field will display the IP address allotted to this device by the DHCP Server feature of this Switch. |
| Hardware Address | This field will display the MAC address of the device that is bound to the corresponding IP address. |
| Type | This field will display the type of node server being used for the previously configured Net BIOS Name server of this entry. |
| Status | This field will display the Status of the entry, whether it was dynamically bound or manually bound. |
| Life Time (sec) | This field will display, in seconds, the time remaining on the lease for this IP address. |

DHCP Server Manual Binding

The following windows will allow users to view and set manual DHCP entries. Manual DHCP entries will bind an IP address with the MAC address of a client within a DHCP pool. These entries are necessary for special devices on the local network that will always require a static IP address that cannot be changed.

To view this window, click **L3 Features > DHCP Server > DHCP Server Manual Binding**, as shown below.

Figure 8- 64. DHCP Server Manual Binding Table window

Users may view statically bound DHCP entries within a DHCP pool by entering the Pool Name and clicking **Find**. Results will be displayed in the window above. To set a manual DHCP Binding entry, click the **Add** window, which will produce the following window to configure.

Figure 8- 65. Create DHCP Pool Manual Binding window

The following parameters may be configured or viewed.

| Parameter | Description |
|-------------------------|---|
| Pool Name | Enter the name of the DHCP pool within which will be created a manual DHCP binding entry. |
| IP Address | Enter the IP address to be statically bound to a device within the local network that will be specified by entering the Hardware Address in the following field. |
| Hardware Address | Enter the MAC address of the client to be statically bound to the IP address entered in the previous field. |
| Type | This field is used to specify the type of connection for which this manually bound entry will be set. <i>Ethernet</i> will denote that the manually bound device is connected directly to the Switch, while the <i>IEEE802</i> denotes that the manually bound device is outside the local network of the Switch. |

Click **Apply** to set the entry.

Filter DHCP Server

The Dynamic Host Configuration Protocol (DHCP) automates the assignment of IP addresses, subnet masks, default routers, and other IP parameters. The assignment usually occurs when the DHCP configured machine boots up or regains connectivity to the network. The DHCP client sends out a query requesting a response from a DHCP server on the locally attached network. The DHCP server then replies to the client with its assigned IP address, subnet mask, DNS server and default gateway information.

This function allows DHCP server packets except those that have been IP/client MAC bound to be filtered. The Filter DHCP Server is used to configure the state of the function for filtering of DHCP server packets and to add or delete the DHCP server/client binding entry. This command has two purposes firstly to filter all DHCP server packets on the specified port(s) and secondly to allow some DHCP server packets to be forwarded if they are on the pre-defined server IP address/MAC address binding list. Thus the DHCP server can be restricted to service a specified DHCP client. This is useful when there are two or more DHCP servers present on a network.

Filter DHCP Server Global Settings

This window is used to enable the settings for the **Filter DHCP Server Global Settings** on the Switch.

To view this table, click **L3 Features > Filter DHCP Server > Filter DHCP Server Global Settings**, as shown below.

| DHCP Server Filter Global Settings | |
|--------------------------------------|----------|
| Trap / Log | Disabled |
| Illegal Server Log Suppress Duration | 5 min |
| Apply | |

Figure 8- 66. DHCP Server Filter Global Settings window

The following parameters may be configured.

| Parameter | Description |
|--------------------------------------|---|
| Trap/Log | To <i>Enable</i> or <i>Disable</i> the function for filtering DHCP server packets. |
| Illegal Server Log Suppress Duration | The DHCP server filtering function filters any illegal DHCP server packets. The DHCP server who sends the illegal packets will be logged. This command is used to suppress the logging of DHCP servers who continue to send illegal DHCP packets. The same illegal DHCP server IP address that is detected will be logged only once regardless of how many illegal packets are sent. The log can be suppressed by <i>1 minute</i> , <i>5 minutes</i> or <i>30 minutes</i> . The default value is 5 minutes. |

Click **Apply** to implement the changes.

Filter DHCP Server Port Settings

This window is used to enable the settings for the **Filter DHCP Server Port Settings**.

To view this window, click **L3 Features > Filter DHCP Server > Filter DHCP Server Port Settings**, as shown below.

Filter DHCP Server Port State Settings

| | |
|-----------------|---|
| State | Disabled <input type="button" value="v"/> |
| PortList | <input type="text"/> <input type="checkbox"/> All Ports |

Filter DHCP Server Enabled Ports Table

| | |
|----------------------|--|
| Enabled Ports | |
|----------------------|--|

Filter DHCP Server Port Settings

| | |
|---------------------------|---|
| Action | Add <input type="button" value="v"/> |
| Server IP Address | <input type="text"/> |
| Client MAC Address | <input type="text"/> |
| PortList | <input type="text"/> <input type="checkbox"/> All Ports |

Total Entries: 0

Filter DHCP Server/Client Table

| Server IP Address | Client MAC Address | Port |
|-------------------|--------------------|------|
|-------------------|--------------------|------|

Figure 8- 67. Filter DHCP Server Port State Settings window

The following parameters may be configured.

| Parameter | Description |
|---|---|
| State | Used to <i>Enable</i> or <i>Disable</i> the Filter DHCP Server Port State Settings . |
| PortList | Specifies the ports that will enable filter DHCP server. |
| Filter DHCP Server Port Settings | |
| Action | Select <i>Add</i> or <i>Delete</i> to add or delete a filter DHCP server entry. |
| Server Address | IP The IP address of the DHCP server that specifies an allotted server ipaddress to the client. |
| Client Address | MAC Specifies the MAC address of the client which allowed the requested IP address from the DHCP server. |
| PortList | Enter the list of ports to use the given filter DHCP server entry. |

Click **Apply** to implement the changes

DNS Relay

Computer users usually prefer to use text names for computers for which they may want to open a connection. Computers themselves, require 32 bit IP addresses. Somewhere, a database of network devices' text names and their corresponding IP addresses must be maintained.

The Domain Name System (DNS) is used to map names to IP addresses throughout the Internet and has been adapted for use within intranets.

For two DNS servers to communicate across different subnets, the **DNS Relay** of the Switch must be used. The DNS servers are identified by IP addresses.

Mapping Domain Names to Addresses

Name-to-address translation is performed by a program called a Name server. The client program is called a Name resolver. A Name resolver may need to contact several Name servers to translate a name to an address.

The Domain Name System (DNS) servers are organized in a somewhat hierarchical fashion. A single server often holds names for a single network, which is connected to a root DNS server - usually maintained by an ISP.

Domain Name Resolution

The domain name system can be used by contacting the name servers one at a time, or by asking the domain name system to do the complete name translation. The client makes a query containing the name, the type of answer required, and a code specifying whether the domain name system should do the entire name translation, or simply return the address of the next DNS server if the server receiving the query cannot resolve the name.

When a DNS server receives a query, it checks to see if the name is in its sub domain. If it is, the server translates the name and appends the answer to the query, and sends it back to the client. If the DNS server cannot translate the name, it determines what type of name resolution the client requested. A complete translation is called recursive resolution and requires the server to contact other DNS servers until the name is resolved. Iterative resolution specifies that if the DNS server cannot supply an answer, it returns the address of the next DNS server the client should contact.

Each client must be able to contact at least one DNS server, and each DNS server must be able to contact at least one root server.

The address of the machine that supplies domain name service is often supplied by a DHCP or BOOTP server, or can be entered manually and configured into the operating system at startup.

DNS Relay Global Settings

This window is used to configure the DNS function on the Switch.

To view the **DNS Relay Global Settings**, click **L3 Features > DNS Relay > DNS Relay Global Settings**, as shown below.

| DNS Relay Global Settings | |
|---------------------------|------------|
| DNS State | Disabled ▾ |
| Primary Name Server | 0.0.0.0 |
| Secondary Name Server | 0.0.0.0 |
| DNSR Cache State | Disabled ▾ |
| DNSR Static Table State | Disabled ▾ |
| Apply | |

Figure 8- 68. DNS Relay Global Settings window

The following fields can be set:

| Parameter | Description |
|----------------------------|--|
| DNS State | This field can be toggled between <i>Disabled</i> and <i>Enabled</i> using the pull-down menu, and is used to enable or disable the DNS Relay service on the Switch. |
| Primary Name Server | Allows the entry of the IP address of a primary domain name server (DNS). |

| | |
|--------------------------------|--|
| Secondary Name Server | Allows the entry of the IP address of a secondary domain name server (DNS). |
| DNSR Cache Status | This can be toggled between <i>Disabled</i> and <i>Enabled</i> . This determines if a DNS cache will be enabled on the Switch. |
| DNSR Static Table State | This field can be toggled using the pull-down menu between <i>Disabled</i> and <i>Enabled</i> . This determines if the static DNS table will be used or not. |

Click **Apply** to implement changes made.

DNS Relay Static Settings

This window is used to set the DNS Relay Static Settings on the Switch.

To view this window, click **L3 Features > DNS Relay > DNS Relay Static Settings**, as shown below.

Figure 8- 69. DNS Relay Static Settings window

To add an entry into the DNS Relay Static Table, simply enter a Domain Name with its corresponding IP address and click **Add** under the Apply heading. A successful entry will be presented in the table below, as shown in the example above. To erase an entry from the table, click its corresponding under the Delete heading.

VRRP

VRRP or Virtual Routing Redundancy Protocol is a function on the Switch that dynamically assigns responsibility for a virtual router to one of the VRRP routers on a LAN. The VRRP router that controls the IP address associated with a virtual router is called the Master, and will forward packets sent to this IP address. This will allow any Virtual Router IP address on the LAN to be used as the default first hop router by end hosts. Utilizing VRRP, the administrator can achieve a higher available default path cost without needing to configure every end host for dynamic routing or routing discovery protocols.

Statically configured default routes on the LAN are prone to a single point of failure. VRRP is designed to eliminate these failures by setting an election protocol that will assign a responsibility for a virtual router to one of the VRRP routers on the LAN. When a virtual router fails, the election protocol will select a virtual router with the highest priority to be the Master router on the LAN. This retains the link and the connection is kept alive, regardless of the point of failure.

To configure VRRP for virtual routers on the Switch, an IP interface must be present on the system and it must be a part of a VLAN. VRRP IP interfaces may be assigned to every VLAN, and therefore IP interface, on the Switch. VRRP routers within the same VRRP group must be consistent in configuration settings for this protocol to function optimally.

VRRP Global Settings

This window is used to enable VRRP globally on the Switch.

To view this window, click **L3 Features > VRRP > VRRP Global Settings**, as shown below.



Figure 8- 70. VRRP Global Settings window

The following fields can be set:

| Parameter | Description |
|--------------------------------|--|
| VRRP State | Use the pull-down menu to enable or disable VRRP globally on the Switch. The default is <i>Disabled</i> . |
| Non-owner response Ping | Enabling this parameter will allow the virtual IP address to be pinged from other host end nodes to verify connectivity. This will only enable the ping connectivity check function. This command is <i>Disabled</i> by default. |

Click **Apply** to implement changes made.

VRRP Virtual Router Settings

The following window will allow the user to view the parameters for the VRRP function on the Switch.



To view this window, click **L3 Features > VRRP > VRRP Virtual Router Settings**, as shown below.



Figure 8- 71. VRRP Virtual Router Settings window

The following fields are displayed in the window above:

| Parameter | Description |
|-------------------------|---|
| VRID / Interface | VRID - Displays the virtual router ID set by the user. This will uniquely identify the VRRP |

| | |
|-----------------------------|---|
| Name | Interface on the network. Interface Name - An IP interface name that has been enabled for VRRP. This entry must have been previously set in the IP Interfaces table. |
| Virtual IP Address | The IP address of the Virtual router configured on the Switch. |
| Master IP Address | Displays the IP address of the Master router for the VRRP function. |
| Virtual Router State | Displays the current state of the Virtual Router on the Switch. Possible states include Initialize, Master, and Backup. |
| State | Displays the VRRP state of the corresponding VRRP entry. |
| Display | Click the  button to display the settings for this particular VRRP entry. |
| Delete | Click the  to delete this VRRP entry. |

Click the **Add** button to display the following window to configure a VRRP interface.

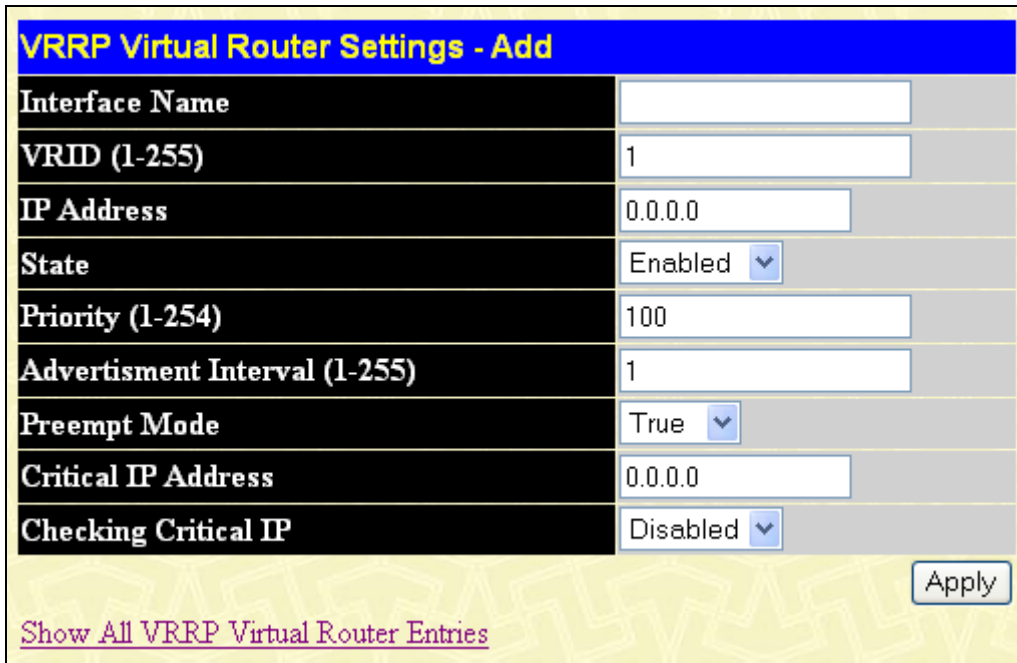

Figure 8- 72. VRRP Virtual Router Settings – Add window

Or, the user may click the hyperlinked Interface Name to view the same window:

The following parameters may be set to configure an existing or new VRRP interface.

| Parameter | Description |
|-----------------------|--|
| Interface Name | Enter the name of a previously configured IP interface for which to create a VRRP entry. This IP interface must be assigned to a VLAN on the Switch. |
| VRID (1-255) | Enter a value between 1 and 255 to uniquely identify this VRRP group on the Switch. All routers participating in this group must be assigned the same VRID value. This value MUST be different from other VRRP groups set on the Switch. |
| IP Address | Enter the IP address that will be assigned to the VRRP router. This IP address is also the default gateway that will be statically assigned to end hosts and must be set for all routers that participate in this group. |
| State | Used to enable and disable the VRRP IP interface on the Switch. |

| | |
|---------------------------------------|---|
| Priority (1-254) | Enter a value between 1 and 254 to indicate the router priority. The VRRP Priority value may determine if a higher priority VRRP router overrides a lower priority VRRP router. A higher priority will increase the probability that this router will become the Master router of the group. A lower priority will increase the probability that this router will become the backup router. VRRP routers that are assigned the same priority value will elect the highest physical IP address as the Master router. The default value is 100. (The value of 255 is reserved for the router that owns the IP address associated with the virtual router and is therefore set automatically.) |
| Advertisement Interval (1-255) | Enter a time interval value, in seconds, for sending VRRP message packets. This value must be consistent with all participating routers. The default is 1 second. |
| Preempt Mode | This entry will determine the behavior of backup routers within the VRRP group by controlling whether a higher priority backup router will preempt a lower priority Master router. A <i>True</i> entry, along with having the backup router's priority set higher than the masters priority, will set the backup router as the Master router. A <i>False</i> entry will disable the backup router from becoming the Master router. This setting must be consistent with all routers participating within the same VRRP group. The default setting is <i>True</i> . |
| Critical IP Address | Enter the IP address of the physical device that will provide the most direct route to the Internet or other critical network connections from this virtual router. This must be a real IP address of a real device on the network. If the connection from the virtual router to this IP address fails, the virtual router will automatically disabled. A new Master will be elected from the backup routers participating in the VRRP group. Different critical IP addresses may be assigned to different routers participating in the VRRP group, and can therefore define multiple routes to the Internet or other critical network connections. |
| Checking Critical IP | Use the pull-down menu to enable or disable the Critical IP address entered above. |

Click **Apply** to implement changes made.

To view the settings for a particular VRRP setting, click the corresponding [View](#) in the VRRP Interface Table of the entry, which will display the following:

| VRRP Virtual Router Settings - Display | |
|--|-------------------|
| Interface Name | Triton |
| Authentication type | No Authentication |
| VRID | 1 |
| Virtual IP Address | 11.1.1.1 |
| Virtual MAC Address | 00:00:5e:00:01:01 |
| Virtual Router State | Initialize |
| State | Enabled |
| Priority | 255 |
| Master IP Address | 11.1.1.1 |
| Critical IP Address | 0.0.0.0 |
| Checking Critical IP | Disabled |
| Advertisement Interval | 1 |
| Preempt Mode | True |
| Virtual Router Up Time | 0 |
| Show All VRRP Virtual Router Entries | |

Figure 8- 73. VRRP Virtual Router Settings - Display window

This window displays the following information:

| Parameter | Description |
|-------------------------------|---|
| Interface Name | An IP interface name that has been enabled for VRRP. This entry must have been previously set in the IP Interface Settings table. |
| Authentication type | Displays the type of authentication used to compare VRRP packets received by a virtual router. Possible authentication types include: <ul style="list-style-type: none"> No authentication - No authentication has been selected to compare VRRP packets received by a virtual router. Simple Text Password - A Simple password has been selected to compare VRRP packets received by a virtual router, for authentication. IP Authentication Header - An MD5 message digest algorithm has been selected to compare VRRP packets received by a virtual router, for authentication. |
| VRID | Displays the virtual router ID set by the user. This will uniquely identify the VRRP Interface on the network. |
| Virtual IP Address | The IP address of the Virtual router configured on the Switch. |
| Virtual MAC Address | The MAC address of the device that holds the Virtual router. |
| Virtual Router State | Displays the current status of the virtual router. Possible states include Initialize, Master and Backup. |
| State | Displays the current state of the router. |
| Priority | Displays the priority of the virtual router. A higher priority will increase the probability that this router will become the Master router of the group. A lower priority will increase the probability that this router will become the backup router. The lower the number, the higher the priority. |
| Master IP Address | Displays the IP address of the Master router for the VRRP function. |
| Critical IP Address | Displays the critical IP address of the VRRP function. This address will judge if a virtual router is qualified to be a master router. |
| Checking Critical IP | Displays the status of the Critical IP address. May be enabled or disabled. |
| Advertisement Interval | Displays the time interval, in seconds, which VRRP messages are sent out to the network. |
| Preempt Mode | Displays the mode for determining the behavior of backup routers set on this VRRP interface. True will denote that this will be the backup router, if the routers priority is set higher than the master router. False will disable the backup router from becoming the master router. |
| Virtual Router Up Time | Displays the time, in minutes, since the virtual router has been initialized |

To edit the settings for a particular VRRP setting, click **L3 Features > VRRP > VRRP Virtual Router Settings**, which will display the following window:

| VRRP Virtual Router Settings | | | | | | |
|------------------------------|--------------------|-------------------|----------------------|---------|----------------------|--------|
| VRID / Interface Name | Virtual IP Address | Master IP Address | Virtual Router State | State | Display | Delete |
| 1 / System | 10.24.22.200 | 10.24.22.200 | Master | Enabled | View | |

Figure 8- 74. VRRP Virtual Router Settings window

Click the hyperlink VRID / Interface Name that you want to edit to display the following window:

VRRP Virtual Router Settings - Edit

| | |
|--------------------------------|---|
| Interface Name | System |
| VRID (1-255) | 1 |
| IP Address | 10.24.22.200 |
| State | Enabled <input type="button" value="v"/> |
| Priority (1-254) | 255 |
| Advertisement Interval (1-255) | 1 |
| Preempt Mode | True <input type="button" value="v"/> |
| Critical IP Address | 0.0.0.0 |
| Checking Critical IP | Disabled <input type="button" value="v"/> |

[Show All VRRP Virtual Router Entries](#)

Figure 8- 75. VRRP Virtual Router Settings window

This window displays the following information:

| Parameter | Description |
|---------------------------------------|---|
| Interface Name | Enter the name of a previously configured IP interface for which to create a VRRP entry. This IP interface must be assigned to a VLAN on the Switch. |
| VRID (1-255) | Enter a value between 1 and 255 to uniquely identify this VRRP group on the Switch. All routers participating in this group must be assigned the same VRID value. This value MUST be different from other VRRP groups set on the Switch. |
| IP Address | Enter the IP address that will be assigned to the VRRP router. This IP address is also the default gateway that will be statically assigned to end hosts and must be set for all routers that participate in this group. |
| State | Used to enable and disable the VRRP IP interface on the Switch. |
| Priority (1-254) | Enter a value between 1 and 254 to indicate the router priority. The VRRP Priority value may determine if a higher priority VRRP router overrides a lower priority VRRP router. A higher priority will increase the probability that this router will become the Master router of the group. A lower priority will increase the probability that this router will become the backup router. VRRP routers that are assigned the same priority value will elect the highest physical IP address as the Master router. The default value is 100. (The value of 255 is reserved for the router that owns the IP address associated with the virtual router and is therefore set automatically.) |
| Advertisement Interval (1-255) | Enter a time interval value, in seconds, for sending VRRP message packets. This value must be consistent with all participating routers. The default is 1 second. |

| | |
|-----------------------------|---|
| Preempt Mode | This entry will determine the behavior of backup routers within the VRRP group by controlling whether a higher priority backup router will preempt a lower priority Master router. A <i>True</i> entry, along with having the backup router's priority set higher than the masters priority, will set the backup router as the Master router. A <i>False</i> entry will disable the backup router from becoming the Master router. This setting must be consistent with all routers participating within the same VRRP group. The default setting is <i>True</i> . |
| Critical IP Address | Enter the IP address of the physical device that will provide the most direct route to the Internet or other critical network connections from this virtual router. This must be a real IP address of a real device on the network. If the connection from the virtual router to this IP address fails, the virtual router will automatically disabled. A new Master will be elected from the backup routers participating in the VRRP group. Different critical IP addresses may be assigned to different routers participating in the VRRP group, and can therefore define multiple routes to the Internet or other critical network connections. |
| Checking Critical IP | Use the pull-down menu to enable or disable the Critical IP address entered above. |

Click **Apply** to implement changes made.

VRRP Authentication Settings

This window is used to set the authentication for each Interface configured for VRRP. This authentication is used to identify incoming message packets received by a router. If the authentication is not consistent with incoming packets, they will be discarded. The Authentication Type must be consistent with all routers participating within the VRRP group.

To view the following window, click **L3 Features > VRRP > VRRP Authentication Settings**, as shown below.

| VRRP Authentication Settings | |
|------------------------------|---------------------|
| Interface Name | Authentication Type |
| System | No Authentication |

Figure 8- 76. VRRP Authentication Settings window

To configure the authentication for a pre-created interface, click its hyperlinked name, revealing the following window to configure:

| VRRP Authentication Settings - Edit | |
|---|---------------------------------------|
| Interface Name | System |
| Authentication Type | None <input type="button" value="v"/> |
| Authentication Data | <input type="text"/> |
| <input type="button" value="Apply"/> | |
| Show All VRRP Interface Entries | |

Figure 8- 77. VRRP Authentication Settings – Edit window

The following parameters may be viewed or configured:

| Parameter | Description |
|----------------------------|--|
| Interface Name | The name of a previously created IP interface for which to configure the VRRP authentication. |
| Authentication Type | Specifies the type of authentication used. The Authentication Type must be consistent with all routers participating within the VRRP group. The choices are: <ul style="list-style-type: none"> <i>None</i> - Selecting this parameter indicates that VRRP protocol exchanges will not be authenticated. <i>Simple</i> - Selecting this parameter will require the user to set a simple password in the Auth. Data field for comparing VRRP message packets received by a router. If the two passwords are not exactly the same, the packet will be dropped. <i>IP</i> - Selecting this parameter will require the user to set a MD5 message digest for authentication in comparing VRRP messages received by the router. If the two values are inconsistent, the packet will be dropped. |
| Authentication Data | This field is only valid if the user selects <i>Simple</i> or <i>IP</i> in the Authentication Type drop-down menu. <ul style="list-style-type: none"> <i>Simple</i> will require the user to enter an alphanumeric string of no more than eight characters to identify VRRP packets received by a router. <i>IP</i> will require the user to enter a MD5 message digest for authentication in comparing VRRP messages received by the router. <p>This entry must be consistent with all routers participating in the same IP interface.</p> |

Click **Apply** to implement changes made.

IP Multicast Routing Protocol

The functions supporting IP multicasting are found in **L3 Features > IP Multicast Routing Protocol**. IGMP, DVMRP, and PIM-DM/SM/SM-DM can be enabled or disabled on the Switch without changing the individual protocol’s configuration by using the **DGS-3600 Web Management Tool**.

IGMP

Computers and network devices that want to receive multicast transmissions need to inform nearby routers that they will become members of a multicast group. The Internet Group Management Protocol (IGMP) is used to communicate this information. IGMP is also used to periodically check the multicast group for members that are no longer active.

In the case where there is more than one multicast router on a subnetwork, one router is elected as the ‘querier’. This router then keeps track of the membership of the multicast groups that have active members. The information received from IGMP is then used to determine if multicast packets should be forwarded to a given subnetwork or not. The router can check, using IGMP, to see if there is at least one member of a multicast group on a given subnetwork. If there are no members on a subnetwork, packets will not be forwarded to that subnetwork.

IGMP Versions 1 and 2

Multicast groups allow members to join or leave at any time. IGMP provides the method for members and multicast routers to communicate when joining or leaving a multicast group.

IGMP version 1 is defined in RFC 1112. It has a fixed packet size and no optional data.

The format of an IGMP packet is shown below:

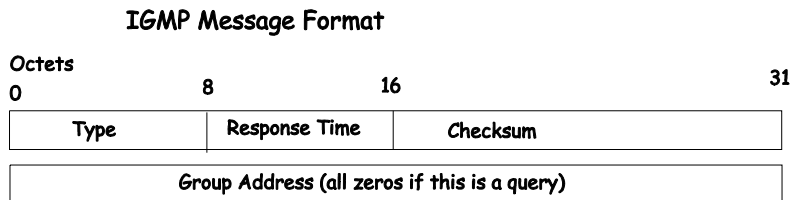

Figure 8- 78. IGMP Message Format

The IGMP Type codes are shown below:

| Type | Meaning |
|------|---|
| 0x11 | Membership Query (if Group Address is 0.0.0.0) |
| 0x11 | Specific Group Membership Query (if Group Address is Present) |
| 0x16 | Membership Report (version 2) |
| 0x17 | Leave a Group (version 2) |
| 0x12 | Membership Report (version 1) |

Table 8- 1. IGMP Type Codes

IGMP packets enable multicast routers to keep track of the membership of multicast groups, on their respective subnetworks. The following outlines what is communicated between a multicast router and a multicast group member using IGMP.

A host sends an IGMP “report” to join a group

A host will never send a report when it wants to leave a group (for version 1).

A host will send a “leave” report when it wants to leave a group (for version 2).

Multicast routers send IGMP queries (to the all-hosts group address: 224.0.0.1) periodically to see whether any group members exist on their subnetworks. If there is no response from a particular group, the router assumes that there are no group members on the network.

The Time-to-Live (TTL) field of query messages is set to 1 so that the queries will not be forwarded to other subnetworks.

IGMP version 2 introduces some enhancements such as a method to elect a multicast querier for each LAN, an explicit leave message, and query messages that are specific to a given group.

The states a computer will go through to join or to leave a multicast group are shown below:

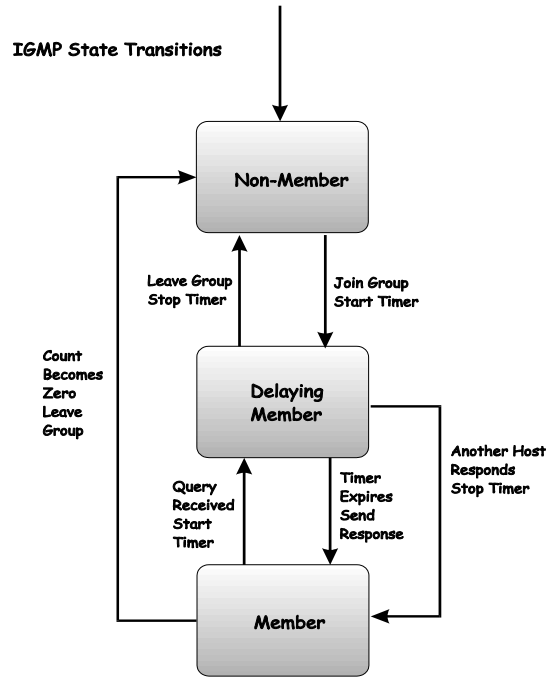

Figure 8- 79. IGMP State Transitions

IGMP Version 3

The current release of the Switch now implements IGMPv3. Improvements of IGMPv3 over version 2 include:

- The introduction of the SSM or Source Specific Multicast. In previous versions of IGMP, the host would receive all packets sent to the multicast group. Now, a host will receive packets only from a specific source or sources. This is done through the implementation of include and exclude filters used to accept or deny traffic from these specific sources.
- In IGMP v2, Membership reports could contain only one multicast group whereas in v3, these reports can contain multiple multicast groups and multiple sources within the multicast group.
- Leaving a multicast group could only be accomplished using a specific leave message in v2. In v3, leaving a multicast group is done through a Membership report, which includes a block message in the group report packet.
- For version 2, the host could respond to a group query but in version 3, the host is now capable to answer queries specific to the group and the source.

IGMP v3 is backwards compatible with other versions of IGMP.

The IGMPv3 Type supported codes are shown below:

| Type | Meaning |
|------|-----------------------------|
| 0x11 | Membership Query |
| 0x12 | Version 1 Membership Report |
| 0x16 | Version 2 Membership Report |
| 0x17 | Version 2 Leave Group |
| 0x22 | IGMPv3 Membership Report |

Timers

As previously mentioned, IGMPv3 incorporates filters to include or exclude sources. These filters are kept updated using timers. IGMPv3 utilizes two types of timers, one for the group and one for the source. The purpose of the filter mode is to reduce the reception state of a multicast group so that all members of the multicast group are satisfied. This filter mode is dependant on membership reports and timers of the multicast group. These filters are used to maintain a list of multicast sources and groups of multicast receivers that more accurately reflect the actual sources and receiving groups at any one time on the network.

Source timers are used to keep sources present and active within a multicast group on the Switch. These source timers are refreshed if a group report packet is received by the Switch, which holds information pertaining to the active source group record part of a report packet. If the filter mode is exclude, traffic is being denied from at least one specific source, yet other hosts may be accepting traffic from the multicast group. If the group timer expires for the multicast group, the filter mode is changed to include and other hosts can receive traffic from the source. If no group report packet is received and the filter mode is include, the Switch presumes that traffic from the source is no longer wanted on the attached network and the source record list is then deleted after all source timers expire. If there is no source list record in the multicast group, the multicast group will be deleted from the Switch.

Timers are also used for IGMP version 1 and 2 members, which are a part of a multicast group when the Switch is running IGMPv3. This timer is based on a host within the multicast group that is running IGMPv1 or v2. Receiving a group report from an IGMPv1 or v2 host within the multicast group will refresh the timer and keep the v1 and/or v2 membership alive in v3.



NOTE: The length of time for all timers utilized in IGMPv3 can be determined using IGMP configurations to perform the following calculation:

$$(\text{Query Interval} \times \text{Robustness Variable}) + \text{One Query Response Interval}$$

IGMP Interface Settings

The Internet Group Management Protocol (IGMP) can be configured on the Switch on a per-IP interface basis. Each IP interface configured on the Switch is displayed in the below **IGMP Interface Settings** window. To configure IGMP for a particular interface, click the corresponding hyperlink for that IP interface.

To view this Table, click **L3 Features > IP Multicast Routing Protocol > IGMP Interface Settings**, as shown below.

| Total Entries: 1 | | | | | | | |
|-------------------------|-------------|---------|----------------|-------------------|---------------------|----------------------------|----------|
| IGMP Interface Settings | | | | | | | |
| Interface Name | IP Address | Version | Query Interval | Max Response Time | Robustness Variable | Last Member Query Interval | State |
| System | 10.73.21.33 | 3 | 125 | 10 | 2 | 1 | Disabled |

Figure 8- 80. IGMP Interface Settings window

| IGMP Interface Settings - Edit | |
|---|-------------|
| Interface Name | System |
| IP Address | 10.73.21.33 |
| Version | 3 ▾ |
| Query Interval (1- 31744) | 125 |
| Max Response Time (1-25) | 10 |
| Robustness Variable (1-255) | 2 |
| Last Member Query Interval (1-25) | 1 |
| State | Disabled ▾ |
| <input type="button" value="Apply"/> | |
| Show All IGMP Interface Entries | |

Figure 8- 81. IGMP Interface Settings – Edit window

This window allows the configuration of IGMP for each IP interface configured on the Switch. IGMP can be configured as Version 1, 2 or 3 by toggling the Version field using the pull-down menu. The length of time between queries can be varied by entering a value between 1 and 31,744 seconds in the Query Interval field. The maximum length of time between the receipt of a query and the sending of an IGMP response report can be varied by entering a value in the Max Response Time field.

The Robustness Variable field allows IGMP to be 'tuned' for sub-networks that are expected to lose many packets. A high value (max. 255) for the robustness variable will help compensate for 'lossy' sub-networks. A low value (min. 2) should be used for less 'lossy' sub-networks.

The following fields can be set:

| Parameter | Description |
|--|---|
| Interface Name | Displays the name of the IP interface that is to be configured for IGMP. This must be a previously configured IP interface. |
| IP Address | Displays the IP address corresponding to the IP interface name above. |
| Version | Enter the IGMP version (1, 2 or 3) that will be used to interpret IGMP queries on the interface. |
| Query Interval (1-31744) | Allows the entry of a value between 1 and 31744 seconds, with a default of 125 seconds. This specifies the length of time between sending IGMP queries. |
| Max Response Time (1-25) | Sets the maximum amount of time allowed before sending an IGMP response report. A value between 1 and 25 seconds can be entered, with a default of 10 seconds. |
| Robustness Variable (1-255) | A tuning variable to allow for subnetworks that are expected to lose a large number of packets. A value between 1 and 255 can be entered, with larger values being specified for subnetworks that are expected to lose larger numbers of packets. The default setting is 2. |
| Last Member Query Interval (1-25) | Specifies the maximum amount of time between group-specific query messages, including those sent in response to leave group messages. A value between 1 and 25. The default is 1 second. |
| State | This field can be toggled between <i>Enabled</i> and <i>Disabled</i> and enables or disables IGMP for the IP interface. The default is <i>Disabled</i> . |

Click **Apply** to implement changes made.

DVMRP Interface Configuration

The Distance Vector Multicast Routing Protocol (DVMRP) is a hop-based method of building multicast delivery trees from multicast sources to all nodes of a network. Because the delivery trees are ‘pruned’ and ‘shortest path’, DVMRP is relatively efficient. Because multicast group membership information is forwarded by a distance-vector algorithm, propagation is slow. DVMRP is optimized for high delay (high latency) relatively low bandwidth networks, and can be considered as a ‘best-effort’ multicasting protocol.

DVMRP resembles the Routing Information Protocol (RIP), but is extended for multicast delivery. DVMRP builds a routing table to calculate ‘shortest paths’ back to the source of a multicast message, but defines a ‘route cost’ (similar to the hop count in RIP) as a relative number that represents the real cost of using this route in the construction of a multicast delivery tree to be ‘pruned’ - once the delivery tree has been established.

When a sender initiates a multicast, DVMRP initially assumes that all users on the network will want to receive the multicast message. When an adjacent router receives the message, it checks its routing table to determine the interface that gives the shortest path (lowest cost) back to the source. If the multicast was received over the shortest path, then the adjacent router enters the information into its tables and forwards the message. If the message is not received on the shortest path back to the source, the message is dropped.

Route cost is a relative number that is used by DVMRP to calculate which branches of a multicast delivery tree should be ‘pruned’. The ‘cost’ is relative to other costs assigned to other DVMRP routes throughout the network.

The higher the route cost, the lower the probability that the current route will be chosen to be an active branch of the multicast delivery tree (not ‘pruned’) - if there is an alternative route.

DVMRP Global Settings

This window is used to enable DVMRP globally on the Switch.

To view this window, click **L3 Features > IP Multicast Routing Protocol > DVMRP Global Settings**, as shown below.



Figure 8- 82. DVMRP Global Settings window

Use the pull-down menu, choose *Enabled*, and click **Apply** to implement the DVMRP function on the Switch.

DVMRP Interface Settings

This window allows the Distance-Vector Multicast Routing Protocol (DVMRP) to be configured for each IP interface defined on the Switch. Each IP interface configured on the Switch is displayed in the below **DVMRP Interface Settings** window. To configure DVMRP for a particular interface, click the corresponding hyperlink for that IP interface.

To view this Table, click **L3 Features > IP Multicast Routing Protocol > DVMRP Interface Settings**, as shown below.

| Total Entries:1 | | | | | |
|--------------------------|-------------|------------------|-------|--------|----------|
| DVMRP Interface Settings | | | | | |
| Interface Name | IP Address | Neighbor Timeout | Probe | Metric | State |
| System | 10.73.21.33 | 35 | 10 | 1 | Disabled |

Figure 8- 83. DVMRP Interface Settings window

| DVMRP Interface Settings - Edit | |
|--|---|
| Interface Name | System |
| IP Address | 10.73.21.33 |
| Neighbor Timeout (1-65535 sec) | 35 |
| Probe Interval (1-65535 sec) | 10 |
| Metric (1-31) | 1 |
| State | Disabled <input type="button" value="v"/> |
| <input type="button" value="Apply"/> | |
| Show All DVMRP Interface Entries | |

Figure 8- 84. DVMRP Interface Settings - Edit window

The following fields can be set:

| Parameter | Description |
|---------------------------------------|---|
| Interface Name | Displays the name of the IP interface for which DVMRP is to be configured. This must be a previously defined IP interface. |
| IP Address | Displays the IP address corresponding to the IP Interface name entered above. |
| Neighbor Timeout (1-65535 sec) | This field allows an entry between 1 and 65,535 seconds and defines the time period DVMRP will hold Neighbor Router reports before issuing poison route messages. The default is 35 seconds. |
| Probe Interval (1-65535 sec) | This field allows an entry between 1 and 65,535 seconds and defines the interval between 'probes'. The default is 10 seconds. |
| Metric (1-31) | This field allows an entry between 1 and 31 and defines the route cost for the IP interface. The DVMRP route cost is a relative number that represents the real cost of using this route in the construction of a multicast delivery tree. It is similar to, but not defined as, the hop count in RIP. The default cost is 1. |
| State | This field can be toggled between <i>Enabled</i> and <i>Disabled</i> and enables or disables DVMRP for the IP interface. The default is <i>Disabled</i> . |

Click **Apply** to implement changes made. Click [Show All DVMRP Interface Entries](#) to return to the **DVMRP Interface Settings** window.

PIM

PIM or Protocol Independent Multicast is a method of forwarding traffic to multicast groups over the network using any pre-existing unicast routing protocol, such as RIP or OSPF, set on routers within a multicast network. The Switch supports three types of PIM, Dense Mode (PIM-DM), Sparse Mode (PIM-SM), and Sparse-Dense Mode (PIM-DM-SM).

PIM-SM

PIM-SM or Protocol Independent Multicast – Sparse Mode is a method of forwarding multicast traffic over the network only to multicast routers who actually request this information. Unlike most multicast routing protocols which flood the network with multicast packets, PIM-SM will forward traffic to routers who are explicitly a part of the multicast group through the use of a Rendezvous Point (RP). This RP will take all requests from PIM-SM enabled routers, analyze the information and then returns multicast information it receives from the source, to requesting routers within its configured network. Through this method, a distribution tree is created, with the RP as the root. This distribution tree holds all PIM-SM enabled routers within which information collected from these routers are stored by the RP.

Two other types of routers also exist with the PIM-SM configuration. When many routers are a part of a multiple access network, a Designated Router (DR) will be elected. The DR's primary function is to send Join/Prune messages to the RP. The router with the highest priority on the LAN will be selected as the DR. If there is a tie for the highest priority, the router with the higher IP address will be chosen.

The third type of router created in the PIM-SM configuration is the Boot Strap Router (BSR). The goal of the Boot Strap Router is to collect and relay RP information to PIM-SM enabled routers on the LAN. Although the RP can be statically set, the BSR

mechanism can also determine the RP. Multiple Candidate BSRs (C-BSR) can be set on the network but only one BSR will be elected to process RP information. If it is not explicitly apparent which C-BSR is to be the BSR, all C-BSRs will emit Boot Strap Messages (BSM) out on the PIM-SM enabled network to determine which C-BSR has the higher priority and once determined, will be elected as the BSR. Once determined, the BSR will collect RP data emanating from candidate RPs on the PIM-SM network, compile it and then send it out on the LAN using periodic Boot Strap Messages (BSM). All PIM-SM Routers will get the RP information from the Boot Strap Mechanism and then store it in their database.

Discovering and Joining the Multicast Group

Although Hello packets discover PIM-SM routers, these routers can only join or be “pruned” from a multicast group through the use of Join/Prune Messages exchanged between the DR and RP. Join/Prune Messages are packets relayed between routers that effectively state which interfaces are, or are not to be receiving multicast data. These messages can be configured for their frequency to be sent out on the network and are only valid to routers if a Hello packet has first been received. A Hello packet will simply state that the router is present and ready to become a part of the RP’s distribution tree. Once a router has accepted a member of the IGMP group and it is PIM-SM enabled, the interested router will then send an explicit Join/Prune message to the RP, which will in turn route multicast data from the source to the interested router, resulting in a unidirectional distribution tree for the group. Multicast packets are then sent out to all nodes on this tree. Once a prune message has been received for a router that is a member of the RP’s distribution tree, the router will drop the interface from its distribution tree.

Distribution Trees

Two types of distribution trees can exist within the PIM-SM protocol, a Rendezvous-Point Tree (RPT) and a Shortest Path Tree (SPT). The RP will send out specific multicast data that it receives from the source to all outgoing interfaces enabled to receive multicast data. Yet, once a router has determined the location of its source, an SPT can be created, eliminating hops between the source and the destination, such as the RP. This can be configured by the switch administrator by setting the multicast data rate threshold. Once the threshold has been passed, the data path will switch to the SPT. Therefore, a closer link can be created between the source and destination, eliminating hops previously used and shortening the time a multicast packet is sent from the source to its final destination.

Register and Register Suppression Messages

Multicast sources do not always join the intended receiver group. The first hop router (DR) can send multicast data without being the member of a group or having a designated source, which essentially means it has no information about how to relay this information to the RP distribution tree. This problem is alleviated through Register and Register-Stop messages. The first multicast packet received by the DR is encapsulated and sent on to the RP, which in turn removes the encapsulation and sends the packet on down the RP distribution tree. When the route has been established, a SPT can be created to directly connect routers to the source, or the multicast traffic flow can begin, traveling from the DR to the RP. When the latter occurs, the same packet may be sent twice, one type encapsulated, one not. The RP will detect this flaw and then return a Register Suppression message to the DR requesting it to discontinue sending encapsulated packets.

Assert Messages

At times on the PIM-SM enabled network, parallel paths are created from source to receiver, meaning some receivers will receive the same multicast packets twice. To improve this situation, Assert messages are sent from the receiving device to both multicast sources to determine which single router will send the receiver the necessary multicast data. The source with the shortest metric (hop count) will be elected as the primary multicast source. This metric value is included within the Assert message.

PIM-DM

The Protocol Independent Multicast - Dense Mode (PIM-DM) protocol should be used in networks with a low delay (low latency) and high bandwidth as PIM-DM is optimized to guarantee delivery of multicast packets, not to reduce overhead.

The PIM-DM multicast routing protocol assumes that all downstream routers want to receive multicast messages and relies upon explicit prune messages from downstream routers to remove branches from the multicast delivery tree that do not contain multicast group members.

PIM-DM has no explicit ‘join’ messages. It relies upon periodic flooding of multicast messages to all interfaces and then either waiting for a timer to expire (the Join/Prune Interval) or for the downstream routers to transmit explicit ‘prune’ messages indicating that there are no multicast members on their respective branches. PIM-DM then removes these branches (‘prunes’ them) from the multicast delivery tree.

Because a member of a pruned branch of a multicast delivery tree may want to join a multicast delivery group (at some point in the future), the protocol periodically removes the ‘prune’ information from its database and floods multicast messages to all interfaces on that branch. The interval for removing ‘prune’ information is the Join/Prune Interval.

PIM-SM-DM

In the PIM-SM, RP is a key point for the first hop of the sender. If the first hop does not have RP information when the sender sends data out, it will drop the packet and do nothing. Sparse-Dense mode will be useful in this condition. In Sparse-Dense mode, the packets can be flooded to all the outgoing interfaces and pruning/joining (prune/graft) can be used to control the outgoing

interface list if RP is not found. In other words, the PIM Sparse-Dense mode is treated in either the sparse mode or dense mode of the operation; it depends on which mode the multicast group operates. When an interface receives multicast traffic, if there is a known RP for the group, then the current operation mode on the interface is sparse mode, otherwise the current operation mode on the interface will be dense mode.

PIM Global Settings

This window is used to enable PIM globally on the Switch.

To view this window, click **L3 Features > IP Multicast Routing Protocol > PIM > PIM Global Settings**, as shown below.

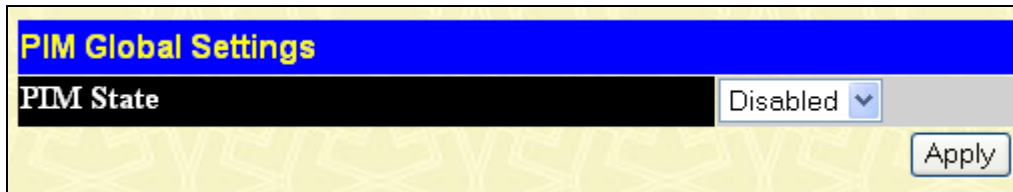

Figure 8- 85. PIM Global Settings window

Use the pull-down menu, choose *Enabled*, and click **Apply** to set the PIM function on the Switch.

PIM Parameter Settings

The following window will configure the parameter settings for the PIM distribution tree.

To view this window, click **L3 Features > IP Multicast Routing Protocol > PIM > PIM Parameter Settings**, as shown below.

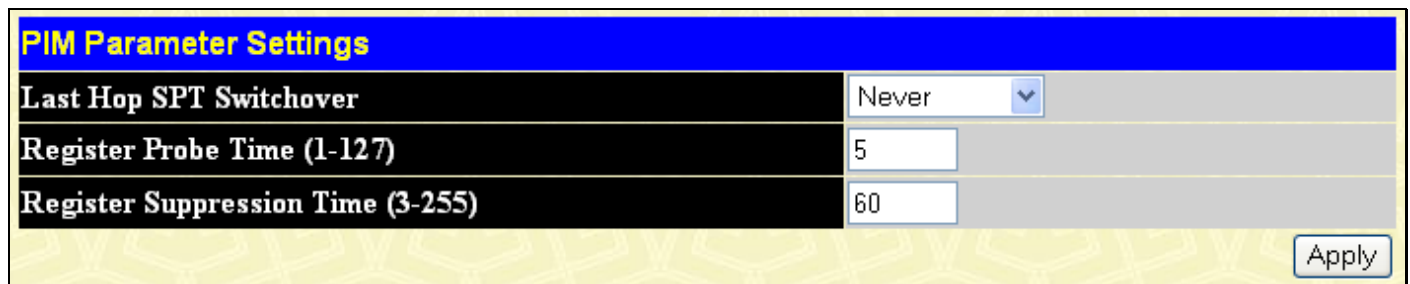

Figure 8- 86. PIM Parameter Settings window

The following fields can be viewed or set:

| Parameter | Description |
|--|--|
| Last Hop SPT Switchover | This field is used by the last hop router to decide whether to receive multicast data from the shared tree or switch over to the shortest path tree. When the switchover mode is set to never, the last hope router will always receive multicast data from the shared tree. When the mode is set to immediately, the last hop router will always receive data from the shortest path tree. |
| Register Probe Time (1-127) | This command is used to set a time to send a probe message from the DR to the RP before the Register Suppression time expires. If a Register Stop message is received by the DR, the Register Suppression Time will be restarted. If no Register Stop message is received within the probe time, Register Packets will be resent to the RP. The user may configure a time between 1 and 127 seconds with a default setting of 5 seconds. |
| Register Suppression Time (3-255) | This field is to be configured for the first hop router from the source. After this router sends out a Register message to the RP, and the RP replies with a Register stop message, it will wait for the time configured here to send out another register message to the RP. The user may set a time between 3 and 255 with a default setting of 60 seconds. |

Click **Apply** to implement changes made.



NOTE: The Probe time value must be less than half of the Register Suppression Time value. If not, the administrator will be presented with an error message after clicking **Apply**.

PIM Interface Settings

This window is used to configure the settings for the PIM Protocol per IP interface.

To view this window, click **L3 Features > IP Multicast Routing Protocol > PIM > PIM Interface Settings**, as shown below.

| Total Entries: 1 | | | | | | | | |
|------------------------|-------------|-------------------|----------------|---------------------|------|----------|-------------|---------------------------------------|
| PIM Interface Settings | | | | | | | | |
| Interface | IP Address | Designated Router | Hello Interval | Join/Prune Interval | Mode | State | DR Priority | Modify |
| System | 10.73.21.33 | 10.73.21.33 | 30 | 60 | DM | Disabled | 1 | <input type="button" value="Modify"/> |

Figure 8- 87. PIM Interface Settings window

To configure an IP interface for PIM, click its corresponding **Modify** button, which will lead you to the following window:

| PIM Interface Settings - Edit | |
|--|---|
| Interface Name | System |
| IP Address | 10.73.21.33 |
| Designated Router | 10.73.21.33 |
| Hello Interval (1-18724 sec) | <input type="text" value="30"/> |
| Join/Prune Interval (1-18724 sec) | <input type="text" value="60"/> |
| Dr Priority (0-4294967294) | <input type="text" value="1"/> |
| Mode | DM <input type="button" value="v"/> |
| State | Disabled <input type="button" value="v"/> |
| <input type="button" value="Apply"/> | |
| Show All PIM Interface Entries | |

Figure 8- 88. PIM Interface Settings – Edit window

The following fields can be set:

| Parameter | Description |
|-------------------------------------|--|
| Interface Name | This read-only field denotes the IP interface selected to be configured for PIM. |
| IP Address | This read-only field denotes the IP address of the IP interface selected to be configured for PIM. |
| Designated Router | This read-only field denotes the IP address of the Designated Router of the distribution tree to which this IP address belongs. |
| Hello Interval (1-18724 sec) | This field will set the interval time between the sending of Hello Packets from this IP interface to neighboring routers one hop away. These Hello packets are used to discover other PIM enabled routers and state their priority as the Designated Router (DR) on the PIM enabled network. The user may state an interval time between 1 and 18724 seconds with a default interval time of 30 seconds. |

| | |
|--|---|
| Join/Prune Interval (1-18724 sec) | This field will set the interval time between the sending of Join/Prune packets stating which multicast groups are to join the PIM enabled network and which are to be removed or “pruned” from that group. The user may state an interval time between 1 and 18724 seconds with a default interval time of 60 seconds. |
| DR Priority (0-4294967294) | Enter the priority of this IP interface to become the Designated Router for the multiple access network. The user may enter a DR priority between 0 and 4,294,967,294 with a default setting of 1. |
| Mode | Use the pull-down menu to select the type of PIM protocol to use, Sparse Mode (SM), Dense Mode (DM), or Sparse-Dense Mode (SM-DM). The default setting is DM. |
| State | Use the pull-down menu to enable or disable PIM for this IP interface. The default is Disabled. |

Click **Apply** to implement changes made.

PIM Candidate BSR Settings

The following windows are used to configure the Candidate Boot Strap Router settings for the switch and the priority of the selected IP interface to become the Boot Strap Router (BSR) for the PIM enabled network. The Boot Strap Router holds the information which determines which router on the network is to be elected as the RP for the multicast group and then to gather and distribute RP information to other PIM-SM enabled routers.

To view this window, click **L3 Features > IP Multicast Routing Protocol > PIM > PIM Candidate BSR Settings**, as shown below.

Figure 8- 89. PIM Candidate BSR Settings window

The following fields can be set:

| Parameter | Description |
|---|--|
| Candidate BSR Hash Mask Len (0-32) | Enter a hash mask length, which will be used with the IP address of the candidate RP and the multicast group address, to calculate the hash algorithm used by the router to determine which C-RP on the PIM-SM enabled network will be the RP. The user may select a length between 0 and 32 with a default setting of 30. |
| Candidate BSR Bootstrap Period (1-255) | Enter a time period between 1 and 255 to determine the interval the Switch will send out Boot Strap Messages (BSM) to the PIM enabled network. The default setting is 60 seconds. |
| Interface Name | To find an IP interface on the Switch, enter the interface name into the space provided and click Search . If found, the Interface Name will appear alone in the PIM Candidate BSR Settings window below. |

To view the C-BSR settings for an IP interface and set its BSR priority, click its corresponding **Modify** button, which will lead you to the following window.

Figure 8- 90. PIM Candidate BSR Settings – Edit window

The following fields can be viewed or set:

| Parameter | Description |
|-------------------------------|---|
| Interface Name | This read-only field denotes the IP Interface Name to be edited for its C-BSR priority. |
| IP Address | Denotes the IP Address of the IP Interface Name to be edited for its C-BSR priority. |
| Priority (-1 or 0-255) | Used to state the Priority of this IP Interface to become the BSR. The user may select a priority between -1 and 0 to 255. An entry of -1 states that the interface will be disabled to be the BSR. |

Click **Apply** to set the priority for this IP Interface.

PIM Candidate RP Settings

The following window is used to set the Parameters for this Switch to become a candidate RP.

To view this window, click **L3 Features > IP Multicast Routing Protocol > PIM > PIM Candidate RP Settings**, as shown below.

Figure 8- 91. PIM Candidate RP Settings window

The following fields can be viewed or set:

| Parameter | Description |
|---------------------------------------|--|
| Candidate RP Hold Time (0-255) | This field is used to set the time Candidate RP (CRP) advertisements are valid on the PIM-SM enabled network. If CRP advertisements are not received by the BSR within this time frame, the CRP is removed from the list of candidates. The user may set a time between 0 and 255 seconds with a default setting of 150 seconds. An entry of 0 will send out one |

| | |
|---|---|
| | advertisement that states to the BSR that it should be immediately removed from CRP status on the PIM-SM network. |
| Candidate RP Priority (0-255) | Enter a priority value to determine which CRP will become the RP for the distribution tree. This priority value will be included in the router's CRP advertisements. A lower value means a higher priority, yet, if there is a tie for the highest priority, the router having the higher IP address will become the RP. The user may set a priority between 0 and 255 with a default setting of 192. |
| Candidate RP Wildcard Prefix Count | The user may set the Prefix Count value of the wildcard group address here by choosing a value between 0 and 1 with a default setting of 0. |

Click **Apply** to implement changes made.

To add a PIM Candidate RP, click the **Add** button in the previous window, which will display the following window for the user to configure.

Figure 8- 92. PIM Candidate RP Settings – Add window

The following fields can be set:

| Parameter | Description |
|--------------------|--|
| IP Address | Enter the IP address of the device to be added as a Candidate RP. |
| Subnet Mask | Enter the corresponding subnet mask of the device to be added as a Candidate RP. |
| Interface | Enter the IP interface where this device is located. |

Click **Apply** to add the device as a Candidate RP.

PIM Static RP Settings

The following window will display the parameters for the switch to become a static RP.

To view this window, click **L3 Features > IP Multicast Routing Protocol > PIM > PIM Static RP Settings**, as shown below.

Figure 8- 93. PIM Static RP Settings window

The following fields can be viewed or set:

| Parameter | Description |
|----------------------|---|
| Group Address | Enter the multicast group address for this Static RP. This address must be a class D address. |
| Group Mask | Enter the mask for the multicast group address stated above. |
| RP Address | Enter the IP address of the rendezvous Point. |

Click **Apply** to implement changes made.

PIM Register Checksum Settings

This window is used to configure RP addresses. The data part is included when calculating the checksum for a PIM register message to the RP on the first hop router.

To view this window, click **L3 Features > IP Multicast Routing Protocol > PIM > PIM Register Checksum Settings**, as shown below.

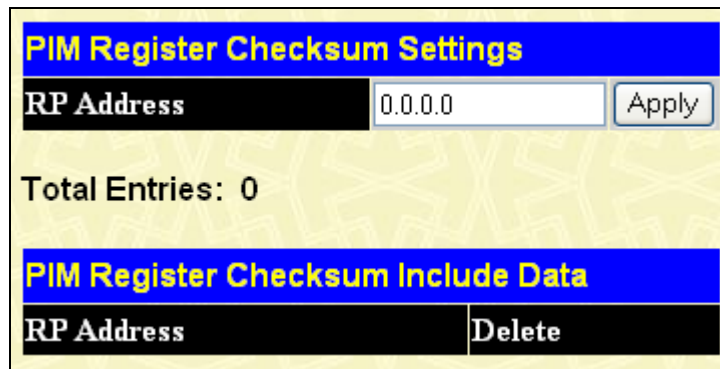

Figure 8- 94. PIM Register Checksum Settings window

The following fields can be set:

| Parameter | Description |
|-------------------|--|
| RP Address | Enter the IP address of the RP for which the data part will be included when calculating checksum for registering packets to the RP. |

Click **Apply** to add the RP into the checksum including the data list.

Section 9

QoS

Bandwidth Control

QoS Scheduling Mechanism

QoS Output Scheduling

802.1p Default Priority

802.1p User Priority

The Switch supports 802.1p priority queuing Quality of Service. The following section discusses the implementation of QoS (Quality of Service) and benefits of using 802.1p priority queuing.

Advantages of QoS

QoS is an implementation of the IEEE 802.1p standard that allows network administrators a method of reserving bandwidth for important functions that require a large bandwidth or have a high priority, such as VoIP (voice-over Internet Protocol), web browsing applications, file server applications or video conferencing. Not only can a larger bandwidth be created, but other less critical traffic can be limited, so excessive bandwidth can be saved. The Switch has separate hardware queues on every physical port to which packets from various applications can be mapped to, and, in turn prioritized. View the following map to see how the Switch implements 802.1p priority queuing.

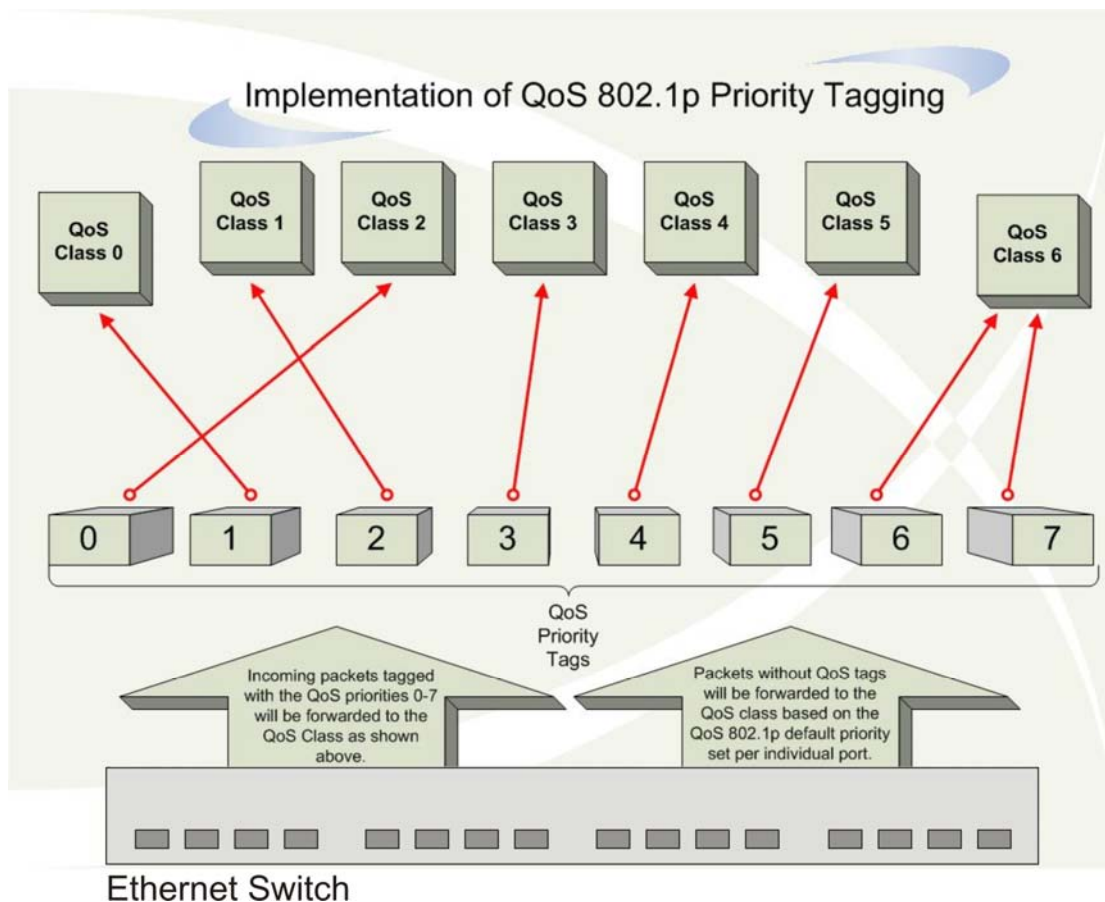

Figure 9- 1. Mapping QoS on the Switch

The previous picture shows the default priority setting for the Switch. Class-6 has the highest priority of the eight priority queues on the Switch. In order to implement QoS, the user is required to instruct the Switch to examine the header of a packet to see if it has the proper identifying tag tagged. Then the user may forward these tagged packets to designated queues on the Switch where they will be emptied, based on priority.

For example, let's say a user wishes to have a video conference between two remotely set computers. The administrator can add priority tags to the video packets being sent out, utilizing the Access Profile commands. Then, on the receiving end, the

administrator instructs the Switch to examine packets for this tag, acquires the tagged packets and maps them to a class queue on the Switch. Then in turn, the administrator will set a priority for this queue so that will be emptied before any other packet is forwarded. This results in the end user receiving all packets sent as quickly as possible, thus prioritizing the queue and allowing for an uninterrupted stream of packets, which optimizes the use of bandwidth available for the video conference.

Understanding QoS

The Switch has eight priority queues, one of which is internal and unconfigurable. These priority queues are labeled as 6, the high queue to 0, the lowest queue. The eight priority tags, specified in IEEE 802.1p are mapped to the Switch's priority tags as follows:

- Priority 0 is assigned to the Switch's Q2 queue.
- Priority 1 is assigned to the Switch's Q0 queue.
- Priority 2 is assigned to the Switch's Q1 queue.
- Priority 3 is assigned to the Switch's Q3 queue.
- Priority 4 is assigned to the Switch's Q4 queue.
- Priority 5 is assigned to the Switch's Q5 queue.
- Priority 6 is assigned to the Switch's Q6 queue.
- Priority 7 is assigned to the Switch's Q6 queue.

For strict priority-based scheduling, any packets residing in the higher priority queues are transmitted first. Multiple strict priority queues empty based on their priority tags. Only when these queues are empty, are packets of lower priority transmitted.

For weighted round robin queuing, the number of packets sent from each priority queue depends upon the assigned weight. For a configuration of 8 CoS queues, A~H with their respective weight value: 8~1, the packets are sent in the following sequence: A1, B1, C1, D1, E1, F1, G1, H1, A2, B2, C2, D2, E2, F2, G2, A3, B3, C3, D3, E3, F3, A4, B4, C4, D4, E4, A5, B5, C5, D5, A6, B6, C6, A7, B7, A8, A1, B1, C1, D1, E1, F1, G1, H1.

For weighted round robin queuing, if each CoS queue has the same weight value, then each CoS queue has an equal opportunity to send packets just like round robin queuing.

For weighted round-robin queuing, if the weight for a CoS is set to 0, then it will continue processing the packets from this CoS until there are no more packets for this CoS. The other CoS queues that have been given a nonzero value, and depending upon the weight, will follow a common weighted round-robin scheme.

Remember that the Switch has seven configurable priority queues (and seven Classes of Service) for each port on the Switch.



NOTICE: The Switch contains eight classes of service for each port on the Switch. One of these classes is reserved for internal use on the Switch and therefore is not configurable. All references in the following section regarding classes of service will refer to only the seven classes of service that may be used and configured by the Switch's Administrator.

Bandwidth Control

The bandwidth control settings are used to place a ceiling on the transmitting and receiving data rates for any selected port. To view the Bandwidth Control window, click **QoS > Bandwidth Control**, as shown below.

Bandwidth Settings

| Unit | From | To | Type | No Limit | Rate (64-10000000) | Apply |
|------|----------|----------|--------|------------|-------------------------------|-------|
| 1 ▾ | Port 1 ▾ | Port 1 ▾ | Both ▾ | Disabled ▾ | <input type="text"/> Kbit/sec | Apply |

Port Bandwidth Table-Unit 1

| Port | Rx Rate (Kbit/sec) | Tx Rate (Kbit/sec) | Effective Rx (Kbit/sec) | Effective Tx (Kbit/sec) |
|------|--------------------|--------------------|-------------------------|-------------------------|
| 1 | No Limit | No Limit | No Limit | No Limit |
| 2 | No Limit | No Limit | No Limit | No Limit |
| 3 | No Limit | No Limit | No Limit | No Limit |
| 4 | No Limit | No Limit | No Limit | No Limit |
| 5 | No Limit | No Limit | No Limit | No Limit |
| 6 | No Limit | No Limit | No Limit | No Limit |
| 7 | No Limit | No Limit | No Limit | No Limit |
| 8 | No Limit | No Limit | No Limit | No Limit |
| 9 | No Limit | No Limit | No Limit | No Limit |
| 10 | No Limit | No Limit | No Limit | No Limit |
| 11 | No Limit | No Limit | No Limit | No Limit |
| 12 | No Limit | No Limit | No Limit | No Limit |
| 13 | No Limit | No Limit | No Limit | No Limit |
| 14 | No Limit | No Limit | No Limit | No Limit |
| 15 | No Limit | No Limit | No Limit | No Limit |
| 16 | No Limit | No Limit | No Limit | No Limit |
| 17 | No Limit | No Limit | No Limit | No Limit |
| 18 | No Limit | No Limit | No Limit | No Limit |
| 19 | No Limit | No Limit | No Limit | No Limit |
| 20 | No Limit | No Limit | No Limit | No Limit |
| 21 | No Limit | No Limit | No Limit | No Limit |
| 22 | No Limit | No Limit | No Limit | No Limit |
| 23 | No Limit | No Limit | No Limit | No Limit |
| 24 | No Limit | No Limit | No Limit | No Limit |
| 25 | No Limit | No Limit | No Limit | No Limit |

Figure 9- 2. Bandwidth Settings window

The following parameters can be set or are displayed:

| Parameter | Description |
|------------------|---|
| Unit | Select the unit you wish to configure. |
| From...To | A consecutive group of ports may be configured starting with the selected port. |
| Type | This drop-down menu allows you to select between <i>RX</i> (receive), <i>TX</i> (transmit), and |

| | |
|---------------------------|--|
| | <i>Both.</i> This setting will determine whether the bandwidth ceiling is applied to receiving, transmitting, or both receiving and transmitting packets. |
| No Limit | This drop-down menu allows you to specify that the selected port will have no bandwidth limit. <i>Enabled</i> disables the limit or limits the bandwidth on a given port. |
| Rate (64-10000000) | This field allows the user to enter the data rate that will be the limit for the selected port. A rate can only be entered if the No Limit feature is <i>Disabled</i> . |

Click **Apply** to set the bandwidth control for the selected ports. Results of configured Bandwidth Settings will be displayed in the Port Bandwidth Table.

QoS Scheduling Mechanism

Changing the output scheduling used for the hardware queues in the Switch can customize QoS. As with any changes to QoS implementation, careful consideration should be given to how network traffic in lower priority queues is affected. Changes in scheduling may result in unacceptable levels of packet loss or significant transmission delay. If the user chooses to customize this setting, it is important to monitor network performance, especially during peak demand, as bottlenecks can quickly develop if the QoS settings are not suitable.

To view this window, click **QoS > QoS Scheduling Mechanism**, as shown below.

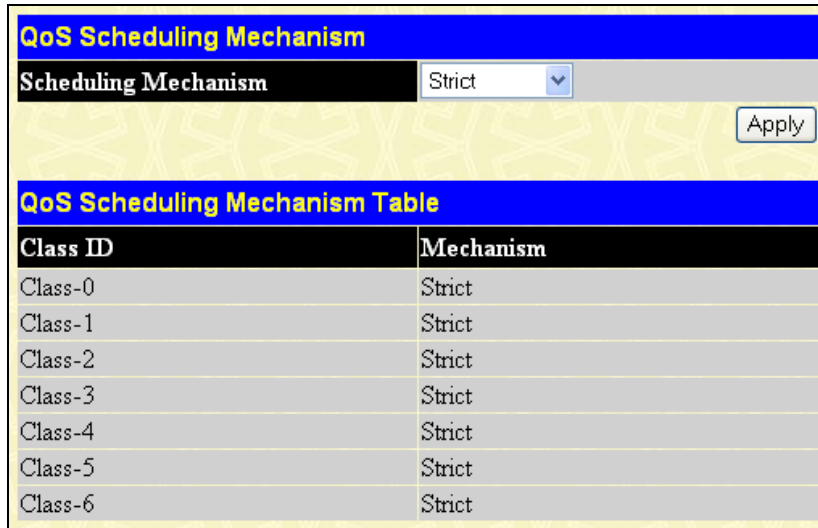

Figure 9- 3. QoS Scheduling Mechanism window

The Scheduling Mechanism has the following parameters.

| Parameter | Description |
|--------------------|--|
| Strict | The highest class of service is the first to process traffic. That is, the highest class of service will finish before other queues empty. |
| Weight fair | Use the weighted round-robin (<i>WRR</i>) algorithm to handle packets in an even distribution in priority classes of service. |

Click **Apply** to implement changes made.

QoS Output Scheduling

QoS can be customized by changing the output scheduling used for the hardware classes of service in the Switch. As with any changes to QoS implementation, careful consideration should be given to how network traffic in lower priority classes of service is affected. Changes in scheduling may result in unacceptable levels of packet loss or significant transmission delay. If choosing to customize this setting, it is important to monitor network performance, especially during peak demand, as bottlenecks can quickly develop if the QoS settings are not suitable.

To view this table, click **QoS > QoS Output Scheduling**, as shown below.

| QoS Output Scheduling | |
|--------------------------------------|--------------------------------|
| | Max. Packets |
| Class-0 | <input type="text" value="1"/> |
| Class-1 | <input type="text" value="2"/> |
| Class-2 | <input type="text" value="3"/> |
| Class-3 | <input type="text" value="4"/> |
| Class-4 | <input type="text" value="5"/> |
| Class-5 | <input type="text" value="6"/> |
| Class-6 | <input type="text" value="7"/> |
| <input type="button" value="Apply"/> | |

Figure 9- 4. QoS Output Scheduling window

The following values may be assigned to the QoS classes to set the scheduling.

| Parameter | Description |
|---------------------|---|
| Max. Packets | Specifies the maximum number of packets the above specified hardware priority class of service will be allowed to transmit before allowing the next lowest priority queue to transmit its packets. A value between 0 and 15 can be specified. |

Click **Apply** to implement changes made.

Configuring the Combination Queue

Utilizing the **QoS Output Scheduling** window shown above, the Switch can implement a combination queue for forwarding packets. This combination queue allows for a combination of strict and weight-fair (weighted round-robin “WRR”) scheduling for emptying given classes of service. To set the combination queue, enter a 0 for the Max Packets entry of the corresponding priority classes of service listed in the window above. Priority classes of service that have a 0 in the Max Packet field will forward packets with strict priority scheduling. The remaining classes of service, that do not have a 0 in their Max Packet field, will follow a weighted round-robin (WRR) method of forwarding packets — as long as the priority classes of service with a 0 in their Max Packet field are empty. When a packet arrives in a priority class with a 0 in its Max Packet field, this class of service will automatically begin forwarding packets until it is empty. Once a priority class of service with a 0 in its Max Packet field is empty, the remaining priority classes of service will reset the weighted round-robin (WRR) cycle of forwarding packets, starting with the highest available priority class of service. Priority classes of service with an equal level of priority and equal entries in their Max Packet field will empty their fields based on hardware priority scheduling. The Max Packet parameter allows the maximum number of packets a given priority class of service can transmit per weighted round-robin (WRR) scheduling cycle to be selected. This provides for a controllable CoS behavior while allowing other classes to empty as well. A value between 0 and 15 packets can be specified per priority class of service to create the combination queue.

The example window below displays an example of the combination queue where Class-1 will have a strict priority for emptying its class, while the other classes will follow a weight fair scheduling.

| QoS Output Scheduling | |
|-----------------------|--------------------------------|
| | Max. Packets |
| Class-0 | <input type="text" value="1"/> |
| Class-1 | <input type="text" value="0"/> |
| Class-2 | <input type="text" value="3"/> |
| Class-3 | <input type="text" value="4"/> |
| Class-4 | <input type="text" value="5"/> |
| Class-5 | <input type="text" value="6"/> |
| Class-6 | <input type="text" value="7"/> |

Figure 9- 5. QoS Output Scheduling window – Combination queue example

802.1p Default Priority

The Switch allows the assignment of a default 802.1p priority to each port on the Switch.

This window allows users to assign a default 802.1p priority to any given port on the Switch. The priority queues are numbered from 0, the lowest priority, to 7, the highest priority. Click **Apply** to implement changes made.

To view this window, click **QoS > 802.1p Default Priority**, as shown.



NOTE: The settings users assign to the queues, numbers 0-7, represent the IEEE 802.1p priority tag number. Do not confuse these settings with port numbers.

| 802.1P Default Priority | | | | |
|-------------------------|--------|--------|---------------|-------|
| Unit | From | To | Priority(0~7) | Apply |
| 1 | Port 1 | Port 1 | 0 | Apply |

| 802.1P Default Priority-Unit 1 | | |
|--------------------------------|----------|--------------------|
| Port | Priority | Effective Priority |
| 1 | 0 | 0 |
| 2 | 0 | 0 |
| 3 | 0 | 0 |
| 4 | 0 | 0 |
| 5 | 0 | 0 |
| 6 | 0 | 0 |
| 7 | 0 | 0 |
| 8 | 0 | 0 |
| 9 | 0 | 0 |
| 10 | 0 | 0 |
| 11 | 0 | 0 |
| 12 | 0 | 0 |
| 13 | 0 | 0 |
| 14 | 0 | 0 |
| 15 | 0 | 0 |
| 16 | 0 | 0 |
| 17 | 0 | 0 |
| 18 | 0 | 0 |
| 19 | 0 | 0 |
| 20 | 0 | 0 |
| 21 | 0 | 0 |
| 22 | 0 | 0 |
| 23 | 0 | 0 |
| 24 | 0 | 0 |
| 25 | 0 | 0 |

Figure 9- 6. 802.1p Default Priority window

802.1p User Priority

The Switches allows the assignment of a user priority to each of the 802.1p priorities.

To view this window, click **QoS > 802.1p User Priority**, as shown below.

| 802.1P User Priority | |
|----------------------|---------|
| Priority-0 | Class-2 |
| Priority-1 | Class-0 |
| Priority-2 | Class-1 |
| Priority-3 | Class-3 |
| Priority-4 | Class-4 |
| Priority-5 | Class-5 |
| Priority-6 | Class-6 |
| Priority-7 | Class-6 |

Apply

Figure 9- 7. 802.1p User Priority window

Once a priority to the port groups on the Switch has been assigned, users can then assign this Class to each of the eight levels of 802.1p priorities. Click **Apply** to set changes made.

Section 10

ACL

Time Range

Access Profile Table

ACL Flow Meter

CPU Interface Filtering

Time Range

The Time Range window is used in conjunction with the Access Profile feature to determine a starting point and an ending point, based on days of the week, when an Access Profile configuration will be enabled on the Switch. Once configured here, the time range settings are to be applied to an access profile rule using the Access Profile table. The user may enter up to 64 time range entries on the Switch.



NOTE: The Time Range commands are based on the time settings of the Switch. Make sure to configure the time for the Switch appropriately for these commands using commands listed in the following chapter, Time and SNTP Commands.

To open the Time Range window, click **ACL > Time Range**, as shown below.

| Time Range Settings | | | | | | | | | | | | | | | | |
|--------------------------------------|--|--------------------------|----------|--------------------------|----------|--------------------------|------|--------------------------|-----|--------------------------|-----|--------------------------|-----|--------------------------|-----------------|--------------------------|
| Range Name | <input style="width: 90%;" type="text"/> | | | | | | | | | | | | | | | |
| Hours(HH MM SS) | Start Time | 00 ▾ | 00 ▾ | 00 ▾ | End Time | 00 ▾ | 00 ▾ | 00 ▾ | | | | | | | | |
| Weekdays | Mon | <input type="checkbox"/> | Tue | <input type="checkbox"/> | Wed | <input type="checkbox"/> | Thu | <input type="checkbox"/> | Fri | <input type="checkbox"/> | Sat | <input type="checkbox"/> | Sun | <input type="checkbox"/> | Select All Days | <input type="checkbox"/> |
| <input type="button" value="Apply"/> | | | | | | | | | | | | | | | | |
| Total Entries: 0 | | | | | | | | | | | | | | | | |
| Time Range Information | | | | | | | | | | | | | | | | |
| Range Name | Days | Start Time | End Time | Delete | | | | | | | | | | | | |

Figure 10- 1. Time Range Settings window

The user may adjust the following parameters to configure a time range on the Switch:

| Parameter | Description |
|-------------------------|--|
| Range Name | Enter a name of no more than 32 alphanumeric characters that will be used to identify this time range on the Switch. This range name will be used in the Access Profile table to identify the access profile and associated rule to be enabled during this time range. |
| Hours (HH MM SS) | This parameter is used to set the time in the day that this time range is to be enabled using the following parameters: <ul style="list-style-type: none"> Start Time <time hh:mm:ss> - Use this parameter to identify the starting time of the time range, in hours, minutes and seconds, based on the 24-hour time system. End Time <time hh:mm:ss> - Use this parameter to identify the ending time of the time range, in hours, minutes and seconds, based on the 24-hour time system. |
| Weekdays | Use the check boxes to tick the corresponding days of the week that this time range is to be enabled. |

Click **Apply** to implement changes made. Currently configured entries will be displayed in the Time Range Information table in the bottom half of the window shown above.

Access profiles allow users to establish criteria to determine whether or not the Switch will forward packets based on the information contained in each packet's header. These criteria can be specified on a basis of Packet Content, MAC address, or IP address.

Access Profile Table

Creating an access profile is divided into two basic parts. The first is to specify which part or parts of a frame the Switch will examine, such as the MAC source address or the IP destination address. The second part is entering the criteria the Switch will use to determine what to do with the frame. The entire process is described below in two parts.

To view this window, click **ACL > Access Profile Table**, as shown below.

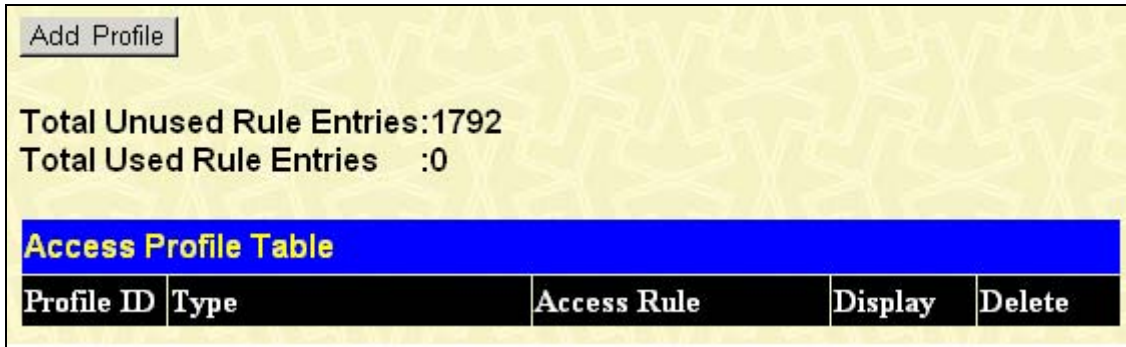

Figure 10- 2. Access Profile Table window

To add an entry to the Access Profile Table, click the **Add Profile** button. This will open the **Access Profile Configuration** window, as shown below. There are four **Access Profile Configuration** windows; one for Ethernet (or MAC address-based) profile configuration, one for IP address-based profile configuration, one for Packet Content and one for IPv6 addresses. Users can switch between the four **Access Profile Configuration** windows by using the Type drop-down menu. The window shown below is the **Access Profile Configuration** window for Ethernet.

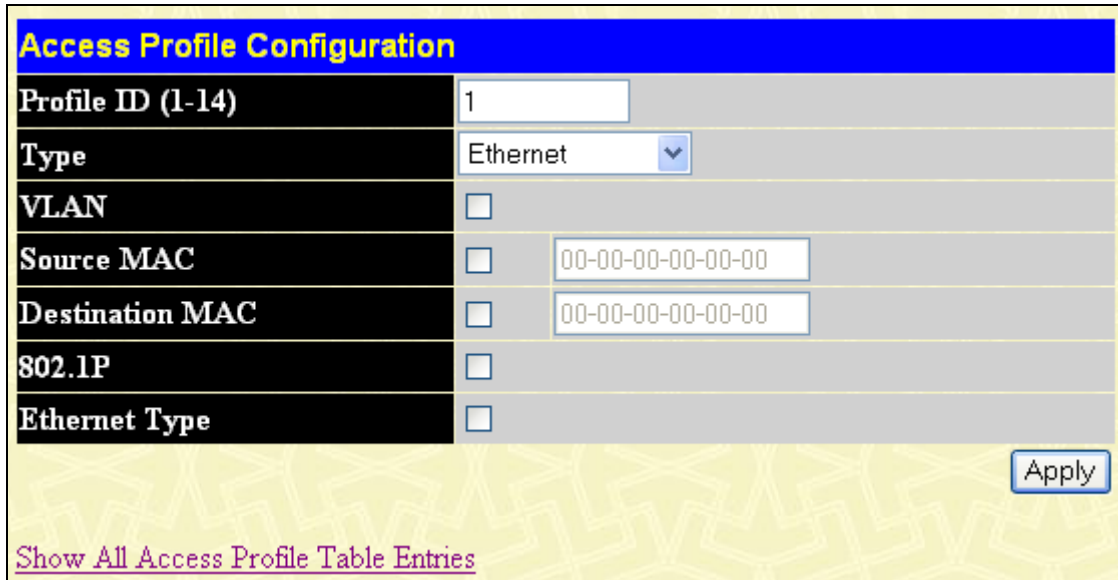

Figure 10- 3. Access Profile Configuration window (Ethernet)

The following parameters can be set, for the Ethernet type:

| Parameter | Description |
|--------------------------|---|
| Profile ID (1-14) | Type in a unique identifier number for this profile set. This value can be set from 1 to 14. |
| Type | Select profile based on <i>Ethernet</i> (MAC Address), <i>IP</i> address, <i>Packet Content</i> , or <i>IPv6</i> address. This will change the window according to the requirements for the type of profile. <ul style="list-style-type: none"> Select <i>Ethernet</i> to instruct the Switch to examine the layer 2 part of each packet |

| | |
|------------------------|--|
| | <p>header.</p> <ul style="list-style-type: none"> • Select <i>IP</i> to instruct the Switch to examine the IP address in each frame's header. • Select <i>Packet Content Mask</i> to specify a mask to hide the content of the packet header. • Select <i>IPv6</i> to instruct the Switch to examine the IPv6 address in each frame's header. |
| VLAN | Selecting this option instructs the Switch to examine the VLAN identifier of each packet header and use this as the full or partial criterion for forwarding. |
| Source MAC | Source MAC Mask - Enter a MAC address mask for the source MAC address. |
| Destination MAC | Destination MAC Mask - Enter a MAC address mask for the destination MAC address. |
| 802.1p | Selecting this option instructs the Switch to examine the 802.1p priority value of each packet header and use this as the, or part of the criterion for forwarding. |
| Ethernet type | Selecting this option instructs the Switch to examine the Ethernet type value in each frame's header. |

The window shown below is the **Access Profile Configuration** window for IP.

Access Profile Configuration

| | | |
|----------------------------|-------------------------------------|--|
| Profile ID (1-14) | <input type="text" value="2"/> | |
| Type | IP <input type="button" value="v"/> | |
| VLAN | <input type="checkbox"/> | |
| Source IP Mask | <input type="checkbox"/> | <input type="text" value="0.0.0.0"/> |
| Destination IP Mask | <input type="checkbox"/> | <input type="text" value="0.0.0.0"/> |
| DSCP | <input type="checkbox"/> | |
| Protocol | <input type="checkbox"/> | <input checked="" type="radio"/> ICMP <input type="checkbox"/> type <input type="checkbox"/> code <input type="radio"/> IGMP <input type="checkbox"/> type <input type="radio"/> TCP <input type="checkbox"/> src port mask <input type="text" value="0000"/> <input type="checkbox"/> dst port mask <input type="text" value="0000"/> <input type="checkbox"/> flag bit <input type="checkbox"/> urg <input type="checkbox"/> ack <input type="checkbox"/> psh <input type="checkbox"/> rst <input type="checkbox"/> syn <input type="checkbox"/> fin <input type="radio"/> UDP <input type="checkbox"/> src port mask <input type="text" value="0000"/> <input type="checkbox"/> dst port mask <input type="text" value="0000"/> <input type="radio"/> Protocol id <input type="text" value="00"/> <input type="checkbox"/> user mask <input type="text" value="00000000"/> |

[Show All Access Profile Table Entries](#)

Figure 10- 4. Access Profile Configuration window (IP)

The following parameters can be set, for IP:

| Parameter | Description |
|----------------------------|---|
| Profile ID (1-14) | Type in a unique identifier number for this profile set. This value can be set from 1 to 14. |
| Type | <p>Select profile based on <i>Ethernet</i> (MAC Address), <i>IP</i> address, <i>Packet Content Mask</i>, or <i>IPv6</i> address. This will change the window according to the requirements for the type of profile.</p> <ul style="list-style-type: none"> Select <i>Ethernet</i> to instruct the Switch to examine the layer 2 part of each packet header. Select <i>IP</i> to instruct the Switch to examine the IP address in each frame's header. Select <i>Packet Content Mask</i> to specify a mask to hide the content of the packet header. Select <i>IPv6</i> to instruct the Switch to examine the IPv6 address in each frame's header. |
| VLAN | Selecting this option instructs the Switch to examine the VLAN part of each packet header and use this as the, or part of the criterion for forwarding. |
| Source IP Mask | Enter an IP address mask for the source IP address. |
| Destination IP Mask | Enter an IP address mask for the destination IP address. |
| DSCP | Selecting this option instructs the Switch to examine the DiffServ Code part of each packet header and use this as the, or part of the criterion for forwarding. |
| Protocol | <p>Selecting this option instructs the Switch to examine the protocol type value in each frame's header. You must then specify what protocol(s) to include according to the following guidelines:</p> <p>Select <i>ICMP</i> to instruct the Switch to examine the Internet Control Message Protocol (ICMP) field in each frame's header.</p> <ul style="list-style-type: none"> Select <i>Type</i> to further specify that the access profile will apply an ICMP type value, or specify <i>Code</i> to further specify that the access profile will apply an ICMP code value. <p>Select <i>IGMP</i> to instruct the Switch to examine the Internet Group Management Protocol (IGMP) field in each frame's header.</p> <ul style="list-style-type: none"> Select <i>Type</i> to further specify that the access profile will apply an IGMP type value <p>Select <i>TCP</i> to use the TCP port number contained in an incoming packet as the forwarding criterion. Selecting TCP requires that you specify a source port mask and/or a destination port mask. The user may also identify which flag bits to filter. Flag bits are parts of a packet that determine what to do with the packet. The user may filter packets by filtering certain flag bits within the packets, by checking the boxes corresponding to the flag bits of the TCP field. The user may choose between <i>urg</i> (urgent), <i>ack</i> (acknowledgement), <i>psh</i> (push), <i>rst</i> (reset), <i>syn</i> (synchronize), <i>fin</i> (finish).</p> <ul style="list-style-type: none"> <i>src port mask</i> - Specify a TCP port mask for the source port in hex form (hex 0x0-0xffff), which you wish to filter. <i>dst port mask</i> - Specify a TCP port mask for the destination port in hex form (hex 0x0-0xffff) which you wish to filter. <p>Select <i>UDP</i> to use the UDP port number contained in an incoming packet as the forwarding criterion. Selecting UDP requires that you specify a source port mask and/or a destination port mask.</p> <ul style="list-style-type: none"> <i>src port mask</i> - Specify a UDP port mask for the source port in hex form (hex 0x0-0xffff). <i>dst port mask</i> - Specify a UDP port mask for the destination port in hex form (hex 0x0-0xffff). |

protocol id - Enter a value defining the protocol ID in the packet header to mask. Specify the protocol ID mask in hex form (hex 0x0-0xff) or a user value.

Click Apply to implement changes made. The window shown below is the Access Profile Configuration window for Packet Content Mask.

Figure 10- 5. Access Profile Configuration window (Packet Content Mask)

This screen will aid the user in configuring the Switch to mask packet headers beginning with the offset value specified. The following fields are used to configure the Packet Content Mask:

| Parameter | Description | | | | | | | | | | | | | | | | | | | | | | | | | | | | | | |
|--------------------------|--|---------------------|----------------|---------------------|----------------|----------------|----------------|------|----|----|------|------|------|------|----|----|------|------|------|----|----|----|------|------|------|----|----|----|------|------|------|
| Profile ID (1-14) | Type in a unique identifier number for this profile set. This value can be set from 1 to 14. | | | | | | | | | | | | | | | | | | | | | | | | | | | | | | |
| Type | <p>Select profile based on Ethernet (MAC Address), IP address, packet content mask or IPv6. This will change the menu according to the requirements for the type of profile.</p> <ul style="list-style-type: none"> • Select <i>Ethernet</i> to instruct the Switch to examine the layer 2 part of each packet header. • Select <i>IP</i> to instruct the Switch to examine the IP address in each frame's header. • Select <i>Packet Content Mask</i> to specify a mask to hide the content of the packet header. • Select <i>IPv6</i> to instruct the Switch to examine the IPv6 part of each packet header. | | | | | | | | | | | | | | | | | | | | | | | | | | | | | | |
| Offset | <p>The offset field is used to examine the packet header which is divided up into four “chunks” where each chunk represents 4 bytes. Values within the packet header chunk to be identified are to be marked in hexadecimal form in the “mask” field. The following table will help you identify the bytes in the respective chunks.</p> <table border="1"> <thead> <tr> <th><u>chunk0</u></th> <th><u>chunk1</u></th> <th><u>chunk2</u>.....</th> <th><u>chunk29</u></th> <th><u>chunk30</u></th> <th><u>chunk31</u></th> </tr> </thead> <tbody> <tr> <td>b126</td> <td>b2</td> <td>b6</td> <td>b114</td> <td>b118</td> <td>b122</td> </tr> <tr> <td>b127</td> <td>b3</td> <td>b7</td> <td>b115</td> <td>b119</td> <td>b123</td> </tr> <tr> <td>b0</td> <td>b4</td> <td>b8</td> <td>b116</td> <td>b120</td> <td>b124</td> </tr> <tr> <td>b1</td> <td>b5</td> <td>b9</td> <td>b117</td> <td>b121</td> <td>b125</td> </tr> </tbody> </table> <p>Check the box of the chunk, from 1 to 4, you wish to examine and then enter the hexadecimal value in the mask field.</p> | <u>chunk0</u> | <u>chunk1</u> | <u>chunk2</u> | <u>chunk29</u> | <u>chunk30</u> | <u>chunk31</u> | b126 | b2 | b6 | b114 | b118 | b122 | b127 | b3 | b7 | b115 | b119 | b123 | b0 | b4 | b8 | b116 | b120 | b124 | b1 | b5 | b9 | b117 | b121 | b125 |
| <u>chunk0</u> | <u>chunk1</u> | <u>chunk2</u> | <u>chunk29</u> | <u>chunk30</u> | <u>chunk31</u> | | | | | | | | | | | | | | | | | | | | | | | | | | |
| b126 | b2 | b6 | b114 | b118 | b122 | | | | | | | | | | | | | | | | | | | | | | | | | | |
| b127 | b3 | b7 | b115 | b119 | b123 | | | | | | | | | | | | | | | | | | | | | | | | | | |
| b0 | b4 | b8 | b116 | b120 | b124 | | | | | | | | | | | | | | | | | | | | | | | | | | |
| b1 | b5 | b9 | b117 | b121 | b125 | | | | | | | | | | | | | | | | | | | | | | | | | | |

Click **Apply** to implement changes made.

The window shown below is the **Access Profile Configuration** window for IPv6.

Figure 10- 6. Access Profile Configuration window (IPv6)

This screen will aid the user in configuring the Switch to mask packet headers beginning with the offset value specified. The following fields are used to configure the IPv6:

| Parameter | Description |
|------------------------------|---|
| Profile ID (1-14) | Type in a unique identifier number for this profile set. This value can be set from 1 to 14. |
| Type | Select profile based on <i>Ethernet</i> (MAC Address), <i>IP Address</i> , <i>Packet Content</i> or <i>IPv6</i> address. This will change the window according to the requirements for the type of profile. <ul style="list-style-type: none"> Select <i>Ethernet</i> to instruct the Switch to examine the layer 2 part of each packet header. Select <i>IP</i> to instruct the Switch to examine the IP address in each frame's header. Select <i>Packet Content Mask</i> to specify a mask to hide the content of the packet header. Select <i>IPv6</i> to instruct the Switch to examine the IPv6 address in each frame's header. |
| Class | Ticking this check box will instruct the Switch to examine the class field of the IPv6 header. This class field is a part of the packet header that is similar to the Type of Service (ToS) or Precedence bits field in IPv4. |
| Flow Label | Ticking this check box will instruct the Switch to examine the flow label field of the IPv6 header. This flow label field is used by a source to label sequences of packets such as non-default quality of service or real time service packets. |
| Source IPv6 Mask | The user may specify an IP address mask for the source IPv6 address by ticking the corresponding box and entering the IP address mask. |
| Destination IPv6 Mask | The user may specify an IP address mask for the destination IPv6 address by ticking the corresponding box and entering the IP address mask. |

Click **Apply** to implement changes made.

To view the configurations set for a previously created access profile, return to the Access Profile Table and click the [View](#) button under the Display heading, corresponding to the access profile for which to view configurations. A window similar to the one below will be displayed.

| Access Profile Entry Display | |
|------------------------------|----------|
| Profile ID | 1 |
| Owner | ACL |
| Type | Ethernet |
| VLAN | Enabled |
| Source MAC | ----- |
| Destination MAC | ----- |
| 802.1P | ----- |
| Ethernet Type | ----- |

[Show All Access Profile Table Entries](#)

Figure 10- 7. Access Profile Entry Display window (Ethernet)

To establish the rule for a previously created Access Profile:

To view this window, click **ACL > Access Profile Table > Access Profile Table**, as shown below.

| <input type="button" value="Add Profile"/> | <input type="button" value="Clear All"/> | | | |
|--|--|---------------------------------------|-------------------------------------|----------------------------------|
| Total Unused Rule Entries:1792 | | | | |
| Total Used Rule Entries :0 | | | | |
| Access Profile Table | | | | |
| Profile ID | Type | Access Rule | Display | Delete |
| 1 | Ethernet | <input type="button" value="Modify"/> | <input type="button" value="View"/> | <input type="button" value="X"/> |
| 2 | IP | <input type="button" value="Modify"/> | <input type="button" value="View"/> | <input type="button" value="X"/> |
| 3 | Packet Content | <input type="button" value="Modify"/> | <input type="button" value="View"/> | <input type="button" value="X"/> |
| 4 | IPv6 | <input type="button" value="Modify"/> | <input type="button" value="View"/> | <input type="button" value="X"/> |

Figure 10- 8. Access Profile Table window

To create a new rule set for an access profile click the **Modify** button located under the **Access Rule** heading. The window shown below (**Access Profile Rule**) will be displayed. To remove a previously created rule, click the corresponding button.

| <input type="button" value="Add Rule"/> | | | | | |
|---|--------|----------|-----------|-------------------------------------|----------------------------------|
| Access Rule Table | | | | | |
| Profile ID | Mode | Type | Access ID | Display | Delete |
| 1 | Permit | Ethernet | 1 | <input type="button" value="View"/> | <input type="button" value="X"/> |
| Unused Entries:127 | | | | | |
| Show All Access Profile Entries | | | | | |

Figure 10- 9. Access Rule Table window

Click **Add Rule** to add a new Rule for an existing profile. The **Access Rule Configuration** window will appear.

To remove a previously created rule, select it and click the  button. To add a new Access Rule, click the **Add Rule** button, and the **Access Rule Configuration** window will appear:

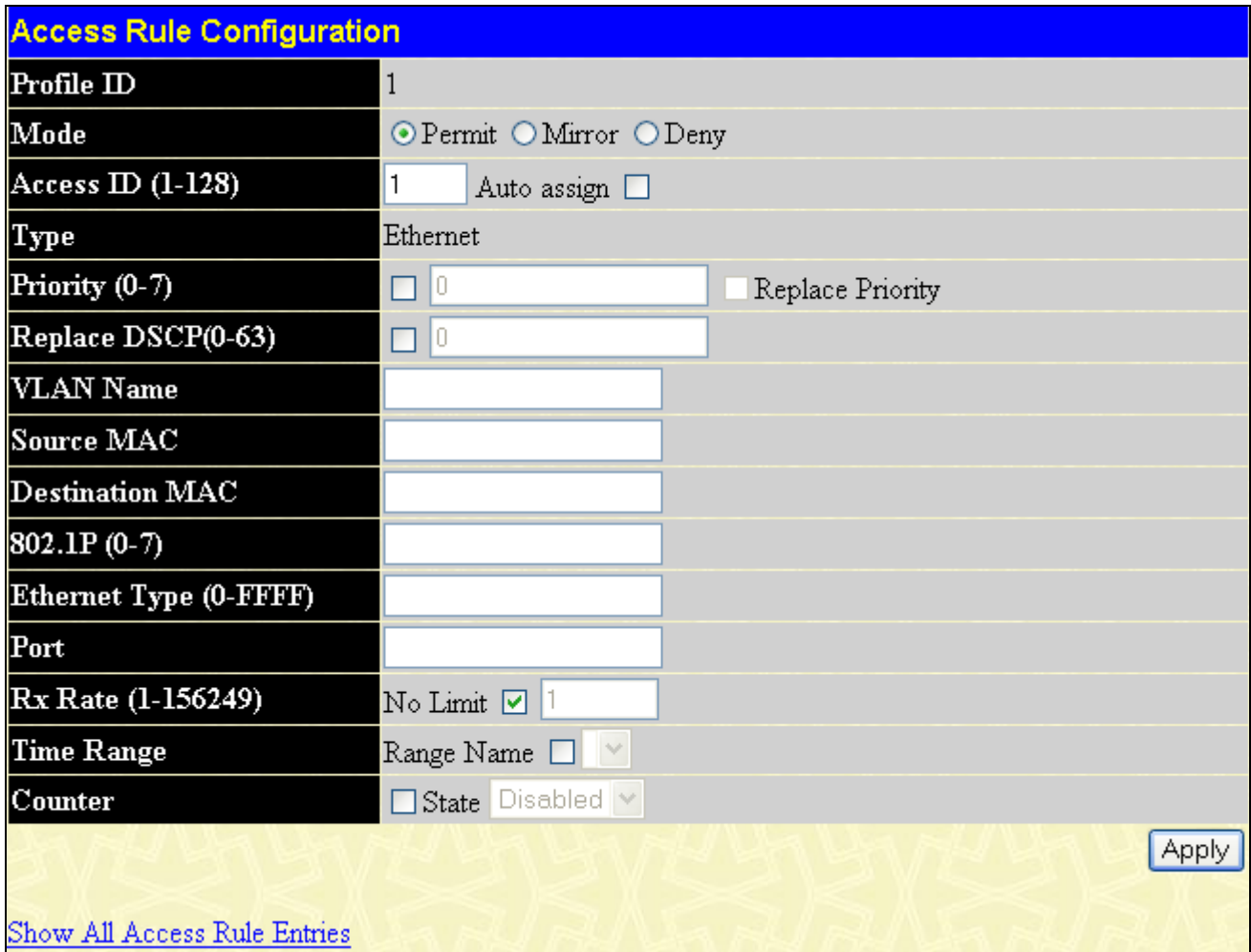

Figure 10- 10. Access Rule Configuration window (Ethernet)

To set the Access Rule for Ethernet, adjust the following parameters and click **Apply**.

| Parameters | Description |
|--------------------------|--|
| Profile ID | This is the identifier number for this profile set. |
| Mode | <p>Select <i>Permit</i> to specify that the packets that match the access profile are forwarded by the Switch, according to any additional rule added (see below).</p> <p>Select <i>Deny</i> to specify that packets that do not match the access profile are not forwarded by the Switch and will be filtered.</p> <p>Select <i>Mirror</i> to specify that packets that match the access profile are mirrored to a port defined in the Port Mirroring window. Port Mirroring must be enabled and a target port must be set.</p> |
| Access ID (1-128) | <p>Type in a unique identifier number for this access. This value can be set from 1 to 128.</p> <ul style="list-style-type: none"> Auto Assign – Ticking this check box will instruct the Switch to automatically assign an Access ID for the rule being created. |
| Type | <p>Selected profile based on Ethernet (MAC Address), IP address, Packet Content, IPv6 address.</p> <ul style="list-style-type: none"> Ethernet instructs the Switch to examine the layer 2 part of each packet header. IP instructs the Switch to examine the IP address in each frame's header. Packet Content Mask instructs the Switch to examine the packet header. IPv6 instructs the Switch to examine the IPv6 address in each frame's header. |

| | |
|--------------------------------------|--|
| <p>Priority (0-7)</p> | <p>This parameter is specified to re-write the 802.1p default priority previously set in the Switch, which is used to determine the CoS queue to which packets are forwarded. Once this field is specified, packets accepted by the Switch that match this priority are forwarded to the CoS queue specified previously by the user.</p> <p>Replace priority – Tick the corresponding check box to re-write the 802.1p default priority of a packet to the value entered in the <i>Priority</i> field, which meets the criteria specified previously in this command, before forwarding it on to the specified CoS queue. Otherwise, a packet will have its incoming 802.1p user priority re-written to its original value before being forwarded by the Switch.</p> <p>For more information on priority queues, CoS queues and mapping for 802.1p, see the QoS section of this manual.</p> |
| <p>Replace DSCP(0-63)</p> | <p>This feature allows the user to specify a value to be written to the DSCP field of an incoming packet. This value will over-write the value in the DSCP field of the packet. Enter a value between 0-63.</p> |
| <p>VLAN Name</p> | <p>Allows the entry of a name for a previously configured VLAN.</p> |
| <p>Source MAC</p> | <p>Source MAC Address - Enter a MAC Address for the source MAC address.</p> |
| <p>Destination MAC</p> | <p>Destination MAC Address - Enter a MAC Address mask for the destination MAC address.</p> |
| <p>802.1p (0-7)</p> | <p>Enter a value from 0 to 7 to specify that the access profile will apply only to packets with this 802.1p priority value.</p> |
| <p>Ethernet Type (0-FFFF)</p> | <p>Specifies that the access profile will apply only to packets with this hexadecimal 802.1Q Ethernet type value (hex 0x0-0xffff) in the packet header. The Ethernet type value may be set in the form: hex 0x0-0xffff, which means the user may choose any combination of letters and numbers ranging from a-f and from 0-9.</p> |
| <p>Port</p> | <p>The Access Rule may be configured on a per-port basis by entering the port number of the switch in the switch stack into this field. When a range of ports is to be configured, the <i>Auto Assign check</i> box MUST be clicked in the <i>Access ID</i> field of this window. If not, the user will be presented with an error message and the access rule will not be configured. The beginning and end of the port list range are separated by a dash. For example, 3 specifies port 3. 2 - 4 specifies the range of ports from 2 to 4.</p> |
| <p>Rx Rate (1-156249)</p> | <p>Use this to limit Rx bandwidth for the profile being configured. This rate is implemented using the following equation: 1 value = 64kbit/sec. (ex. If the user selects an Rx rate of 10 then the ingress rate is 640kbit/sec.) The user may select a value between 1 and 156249 or <i>No Limit</i>. The default setting is <i>No Limit</i>.</p> |
| <p>Time Range</p> | <p>Tick the check box and enter the name of the Time Range settings that has been previously configured in the Time Range Settings window. This will set specific times when this access rule will be implemented on the Switch.</p> |
| <p>Counter</p> | <p>Tick the check box and use the pull-down menu to employ the Counter that will count the packets identified with this rule. Users must note that if the Counter is employed in the ACL Flow Meter function, the Counter will automatically be disabled here, regardless of this setting.</p> |

To view the settings of a previously, correctly configured rule, click [View](#) in the Access Rule Table to view the window shown below. Clicking the hyperlink for the Profile ID on the **Access Profile Table** window will also bring up the **Access Rule Display** window.

| Access Rule Display | |
|---------------------|----------|
| Profile ID | 1 |
| Access ID | 1 |
| Mode | Permit |
| Type | Ethernet |
| Priority | ----- |
| Replace Dscp | ----- |
| VLAN Name | RG |
| Source MAC | ----- |
| Destination MAC | ----- |
| 802.1P | ----- |
| Ethernet Type | ----- |
| Port | 1:1 |
| Rx Rate(64Kbps) | No Limit |

[Show All Access Rule Entries](#)

Figure 10- 11. Access Rule Display window (Ethernet)

| Access Rule Configuration | |
|---------------------------|---|
| Profile ID | 2 |
| Mode | <input checked="" type="radio"/> Permit <input type="radio"/> Mirror <input type="radio"/> Deny |
| Access ID (1-128) | 1 <input type="checkbox"/> Auto assign <input type="checkbox"/> |
| Type | IP |
| Priority (0-7) | <input type="checkbox"/> 0 <input type="checkbox"/> Replace Priority |
| Replace DSCP(0-63) | <input type="checkbox"/> 0 |
| VLAN Name | <input type="text"/> |
| Source IP | <input type="text"/> |
| Destination IP | <input type="text"/> |
| DSCP (0-63) | <input type="text"/> |
| Protocol | Protocol id <input type="text"/> user define <input type="text"/> |
| Port | <input type="text"/> |
| Rx Rate (1-156249) | No Limit <input checked="" type="checkbox"/> 1 <input type="text"/> |
| Time Range | Range Name <input type="checkbox"/> <input type="text"/> |
| Counter | <input type="checkbox"/> State Disabled <input type="text"/> |

[Show All Access Rule Entries](#)

Figure 10- 12. Access Rule Configuration window (IP)

Configure the following **Access Rule Configuration** settings for IP:

| Parameter | Description |
|----------------------------|--|
| Profile ID | This is the identifier number for this profile set. |
| Mode | <p>Select <i>Permit</i> to specify that the packets that match the access profile are forwarded by the Switch, according to any additional rule added (see below).</p> <p>Select <i>Deny</i> to specify that packets that do not match the access profile are not forwarded by the Switch and will be filtered.</p> <p>Select <i>Mirror</i> to specify that packets that match the access profile are mirrored to a port defined in the Port Mirroring window. Port Mirroring must be enabled and a target port must be set.</p> |
| Access ID (1-128) | <p>Type in a unique identifier number for this access. This value can be set from 1 to 128.</p> <ul style="list-style-type: none"> Auto Assign – Ticking this check box will instruct the Switch to automatically assign an Access ID for the rule being created. |
| Type | <p>Selected profile based on Ethernet (MAC Address), IP address, Packet Content, or IPv6 address.</p> <ul style="list-style-type: none"> Ethernet instructs the Switch to examine the layer 2 part of each packet header. IP instructs the Switch to examine the IP address in each frame's header. Packet Content Mask instructs the Switch to examine the packet header. IPv6 instructs the Switch to examine the IPv6 address in each frame's header. |
| Priority (0-7) | <p>This parameter is specified to re-write the 802.1p default priority previously set in the Switch, which is used to determine the CoS queue to which packets are forwarded to. Once this field is specified, packets accepted by the Switch that match this priority are forwarded to the CoS queue specified previously by the user.</p> <p>Replace priority – Tick the corresponding check box to re-write the 802.1p default priority of a packet to the value entered in the <i>Priority</i> field, which meets the criteria specified previously in this command, before forwarding it on to the specified CoS queue. Otherwise, a packet will have its incoming 802.1p user priority re-written to its original value before being forwarded by the Switch.</p> <p>For more information on priority queues, CoS queues and mapping for 802.1p, see the QoS section of this manual.</p> |
| Replace DSCP (0-63) | Select this option to instruct the Switch to replace the DSCP value (in a packet that meets the selected criteria) with the value entered in the adjacent field. |
| Source IP | Source IP Address - Enter an IP Address mask for the source IP address. |
| Destination IP | Destination IP Address- Enter an IP Address mask for the destination IP address. |
| DSCP (0-63) | This field allows the user to enter a DSCP value in the space provided, which will instruct the Switch to examine the DiffServ Code part of each packet header and use this as the, or part of the criterion for forwarding. The user may choose a value between 0 and 63. |
| Protocol | This field allows the user to modify the protocol used to configure the Access Rule Table; depending on which protocol the user has chosen in the Access Profile Table. |
| Port | The Access Rule may be configured on a per-port basis by entering the port number of the switch in the switch stack into this field. When a range of ports is to be configured, the Auto Assign check box MUST be ticked in the Access ID field of this window. If not, the user will be presented with an error message and the access rule will not be configured. The beginning and end of the port list range are separated by a dash. For example, 3 specifies port 3. 2-4 specifies the range of ports from 2 to 4. |
| Rx Rate | Use this to limit Rx bandwidth for the profile being configured. This rate is implemented using the following equation: 1 value = 64kbit/sec. (ex. If the user selects an Rx rate of 10 then the ingress |

| | |
|-------------------|---|
| | rate is 640kbit/sec.) The user may select a value between 1 and 156249 or <i>No Limit</i> . The default setting is <i>No Limit</i> . |
| Time Range | Tick the check box and enter the name of the Time Range settings that has been previously configured in the Time Range Settings window. This will set specific times when this access rule will be implemented on the Switch. |
| Counter | Tick the check box and use the pull-down menu to employ the Counter that will count the packets identified with this rule. Users must note that if the Counter is employed in the ACL Flow Meter function, the Counter will automatically be disabled here, regardless of this setting. |

To view the settings of a previously correctly configured rule, click [View](#) in the **Access Rule Table**.

| Access Rule Table | | | | | |
|-------------------|--------|------|-----------|----------------------|--------|
| Profile ID | Mode | Type | Access ID | Display | Delete |
| 2 | Permit | IP | 3 | View | X |

[Show All Access Profile Entries](#)

Figure 10- 13. Access Rule Table window

The window shown below will appear.

| Access Rule Display | |
|---------------------|----------|
| Profile ID | 1 |
| Access ID | 1 |
| Mode | Permit |
| Type | IP |
| Priority | ----- |
| Replace Dscp | ----- |
| VLAN Name | RG |
| Source IP | ----- |
| Destination IP | ----- |
| DSCP | ----- |
| Protocol | ----- |
| Port | 1:2 |
| Rx Rate(64Kbps) | No Limit |

[Show All Access Rule Entries](#)

Figure 10- 14. Access Rule Display window (IP)

The following window is the Access Rule table for Packet Content.

| Access Rule Table | | | | | |
|-------------------|--------|----------------|-----------|----------------------|--------------------------|
| Profile ID | Mode | Type | Access ID | Display | Delete |
| 2 | Permit | Packet Content | 1 | View | <input type="checkbox"/> |

Unused Entries:127

[Show All Access Profile Entries](#)

Figure 10- 15. Access Rule Table window (Packet Content Mask)

To remove a previously created rule, select it and click the button. To add a new Access Rule, click the **Add** button:

| Access Rule Configuration | |
|---------------------------|---|
| Profile ID | 1 |
| Mode | <input checked="" type="radio"/> Permit <input type="radio"/> Mirror <input type="radio"/> Deny |
| Access ID (1-128) | 1 <input type="text"/> Auto assign <input type="checkbox"/> |
| Type | Packet Content |
| Priority (0-7) | <input type="checkbox"/> <input type="text"/> <input type="checkbox"/> Replace Priority |
| Offset | <input type="checkbox"/> Chunk 1 mask <input type="text"/> |
| | <input type="checkbox"/> Chunk 2 mask <input type="text"/> |
| | <input type="checkbox"/> Chunk 3 mask <input type="text"/> |
| | <input type="checkbox"/> Chunk 4 mask <input type="text"/> |
| Port | <input type="text"/> |
| Rx Rate (1-156249) | No Limit <input checked="" type="checkbox"/> <input type="text"/> 1 |
| Time Range | Range Name <input type="checkbox"/> <input type="text"/> |
| Counter | <input type="checkbox"/> State <input type="text"/> Disabled <input type="text"/> |

[Show All Access Rule Entries](#)

Figure 10- 16. Access Rule Configuration window (Packet Content Mask)

To set the Access Rule for the Packet Content Mask, adjust the following parameters and click **Apply**.

| Parameter | Description |
|-------------------|--|
| Profile ID | This is the identifier number for this profile set. |
| Mode | Select <i>Permit</i> to specify that the packets that match the access profile are forwarded by the Switch, according to any additional rule added (see below). Select <i>Deny</i> to specify that packets that match the access profile are not forwarded by the Switch and will be filtered. Select <i>Mirror</i> to specify that packets that match the access profile are mirrored to a port defined in the Port Mirroring window. Port Mirroring must be enabled and a target port must be set. |
| Access ID (1-128) | Type in a unique identifier number for this access. This value can be set from 1 to 128. |

| | |
|-------------------|--|
| | <ul style="list-style-type: none"> Auto Assign – Ticking this check box will instruct the Switch to automatically assign an Access ID for the rule being created. |
| Type | <p>Selected profile based on Ethernet (MAC Address), IP address, Packet Content Mask or IPv6.</p> <ul style="list-style-type: none"> Ethernet instructs the Switch to examine the layer 2 part of each packet header. IP instructs the Switch to examine the IP address in each frame's header. Packet Content Mask instructs the Switch to examine the packet header. IPv6 instructs the Switch to examine the IPv6 part of each packet header. |
| Priority | <p>This parameter is specified to re-write the 802.1p default priority previously set in the Switch, which is used to determine the CoS queue to which packets are forwarded to. Once this field is specified, packets accepted by the Switch that match this priority are forwarded to the CoS queue specified previously by the user.</p> <p>Replace priority with – Tick the corresponding check box if you want to re-write the 802.1p default priority of a packet to the value entered in the Priority field, which meets the criteria specified previously in this command, before forwarding it on to the specified CoS queue. Otherwise, a packet will have its incoming 802.1p user priority re-written to its original value before being forwarded by the Switch.</p> <p>For more information on priority queues, CoS queues and mapping for 802.1p, see the QoS section of this manual.</p> |
| Offset | <p>This field will instruct the Switch to mask the packet header beginning with the offset value specified:</p> <ul style="list-style-type: none"> Chunk 1 - Enter a value in hex form to mask the packet from the beginning of the packet to the first chunk. Chunk 2 - Enter a value in hex form to mask the packet from the end of the first chunk to the end of the second chunk. Chunk 3- Enter a value in hex form to mask the packet from the end of the second chunk to the end of the third chunk. Chunk 4 - Enter a value in hex form to mask the packet from the end of the third chunk to the end of the fourth chunk. |
| Port | <p>The Access Rule may be configured on a per-port basis by entering the port number of the switch in the switch stack into this field. When a range of ports is to be configured, the Auto Assign check box MUST be ticked in the Access ID field of this window. If not, the user will be presented with an error message and the access rule will not be configured. The beginning and end of the port list range are separated by a dash. Entering <i>all</i> will denote all ports on the Switch.</p> |
| Rx Rate | <p>Use this to limit Rx bandwidth for the profile being configured. This rate is implemented using the following equation: 1 value = 64kbit/sec. (ex. If the user selects an Rx rate of 10 then the ingress rate is 640kbit/sec.) The user may select a value between 1 and 156249 or <i>No Limit</i>. The default setting is <i>No Limit</i>.</p> |
| Time Range | <p>Tick the check box and enter the name of the Time Range settings that has been previously configured in the Time Range Settings window. This will set specific times when this access rule will be implemented on the Switch.</p> |
| Counter | <p>Tick the check box and use the pull-down menu to employ the Counter that will count the packets identified with this rule. Users must note that if the Counter is employed in the ACL Flow Meter function, the Counter will automatically be disabled here, regardless of this setting.</p> |

To view the settings of a previously correctly configured rule, click [View](#) in the Access Rule Table to view the following window:

| Access Profile Entry Display | |
|---|-------------------------------|
| Profile ID | 2 |
| Type | Packet Content |
| Offset | Chunk 1: 2, Value: 0x00000000 |
| Show All Access Profile Table Entries | |

Figure 10- 17. Access Profile Entry Display window (Packet Content Mask)



NOTE: When using the ACL Mirror function, ensure that the Port Mirroring function is enabled and a target mirror port is set.

To configure the Access Rule for IPv6, open the **Access Profile Table** window and click **Modify** for an IPv6 entry. This will open the following window:

| Access Rule Table | | | | | |
|---|--------|------|-----------|----------------------|----------------------------------|
| Profile ID | Mode | Type | Access ID | Display | Delete |
| 3 | Permit | IPv6 | 1 | View | <input type="button" value="X"/> |
| Show All Access Profile Entries | | | | | |

Figure 10- 18. Access Rule Table window (IPv6)

To remove a previously created rule, click its corresponding button. To add a new Access Rule, click the **Add Rule** button:

| Access Rule Configuration | |
|---------------------------|---|
| Profile ID | 1 |
| Mode | <input checked="" type="radio"/> Permit <input type="radio"/> Mirror <input type="radio"/> Deny |
| Access ID (1-128) | 1 <input type="checkbox"/> Auto assign <input type="checkbox"/> |
| Type | IPv6 |
| Priority (0-7) | <input type="checkbox"/> <input type="text"/> <input type="checkbox"/> Replace Priority |
| Class (0-255) | <input type="text"/> |
| Flow Label (0-FFFFFF) | <input type="text"/> |
| Source IPv6 Address | <input type="text"/> |
| Destination IPv6 Address | <input type="text"/> |
| Port | <input type="text"/> |
| Rx Rate (1-156249) | No Limit <input checked="" type="checkbox"/> <input type="text"/> 1 |
| Time Range | Range Name <input type="checkbox"/> <input type="text"/> |
| Counter | <input type="checkbox"/> State <input type="text"/> Disabled <input type="text"/> |

[Show All Access Rule Entries](#)

Figure 10- 19. Access Rule Configuration window (IPv6)

To set the Access Rule for the IPv6, adjust the following parameters and click **Apply**.

| Parameter | Description |
|--------------------------|--|
| Profile ID | This is the identifier number for this profile set. |
| Mode | Select <i>Permit</i> to specify that the packets that match the access profile are forwarded by the Switch, according to any additional rule added (see below). Select <i>Deny</i> to specify that packets that match the access profile are not forwarded by the Switch and will be filtered. Select <i>Mirror</i> to specify that packets that match the access profile are mirrored to a port defined in the Port Mirroring window. Port Mirroring must be enabled and a target port must be set. |
| Access ID (1-128) | Type in a unique identifier number for this access rule. This value can be set from 1 to 128. <ul style="list-style-type: none"> Auto Assign – Ticking this check box will instruct the Switch to automatically assign an Access ID for the rule being created. |
| Type | Selected profile based on Ethernet (MAC Address), IP address, Packet Content, or IPv6 address. <ul style="list-style-type: none"> Ethernet instructs the Switch to examine the layer 2 part of each packet header. IP instructs the Switch to examine the IP address in each frame's header. Packet Content Mask instructs the Switch to examine the packet header. IPv6 instructs the Switch to examine the IPv6 address in each frame's header. |
| Priority (0-7) | This parameter is specified to re-write the 802.1p default priority previously set in the Switch, which is used to determine the CoS queue to which packets are forwarded to. Once this field is specified, packets accepted by the Switch that match this priority are forwarded to the CoS queue specified previously by the user. replace priority – Tick the corresponding check box to re-write the 802.1p default priority of a packet to the value entered in the Priority field, which meets the criteria specified previously in this command, before forwarding it on to the specified CoS queue. Otherwise, a packet will have its |

| | |
|---------------------------------|---|
| | incoming 802.1p user priority re-written to its original value before being forwarded by the Switch. For more information on priority queues, CoS queues and mapping for 802.1p, see the QoS section of this manual. |
| Class (0-255) | Entering a value between 0 and 255 will instruct the Switch to examine the class field of the IPv6 header. This class field is a part of the packet header that is similar to the Type of Service (ToS) or Precedence bits field of IPv4. |
| Flow Label (0-FFFFF) | Configuring this field, in hex form, will instruct the Switch to examine the flow label field of the IPv6 header. This flow label field is used by a source to label sequences of packets such as non-default quality of service or real time service packets. |
| Source IPv6 Address | The user may specify an IP address mask for the source IPv6 address by entering the IP address mask, in hex form. |
| Destination IPv6 Address | The user may specify an IP address mask for the destination IPv6 address by and entering the IP address mask, in hex form. |
| Port | The Access Rule may be configured on a per-port basis by entering the port number of the Switch. |
| Rx Rate (1-156249) | Use this to limit Rx bandwidth for the profile being configured. This rate is implemented using the following equation: 1 value = 64kbit/sec. (ex. If the user selects an Rx rate of 10 then the ingress rate is 640kbit/sec.) The user may select a value between 1 and 156249 or <i>No Limit</i> . The default setting is <i>No Limit</i> . |
| Time Range | Tick the check box and enter the name of the Time Range settings that has been previously configured in the Time Range Settings window. This will set specific times when this access rule will be implemented on the Switch. |
| Counter | Tick the check box and use the pull-down menu to employ the Counter that will count the packets identified with this rule. Users must note that if the Counter is employed in the ACL Flow Meter function, the Counter will automatically be disabled here, regardless of this setting. |

To view the settings of a previously correctly configured rule, click [View](#) in the **Access Rule Table** to view the following window:

| Access Profile Entry Display | |
|---|---------|
| Profile ID | 1 |
| Owner | ACL |
| Type | IPv6 |
| Class | ----- |
| Flow Label | Enabled |
| Source IPv6 Mask | ----- |
| Destination IPv6 Mask | ----- |
| Show All Access Profile Table Entries | |

Figure 10- 20. Access Profile Entry Display window (IPv6)

ACL Flow Meter

Before configuring the ACL Flow Meter, here is a list of acronyms and terms users will need to know.

trTCM – Two Rate Three Color Marker. This, along with the srTCM, are two methods available on the switch for metering and marking packet flow. The trTCM meters and IP flow and marks it as a color based on the flow's surpassing of two rates, the CIR and the PIR.

CIR – Committed Information Rate. Common to both the trTCM and the srTCM, the CIR is measured in bytes of IP packets. IP packet bytes are measured by taking the size of the IP header but not the link specific headers. For the trTCM, the packet flow is marked green if it doesn't exceed the CIR and yellow if it does. The configured rate of the CIR must not exceed that of the PIR. The CIR can also be configured for unexpected packet bursts using the CBS and PBS fields.

CBS – Committed Burst Size. Measured in bytes, the CBS is associated with the CIR and is used to identify packets that exceed the normal boundaries of packet size. The CBS should be configured to accept the biggest IP packet that is expected in the IP flow.

PIR – Peak Information Rate. This rate is measured in bytes of IP packets. IP packet bytes are measured by taking the size of the IP header but not the link specific headers. If the packet flow exceeds the PIR, that packet flow is marked red. The PIR must be configured to be equal or more than that of the CIR.

PBS – Peak Burst Size. Measured in bytes, the PBS is associated with the PIR and is used to identify packets that exceed the normal boundaries of packet size. The PBS should be configured to accept the biggest IP packet that is expected in the IP flow.

srTCM – Single Rate Three Color Marker. This, along with the trTCM, are two methods available on the switch for metering and marking packet flow. The srTCM marks its IP packet flow based on the configured CBS and EBS. A packet flow that does not reach the CBS is marked green, if it exceeds the CBS but not the EBS its marked yellow, and if it exceeds the EBS its marked red.

CBS – Committed Burst Size. Measured in bytes, the CBS is associated with the CIR and is used to identify packets that exceed the normal boundaries of packet size. The CBS should be configured to accept the biggest IP packet that is expected in the IP flow.

EBS – Excess Burst Size. Measured in bytes, the EBS is associated with the CIR and is used to identify packets that exceed the boundaries of the CBS packet size. The EBS is to be configured for an equal or larger rate than the CBS.

DSCP – Differentiated Services Code Point. The part of the packet header where the color will be added. Users may change the DSCP field of incoming packets.

The ACL Flow Meter function will allow users to color code IP packet flows based on the rate of incoming packets. Users have two types of Flow metering to choose from, trTCM and srTCM, as explained previously. When a packet flow is placed in a color code, the user can choose what to do with packets that have exceeded that color-coded rate.

Green – When an IP flow is in the green mode, its configurable parameters can be set in the Conform field, where the packets can have their DSCP field changed. This is an acceptable flow rate for the ACL Flow Meter function.

Yellow – When an IP flow is in the yellow mode, its configurable parameters can be set in the Exceed field. Users may choose to either **Permit** or **Drop** exceeded packets. Users may also choose to change the DSCP field of the packets.

Red – When an IP flow is in the red mode, its configurable parameters can be set in the Exceed field. Users may choose to either **Permit** or **Drop** exceeded packets. Users may also choose to change the DSCP field of the packets.

Users may also choose to count exceeded packets by clicking the **Counter** check box. If the counter is enabled, the counter setting in the access profile will be disabled. Users may only enable two counters for one flow meter at any given time.

To view this window, click **ACL > ACL Flow Meter**, as shown below.

| | |
|----------------|--|
| | <p>following parameters to determine the color rate of the IP packet flow.</p> <p>CIR – The Committed Information Rate can be set between 1 and 156249. IP flow rates at or below this level will be considered green. IP flow rates that exceed this rate but not the PIR rate are considered yellow.</p> <p>PIR – The Peak information Rate. IP flow rates that exceed this setting will be considered as red. This field must be set at an equal or higher value than the CIR.</p> <p>CBS – The Committed Burst Size. Used to gauge packets that are larger than the normal IP packets. Click the check box to employ the CBS. This field does not have to be set for this feature to function properly but is to be used in conjunction with the CIR setting. The CBS should be configured to accept the biggest IP packet that is expected in the IP flow.</p> <p>PBS - The Peak Burst Size. This optional field is to be used in conjunction with the PIR. The PBS should be configured to accept the biggest IP packet that is expected in the IP flow.</p> |
| srTCM | <p>Choosing this field will allow users to employ the Single Rate Three Color Mode and set the following parameters to determine the color rate of the IP packet flow.</p> <p>CIR – The Committed Information Rate can be set between 1 and 156249. The color rates are based on the following two fields which are used in conjunction with the CIR.</p> <p>CBS – Committed Burst Size. Measured in bytes, the CBS is associated with the CIR and is used to identify packets that exceed the normal boundaries of packet size. The CBS should be configured to accept the biggest IP packet that is expected in the IP flow. Packet flows that are lower than this configured value are marked green. Packet flows that exceed this value but are less than the EBS value are marked yellow.</p> <p>EBS – Excess Burst Size. Measured in bytes, the EBS is associated with the CIR and is used to identify packets that exceed the boundaries of the CBS packet size. The EBS is to be configured for an equal or larger rate than the CBS. Packet flows that exceed this value are marked as red.</p> |
| Action | <p>This field is used to determine the course of action when a packet flow has been marked as a color, based on the following fields.</p> |
| Conform | <p>This field denotes the green packet flow. Green packet flows may have their DSCP field rewritten to a value stated in this field. Users may also choose to count green packets by ticking the Counter check box.</p> |
| Exceed | <p>This field denotes the yellow packet flow. Yellow packet flows may have excess packets permitted through or dropped. Users may replace the DSCP field of these packets by checking its radio button and entering a new DSCP value in the allotted field. Users may also choose to count yellow packets by ticking the Counter check box.</p> |
| Violate | <p>This field denotes the red packet flow. Red packet flows may have excess packets permitted through or dropped. Users may replace the DSCP field of these packets by checking its radio button and entering a new DSCP value in the allotted field. Users may also choose to count yellow packets by ticking the Counter check box.</p> |

Click **Apply** to save changes made. To view the ACL Flow Meter configurations for a particular Profile and Access ID, click its corresponding View button, as seen in the **ACL Flow Meter Table** window that will display the following read-only window.

| ACL Flow Meter Display | | |
|------------------------|-----------------|---------------------|
| Profile ID | 1 | |
| Access ID | 1 | |
| Mode | trTCM | CIR: 100000 (Kbps) |
| | | PIR: 120000 (Kbps) |
| | | CBS: 11100 (Kbyte) |
| | | PBS: 12100 (Kbyte) |
| Action | Conform: Permit | Replace DSCP: ----- |
| | | Counter: Disable |
| | Exceed: Permit | Replace DSCP: ----- |
| | | Counter: Disable |
| | Violate: Permit | Replace DSCP: ----- |
| | | Counter: Disable |

[Show All ACL Flow Meter Entries](#)

Figure 10- 23. ACL Flow Meter Display window

CPU Interface Filtering

Due to a chipset limitation and the need for extra switch security, the Switch incorporates CPU Interface filtering. This added feature increases the running security of the Switch by enabling the user to create a list of access rules for packets destined for the Switch’s CPU interface. Employed similarly to the Access Profile feature previously mentioned, CPU interface filtering examines Ethernet, IP, Packet Content Mask and IPv6 packet headers destined for the CPU and will either forward them or filter them, based on the user’s implementation. As an added feature for the CPU Filtering, the Switch allows the CPU filtering mechanism to be enabled or disabled globally, permitting the user to create various lists of rules without immediately enabling them.

Creating an access profile for the CPU is divided into two basic parts. The first is to specify which part or parts of a frame the Switch will examine, such as the MAC source address or the IP destination address. The second part is entering the criteria the Switch will use to determine what to do with the frame. The entire process is described below.

CPU Interface Filtering State Settings

In the following window, the user may globally enable or disable the CPU Interface Filtering mechanism by using the pull-down menu to change the running state.

To view this window, click **ACL > CPU Interface Filtering > CPU Interface Filtering State**, as shown below.

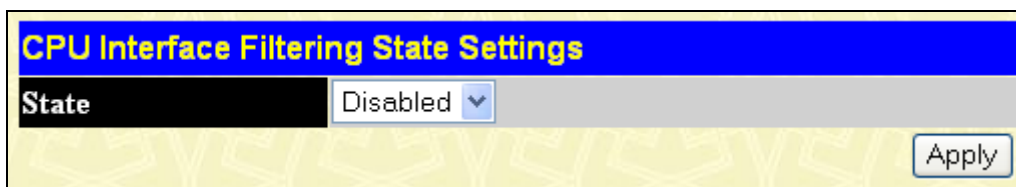

Figure 10- 24. CPU Interface Filtering State Settings window

Choose *Enabled* to enable CPU packets to be scrutinized by the Switch and *Disabled* to disallow this scrutiny.

CPU Interface Filtering Table

This window allows the user to create a new profile for the CPU Interface Filtering Table.

To view this window, click **ACL > CPU Interface Filtering > CPU Interface Filtering Table**, as shown below.

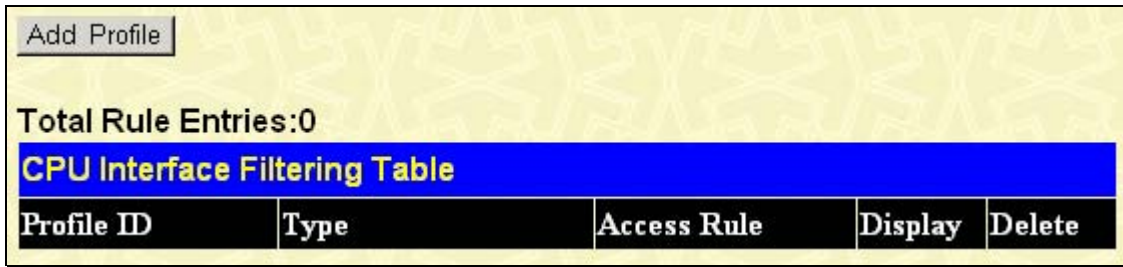

Figure 10- 25. CPU Interface Filtering Table window

To add an entry to the CPU Interface Filtering Table, click the **Add Profile** button. This will open the **CPU Interface Filtering Profile Configuration** window, as shown below. There are four **CPU Access Profile Configuration** windows; one for Ethernet (or MAC address-based) profile configuration, one for IP address-based profile configuration, one for the Packet Content Mask and one for IPv6. Users can switch between the four **CPU Access Profile Configuration** windows by using the Type drop-down menu. The window shown below is the **CPU Interface Filtering Configuration** window for Ethernet.

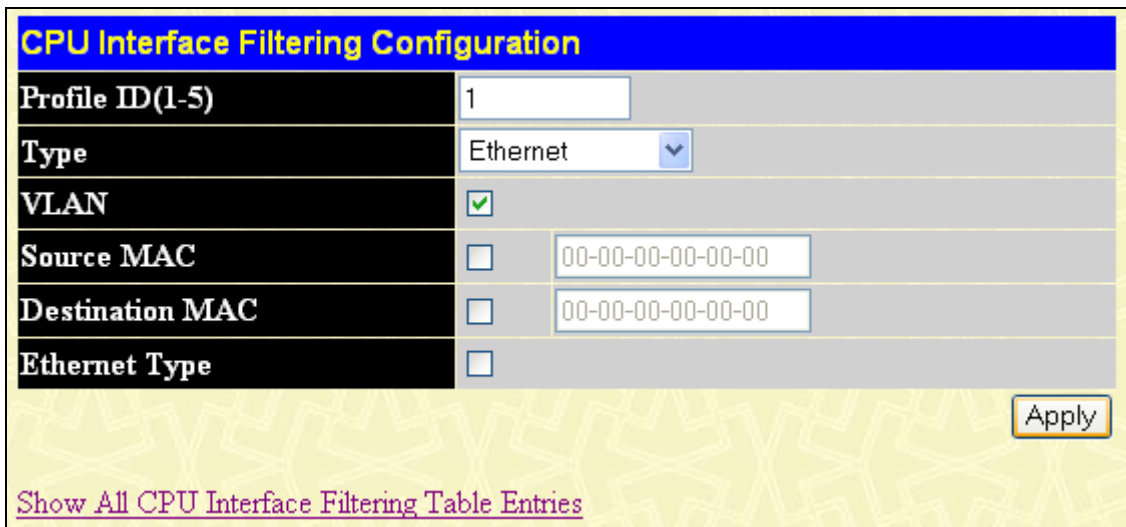

Figure 10- 26. CPU Interface Filtering Configuration window (Ethernet)

| Parameter | Description |
|-------------------------|---|
| Profile ID (1-5) | Type in a unique identifier number for this profile set. This value can be set from 1 to 5. |
| Type | Select profile based on <i>Ethernet</i> (MAC Address), <i>IP</i> address or <i>Packet Content Mask</i> or <i>IPv6</i> address. This will change the menu according to the requirements for the type of profile. <ul style="list-style-type: none"> • Select <i>Ethernet</i> to instruct the Switch to examine the layer 2 part of each packet header. • Select <i>IP</i> to instruct the Switch to examine the IP address in each frame's header. • Select <i>Packet Content Mask</i> to specify a mask to hide the content of the packet header. • Select <i>IPv6</i> to instruct the Switch to examine the IPv6 address in each frame's header. |
| VLAN | Selecting this option instructs the Switch to examine the VLAN identifier of each packet header and use this as the full or partial criterion for forwarding. |
| Source MAC | Source MAC Mask - Enter a MAC address mask for the source MAC address. |
| Destination MAC | Destination MAC Mask - Enter a MAC address mask for the destination MAC address. |
| Ethernet type | Selecting this option instructs the Switch to examine the Ethernet type value in each frame's header. |

Click **Apply** to set this entry in the Switch's memory.

The window shown below is the **CPU Interface Filtering Configuration** for IP window.

Figure 10- 27. CPU Interface Filtering Configuration window (IP)

The following parameters can be modified:

| Parameter | Description |
|----------------------------|---|
| Profile ID (1-5) | Type in a unique identifier number for this profile set. This value can be set from 1 to 5. |
| Type | Select profile based on <i>Ethernet</i> (MAC Address), <i>IP</i> address or <i>Packet Content Mask</i> or <i>IPv6</i> address. This will change the menu according to the requirements for the type of profile. <ul style="list-style-type: none"> Select <i>Ethernet</i> to instruct the Switch to examine the layer 2 part of each packet header. Select <i>IP</i> to instruct the Switch to examine the IP address in each frame's header. Select <i>Packet Content Mask</i> to specify a mask to hide the content of the packet header. Select <i>IPv6</i> to instruct the Switch to examine the IPv6 address in each frame's header. |
| VLAN | Selecting this option instructs the Switch to examine the VLAN part of each packet header and use this as the criterion, or part of the criterion for forwarding. |
| Source IP Mask | Enter an IP address mask for the source IP address. |
| Destination IP Mask | Enter an IP address mask for the destination IP address. |
| DSCP | Selecting this option instructs the Switch to examine the DiffServ Code part of each packet |

| | |
|-----------------|--|
| | header and use this as the, or part of the criterion for forwarding. |
| Protocol | <p>Selecting this option instructs the Switch to examine the protocol type value in each frame's header. You must then specify what protocol(s) to include according to the following guidelines:</p> <p>Select ICMP to instruct the Switch to examine the Internet Control Message Protocol (ICMP) field in each frame's header.</p> <ul style="list-style-type: none"> • Select Type to further specify that the access profile will apply an ICMP type value, or specify Code to further specify that the access profile will apply an ICMP code value. <p>Select IGMP to instruct the Switch to examine the Internet Group Management Protocol (IGMP) field in each frame's header.</p> <ul style="list-style-type: none"> • Select Type to further specify that the access profile will apply an IGMP type value. <p>Select TCP to use the TCP port number contained in an incoming packet as the forwarding criterion. Selecting TCP requires that you specify a source port mask and/or a destination port mask. The user may also identify which flag bits to filter. Flag bits are parts of a packet that determine what to do with the packet. The user may filter packets by filtering certain flag bits within the packets, by checking the boxes corresponding to the flag bits of the TCP field. The user may choose between urg (urgent), ack (acknowledgement), psh (push), rst (reset), syn (synchronize), fin (finish).</p> <ul style="list-style-type: none"> • src port mask - Specify a TCP port mask for the source port in hex form (hex 0x0-0xffff), which you wish to filter. • dst port mask - Specify a TCP port mask for the destination port in hex form (hex 0x0-0xffff) which you wish to filter. <p>Select UDP to use the UDP port number contained in an incoming packet as the forwarding criterion. Selecting UDP requires that you specify a source port mask and/or a destination port mask.</p> <ul style="list-style-type: none"> • src port mask - Specify a UDP port mask for the source port in hex form (hex 0x0-0xffff). • dst port mask - Specify a UDP port mask for the destination port in hex form (hex 0x0-0xffff). <p>Protocol id - Enter a value defining the protocol ID in the packet header to mask. Specify the protocol ID mask in hex form (hex 0x0-0xff).</p> |

Click **Apply** to set this entry in the Switch's memory.

The window shown below is the **CPU Interface Filtering Configuration** window for the Packet Content Mask.

Figure 10- 28. CPU Interface Filtering Configuration window (Packet Content)

This window will aid the user in configuring the Switch to mask packet headers beginning with the offset value specified. The following fields are used to configure the Packet Content Mask:

| Parameter | Description |
|-------------------------|---|
| Profile ID (1-5) | Type in a unique identifier number for this profile set. This value can be set from 1 to 5. |
| Type | <p>Select profile based on <i>Ethernet</i> (MAC Address), <i>IP</i> address or <i>Packet Content Mask</i> or <i>IPv6</i> address. This will change the menu according to the requirements for the type of profile.</p> <ul style="list-style-type: none"> Select <i>Ethernet</i> to instruct the Switch to examine the layer 2 part of each packet header. Select <i>IP</i> to instruct the Switch to examine the IP address in each frame's header. Select <i>Packet Content Mask</i> to specify a mask to hide the content of the packet header. |

| | |
|---------------|--|
| | <ul style="list-style-type: none"> Select <i>IPv6</i> to instruct the Switch to examine the IPv6 address in each frame's header. |
| Offset | <p>This field will instruct the Switch to mask the packet header beginning with the offset value specified:</p> <ul style="list-style-type: none"> value (0-15) – Enter a value in hex form to mask the packet from the beginning of the packet to the 15th byte. value (16-31) – Enter a value in hex form to mask the packet from byte 16 to byte 31. value (32-47) – Enter a value in hex form to mask the packet from byte 32 to byte 47. value (48-63) – Enter a value in hex form to mask the packet from byte 48 to byte 63. value (64-79) – Enter a value in hex form to mask the packet from byte 64 to byte 79. |

Click **Apply** to implement changes made.

The window shown below is the IPv6 configuration window.

Figure 10- 29. CPU Interface Filtering Configuration window (IPv6)

The following fields are used to configure the Packet Content Mask:

| Parameter | Description |
|-------------------|--|
| Profile ID | This is the identifier number for this profile set. Up to five profile ID configurations can be created. |
| Type | <p>Selected profile based on <i>Ethernet</i> (MAC Address), <i>IP</i> address, <i>Packet Content Mask</i> or <i>IPv6</i>.</p> <ul style="list-style-type: none"> <i>Ethernet</i> instructs the Switch to examine the layer 2 part of each packet header. <i>IP</i> instructs the Switch to examine the IP address in each frame's header. <i>Packet Content Mask</i> instructs the Switch to examine the packet header. <i>IPv6</i> instructs the Switch to examine the IPv6 part of each packet header. |
| Class | Tick this check box to instruct the Switch to examine the class field of the IPv6 header. This class field is a part of the packet header that is similar to the Type of Service (ToS) or Precedence bits field of IPv4. |
| Flow Label | Configuring this field, in hex form, will instruct the Switch to examine the flow label field of the IPv6 header. This flow label field is used by a source to label sequences of packets such as non-default quality of service or real time service packets. |

| | |
|---------------------------------|--|
| Source IPv6 Address | The user may specify an IP address mask for the source IPv6 address by entering the IP address mask, in hex form. |
| Destination IPv6 Address | The user may specify an IP address mask for the destination IPv6 address by and entering the IP address mask, in hex form. |

Click Apply to implement changes made.

To establish the rule for a previously created CPU Access Profile:

To view this window, click **ACL > CPU Interface Filtering > CPU Interface Filtering Table**, as shown below.

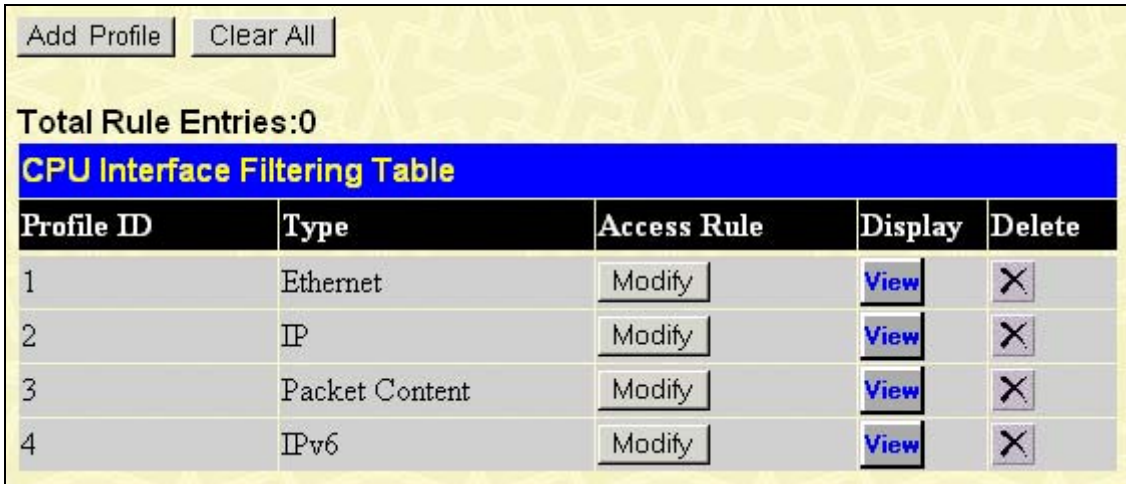

Figure 10- 30. CPU Interface Filtering Table window - Add

In this window, the user may add a rule to a previously created CPU access profile by clicking the corresponding **Add Rule** button of the entry to configure Ethernet, IPv4, Packet Content Mask, or IPv6.

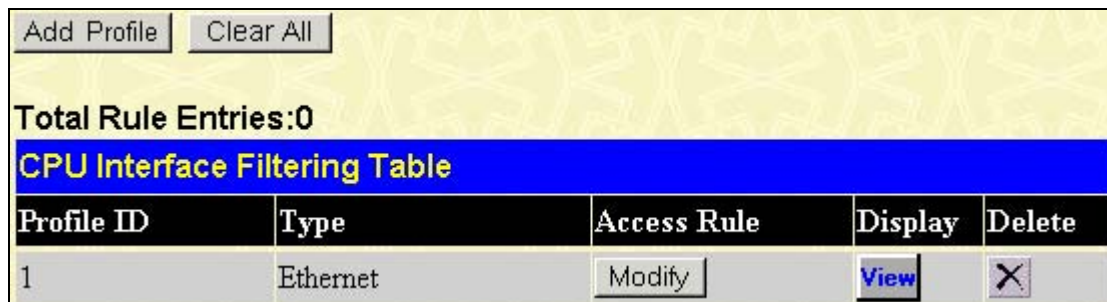

Figure 10- 31. CPU Interface Filtering Rule Table window

Click the **Add Rule** button to continue on to the **CPU Interface Filtering Rule Table** window. A new and unique window, for Ethernet, IP, Packet Content and IPv6 will open as shown in the examples below.

To change a rule for a previously created CPU Access Profile Rule:

The **CPU Interface Filtering Rule Configuration** window allows the user to create a rule for a previously created CPU Access Profile.

| CPU Interface Filtering Rule Configuration | |
|--|--|
| Profile ID | 1 |
| Mode | <input checked="" type="radio"/> Permit <input type="radio"/> Deny |
| Access ID(1-100) | 1 |
| Type | Ethernet |
| VLAN Name | |
| Source MAC | 00-00-00-00-00-00 |
| Destination MAC | 00-00-00-00-00-00 |
| Ethernet Type | 0000 |
| Port | |
| Time Range | Range Name <input type="checkbox"/> <input type="text"/> |

[Show All CPU Interface Filtering Rule Entries](#)

Figure 10- 32. CPU Interface Filtering Rule Configuration window (Ethernet)

To set the CPU Access Rule for Ethernet, adjust the following parameters and click **Apply**.

| Parameters | Description |
|------------------------|--|
| Profile ID | This is the identifier number for this profile set. |
| Mode | Select Permit to specify that the packets that match the access profile are forwarded by the Switch, according to any additional rule added (see below). Select Deny to specify that packets that do not match the access profile are not forwarded by the Switch and will be filtered. |
| Access ID | Type in a unique identifier number for this access and priority. This value can be set from 1 to 100. |
| Type | Selected profile based on Ethernet (MAC Address), IP address, Packet Content Mask or IPv6. <ul style="list-style-type: none"> Ethernet instructs the Switch to examine the layer 2 part of each packet header. IP instructs the Switch to examine the IP address in each frame's header. Packet Content Mask instructs the Switch to examine the packet header. IPv6 instructs the Switch to examine the IPv6 part of the packet header. |
| VLAN Name | Allows the entry of a name for a previously configured VLAN. |
| Source MAC | Source MAC Address – Enter a MAC Address for the source MAC address. |
| Destination MAC | Destination MAC Address – Enter a MAC Address mask for the destination MAC address. |
| 802.1p (0-7) | Enter a value from 0 to 7 to specify that the access profile will apply only to packets with this 802.1p priority value. |
| Ethernet Type | Specifies that the access profile will apply only to packets with this hexadecimal 802.1Q Ethernet type value (hex 0x0-0xffff) in the packet header. The Ethernet type value may be set in the form: hex 0x0-0xffff, which means the user may choose any combination of letters and numbers ranging from a-f and from 0-9. |

| | |
|-------------------|---|
| Port | The CPU Access Rule may be configured on a per-port basis by entering the port number of the Switch. |
| Time Range | Click the check box and enter the name of the Time Range settings that has been previously configured in the Time Range Settings window. This will set specific times when this CPU access rule will be implemented on the Switch. |

To view the settings of a previously configured rule, click [View](#) in the Access Rule Table to view the following window:

| CPU Interface Filtering Rule Display | |
|--------------------------------------|----------|
| Profile ID | 1 |
| Access ID | 1 |
| Mode | Permit |
| Type | Ethernet |
| VLAN Name | RG |
| Source MAC | ----- |
| Destination MAC | ----- |
| Ethernet Type | ----- |
| Port | 1:3 |

[Show All CPU Interface Filtering Rule Entries](#)

Figure 10- 33. CPU Interface Filtering Rule Display window (Ethernet)

The following window is the **CPU Interface Filtering Rule Table** for IP.

| CPU Interface Filtering Rule Table | | | | | |
|------------------------------------|--------|------|-----------|----------------------|----------------------------------|
| Profile ID | Mode | Type | Access ID | Display | Delete |
| 2 | Permit | IP | 1 | View | <input type="button" value="X"/> |

[Show All CPU Interface Filtering Entries](#)

Figure 10- 34. CPU Interface Filtering Rule Table window (IP)

To create a new rule set for an access profile click the **Add** button. A new window is displayed. To remove a previously created rule, click the corresponding button. The following window is used for the CPU IP Rule configuration.

| CPU Interface Filtering Rule Configuration | |
|--|--|
| Profile ID | 2 |
| Mode | <input checked="" type="radio"/> Permit <input type="radio"/> Deny |
| Access ID(1-100) | 1 |
| Type | IP |
| VLAN Name | <input type="text"/> |
| Source IP | 0.0.0.0 |
| Destination IP | 0.0.0.0 |
| DSCP(0-63) | 0 |
| Port | <input type="text"/> |
| Time Range | Range Name <input type="checkbox"/> <input type="text"/> |

[Show All CPU Interface Filtering Rule Entries](#)

Figure 10- 35. CPU Interface Filtering Rule Configuration window (IP)

Configure the following Access Rule Configuration settings for IP:

| Parameter | Description |
|-----------------------|--|
| Profile ID | This is the identifier number for this profile set. |
| Mode | Select Permit to specify that the packets that match the access profile are forwarded by the Switch, according to any additional rule added (see below). Select Deny to specify that packets that do not match the access profile are not forwarded by the Switch and will be filtered. |
| Access ID | Type in a unique identifier number for this access and priority. This value can be set from 1 to 100. |
| Type | Selected profile based on Ethernet (MAC Address), IP address, Packet Content Mask or IPv6. <ul style="list-style-type: none"> Ethernet instructs the Switch to examine the layer 2 part of each packet header. IP instructs the Switch to examine the IP address in each frame's header. Packet Content Mask instructs the Switch to examine the packet header. IPv6 instructs the Switch to examine the IPv6 part of the packet header. |
| VLAN Name | Allows the entry of a name for a previously configured VLAN. |
| Source IP | Source IP Address - Enter an IP Address mask for the source IP address. |
| Destination IP | Destination IP Address- Enter an IP Address mask for the destination IP address. |
| DSCP (0-63) | This field allows the user to enter a DSCP value in the space provided, which will instruct the Switch to examine the DiffServ Code part of each packet header and use this as the, or part of the criterion for forwarding. The user may choose a value between 0 and 63. |
| Port | The CPU Access Rule may be configured on a per-port basis by entering the port number of the Switch. |
| Time Range | Click the check box and enter the name of the Time Range settings that has been previously configured in the Time Range Settings window. This will set specific times when this CPU |

access rule will be implemented on the Switch.

To view the settings of a previously correctly configured rule, click [View](#) in the **Access Rule Table** to view the following window:

| | |
|-------------------------|--|
| Profile ID | 2 |
| Mode | <input checked="" type="radio"/> Permit <input type="radio"/> Deny |
| Access ID(1-100) | 1 |
| Type | IP |
| VLAN Name | |
| Source IP | 0.0.0.0 |
| Destination IP | 0.0.0.0 |
| DSCP(0-63) | 0 |
| Port | |
| Time Range | Range Name <input type="checkbox"/> <input type="button" value="v"/> |

[Show All CPU Interface Filtering Rule Entries](#)

Figure 10- 36. CPU Interface Filtering Rule Display window (IP)

The following window is the CPU Interface Filtering Rule Table for Packet Content.

| Profile ID | Mode | Type | Access ID | Display | Delete |
|------------|--------|----------------|-----------|-------------------------------------|----------------------------------|
| 1 | Permit | Packet Content | 1 | <input type="button" value="View"/> | <input type="button" value="X"/> |

[Show All CPU Interface Filtering Entries](#)

Figure 10- 37. CPU Interface Filtering Rule Table window (Packet Content)

To remove a previously created rule, select it and click the button. To add a new CPU Access Rule, click the **Add** button:

| CPU Interface Filtering Rule Configuration | | | | | |
|--|--|--|---------------|---------------|---------------|
| Profile ID | 3 | | | | |
| Mode | <input checked="" type="radio"/> Permit <input type="radio"/> Deny | | | | |
| Access ID(1-100) | 1 | | | | |
| Type | Packet Content | | | | |
| Offset | <input type="checkbox"/> value(0-15) | mask 00000000 | mask 00000000 | mask 00000000 | mask 00000000 |
| | <input type="checkbox"/> value(16-31) | mask 00000000 | mask 00000000 | mask 00000000 | mask 00000000 |
| | <input type="checkbox"/> value(32-47) | mask 00000000 | mask 00000000 | mask 00000000 | mask 00000000 |
| | <input type="checkbox"/> value(48-63) | mask 00000000 | mask 00000000 | mask 00000000 | mask 00000000 |
| | <input type="checkbox"/> value(64-79) | mask 00000000 | mask 00000000 | mask 00000000 | mask 00000000 |
| | Port | | | | |
| | Time Range | Range Name <input type="checkbox"/> <input type="button" value="v"/> | | | |
| | <input type="button" value="Apply"/> | | | | |
| | Show All CPU Interface Filtering Rule Entries | | | | |

Figure 10- 38. CPU Interface Filtering Rule Configuration window (Packet Content Mask)

To set the Access Rule for Ethernet, adjust the following parameters and click **Apply**.

| Parameters | Description |
|------------|--|
| Profile ID | This is the identifier number for this profile set. |
| Mode | Select Permit to specify that the packets that match the access profile are forwarded by the Switch, according to any additional rule added (see below). Select Deny to specify that packets that do not match the access profile are not forwarded by the Switch and will be filtered. |

| | |
|-------------------|---|
| Access ID | Type in a unique identifier number for this access. This value can be set from 1 to 100. |
| Type | Selected profile based on Ethernet (MAC Address), IP address, Packet Content Mask, or IPv6. <ul style="list-style-type: none"> Ethernet instructs the Switch to examine the layer 2 part of each packet header. IP instructs the Switch to examine the IP address in each frame's header. Packet Content Mask instructs the Switch to examine the packet header. IPv6 instructs the Switch to examine the IPv6 part of the packet header. |
| Offset | This field will instruct the Switch to mask the packet header beginning with the offset value specified: <ul style="list-style-type: none"> value (0-15) - Enter a value in hex form to mask the packet from the beginning of the packet to the 15th byte. value (16-31) - Enter a value in hex form to mask the packet from byte 16 to byte 31. value (32-47) - Enter a value in hex form to mask the packet from byte 32 to byte 47. value (48-63) - Enter a value in hex form to mask the packet from byte 48 to byte 63. value (64-79) - Enter a value in hex form to mask the packet from byte 64 to byte 79. |
| Port | The CPU Access Rule may be configured on a per-port basis by entering the port number of the Switch. |
| Time Range | Click the check box and enter the name of the Time Range settings that has been previously configured in the Time Range Settings window. This will set specific times when this CPU access rule will be implemented on the Switch. |

To view the settings of a previously correctly configured rule, click [View](#) in the **Access Rule Table** to view the following window:

| CPU Interface Filtering Entry Display | |
|--|---|
| Profile ID | 3 |
| Type | Packet Content |
| Offset 0-15 | 0x00000000 0x00000000 0x00000000 0x00000000 |
| Offset 16-31 | ----- |
| Offset 32-47 | ----- |
| Offset 64-79 | ----- |
| Show All CPU Interface Filtering Table Entries | |

Figure 10- 39. CPU Interface Filtering Entry Display window (Packet Content)

The following window is the CPU Access Rule Table for IPv6.

| CPU Access Rule Table | | | | | |
|-----------------------|--------|------|-----------|----------------------|-------------------|
| Profile ID | Mode | Type | Access ID | Display | Delete |
| 4 | Permit | IPv6 | 2 | View | X |

[Add](#)

[Show All CPU Access Profile Entries](#)

Figure 10- 40. CPU Access Rule Table window (IPv6)

To create a new rule set for an access profile click the **Add** button. A new window is displayed. To remove a previously created rule, click the corresponding [X](#) button. The following window is used for the CPU IP Rule configuration.

| CPU Interface Filtering Rule Configuration | |
|--|--|
| Profile ID | 5 |
| Mode | <input checked="" type="radio"/> Permit <input type="radio"/> Deny |
| Access ID(1-100) | 1 |
| Type | IPv6 |
| Class (0-255) | |
| Flow Label (0-FFFFFF) | 00000 |
| Source IPv6 Address | 0000:0000:0000:0000:0000:0000 |
| Destination IPv6 Address | 0000:0000:0000:0000:0000:0000 |
| Port | |
| Time Range | Range Name <input type="checkbox"/> <input type="button" value="v"/> |

[Apply](#)

[Show All CPU Interface Filtering Rule Entries](#)

Figure 10- 41. CPU Interface Filtering Rule Configuration window (IPv6)

The following parameters may be viewed or modified:

| Parameter | Description |
|--------------------------|---|
| Profile ID | This is the identifier number for this profile set. |
| Mode | Select <i>Permit</i> to specify that the packets that match the access profile are forwarded by the Switch, according to any additional rule added (see below). Select <i>Deny</i> to specify that packets that match the access profile are not forwarded by the Switch and will be filtered. |
| Access ID (1-100) | Type in a unique identifier number for this access. This value can be set from 1 to 100. |
| Type | Selected profile based on Ethernet (MAC Address), IP address, Packet Content or IPv6. <ul style="list-style-type: none"> Ethernet instructs the Switch to examine the layer 2 part of each packet header. IP instructs the Switch to examine the IP address in each frame's header. |

| | |
|---------------------------------|--|
| | <ul style="list-style-type: none"> • Packet Content Mask instructs the Switch to examine the packet header. • IPv6 instructs the Switch to examine the IPv6 part of each packet header. |
| Class (0-255) | Entering a value between 0 and 255 will instruct the Switch to examine the class field of the IPv6 header. This class field is a part of the packet header that is similar to the Type of Service (ToS) or Precedence bits field of IPv4. |
| Flow Label (0-FFFFFF) | Configuring this field, in hex form, will instruct the Switch to examine the flow label field of the IPv6 header. This flow label field is used by a source to label sequences of packets such as non-default quality of service or real time service packets. |
| Source IPv6 Address | The user may specify an IP address mask for the source IPv6 address by entering the IP address mask, in hex form. |
| Destination IPv6 Address | The user may specify an IP address mask for the destination IPv6 address by and entering the IP address mask, in hex form. |
| Port | The CPU Access Rule may be configured on a per-port basis by entering the port number of the Switch. |
| Time Range | Tick the check box and enter the name of the Time Range settings that has been previously configured in the Time Range Settings window. This will set specific times when this CPU access rule will be implemented on the Switch. |

To view the settings of a previously correctly configured rule, click [View](#) in the **CPU Access Rule Table** to view the following window:

| CPU Interface Filtering Rule Display | |
|---|--------|
| Profile ID | 5 |
| Access ID | 5 |
| Mode | Permit |
| Type | IPv6 |
| Class | ----- |
| Flow Label | 0x0 |
| Source IPv6 | ----- |
| Destination IPv6 | ----- |
| Port | 1:3 |
| Show All CPU Interface Filtering Rule Entries | |

Figure 10- 42. CPU Interface Filtering Rule Display window (IPv6)

Section 11

Security

Traffic Control

Port Security

IP-MAC-Port Binding

802.1X

Web Authentication

Trust Host

Access Authentication Control

MAC Based Access Control

Safeguard Engine

Traffic Segmentation

SSL

SSH

Traffic Control

On a computer network, packets such as Multicast packets and Broadcast packets continually flood the network as normal procedure. At times, this traffic may increase do to a malicious endstation on the network or a malfunctioning device, such as a faulty network card. Thus, switch throughput problems will arise and consequently affect the overall performance of the switch network. To help rectify this packet storm, the Switch will monitor and control the situation.

The packet storm is monitored to determine if too many packets are flooding the network, based on the threshold level provided by the user. Once a packet storm has been detected, the Switch will drop packets coming into the Switch until the storm has subsided. This method can be utilized by selecting the *Drop* option of the Action field in the window below.

The Switch will also scan and monitor packets coming into the Switch by monitoring the Switch's chip counter. This method is only viable for Broadcast and Multicast storms because the chip only has counters for these two types of packets. Once a storm has been detected (that is, once the packet threshold set below has been exceeded), the Switch will shutdown the port to all incoming traffic with the exception of STP BPDU packets, for a time period specified using the Countdown field.

To view this window, click **Security > Traffic Control**, as shown below.

| Unit | From | To | Apply | | | | | | |
|------|--------|--------|-------|--|--|--|--|--|--|
| 1 | Port 1 | Port 1 | Apply | | | | | | |

| Traffic Trap Settings | |
|-----------------------|---|
| Traffic Trap | None <input type="button" value="Apply"/> |

| Traffic Control Settings | | | | | | | | | | |
|--------------------------|--------|--------|-----------|-----------|----------|--------|-----------|------------|----------|-------|
| Unit | From | To | Broadcast | Multicast | Unicast | Action | Threshold | Count Down | Interval | Apply |
| 1 | Port 1 | Port 1 | Disabled | Disabled | Disabled | Drop | 131072 | 0 | 5 | Apply |

| Traffic Control Table-Unit 1 | | | | | | | | |
|------------------------------|-----------|-----------|----------|--------|-----------|------------|---------------|---------|
| Port | Broadcast | Multicast | Unicast | Action | Threshold | Count Down | Time Interval | Forever |
| 1 | Disabled | Disabled | Disabled | Drop | 131072 | 0 | 5 | |
| 2 | Disabled | Disabled | Disabled | Drop | 131072 | 0 | 5 | |
| 3 | Disabled | Disabled | Disabled | Drop | 131072 | 0 | 5 | |
| 4 | Disabled | Disabled | Disabled | Drop | 131072 | 0 | 5 | |
| 5 | Disabled | Disabled | Disabled | Drop | 131072 | 0 | 5 | |
| 6 | Disabled | Disabled | Disabled | Drop | 131072 | 0 | 5 | |
| 7 | Disabled | Disabled | Disabled | Drop | 131072 | 0 | 5 | |
| 8 | Disabled | Disabled | Disabled | Drop | 131072 | 0 | 5 | |
| 9 | Disabled | Disabled | Disabled | Drop | 131072 | 0 | 5 | |
| 10 | Disabled | Disabled | Disabled | Drop | 131072 | 0 | 5 | |
| 11 | Disabled | Disabled | Disabled | Drop | 131072 | 0 | 5 | |
| 12 | Disabled | Disabled | Disabled | Drop | 131072 | 0 | 5 | |
| 13 | Disabled | Disabled | Disabled | Drop | 131072 | 0 | 5 | |
| 14 | Disabled | Disabled | Disabled | Drop | 131072 | 0 | 5 | |
| 15 | Disabled | Disabled | Disabled | Drop | 131072 | 0 | 5 | |
| 16 | Disabled | Disabled | Disabled | Drop | 131072 | 0 | 5 | |
| 17 | Disabled | Disabled | Disabled | Drop | 131072 | 0 | 5 | |
| 18 | Disabled | Disabled | Disabled | Drop | 131072 | 0 | 5 | |
| 19 | Disabled | Disabled | Disabled | Drop | 131072 | 0 | 5 | |
| 20 | Disabled | Disabled | Disabled | Drop | 131072 | 0 | 5 | |
| 21 | Disabled | Disabled | Disabled | Drop | 131072 | 0 | 5 | |
| 22 | Disabled | Disabled | Disabled | Drop | 131072 | 0 | 5 | |
| 23 | Disabled | Disabled | Disabled | Drop | 131072 | 0 | 5 | |
| 24 | Disabled | Disabled | Disabled | Drop | 131072 | 0 | 5 | |
| 25 | Disabled | Disabled | Disabled | Drop | 131072 | 0 | 5 | |

Figure 11- 1. Traffic Control Recover window

If this field times out and the packet storm continues, the port will be placed in a Shutdown Forever mode which will produce a warning message to be sent to the Trap Receiver. Once in Shutdown Forever mode, the only method of recovering this port is to manually recoup it using the **Port Configuration** window in the **Administration** folder and selecting the disabled port and returning it to an Enabled status. To utilize this method of Storm Control, choose the Shutdown option of the Action field in the window below.

The user may set the following parameters:

| Parameter | Description |
|--------------------------------|-------------|
| Traffic Control Recover | |

| | |
|---------------------------------|---|
| From...To | Select the ports to be recovered. |
| Traffic Trap Settings | |
| Traffic Trap Settings | <p>Enable sending of Storm Trap messages when the type of action taken by the Traffic Control function in handling a Traffic Storm is one of the following:</p> <ul style="list-style-type: none"> • <i>None</i> – Will send no Storm trap warning messages regardless of action taken by the Traffic Control mechanism. • <i>Storm Occurred</i> – Will send Storm Trap warning messages upon the occurrence of a Traffic Storm only. • <i>Storm Cleared</i> – Will send Storm Trap messages when a Traffic Storm has been cleared by the Switch only. • <i>Both</i> – Will send Storm Trap messages when a Traffic Storm has been both detected and cleared by the Switch. <p>This function cannot be implemented in the Hardware mode. (When Drop is chosen in the Action field.)</p> |
| Traffic Control Settings | |
| Unit | Select the unit you wish to configure. |
| From...To | Select the ports of this Switch to configure for Storm Control. |
| Broadcast | Enables or disable Broadcast Storm Control. |
| Multicast | Enables or disables Multicast Storm Control. |
| Unicast | Enables or disables Unicast Storm control. |
| Action | <p>Select the method of traffic Control from the pull down menu. The choices are:</p> <p><i>Drop</i> – Utilizes the hardware Traffic Control mechanism, which means the Switch’s hardware will determine the Packet Storm based on the Threshold value stated and drop packets until the issue is resolved.</p> <p><i>Shutdown</i> – Utilizes the Switch’s software Traffic Control mechanism to determine the Packet Storm occurring. Once detected, the port will deny all incoming traffic to the port except STP BPDU packets, which are essential in keeping the Spanning Tree operational on the Switch. If the Countdown timer has expired and yet the Packet Storm continues, the port will be placed in Shutdown Forever mode and is no longer operational until the user manually resets the port using the Storm Control Recover setting at the top of this window. Choosing this option obligates the user to configure the Interval setting as well, which will provide packet count samplings from the Switch’s chip to determine if a Packet Storm is occurring.</p> |
| Threshold | Specifies the maximum number of packets per second that will trigger the Traffic Control function to commence. The Threshold can be set from 0 to 255000 with a default setting of 131072. |
| Count Down | The Count Down timer is set to determine the amount of time, in minutes, that the Switch will wait before shutting down the port that is experiencing a traffic storm. This parameter is only useful for ports configured as Shutdown in their Action field and therefore will not operate for Hardware based Traffic Control implementations. The possible time settings for this field are 0, 5 to 30 minutes. 0 is the default setting for this field and 0 will denote that the port will never shutdown. |
| Interval | The Interval will set the time between Multicast and Broadcast packet counts sent from the Switch’s chip to the Traffic Control function. These packet counts are the determining factor in deciding when incoming packets exceed the Threshold value. The Interval may be set between 5 and 30 seconds with the default setting of 5 seconds. |

Click **Apply** to implement the settings made.



NOTE: Traffic Control cannot be implemented on ports that are set for Link Aggregation (Port Trunking).



NOTE: Ports that are in the Shutdown forever mode will be seen as Discarding in Spanning Tree windows and implementations though these ports will still be forwarding BPDUs to the Switch's CPU.



NOTE: Ports that are in Shutdown Forever mode will be seen as link down in all windows until the user recovers these ports.

Port Security

Port Security Settings

A given ports' (or a range of ports') dynamic MAC address learning can be locked such that the current source MAC addresses entered into the MAC address forwarding table can not be changed once the port lock is enabled. Setting the **Admin State** pull-down menu to *Enabled*, and clicking **Apply** can lock the port.

Port Security is a security feature that prevents unauthorized computers (with source MAC addresses) unknown to the Switch, from connecting to the Switch's ports and gaining access to the network.

To view this window, click **Security > Port Security > Port Security Settings**, as shown below.

Port Security Settings

| Unit | From | To | Admin State | Max.Addr (0-16) | Mode | Apply |
|------|--------|--------|-------------|-----------------|---------------|-------|
| 1 | Port 1 | Port 1 | Disabled | 0 | DeleteOnReset | Apply |

Port Security Table-Unit 1

| Port | Admin State | Max.Learning Addr | Lock Address Mode | Clear |
|------|-------------|-------------------|-------------------|-------|
| 1 | Disabled | 1 | DeleteOnReset | ✕ |
| 2 | Disabled | 1 | DeleteOnReset | ✕ |
| 3 | Disabled | 1 | DeleteOnReset | ✕ |
| 4 | Disabled | 1 | DeleteOnReset | ✕ |
| 5 | Disabled | 1 | DeleteOnReset | ✕ |
| 6 | Disabled | 1 | DeleteOnReset | ✕ |
| 7 | Disabled | 1 | DeleteOnReset | ✕ |
| 8 | Disabled | 1 | DeleteOnReset | ✕ |
| 9 | Disabled | 1 | DeleteOnReset | ✕ |
| 10 | Disabled | 1 | DeleteOnReset | ✕ |
| 11 | Disabled | 1 | DeleteOnReset | ✕ |
| 12 | Disabled | 1 | DeleteOnReset | ✕ |
| 13 | Disabled | 1 | DeleteOnReset | ✕ |
| 14 | Disabled | 1 | DeleteOnReset | ✕ |
| 15 | Disabled | 1 | DeleteOnReset | ✕ |
| 16 | Disabled | 1 | DeleteOnReset | ✕ |
| 17 | Disabled | 1 | DeleteOnReset | ✕ |
| 18 | Disabled | 1 | DeleteOnReset | ✕ |
| 19 | Disabled | 1 | DeleteOnReset | ✕ |
| 20 | Disabled | 1 | DeleteOnReset | ✕ |
| 21 | Disabled | 1 | DeleteOnReset | ✕ |
| 22 | Disabled | 1 | DeleteOnReset | ✕ |
| 23 | Disabled | 1 | DeleteOnReset | ✕ |
| 24 | Disabled | 1 | DeleteOnReset | ✕ |
| 25 | Disabled | 1 | DeleteOnReset | ✕ |

Figure 11- 2. Port Security Settings window

The following parameters can be set:

| Parameter | Description |
|-----------------------------------|---|
| Unit | Select the unit you wish to configure. |
| From...To | A consecutive group of ports may be configured starting with the selected port. |
| Admin State | This pull-down menu allows users to enable or disable Port Security (locked MAC address table for the selected ports). |
| Max. Learning Addr. (0-16) | The number of MAC addresses that will be in the MAC address-forwarding table for the selected switch and group of ports. |
| Lock Address Mode | This pull-down menu allows you to select how the MAC address table locking will be implemented on the Switch, for the selected group of ports. The options are: <ul style="list-style-type: none"> <i>Permanent</i> – The locked addresses will not age out. <i>DeleteOnTimeout</i> – The locked addresses will age out after the aging timer expires. <i>DeleteOnReset</i> – The locked addresses will not age out until the Switch has been reset. |

Click **Apply** to implement changes made.

Port Security Entries

This window is used to remove an entry from the port security entries learned by the Switch and entered into the forwarding database.

To view the following window, click **Security > Port Security > Port Security Entries**, as shown below.

| Total Entries: 0 | | | | | | |
|------------------------------------|-----------|-------------|------|------|------|--------|
| Port Security Entries Table | | | | | | |
| VID | VLAN Name | MAC Address | Unit | Port | Type | Delete |

Figure 11- 3. Port Security Entries Table window

This function is only operable if the Mode in the **Port Security** window is selected as *Permanent* or *DeleteOnReset*, or in other words, only addresses that are permanently learned by the Switch can be deleted on reset. Once the entry has been defined by entering the correct information into the window above, click the under the Delete heading of the corresponding MAC address to be deleted. Only entries marked *Secured_Permanent* can be deleted. Click the **Next** button to view the next page of entries listed in this table. This window displays the following information:

| Parameter | Description |
|--------------------|--|
| VID | The VLAN ID of the entry in the forwarding database table that has been permanently learned by the Switch. |
| VLAN NAME | The VLAN Name of the entry in the forwarding database table that has been permanently learned by the Switch. |
| MAC Address | The MAC address of the entry in the forwarding database table that has been permanently learned by the Switch. |
| Unit | Enter the unit you wish to configure. |
| Port | The ID number of the port that has permanently learned the MAC address. |
| Type | The type of MAC address in the forwarding database table. Only entries marked <i>Secured_Permanent</i> can be deleted. |
| Delete | Click the <input type="checkbox"/> in this field to delete the corresponding MAC address that was permanently learned by the Switch. |

IP-MAC-Port Binding

The IP network layer uses a four-byte address. The Ethernet link layer uses a six-byte MAC address. Binding these two address types together allows the transmission of data between the layers. The primary purpose of IP-MAC-Port binding is to restrict the access to a switch to a number of authorized users. Only the authorized client can access the Switch's port by checking the pair of IP-MAC addresses with the pre-configured database. If an unauthorized user tries to access an IP-MAC-Port binding enabled port, the system will block the access by dropping its packet. The maximum number of IP-MAC-Port binding entries is dependant on chip capability (e.g. the ARP table size) and storage size of the device. The maximum number of IP-MAC-Port Binding entries is 511. The creation of authorized users can be manually configured by CLI or Web. The function is port-based, meaning a user can enable or disable the function on the individual port.

IMP Global Settings

This window is used to enable or disable the Trap Log State and DHCP Snoop state on the switch. The Trap/Log field will enable and disable the sending of trap log messages for IP-MAC-Port binding. When enabled, the Switch will send a trap message to the SNMP agent and the Switch log when the address binding module detects illegal IP and MAC addresses.

To view this window click, **Security > IP-MAC-Port Binding > IMP Global Settings**, as shown below.

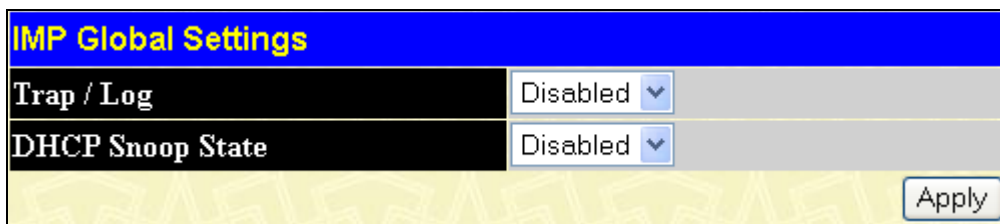

Figure 11- 4. IMP Global Settings window

The following parameters can be set:

| Parameter | Description |
|------------------|--|
| Trap / Log | This field will enable and disable the sending of trap log messages for IP-MAC binding. When enabled, the Switch will send a trap log message to the SNMP agent and the Switch log when address binding module detects illegal IP and MAC addresses. |
| DHCP Snoop State | Use the pull-down menu to enable or disable the DHCP Snoop State for IP-MAC-Port Binding. |

Click Apply to implement the settings made.

IMP Port Settings

Select a port or a range of ports with the From Port and To Port fields. Enable or disable the port with the State, Allow Zero IP and Forward DHCP packet field, and configure the port's Max entry.

To view this window click, **Security > IP-MAC-Port Binding > IMP Port Settings**, as shown below.

| IMP Port Settings | | | | | | | | |
|-------------------|--------|--------|----------|---------------|---------------------|------|-----------------------------------|-------|
| Unit | From | To | State | Allow Zero IP | Forward DHCP Packet | Mode | Max Entry(1-50) | Apply |
| 1 | Port 1 | Port 1 | Disabled | Disabled | Enabled | ARP | <input type="checkbox"/> No Limit | Apply |

| IMP Port Table | | | | | |
|----------------|----------|---------------|---------------------|------|-----------|
| Port | State | Allow Zero IP | Forward DHCP Packet | Mode | Max Entry |
| 1 | Disabled | Disabled | Enabled | ARP | No Limit |
| 2 | Disabled | Disabled | Enabled | ARP | No Limit |
| 3 | Disabled | Disabled | Enabled | ARP | No Limit |
| 4 | Disabled | Disabled | Enabled | ARP | No Limit |
| 5 | Disabled | Disabled | Enabled | ARP | No Limit |
| 6 | Disabled | Disabled | Enabled | ARP | No Limit |
| 7 | Disabled | Disabled | Enabled | ARP | No Limit |
| 8 | Disabled | Disabled | Enabled | ARP | No Limit |
| 9 | Disabled | Disabled | Enabled | ARP | No Limit |
| 10 | Disabled | Disabled | Enabled | ARP | No Limit |
| 11 | Disabled | Disabled | Enabled | ARP | No Limit |
| 12 | Disabled | Disabled | Enabled | ARP | No Limit |
| 13 | Disabled | Disabled | Enabled | ARP | No Limit |
| 14 | Disabled | Disabled | Enabled | ARP | No Limit |
| 15 | Disabled | Disabled | Enabled | ARP | No Limit |
| 16 | Disabled | Disabled | Enabled | ARP | No Limit |
| 17 | Disabled | Disabled | Enabled | ARP | No Limit |
| 18 | Disabled | Disabled | Enabled | ARP | No Limit |
| 19 | Disabled | Disabled | Enabled | ARP | No Limit |
| 20 | Disabled | Disabled | Enabled | ARP | No Limit |
| 21 | Disabled | Disabled | Enabled | ARP | No Limit |
| 22 | Disabled | Disabled | Enabled | ARP | No Limit |
| 23 | Disabled | Disabled | Enabled | ARP | No Limit |
| 24 | Disabled | Disabled | Enabled | ARP | No Limit |
| 25 | Disabled | Disabled | Enabled | ARP | No Limit |

Figure 11- 5. IMP Port Settings window

The following fields can be set or modified:

| Parameter | Description |
|----------------------|---|
| Unit | Enter the unit you wish to configure. |
| From...To | Select a port or range of ports to set for IP-MAC-Port Binding. |
| State | Use the pull-down menu to enable or disable these ports for IP-MAC-Port Binding. |
| Allow Zero IP | Use the pull-down menu to enable or disable this feature. Allow zero IP configures the state which allows ARP packets with 0.0.0.0 source IP to bypass. |

| | |
|----------------------------|---|
| Forward DHCP Packet | By default, the DHCP packet with broadcast DA will be flooded. When set to disable in strict mode, the broadcast DHCP packet received by the specified port will not be forwarded. This function will only take effect in Strict mode. The Switch will forward DHCP packets in Loose mode whether forwarded DHCP packets are enabled or disabled. |
| Mode | <p>ARP – ARP mode is the default mode that applies to IMPB enabled ports. In ARP mode if the switch identifies the host is legal, the host's MAC will be programmed to <i>L2 FDB with allowed</i>; otherwise the host's MAC will be programmed to <i>L2 FDB with drop</i>. ARP mode for security access control is based on Layer 2 MAC address.</p> <p>ACL – ACL mode provides strict security for IP level traffic, If ACL mode is enabled, the static configured IMPB entries with ACL mode will be applied to hardware ACL table, if the ACL mode is disabled, the ACL entries will be removed from the hardware ACL table.</p> |
| Max Entry(1-50) | Specifies the maximum number of IP-MAC-Port Binding dynamic entries. By default, per port max dynamic entry is "No Limit." The Max dynamic entry threshold is 1-50. Check the No Limit check box to allow no limit. |

IMP Entry Settings

This table is used to create Static IP-MAC-Port-Binding entries on the switch.

To view this window click, **Security > IP-MAC-Port Binding > IMP Entry Settings**, as shown below.

Figure 11- 6. IMP Entry Settings window

The following fields can be set or modified:

| Parameter | Description |
|--------------------|---|
| IP Address | Enter the IP address to bind to the MAC address set below. |
| MAC Address | Enter the MAC address to bind to the IP Address set above. |
| Ports | Specify the switch ports for which to configure this IP-MAC-Port binding entry (IP Address + MAC Address). Click the All check box to configure this entry for all ports on the Switch. |

Click **Add** for implement changes, click **Find** to search for an entry, click **View All** for the table to display all entries and click **Delete** to remove an entry.

DHCP Snooping Entries

This table is used to view dynamic entries on specific ports. To view particular port settings, select the unit, enter the port number and click **Find**. To view all entries click **View All**, and to delete an entry, click **Clear**.

To view this window click, **Security > IP-MAC-Port Binding > DHCP Snooping Entries**, as shown below.

| | | | |
|------------------------------|----------------------|-------------------------------------|---|
| Unit - Port | 1 ▾ Port 1 ▾ | <input type="button" value="Find"/> | <input type="button" value="View All"/> |
| Ports (e.g: 1,5,7-12) | <input type="text"/> | <input type="checkbox"/> All | <input type="button" value="Clear"/> |
| Total Entries: 0 | | | |
| DHCP Snooping Entries | | | |
| IP Address | MAC Address | Lease Time(secs) | Port |
| | | | Status |

Figure 11- 7. DHCP Snooping Entries window

MAC Block List

This table is used to view unauthorized devices that have been blocked by IP-MAC-Port binding restrictions. To find an unauthorized device that has been blocked by the IP-MAC-Port binding restrictions, enter the **VLAN Name** and **MAC Address** in the appropriate fields and click **Find**. To delete an entry, click the delete button next to the entry's port. To delete all the entries in the **MAC Block List** window, click **Delete All**.

To view this window click, **Security > IP-MAC-Port Binding > MAC Block List**, as shown below.

| | | |
|-------------------------|----------------------|---|
| VLAN Name | <input type="text"/> | |
| MAC Address | 00-00-00-00-00-00 | <input type="button" value="Find"/> <input type="button" value="Delete All"/> |
| Total Entries: 0 | | |
| MAC Block List | | |
| VID | VLAN Name | MAC Address |
| | | Port |
| | | Delete |

Figure 11- 8. MAC Block List window

802.1X

802.1X Port-Based and MAC-Based Access Control

The IEEE 802.1X standard is a security measure for authorizing and authenticating users to gain access to various wired or wireless devices on a specified Local Area Network by using a Client and Server based access control model. This is accomplished by using a RADIUS server to authenticate users trying to access a network by relaying Extensible Authentication Protocol over LAN (EAPOL) packets between the Client and the Server. The following figure represents a basic EAPOL packet:

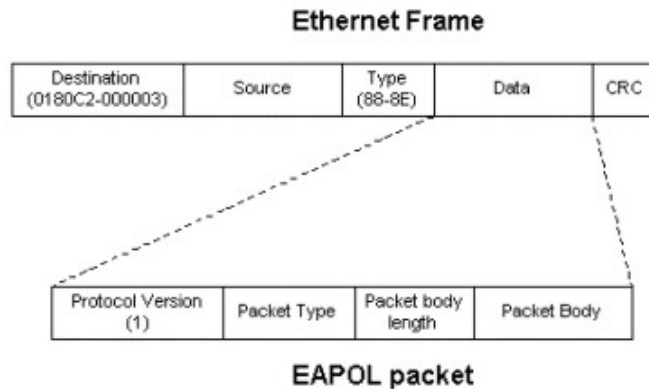

Figure 11- 9. The EAPOL Packet

Utilizing this method, unauthorized devices are restricted from connecting to a LAN through a port to which the user is connected. EAPOL packets are the only traffic that can be transmitted through the specific port until authorization is granted. The 802.1X Access Control method holds three roles, each of which are vital to creating and upkeeping a stable and working Access Control security method.

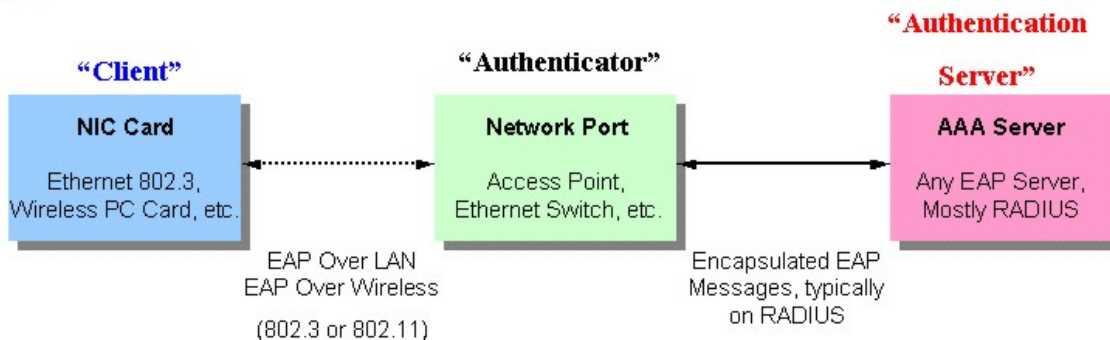

Figure 11- 10. The three roles of 802.1X

The following section will explain the three roles of Client, Authenticator, and Authentication Server in greater detail.

Authentication Server

The Authentication Server is a remote device that is connected to the same network as the Client and Authenticator, must be running a RADIUS Server program and must be configured properly on the Authenticator (Switch). Clients connected to a port on the Switch must be authenticated by the Authentication Server (RADIUS) before attaining any services offered by the Switch on the LAN. The role of the Authentication Server is to certify the identity of the Client attempting to access the network by exchanging secure information between the RADIUS server and the Client through EAPOL packets and, in turn, informs the Switch whether or not the Client is granted access to the LAN and/or switches services.

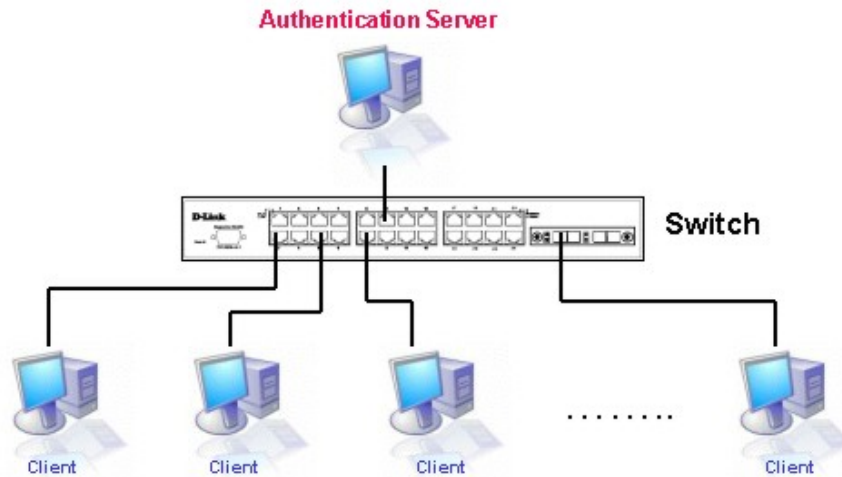

Figure 11- 11. The Authentication Server

Authenticator

The Authenticator (the Switch) is an intermediary between the Authentication Server and the Client. The Authenticator serves two purposes when utilizing 802.1X. The first purpose is to request certification information from the Client through EAPOL packets, which is the only information allowed to pass through the Authenticator before access is granted to the Client. The second purpose of the Authenticator is to verify the information gathered from the Client with the Authentication Server, and to then relay that information back to the Client.

Three steps must be implemented on the Switch to properly configure the Authenticator.

1. The 802.1X State must be *Enabled*. (**DGS-3600 Web Management Tool**)
2. The 802.1X settings must be implemented by port (**Security / 802.1X / Configure 802.1X Authenticator Parameter**)
3. A RADIUS server must be configured on the Switch. (**Security / 802.1X / Authentic RADIUS Server**)

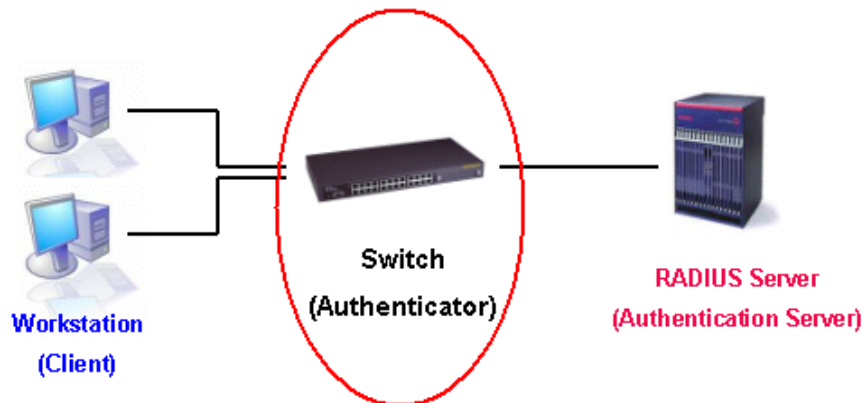

Figure 11- 12. The Authenticator

Client

The Client is simply the endstation that wishes to gain access to the LAN or switch services. All endstations must be running software that is compliant with the 802.1X protocol. For users running Windows XP, that software is included within the operating system. All other users are required to attain 802.1X client software from an outside source. The Client will request access to the LAN and or Switch through EAPOL packets and, in turn will respond to requests from the Switch.

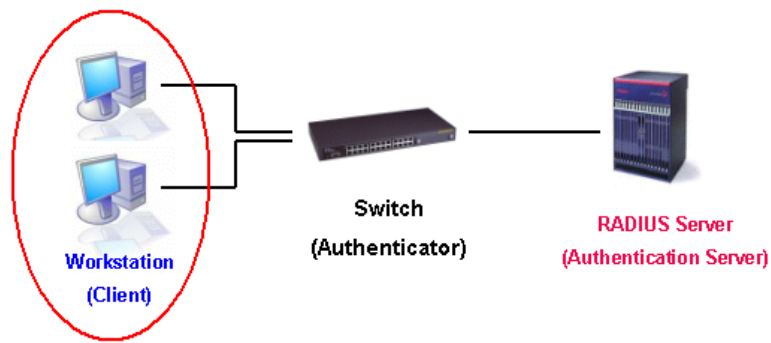

Figure 11- 13. The Client

Authentication Process

Utilizing the three roles stated above, the 802.1X protocol provides a stable and secure way of authorizing and authenticating users attempting to access the network. Only EAPOL traffic is allowed to pass through the specified port before a successful authentication is made. This port is “locked” until the point when a Client with the correct username and password (and MAC address if 802.1X is enabled by MAC address) is granted access and therefore successfully “unlocks” the port. Once unlocked, normal traffic is able to pass through the port. The following figure displays a more detailed explanation of how the authentication process is completed between the three roles stated above.

802.1X Authentication process

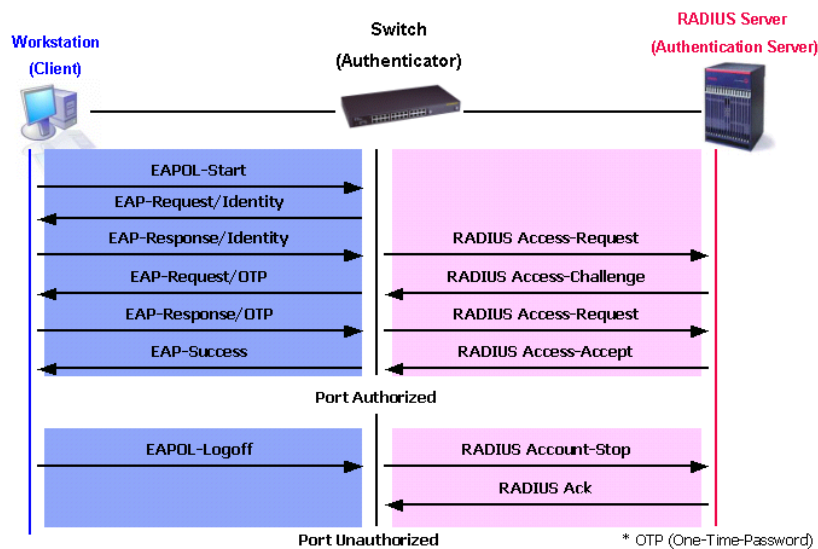

Figure 11- 14. The 802.1X Authentication Process

The D-Link implementation of 802.1X allows network administrators to choose between two types of Access Control used on the Switch, which are:

1. Port-Based Access Control – This method requires only one user to be authenticated per port by a remote RADIUS server to allow the remaining users on the same port access to the network.
2. MAC-Based Access Control – Using this method, the Switch will automatically learn up to sixteen MAC addresses by port and set them in a list. Each MAC address must be authenticated by the Switch using a remote RADIUS server before being allowed access to the Network.

Understanding 802.1X Port-based and MAC-based Network Access Control

The original intent behind the development of 802.1X was to leverage the characteristics of point-to-point in LANs. As any single LAN segment in such infrastructures has no more than two devices attached to it, one of which is a Bridge Port. The Bridge Port detects events that indicate the attachment of an active device at the remote end of the link, or an active device becoming inactive. These events can be used to control the authorization state of the Port and initiate the process of authenticating the attached device if the Port is unauthorized. This is the Port-Based Network Access Control.

Port-Based Network Access Control

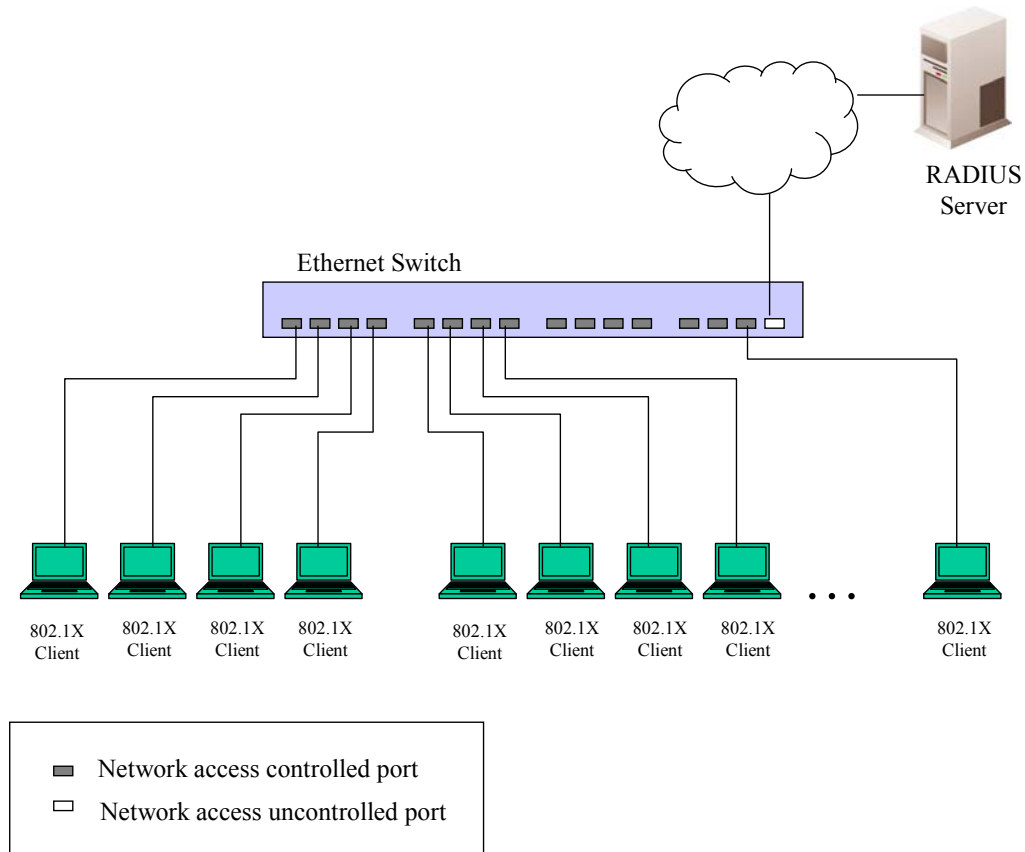

Figure 11- 15. Example of Typical Port-Based Configuration

Once the connected device has successfully been authenticated, the Port then becomes Authorized, and all subsequent traffic on the Port is not subject to access control restriction until an event occurs that causes the Port to become Unauthorized. Hence, if the Port is actually connected to a shared media LAN segment with more than one attached device, successfully authenticating one of the attached devices effectively provides access to the LAN for all devices on the shared segment. Clearly, the security offered in this situation is open to attack.

MAC-Based Network Access Control

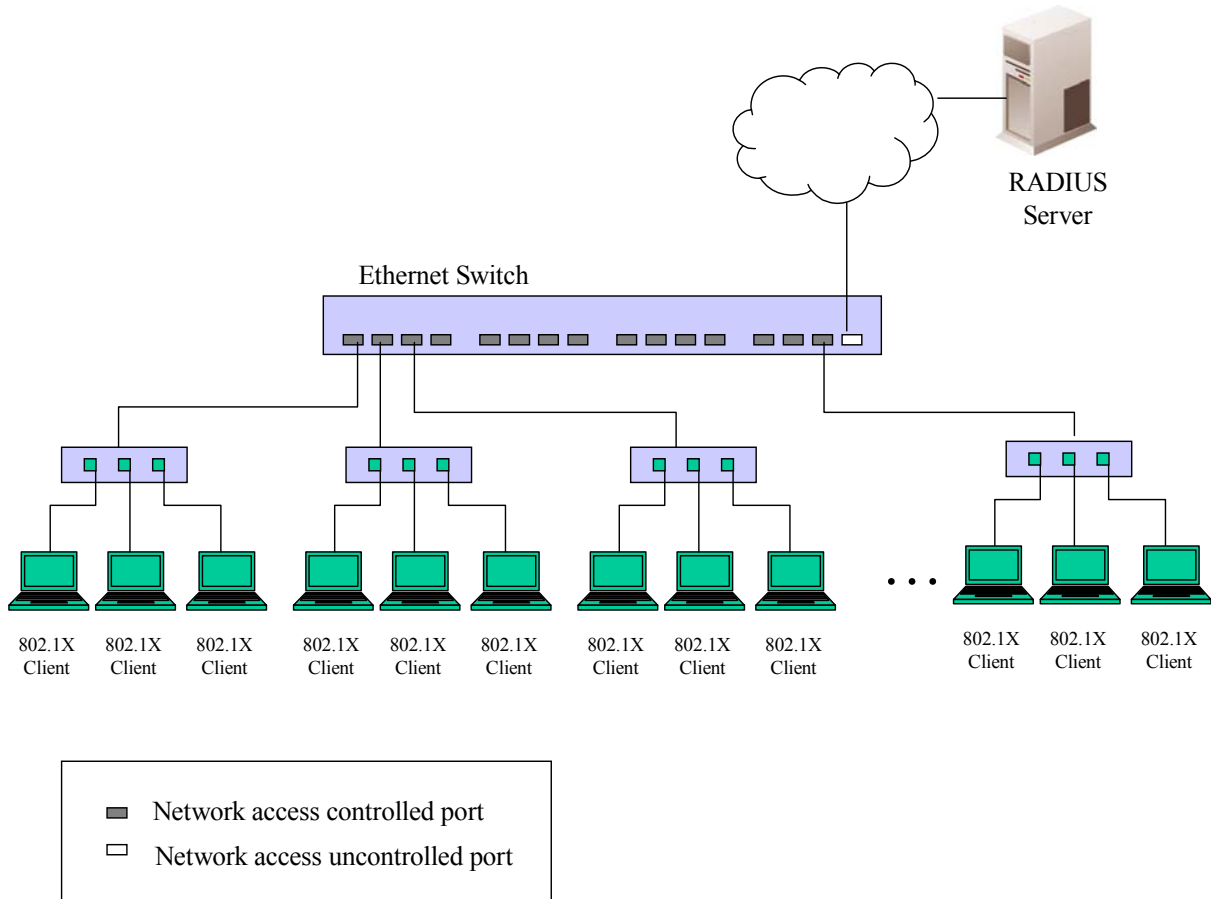

Figure 11- 16. Example of Typical MAC-Based Configuration

In order to successfully make use of 802.1X in a shared media LAN segment, it would be necessary to create “logical” Ports, one for each attached device that required access to the LAN. The Switch would regard the single physical Port connecting it to the shared media segment as consisting of a number of distinct logical Ports, each logical Port being independently controlled from the point of view of EAPOL exchanges and authorization state. The Switch learns each attached devices’ individual MAC addresses, and effectively creates a logical Port that the attached device can then use to communicate with the LAN via the Switch.

Guest VLANs

On 802.1x security enabled networks, there is a need for non 802.1x supported devices to gain limited access to the network, due to lack of the proper 802.1x software or incompatible devices, such as computers running Windows 98 or lower operating systems, or the need for guests to gain access to the network without full authorization. To supplement these circumstances, this switch now implements Guest 802.1x VLANs. These VLANs should have limited access rights and features separate from other VLANs on the network.

To implement 802.1x Guest VLANs, the user must first create a VLAN on the network with limited rights and then enable it as an 802.1x guest VLAN. Then the administrator must configure the guest accounts accessing the Switch to be placed in a Guest VLAN when trying to access the Switch. Upon initial entry to the Switch, the client wishing services on the Switch will need to be authenticated by a remote RADIUS Server or local authentication on the Switch to be placed in a fully operational VLAN. If authenticated and the authenticator possesses the VLAN placement information, that client will be accepted into the fully operational target VLAN and normal switch functions will be open to the client. If the authenticator does not have target VLAN placement information, the client will be returned to its originating VLAN. Yet, if the client is denied authentication by the authenticator, it will be placed in the Guest VLAN where it has limited rights and access. The adjacent figure should give the user a better understanding of the Guest VLAN process.

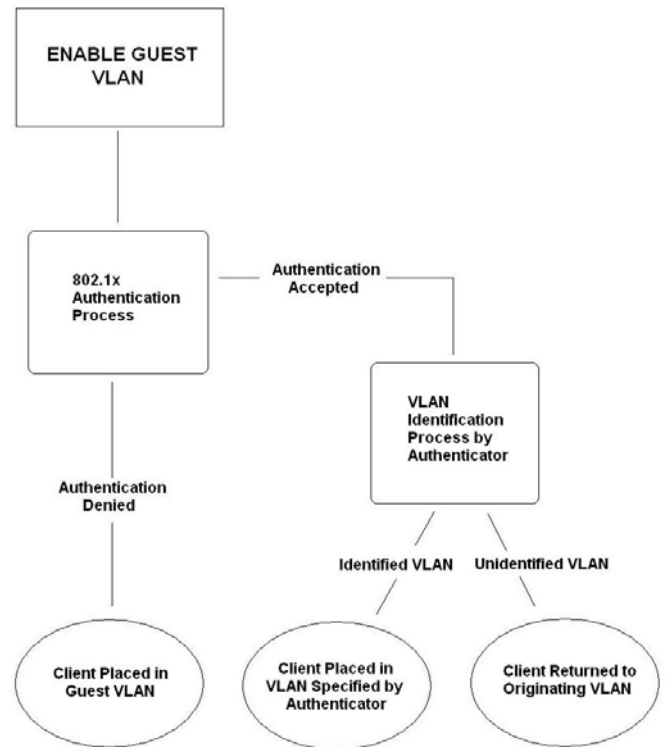

Figure 11- 17. Guest VLAN Authentication Process

Limitations Using the Guest VLAN

1. Ports supporting Guest VLANs cannot be GVRP enabled and vice versa.
2. A port cannot be a member of a Guest VLAN and a static VLAN simultaneously.
3. Once a client has been accepted into the target VLAN, it can no longer access the Guest VLAN.
4. If a port is a member of multiple VLANs, it cannot become a member of the Guest VLAN.
5. 802.1X Guest VLAN cannot be a member of a Web-based authentication VLAN.

Configure 802.1X Guest VLAN

To set a Guest 802.1X VLAN, the user must first configure a normal VLAN which can be enabled here for Guest VLAN status.

To view this window, click **Security > 802.1X > Configure 802.1X Guest VLAN**, as shown below.

Figure 11- 18. Guest VLAN Settings window

The following fields may be modified to enable the guest 802.1X VLAN:

| Parameter | Description |
|------------------|--|
| VLAN Name | Enter the pre-configured VLAN name to create as a Guest 802.1X VLAN. |
| Operation | The user has four choices in configuring the Guest 802.1X VLAN, which are: <i>Enabled Ports</i> – Selecting this option will enable ports listed in the Port List below, as part of the Guest VLAN. Be sure that these ports are configured for this VLAN or users will be prompted with an error message. <i>Disabled Ports</i> - Selecting this option will disable ports listed in the Port List below, as part of the Guest VLAN. Be sure that these ports are configured for this VLAN or users will be prompted with an error message. <i>Add</i> – Selecting this option will add the VLAN entered in the VLAN Name window above. <i>Delete</i> – Selecting this option will delete the VLAN entered in the VLAN Name window above. |
| Port List | Enter the ports to be operational for the Gust VLAN. Checking the All box will select all ports to be enabled. |

Click **Apply** to implement the guest 802.1X VLAN settings entered. Only one VLAN may be assigned as the 802.1X Guest VLAN.

Configure 802.1X Authenticator Parameter

To configure the 802.1X Authenticator Settings, click **Security > 802.1X > Configure 802.1X Authenticator Parameter**, as shown below.

Unit: 1

Configure 802.1X Authenticator Parameter-Unit 1

| Port | AdmDir | Port Control | TxPeriod | Quiet Period | Supp-Timeout | Server-Timeout | MaxReq | ReAuth Period | ReAuth Enabled | Capability | Modify |
|------|--------|--------------|----------|--------------|--------------|----------------|--------|---------------|----------------|------------|--------|
| 1 | both | Auto | 30 | 60 | 30 | 30 | 2 | 3600 | No | None | Modify |
| 2 | both | Auto | 30 | 60 | 30 | 30 | 2 | 3600 | No | None | Modify |
| 3 | both | Auto | 30 | 60 | 30 | 30 | 2 | 3600 | No | None | Modify |
| 4 | both | Auto | 30 | 60 | 30 | 30 | 2 | 3600 | No | None | Modify |
| 5 | both | Auto | 30 | 60 | 30 | 30 | 2 | 3600 | No | None | Modify |
| 6 | both | Auto | 30 | 60 | 30 | 30 | 2 | 3600 | No | None | Modify |
| 7 | both | Auto | 30 | 60 | 30 | 30 | 2 | 3600 | No | None | Modify |
| 8 | both | Auto | 30 | 60 | 30 | 30 | 2 | 3600 | No | None | Modify |
| 9 | both | Auto | 30 | 60 | 30 | 30 | 2 | 3600 | No | None | Modify |
| 10 | both | Auto | 30 | 60 | 30 | 30 | 2 | 3600 | No | None | Modify |
| 11 | both | Auto | 30 | 60 | 30 | 30 | 2 | 3600 | No | None | Modify |
| 12 | both | Auto | 30 | 60 | 30 | 30 | 2 | 3600 | No | None | Modify |
| 13 | both | Auto | 30 | 60 | 30 | 30 | 2 | 3600 | No | None | Modify |
| 14 | both | Auto | 30 | 60 | 30 | 30 | 2 | 3600 | No | None | Modify |
| 15 | both | Auto | 30 | 60 | 30 | 30 | 2 | 3600 | No | None | Modify |
| 16 | both | Auto | 30 | 60 | 30 | 30 | 2 | 3600 | No | None | Modify |
| 17 | both | Auto | 30 | 60 | 30 | 30 | 2 | 3600 | No | None | Modify |
| 18 | both | Auto | 30 | 60 | 30 | 30 | 2 | 3600 | No | None | Modify |
| 19 | both | Auto | 30 | 60 | 30 | 30 | 2 | 3600 | No | None | Modify |
| 20 | both | Auto | 30 | 60 | 30 | 30 | 2 | 3600 | No | None | Modify |
| 21 | both | Auto | 30 | 60 | 30 | 30 | 2 | 3600 | No | None | Modify |
| 22 | both | Auto | 30 | 60 | 30 | 30 | 2 | 3600 | No | None | Modify |
| 23 | both | Auto | 30 | 60 | 30 | 30 | 2 | 3600 | No | None | Modify |
| 24 | both | Auto | 30 | 60 | 30 | 30 | 2 | 3600 | No | None | Modify |
| 25 | both | Auto | 30 | 60 | 30 | 30 | 2 | 3600 | No | None | Modify |

Figure 11- 19. Configure 802.1X Authenticator Parameter window

To configure the settings by port, click on its corresponding **Modify** button, which will display the following table to configure:

| 802.1X Authenticator Settings-Unit 1 | |
|---|----------|
| Unit | 1 |
| From | Port 1 |
| To | Port 1 |
| AdmDir | both |
| PortControl | auto |
| TxPeriod | 30 |
| QuietPeriod | 60 |
| SuppTimeout | 30 |
| ServerTimeout | 30 |
| MaxReq | 2 |
| ReAuthPeriod | 3600 |
| ReAuth | Disabled |
| Capability | None |
| Show Authenticators Setting for Unit 1 Apply | |

Figure 11- 20. 802.1X Authenticator Settings window (Modify)

This window allows users to set the following features:

| Parameter | Description |
|-------------|---|
| Unit | Select the unit you wish to configure. |
| From...To | Enter the port or ports to be set. |
| AdmCtrlDir | <p>Sets the administrative-controlled direction to either <i>in</i> or <i>both</i>.</p> <p>If <i>in</i> is selected, control is only exerted over incoming traffic through the port you selected in the first field.</p> <p>If <i>both</i> are selected, control is exerted over both incoming and outgoing traffic through the controlled port selected in the first field.</p> |
| PortControl | <p>This allows you to control the port authorization state.</p> <p>Select <i>forceAuthorized</i> to disable 802.1X and cause the port to transition to the authorized state without any authentication exchange required. This means the port transmits and receives normal traffic without 802.1X-based authentication of the client.</p> <p>If <i>forceUnauthorized</i> is selected, the port will remain in the unauthorized state, ignoring all attempts by the client to authenticate. The Switch cannot provide authentication services to the client through the interface.</p> <p>If <i>Auto</i> is selected, it will enable 802.1X and cause the port to begin in the unauthorized state, allowing only EAPOL frames to be sent and received through the port. The authentication process begins when the link state of the port transitions from down to up, or when an EAPOL-start frame is received. The Switch then requests the identity of the client and begins relaying authentication messages between the client and the authentication server.</p> <p>The default setting is <i>Auto</i>.</p> |
| TxPeriod | This sets the TxPeriod of time for the authenticator PAE state machine. This value determines the period of an EAP Request/Identity packet transmitted to the client. The |

| | |
|----------------------|---|
| | default setting is 30 seconds. |
| QuietPeriod | This allows you to set the number of seconds that the Switch remains in the quiet state following a failed authentication exchange with the client. The default setting is 60 seconds. |
| SuppTimeout | This value determines timeout conditions in the exchanges between the Authenticator and the client. The default setting is 30 seconds. |
| ServerTimeout | This value determines timeout conditions in the exchanges between the Authenticator and the authentication server. The default setting is 30 seconds. |
| MaxReq | The maximum number of times that the Switch will retransmit an EAP Request to the client before it times out of the authentication sessions. The default setting is 2. |
| ReAuthPeriod | A constant that defines a nonzero number of seconds between periodic reauthentication of the client. The default setting is 3600 seconds. |
| ReAuth | Determines whether regular reauthentication will take place on this port. The default setting is <i>Disabled</i> . |
| Capability | This allows the 802.1X Authenticator settings to be applied on a per-port basis. Select <i>Authenticator</i> to apply the settings to the port. When the setting is activated A user must pass the authentication process to gain access to the network. Select <i>None</i> disable 802.1X functions on the port. |

Click **Apply** to implement configuration changes.

802.1X User

This window allows the user to set different local users on the Switch.

To view this window, click **Security > 802.1X > 802.1X User**, as shown below.

Figure 11- 21. 802.1X User window

Enter a User Name, Password and confirmation of that password. Properly configured local users will be displayed in the 802.1X User Table in the same window.

Initialize Port(s)

Existing 802.1X port and MAC settings are displayed and can be configured using the window below.

To view this window, click **Security > 802.1X > Initialize Port(s)**, as shown below.

Figure 11- 22. Initialize Port window (Port-based 802.1X)

This window allows initialization of a port or group of ports. The Initialize Port Table in the bottom half of the window displays the current status of the port(s).

To initialize ports for the MAC side of 802.1X, the user must first enable 802.1X by MAC address in the **DGS-3600 Web Management Tool** window.

Click **Security > 802.1X > Initialize Port(s)**, as shown below:

Figure 11- 23. Initialize Ports window (MAC-based 802.1X)

To initialize ports, first choose the switch in the switch stack by using the pull-down menu and then choose the range of ports in the From and To field. Then the user must specify the MAC address to be initialized by entering it into the MAC Address field and ticking the corresponding check box. To begin the initialization, click **Apply**.

This window displays the following information:

| Parameter | Description |
|-----------------------|--|
| From...To | Select ports to be initialized. |
| Port | A read-only field indicating a port on the Switch. |
| MAC Address | The MAC address of the Switch connected to the corresponding port, if any. |
| Auth PAE State | The Authenticator PAE State will display one of the following: Initialize, Disconnected, Connecting, Authenticating, Authenticated, Aborting, Held, ForceAuth, ForceUnauth, and N/A. |
| Backend State | The Backend Authentication State will display one of the following: Request, Response, Success, Fail, Timeout, Idle, Initialize, and N/A. |
| Port Status | The status of the controlled port can be <i>Authorized</i> , <i>Unauthorized</i> , or <i>N/A</i> . |



NOTE: The user must first globally enable 802.1X in the **DGS-3600 Web Management Tool** window before initializing ports. Information in the Initialize Ports Table cannot be viewed before enabling 802.1X.

Reauthenticate Port(s)

This window allows reauthentication of a port or group of ports by using the pull-down menus From and To and clicking **Apply**. The Reauthenticate Port Table displays the current status of the reauthenticated port(s) once **Apply** has been clicked.

To view this window, click **Security > 802.1X > Reauthenticate Port(s)**, as shown below.

| Reauthenticate Port | | | |
|----------------------------------|----------------|--------------|------------|
| Unit | From | To | Show |
| 1 | Port 1 | Port 1 | Show |
| Reauthenticate Port Table-Unit 1 | | | |
| Port | Auth PAE State | BackendState | PortStatus |

Figure 11- 24. Reauthenticate Port window



NOTE: The user must first globally enable 802.1X in the **DGS-3600 Web Management Tool** window before initializing ports. Information in the Initialize Ports Table cannot be viewed before enabling 802.1X.

To reauthenticate ports for the MAC side of 802.1X, the user must first enable 802.1X by MAC address in the **DGS-3600 Web Management Tool** window.

Click **Security > 802.1X > Reauthenticate Port(s)** as shown below:

Figure 11- 25. Reauthenticate Port(s) window (MAC-based 802.1X)

To reauthenticate ports, first choose the switch in the switch stack by using the pull-down menu and then choose the range of ports in the From and To field. Then the user must specify the MAC address to be reauthenticated by entering it into the MAC Address field and ticking the corresponding check box. To begin the reauthentication, click **Apply**.

This window displays the following information:

| Parameter | Description |
|-----------------------|--|
| Port | The port number of the reauthenticated port. |
| MAC Address | Displays the physical address of the Switch where the port resides. |
| Auth PAE State | The Authenticator State will display one of the following: Initialize, Disconnected, Connecting, Authenticating, Authenticated, Aborting, Held, ForceAuth, ForceUnauth, and N/A. |
| BackendState | The Backend State will display one of the following: Request, Response, Success, Fail, Timeout, Idle, Initialize, and N/A. |
| PortStatus | The status of the controlled port can be Authorized, Unauthorized, or N/A. |

Authentic RADIUS Server

The RADIUS feature of the Switch allows you to facilitate centralized user administration as well as providing protection against a sniffing, active hacker. The Web Manager offers three windows.

To view this window, click **Security > 802.1X > Authentic RADIUS Server**, as shown below.

| Succession | RADIUS Server | Auth UDP Port | Acct UDP Port | Status | Key |
|------------|---------------|---------------|---------------|--------|-----|
| First | | | | | |
| Second | | | | | |
| Third | | | | | |

Figure 11- 26. Authentic RADIUS Server window

This window displays the following information:

| Parameter | Description |
|------------------------|--|
| Succession | Choose the desired RADIUS server to configure: <i>First</i> , <i>Second</i> or <i>Third</i> . |
| RADIUS Server | Set the RADIUS server IP. |
| Authentic Port | Set the RADIUS authentic server(s) UDP port. The default port is <i>1812</i> . |
| Accounting Port | Set the RADIUS account server(s) UDP port. The default port is <i>1813</i> . |
| Key | Set the key the same as that of the RADIUS server. |
| Confirm Key | Confirm the shared key is the same as that of the RADIUS server. |
| Status | This allows users to set the RADIUS Server as <i>Valid</i> (Enabled) or <i>Invalid</i> (Disabled). |

Web Authentication

Web-based Access Control is another port based access control method implemented similarly to the 802.1x port based access control method previously stated. This function will allow user authentication through a RADIUS server or through the local authentication set on the Switch when a user is trying to access the network via the switch, if the port connected to the user is enabled for this feature.

The user attempting to gain web access will be prompted for a username and password before being allowed to accept HTTP packets from the Switch. When a client attempts to access a website, that port is placed in the authentication VLAN set by the user. All clients in this authentication VLAN will be queried for authentication by the local method or through a RADIUS server. Once accepted, the user will be placed in a target VLAN on the Switch where it will have rights and privileges to openly access the Internet. If denied access, no packets will pass through to the user and thus, that user will be returned to the authentication VLAN from where it came and the authentication procedure will have to be reattempted by the user.

Once a client has been authenticated on a particular port, that port will be placed in the pre-configured VLAN and any other clients on that port will be automatically authenticated to access the specified Redirection Path URL, as well as the authenticated client.

To the right there is an example of the basic six step process all parties of the authentication go through for a successful Web-based Access Control process.

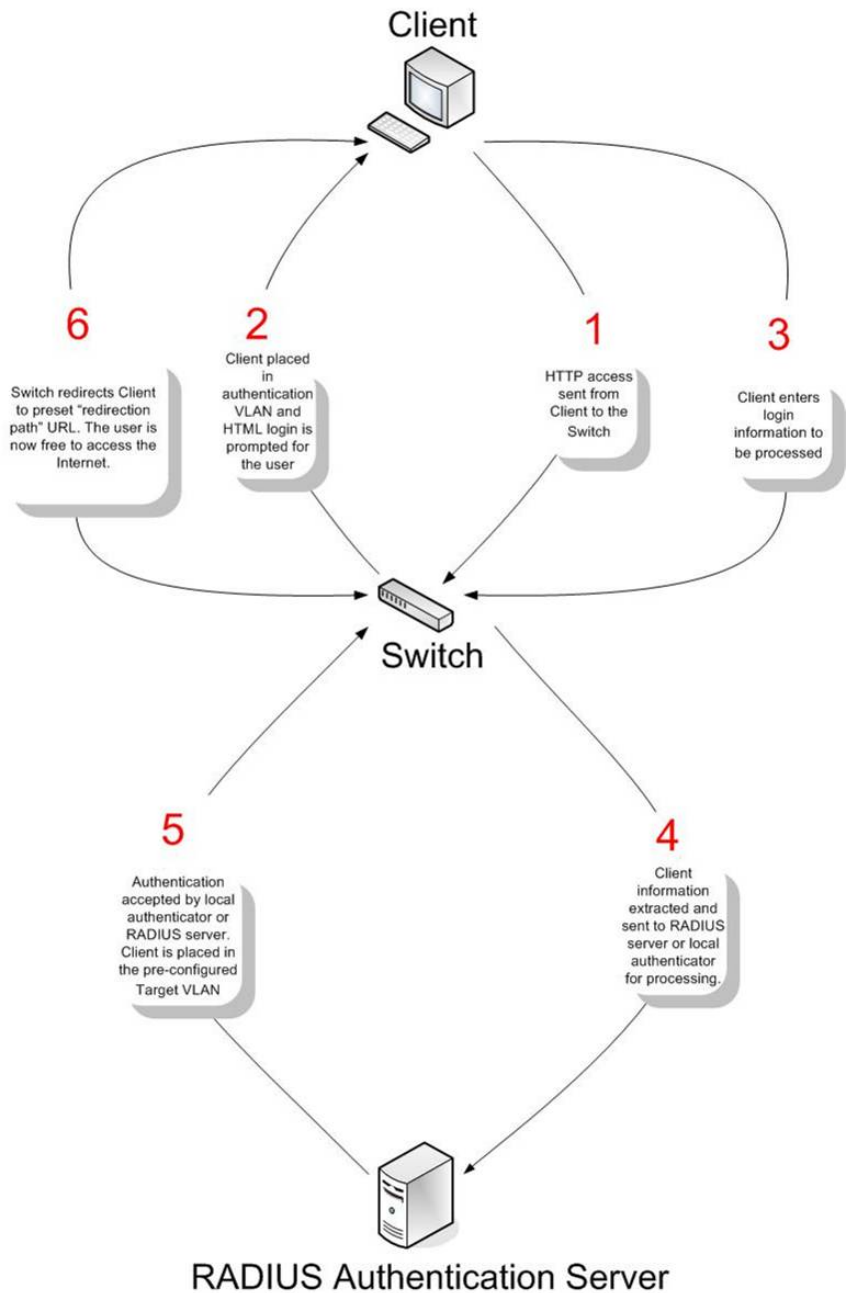

Conditions and Limitations

1. The subnet of the authentication VLAN's IP interface must be the same as that of the client. If not configured properly, the authentication will be permanently denied by the authenticator. It cannot be a Guest VLAN.
2. If the client is utilizing DHCP to attain an IP address, the authentication VLAN must provide a DHCP server or a DHCP relay function so that client may obtain an IP address.
3. The authentication VLAN of this function must be configured to access a DNS server to improve CPU performance, and allow the processing of DNS, UDP and HTTP packets.
4. Certain functions exist on the Switch that will filter HTTP packets, such as the Access Profile function. The user needs to be very careful when setting filter functions for the target VLAN, so that these HTTP packets are not denied by the Switch.
5. The Redirection Path must be set before the Web-based Access Control can be enabled. If not, the user will be prompted with an error message and the Web-based Access Control will not be enabled.
6. If a RADIUS server is to be used for authentication, the user must first establish a RADIUS Server with the appropriate parameters, including the target VLAN, before enabling the Web-based Access Control on the Switch.

Web Authentication Control

This window is used to configure the Switch for WAC Configuration.

To view this window, click **Security > Web Authentication > Web Authentication Configuration**, as shown below.

Figure 11- 27. Web-based Access Control Configuration window

To set the Web-based Access Control for the Switch, complete the following fields:

| Parameter | Description |
|---------------------------------------|--|
| Web-based Access Control State | Toggle the State field to either <i>Enabled</i> or <i>Disabled</i> for the Web-based Access Control settings of the Switch. |
| VLAN Name | Enter the VLAN name which users will be placed while authenticated by the Switch or a RADIUS server. This VLAN should be pre-configured to have limited access rights to web based authenticated users. |
| Method | Use the pull down menu to choose the authenticator for Web-based Access Control. The user may choose: <i>Local</i> – Choose this parameter to use the local authentication method of the Switch as the authenticating method for users trying to access the network via the switch. This is, in fact, the username and password to access the Switch configured using the User Account Creation screen seen below. <i>RADIUS</i> – Choose this parameter to use a remote RADIUS server as the authenticating method for users trying to access the network via the switch. This RADIUS server must have already been pre-assigned by the administrator using the RADIUS Server window located in the 802.1X section. |
| Port List | Specify the ports to be enabled as Web-based Access Control ports. Only these ports will accept authentication parameters from the user wishing limited access rights through the Switch. When one client on a port has been authenticated for Web-based Access Control, all clients on this port are authenticated as well. Use the State pull-down menu to enable these configured ports as Web-based Access Control ports. |
| Redirection Path | Enter the URL of the website that authenticated users placed in the VLAN are directed to once authenticated. This path must be entered into this field before the Web-based Access |

Control can be enabled.

Click **Apply** to implement changes made.



NOTE: To enable the Web-based Access Control function, the redirection path field must have the URL of the website that users will be directed to once they enter the limited resource, pre-configured VLAN. Users which attempt Apply settings without the Redirection Page field set will be prompted with an error message and Web-based Access Control will not be enabled. The URL should follow the form <http://www.dlink.com>



NOTE: The subnet of the IP address of the authentication VLAN must be the same as that of the client, or the client will always be denied authentication.



NOTE: A successful authentication should direct the client to the stated web page. If the client does not reach this web page, yet does not receive a Fail! message, the client will already be authenticated and therefore should refresh the current browser window or attempt to open a different web page.

To view Web-based Access Control status of individual ports, click the [Show Port State](#) link to open the window seen below.

| Port | State |
|------|----------|
| 1 | Disabled |
| 2 | Disabled |
| 3 | Disabled |
| 4 | Disabled |

Figure 11- 28. Web-based Access Control Port State window

Use the pull-down menu to select the Switch in the switch stack and then the From and To fields to select a port or range of ports to be viewed for their Web-based Access Control status. In the previous window, ports 1 to 5 have been selected to be viewed.

User Account Management

This window is used to set user accounts for the Web-based Access Control.

To view this window, click **Security > Web Authentication > User Account Management**, as shown below.

| User Account Creation | | | |
|--------------------------|----------------------|-------------------------------------|------------------------------------|
| User Name | Password | Confirmation | Add |
| <input type="text"/> | <input type="text"/> | <input type="text"/> | <input type="button" value="Add"/> |
| User - VLAN Mapping | | | |
| User Name | VLAN Name | Link | |
| <input type="text"/> | <input type="text"/> | <input type="button" value="Link"/> | |
| User List | | | |
| User Name | VLAN Name | Delete | |
| There is no entry found. | | | |
| Total Entries: 0 | | | |

Figure 11- 29. User Account Creation window

To set the User Account settings for the Web-based Access Control by the Switch, complete the following fields.

| Parameter | Description |
|-----------------------|---|
| User Account Creation | |
| User Name | Enter the username of up to 15 alphanumeric characters of the guest wishing to access the web through this process. This field is for administrators who have selected <i>local</i> as their web based authenticator. |
| Password | Enter the password the administrator has chosen for the selected user. This field is case sensitive and must be a complete alphanumeric string. This field is for administrators who have selected <i>local</i> as their web based authenticator. |
| Confirmation | Retype the Password in this field to confirm. |
| User-VLAN Mapping | |
| User Name | Enter the user name of a guest authenticated through this process, to be mapped to a previously configured VLAN with limited rights. |
| VLAN Name | Enter the VLAN name of a previously configured VLAN to which successfully authenticated web user will be mapped. |
| Link | Click the Link button to map the user name and VLAN stated in the previous 2 fields. Users will be linked directly to the VLAN upon successful authentication. |
| User List | This section displays users and their associated VLAN configured for Web-based Access Control. Click the corresponding  to delete the user. |

The following window displays the Authentication Login windows that guest users will be prompted with once attempting Web-based Access Control. Enter the user name and the password configured in the previous window and click **Enter** to access the VLAN previously assigned by the Switch administrator for successful authentication.

| Authentication Login | |
|---|--------------------------|
| User Name | <input type="text"/> |
| Password | <input type="password"/> |
| <input type="button" value="Enter"/> <input type="button" value="Clear"/> | |

Figure 11- 30. Web-based Access Control Authentication Login window

After successfully logging in, the user will be prompted with this window, verifying that the user has successfully authenticated the WAC port.



Figure 11- 31. WAC logout window



NOTE: The previous logout screen may have some problems when using Netscape 7.0. If the port where Web-Access Control is preset to be moved to a VLAN without an IPIF interface, the previous logout screen may also not be presented when logging in.

Trust Host

To view this window, click **Security > Trust Host**, as shown below.

| Security IP | | | |
|---|--------------------------------------|----------|--|
| IP1 Access to Switch | <input type="text" value="0.0.0.0"/> | Net Mask | <input type="text" value="0.0.0.0"/> |
| IP2 Access to Switch | <input type="text" value="0.0.0.0"/> | Net Mask | <input type="text" value="0.0.0.0"/> |
| IP3 Access to Switch | <input type="text" value="0.0.0.0"/> | Net Mask | <input type="text" value="0.0.0.0"/> |
| IP4 Access to Switch | <input type="text" value="0.0.0.0"/> | Net Mask | <input type="text" value="0.0.0.0"/> |
| IP5 Access to Switch | <input type="text" value="0.0.0.0"/> | Net Mask | <input type="text" value="0.0.0.0"/> |
| IP6 Access to Switch | <input type="text" value="0.0.0.0"/> | Net Mask | <input type="text" value="0.0.0.0"/> |
| IP7 Access to Switch | <input type="text" value="0.0.0.0"/> | Net Mask | <input type="text" value="0.0.0.0"/> |
| IP8 Access to Switch | <input type="text" value="0.0.0.0"/> | Net Mask | <input type="text" value="0.0.0.0"/> |
| IP9 Access to Switch | <input type="text" value="0.0.0.0"/> | Net Mask | <input type="text" value="0.0.0.0"/> |
| IP10 Access to Switch | <input type="text" value="0.0.0.0"/> | Net Mask | <input type="text" value="0.0.0.0"/> |
| | | | <input type="button" value="Apply"/> <input type="button" value="Delete All"/> |
| <p>Note : Create a list of IP address that can access the switch. Your local host IP address must be one of the IP addresses to avoid disconnection.</p> | | | |

Figure 11- 32. Security IP window

Use the Security IP Management to permit remote stations to manage the Switch. If you choose to define one or more designated management stations, only the chosen stations, as defined by IP address, will be allowed management privilege through the web manager or Telnet session. To define a management station IP setting, type in the IP address and the corresponding Net Mask and click the **Apply** button.

Access Authentication Control

The TACACS/XTACACS/TACACS+/RADIUS commands allow users to secure access to the Switch using the TACACS/XTACACS/TACACS+/RADIUS protocols. When a user logs in to the Switch or tries to access the administrator level privilege, he or she is prompted for a password. If TACACS/XTACACS/TACACS+/RADIUS authentication is enabled on the Switch, it will contact a TACACS/XTACACS/TACACS+/RADIUS server to verify the user. If the user is verified, he or she is granted access to the Switch.

There are currently three versions of the TACACS security protocol, each a separate entity. The Switch's software supports the following versions of TACACS:

- TACACS (Terminal Access Controller Access Control System) - Provides password checking and authentication, and notification of user actions for security purposes utilizing via one or more centralized TACACS servers, utilizing the UDP protocol for packet transmission.
- Extended TACACS (XTACACS) - An extension of the TACACS protocol with the ability to provide more types of authentication requests and more types of response codes than TACACS. This protocol also uses UDP to transmit packets.
- TACACS+ (Terminal Access Controller Access Control System plus) - Provides detailed access control for authentication for network devices. TACACS+ is facilitated through Authentication commands via one or more centralized servers. The TACACS+ protocol encrypts all traffic between the Switch and the TACACS+ daemon, using the TCP protocol to ensure reliable delivery

In order for the TACACS/XTACACS/TACACS+/RADIUS security function to work properly, a TACACS/XTACACS/TACACS+/RADIUS server must be configured on a device other than the Switch, called an Authentication Server Host and it must include usernames and passwords for authentication. When the user is prompted by the Switch to enter usernames and passwords for authentication, the Switch contacts the TACACS/XTACACS/TACACS+/RADIUS server to verify, and the server will respond with one of three messages:

- The server verifies the username and password, and the user is granted normal user privileges on the Switch.
- The server will not accept the username and password and the user is denied access to the Switch.
- The server doesn't respond to the verification query. At this point, the Switch receives the timeout from the server and then moves to the next method of verification configured in the method list.

The Switch has four built-in Authentication Server Groups, one for each of the TACACS, XTACACS, TACACS+ and RADIUS protocols. These built-in Authentication Server Groups are used to authenticate users trying to access the Switch. The users will set Authentication Server Hosts in a preferable order in the built-in Authentication Server Groups and when a user tries to gain access to the Switch, the Switch will ask the first Authentication Server Hosts for authentication. If no authentication is made, the second server host in the list will be queried, and so on. The built-in Authentication Server Groups can only have hosts that are running the specified protocol. For example, the TACACS Authentication Server Groups can only have TACACS Authentication Server Hosts.

The administrator for the Switch may set up six different authentication techniques per user-defined method list (TACACS/XTACACS/TACACS+/RADIUS/local/none) for authentication. These techniques will be listed in an order preferable, and defined by the user for normal user authentication on the Switch, and may contain up to eight authentication techniques. When a user attempts to access the Switch, the Switch will select the first technique listed for authentication. If the first technique goes through its Authentication Server Hosts and no authentication is returned, the Switch will then go to the next technique listed in the server group for authentication, until the authentication has been verified or denied, or the list is exhausted.

Please note that users granted access to the Switch will be granted normal user privileges on the Switch. To gain access to administrator level privileges, the user must access the **Enable Admin** window and then enter a password, which was previously configured by the administrator of the Switch.



NOTE: TACACS, XTACACS and TACACS+ are separate entities and are not compatible. The Switch and the server must be configured exactly the same, using the same protocol. (For example, if the Switch is set up for TACACS authentication, so must be the host server.)

Authentication Policy and Parameter Settings

This command will enable an administrator-defined authentication policy for users trying to access the Switch. When enabled, the device will check the Login Method List and choose a technique for user authentication upon login.

To view this window, click **Security > Access Authentication Control > Authentication Policy and Parameter Setting**, as shown below.

| Authentication Policy and Parameter Settings | |
|--|-----------|
| Authentication Policy | Enabled ▾ |
| Response Timeout (0-255) | 30 |
| User Attempts (1-255) | 3 |
| Apply | |

Figure 11- 33. Authentication Policy and Parameter Settings window

The following parameters can be set:

| Parameters | Description |
|---------------------------------|--|
| Authentication Policy | Use the pull-down menu to enable or disable the Authentication Policy on the Switch. |
| Response Timeout (0-255) | This field will set the time the Switch will wait for a response of authentication from the user. The user may set a time between 0 and 255 seconds. The default setting is 30 seconds. |
| User Attempts (1-255) | This command will configure the maximum number of times the Switch will accept authentication attempts. Users failing to be authenticated after the set amount of attempts will be denied access to the Switch and will be locked out of further authentication attempts. Command line interface users will have to wait 60 seconds before another authentication attempt. Telnet and Web users will be disconnected from the Switch. The user may set the number of attempts from 1 to 255. The default setting is 3. |

Click **Apply** to implement changes made.

Application Authentication Settings

This window is used to configure switch configuration applications (console, Telnet, SSH, web) for login at the user level and at the administration level (Enable Admin) utilizing a previously configured method list.

To view this window, click **Security > Access Authentication Control > Application Authentication Settings**, as shown below.

| Application Authentication Settings | | |
|-------------------------------------|-------------------|--------------------|
| Application | Login Method List | Enable Method List |
| Console | default ▾ | default ▾ |
| Telnet | default ▾ | default ▾ |
| SSH | default ▾ | default ▾ |
| HTTP | default ▾ | default ▾ |
| Apply | | |

Figure 11- 34. Application Authentication Settings window

The following parameters can be set:

| Parameter | Description |
|--------------------|---|
| Application | Lists the configuration applications on the Switch. The user may configure the Login Method List and Enable Method List for authentication for users utilizing the Console (Command |

| | |
|---------------------------|---|
| | Line Interface) application, the Telnet application, SSH and the WEB (HTTP) application. |
| Login Method List | Using the pull-down menu, configure an application for normal login on the user level, utilizing a previously configured method list. The user may use the default Method List or other Method List configured by the user. See the Login Method Lists window, in this section, for more information. |
| Enable Method List | Using the pull-down menu, configure an application for normal login on the user level, utilizing a previously configured method list. The user may use the default Method List or other Method List configured by the user. See the Enable Method Lists window, in this section, for more information. |

Click **Apply** to implement changes made.

Authentication Server Group

This window will allow users to set up Authentication Server Groups on the Switch. A server group is a technique used to group TACACS/XTACACS/TACACS+/RADIUS server hosts into user-defined categories for authentication using method lists. The user may define the type of server group by protocol or by previously defined server group. The Switch has four built-in Authentication Server Groups that cannot be removed but can be modified. Up to eight authentications server hosts may be added to any particular group.

To view this window, click **Security > Access Authentication Control > Authentication Server Group**, as shown below.



Figure 11- 35. Authentication Server Group window

This window displays the Authentication Server Groups on the Switch. The Switch has four built-in Authentication Server Groups that cannot be removed but can be modified. To modify a particular group, click its hyperlinked Group Name, which will then display the following window.

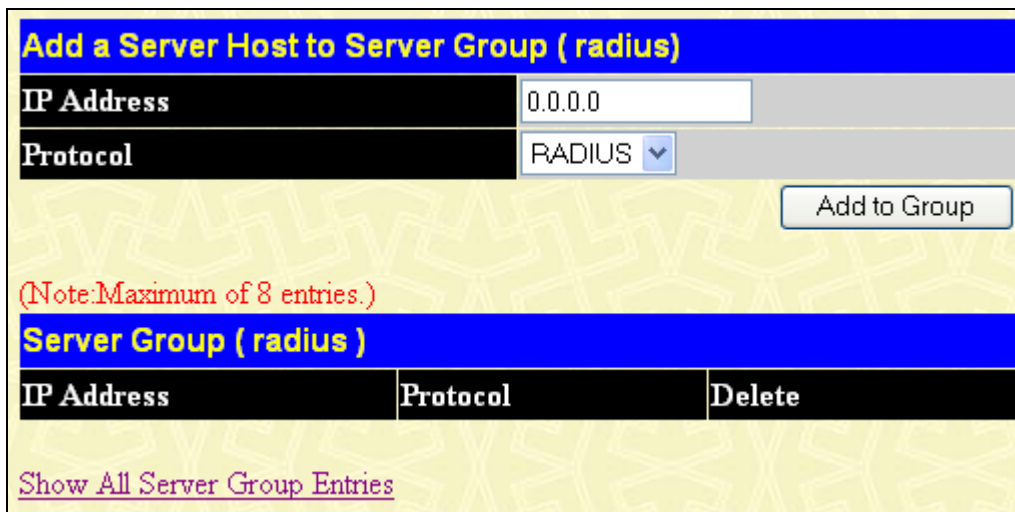

Figure 11- 36. Add a Server Host to Server Group (radius) window

To add an Authentication Server Host to the list, enter its IP address in the IP Address field, choose the protocol associated with the IP address of the Authentication Server Host and click **Add to Group** to add this Authentication Server Host to the group.

To add a user-defined group to the list, click the **Add** button in the **Authentication Server Group** window, which will display the following window.



Figure 11- 37. Authentication Server Group Table Add Settings window

Simply enter a group name of no more than 15 alphanumeric characters to define the user group to add. After clicking **Apply**, the new user-defined group will be displayed in the **Authentication Server Group** window. Here, it can be configured as the user desires.



NOTE: The user must configure Authentication Server Hosts using the Authentication Server Hosts window before adding hosts to the list. Authentication Server Hosts must be configured for their specific protocol on a remote centralized server before this function can work properly.



NOTE: The four built in server groups can only have server hosts running the same TACACS daemon. TACACS/XTACACS/TACACS+ protocols are separate entities and are not compatible with each other.

Authentication Server Host

This window will set user-defined Authentication Server Hosts for the TACACS/XTACACS/TACACS+/RADIUS security protocols on the Switch. When a user attempts to access the Switch with Authentication Policy enabled, the Switch will send authentication packets to a remote TACACS/XTACACS/TACACS+/RADIUS server host on a remote host. The TACACS/XTACACS/TACACS+/RADIUS server host will then verify or deny the request and return the appropriate message to the Switch. More than one authentication protocol can be run on the same physical server host but, remember that TACACS/XTACACS/TACACS+/RADIUS are separate entities and are not compatible with each other. The maximum supported number of server hosts is 16.

To view this window, click **Security > Access Authentication Control > Authentication Server Host**, as shown below.

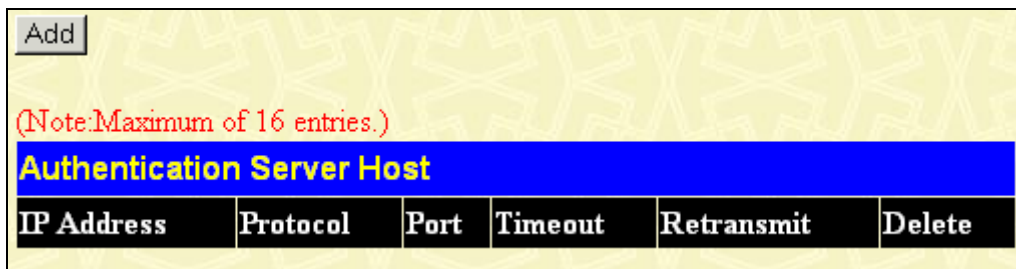

Figure 11- 38. Authentication Server Host Setting window

To add an Authentication Server Host, click the **Add** button, revealing the following window:

Figure 11- 39. Authentication Server Host Setting – Add window

To edit an Authentication Server Host, click the IP address hyperlink.

Configure the following parameters to add or edit an Authentication Server Host:

| Parameter | Description |
|---------------------------|--|
| IP Address | The IP address of the remote server host to add. |
| Protocol | The protocol used by the server host. The user may choose one of the following: <ul style="list-style-type: none"> • <i>TACACS</i> - Enter this parameter if the server host utilizes the TACACS protocol. • <i>XTACACS</i> - Enter this parameter if the server host utilizes the XTACACS protocol. • <i>TACACS+</i> - Enter this parameter if the server host utilizes the TACACS+ protocol. • <i>RADIUS</i> - Enter this parameter if the server host utilizes the RADIUS protocol. |
| Port (1-65535) | Enter a number between 1 and 65535 to define the virtual port number of the authentication protocol on a server host. The default port number is 49 for TACACS/XTACACS/TACACS+ servers and 1813 for RADIUS servers but the user may set a unique port number for higher security. |
| Timeout (1-255) | Enter the time in seconds the Switch will wait for the server host to reply to an authentication request. The default value is 5 seconds. |
| Retransmit (1-255) | Enter the value in the retransmit field to change how many times the device will resend an authentication request when the TACACS server does not respond. |
| Key | Authentication key to be shared with a configured TACACS+ or RADIUS servers only. Specify an alphanumeric string up to 254 characters. |

Click **Apply** to add the server host.



NOTE: More than one authentication protocol can be run on the same physical server host but, remember that TACACS/XTACACS/TACACS+ are separate entities and are not compatible with each other

Login Method Lists

This command will configure a user-defined or default Login Method List of authentication techniques for users logging on to the Switch. The sequence of techniques implemented in this command will affect the authentication result. For example, if a user enters a sequence of techniques, for example TACACS – XTACACS - local, the Switch will send an authentication request to the first TACACS host in the server group. If no response comes from the server host, the Switch will send an authentication request to the second TACACS host in the server group and so on, until the list is exhausted. At that point, the Switch will restart the same sequence with the following protocol listed, XTACACS. If no authentication takes place using the XTACACS list, the local account database set in the Switch is used to authenticate the user. When the local method is used, the privilege level will be dependant on the local account privilege configured on the Switch.

Successful login using any of these techniques will give the user a "User" privilege only. To upgrade his or her status to the administrator level, the user must use the **Enable Admin** window, in which the user must enter a previously configured password, set by the administrator. (See the Enable Admin part of this section for more detailed information concerning the Enable Admin command.)

To view this window, click **Security > Access Authentication Control > Login Method Lists**, as shown below.

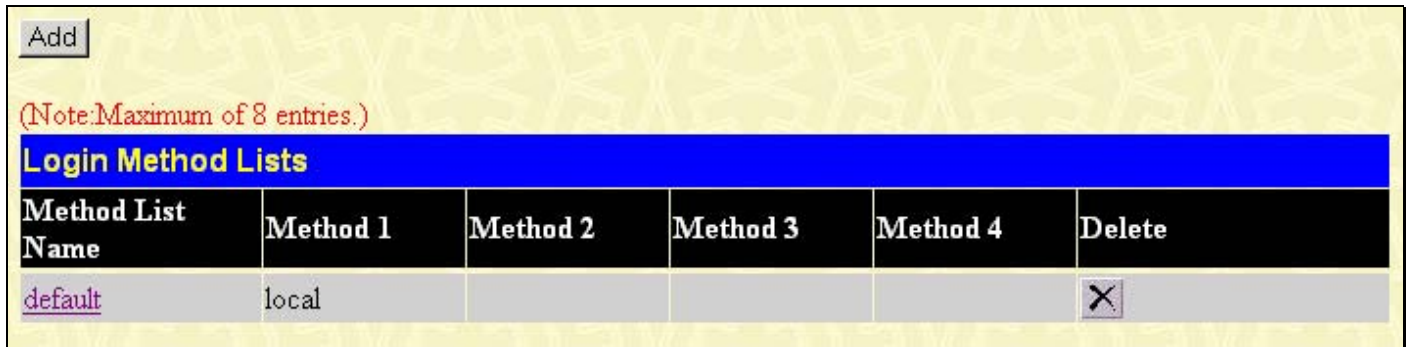

Figure 11- 40. Login Method Lists window

The Switch contains one Method List that is set and cannot be removed, yet can be modified. To delete a Login Method List defined by the user, click the X under the Delete heading corresponding to the entry desired to be deleted. To modify a Login Method List, click on its hyperlinked Method List Name. To configure a new Method List, click the **Add** button.

Both actions will result in the same window to configure:

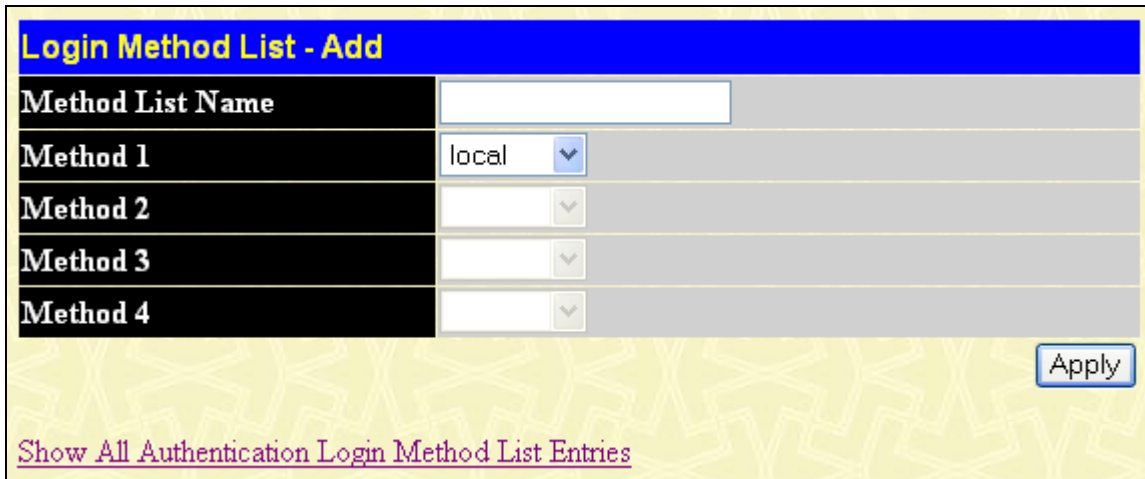

Figure 11- 41. Login Method List – Add window

To define a Login Method List, set the following parameters and click **Apply**:

| Parameter | Description |
|--------------------------|--|
| Method List Name | Enter a method list name defined by the user of up to 15 characters. |
| Method 1, 2, 3, 4 | The user may add one, or a combination of up to four of the following authentication methods to this method list: <ul style="list-style-type: none"> <i>tacacs</i> - Adding this parameter will require the user to be authenticated using the TACACS protocol from a remote TACACS server. |

| | |
|--|---|
| | <ul style="list-style-type: none"> • <i>xtacacs</i> - Adding this parameter will require the user to be authenticated using the XTACACS protocol from a remote XTACACS server. • <i>tacacs+</i> - Adding this parameter will require the user to be authenticated using the TACACS+ protocol from a remote TACACS+ server. • <i>radius</i> - Adding this parameter will require the user to be authenticated using the RADIUS protocol from a remote RADIUS server. • <i>server_group</i> - Adding this parameter will require the user to be authenticated using a user-defined server group previously configured on the Switch. • <i>local</i> - Adding this parameter will require the user to be authenticated using the local user account database on the Switch. • <i>none</i> - Adding this parameter will require an authentication to access the Switch. |
|--|---|

Enable Method Lists

The **Enable Method Lists** window is used to set up Method Lists to promote users with user level privileges to Administrator (Admin) level privileges using authentication methods on the Switch. Once a user acquires normal user level privileges on the Switch, he or she must be authenticated by a method on the Switch to gain administrator privileges on the Switch, which is defined by the Administrator. A maximum of eight Enable Method Lists can be implemented on the Switch, one of which is a default Enable Method List. This default Enable Method List cannot be deleted but can be configured.

The sequence of methods implemented in this command will affect the authentication result. For example, if a user enters a sequence of methods like TACACS - XTACACS - Local Enable, the Switch will send an authentication request to the first TACACS host in the server group. If no verification is found, the Switch will send an authentication request to the second TACACS host in the server group and so on, until the list is exhausted. At that point, the Switch will restart the same sequence with the following protocol listed, XTACACS. If no authentication takes place using the XTACACS list, the Local Enable password set in the Switch is used to authenticate the user.

Successful authentication using any of these methods will give the user a "user" privilege.



NOTE: To set the Local Enable Password, see the next section, entitled Local Enable Password.

To view this table, click **Security > Access Authentication Control > Enable Method Lists**, as shown below.

| <input type="button" value="Add"/> | | | | | |
|------------------------------------|--------------|----------|----------|----------|----------------------------------|
| (Note: Maximum of 8 entries.) | | | | | |
| Enable Method Lists | | | | | |
| Method List Name | Method 1 | Method 2 | Method 3 | Method 4 | Delete |
| default | local_enable | | | | <input type="button" value="X"/> |

Figure 11- 42. Enable Method Lists window

To delete an Enable Method List defined by the user, click the under the Delete heading corresponding to the entry desired to be deleted. To modify an Enable Method List, click on its hyperlinked Method List Name. To configure a Method List, click the **Add** button.

Both actions will result in the same window to configure:

Figure 11- 43. Enable Method List - Add window

To define an Enable Login Method List, set the following parameters and click **Apply**:

| Parameter | Description |
|--------------------------|--|
| Method List Name | Enter a method list name defined by the user of up to 15 characters. |
| Method 1, 2, 3, 4 | <p>The user may add one, or a combination of up to four of the following authentication methods to this method list:</p> <ul style="list-style-type: none"> • <i>local_enable</i> - Adding this parameter will require the user to be authenticated using the local enable password database on the Switch. The user in the next section entitled Local Enable Password must set the local enable password. • <i>none</i> - Adding this parameter will require an authentication to access the Switch. • <i>radius</i> - Adding this parameter will require the user to be authenticated using the RADIUS protocol from a remote RADIUS server. • <i>tacacs</i> - Adding this parameter will require the user to be authenticated using the TACACS protocol from a remote TACACS server. • <i>xtacacs</i> - Adding this parameter will require the user to be authenticated using the XTACACS protocol from a remote XTACACS server. • <i>tacacs+</i> - Adding this parameter will require the user to be authenticated using the TACACS protocol from a remote TACACS server. • <i>server_group</i> - Adding a previously configured server group will require the user to be authenticated using a user-defined server group previously configured on the Switch. |

Configure Local Enable Password

This window will configure the locally enabled password for the Enable Admin command. When a user chooses the "local_enable" method to promote user level privileges to administrator privileges, he or she will be prompted to enter the password configured here that is locally set on the Switch.

To view this window, click **Security > Access Authentication Control > Configure Local Enable Password**, as shown below.

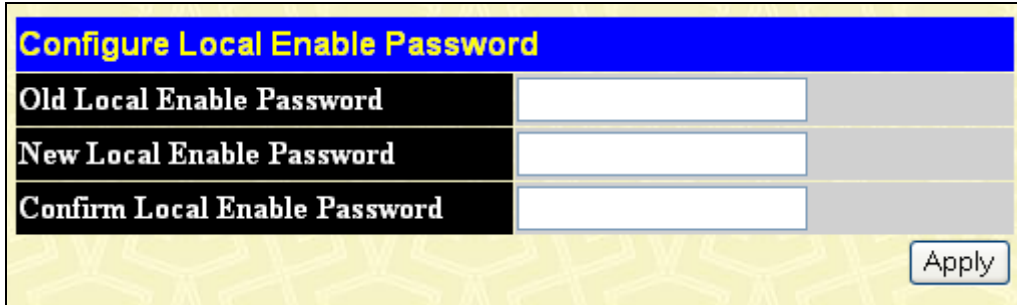

Figure 11- 44. Configure Local Enable Password window

To set the Local Enable Password, set the following parameters and click **Apply**.

| Parameter | Description |
|--------------------------------------|--|
| Old Local Enable Password | If a password was previously configured for this entry, enter it here in order to change it to a new password |
| New Local Enable Password | Enter the new password that you wish to set on the Switch to authenticate users attempting to access Administrator Level privileges on the Switch. The user may set a password of up to 15 characters. |
| Confirm Local Enable Password | Confirm the new password entered above. Entering a different password here from the one set in the New Local Enabled field will result in a fail message. |

Enable Admin

The **Enable Admin** window is for users who have logged on to the Switch on the normal user level, and wish to be promoted to the administrator level. After logging on to the Switch, users will have only user level privileges. To gain access to administrator level privileges, the user will open this window and will have to enter an authentication password. Possible authentication methods for this function include TACACS/XTACACS/TACACS+/RADIUS, user defined server groups, local enable (local account on the Switch), or no authentication (none). Because XTACACS and TACACS do not support the enable function, the user must create a special account on the server host, which has the username "enable", and a password configured by the administrator that will support the "enable" function. This function becomes inoperable when the authentication policy is disabled.

When this window appears, click the **Enable Admin** button revealing a dialog box for the user to enter authentication (password, username). A successful entry will promote the user to Administrator level privileges on the Switch.

To view this window, click **Security > Access Authentication Control > Enable Admin**, as shown.

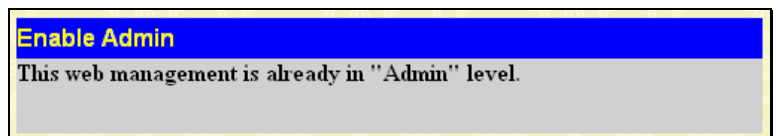

Figure 11- 45. Enable Admin window



Figure 11- 46. Enter Network Password dialog box

MAC Based Access Control

The MAC-based Access Control feature will allow users to configure a list of MAC addresses, either locally or on a remote RADIUS server, to be authenticated by the Switch and given access rights based on the configurations set on the Switch of the target VLAN where these authenticated users are placed.

For local authentication on the Switch, the user must enter a list of MAC addresses to be accepted through this mechanism using the MAC-based Access Control Global Settings window, as seen below. The user may enter up to 128 MAC addresses locally on the Switch but only 128 MAC addresses can be accepted per physical MAC-based Access Control enabled port. Once a MAC address has been authenticated by the Switch on the local side, the port where that MAC address resides will be placed in the previously configured target VLAN, where the rights and privileges are set by the switch administrator. If the VLAN Name for the target VLAN is not found by the Switch, the Switch will return the port containing that MAC address to the originating VLAN. If the MAC address is not found and the port is in the Guest VLAN, it will remain in the Guest VLAN, with the associated rights. If the port is not in the guest VLAN, this MAC address will be blocked by the Switch.

For remote RADIUS server authentication, the user must first configure the RADIUS server with a list of MAC addresses and relative target VLANs that are to be authenticated on the Switch. Once a MAC address has been discovered by the Switch, the Switch will then query the remote RADIUS server with this potential MAC address, using a RADIUS Access Request packet. If a match is made with this MAC address, the RADIUS server will return a notification stating that the MAC address has been accepted and is to be placed in the target VLAN. If the VID for the target VLAN is not found, the Switch will return the port containing the MAC address to the original VLAN. If the MAC address is not found, and if the port is in the Guest VLAN, it will remain in the Guest VLAN, with the associated rights. If the port is not in the guest VLAN, this MAC address will be blocked by the Switch.

Notes About MAC-based Access Control

There are certain limitations and regulations regarding the MAC-based Access Control:

Once this feature is enabled for a port, the Switch will clear the FDB of that port.

MAC-based Access Control is its own entity and is not dependant on other authentication functions on the Switch, such as 802.1X, Web-Based authentication etc.

A port accepts a maximum of 128 authenticated MAC addresses in local mode and 200 MAC addresses in radius mode per physical port of a VLAN that is not a Guest VLAN. Other MAC addresses attempting authentication on a port with the maximum number of authenticated MAC addresses will be blocked.

Ports that have been enabled for Link Aggregation, stacking, 802.1X authentication, 802.1X Guest VLAN, Port Security, GVRP or Web-based authentication cannot be enabled for the MAC-based Authentication.

MAC-based Access Control Guest VLAN cannot be a member of a Web-based authentication VLAN.

MAC-based Access Control Global Settings

The following window is used to set the parameters for the MAC-based Access Control function on the Switch. Here the user can set the running state, method of authentication, RADIUS password and view the Guest VLAN configuration to be associated with the MAC-based Access Control function of the Switch.

To enable these Settings, click **Security > MAC Based Access Control > MAC-based Access Control Global Settings**, as shown below.

MAC Based Access Control Global Settings

| | |
|--------------------------------|---|
| State | Disabled <input type="button" value="v"/> |
| Method | Local <input type="button" value="v"/> |
| Password | default <input type="text"/> |
| Guest VLAN Name | <input type="text"/> <input type="button" value="v"/> |
| Guest VLAN ID | <input type="text"/> <input type="button" value="v"/> |
| Guest VLAN Member Ports | <input type="text"/> |

MAC Based Access Control Port Settings

| Unit | From | To | State | Mode | Aging Time(1-1440 min) | Hold Time(1-300 sec) | Apply |
|------------------------------------|---|---|---|---|--|---------------------------------------|--------------------------------------|
| 1 <input type="button" value="v"/> | Port 1 <input type="button" value="v"/> | Port 1 <input type="button" value="v"/> | Disabled <input type="button" value="v"/> | Port Based <input type="button" value="v"/> | 1440 <input type="checkbox"/> Infinite | 300 <input type="checkbox"/> Infinite | <input type="button" value="Apply"/> |

MAC Based Access Control Port Table

| Port | State | Aging Time | Hold Time | Auth Mode |
|------|----------|------------|-----------|------------|
| 1 | Disabled | 1440 | 300 | Host Based |
| 2 | Disabled | 1440 | 300 | Host Based |
| 3 | Disabled | 1440 | 300 | Host Based |
| 4 | Disabled | 1440 | 300 | Host Based |
| 5 | Disabled | 1440 | 300 | Host Based |
| 6 | Disabled | 1440 | 300 | Host Based |
| 7 | Disabled | 1440 | 300 | Host Based |
| 8 | Disabled | 1440 | 300 | Host Based |
| 9 | Disabled | 1440 | 300 | Host Based |
| 10 | Disabled | 1440 | 300 | Host Based |
| 11 | Disabled | 1440 | 300 | Host Based |
| 12 | Disabled | 1440 | 300 | Host Based |
| 13 | Disabled | 1440 | 300 | Host Based |
| 14 | Disabled | 1440 | 300 | Host Based |
| 15 | Disabled | 1440 | 300 | Host Based |
| 16 | Disabled | 1440 | 300 | Host Based |
| 17 | Disabled | 1440 | 300 | Host Based |
| 18 | Disabled | 1440 | 300 | Host Based |
| 19 | Disabled | 1440 | 300 | Host Based |
| 20 | Disabled | 1440 | 300 | Host Based |
| 21 | Disabled | 1440 | 300 | Host Based |
| 22 | Disabled | 1440 | 300 | Host Based |
| 23 | Disabled | 1440 | 300 | Host Based |
| 24 | Disabled | 1440 | 300 | Host Based |
| 25 | Disabled | 1440 | 300 | Host Based |

Figure 11- 47. MAC Based Access Control Global Settings window

The following parameters may be viewed or set:

| Parameter | Description |
|-----------------|---|
| Settings | |
| State | Use the pull-down menu to globally enable or disable the MAC-based Access Control |

| | |
|---|---|
| | function on the Switch. |
| Method | <p>Use the pull-down menu to choose the type of authentication to be used when authentication MAC addresses on a given port. The user may choose between the following methods:</p> <p><i>Local</i> – Use this method to utilize the locally set MAC address database as the authenticator for MAC-based Access Control. This MAC address list can be configured in the MAC-based Access Control Local Database Settings window.</p> <p><i>RADIUS</i> – Use this method to utilize a remote RADIUS server as the authenticator for MAC-based Access Control. Remember, the MAC list must be previously set on the RADIUS server and the settings for the server must be first configured on the Switch.</p> |
| Password | Enter the password for the RADIUS server, which is to be used for packets being sent requesting authentication. The default password is “default”. |
| Guest VLAN Name/Guest VLAN ID | Select the method of identification, either Guest VLAN name or guest VLAN ID before entering the name or ID of the Guest VLAN being used for this function. |
| Guest VLAN Member Ports | Enter the list of ports that you wish to configure for the Guest VLAN. |
| MAC Based Access Control Port Settings | |
| Unit | Enter the unit you wish to configure. |
| From...To | Enter the Port range. |
| State | Use the pull-down menu to <i>Enable</i> or <i>Disable</i> the MAC-based Access Control function on individual ports. |
| Mode | <p><i>Port Based:</i> In this mode, if one of the attached hosts is successfully authorized, all hosts on the same port will be granted access to the network. If the port authorization fails, this port will continue authenticating.</p> <p><i>Host Based:</i> In this mode, every user can individually authenticate and access the network.</p> |
| Aging Time(1-1440 min) | <p>A time period (configurable per port) between 1-1440 minutes, during which an authenticated host will stay in an authenticated state. When the aging time has expired, the host will be moved back to an unauthenticated state.</p> <p>When aging time is set to infinite, it will disable the aging time.</p> |
| Hold Time(1-300 sec) | If a host fails to pass the authentication it will be blocked for a period of time referred to as hold time (per port configurable). During this time, this host can't proceed to the authenticating process (unless the user clears the database manually). As a result, this hold mechanism can prevent the switch from frequent authentication which consumes too much computing power. |

Click **Apply** to implement settings.

MAC-based Access Control Local MAC Settings

The following window is used to set a list of MAC addresses, along with their corresponding target VLAN, which will be authenticated for the Switch. Once a queried MAC address is matched in this table, it will be placed in the VLAN associated with it here. The switch administrator may enter up to 128 MAC addresses to be authenticated using the local method configured here.

To enable these Settings, click **Security > MAC Based Access Control > MAC Based Access Control Local MAC Settings**, as shown below.

MAC Based Access Control Local MAC Settings

MAC Address Find By MAC Delete By MAC

VLAN Name Find By VLAN Delete By VLAN

VID Find By VID Delete By VID

Add

Total Entries: 0

MAC Based Access Control Local MAC Table

| MAC Address | VLAN Name | VID | Modify |
|-------------|-----------|-----|--------|
|-------------|-----------|-----|--------|

Figure 11- 48. MAC Based Access Control Local MAC Settings

To set the following parameters:

| Parameter | Description |
|----------------------|--|
| MAC Address | To search for a previously configured MAC address, enter the address and click Find By MAC . If you want to add the entry to the MAC Based Access Control Local MAC Table, click the Add button. To delete an entry click the Delete By MAC button. |
| VLAN Name/VID | To search for a previously configured VLAN Name/VLAN ID, enter the information and click Find By VLAN . If you want to add the entry to the MAC Based Access Control Local MAC Table, click the Add button. To delete an entry click the Delete By VLAN button. |

To edit an entry click the corresponding **Modify** button.

Safeguard Engine

Periodically, malicious hosts on the network will attack the Switch by utilizing packet flooding (ARP Storm) or other methods. These attacks may increase the Safeguard Engine beyond its capability. To alleviate this problem, the Safeguard Engine function was added to the Switch's software.

The Safeguard Engine can help the overall operability of the Switch by minimizing the workload of the Switch while the attack is ongoing, thus making it capable to forward essential packets over its network in a limited bandwidth. When the Switch either (a) receives too many packets to process or (b) exerts too much memory, it will enter an Exhausted mode. When in this mode, the Switch will drop all ARP and IP broadcast packets for a calculated time interval. Every five seconds, the Switch will check to see if there are too many packets flooding the Switch. If the threshold has been crossed, the Switch will initially stop all ingress ARP and IP broadcast packets for five seconds. After another five-second checking interval arrives, the Switch will again check the ingress flow of packets. If the flooding has stopped, the Switch will again begin accepting all packets. Yet, if the checking shows that there continues to be too many packets flooding the Switch, it will stop accepting all ARP and IP broadcast packets for double the time of the previous stop period. This doubling of time for stopping ingress ARP and IP broadcast packets will continue until the maximum time has been reached, which is 320 seconds and every stop from this point until a return to normal ingress flow would be 320 seconds. For a better understanding, examine the following example of the Safeguard Engine.

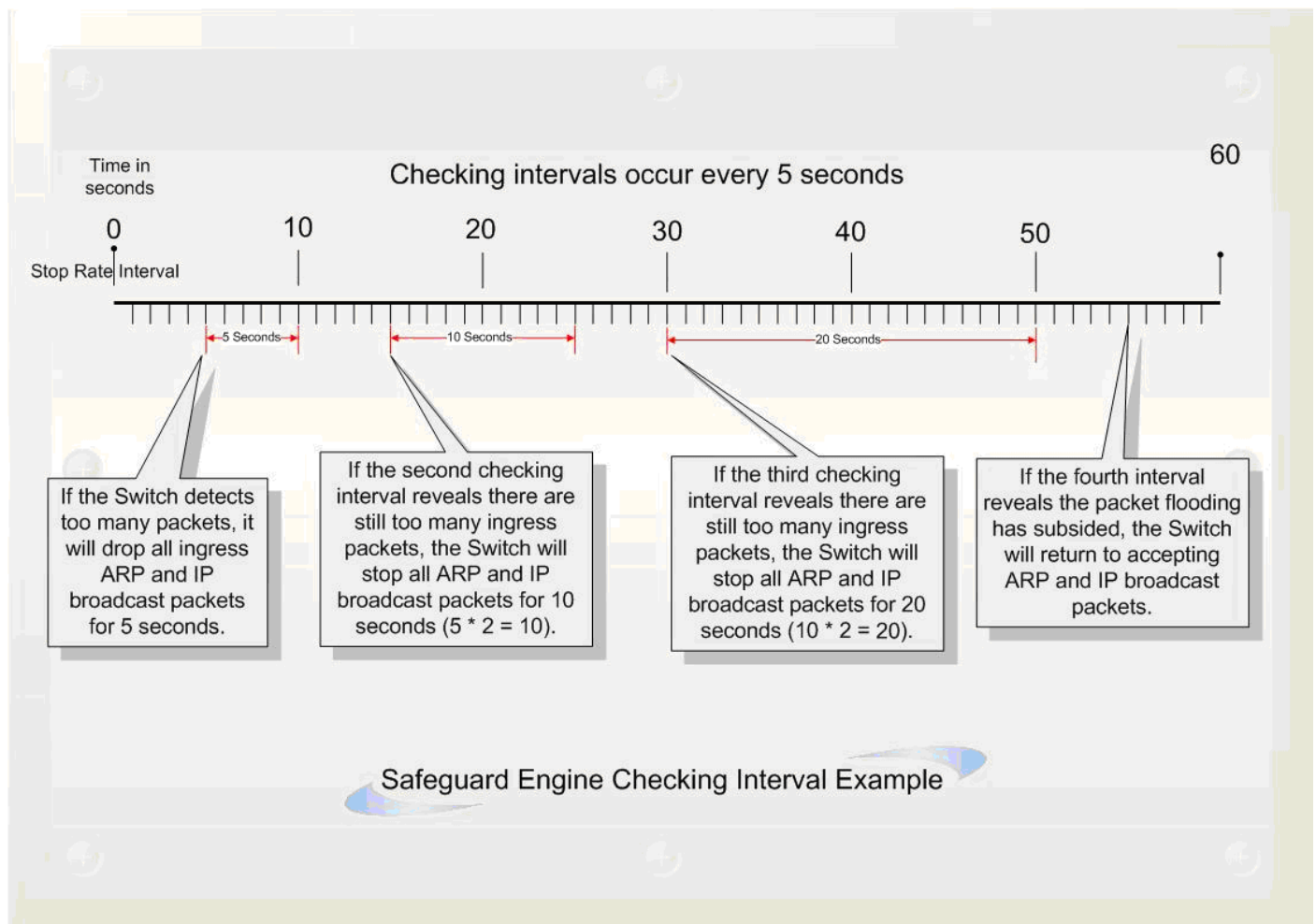

Figure 11- 49. Safeguard Engine example

For every consecutive checking interval that reveals a packet flooding issue, the Switch will double the time it will discard ingress ARP and IP broadcast packets. In the example above, the Switch doubled the time for dropping ARP and IP broadcast packets when consecutive flooding issues were detected at 5-second intervals. (First stop = 5 seconds, second stop = 10 seconds, third stop = 20 seconds) Once the flooding is no longer detected, the wait period for dropping ARP and IP broadcast packets will return to 5 seconds and the process will resume.

Once in Exhausted mode, the packet flow will decrease by half of the level that caused the Switch to enter Exhausted mode. After the packet flow has stabilized, the rate will initially increase by 25% and then return to a normal packet flow.



NOTICE: When Safeguard Engine is enabled, the Switch will allot bandwidth to various traffic flows (ARP, IP) using the FFP (Fast Filter Processor) metering table to control the CPU utilization and limit traffic. This may limit the speed of routing traffic over the network.

Safeguard Engine Settings

To window is used to enable Safeguard Engine or configure advanced Safeguard Engine settings for the Switch.

To configure the Safeguard Engine settings, click **Security > Safeguard Engine > Safeguard Engine Settings**, as shown below.,

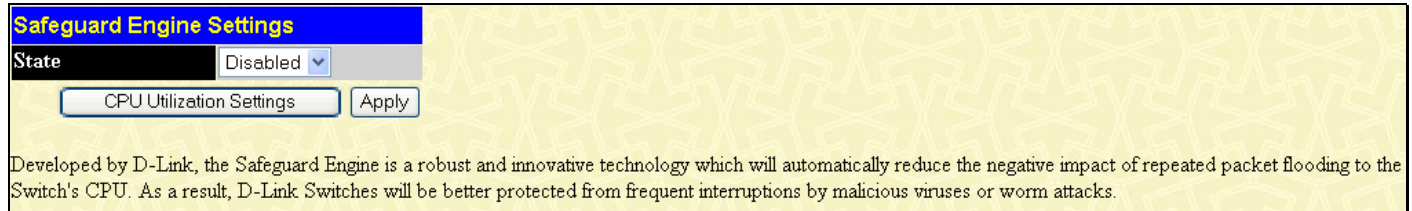

Figure 11- 50. Safeguard Engine Settings window

To enable the Safeguard Engine option, select *Enabled* with the drop-down State menu and click the **Apply** button.

To configure the advanced settings for Safeguard Engine, click the **CPU Utilization Settings** button to view the following window.

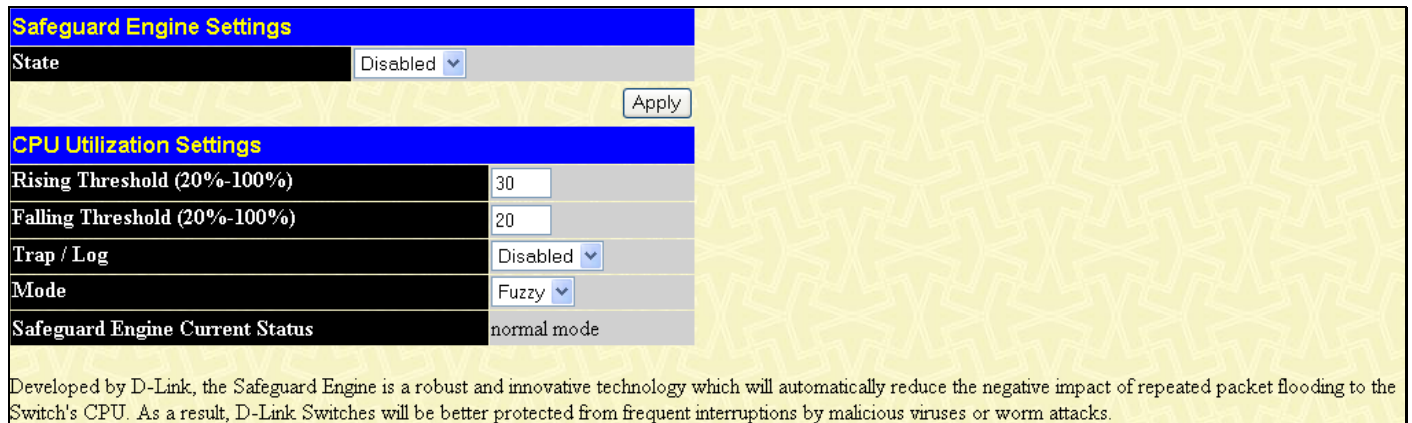

Figure 11- 51. Safeguard Engine Settings window

To configure the following parameters:

| Parameter | Description |
|-------------------------------------|--|
| State | Use the pull-down menu to globally enable or disable Safeguard Engine settings for the Switch. |
| Rising Threshold (20%-100%) | Used to configure the acceptable level of CPU utilization before the Safeguard Engine mechanism is enabled. Once the CPU utilization reaches this percentage level, the Switch will move into Safeguard Engine state, based on the parameters provided in this window. |
| Falling Threshold (20%-100%) | Used to configure the acceptable level of CPU utilization as a percentage, where the Switch leaves the Safeguard Engine state and returns to normal mode. |
| Trap / Log | Use the pull-down menu to enable or disable the sending of messages to the device's SNMP agent and switch log once the Safeguard Engine has been activated by a high CPU utilization rate. |
| Mode | Used to select the type of Safeguard Engine to be activated by the Switch when the CPU utilization reaches a high rate. The user may select: <i>Fuzzy</i> – If selected, this function will instruct the Switch to minimize the IP and ARP traffic flow to the CPU by dynamically allotting an even bandwidth to all traffic flows. <i>Strict</i> – If selected, this function will stop accepting all ARP packets not intended for the Switch, and will stop receiving all unnecessary broadcast IP packets, until the storm has subsided. The default setting is <i>Fuzzy</i> mode. |

Traffic Segmentation

Traffic segmentation is used to limit traffic flow from a single port to a group of ports on either a single switch or a group of ports on another switch in a switch stack. This method of segmenting the flow of traffic is similar to using VLANs to limit traffic, but is more restrictive. It provides a method of directing traffic that does not increase the overhead of the Master switch CPU.

To view the **Traffic Segmentation** window, click **Security > Traffic Segmentation**, as shown below.

| Unit | Port | Configuration | Setup |
|------|--------|---------------|-------|
| 1 | Port 1 | View | Setup |

| Current Traffic Segmentation Table | |
|------------------------------------|----------|
| Unit | Port Map |
| 1 | 1-25 |
| 2 | |
| 3 | |
| 4 | |
| 5 | |
| 6 | |
| 7 | |
| 8 | |
| 9 | |
| 10 | |
| 11 | |
| 12 | |

Figure 11- 52. Current Traffic Segmentation Table window

This window allows you to view which port on a given switch will be allowed to forward packets to other ports on that switch. Select the unit you wish to configure and a port number from the drop down menu and click **View** to display the forwarding ports. To configure new forwarding ports for a particular port, select a port from the drop down menu and click **Setup**. The window shown below will appear.

| Setup Forwarding Ports | | | | | | | | | | | | | | | | | | | | | | | | | | | | | | | | | | | | | | | | | | | | | | | | | | | | | | | | | | | | | | | | | | | | | | | | | | | | | | | | | | | | | | | | | | | | | | | | | | | | | |
|--|---|-------------------------------------|-------------------------------------|-------------------------------------|-------------------------------------|-------------------------------------|-------------------------------------|-------------------------------------|-------------------------------------|-------------------------------------|-------------------------------------|-------------------------------------|-------------------------------------|-------------------------------------|-------------------------------------|-------------------------------------|-------------------------------------|-------------------------------------|-------------------------------------|-------------------------------------|-------------------------------------|-------------------------------------|-------------------------------------|-------------------------------------|----|----|-------------------------------------|-------------------------------------|-------------------------------------|-------------------------------------|-------------------------------------|-------------------------------------|-------------------------------------|-------------------------------------|-------------------------------------|-------------------------------------|-------------------------------------|-------------------------------------|-------------------------------------|-------------------------------------|-------------------------------------|-------------------------------------|-------------------------------------|-------------------------------------|-------------------------------------|-------------------------------------|-------------------------------------|-------------------------------------|-------------------------------------|-------------------------------------|-------------------------------------|---|---|---|---|---|---|---|---|---|---|---|---|---|---|---|---|---|---|---|---|---|---|---|---|---|---|---|---|---|---|---|---|---|---|---|---|---|---|---|---|---|---|---|---|---|---|---|---|---|---|
| Unit-Port | 1 Port 1 | | | | | | | | | | | | | | | | | | | | | | | | | | | | | | | | | | | | | | | | | | | | | | | | | | | | | | | | | | | | | | | | | | | | | | | | | | | | | | | | | | | | | | | | | | | | | | | | | | | | |
| Forward Unit | 1 | | | | | | | | | | | | | | | | | | | | | | | | | | | | | | | | | | | | | | | | | | | | | | | | | | | | | | | | | | | | | | | | | | | | | | | | | | | | | | | | | | | | | | | | | | | | | | | | | | | | |
| Forward Port | <table border="1"> <thead> <tr> <th>1</th><th>2</th><th>3</th><th>4</th><th>5</th><th>6</th><th>7</th><th>8</th><th>9</th><th>10</th><th>11</th><th>12</th><th>13</th><th>14</th><th>15</th><th>16</th><th>17</th><th>18</th><th>19</th><th>20</th><th>21</th><th>22</th><th>23</th><th>24</th><th>25</th> </tr> </thead> <tbody> <tr> <td><input checked="" type="checkbox"/></td><td><input checked="" type="checkbox"/></td><td><input checked="" type="checkbox"/></td><td><input checked="" type="checkbox"/></td><td><input checked="" type="checkbox"/></td><td><input checked="" type="checkbox"/></td><td><input checked="" type="checkbox"/></td><td><input checked="" type="checkbox"/></td><td><input checked="" type="checkbox"/></td><td><input checked="" type="checkbox"/></td><td><input checked="" type="checkbox"/></td><td><input checked="" type="checkbox"/></td><td><input checked="" type="checkbox"/></td><td><input checked="" type="checkbox"/></td><td><input checked="" type="checkbox"/></td><td><input checked="" type="checkbox"/></td><td><input checked="" type="checkbox"/></td><td><input checked="" type="checkbox"/></td><td><input checked="" type="checkbox"/></td><td><input checked="" type="checkbox"/></td><td><input checked="" type="checkbox"/></td><td><input checked="" type="checkbox"/></td><td><input checked="" type="checkbox"/></td><td><input checked="" type="checkbox"/></td><td><input checked="" type="checkbox"/></td> </tr> <tr> <td>-</td><td>-</td><td>-</td><td>-</td><td>-</td><td>-</td><td>-</td><td>-</td><td>-</td><td>-</td><td>-</td><td>-</td><td>-</td><td>-</td><td>-</td><td>-</td><td>-</td><td>-</td><td>-</td><td>-</td><td>-</td><td>-</td><td>-</td><td>-</td><td>-</td> </tr> <tr> <td>-</td><td>-</td><td>-</td><td>-</td><td>-</td><td>-</td><td>-</td><td>-</td><td>-</td><td>-</td><td>-</td><td>-</td><td>-</td><td>-</td><td>-</td><td>-</td><td>-</td><td>-</td><td>-</td><td>-</td><td>-</td><td>-</td><td>-</td><td>-</td><td>-</td> </tr> </tbody> </table> | 1 | 2 | 3 | 4 | 5 | 6 | 7 | 8 | 9 | 10 | 11 | 12 | 13 | 14 | 15 | 16 | 17 | 18 | 19 | 20 | 21 | 22 | 23 | 24 | 25 | <input checked="" type="checkbox"/> | <input checked="" type="checkbox"/> | <input checked="" type="checkbox"/> | <input checked="" type="checkbox"/> | <input checked="" type="checkbox"/> | <input checked="" type="checkbox"/> | <input checked="" type="checkbox"/> | <input checked="" type="checkbox"/> | <input checked="" type="checkbox"/> | <input checked="" type="checkbox"/> | <input checked="" type="checkbox"/> | <input checked="" type="checkbox"/> | <input checked="" type="checkbox"/> | <input checked="" type="checkbox"/> | <input checked="" type="checkbox"/> | <input checked="" type="checkbox"/> | <input checked="" type="checkbox"/> | <input checked="" type="checkbox"/> | <input checked="" type="checkbox"/> | <input checked="" type="checkbox"/> | <input checked="" type="checkbox"/> | <input checked="" type="checkbox"/> | <input checked="" type="checkbox"/> | <input checked="" type="checkbox"/> | <input checked="" type="checkbox"/> | - | - | - | - | - | - | - | - | - | - | - | - | - | - | - | - | - | - | - | - | - | - | - | - | - | - | - | - | - | - | - | - | - | - | - | - | - | - | - | - | - | - | - | - | - | - | - | - | - | - |
| 1 | 2 | 3 | 4 | 5 | 6 | 7 | 8 | 9 | 10 | 11 | 12 | 13 | 14 | 15 | 16 | 17 | 18 | 19 | 20 | 21 | 22 | 23 | 24 | 25 | | | | | | | | | | | | | | | | | | | | | | | | | | | | | | | | | | | | | | | | | | | | | | | | | | | | | | | | | | | | | | | | | | | | | | | | | | | | | |
| <input checked="" type="checkbox"/> | <input checked="" type="checkbox"/> | <input checked="" type="checkbox"/> | <input checked="" type="checkbox"/> | <input checked="" type="checkbox"/> | <input checked="" type="checkbox"/> | <input checked="" type="checkbox"/> | <input checked="" type="checkbox"/> | <input checked="" type="checkbox"/> | <input checked="" type="checkbox"/> | <input checked="" type="checkbox"/> | <input checked="" type="checkbox"/> | <input checked="" type="checkbox"/> | <input checked="" type="checkbox"/> | <input checked="" type="checkbox"/> | <input checked="" type="checkbox"/> | <input checked="" type="checkbox"/> | <input checked="" type="checkbox"/> | <input checked="" type="checkbox"/> | <input checked="" type="checkbox"/> | <input checked="" type="checkbox"/> | <input checked="" type="checkbox"/> | <input checked="" type="checkbox"/> | <input checked="" type="checkbox"/> | <input checked="" type="checkbox"/> | | | | | | | | | | | | | | | | | | | | | | | | | | | | | | | | | | | | | | | | | | | | | | | | | | | | | | | | | | | | | | | | | | | | | | | | | | | | | |
| - | - | - | - | - | - | - | - | - | - | - | - | - | - | - | - | - | - | - | - | - | - | - | - | - | | | | | | | | | | | | | | | | | | | | | | | | | | | | | | | | | | | | | | | | | | | | | | | | | | | | | | | | | | | | | | | | | | | | | | | | | | | | | |
| - | - | - | - | - | - | - | - | - | - | - | - | - | - | - | - | - | - | - | - | - | - | - | - | - | | | | | | | | | | | | | | | | | | | | | | | | | | | | | | | | | | | | | | | | | | | | | | | | | | | | | | | | | | | | | | | | | | | | | | | | | | | | | |
| <input type="button" value="Apply"/> | | | | | | | | | | | | | | | | | | | | | | | | | | | | | | | | | | | | | | | | | | | | | | | | | | | | | | | | | | | | | | | | | | | | | | | | | | | | | | | | | | | | | | | | | | | | | | | | | | | | | |
| View Settings of Unit 1 Port 1 | | | | | | | | | | | | | | | | | | | | | | | | | | | | | | | | | | | | | | | | | | | | | | | | | | | | | | | | | | | | | | | | | | | | | | | | | | | | | | | | | | | | | | | | | | | | | | | | | | | | | |

Figure 11- 53. Setup Forwarding Ports window

The user may set the following parameters:

| Parameter | Description |
|---------------------|--|
| Unit – Port | Use the drop-down menu to select the desired unit and port to transmit packets. |
| Forward Port | Tick the check boxes to select which of the ports on the Switch will be able to forward packets. These ports will be allowed to receive packets from the port specified above. |

Clicking the **Apply** button will enter the combination of transmitting port and allowed receiving ports into the Switch's Current Traffic Segmentation Table.

SSL

Secure Sockets Layer or SSL is a security feature that will provide a secure communication path between a host and client through the use of authentication, digital signatures and encryption. These security functions are implemented through the use of a ciphersuite, which is a security string that determines the exact cryptographic parameters, specific encryption algorithms and key sizes to be used for an authentication session and consists of three levels:

1. **Key Exchange:** The first part of the ciphersuite string specifies the public key algorithm to be used. This switch utilizes the Rivest Shamir Adleman (RSA) public key algorithm and the Digital Signature Algorithm (DSA), specified here as the DHE DSS Diffie-Hellman (DHE) public key algorithm. This is the first authentication process between client and host as they “exchange keys” in looking for a match and therefore authentication to be accepted to negotiate encryptions on the following level.
2. **Encryption:** The second part of the ciphersuite that includes the encryption used for encrypting the messages sent between client and host. The Switch supports two types of cryptology algorithms:
 - **Stream Ciphers** – There are two types of stream ciphers on the Switch, RC4 with 40-bit keys and RC4 with 128-bit keys. These keys are used to encrypt messages and need to be consistent between client and host for optimal use.
 - **CBC Block Ciphers** – CBC refers to Cipher Block Chaining, which means that a portion of the previously encrypted block of encrypted text is used in the encryption of the current block. The Switch supports the 3DES EDE encryption code defined by the Data Encryption Standard (DES) to create the encrypted text.
3. **Hash Algorithm:** This part of the ciphersuite allows the user to choose a message digest function that will determine a Message Authentication Code. This Message Authentication Code will be encrypted with a sent message to provide integrity and prevent against replay attacks. The Switch supports two hash algorithms, MD5 (Message Digest 5) and SHA (Secure Hash Algorithm).

These three parameters are uniquely assembled in four choices on the Switch to create a three-layered encryption code for secure communication between the server and the host. The user may implement any one or combination of the ciphersuites available, yet different ciphersuites will affect the security level and the performance of the secured connection. The information included in the ciphersuites is not included with the Switch and requires downloading from a third source in a file form called a certificate. This function of the Switch cannot be executed without the presence and implementation of the certificate file and can be downloaded to the Switch by utilizing a TFTP server. The Switch supports SSLv3 and TLSv1. Other versions of SSL may not be compatible with this Switch and may cause problems upon authentication and transfer of messages from client to host.

Download Certificate

This window is used to download a certificate file for the SSL function on the Switch from a TFTP server. The certificate file is a data record used for authenticating devices on the network. It contains information on the owner, keys for authentication and digital signatures. Both the server and the client must have consistent certificate files for optimal use of the SSL function. The Switch only supports certificate files with .der file extensions. The Switch is shipped with a certificate pre-loaded though the user may need to download more, depending on user circumstances.

Ciphersuite

This window will allow the user to enable SSL on the Switch and implement any one or combination of listed ciphersuites on the Switch. A ciphersuite is a security string that determines the exact cryptographic parameters, specific encryption algorithms and key sizes to be used for an authentication session. The Switch possesses four possible ciphersuites for the SSL function, which are all enabled by default. To utilize a particular ciphersuite, disable the unwanted ciphersuites, leaving the desired one for authentication.

When the SSL function has been enabled, the web will become disabled. To manage the Switch through the web based management while utilizing the SSL function, the web browser must support SSL encryption and the header of the URL must begin with https://. (Ex. https://10.90.90.90) Any other method will result in an error and no access can be authorized for the web-based management.

To view the windows for **Download Certificate** and **Ciphersuite**, click **Security > SSL**, as shown below.

Download Certificate

| | |
|------------------------------|--|
| Certificate Type | Local <input type="button" value="v"/> |
| Server IP | <input type="text" value="0.0.0.0"/> |
| Certificate File Name | <input type="text"/> |
| Key File Name | <input type="text"/> |

Current Certificate: Loaded with RSA Certificate!

Configuration

| | |
|------------------------------------|---|
| SSL Status | Disabled <input type="button" value="v"/> |
| Cache Timeout(60-86400 sec) | <input type="text" value="600"/> |

Ciphersuite

| | |
|--------------------------------------|---|
| RSA with RC4 128 MD5 | Enabled <input type="button" value="v"/> 0x0004 |
| RSA with 3DES EDE CBC SHA | Enabled <input type="button" value="v"/> 0x000a |
| DHE DSS with 3DES EDE CBC SHA | Enabled <input type="button" value="v"/> 0x0013 |
| RSA EXPORT with RC4 40 MD5 | Enabled <input type="button" value="v"/> 0x0003 |

Figure 11- 54. Download Certificate window

To download certificates, set the following parameters and click **Apply**.

| Parameter | Description |
|------------------------------|---|
| Certificate Type | Enter the type of certificate to be downloaded. This type refers to the server responsible for issuing certificates. This field has been limited to <i>Local</i> for this firmware release. |
| Server IP | Enter the IP address of the TFTP server where the certificate files are located. |
| Certificate File Name | Enter the path and the filename of the certificate file to download. This file must have a .der extension. (Ex. c:/cert.der) |
| Key File Name | Enter the path and the filename of the key file to download. This file must have a .der extension (Ex. c:/pkey.der) |

To set up the SSL function on the Switch, configure the following parameters and click **Apply**.

| Parameter | Description |
|---------------------------------|---|
| Configuration | |
| SSL Status | Use the pull-down menu to enable or disable the SSL status on the switch. The default is <i>Disabled</i> . |
| Cache Timeout (60-86400) | This field will set the time between a new key exchange between a client and a host using the SSL function. A new SSL session is established every time the client and host go through a key exchange. Specifying a longer timeout will allow the SSL session to reuse the master key on future connections with that particular host, therefore speeding up the negotiation process. The default setting is 600 seconds. |

| Ciphersuite | |
|--------------------------------------|--|
| RSA with RC4 128 MD5 | This ciphersuite combines the RSA key exchange, stream cipher RC4 encryption with 128-bit keys and the MD5 Hash Algorithm. Use the pull-down menu to enable or disable this ciphersuite. This field is <i>Enabled</i> by default. |
| RSA with 3DES EDE CBC SHA | This ciphersuite combines the RSA key exchange, CBC Block Cipher 3DES_EDE encryption and the SHA Hash Algorithm. Use the pull-down menu to enable or disable this ciphersuite. This field is <i>Enabled</i> by default. |
| DHE DSS with 3DES EDE CBC SHA | This ciphersuite combines the DSA Diffie Hellman key exchange, CBC Block Cipher 3DES_EDE encryption and SHA Hash Algorithm. Use the pull-down menu to enable or disable this ciphersuite. This field is <i>Enabled</i> by default. |
| RSA EXPORT with RC4 40 MD5 | This ciphersuite combines the RSA Export key exchange and stream cipher RC4 encryption with 40-bit keys. Use the pull-down menu to enable or disable this ciphersuite. This field is <i>Enabled</i> by default. |



NOTE: Certain implementations concerning the function and configuration of SSL are not available on the web-based management of this Switch and need to be configured using the command line interface. For more information on SSL and its functions, see the *xStack® DGS-3600 Series CLI Manual*, located on the documentation CD of this product.



NOTE: Enabling the SSL command will disable the web-based switch management. To log on to the Switch again, the header of the URL must begin with `https://`. Entering anything else into the address field of the web browser will result in an error and no authentication will be granted.

SSH

SSH is an abbreviation of Secure Shell, which is a program allowing secure remote login and secure network services over an insecure network. It allows a secure login to remote host computers, a safe method of executing commands on a remote end node, and will provide secure encrypted and authenticated communication between two non-trusted hosts. SSH, with its array of unmatched security features is an essential tool in today's networking environment. It is a powerful guardian against numerous existing security hazards that now threaten network communications.

The steps required to use the SSH protocol for secure communication between a remote PC (the SSH client) and the Switch (the SSH server) are as follows:

1. Create a user account with admin-level access using the User Accounts window in the **Security Management** folder. This is identical to creating any other admin-level User Account on the Switch, including specifying a password. This password is used to logon to the Switch, once a secure communication path has been established using the SSH protocol.
2. Configure the User Account to use a specified authorization method to identify users that are allowed to establish SSH connections with the Switch using the **SSH User Authentication** window. There are three choices as to the method SSH will use to authorize the user, which are *Host Based*, *Password* and *Public Key*.
3. Configure the encryption algorithm that SSH will use to encrypt and decrypt messages sent between the SSH client and the SSH server, using the **SSH Algorithm** window.
4. Finally, enable SSH on the Switch using the **SSH Configuration** window.

After completing the preceding steps, a SSH Client on a remote PC can be configured to manage the Switch using a secure, in band connection.

SSH Server Configuration

The following window is used to configure and view settings for the SSH server.

To view this window, click **Security > SSH > SSH Server Configuration**, as shown below

| SSH Server Configuration | |
|-----------------------------------|------------|
| SSH Server Status | Disabled |
| Max Session | 8 |
| Connection Timeout | 120 |
| Auth. Fail | 2 |
| Session Rekeying | Never |
| Listened Port Number | 22 |
| SSH Server Configuration Settings | |
| SSH Server Status | Disabled ▾ |
| Max Session(1-8) | 8 |
| Connection Timeout(120-600) | 120 |
| Auth. Fail(2-20) | 2 |
| Session Rekeying | Never ▾ |
| Apply | |

Figure 11- 55. SSH Server Configuration window

To configure the SSH server on the Switch, modify the following parameters and click **Apply**:

| Parameter | Description |
|-----------------------------|--|
| SSH Server Status | Use the pull-down menu to enable or disable SSH on the Switch. The default is <i>Disabled</i> . |
| Max Session | Enter a value between 1 and 8 to set the number of users that may simultaneously access the Switch. The default setting is 8. |
| Connection Timeout | Allows the user to set the connection timeout. The use may set a time between 120 and 600 seconds. The default setting is 120 seconds. |
| Auth. Fail | Allows the Administrator to set the maximum number of attempts that a user may try to log on to the SSH Server utilizing the SSH authentication. After the maximum number of attempts has been exceeded, the Switch will be disconnected and the user must reconnect to the Switch to attempt another login. The number of maximum attempts may be set between 2 and 20. The default setting is 2. |
| Session Rekeying | Using the pull-down menu uses this field to set the time period that the Switch will change the security shell encryptions. The available options are <i>Never</i> , <i>10 min</i> , <i>30 min</i> , and <i>60 min</i> . The default setting is <i>Never</i> . |
| Listened Port Number | This displays the virtual port number to be used with this feature. The common port number for SSH is 22. |

SSH Authentication Mode and Algorithm Settings

The SSH Algorithm window allows the configuration of the desired types of SSH algorithms used for authentication encryption. There are four categories of algorithms listed and specific algorithms of each may be enabled or disabled by using their corresponding pull-down menus. All algorithms are enabled by default.

To view this window, click **Security > SSH > SSH Authentication Mode and Algorithm Settings**, as shown.

| SSH Authentication Mode and Algorithm Settings | |
|--|--|
| Password | Enabled <input type="button" value="v"/> |
| Publickey | Enabled <input type="button" value="v"/> |
| Host-based | Enabled <input type="button" value="v"/> |
| Encryption Algorithm | |
| 3DES-CBC | Enabled <input type="button" value="v"/> |
| Blow-fish-CBC | Enabled <input type="button" value="v"/> |
| AES128-CBC | Enabled <input type="button" value="v"/> |
| AES192-CBC | Enabled <input type="button" value="v"/> |
| AES256-CBC | Enabled <input type="button" value="v"/> |
| ARC4 | Enabled <input type="button" value="v"/> |
| Cast128-CBC | Enabled <input type="button" value="v"/> |
| Twofish128 | Enabled <input type="button" value="v"/> |
| Twofish192 | Enabled <input type="button" value="v"/> |
| Twofish256 | Enabled <input type="button" value="v"/> |
| Data Integrity Algorithm | |
| HMAC-SHA1 | Enabled <input type="button" value="v"/> |
| HMAC-MD5 | Enabled <input type="button" value="v"/> |
| Public Key Algorithm | |
| HMAC-RSA | Enabled <input type="button" value="v"/> |
| HMAC-DSA | Enabled <input type="button" value="v"/> |
| <input type="button" value="Apply"/> | |

Figure 11- 56. SSH Authenticate Mode and Algorithm Settings window

The following algorithms may be set:

| Parameter | Description |
|---|--|
| SSH Authentication Mode and Algorithm Settings | |
| Password | This parameter may be enabled if the administrator wishes to use a locally configured password for authentication on the Switch. The default is <i>Enabled</i> . |
| Public Key | This parameter may be enabled if the administrator wishes to use a public key configuration set on a SSH server, for authentication on the Switch. The default is <i>Enabled</i> . |
| Host-based | This parameter may be enabled if the administrator wishes to use a host computer for authentication. This parameter is intended for Linux users requiring SSH authentication techniques and the host computer is running the Linux operating system with a SSH program previously installed. The default is <i>Enabled</i> . |
| Encryption Algorithm | |
| 3DES-CBC | Use the pull-down to enable or disable the Triple Data Encryption Standard encryption algorithm with Cipher Block Chaining. The default is <i>Enabled</i> . |
| Blow-fish CBC | Use the pull-down to enable or disable the Blowfish encryption algorithm with Cipher Block Chaining. The default is <i>Enabled</i> . |
| AES128-CBC | Use the pull-down to enable or disable the Advanced Encryption Standard AES128 encryption algorithm with Cipher Block Chaining. The default is <i>Enabled</i> . |
| AES192-CBC | Use the pull-down to enable or disable the Advanced Encryption Standard AES192 encryption algorithm with Cipher Block Chaining. The default is <i>Enabled</i> . |
| AES256-CBC | Use the pull-down to enable or disable the Advanced Encryption Standard AES-256 encryption algorithm with Cipher Block Chaining. The default is <i>Enabled</i> . |
| ARC4 | Use the pull-down to enable or disable the Arcfour encryption algorithm with Cipher Block Chaining. The default is <i>Enabled</i> . |
| Cast128-CBC | Use the pull-down to enable or disable the Cast128 encryption algorithm with Cipher Block Chaining. The default is <i>Enabled</i> . |
| Twofish128 | Use the pull-down to enable or disable the twofish128 encryption algorithm. The default is <i>Enabled</i> . |
| Twofish192 | Use the pull-down to enable or disable the twofish192 encryption algorithm. The default is <i>Enabled</i> . |
| Twofish256 | Use the pull-down to enable or disable the twofish256 encryption algorithm. The default is <i>Enabled</i> . |
| Data Integrity Algorithm | |
| HMAC-SHA1 | Use the pull-down to enable or disable the HMAC (Hash for Message Authentication Code) mechanism utilizing the Secure Hash algorithm. The default is <i>Enabled</i> . |
| HMAC-MD5 | Use the pull-down to enable or disable the HMAC (Hash for Message Authentication Code) mechanism utilizing the MD5 Message Digest encryption algorithm. The default is <i>Enabled</i> . |
| Public Key Algorithm | |
| HMAC-RSA | Use the pull-down to enable or disable the HMAC (Hash for Message Authentication Code) mechanism utilizing the RSA encryption algorithm. The default is <i>Enabled</i> . |
| HMAC-DSA | Use the pull-down to enable or disable the HMAC (Hash for Message Authentication Code) mechanism utilizing the Digital Signature Algorithm encryption. The default is <i>Enabled</i> . |

Click **Apply** to implement changes made.

SSH User Authentication

The following windows are used to configure parameters for users attempting to access the Switch through SSH.

To view this window, click **Security > SSH > SSH User Authentication Mode**, as shown.

(Note: Maximum of 8 entries.)

| SSH User Authentication Mode | | | |
|------------------------------|------------|-----------|---------|
| User Name | Auth. Mode | Host Name | Host IP |
| RG | Password | | |

Figure 11- 57. SSH User Authenticate Mode window

In the example window to the right, the User Account “admin” has been previously set using the User Accounts window in the **Administration** folder. A User Account MUST be set in order to set the parameters for the SSH user. To configure the parameters for a SSH user, click on the hyperlinked User Name in the **Current Accounts** window, which will reveal the following window to configure.

| | |
|------------|----------------------------------|
| User Name | RG |
| Auth. Mode | Password |
| Host Name | |
| Host IP | <input type="checkbox"/> 0.0.0.0 |

[Show All User Authentication Entries](#) Apply

Figure 11- 58. SSH User window

The user may set the following parameters:

| Parameter | Description |
|-------------------|---|
| User Name | Enter a User Name of no more than 15 characters to identify the SSH user. This User Name must be a previously configured user account on the Switch. |
| Auth. Mode | <p>The administrator may choose one of the following to set the authorization for users attempting to access the Switch.</p> <p><i>Host Based</i> – This parameter should be chosen to use a remote SSH server for authentication purposes. Choosing this parameter requires the user to input the following information to identify the SSH user.</p> <ul style="list-style-type: none"> <i>Host Name</i> – Displays an alphanumeric string of no more than 31 characters to identify the remote SSH user. <i>Host IP</i> – Displays the corresponding IP address of the SSH user. <p><i>Password</i> – This parameter should be chosen to use an administrator-defined password for authentication. Upon entry of this parameter, the Switch will prompt the administrator for a password, and then to re-type the password for confirmation.</p> <p><i>Public Key</i> – This parameter should be chosen to use the publickey on a SSH server for authentication.</p> |
| Host Name | Enter an alphanumeric string of no more than 32 characters to identify the remote SSH user. This parameter is only used in conjunction with the Host Based choice in the Auth. Mode field. |
| Host IP | Enter the corresponding IP address of the SSH user. This parameter is only used in conjunction with the Host Based choice in the Auth. Mode field. |

Click **Apply** to implement changes made.



NOTE: To set the SSH User Authentication parameters on the Switch, a User Account must be previously configured. For more information on configuring local User Accounts on the Switch, see the User Accounts section of this manual located in the Administration section.

Section 12

Monitoring

Device Status

Stacking Information

Module Information

CPU Utilization

Port Utilization

Packets

Errors

Packet Size

Browse Router Port

Browse MLD Router Port

VLAN Status

VLAN Status Port

Port Access Control

MAC Address Table

IGMP Snooping Group

MLD Snooping Group

Trace Route

IGMP Snooping Forwarding

MLD Snooping Forwarding

IP Forwarding Table

Browse Routing Table

Browse IP Multicast Forwarding Table

Browse IP Multicast Interface Table

Browse IGMP Group Table

DVMRP Monitor

PIM Monitor

OSPF Monitor

Switch Logs

Browse ARP Table

MAC Based Access Control

Device Status

This window displays status information for Internal Power, External Power, Side Fan, and Back Fan.

To view the **Device Status** window, click **Monitoring > Device Status**, as shown below.

| Device Status | | | | | | |
|---------------|----------------|----------------|----------|-----------|----------|---------|
| ID | Internal Power | External Power | Left Fan | Right Fan | Back Fan | CPU Fan |
| 1 | Active | Fail | OK | OK | OK | OK |

Figure 12- 1. Device Status window

Stacking Information

This window displays all the Switches that are currently in the stack as well as configuration information about each Switch.

To view the **Stacking Information** window, click **Monitoring > Stacking Information**, as shown below.

| Stacking Information | | | | | | | | |
|----------------------|----------|-----------|-------|----------|-------------------|--------------|-----------------|-------------|
| Box ID | User Set | Type | Exist | Priority | MAC Address | PROM Version | Runtime Version | H/W Version |
| 1 | Auto | DGS-3627G | Exist | 32 | 00-19-5B-F5-26-C0 | 1.10-B06 | 2.50.B09 | 1A1G |
| 2 | --- | Not_Exist | No | | | | | |
| 3 | --- | Not_Exist | No | | | | | |
| 4 | --- | Not_Exist | No | | | | | |
| 5 | --- | Not_Exist | No | | | | | |
| 6 | --- | Not_Exist | No | | | | | |
| 7 | --- | Not_Exist | No | | | | | |
| 8 | --- | Not_Exist | No | | | | | |
| 9 | --- | Not_Exist | No | | | | | |
| 10 | --- | Not_Exist | No | | | | | |
| 11 | --- | Not_Exist | No | | | | | |
| 12 | --- | Not_Exist | No | | | | | |

Topology : Duplex Chain
 My Box ID : 1
 Master ID : 1
 Box Count : 1

Figure 12- 2. Stacking Information window

Module Information

This window displays module information of the Switch, including the module name, Revision Number, Serial Number and description.

To view the **Module Information** window, click **Monitoring > Module Information**, as shown below.

| Module Information | | | | | |
|--------------------|----|-------------|----------|--------|-------------|
| Box ID | ID | Module Name | Rev. No. | Serial | Description |
| 1 | 1 | - | - | - | - |
| 1 | 2 | - | - | - | - |
| 1 | 3 | - | - | - | - |

Figure 12- 3. Module Information window

CPU Utilization

This window displays the percentage of the CPU being used, expressed as an integer percentage and calculated as a simple average by time interval.

To view this window, click **Monitoring > CPU Utilization**, as shown below.

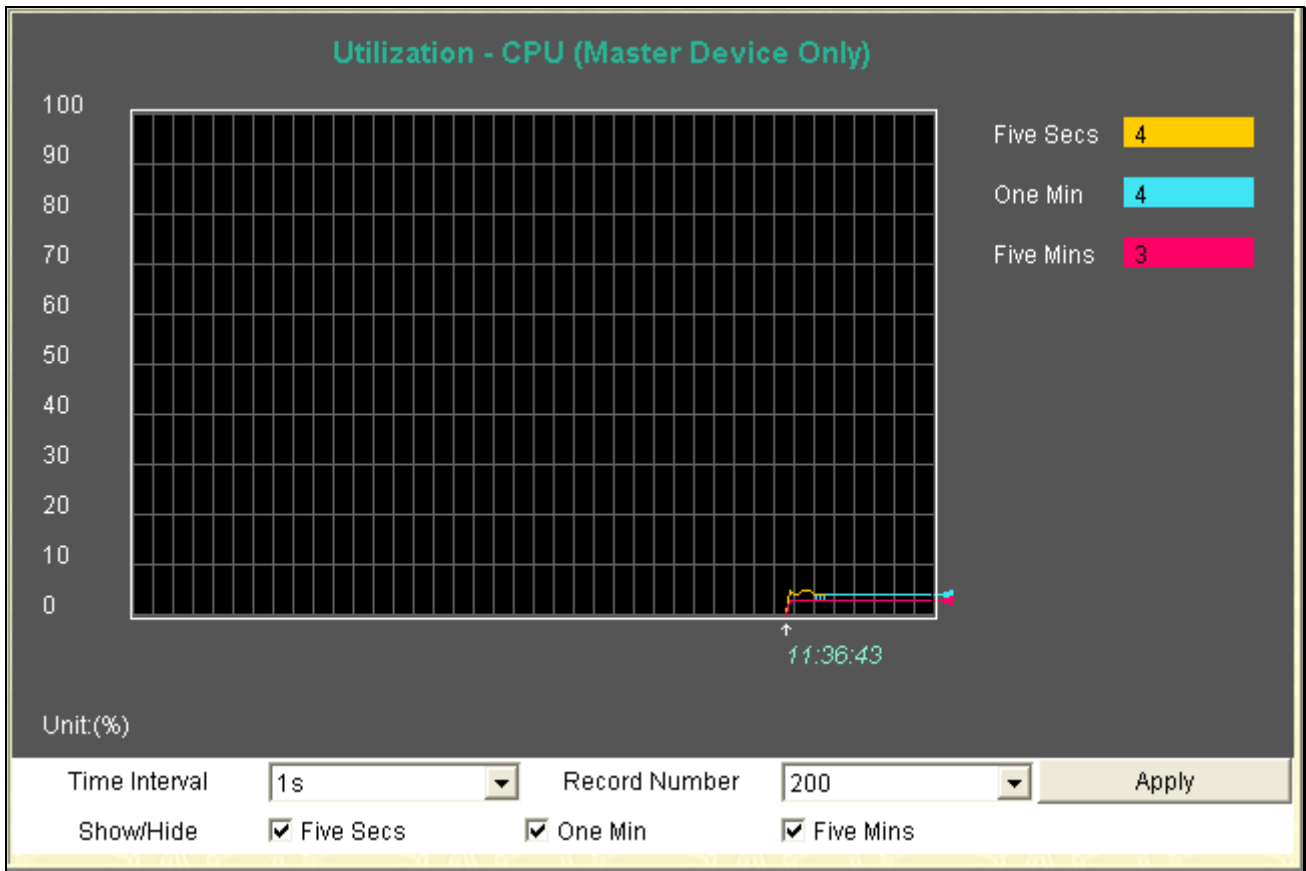

Figure 12- 4. CPU Utilization window

Click **Apply** to implement the configured settings. The window will automatically refresh with new updated statistics

The information is described as follows:

| Parameter | Description |
|----------------------|---|
| Time Interval | Select the desired setting between <i>1s</i> and <i>60s</i> , where "s" stands for seconds. The default value is one second. |
| Record Number | Select number of times the Switch will be polled between <i>20</i> and <i>200</i> . The default value is <i>200</i> . |
| Show/Hide | These check boxes allow the user to choose the CPU utilization over increments of <i>Five Secs</i> , <i>One Min</i> and <i>Five Mins</i> . Each time increment will be displayed in the window as a specifically colored line. Five seconds will be displayed as yellow, one minute as blue and five minutes as pink. |

Port Utilization

This window displays the percentage of the total available bandwidth being used on the port.

To view the port utilization, click **Monitoring > Port Utilization**, as shown below.

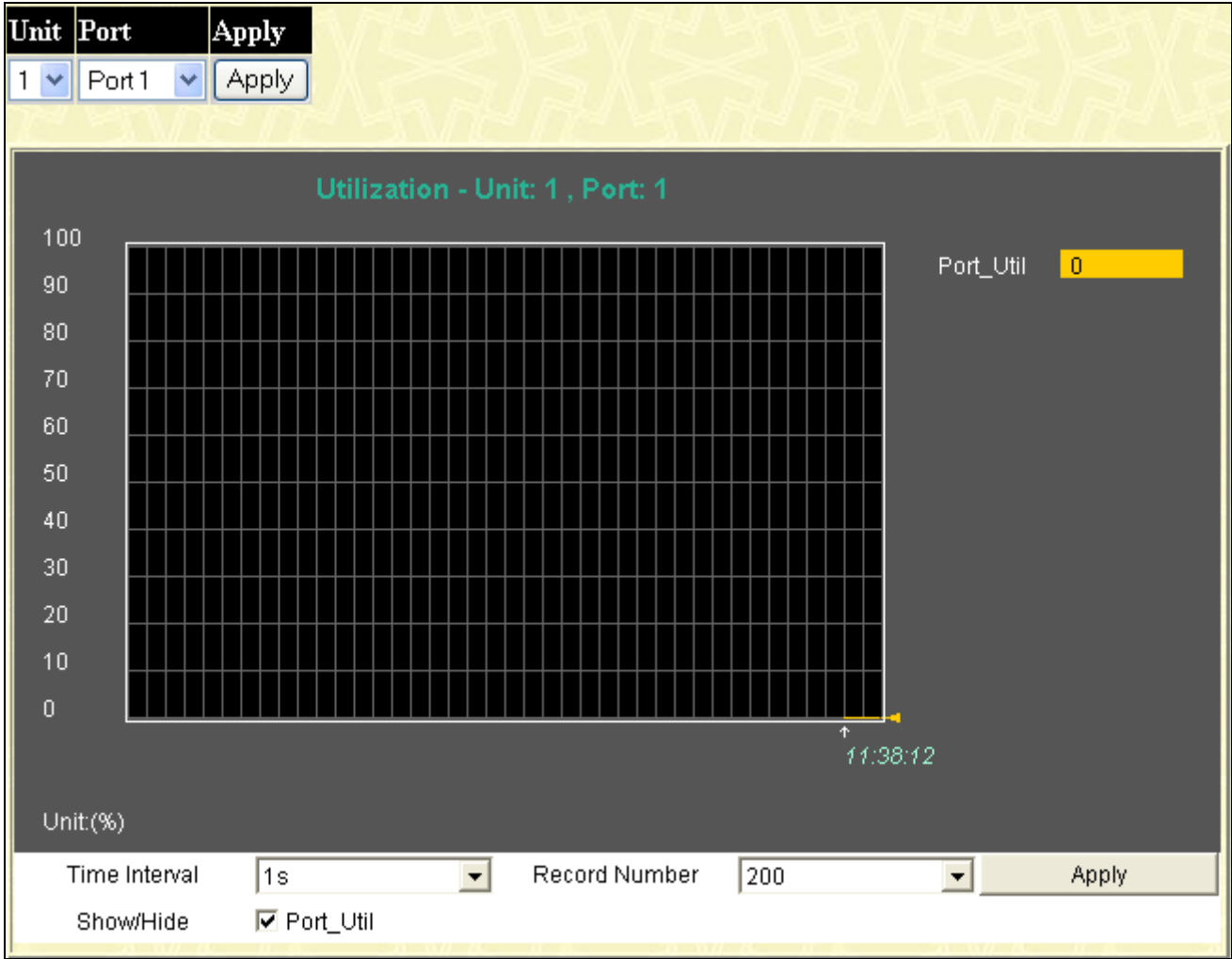

Figure 12- 5. Port Utilization window

Select a Port number from its drop-down menu and click **Apply** to display the Port Utilization for a particular port. The following fields can be set:

| Parameter | Description |
|----------------------|---|
| Time Interval | Select the desired setting between 1s and 60s, where "s" stands for seconds. The default value is one second. |
| Record Number | Select number of times the Switch will be polled between 20 and 200. The default value is 200. |
| Show/Hide | Check whether to display Port Utilization. |

Click **Clear** to refresh the graph. Click **Apply** to set changes implemented.

Packets

The Web Manager allows various packet statistics to be viewed as either a line graph or a table. Six windows are offered.

Received (RX)

To view the **Received (RX)** window, click **Monitoring > Packets > Received (RX)**, as shown below.

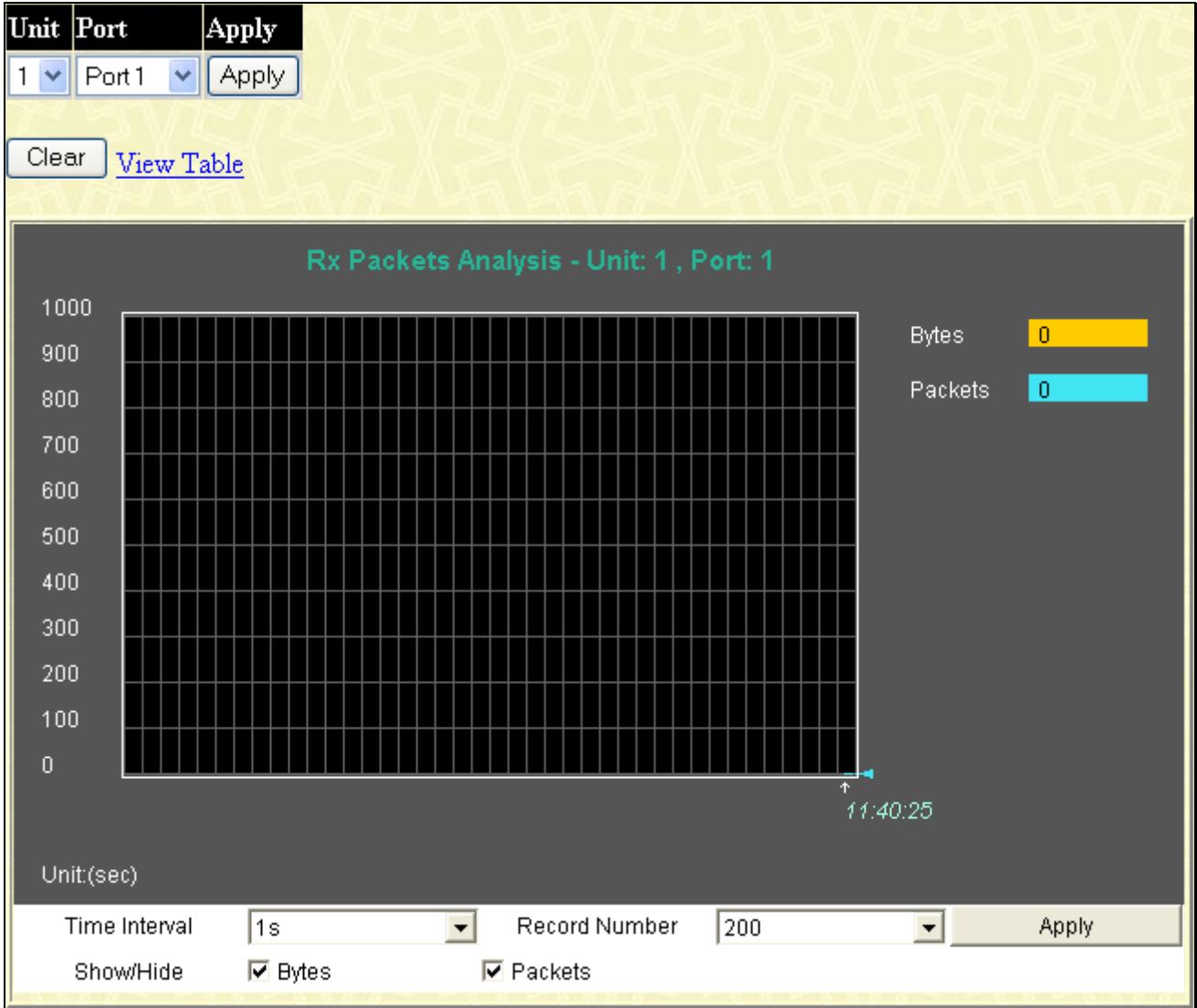

Figure 12- 6. Rx Packets Analysis window (line graph for Bytes and Packets)

Select a Port number from its pull-down menu and click **Apply** to display the Rx Packet analysis for a particular port. To view the Received Packets Table, click the link [View Table](#), which will show the following table:

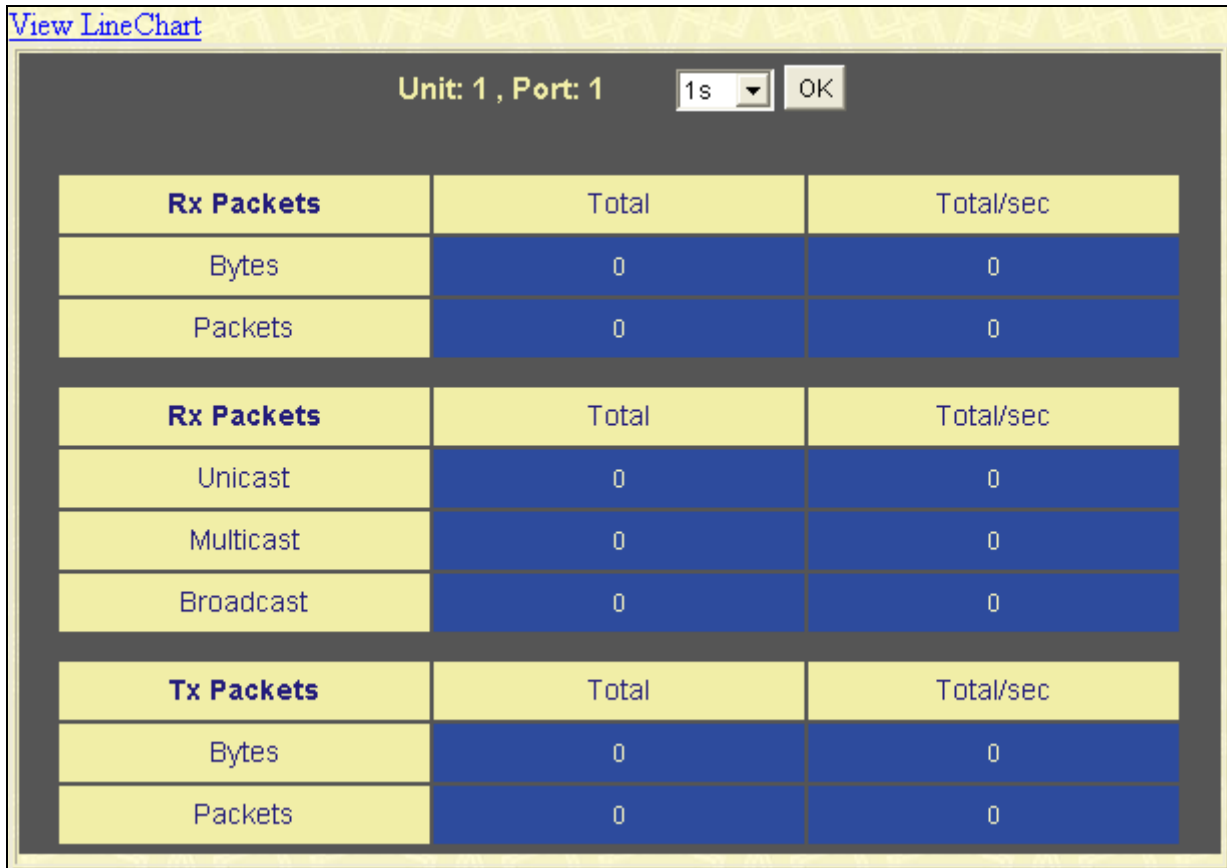

Figure 12- 7. Rx Packets Analysis window (table for Bytes and Packets)

The following fields may be set or viewed:

| Parameter | Description |
|---------------------------------|---|
| Time Interval | Select the desired setting between 1s and 60s, where "s" stands for seconds. The default value is one second. |
| Record Number | Select number of times the Switch will be polled between 20 and 200. The default value is 200. |
| Bytes | Counts the number of bytes received on the port. |
| Packets | Counts the number of packets received on the port. |
| Show/Hide | Check whether to display Bytes and Packets. |
| Clear | Clicking this button clears all statistics counters on this window. |
| View Table | Clicking this button instructs the Switch to display a table rather than a line graph. |
| View Line Chart | Clicking this button instructs the Switch to display a line graph rather than a table. |

UMB_cast (RX)

To view the **UMB_cast (RX)** window, click **Monitoring > Packets > UMB_cast (RX)**, as shown below.



Figure 12- 8. Rx Packets Analysis window (line graph for Unicast, Multicast, and Broadcast Packets)

To view the UMB Cast Table, click the [View Table](#) link, which will show the following table:

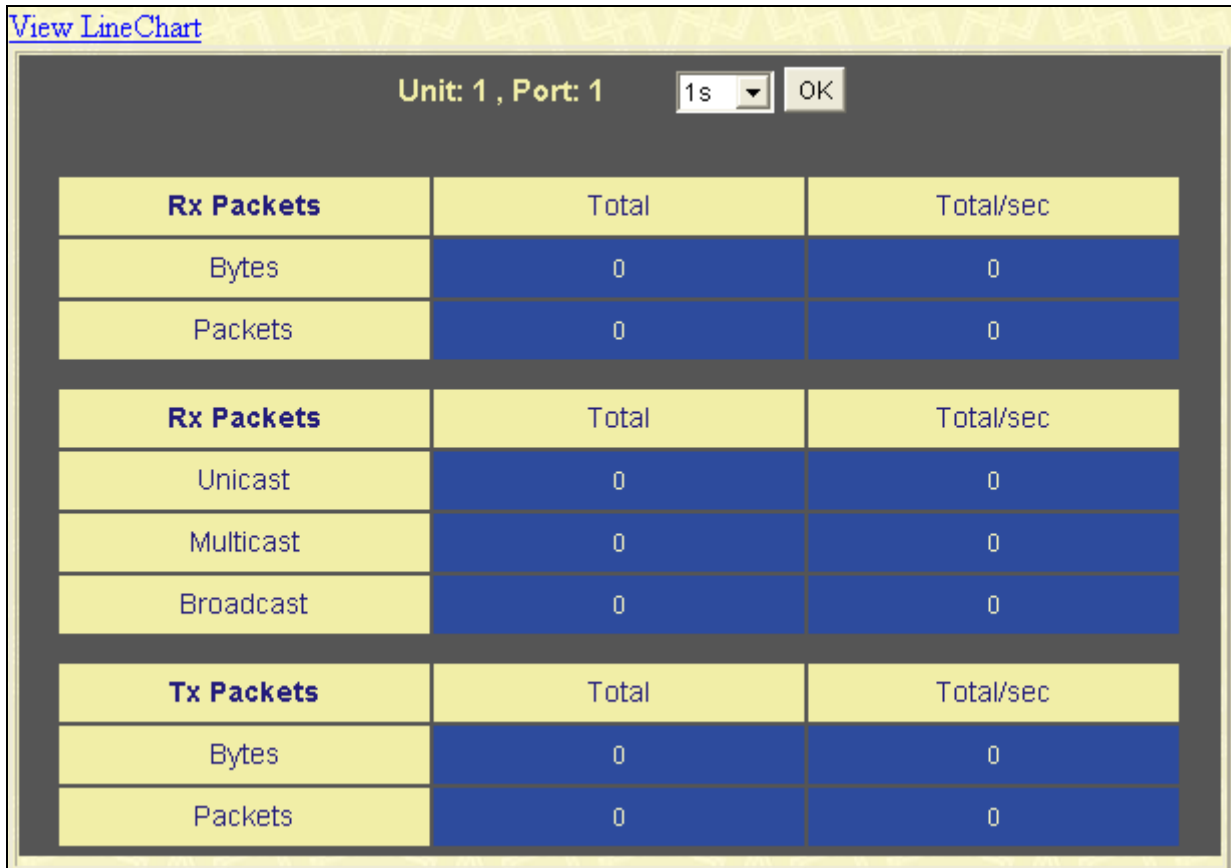

Figure 12- 9. Rx Packets Analysis window (table for Unicast, Multicast, and Broadcast Packets)

The following fields may be set or viewed:

| Parameter | Description |
|---------------------------------|---|
| Time Interval | Select the desired setting between 1s and 60s, where "s" stands for seconds. The default value is one second. |
| Record Number | Select number of times the Switch will be polled between 20 and 200. The default value is 200. |
| Unicast | Counts the total number of good packets that were received by a unicast address. |
| Multicast | Counts the total number of good packets that were received by a multicast address. |
| Broadcast | Counts the total number of good packets that were received by a broadcast address. |
| Show/Hide | Check whether or not to display Multicast, Broadcast, and Unicast Packets. |
| Clear | Clicking this button clears all statistics counters on this window. |
| View Table | Clicking this button instructs the Switch to display a table rather than a line graph. |
| View Line Chart | Clicking this button instructs the Switch to display a line graph rather than a table. |

Transmitted (TX)

To view this window, click **Monitoring > Packets > Transmitted (TX)**, as shown below.

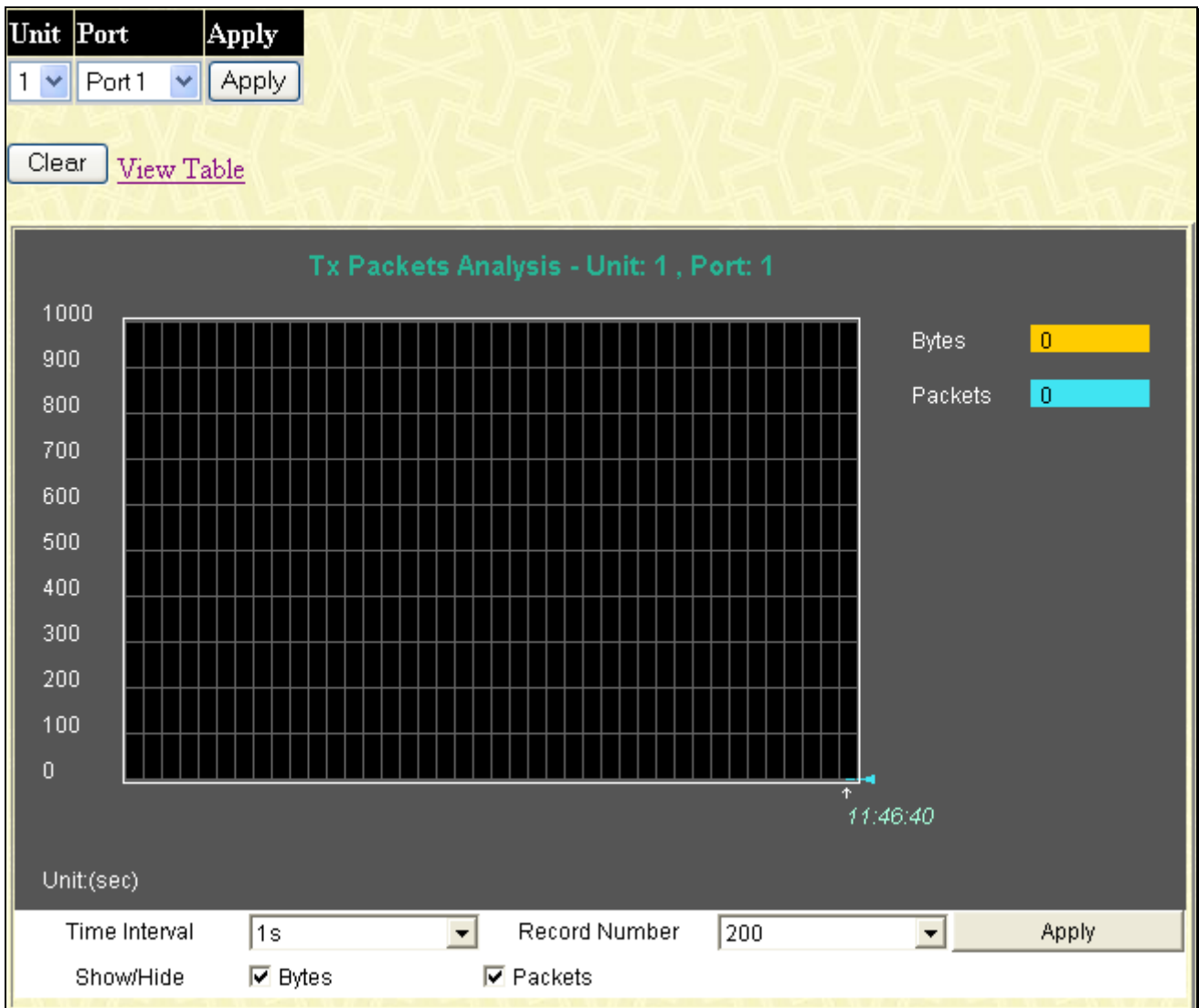

Figure 12- 10. Tx Packets Analysis window (line graph for Bytes and Packets)

To view the Transmitted (TX) Table, click the link [View Table](#), which will show the following table:

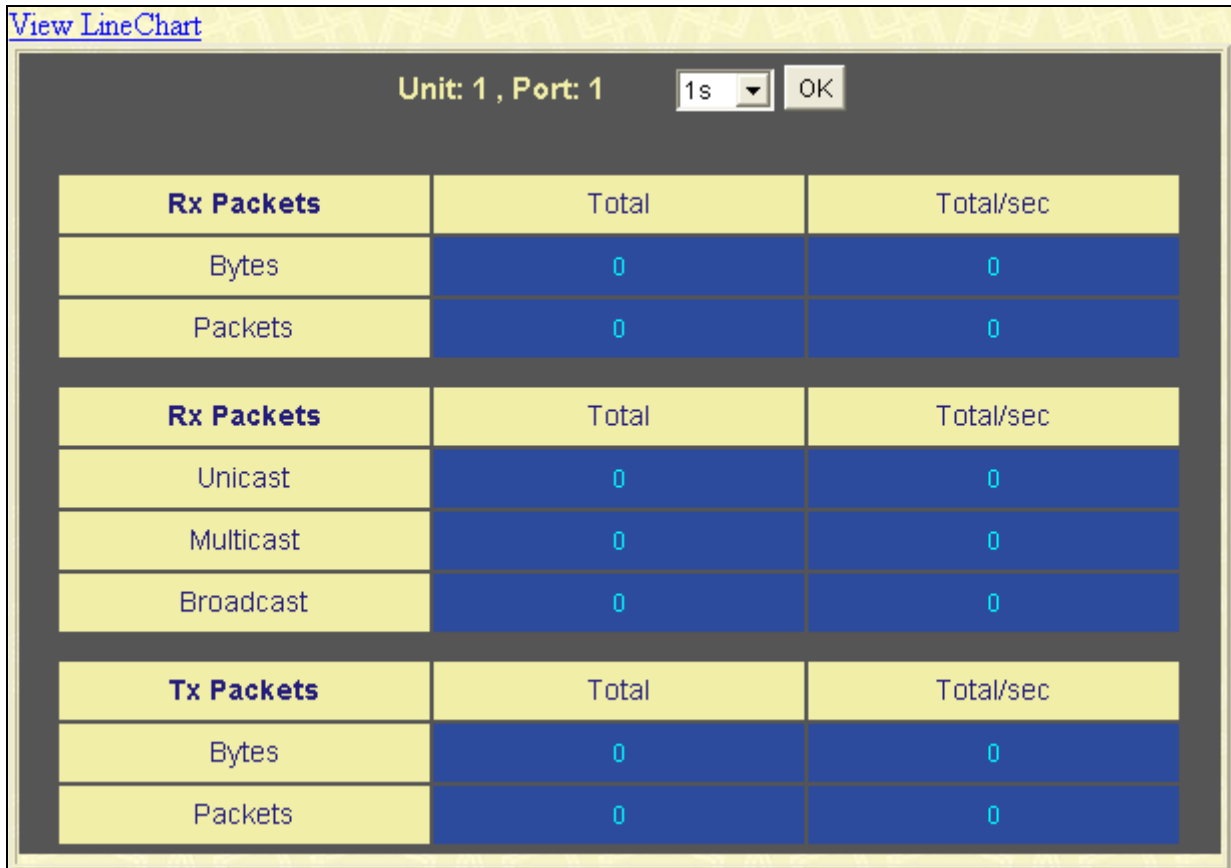

Figure 12- 11. Tx Packets Analysis window (table for Bytes and Packets)

The following fields may be set or viewed:

| Parameter | Description |
|---------------------------------|---|
| Time Interval | Select the desired setting between 1s and 60s, where "s" stands for seconds. The default value is one second. |
| Record Number | Select number of times the Switch will be polled between 20 and 200. The default value is 200. |
| Bytes | Counts the number of bytes successfully sent on the port. |
| Packets | Counts the number of packets successfully sent on the port. |
| Show/Hide | Check whether or not to display Bytes and Packets. |
| Clear | Clicking this button clears all statistics counters on this window. |
| View Table | Clicking this button instructs the Switch to display a table rather than a line graph. |
| View Line Chart | Clicking this button instructs the Switch to display a line graph rather than a table. |

Errors

The Web Manager allows port error statistics compiled by the Switch's management agent to be viewed as either a line graph or a table. Four windows are offered.

Received (RX)

To view this window, click **Monitoring > Errors > Received (RX)**, as shown below.

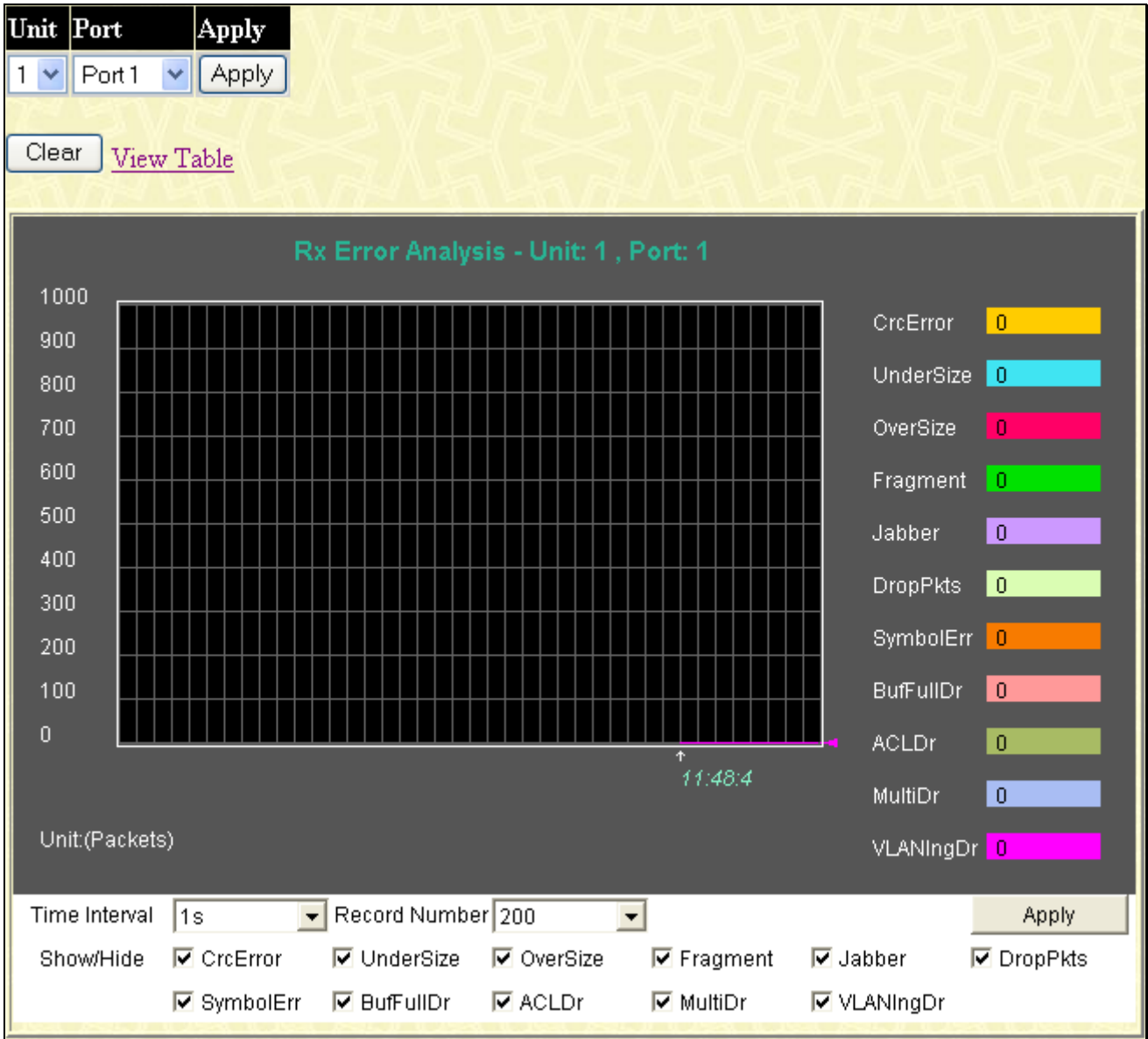

Figure 12- 12. Rx Error Analysis window (line graph)

To view the Received Error Packets Table, click the link [View Table](#), which will show the following table:

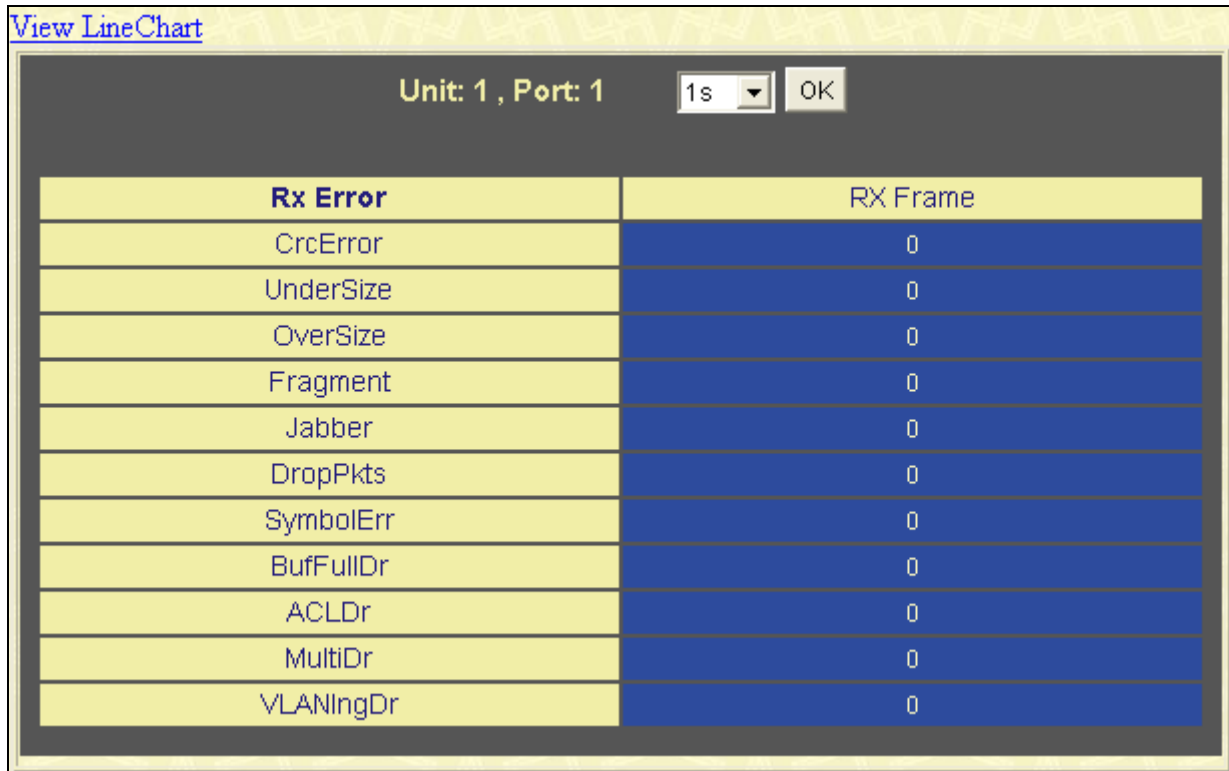

Figure 12- 13. Rx Error Analysis window (table)

The following fields can be set:

| Parameter | Description |
|----------------------|---|
| Time Interval | Select the desired setting between 1s and 60s, where "s" stands for seconds. The default value is one second. |
| Record Number | Select number of times the Switch will be polled between 20 and 200. The default value is 200. |
| Crc Error | Counts otherwise valid packets that did not end on a byte (octet) boundary. |
| Under Size | The number of packets detected that are less than the minimum permitted packets size of 64 bytes and have a good CRC. Undersize packets usually indicate collision fragments, a normal network occurrence. |
| Over Size | Counts packets received that were longer than the MAX_PKT_LEN. Internally, MAX_PKT_LEN is equal to 1536 octets, or if a VLAN frame of 1540 octets was received. |
| Fragment | The number of packets less than 64 bytes with either bad framing or an invalid CRC. These are normally the result of collisions. |
| Jabber | Counts the error packets that were received that exceeded 1518 bytes, or for VLAN frames, 1522 bytes, and less than the MAX_PKT_LEN. The MAX_PKT_LEN is equal to 1536 bytes, and 1540 bytes for a VLAN frame. |
| Drop | The number of packets that are dropped by this port since the last Switch reboot. |
| Symbol | Counts the number of packets received that have errors received in the symbol on the physical labor. |
| BuFullDr | Incremented for each packet that is discarded while the input buffer is full. |
| ACLDr | Incremented for each packet that is denied by ACLs. |
| MultiDr | Incremented for each multicast packet that is discarded. |

| | |
|---------------------------------|--|
| VLANIngDr | Incremented for each packet that is discarded by VLAN ingress checking. |
| Show/Hide | Check whether or not to display Crc Error, Under Size, Over Size, Fragment, Jabber, and Drop errors. |
| Clear | Clicking this button clears all statistics counters on this window. |
| View Table | Clicking this button instructs the Switch to display a table rather than a line graph. |
| View Line Chart | Clicking this button instructs the Switch to display a line graph rather than a table. |

Transmitted (TX)

To view this window, click **Monitoring > Errors > Transmitted (TX)**, as shown below.

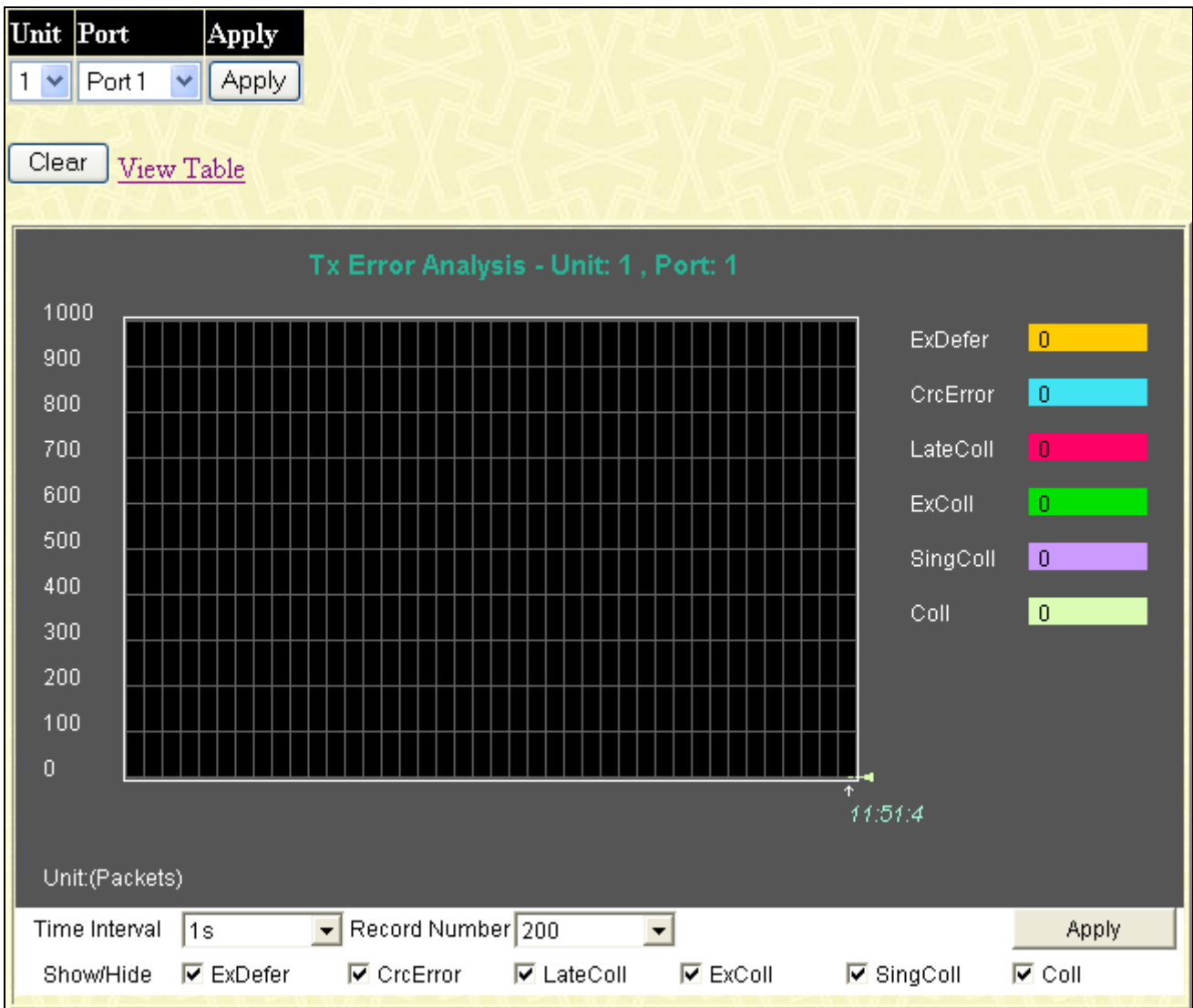

Figure 12- 14. Tx Error Analysis window (line graph)

To view the Transmitted Error Packets Table, click the link [View Table](#), which will show the following table:

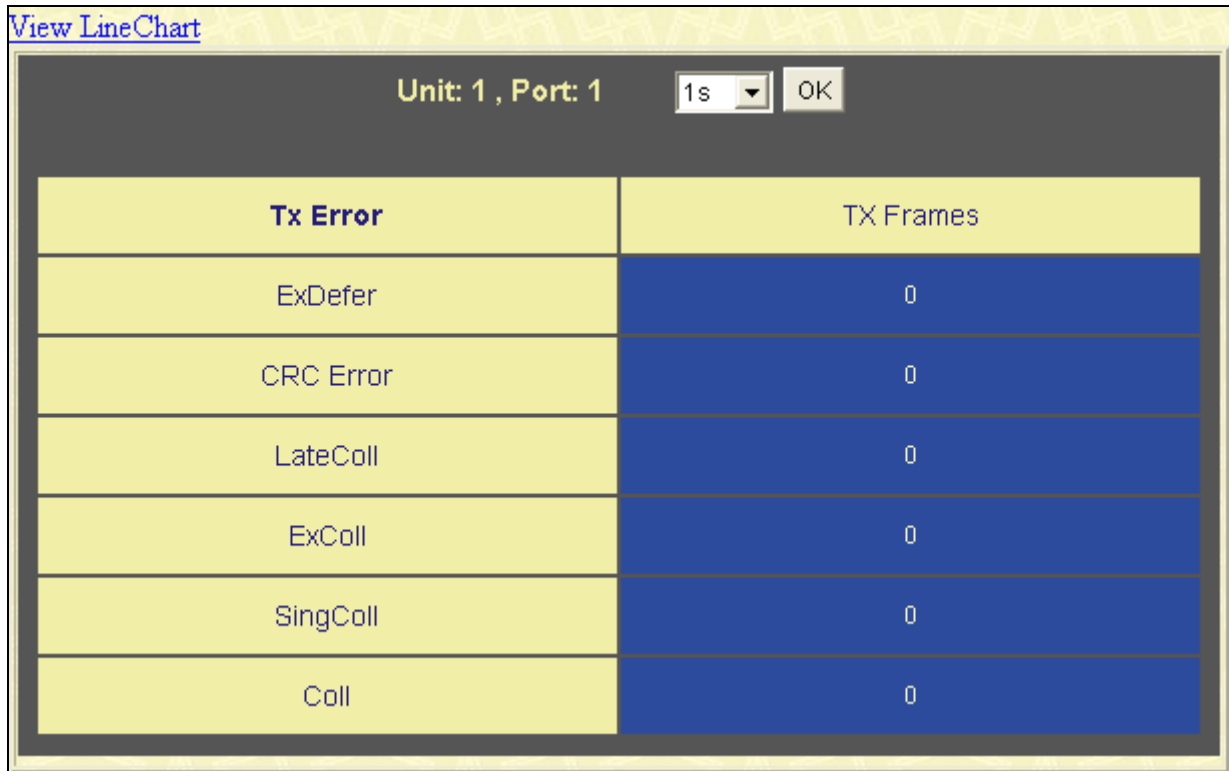

Figure 12- 15. Tx Error Analysis window (table)

The following fields may be set or viewed:

| Parameter | Description |
|---------------------------------|--|
| Time Interval | Select the desired setting between 1s and 60s, where "s" stands for seconds. The default value is one second. |
| Record Number | Select number of times the Switch will be polled between 20 and 200. The default value is 200. |
| ExDefer | Counts the number of packets for which the first transmission attempt on a particular interface was delayed because the medium was busy. |
| CRC Error | Counts otherwise valid packets that did not end on a byte (octet) boundary. |
| LateColl | Counts the number of times that a collision is detected later than 512 bit-times into the transmission of a packet. |
| ExColl | Excessive Collisions. The number of packets for which transmission failed due to excessive collisions. |
| SingColl | Single Collision Frames. The number of successfully transmitted packets for which transmission is inhibited by more than one collision. |
| Coll | An estimate of the total number of collisions on this network segment. |
| Show/Hide | Check whether or not to display ExDefer, LateColl, ExColl, SingColl, and Coll errors. |
| Clear | Clicking this button clears all statistics counters on this window. |
| View Table | Clicking this button instructs the Switch to display a table rather than a line graph. |
| View Line Chart | Clicking this button instructs the Switch to display a line graph rather than a table. |

Packet Size

The Web Manager allows packets received by the Switch, arranged in six groups and classed by size, to be viewed as either a line graph or a table. Two windows are offered.

To view this table, click **Monitoring > Packet Size**, the following window will be displayed.

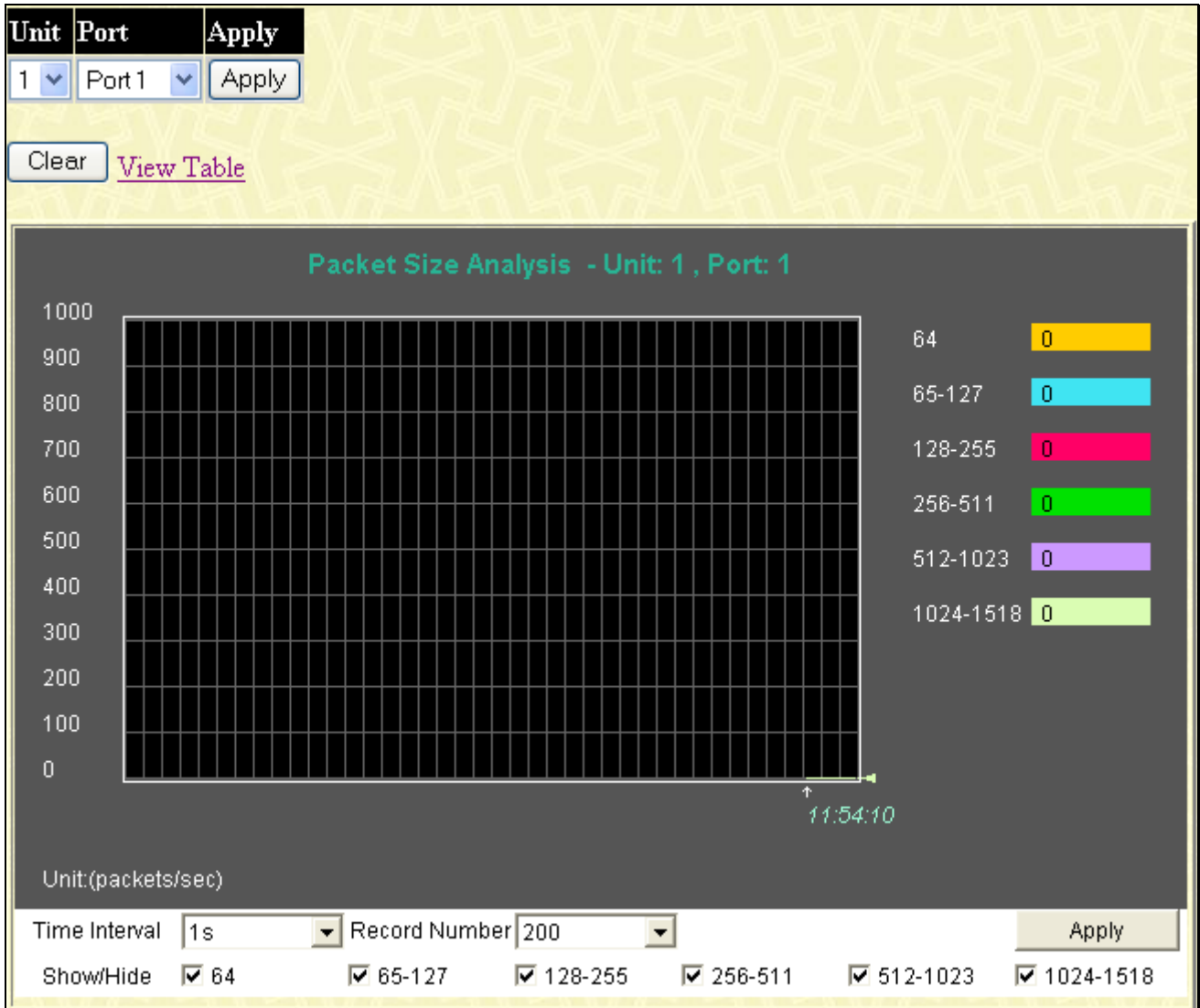

Figure 12- 16. Rx Size Analysis window (line graph)

To view the Packet Size Analysis Table, click the link [View Table](#), which will show the following table:

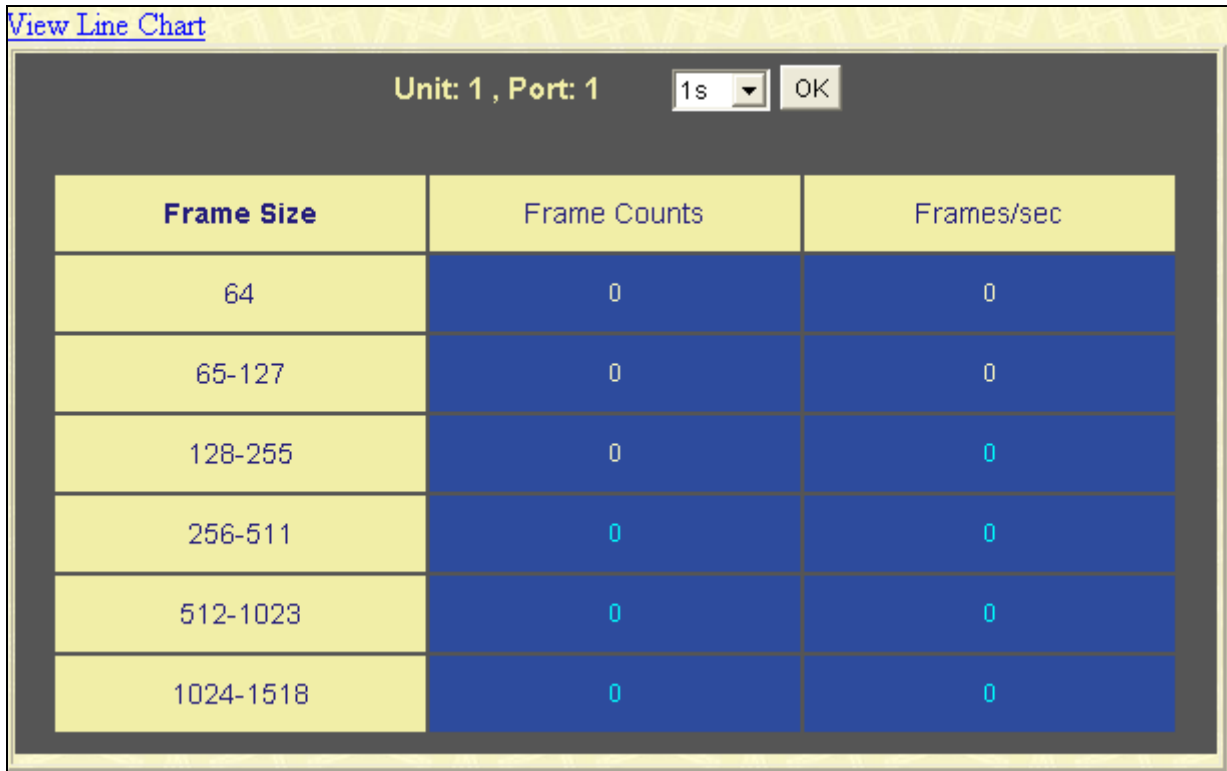

Figure 12- 17. Tx/Rx Packet Size Analysis window (table)

The following fields can be set or viewed:

| Parameter | Description |
|---------------------------------|--|
| Time Interval | Select the desired setting between 1s and 60s, where "s" stands for seconds. The default value is one second. |
| Record Number | Select number of times the Switch will be polled between 20 and 200. The default value is 200. |
| 64 | The total number of packets (including bad packets) received that were 64 octets in length (excluding framing bits but including FCS octets). |
| 65-127 | The total number of packets (including bad packets) received that were between 65 and 127 octets in length inclusive (excluding framing bits but including FCS octets). |
| 128-255 | The total number of packets (including bad packets) received that were between 128 and 255 octets in length inclusive (excluding framing bits but including FCS octets). |
| 256-511 | The total number of packets (including bad packets) received that were between 256 and 511 octets in length inclusive (excluding framing bits but including FCS octets). |
| 512-1023 | The total number of packets (including bad packets) received that were between 512 and 1023 octets in length inclusive (excluding framing bits but including FCS octets). |
| 1024-1518 | The total number of packets (including bad packets) received that were between 1024 and 1518 octets in length inclusive (excluding framing bits but including FCS octets). |
| Show/Hide | Check whether or not to display 64, 65-127, 128-255, 256-511, 512-1023, and 1024-1518 packets received. |
| Clear | Clicking this button clears all statistics counters on this window. |
| View Table | Clicking this button instructs the Switch to display a table rather than a line graph. |
| View Line Chart | Clicking this button instructs the Switch to display a line graph rather than a table. |

Browse Router Port

This displays which of the Switch's ports are currently configured as router ports. A router port configured by a user (using the console or Web-based management interfaces) is displayed as a static router port, designated by **S**. **D** designates a router port that is dynamically configured by the Switch and a forbidden port is designated by **F**.

To view this window, click **Monitoring > Browse Router Port**, as shown below.

| Browse Router Port | | | | | | | | | | | | | | | | | | | | | | | | | |
|--------------------|-------|----|----|----|----|----|----|----|----|----|----|----|-----------|----|----|----|----|----|----|----|----|----|----|----|----|
| VLAN ID | | | | | | | | | | | | | VLAN Name | | | | | | | | | | | | |
| 1 | | | | | | | | | | | | | default | | | | | | | | | | | | |
| Unit | Ports | | | | | | | | | | | | | | | | | | | | | | | | |
| | 1 | 2 | 3 | 4 | 5 | 6 | 7 | 8 | 9 | 10 | 11 | 12 | 13 | 14 | 15 | 16 | 17 | 18 | 19 | 20 | 21 | 22 | 23 | 24 | 25 |
| | 26 | 27 | 28 | 29 | 30 | 31 | 32 | 33 | 34 | 35 | 36 | 37 | 38 | 39 | 40 | 41 | 42 | 43 | 44 | 45 | 46 | 47 | 48 | 49 | 50 |
| 1 | | | | | | | | | | | | | | | | | | | | | | | | | |

Figure 12- 18. Browse Router Port window

Browse MLD Router Port

This displays which of the Switch's ports are currently configured as router ports in IPv6. A router port configured by a user (using the console or Web-based management interfaces) is displayed as a static router port, designated by **S**. A router port that is dynamically configured by the Switch is designated by **D** and a Forbidden port is designated by **F**.

To view this window, click **Monitoring > Browse MLD Snooping Router Port**, as shown below.

| Browse MLD Snooping Router Port | | | | | | | | | | | | | | | | | | | | | | | | | |
|---------------------------------|-------|----|----|----|----|----|----|----|----|----|----|----|-----------|----|----|----|----|----|----|----|----|----|----|----|----|
| VLAN ID | | | | | | | | | | | | | VLAN Name | | | | | | | | | | | | |
| 1 | | | | | | | | | | | | | default | | | | | | | | | | | | |
| Unit | Ports | | | | | | | | | | | | | | | | | | | | | | | | |
| | 1 | 2 | 3 | 4 | 5 | 6 | 7 | 8 | 9 | 10 | 11 | 12 | 13 | 14 | 15 | 16 | 17 | 18 | 19 | 20 | 21 | 22 | 23 | 24 | 25 |
| | 26 | 27 | 28 | 29 | 30 | 31 | 32 | 33 | 34 | 35 | 36 | 37 | 38 | 39 | 40 | 41 | 42 | 43 | 44 | 45 | 46 | 47 | 48 | 49 | 50 |
| 1 | | | | | | | | | | | | | | | | | | | | | | | | | |

Figure 12- 19. Browse MLD Snooping Router Port window

VLAN Status

This allows the VLAN status for each of the Switch's ports to be viewed by VLAN. This window displays the ports on the Switch that are currently Egress (E) or Tag (T) ports. To view the next VLAN in the list, click the **Next** button.

To view this window, click **Monitoring > VLAN Status**, as shown below.

| | | | | | | | | | | | | | | | | | | | | | | | | | |
|------------------------------|----------------------|-------------------------------------|----------------------|----|----|----|----|----|----|----|----|----|----|----|----|----|----|----|----|----|----|----|----|----|----|
| VLAN Name | <input type="text"/> | <input type="button" value="Find"/> | | | | | | | | | | | | | | | | | | | | | | | |
| VLAN ID(1-4094) | <input type="text"/> | <input type="button" value="Find"/> | | | | | | | | | | | | | | | | | | | | | | | |
| Total VLAN Entries: 1 | | | | | | | | | | | | | | | | | | | | | | | | | |
| VLAN Status | | | | | | | | | | | | | | | | | | | | | | | | | |
| VLAN ID | VLAN Name | Status | Advertisement | | | | | | | | | | | | | | | | | | | | | | |
| 1 | default | Static | Enabled | | | | | | | | | | | | | | | | | | | | | | |
| Unit | Ports | | | | | | | | | | | | | | | | | | | | | | | | |
| | 1 | 2 | 3 | 4 | 5 | 6 | 7 | 8 | 9 | 10 | 11 | 12 | 13 | 14 | 15 | 16 | 17 | 18 | 19 | 20 | 21 | 22 | 23 | 24 | 25 |
| | 26 | 27 | 28 | 29 | 30 | 31 | 32 | 33 | 34 | 35 | 36 | 37 | 38 | 39 | 40 | 41 | 42 | 43 | 44 | 45 | 46 | 47 | 48 | 49 | 50 |
| 1 | E | E | E | E | E | E | E | E | E | E | E | E | E | E | E | E | E | E | E | E | E | E | E | E | E |
| | | | | | | | | | | | | | | | | | | | | | | | | | |

Figure 12- 20. VLAN Status window

VLAN Status Port

This read-only window displays the current VLAN status for the port selected using the drop-down menu.

To view this window, click **Monitoring > VLAN Status Port**, as shown below.

| | | | | | |
|-------------------------|------------|-----------------|-------------------------------------|------------------|----------------|
| Unit - Port | 1 ▾ | Port1 ▾ | <input type="button" value="Find"/> | | |
| VLAN Status Port | | | | | |
| Port ID | VID | Untagged | Tagged | Forbidden | Dynamic |
| 1 : 1 | 1 | X | - | - | - |
| Total Entries:1 | | | | | |

Figure 12- 21. VLAN Status Port window

Port Access Control

The following windows are used to monitor 802.1X statistics of the Switch, on a per port basis. To view the **Port Access Control** windows, click **monitoring > Port Access Control**. There are six windows to monitor.



NOTE: The Authenticator State cannot be viewed on the Switch unless 802.1X is enabled by port or by MAC address. To enable 802.1X, go to the DGS-3600 Web Management Tool window.

Authenticator State

The following section describes the 802.1X Status on the Switch. This window displays the Authenticator State for individual ports on a selected device. A polling interval between 1 and 60 seconds can be set using the drop-down menu at the top of the window and clicking **OK**.

To view the Authenticator State click **Monitoring > Port Access Control > Authenticator State**, as shown below.

The screenshot shows the 'Authenticator State of Unit 1' window. At the top, there is a 'Unit' dropdown menu set to '1' and an 'Apply' button. Below this, the window title is 'Authenticator State of Unit 1' and there is a 'Time Interval' dropdown menu set to '1s' and an 'OK' button. The main content is a table with four columns: 'Port', 'Auth_PAE_State', 'Backend_State', and 'PortStatus'. The table lists 25 ports, all of which are in the 'Authorized' state.

| Port | Auth_PAE_State | Backend_State | PortStatus |
|------|----------------|---------------|------------|
| 1 | ForceAuth | Success | Authorized |
| 2 | ForceAuth | Success | Authorized |
| 3 | ForceAuth | Success | Authorized |
| 4 | ForceAuth | Success | Authorized |
| 5 | ForceAuth | Success | Authorized |
| 6 | ForceAuth | Success | Authorized |
| 7 | ForceAuth | Success | Authorized |
| 8 | ForceAuth | Success | Authorized |
| 9 | ForceAuth | Success | Authorized |
| 10 | ForceAuth | Success | Authorized |
| 11 | ForceAuth | Success | Authorized |
| 12 | ForceAuth | Success | Authorized |
| 13 | ForceAuth | Success | Authorized |
| 14 | ForceAuth | Success | Authorized |
| 15 | ForceAuth | Success | Authorized |
| 16 | ForceAuth | Success | Authorized |
| 17 | ForceAuth | Success | Authorized |
| 18 | ForceAuth | Success | Authorized |
| 19 | ForceAuth | Success | Authorized |
| 20 | ForceAuth | Success | Authorized |
| 21 | ForceAuth | Success | Authorized |
| 22 | ForceAuth | Success | Authorized |
| 23 | ForceAuth | Success | Authorized |
| 24 | ForceAuth | Success | Authorized |
| 25 | ForceAuth | Success | Authorized |

Figure 12- 22. Authenticator State window (Port-based 802.1X)

The user may also view this window if MAC Base is chosen for 802.1X. The window displays the same information, except that it is by MAC address and not port.

The information on this window is described as follows:

| Parameter | Description |
|-----------------------|--|
| Auth PAE State | The Authenticator PAE State value can be: Initialize, Disconnected, Connecting, Authenticating, Authenticated, Aborting, Held, Force_Auth, Force_Unauth, or N/A. N/A (Not Available) indicates that the port's authenticator capability is disabled. |
| Backend State | The Backend Authentication State can be Request, Response, Success, Fail, Timeout, Idle, Initialize, or N/A. N/A (Not Available) indicates that the port's authenticator capability is disabled. |
| Port Status | Controlled Port Status can be Authorized, Unauthorized, or N/A. |

Unit **1** Port **Port 1** Apply

Show Authenticator State of Unit 1 Port 1 Time Interval **1s** OK

| Index | MAC Address | Auth PAE State | Backend State | Port Status |
|-------|-------------|----------------|---------------|-------------|
| 1 | N/A | N/A | N/A | N/A |
| 2 | N/A | N/A | N/A | N/A |
| 3 | N/A | N/A | N/A | N/A |
| 4 | N/A | N/A | N/A | N/A |
| 5 | N/A | N/A | N/A | N/A |
| 6 | N/A | N/A | N/A | N/A |
| 7 | N/A | N/A | N/A | N/A |
| 8 | N/A | N/A | N/A | N/A |
| 9 | N/A | N/A | N/A | N/A |
| 10 | N/A | N/A | N/A | N/A |
| 11 | N/A | N/A | N/A | N/A |
| 12 | N/A | N/A | N/A | N/A |
| 13 | N/A | N/A | N/A | N/A |
| 14 | N/A | N/A | N/A | N/A |
| 15 | N/A | N/A | N/A | N/A |
| 16 | N/A | N/A | N/A | N/A |

Figure 12- 23. Authenticator State window – MAC-Based 802.1X

Authenticator Statistics

This table contains the statistics objects for the Authenticator PAE associated with each port. An entry appears in this table for each port that supports the Authenticator function.

To view the Authenticator Statistics, click **Monitoring > Port Access Control > Authenticator Statistics**, as shown below.

| Port | Frames Rx | Frames Tx | Rx Start | Tx ReqId | Rx LogOff | Tx Req | Rx Respld | Rx Resp | Rx Invalid |
|------|-----------|-----------|----------|----------|-----------|--------|-----------|---------|------------|
| 1 | 0 | 0 | 0 | 0 | 0 | 0 | 0 | 0 | 0 |
| 2 | 0 | 0 | 0 | 0 | 0 | 0 | 0 | 0 | 0 |
| 3 | 0 | 0 | 0 | 0 | 0 | 0 | 0 | 0 | 0 |
| 4 | 0 | 0 | 0 | 0 | 0 | 0 | 0 | 0 | 0 |
| 5 | 0 | 0 | 0 | 0 | 0 | 0 | 0 | 0 | 0 |
| 6 | 0 | 0 | 0 | 0 | 0 | 0 | 0 | 0 | 0 |
| 7 | 0 | 0 | 0 | 0 | 0 | 0 | 0 | 0 | 0 |
| 8 | 0 | 0 | 0 | 0 | 0 | 0 | 0 | 0 | 0 |
| 9 | 0 | 0 | 0 | 0 | 0 | 0 | 0 | 0 | 0 |
| 10 | 0 | 0 | 0 | 0 | 0 | 0 | 0 | 0 | 0 |
| 11 | 0 | 0 | 0 | 0 | 0 | 0 | 0 | 0 | 0 |
| 12 | 0 | 0 | 0 | 0 | 0 | 0 | 0 | 0 | 0 |
| 13 | 0 | 0 | 0 | 0 | 0 | 0 | 0 | 0 | 0 |
| 14 | 0 | 0 | 0 | 0 | 0 | 0 | 0 | 0 | 0 |
| 15 | 0 | 0 | 0 | 0 | 0 | 0 | 0 | 0 | 0 |
| 16 | 0 | 0 | 0 | 0 | 0 | 0 | 0 | 0 | 0 |
| 17 | 0 | 0 | 0 | 0 | 0 | 0 | 0 | 0 | 0 |
| 18 | 0 | 0 | 0 | 0 | 0 | 0 | 0 | 0 | 0 |
| 19 | 0 | 0 | 0 | 0 | 0 | 0 | 0 | 0 | 0 |
| 20 | 0 | 0 | 0 | 0 | 0 | 0 | 0 | 0 | 0 |
| 21 | 0 | 0 | 0 | 0 | 0 | 0 | 0 | 0 | 0 |
| 22 | 0 | 0 | 0 | 0 | 0 | 0 | 0 | 0 | 0 |
| 23 | 0 | 0 | 0 | 0 | 0 | 0 | 0 | 0 | 0 |
| 24 | 0 | 0 | 0 | 0 | 0 | 0 | 0 | 0 | 0 |
| 25 | 0 | 0 | 0 | 0 | 0 | 0 | 0 | 0 | 0 |

Figure 12- 24. Authenticator Statistics window

The user may also select the desired time interval to update the statistics, between *1s* and *60s*, where “s” stands for seconds. The default value is one second.

The following fields can be viewed:

| Parameter | Description |
|------------------|--|
| Port | The identification number assigned to the Port by the System in which the Port resides. |
| Frames Rx | The number of valid EAPOL frames that have been received by this Authenticator. |
| Frames Tx | The number of EAPOL frames that have been transmitted by this Authenticator. |
| Rx Start | The number of EAPOL Start frames that have been received by this Authenticator. |
| TxReqId | The number of EAP Req/Id frames that have been transmitted by this Authenticator. |
| RxLogOff | The number of EAPOL Logoff frames that have been received by this Authenticator. |
| Tx Req | The number of EAP Request frames (other than Rq/Id frames) that have been transmitted by this Authenticator. |
| Rx Respld | The number of EAP Resp/Id frames that have been received by this Authenticator. |
| Rx Resp | The number of valid EAP Response frames (other than Resp/Id frames) that have been received |

| | |
|---------------------|--|
| | by this Authenticator. |
| Rx Invalid | The number of EAPOL frames that have been received by this Authenticator in which the frame type is not recognized. |
| Rx Error | The number of EAPOL frames that have been received by this Authenticator in which the Packet Body Length field is invalid. |
| Last Version | The protocol version number carried in the most recently received EAPOL frame. |
| Last Source | The source MAC address carried in the most recently received EAPOL frame. |

Authenticator Session Statistics

This table contains the session statistics objects for the Authenticator PAE associated with each port. An entry appears in this table for each port that supports the Authenticator function.

To view the **Authenticator Session Statistics**, click **Monitoring > Port Access Control > Authenticator Session Statistics**, as shown below.

Unit 1 Apply

Authenticator Session Statistics of Unit 1 Time Interval 1s OK

| Port | Octets Rx | Octets Tx | Frames Rx | Frames Tx | ID | AuthenticMethod | T |
|------|-----------|-----------|-----------|-----------|-----|-------------------------|---|
| 1 | 0 | 0 | 0 | 0 | N/A | Remote Authentic Server | |
| 2 | 0 | 0 | 0 | 0 | N/A | Remote Authentic Server | |
| 3 | 0 | 0 | 0 | 0 | N/A | Remote Authentic Server | |
| 4 | 0 | 0 | 0 | 0 | N/A | Remote Authentic Server | |
| 5 | 0 | 0 | 0 | 0 | N/A | Remote Authentic Server | |
| 6 | 0 | 0 | 0 | 0 | N/A | Remote Authentic Server | |
| 7 | 0 | 0 | 0 | 0 | N/A | Remote Authentic Server | |
| 8 | 0 | 0 | 0 | 0 | N/A | Remote Authentic Server | |
| 9 | 0 | 0 | 0 | 0 | N/A | Remote Authentic Server | |
| 10 | 0 | 0 | 0 | 0 | N/A | Remote Authentic Server | |
| 11 | 0 | 0 | 0 | 0 | N/A | Remote Authentic Server | |
| 12 | 0 | 0 | 0 | 0 | N/A | Remote Authentic Server | |
| 13 | 0 | 0 | 0 | 0 | N/A | Remote Authentic Server | |
| 14 | 0 | 0 | 0 | 0 | N/A | Remote Authentic Server | |
| 15 | 0 | 0 | 0 | 0 | N/A | Remote Authentic Server | |
| 16 | 0 | 0 | 0 | 0 | N/A | Remote Authentic Server | |
| 17 | 0 | 0 | 0 | 0 | N/A | Remote Authentic Server | |
| 18 | 0 | 0 | 0 | 0 | N/A | Remote Authentic Server | |
| 19 | 0 | 0 | 0 | 0 | N/A | Remote Authentic Server | |
| 20 | 0 | 0 | 0 | 0 | N/A | Remote Authentic Server | |
| 21 | 0 | 0 | 0 | 0 | N/A | Remote Authentic Server | |
| 22 | 0 | 0 | 0 | 0 | N/A | Remote Authentic Server | |
| 23 | 0 | 0 | 0 | 0 | N/A | Remote Authentic Server | |
| 24 | 0 | 0 | 0 | 0 | N/A | Remote Authentic Server | |
| 25 | 0 | 0 | 0 | 0 | N/A | Remote Authentic Server | |

Figure 12- 25. Authenticator Session Statistics window

The user may also select the desired time interval to update the statistics, between 1s and 60s, where “s” stands for seconds. The default value is one second.

The following fields can be viewed:

| Parameter | Description |
|-------------|---|
| Port | The identification number assigned to the Port by the System in which the Port resides. |

| | |
|-------------------------|--|
| Octets Rx | The number of octets received in user data frames on this port during the session. |
| Octets Tx | The number of octets transmitted in user data frames on this port during the session. |
| Frames Rx | The number of user data frames received on this port during the session. |
| Frames Tx | The number of user data frames transmitted on this port during the session. |
| ID | A unique identifier for the session, in the form of a printable ASCII string of at least three characters. |
| Authentic Method | The authentication method used to establish the session. Valid Authentic Methods include: (1) Remote Authentic Server - The Authentication Server is external to the Authenticator's System. (2) Local Authentic Server - The Authentication Server is located within the Authenticator's System. |
| Time | The duration of the session in seconds. |
| Terminate Cause | The reason for the session termination. There are eight possible reasons for termination. 1) Supplicant Logoff 2) Port Failure 3) Supplicant Restart 4) Reauthentication Failure 5) AuthControlledPortControl set to ForceUnauthorized 6) Port re-initialization 7) Port Administratively Disabled 8) Not Terminated Yet |
| UserName | The User-Name representing the identity of the Supplicant PAE. |

Authenticator Diagnostics

This table contains the diagnostic information regarding the operation of the Authenticator associated with each port. An entry appears in this table for each port that supports the Authenticator function.

To view the **Authenticator Diagnostics**, click **Monitoring > Port Access Control > Authenticator Diagnostics**, as shown below.

Unit 1

| Authenticator | | | | | | | | |
|---------------|---------------|----------------|------------|--------------|--------------|-----------|-------------|----------|
| Port | Connect Enter | Connect LogOff | Auth Enter | Auth Success | Auth Timeout | Auth Fail | Auth Reauth | Auth Sta |
| 1 | 0 | 0 | 0 | 0 | 0 | 0 | 0 | 0 |
| 2 | 0 | 0 | 0 | 0 | 0 | 0 | 0 | 0 |
| 3 | 0 | 0 | 0 | 0 | 0 | 0 | 0 | 0 |
| 4 | 0 | 0 | 0 | 0 | 0 | 0 | 0 | 0 |
| 5 | 0 | 0 | 0 | 0 | 0 | 0 | 0 | 0 |
| 6 | 0 | 0 | 0 | 0 | 0 | 0 | 0 | 0 |
| 7 | 0 | 0 | 0 | 0 | 0 | 0 | 0 | 0 |
| 8 | 0 | 0 | 0 | 0 | 0 | 0 | 0 | 0 |
| 9 | 0 | 0 | 0 | 0 | 0 | 0 | 0 | 0 |
| 10 | 0 | 0 | 0 | 0 | 0 | 0 | 0 | 0 |
| 11 | 0 | 0 | 0 | 0 | 0 | 0 | 0 | 0 |
| 12 | 0 | 0 | 0 | 0 | 0 | 0 | 0 | 0 |
| 13 | 0 | 0 | 0 | 0 | 0 | 0 | 0 | 0 |
| 14 | 0 | 0 | 0 | 0 | 0 | 0 | 0 | 0 |
| 15 | 0 | 0 | 0 | 0 | 0 | 0 | 0 | 0 |
| 16 | 0 | 0 | 0 | 0 | 0 | 0 | 0 | 0 |
| 17 | 0 | 0 | 0 | 0 | 0 | 0 | 0 | 0 |
| 18 | 0 | 0 | 0 | 0 | 0 | 0 | 0 | 0 |
| 19 | 0 | 0 | 0 | 0 | 0 | 0 | 0 | 0 |
| 20 | 0 | 0 | 0 | 0 | 0 | 0 | 0 | 0 |
| 21 | 0 | 0 | 0 | 0 | 0 | 0 | 0 | 0 |
| 22 | 0 | 0 | 0 | 0 | 0 | 0 | 0 | 0 |
| 23 | 0 | 0 | 0 | 0 | 0 | 0 | 0 | 0 |
| 24 | 0 | 0 | 0 | 0 | 0 | 0 | 0 | 0 |
| 25 | 0 | 0 | 0 | 0 | 0 | 0 | 0 | 0 |

Figure 12- 26. Authenticator Diagnostics window

The user may select the desired time interval to update the statistics, between *1s* and *60s*, where “s” stands for seconds. The default value is one second.

The following fields can be viewed:

| Parameter | Description |
|-----------------------|--|
| Port | The identification number assigned to the Port by the System in which the Port resides. |
| Connect Enter | Counts the number of times that the state machine transitions to the CONNECTING state from any other state. |
| Connect LogOff | Counts the number of times that the state machine transitions from CONNECTING to DISCONNECTED as a result of receiving an EAPOL-Logoff message. |
| Auth Enter | Counts the number of times that the state machine transitions from CONNECTING to AUTHENTICATING, as a result of an EAP-Response/Identity message being received from the Supplicant. |
| Auth Success | Counts the number of times that the state machine transitions from AUTHENTICATING to AUTHENTICATED, as a result of the Backend Authentication state machine indicating successful authentication of the Supplicant (authSuccess = TRUE). |
| Auth Timeout | Counts the number of times that the state machine transitions from AUTHENTICATING to ABORTING, as a result of the Backend Authentication state machine indicating authentication timeout (authTimeout = TRUE). |
| Auth Fail | Counts the number of times that the state machine transitions from AUTHENTICATING to HELD, as a result of the Backend Authentication state machine indicating authentication failure |

| | |
|---------------------------|--|
| | (authFail = TRUE). |
| Auth Reauth | Counts the number of times that the state machine transitions from AUTHENTICATING to ABORTING, as a result of a reauthentication request (reAuthenticate = TRUE). |
| Auth Start | Counts the number of times that the state machine transitions from AUTHENTICATING to ABORTING, as a result of an EAPOL-Start message being received from the Supplicant. |
| Auth LogOff | Counts the number of times that the state machine transitions from AUTHENTICATING to ABORTING, as a result of an EAPOL-Logoff message being received from the Supplicant. |
| Authed Reauth | Counts the number of times that the state machine transitions from AUTHENTICATED to CONNECTING, as a result of a reauthentication request (reAuthenticate = TRUE). |
| Authed Start | Counts the number of times that the state machine transitions from AUTHENTICATED to CONNECTING, as a result of an EAPOL-Start message being received from the Supplicant. |
| Authed LogOff | Counts the number of times that the state machine transitions from AUTHENTICATED to DISCONNECTED, as a result of an EAPOL-Logoff message being received from the Supplicant. |
| Responses | Counts the number of times that the state machine sends an initial Access-Request packet to the Authentication server (i.e., executes sendRespToServer on entry to the RESPONSE state). Indicates that the Authenticator attempted communication with the Authentication Server. |
| AccessChallenges | Counts the number of times that the state machine receives an initial Access-Challenge packet from the Authentication server (i.e., aReq becomes TRUE, causing exit from the RESPONSE state). Indicates that the Authentication Server has communication with the Authenticator. |
| OtherReqToSupp | Counts the number of times that the state machine sends an EAP-Request packet (other than an Identity, Notification, Failure, or Success message) to the Supplicant (i.e., executes txReq on entry to the REQUEST state). Indicates that the Authenticator chose an EAP-method. |
| NonNakRespFrom Sup | Counts the number of times that the state machine receives a response from the Supplicant to an initial EAP-Request, and the response is something other than EAP-NAK (i.e., rxResp becomes TRUE, causing the state machine to transition from REQUEST to RESPONSE, and the response is not an EAP-NAK). Indicates that the Supplicant can respond to the Authenticator's chosen EAP-method. |
| Bac Auth Success | Counts the number of times that the state machine receives an Accept message from the Authentication Server (i.e., aSuccess becomes TRUE, causing a transition from RESPONSE to SUCCESS). Indicates that the Supplicant has successfully authenticated to the Authentication Server. |
| Bac Auth Fail | Counts the number of times that the state machine receives a Reject message from the Authentication Server (i.e., aFail becomes TRUE, causing a transition from RESPONSE to FAIL). Indicates that the Supplicant has not authenticated to the Authentication Server. |

RADIUS Authentication

This table contains information concerning the activity of the RADIUS authentication client on the client side of the RADIUS authentication protocol. It has one row for each RADIUS authentication server with which the client shares a secret.

To view the **RADIUS Authentication**, click **Monitoring > Port Access Control > RADIUS Authentication**, as shown below.

| RADIUS Authentication | | | | | | | | |
|-----------------------|-------------------|------------|----------------|------------------|---------------|----------------|---------------|---------------|
| ServerIndex | InvalidServerAddr | Identifier | AuthServerAddr | ServerPortNumber | RoundTripTime | AccessRequests | AccessRetrans | AccessAccepts |
| 1 | 0 | D-link | 0.0.0.0 | 0 | 0 | 0 | 0 | 0 |
| 2 | 0 | D-link | 0.0.0.0 | 0 | 0 | 0 | 0 | 0 |
| 3 | 0 | D-link | 0.0.0.0 | 0 | 0 | 0 | 0 | 0 |

Figure 12- 27. RADIUS Authentication window

The user may also select the desired time interval to update the statistics, between 1s and 60s, where “s” stands for seconds. The default value is one second. To clear the current statistics shown, click the *Clear* button in the top left hand corner.

The following fields can be viewed:

| Parameter | Description |
|--------------------------|---|
| ServerIndex | The identification number assigned to each RADIUS Authentication server that the client shares a secret with. |
| InvalidServerAddr | The number of RADIUS Access-Response packets received from unknown addresses. |
| Identifier | The NAS-Identifier of the RADIUS authentication client. (This is not necessarily the same as sysName in MIB II.) |
| AuthServerAddr | The (conceptual) table listing the RADIUS authentication servers with which the client shares a secret. |
| ServerPortNumber | The UDP port the client is using to send requests to this server. |
| RoundTripTime | The time interval (in hundredths of a second) between the most recent Access-Reply/Access-Challenge and the Access-Request that matched it from this RADIUS authentication server. |
| AccessRequests | The number of RADIUS Access-Request packets sent to this server. This does not include retransmissions. |
| AccessRetrans | The number of RADIUS Access-Request packets retransmitted to this RADIUS authentication server. |
| AccessAccepts | The number of RADIUS Access-Accept packets (valid or invalid) received from this server. |
| AccessRejects | The number of RADIUS Access-Reject packets (valid or invalid) received from this server. |
| AccessChallenges | The number of RADIUS Access-Challenge packets (valid or invalid) received from this server. |
| AccessResponses | The number of malformed RADIUS Access-Response packets received from this server. Malformed packets include packets with an invalid length. Bad authenticators or Signature attributes or known types are not included as malformed access responses. |
| BadAuthenticators | The number of RADIUS Access-Response packets containing invalid authenticators or Signature attributes received from this server. |

| | |
|------------------------|---|
| PendingRequests | The number of RADIUS Access-Request packets destined for this server that have not yet timed out or received a response. This variable is incremented when an Access-Request is sent and decremented due to receipt of an Access-Accept, Access-Reject or Access-Challenge, a timeout or retransmission. |
| Timeouts | The number of authentication timeouts to this server. After a timeout the client may retry to the same server, send to a different server, or give up. A retry to the same server is counted as a retransmit as well as a timeout. A send to a different server is counted as a Request as well as a timeout. |
| UnknownTypes | The number of RADIUS packets of unknown type which were received from this server on the authentication port |
| PacketsDropped | The number of RADIUS packets of which were received from this server on the authentication port and dropped for some other reason. |

RADIUS Account Client

This window shows managed objects used for managing RADIUS accounting clients, and the current statistics associated with them. It has one row for each RADIUS authentication server that the client shares a secret with.

To view the **RADIUS Account Client** window, click **Monitoring > Port Access Control > RADIUS Account Client**, as shown below.

| ServerIndex | InvalidServerAddr | Identifier | ServerAddr | ServerPortNumber | RoundTripTime | Requests |
|-------------|-------------------|------------|------------|------------------|---------------|----------|
| 1 | 0 | D-link | 0.0.0.0 | 0 | 0 | 0 |
| 2 | 0 | D-link | 0.0.0.0 | 0 | 0 | 0 |
| 3 | 0 | D-link | 0.0.0.0 | 0 | 0 | 0 |

Figure 12- 28. RADIUS Account Client window

The user may also select the desired time interval to update the statistics, between *1s* and *60s*, where “s” stands for seconds. The default value is one second. To clear the current statistics shown, click the *Clear* button in the top left hand corner.

The following fields can be viewed:

| Parameter | Description |
|--------------------------|--|
| ServerIndex | The identification number assigned to each RADIUS Accounting server that the client shares a secret with. |
| InvalidServerAddr | The number of RADIUS Accounting-Response packets received from unknown addresses. |
| Identifier | The NAS-Identifier of the RADIUS accounting client. (This is not necessarily the same as sysName in MIB II.) |
| ServerAddress | The (conceptual) table listing the RADIUS accounting servers with which the client shares a secret. |
| ServerPortNumber | The UDP port the client is using to send requests to this server. |
| RoundTripTime | The time interval between the most recent Accounting-Response and the Accounting-Request that matched it from this RADIUS accounting server. |

| | |
|---------------------------|---|
| Requests | The number of RADIUS Accounting-Request packets sent. This does not include retransmissions. |
| Retransmissions | The number of RADIUS Accounting-Request packets retransmitted to this RADIUS accounting server. Retransmissions include retries where the Identifier and Acct-Delay have been updated, as well as those in which they remain the same. |
| Responses | The number of RADIUS packets received on the accounting port from this server. |
| MalformedResponses | The number of malformed RADIUS Accounting-Response packets received from this server. Malformed packets include packets with an invalid length. Bad authenticators and unknown types are not included as malformed accounting responses. |
| BadAuthenticators | The number of RADIUS Accounting-Response packets, which contained invalid authenticators, received from this server. |
| PendingRequests | The number of RADIUS Accounting-Request packets sent to this server that have not yet timed out or received a response. This variable is incremented when an Accounting-Request is sent and decremented due to receipt of an Accounting-Response, a timeout or a retransmission. |
| Timeouts | The number of accounting timeouts to this server. After a timeout the client may retry to the same server, send to a different server, or give up. A retry to the same server is counted as a retransmit as well as a timeout. A send to a different server is counted as an Accounting-Request as well as a timeout. |
| UnknownTypes | The number of RADIUS packets of unknown type that were received from this server on the accounting port. |
| PacketsDropped | The number of RADIUS packets, which were received from this server on the accounting port and dropped for some other reason. |

MAC Address Table

This allows the Switch's dynamic MAC address forwarding table to be viewed. When the Switch learns an association between a MAC address and a port number, it makes an entry into its forwarding table. These entries are then used to forward packets through the Switch.

To view the MAC Address forwarding table, click **Monitoring > MAC Address Table**, as shown below:

The screenshot shows the MAC Address Table window with the following search filters and buttons:

- VLAN Name:** [] Find
- VLAN ID(1-4094):** [] Find
- MAC Address:** 00-00-00-00-00-00 Find
- Unit - Port:** 1 [v] Port 1 [v] Find
- Buttons: Clear Dynamic Entry, View All Entry, Clear All Entry

MAC Address Table

| VID | VLAN Name | MAC Address | Unit | Port | Type |
|-----|-----------|-------------------|------|------|---------|
| 1 | default | 00-00-00-00-00-01 | 1 | 21 | Dynamic |
| 1 | default | 00-00-01-02-03-04 | 1 | 21 | Dynamic |
| 1 | default | 00-00-5E-00-01-5F | 1 | 21 | Dynamic |
| 1 | default | 00-00-81-00-00-01 | 1 | 21 | Dynamic |
| 1 | default | 00-00-81-9A-F2-F4 | 1 | 21 | Dynamic |
| 1 | default | 00-00-EB-A4-50-5A | 1 | 21 | Dynamic |
| 1 | default | 00-01-06-30-00-00 | 1 | 21 | Dynamic |
| 1 | default | 00-01-10-FE-0D-14 | 1 | 21 | Dynamic |
| 1 | default | 00-01-11-22-33-02 | 1 | 21 | Dynamic |
| 1 | default | 00-01-6C-CE-62-E0 | 1 | 21 | Dynamic |
| 1 | default | 00-01-80-62-F6-EE | 1 | 21 | Dynamic |
| 1 | default | 00-02-85-32-14-75 | 1 | 21 | Dynamic |
| 1 | default | 00-03-09-18-10-01 | 1 | 21 | Dynamic |
| 1 | default | 00-03-47-92-C7-68 | 1 | 21 | Dynamic |
| 1 | default | 00-03-7F-E0-00-1A | 1 | 21 | Dynamic |
| 1 | default | 00-03-B3-00-09-E9 | 1 | 21 | Dynamic |
| 1 | default | 00-04-00-00-00-00 | 1 | 21 | Dynamic |
| 1 | default | 00-05-5D-04-D6-A4 | 1 | 21 | Dynamic |
| 1 | default | 00-05-5D-1E-D2-60 | 1 | 21 | Dynamic |
| 1 | default | 00-05-5D-7E-75-70 | 1 | 21 | Dynamic |

Total Entries: 319 Next

Figure 12- 29. MAC Address Table window

The following fields can be viewed or set:

| Parameter | Description |
|------------------------|---|
| VLAN Name | Enter a VLAN Name for which to browse the forwarding table. |
| VLAN ID(1-4094) | Enter a VLAN ID between 1 and 4094 for which to browse the forwarding table. |
| MAC Address | Enter a MAC address for which to browse the forwarding table. |
| Find | Allows the user to move to a sector of the database corresponding to a user defined port, VLAN, or MAC address. |

| | |
|----------------------------|--|
| VID | The VLAN ID of the VLAN the port is a member of. |
| MAC Address | The MAC address entered into the address table. |
| Unit – Port | The Unit and port that the MAC address above corresponds to. |
| Type | How the Switch discovered the MAC address. The possible entries are Dynamic, Self, and Static. |
| Next | Click this button to view the next page of the address table. |
| Clear Dynamic Entry | Clicking this button will clear Dynamic entries learned by the Switch. This may be accomplished by VLAN Name or by Port. |
| View All Entry | Clicking this button will allow the user to view all entries of the address table. |
| Clear All Entry | Clicking this button will allow the user to delete all entries of the address table. |

IGMP Snooping Group

IGMP Snooping allows the Switch to read the Multicast Group IP address and the corresponding MAC address from IGMP packets that pass through the Switch.

To view this window, click **Monitoring > IGMP Snooping Group**, as shown below:

| VLAN Name : <input type="text"/> | | <input type="button" value="Find"/> | | | |
|---|-----------|-------------------------------------|-------|--------------|-------------|
| <input type="button" value="View All Entry"/> | | | | | |
| Total Entries : 0 | | | | | |
| IGMP Snooping Group Table | | | | | |
| VID | VLAN Name | Source | Group | Member Ports | Filter Mode |

Figure 12- 30. IGMP Snooping Group Table window

The user may search the IGMP Snooping Table by entering the VLAN Name in the top left hand corner and clicking **Find**.



NOTE: The Switch supports up to 4K IGMP Snooping groups.

The following field can be viewed:

| Parameter | Description |
|---------------------|--|
| VID | The VLAN ID of the VLAN. |
| VLAN Name | The VLAN name which the member port belongs to. |
| Source | Displays the status of the source filtering, which is the ability for a system to report the interest in receiving packets from specific source addresses or sent to a particular multicast address. |
| Group | Specifies the multicast address of the multicast group. |
| Member Ports | The ports that are members of the multicast group. |
| Filter Mode | The Filter Mode will display <i>Include</i> or <i>Exclude</i> depending on whether or not the multicast-address has been configured to include or exclude the filter. |

MLD Snooping Group

The following window allows the user to view MLD Snooping Groups present on the Switch. MLD Snooping is an IPv6 function comparable to IGMP Snooping for IPv4. The user may browse this table by VLAN Name present in the switch by entering that VLAN Name in the empty field shown below, and clicking the **Find** button.

To view this window, click **Monitoring > MLD Snooping Group**, as shown below.

VLAN Name : Find

View All Entry

Total Entries : 0

MLD Snooping Group Table

| VID | VLAN Name | Source | Group | Member Ports | Filter Mode |
|-----|-----------|--------|-------|--------------|-------------|
|-----|-----------|--------|-------|--------------|-------------|

Figure 12- 31. MLD Snooping Group Table window

The following field can be viewed:

| Parameter | Description |
|---------------------|--|
| VID | The VLAN ID of the VLAN. |
| VLAN Name | The VLAN to which the member port belongs. |
| Source | Displays the status of the source filtering, which is the ability for a system to report the interest in receiving packets from specific source addresses or sent to a particular multicast address. |
| Group | The IP address of the MLD multicast group. |
| Member Ports | The ports that are members of the multicast group. |
| Filter Mode | The filter mode will display <i>Include</i> or <i>Exclude</i> depending on whether or not the multicast-address had been configured to include or exclude the filter. |



NOTE: To configure MLD snooping for the Switch, go to the **L2 Features** folder and select **MLD Snooping**. Configuration and other information concerning MLD snooping may be found in Section 6 of this manual under MLD Snooping.

Trace Route

The following window will aid the user in back tracing the route taken by a packet before arriving at the Switch. When initiated, the Trace Route program will display the IP addresses of the previous hops a packet takes from the Target IP Address entered in the window, until it reaches the Switch.

To view this window, click **Monitoring > Trace Route**, as shown below.

The screenshot shows a window titled "Traceroute" with a blue header. Below the header, there is a text prompt: "Enter the IP Address of the device or station you want to traceroute, then click **Start**." Below this prompt are five input fields, each with a label to its left: "Target IP Address:" with the value "0.0.0.0", "TTL:" with the value "30", "Port:" with the value "33435", "Timeout:" with the value "5", and "Probe:" with the value "1". At the bottom center of the window is a button labeled "Start".

Figure 12- 32. Traceroute window

To trace the route of a packet, set the following parameters located in this window, and click **Start**.

| Parameter | Description |
|--------------------------|--|
| Target IP Address | Enter the IP address of the computer to be traced. |
| TTL | The time to live value of the trace route request. This is the maximum number of routers the traceroute command will cross while seeking the network path between two devices. |
| Port | The virtual port number. The port number must be above 1024. The value range is from 30000 to 64900. |
| Timeout | Defines the time-out period while waiting for a response from the remote device. The user may choose an entry between 1 and 65535 seconds. |
| Probe | The probe value is the number of times the Switch will send probe packets to the next hop on the intended traceroute path. The default is 1. |

IGMP Snooping Forwarding

The IGMP Snooping Forwarding table displays the current multicast traffic that the device has received and which ports it should forward.

To view this window, click **Monitoring > IGMP Snooping Forwarding**, as shown below.

| | | | | | | | | | | | | | | | | | | | | | | | | | | |
|---------------------------------------|-------------|----------------------|---------------------------------------|----|----|----|----|----|----|----|----|-----------------|----|----|----|----|----|----|----|----|----|----|----|----|----|--|
| VLAN Name : | | <input type="text"/> | <input type="button" value="Search"/> | | | | | | | | | | | | | | | | | | | | | | | |
| IGMP Snooping Forwarding Table | | | | | | | | | | | | | | | | | | | | | | | | | | |
| VLAN Name | | Source IP | | | | | | | | | | Multicast Group | | | | | | | | | | | | | | |
| | | 0.0.0.0 | | | | | | | | | | 0.0.0.0 | | | | | | | | | | | | | | |
| Unit | Port Member | | | | | | | | | | | | | | | | | | | | | | | | | |
| | 1 | 2 | 3 | 4 | 5 | 6 | 7 | 8 | 9 | 10 | 11 | 12 | 13 | 14 | 15 | 16 | 17 | 18 | 19 | 20 | 21 | 22 | 23 | 24 | 25 | |
| | 26 | 27 | 28 | 29 | 30 | 31 | 32 | 33 | 34 | 35 | 36 | 37 | 38 | 39 | 40 | 41 | 42 | 43 | 44 | 45 | 46 | 47 | 48 | 49 | 50 | |
| 1 | | | | | | | | | | | | | | | | | | | | | | | | | | |
| Total Entries : 0 | | | | | | | | | | | | | | | | | | | | | | | | | | |

Figure 12- 33. IGMP Snooping Forwarding Table window

The user may search the IGMP Snooping Forwarding Table by VLAN Name by entering a VLAN name and then clicking **Search**.

The following field can be viewed:

| Parameter | Description |
|------------------------|---|
| VLAN Name | The VLAN Name where multicast packets are being received. |
| Source IP | The Source IP address that is sending multicast packets. |
| Multicast Group | The Multicast IP address located in the multicast packet. |
| Port Member | These are the ports where the IP multicast packets are being forwarded. |

MLD Snooping Forwarding

The MLD Snooping Forwarding table displays the current multicast traffic entries that the device has received and which ports it should be forwarded to.

To view this window, click **Monitoring** > **MLD Snooping Forwarding**, as shown below.

| | | | | | | | | | | | | | | | | | | | | | | | | | |
|--------------------------------------|-------------|----------------------|---------------------------------------|-----------------|----|----|----|----|----|----|----|----|----|----|----|----|----|----|----|----|----|----|----|----|----|
| VLAN Name : | | <input type="text"/> | <input type="button" value="Search"/> | | | | | | | | | | | | | | | | | | | | | | |
| MLD Snooping Forwarding Table | | | | | | | | | | | | | | | | | | | | | | | | | |
| VLAN Name | | Source IP | | Multicast Group | | | | | | | | | | | | | | | | | | | | | |
| | | | | | | | | | | | | | | | | | | | | | | | | | |
| Unit | Port Member | | | | | | | | | | | | | | | | | | | | | | | | |
| | 1 | 2 | 3 | 4 | 5 | 6 | 7 | 8 | 9 | 10 | 11 | 12 | 13 | 14 | 15 | 16 | 17 | 18 | 19 | 20 | 21 | 22 | 23 | 24 | 25 |
| | 26 | 27 | 28 | 29 | 30 | 31 | 32 | 33 | 34 | 35 | 36 | 37 | 38 | 39 | 40 | 41 | 42 | 43 | 44 | 45 | 46 | 47 | 48 | 49 | 50 |
| 1 | | | | | | | | | | | | | | | | | | | | | | | | | |
| Total Entries : 0 | | | | | | | | | | | | | | | | | | | | | | | | | |

Figure 12- 34. MLD Snooping Forwarding Table window

The user may search the MLD Snooping Forwarding Table by VLAN Name by entering a VLAN name and then clicking **Search**.

The following field can be viewed:

| Parameter | Description |
|-----------------|---|
| VLAN Name | The VLAN Name where multicast packets are being received. |
| Source IP | The Source IP address that is sending multicast packets. |
| Multicast Group | The Multicast IP address located in the multicast packet. |
| Port Member | These are the ports where the IP multicast packets are being forwarded. |

IP Forwarding Table

The **IP Forwarding Table** window is read-only where the user may view IP addresses discovered by the Switch. To search a specific IP address, enter it into the field labeled IP Address at the top of the window and click **Find** to begin your search.

To view this window, click **Monitoring** > **IP Forwarding Table**, as shown below.

| | | | |
|----------------------------|------------|--------------------------------------|-------------------------------------|
| IP Address | | <input type="text" value="0.0.0.0"/> | <input type="button" value="Find"/> |
| IP Forwarding Table | | | |
| Interface | IP Address | Port | Learned |
| System | 10.73.21.1 | 1:23 | Dynamic |
| Total Entries: 1 | | | |

Figure 12- 35. IP Forwarding Table window

Browse Routing Table

This window shows the current IP routing table of the Switch. To find a specific IP route, enter an IP address along with a proper subnet mask in the two fields offered and click **Find**.

To view this window, click **Monitoring > Browse Routing Table**, as shown below.

| | | | | | |
|-------------------------|----------------------|----------------|------------------|-------------|-----------------|
| IP Address | <input type="text"/> | | | | |
| Netmask | <input type="text"/> | | | Find | |
| Total Entries: 1 | | | | | |
| Routing Table | | | | | |
| IP Address | Netmask | Gateway | Interface | Cost | Protocol |
| 10.0.0.0 | 255.0.0.0 | 0.0.0.0 | System | 1 | Local |

Figure 12- 36. Routing Table window

Browse IP Multicast Forwarding Table

This window will show current IP multicasting information on the Switch. To search a specific entry, enter a multicast group IP address into the Multicast Group field, a Source IP address or Source Netmask and click **Find**.

To view this window, click **Monitoring > Browse IP Multicast Forwarding Table**, as shown below.

| | | | | | |
|--------------------------------------|--------------------------|-----------------------|--------------------------|--------------------|-----------------|
| Multicast Group | <input type="text"/> | | | | |
| Source IP Address | <input type="text"/> | | | | |
| Source Netmask | <input type="text"/> | | | Find | |
| IP Multicast Forwarding Table | | | | | |
| Multicast Group | Source IP Address | Source Netmask | Upstream Neighbor | Expire Time | Protocol |
| Total Entries: 0 | | | | | |

Figure 12- 37. IP Multicast Forwarding Table window

Browse IP Multicast Interface Table

This window will show current IP multicasting interfaces located on the Switch. To search a specific entry, enter a multicast interface name into the Interface Name field or choose a Protocol from the pull down list and click **Find**.

To view this window, click **Monitoring > Browse IP Multicast Interface Table**, as shown below.

| | | | | |
|-------------------------------|--------------------------------|-------------|--------------------------|-------------|
| Interface Name | <input type="text"/> | | | |
| Protocol | <input type="text" value="v"/> | | | Find |
| IP Multicast Interface | | | | |
| Interface | IP Address | Mask | Multicast Routing | |
| System | 10.73.21.33 | 255.0.0.0 | INACT | |
| Total Entries: 1 | | | | |

Figure 12- 38. IP Multicast Interface window

Browse IGMP Group Table

This window will show current IGMP group entries on the Switch. To search a specific IGMP group entry, enter an interface name into the Interface Name field or a Multicast Group IP address and click **Find**.

To view this window, click **Monitoring > Browse IGMP Group Table**, as shown below.

| | | | | |
|-------------------------|------------------------|----------------------|-------------------|------------------|
| Interface Name | <input type="text"/> | | | |
| Multicast Group | <input type="text"/> | | Find | |
| IGMP Group Table | | | | |
| Interface | Multicast Group | Last Reporter | IP Querier | IP Expire |
| Total Entries: 0 | | | | |

Figure 12- 39. IGMP Group Table window

DVMRP Monitor

This folder allows the DVMRP (Distance-Vector Multicast Routing Protocol) to be monitored for each IP interface defined on the Switch. The DVMRP monitor section offers three windows for monitoring: **Browse DVMRP Routing Table**, **Browse DVMRP Neighbor Table**, and **Browse DVMRP Routing Next Hop Table**.

Browse DVMRP Routing Table

Multicast routing information is gathered and stored by DVMRP in the DVMRP Routing Table, this window, contains one row for each port in a DVMRP mode. Each routing entry contains information about the source and multicast group, and incoming and outgoing interfaces. You may define your search by entering a Source IP Address and its subnet mask into the fields at the top of the window, and click **Find**.

To view this window, click **Monitoring > DVMRP Monitor > Browse DVMRP Routing Table**

| | | | | | | |
|----------------------------|-----------------------|--------------------------|---------------|----------------|-----------------------|--------------------|
| Source IP Address | <input type="text"/> | | | | | |
| Source Netmask | <input type="text"/> | | Find | | | |
| DVMRP Routing Table | | | | | | |
| Source IP Address | Source Netmask | Upstream Neighbor | Metric | Learned | Interface Name | Expire Time |
| Total Entries: 0 | | | | | | |

Figure 12- 40. DVMRP Routing Table window

Browse DVMRP Neighbor Table

This table contains information about DVMRP neighbors of the Switch. To search this table, enter an Interface Name, Neighbor Address or Source Netmask into the respective field and click the **Find** button. DVMRP neighbors of that entry will appear in the **DVMRP Neighbor Table** below.

To view this window, click **Monitoring > DVMRP Monitor > Browse DVMRP Neighbor Table**, as shown below.

| | | | |
|-----------------------------|----------------------------|----------------------|-------------------------------------|
| Interface Name | <input type="text"/> | | |
| Neighbor IP Address | <input type="text"/> | | |
| Neighbor Netmask | <input type="text"/> | | <input type="button" value="Find"/> |
| DVMRP Neighbor Table | | | |
| Interface Name | Neighbor IP Address | Generation ID | Expire Time |
| Total Entries: 0 | | | |

Figure 12- 41. DVMRP Neighbor Table window

Browse DVMRP Routing Next Hop Table

The DVMRP Routing Next Hop Table contains information regarding the next-hop for forwarding multicast packets on outgoing interfaces. Each entry in the **DVMRP Routing Next Hop Table** window refers to the next-hop of a specific source to a specific multicast group address. To search this table, enter an Interface Name, Source IP Address or Source Netmask into the respective field and click the **Find** button. The next hop of that DVMRP Routing entry will appear in the DVMRP Routing Next Hop Table below.

This view this table, click **Monitoring > DVMRP Monitoring > Browse DVMRP Routing Next Hop Table**, as shown below.

| | | | |
|-------------------------------------|-----------------------|-----------------------|-------------------------------------|
| Interface Name | <input type="text"/> | | |
| Source IP Address | <input type="text"/> | | |
| Source Netmask | <input type="text"/> | | <input type="button" value="Find"/> |
| DVMRP Routing Next Hop Table | | | |
| Source IP Address | Source Netmask | Interface Name | Type |
| Total Entries: 0 | | | |

Figure 12- 42. DVMRP Routing Next Hop Table window

PIM Monitor

Multicast routers use Protocol Independent Multicast (PIM) to determine which other multicast routers should receive multicast packets. To find out more information concerning PIM and its configuration on the Switch, see the IP Multicast Routing Protocol chapter of Section 6, Configuration.

Browse PIM Neighbor Table

The PIM Neighbor Address Table contains information regarding each of a router’s PIM neighbors. To search this table, enter an Interface Name, Neighbor Address or Neighbor Netmask into the respective field and click the **Find** button. PIM neighbors of that entry will appear in the PIM Neighbor Address Table below.

To view this window, click **Monitoring > PIM Monitor > Browse PIM Neighbor Table**, as shown below.

| | | |
|-----------------------------------|----------------------------|-------------------------------------|
| Interface Name | <input type="text"/> | |
| Neighbor IP Address | <input type="text"/> | |
| Neighbor Netmask | <input type="text"/> | <input type="button" value="Find"/> |
| PIM Neighbor Address Table | | |
| Interface Name | Neighbor IP Address | Expire Time |
| Total Entries: 0 | | |

Figure 12- 43. PIM Neighbor Address Table window

Browse PIM IP Multicast Route Table

The PIM IP Multicast Route Table is used to view information regarding the multicast data route entries in the Switch. To view this window, click **Monitoring > PIM Monitor > Browse PIM IP Mutlicast Route Table**, as shown below.

| | | | | | | | | |
|-------------------------------------|-----------------------|--------------------|-----------|-----------|---------------|------------|-------------|-------------|
| PIM IP Multicast Route Table | | | | | | | | |
| Group Address | Source Address | Source Mask | UA | AM | AMPref | ARB | Flag | Type |
| Total Entries: 0 | | | | | | | | |

Figure 12- 44. PIM IP Multicast Route Table window

Browse PIM RP-Set Table

The following window is used to assess information regarding the Rendezvous Point (RP) Set on the Switch. To view this window, click **Monitoring > PIM Monitor > Browse PIM RP-Set Table**, as shown below.

| | | | | | |
|----------------------------------|----------------|-------------------|------------------|---------------------|-------------|
| Bootstrap Router: 0.0.0.0 | | | | | |
| PIM RP-Set Table | | | | | |
| Group Address | Netmask | RP Address | Hold Time | Expired Time | Type |
| Total Entries: 0 | | | | | |

Figure 12- 45. PIM RP Set Table window

OSPF Monitor

This section offers windows regarding OSPF (Open Shortest Path First) information on the Switch, including the **OSPF LSDB Table**, **OSPF Neighbor Table** and the **OSPF Virtual Neighbor Table**. To view these tables, click **Monitoring > OSPF Monitor**.

Browse OSPF LSDB Table

The OSPF LSDB Table displays the current link-state database in use by the OSPF routing protocol on a per-OSPF area basis. To view this table, click **Monitoring > OSPF Monitor > Browse OSPF LSDB Table**, as shown below.

| | | | | | |
|-------------------------|------------------|-----------------------|----------------------|-------------|-----------------|
| Search Type | ALL | ▼ | | | |
| Area ID | 0.0.0.0 | | | | |
| Adv. Router ID | 0.0.0.0 | | | | |
| LSDB Type | RTRLink | ▼ | | | |
| | | Find | | | |
| OSPF LSDB Table | | | | | |
| Area ID | LSDB Type | Adv. Router ID | Link State ID | Cost | Sequence |
| Total Entries: 0 | | | | | |

Figure 12- 46. OSPF LSDB Table window

The user may search for a specific entry by entering the following information into the fields at the top of the screen:

To browse the **OSPF LSDB Table** window, you first must select which browse method you want to use in the Search Type field. The choices are *All*, *Area ID*, *Advertise Router ID*, *LSDB*, *Area ID & Advertise Router ID*, *Area ID & LSDB*, and *Advertise Router ID & LSDB*.

If *Area ID* is selected as the browse method, users must enter the IP address in the Area ID field, and then click *Find*.

If *Adv. Router ID* is selected, users must enter the IP address in the Adv. Router ID field, and then click *Find*.

If *LSDB* is selected, users must select the type of link state (*RTRLink*, *NETLink*, *Summary*, *ASSummary*, *ASExtLink* and *NSSA_EXT*) in the LSDB Type field, and then click *Find*.

The following fields are displayed in the OSPF LSDB Table:

| Parameter | Description | | | | | | | | | | |
|-----------------------|---|---------|---------------|---|-------------------------------------|---|--|---|---------------------------------------|---|--|
| Area ID | Allows the entry of an OSPF Area ID. This Area ID will then be used to search the table, and display an entry – if there is one. | | | | | | | | | | |
| Adv. Router ID | Displays the Advertising Router's ID. | | | | | | | | | | |
| LSDB Type | Displays which one of eight types of link advertisements by which the current link was discovered by the Switch: <i>All</i> , Router link (<i>RTRLink</i>), Network link (<i>NETLink</i>), Summary link (<i>Summary</i>), Autonomous System link (<i>ASSummary</i>), Autonomous System external link (<i>ASExternal</i>), and <i>NSSA_EXT</i> (<i>Not So Stubby Area</i> external) | | | | | | | | | | |
| Link State ID | This field identifies the portion of the Internet environment that is being described by the advertisement. The contents of this field depend on the advertisement's LS type. <table border="1"> <thead> <tr> <th>LS Type</th> <th>Link State ID</th> </tr> </thead> <tbody> <tr> <td>1</td> <td>The originating router's Router ID.</td> </tr> <tr> <td>2</td> <td>The IP interface address of the network's Designated Router.</td> </tr> <tr> <td>3</td> <td>The destination network's IP address.</td> </tr> <tr> <td>4</td> <td>The Router ID of the described AS boundary router.</td> </tr> </tbody> </table> | LS Type | Link State ID | 1 | The originating router's Router ID. | 2 | The IP interface address of the network's Designated Router. | 3 | The destination network's IP address. | 4 | The Router ID of the described AS boundary router. |
| LS Type | Link State ID | | | | | | | | | | |
| 1 | The originating router's Router ID. | | | | | | | | | | |
| 2 | The IP interface address of the network's Designated Router. | | | | | | | | | | |
| 3 | The destination network's IP address. | | | | | | | | | | |
| 4 | The Router ID of the described AS boundary router. | | | | | | | | | | |
| Cost | Displays the cost of the table entry. | | | | | | | | | | |
| Sequence | Displays a sequence number corresponding to number of times the current link has been advertised as changed. | | | | | | | | | | |

Browse OSPF Neighbor Table

Routers that are connected to the same area or segment become neighbors in that area. Neighbors are elected via the Hello protocol. IP multicast is used to send out Hello packets to other routers on the segment. Routers become neighbors when they see themselves listed in a Hello packet sent by another router on the same segment. In this way, two-way communication is guaranteed to be possible between any two-neighbor routers. This table displays OSPF neighbors of the Switch.

To view this table, click **Monitoring > OSPF Monitor > Browse OSPF Neighbor Table** as shown below.

Figure 12- 47. OSPF Neighbor Table window

To search for OSPF neighbors, enter an IP address and click **Find**. Valid OSPF neighbors will appear in the OSPF Neighbor Table below.

Browse OSPF Virtual Neighbor Table

This table displays a list of Virtual OSPF Neighbors of the Switch.

To view this table, click **Monitoring > OSPF Monitor > Browse OSPF Virtual Neighbor Table**, as shown below.

Figure 12- 48. OSPF Virtual Neighbor Table window

The user may choose specifically search a virtual neighbor by using one of the two search options at the top of the window, which are:

| Parameter | Description |
|-----------------------------------|--|
| Transit Area ID | Allows the entry of an OSPF Area ID – previously defined on the Switch – that allows a remote area to communicate with the backbone (area 0). A Transit Area cannot be a Stub Area or a Backbone Area. |
| Virtual Neighbor Router ID | The OSPF router ID for the remote router. This IP address uniquely identifies the remote area’s Area Border Router. |

Switch Logs

The Web manager allows the Switch's history log, as compiled by the Switch's management agent, to be viewed.

To view the Switch history log, click **Monitoring > Switch Logs**, as shown below.

| Log Type Selection | | |
|--------------------------------------|----------------------|--|
| Type | Unit | Apply |
| Regular Log ▾ | 1 ▾ | <input type="button" value="Apply"/> |
| Switch History Logs | | |
| Sequence | Time | Log Text |
| 9 | 2008-12-12, 13:45:37 | Port 1:23 link up, 100Mbps FULL duplex |
| 8 | 2008-12-12, 13:45:14 | Port 1:23 link down |
| 7 | 2008-12-12, 09:46:35 | Successful login through Web (Username: Anonymous) |
| 6 | 2008-12-12, 09:46:35 | Web session timed out (Username: Anonymous) |
| 5 | 2008-12-12, 09:31:21 | Successful login through Web (Username: Anonymous) |
| 4 | 2008-12-12, 09:17:39 | Port 1:23 link up, 1000Mbps FULL duplex |
| 3 | 2008-12-12, 09:17:39 | Port 1:21 link up, 100Mbps FULL duplex |
| 2 | 2008-12-12, 09:17:39 | Stacking topology is Chain. Master(Unit 1, MAC:00-19-5B-F5-26-C0). |
| 1 | 2008-12-12, 09:17:39 | Unit 1, System cold start |
| <input type="button" value="Clear"/> | | |

Figure 12- 49. Log Type Selection window

The Switch can record event information in its own logs, to designated SNMP trap receiving stations, and to the PC connected to the console manager. Clicking **Clear** will allow the user to clear the Switch History Log.

The information in the table is categorized as:

| Parameter | Description |
|-----------------|---|
| Type | Choose the type of log to view. There are two choices: <i>Regular Log</i> – Choose this option to view regular switch log entries, such as logins or firmware transfers. <i>Attack Log</i> – Choose this option to view attack log files, such as spoofing attacks. |
| Unit | Enter the unit you wish to view. |
| Sequence | A counter incremented whenever an entry to the Switch's history log is made. The table displays the last entry (highest sequence number) first. |
| Time | Displays the time in days, hours, and minutes since the Switch generated the log file. |
| Log Text | Displays text describing the event that triggered the history log entry. |

Browse ARP Table

This window will show current ARP entries on the Switch. To search a specific ARP entry, enter an interface name into the Interface Name or an IP address and click **Find**. To clear the ARP Table, click **Clear All**.

To view the Browse ARP table, click **Monitoring > Browse ARP Table**, as shown below.

| | | | |
|-------------------------|--------------------------------------|-------------------------------------|--|
| Interface Name | <input type="text"/> | | |
| IP Address | <input type="text" value="0.0.0.0"/> | <input type="button" value="Find"/> | <input type="button" value="Clear All"/> |
| ARP Table | | | |
| Interface Name | IP Address | MAC Address | Type |
| System | 10.0.0.0 | FF-FF-FF-FF-FF-FF | Local/Broadcast |
| System | 10.73.21.1 | 00-1B-FC-02-A6-03 | Dynamic |
| System | 10.73.21.33 | 00-19-5B-F5-26-C0 | Local |
| System | 10.255.255.255 | FF-FF-FF-FF-FF-FF | Local/Broadcast |
| Total Entries: 4 | | | |

Figure 12- 50. ARP Table window

MAC Based Access Control Authentication

This window is used to clear previously configured MAC Based Access Control Authentication entries.

To view the Browse ARP table, click **Monitoring > MAC Based Access Control Authentication**, as shown below.

| | | | |
|-----------------------------|----------------------|------------------------------------|--------------------------------------|
| Ports (e.g:1,5,7-12) | <input type="text"/> | <input type="checkbox"/> All Ports | <input type="button" value="Clear"/> |
| MAC Address | <input type="text"/> | | <input type="button" value="Clear"/> |

Figure 12- 51. ARP Table window

The The following fields can be configured:

| Parameter | Description |
|-----------------------------|--|
| Ports (e.g:1,5,7-12) | Enter the range of ports you wish to clear and click Clear , to clear all ports check the All Ports check box before clicking Clear . |
| MAC Address | Enter the MAC Address of the entry you wish to clear, and click Clear . |

Section 13

Switch Maintenance

Reset

Reboot System

Save Services

Logout

Reset

The Reset function has several options when resetting the Switch. Some of the current configuration parameters can be retained while resetting all other configuration parameters to their factory defaults.



NOTE: Only the Reset System option will enter the factory default parameters into the Switch's non-volatile RAM, and then restart the Switch. All other options enter the factory defaults into the current configuration, but do not save this configuration. Reset System will return the Switch's configuration to the state it was when it left the factory

Reset gives the option of retaining the Switch's User Accounts and History Log while resetting all other configuration parameters to their factory defaults. If the Switch is reset using this window, and Save Changes is not executed, the Switch will return to the last saved configuration when rebooted.

| Reset | |
|--------------------------------------|---|
| Reset | <input type="radio"/> Proceed with system reset except stacking, IP address, log, user account and banner. |
| Reset Config | <input type="radio"/> Proceed with system reset except stacking. |
| Reset System | <input checked="" type="radio"/> Proceed with system reset (reset all, save, reboot). <input type="checkbox"/> Reset Stack |
| <input type="button" value="Apply"/> | |

Figure 13- 1. Reset window

Reboot System

The following window is used to restart the Switch.

All of the configuration information entered from the last time Save Changes was executed will be lost. Click the **Restart** button to restart the Switch.

| Reboot System |
|--|
| <p>If you do not save the settings, all changes made in this session will be lost.</p> <p>Do you want to save the settings? <input checked="" type="radio"/> Yes <input type="radio"/> No</p> <p style="text-align: center;"><input type="button" value="Restart"/></p> |

Figure 13- 2. Reboot System window

Save Services

The following three windows will aid the user in saving configurations to the Switch's memory.

Save Changes

The Switch has two levels of memory, normal RAM and non-volatile or NV-RAM. Configuration changes are made effective clicking the **Save** button. When this is done, the settings will be immediately applied to the switching software in RAM, and will immediately take effect.

Some settings, though, require you to restart the Switch before they will take effect. Restarting the Switch erases all settings in RAM and reloads the stored settings from the NV-RAM. Thus, it is necessary to save all setting changes to NV-RAM before rebooting the switch.

To retain any configuration changes permanently, click the **Save** button in the **Save Changes** window. The save options allow one alternative configuration image to be stored.

To view this window, click **Save Services > Save Changes**, as shown below.

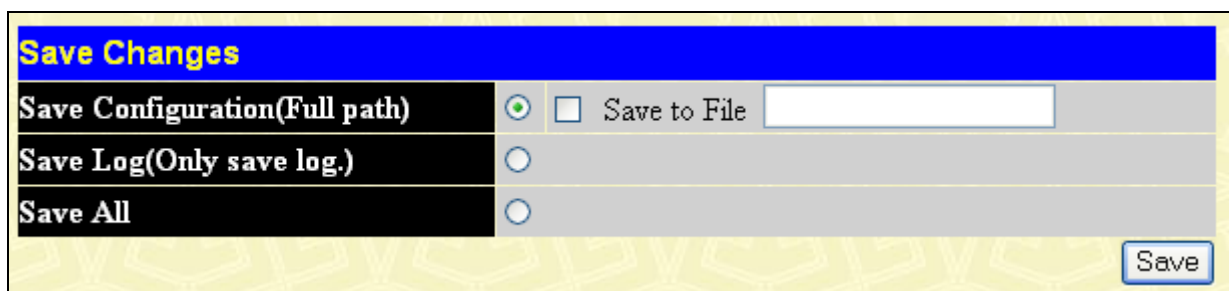

Figure 13- 3. Save Changes window

The Save Changes options include:

- **Save Configuration (Full path)** - Users may save the configuration to the internal flash memory of the Switch. To name the file, click the check box and enter the path of the filename to nominate this file as. All configuration files should start with C:/ . To use this file for configuration it must be designated as the *Boot* configuration using the **Configuration Settings** window (**Save Services > Current Configuration Settings**).
- **Save Log (Only save log)** - To save only the current log.
- **Save All** - To save the current configuration file indexed as Image file 1 and save the current log.

Once the **Save** button has been clicked, the following window will appear, confirming that the settings have been saved.

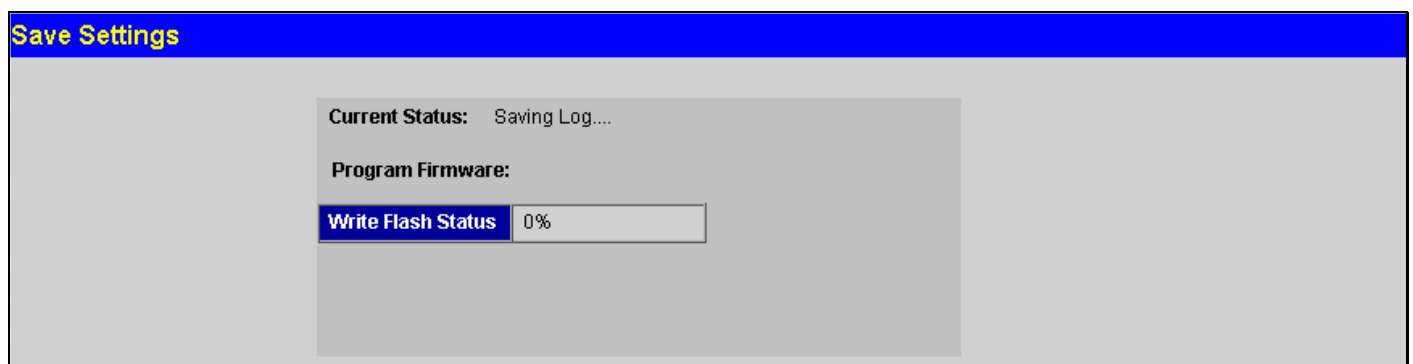

Figure 13- 4. Save Settings window

Current Configuration Settings

The **Current Configuration Settings** window allows users to manipulate configuration images saved in the Flash memory of the Switch.

To view this window, click **Save Services > Current Configuration Settings**, as shown below.

Figure 13- 5. Current Configuration Settings window

This window offers the following information:

| Parameter | Description |
|---------------------------|---|
| Configuration File | Enter the configuration file located on the Flash drive to be altered. |
| Action | <p>This field has two options for configuration.</p> <ul style="list-style-type: none"> <i>Boot</i> – Select this option to set the configuration file specified above as the boot up configuration for the Switch. This saved configuration will be set as the boot up file after a switch reboot has been performed. The default setting has configuration file C:/STARTUP.CFG as the boot up configuration file for the Switch unless specified here. <i>Active</i> - Choosing this parameter will first load and then activate this configuration file on the Switch. |

Click **Apply** to implement changes made.

Logout

Use the Logout page to logout of the Switch's Web-based management agent by clicking on the **Logout** button.

Figure 13- 6. Logout window

Appendix A

Technical Specifications

General

| | |
|-----------------------------|---|
| Protocols | <ul style="list-style-type: none"> IEEE 802.3 10BASE-T Ethernet IEEE 802.3u 100BASE-TX Fast Ethernet IEEE 802.3ab 1000BASE-T Gigabit Ethernet IEEE 802.3z 1000BASE-T (SFP “Mini GBIC”) IEEE 802.1D Spanning Tree IEEE 802.1s Multiple Spanning Tree IEEE 802.1w Rapid Spanning Tree IEEE 802.1Q VLAN IEEE 802.1V Protocol VLAN IEEE 802.1p Priority Queues IEEE 802.1X Port Based Network Access Control IEEE 802.3ad Link Aggregation Control IEEE 802.3x Full-duplex Flow Control IEEE 802.3 Nway auto-negotiation |
| Fiber-Optic | <ul style="list-style-type: none"> SFP (Mini GBIC) Support IEEE 802.3u 100BASE-FX (DEM-210 transceiver) IEEE 802.3u 100BASE-FX (DEM-211 transceiver) IEEE 802.3z 1000BASE-LX (DEM-310GT transceiver) IEEE 802.3z 1000BASE-SX (DEM-311GT transceiver) IEEE 802.3z 1000BASE-SX (DEM-312GT2 transceiver) IEEE 802.3z 1000BASE-LH (DEM-314GT transceiver) IEEE 802.3z 1000BASE-ZX (DEM-315GT transceiver) IEEE 802.3z WDM Transceiver (DEM-330T transceiver) IEEE 802.3z WDM Transceiver (DEM-330R transceiver) IEEE 802.3z WDM Transceiver (DEM-331T transceiver) IEEE 802.3z WDM Transceiver (DEM-331R transceiver) |
| XFP Support | <ul style="list-style-type: none"> IEEE 802.3ae 10G Fiber-Optic |
| CX4 Support | <ul style="list-style-type: none"> IEEE 802.3ak 10G Copper |
| Standards | CSMA/CD |
| Data Transfer Rates: | Half-duplex Full-duplex |
| Ethernet | 10 Mbps 20Mbps |
| Fast Ethernet | 100Mbps 200Mbps |
| Gigabit Ethernet | n/a 2000Mbps |
| Topology | Star |
| Network Cables | <ul style="list-style-type: none"> Cat.5 Enhanced for 1000BASE-T UTP Cat.5, Cat. 5 Enhanced for 100BASE-TX UTP Cat.3, 4, 5 for 10BASE-T EIA/TIA-568 100-ohm screened twisted-pair (STP)(100m) |
| Number of Ports | <ul style="list-style-type: none"> DGS-3627: 24 x 10/100/1000Mbps ports <li style="padding-left: 20px;">4 x 1000Mbps Combo SFP ports <li style="padding-left: 20px;">3 available slots for optional 10GE modules DGS-3627G: 24 x 1000Mbps SFP ports <li style="padding-left: 20px;">4 x 10/100/1000Mbps Combo Ports |

| | |
|------------|--|
| | 3 available slots for optional 10GE modules |
| DGS-3650: | 48 x 10/100/1000 Mbps ports 4 x 1000Mbps Combo SFP Ports 2 available slots for optional 10GE modules |
| DGS-3612G: | 12 x 100/1000Mbps SFP ports 4 x Combo 10/100/1000Mbps ports |
| DGS-3612: | 12 x 10/100/1000Mbps copper ports 4 x Combo 100/1000Mbps SFP ports |

Physical and Environmental

| | |
|------------------------------|---|
| Internal Power Supply | Input: 100~240V, AC/1.3A, 50~60Hz Output: 12V, 10A (Max) |
| Power Consumption | DGS-3627 – 95W DGS-3627G – 77W DGS-3650 – 140W DGS-3612G – 50W DGS-3612 – 45W |
| DC Fans | DGS-3627 – Four 40mm x 40mm x 20mm; one 50mm x 50mm x 20mm; one 44mm x 44mm x 11mm DGS-3627G – Four 40mm x 40mm x 20mm; one 50mm x 50mm x 20mm fans DGS-3650 – Two 40mm x 40mm x 20mm; three 40mm x 40mm x 10mm; one 75.7mm x 75.7mm x 30mm fans; one 44mm x 44mm x 11mm DGS-3612G – Three 40mm x 40mm x 20mm; one 50mm x 50mm x 20mm fans DGS-3612 - Two 40mm x 40mm x 20mm fans |
| Operating Temperature | 0 - 40°C |
| Storage Temperature | -40 - 70°C |
| Humidity | 5 - 95% non-condensing |
| Dimensions | DGS-3627, DGS-3627G, DGS-3650, DGS-3612G – 441mm x 389mm x 44mm DGS-3612 - 441mm x 310mm x 44mm |
| Weight | DGS-3627, DGS-3627G – 5.5kg (12.13 lbs) DGS-3650 – 6kg (13.23 lbs) DGS-3612G – 5kg (11.02 lbs) DGS-3612 - 3.8kg (8.38 lbs) |
| EMI | CE Class A, FCC Class A, C-Tick, VCCI |
| Safety | CB Report, CUL |

Performance

| | |
|---|--|
| Transmission Method | Store-and-forward |
| Packet Buffer | 2 MB per device |
| Packet Filtering/Forwarding Rate | 14,881 pps (10M port) 148.810 pps (100M port) 1,488,100 pps (1Gbps port) |

| | |
|----------------------------------|---|
| MAC Address Learning | Automatic update. Supports 16K MAC address. |
| Priority Queues | 8 Priority Queues per port. |
| Forwarding Table Age Time | Max age: 10-1000000 seconds. Default = 300. |

Appendix B

Cables and Connectors

When connecting the Switch to another switch, a bridge or hub, a normal cable is necessary. Please review these products for matching cable pin assignment.

The following diagrams and tables show the standard RJ-45 receptacle/connector and their pin assignments.

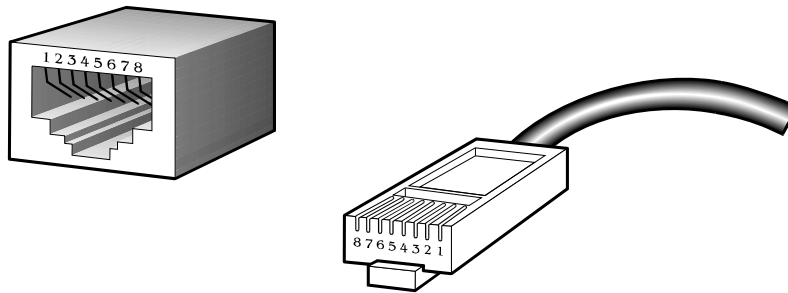

Figure B- 1. The standard RJ-45 port and connector

| RJ-45 Pin Assignments | | |
|-----------------------|----------------|----------------|
| Contact | MDI-X Port | MDI-II Port |
| 1 | RD+ (receive) | TD+ (transmit) |
| 2 | RD- (receive) | TD- (transmit) |
| 3 | TD+ (transmit) | RD+ (receive) |
| 4 | Not used | Not used |
| 5 | Not used | Not used |
| 6 | TD- (transmit) | RD- (receive) |
| 7 | Not used | Not used |
| 8 | Not used | Not used |

Table B- 1. The standard RJ-45 pin assignments

Appendix C

System Log Entries

The following table lists all possible entries and their corresponding meanings that will appear in the System Log of this Switch.

| Category | Event Description | Log Content | Severity | Remark |
|---------------------|-----------------------------------|---|---------------|--|
| <i>system</i> | System started up | System warm start | Critical | |
| <i>system</i> | System started up | System cold start | Critical | |
| | Configuration saved to flash | Configuration and log saved to flash by console (Username: <username>, IP: <ipaddr>, MAC: <macaddr>) | Informational | "by console" and "IP: <ipaddr>, MAC: <macaddr>" are XOR shown in log strings, which means if the user logs in through the console, no IP or MAC address information will be included in the log. |
| | Internal Power failed | Internal Power failed | Critical | |
| | Internal Power is recovered | Internal Power is recovered | Critical | |
| | Redundant Power failed | Redundant Power failed | Critical | |
| | Redundant Power is working | Redundant Power is working | Critical | |
| <i>up/down-load</i> | Firmware successfully uploaded | Firmware successfully uploaded by console (Username:<username>, IP:<ipaddr>, MAC:<macaddr>) | Informational | by console and "IP: <ipaddr>, MAC: <macaddr>" are XOR shown in log string, which means if the user logs in by console, there will be no IP and MAC information for logging. |
| | Firmware upload was unsuccessful | Firmware upload by console was unsuccessful (Username:<username>, IP:<ipaddr>, MAC:<macaddr>) | Warning | by console and "IP: <ipaddr>, MAC: <macaddr>" are XOR shown in log string, which means if the user logs in by console, there will be no IP and MAC information for logging. |
| | Firmware upgraded successfully | Firmware upgraded by console successfully (Username: <username>, IP: <ipaddr>, MAC: <macaddr>) | Informational | by console and "IP: <ipaddr>, MAC: <macaddr>" are XOR shown in log string, which means if the user logs in through the console, no IP or MAC address information will be included in the log. |
| | Firmware upgrade was unsuccessful | Firmware upgrade by console was unsuccessful! | Warning | by console and "IP: <ipaddr>, MAC: <macaddr>" are XOR |

| Category | Event Description | Log Content | Severity | Remark |
|------------------|---|---|---------------|---|
| | | (Username: <username>, IP: <ipaddr>, MAC: <macaddr>) | | shown in log string, which means if the user logs in through the console, no IP or MAC address information will be included in the log. |
| | Configuration successfully downloaded | Configuration successfully downloaded by console (Username: <username>, IP: <ipaddr>, MAC: <macaddr>) | Informational | by console and "IP: <ipaddr>, MAC: <macaddr>" are XOR shown in log string, which means if the user logs in through the console, no IP or MAC address information will be included in the log. |
| | Configuration download was unsuccessful | Configuration download by console was unsuccessful! (Username: <username>, IP: <ipaddr>, MAC: <macaddr>) | Warning | by console and "IP: <ipaddr>, MAC: <macaddr>" are XOR shown in log string, which means if the user logs in through the console, no IP or MAC address information will be included in the log. |
| | Configuration successfully uploaded | Configuration successfully uploaded by console (Username: <username>, IP: <ipaddr>, MAC: <macaddr>) | Informational | by console and "IP: <ipaddr>, MAC: <macaddr>" are XOR shown in log string, which means if the user logs in through the console, no IP or MAC address information will be included in the log. |
| | Configuration upload was unsuccessful | Configuration upload by console was unsuccessful! (Username: <username>, IP: <ipaddr>, MAC: <macaddr>) | Warning | by console and "IP: <ipaddr>, MAC: <macaddr>" are XOR shown in log string, which means if the user logs in through the console, no IP or MAC address information will be included in the log. |
| | Log message successfully uploaded | Log message successfully uploaded by console (Username: <username>, IP: <ipaddr>, MAC: <macaddr>) | Informational | by console and "IP: <ipaddr>, MAC: <macaddr>" are XOR shown in log string, which means if the user logs in through the console, no IP or MAC address information will be included in the log. |
| | Log message upload was unsuccessful | Log message upload by console was unsuccessful! (Username: <username>, IP: <ipaddr>, MAC: <macaddr>) | Warning | by console and "IP: <ipaddr>, MAC: <macaddr>" are XOR shown in log string, which means if the user logs in through the console, no IP or MAC address information will be included in the log. |
| <i>Interface</i> | Port link up | Port <portNum> link up, <link state> | Informational | Port link state (ex: , 100Mbps FULL duplex) |
| | Port link down | Port <portNum> link down | Informational | |

| Category | Event Description | Log Content | Severity | Remark |
|----------------|----------------------------------|---|---------------|--|
| <i>Console</i> | Successful login through Console | Successful login through Console (Username: <username>) | Informational | If the user logs in through the console, no IP or MAC address information will be included in the log. |
| | Login failed through Console | Login failed through Console (Username: <username>) | Warning | If the user logs in through the console, no IP or MAC address information will be included in the log. |
| | Logout through Console | Logout through Console (Username: <username>) | Informational | If the user logs in through the console, no IP or MAC address information will be included in the log. |
| | Console session timed out | Console session timed out (Username: <username>) | Informational | If the user logs in through the console, no IP or MAC address information will be included in the log. |
| <i>Web</i> | Successful login through Web | Successful login through Web (Username: <username>, IP: <ipaddr>, MAC: <macaddr>) | Informational | |
| | Login failed through Web | Login failed through Web (Username: <username>, IP: <ipaddr>, MAC: <macaddr>) | Warning | |
| | Logout through Web | Logout through Web (Username: <username>, IP: <ipaddr>, MAC: <macaddr>) | Informational | |
| | Successful login through SSL | Successful login through Web (SSL) (Username: <string>, IP: <ip>, MAC: <mac>) | Informational | |
| | Logout through SSL | Logout through Web (SSL) (Username: <string>, IP: <ip>, MAC: <mac>) | Informational | |
| | Login failed through SSL | Login failed through Web (SSL) (Username: <string>, IP: <ip>, MAC: <mac>) | Warning | |
| <i>Telnet</i> | Successful login through Telnet | Successful login through Telnet (Username: <username>, IP: <ipaddr>, MAC: <macaddr>) | Informational | |
| | Login failed through Telnet | Login failed through Telnet (Username: <username>, IP: <ipaddr>, MAC: <macaddr>) | Warning | |
| | Logout through | Logout through Telnet (Username: <username>, | Informational | |

| Category | Event Description | Log Content | Severity | Remark |
|-------------|---|--|---------------|--------|
| | Telnet | IP: <ipaddr>, MAC: <macaddr> | | |
| | Telnet session timed out | Telnet session timed out (Username: <username>, IP: <ipaddr>, MAC: <macaddr>) | Informational | |
| <i>SNMP</i> | SNMP request received with invalid community string | SNMP request received from <ipAddress> with invalid community string! | Informational | |
| <i>STP</i> | Topology changed | Topology changed | Informational | |
| | New Root selected | New Root selected | Informational | |
| | BPDU Loop Back on port | BPDU Loop Back on Port <portNum> | Warning | |
| | Spanning Tree Protocol is enabled | Spanning Tree Protocol is enabled | Informational | |
| | Spanning Tree Protocol is disabled | Spanning Tree Protocol is disabled | Informational | |
| <i>SSH</i> | Successful login through SSH | Successful login through SSH (Username: <username>, IP: <ipaddr>, MAC: <macaddr>) | Informational | |
| | Login failed through SSH | Login failed through SSH (Username: <username>, IP: <ipaddr>, MAC: <macaddr>) | Warning | |
| | Logout through SSH | Logout through SSH (Username: <username>, IP: <ipaddr>, MAC: <macaddr>) | Informational | |
| | SSH session timed out | SSH session timed out (Username: <username>, IP: <ipaddr>, MAC: <macaddr>) | Informational | |
| | Enable SSH server | SSH server is enabled | Informational | |
| | Disable SSH server | SSH server is disabled | Informational | |
| <i>AAA</i> | Authentication Policy is enabled | Authentication Policy is enabled (Module: AAA) | Informational | |
| | Authentication Policy is disabled | Authentication Policy is disabled (Module: AAA) | Informational | |

| Category | Event Description | Log Content | Severity | Remark |
|----------|--|--|---------------|--------|
| | Successful login through Console authenticated by AAA local method | Successful login through Console authenticated by AAA local method (Username: <username>) | Informational | |
| | Login failed through Console authenticated by AAA local method | Login failed through Console authenticated by AAA local method (Username: <username>) | Warning | |
| | Successful login through Web authenticated by AAA local method | Successful login through Web from <userIP> authenticated by AAA local method (Username: <username>, MAC: <macaddr>) | Informational | |
| | Login failed through Web authenticated by AAA local method | Login failed through Web from <userIP> authenticated by AAA local method (Username: <username>, MAC: <macaddr>) | Warning | |
| | Successful login through Web (SSL) authenticated by AAA local method | Successful login through Web (SSL) from <userIP> authenticated by AAA local method (Username: <username>, MAC: <macaddr>) | Informational | |
| | Login failed through Web (SSL) authenticated by AAA local method | Login failed through Web (SSL) from <userIP> authenticated by AAA local method (Username: <username>, MAC: <macaddr>) | Warning | |
| | Successful login through Telnet authenticated by AAA local method | Successful login through Telnet from <userIP> authenticated by AAA local method (Username: <username>, MAC: <macaddr>) | Informational | |
| | Login failed through Telnet authenticated by AAA local method | Login failed through Telnet from <userIP> authenticated by AAA local method (Username: <username>, MAC: <macaddr>) | Warning | |
| | Successful login through SSH authenticated by AAA local method | Successful login through SSH from <userIP> authenticated by AAA local method (Username: <username>, MAC: <macaddr>) | Informational | |

| Category | Event Description | Log Content | Severity | Remark |
|----------|--|---|---------------|--|
| | Login failed through SSH authenticated by AAA local method | Login failed through SSH from <userIP> authenticated by AAA local method (Username: <username>, MAC: <macaddr>) | Warning | |
| | Successful login through Console authenticated by AAA none method | Successful login through Console authenticated by AAA none method (Username: <username>) | Informational | |
| | Successful login through Web authenticated by AAA none method | Successful login through Web from <userIP> authenticated by AAA none method (Username: <username>, MAC: <macaddr>) | Informational | |
| | Successful login through Web (SSL) authenticated by AAA none method | Successful login through Web (SSL) from <userIP> authenticated by AAA none method (Username: <username>, MAC: <macaddr>) | Informational | |
| | Successful login through Telnet authenticated by AAA none method | Successful login through Telnet from <userIP> authenticated by AAA none method (Username: <username>, MAC: <macaddr>) | Informational | |
| | Successful login through SSH authenticated by AAA none method | Successful login through SSH from <userIP> authenticated by AAA none method (Username: <username>, MAC: <macaddr>) | Informational | |
| | Successful login through Console authenticated by AAA server | Successful login through Console authenticated by AAA server <serverIP> (Username: <username>) | Informational | If the user logs in through the console, no IP or MAC address information will be included in the log. |
| | Login failed through Console authenticated by AAA server | Login failed through Console authenticated by AAA server <serverIP> (Username: <username>) | Warning | There are no IP and MAC if login by console. |
| | Login failed through Console due to AAA server timeout or improper configuration | Login failed through Console due to AAA server timeout or improper configuration (Username: <username>) | Warning | |
| | Successful login through Web authenticated by AAA server | Successful login through Web from <userIP> authenticated by AAA server <serverIP> | Informational | |

| Category | Event Description | Log Content | Severity | Remark |
|----------|--|---|---------------|--------|
| | | (Username: <username>, MAC: <macaddr>) | | |
| | Login failed through Web authenticated by AAA server | Login failed through Web from <userIP> authenticated by AAA server <serverIP> (Username: <username>, MAC: <macaddr>) | Warning | |
| | Login failed through Web due to AAA server timeout or improper configuration | Login failed through Web from <userIP> due to AAA server timeout or improper configuration (Username: <username>, MAC: <macaddr>) | Warning | |
| | Successful login through Web (SSL) authenticated by AAA server | Successful login through Web (SSL) from <userIP> authenticated by AAA server <serverIP> (Username: <username>, MAC: <macaddr>) | Informational | |
| | Login failed through Web (SSL) authenticated by AAA server | Login failed through Web (SSL) from <userIP> authenticated by AAA server <serverIP> (Username: <username>, MAC: <macaddr>) | Warning | |
| | Login failed through Web (SSL) due to AAA server timeout or improper configuration | Login failed through Web(SSL) from <userIP> due to AAA server timeout or improper configuration (Username: <username>, MAC: <macaddr>) | Warning | |
| | Successful login through Telnet authenticated by AAA server | Successful login through Telnet from <userIP> authenticated by AAA server <serverIP> (Username: <username>, MAC: <macaddr>) | Informational | |
| | Login failed through Telnet authenticated by AAA server | Login failed through Telnet from <userIP> authenticated by AAA server <serverIP> (Username: <username>, MAC: <macaddr>) | Warning | |
| | Login failed through Telnet due to AAA server timeout or improper configuration | Login failed through Telnet from <userIP> due to AAA server timeout or improper configuration (Username: <username>, MAC: <macaddr>) | Warning | |

| Category | Event Description | Log Content | Severity | Remark |
|----------|--|--|---------------|--------|
| | Successful login through SSH authenticated by AAA server | Successful login through SSH from <userIP> authenticated by AAA server <serverIP> (Username: <username>, MAC: <macaddr>) | Informational | |
| | Login failed through SSH authenticated by AAA server | Login failed through SSH from <userIP> authenticated by AAA server <serverIP> (Username: <username>, MAC: <macaddr>) | Warning | |
| | Login failed through SSH due to AAA server timeout or improper configuration | Login failed through SSH from <userIP> due to AAA server timeout or improper configuration (Username: <username>, MAC: <macaddr>) | Warning | |
| | Successful Enable Admin through Console authenticated by AAA local_enable method | Successful Enable Admin through Console authenticated by AAA local_enable method (Username: <username>) | Informational | |
| | Enable Admin failed through Console authenticated by AAA local_enable method | Enable Admin failed through Console authenticated by AAA local_enable method (Username: <username>) | Warning | |
| | Successful Enable Admin through Web authenticated by AAA local_enable method | Successful Enable Admin through Web from <userIP> authenticated by AAA local_enable method (Username: <username>, MAC: <macaddr>) | Informational | |
| | Enable Admin failed through Web authenticated by AAA local_enable method | Enable Admin failed through Web from <userIP> authenticated by AAA local_enable method (Username: <username>, MAC: <macaddr>) | Warning | |
| | Successful Enable Admin through Web (SSL) authenticated by AAA local_enable method | Successful Enable Admin through Web (SSL) from <userIP> authenticated by AAA local_enable method (Username: <username>, MAC: <macaddr>) | Informational | |
| | Enable Admin failed through Web (SSL) authenticated by AAA local_enable method | Enable Admin failed through Web (SSL) from <userIP> authenticated by AAA local_enable method (Username: <username>, MAC: <macaddr>) | Warning | |

| Category | Event Description | Log Content | Severity | Remark |
|----------|---|---|---------------|--------|
| | | MAC: <macaddr> | | |
| | Successful Enable Admin through Telnet authenticated by AAA local_enable method | Successful Enable Admin through Telnet from <userIP> authenticated by AAA local_enable method (Username: <username>, MAC: <macaddr>) | Informational | |
| | Enable Admin failed through Telnet authenticated by AAA local_enable method | Enable Admin failed through Telnet from <userIP> authenticated by AAA local_enable method (Username: <username>, MAC: <macaddr>) | Warning | |
| | Successful Enable Admin through SSH authenticated by AAA local_enable method | Successful Enable Admin through SSH from <userIP> authenticated by AAA local_enable method (Username: <username>, MAC: <macaddr>) | Informational | |
| | Enable Admin failed through SSH authenticated by AAA local_enable method | Enable Admin failed through <Telnet or Web or SSH> from <userIP> authenticated by AAA local_enable method (Username: <username>, MAC: <macaddr>) | Warning | |
| | Successful Enable Admin through Console authenticated by AAA none method | Successful Enable Admin through Console authenticated by AAA none method (Username: <username>) | Informational | |
| | Successful Enable Admin through Web authenticated by AAA none method | Successful Enable Admin through Web from <userIP> authenticated by AAA none method (Username: <username>, MAC: <macaddr>) | Informational | |
| | Successful Enable Admin through Web (SSL) authenticated by AAA none method | Successful Enable Admin through Web (SSL) from <userIP> authenticated by AAA none method (Username: <username>, MAC: <macaddr>) | Informational | |
| | Successful Enable Admin through Telnet authenticated by AAA none method | Successful Enable Admin through Telnet from <userIP> authenticated by AAA none method (Username: <username>, MAC: <macaddr>) | Informational | |

| Category | Event Description | Log Content | Severity | Remark |
|----------|---|--|---------------|--------|
| | Successful Enable Admin through SSH authenticated by AAA none method | Successful Enable Admin through SSH from <userIP> authenticated by AAA none method (Username: <username>, MAC: <macaddr>) | Informational | |
| | Successful Enable Admin through Console authenticated by AAA server | Successful Enable Admin through Console authenticated by AAA server <serverIP> (Username: <username>) | Informational | |
| | Enable Admin failed through Console authenticated by AAA server | Enable Admin failed through Console authenticated by AAA server <serverIP> (Username: <username>) | Warning | |
| | Enable Admin failed through Console due to AAA server timeout or improper configuration | Enable Admin failed through Console due to AAA server timeout or improper configuration (Username: <username>) | Warning | |
| | Successful Enable Admin through Web authenticated by AAA server | Successful Enable Admin through Web from <userIP> authenticated by AAA server <serverIP> (Username: <username>, MAC: <macaddr>) | Informational | |
| | Enable Admin failed through Web authenticated by AAA server | Enable Admin failed through Web from <userIP> authenticated by AAA server <serverIP> (Username: <username>, MAC: <macaddr>) | Warning | |
| | Enable Admin failed through Web due to AAA server timeout or improper configuration | Enable Admin failed through Web from <userIP> due to AAA server timeout or improper configuration (Username: <username>, MAC: <macaddr>) | Warning | |
| | Successful Enable Admin through Web (SSL) authenticated by AAA server | Successful Enable Admin through Web (SSL) from <userIP> authenticated by AAA server <serverIP> (Username: <username>, MAC: <macaddr>) | Informational | |
| | Enable Admin failed through Web (SSL) authenticated by AAA server | Enable Admin failed through Web (SSL) from <userIP> authenticated by AAA server <serverIP> (Username: <username>, MAC: <macaddr>) | Warning | |

| Category | Event Description | Log Content | Severity | Remark |
|----------------------|---|---|---------------|---|
| | Enable Admin failed through Web (SSL) due to AAA server timeout or improper configuration | Enable Admin failed through Web (SSL) from <userIP> due to AAA server timeout or improper configuration (Username: <username>, MAC: <macaddr>) | Warning | |
| | Successful Enable Admin through Telnet authenticated by AAA server | Successful Enable Admin through Telnet from <userIP> authenticated by AAA server <serverIP> (Username: <username>, MAC: <macaddr>) | Informational | |
| | Enable Admin failed through Telnet authenticated by AAA server | Enable Admin failed through Telnet from <userIP> authenticated by AAA server <serverIP> (Username: <username>, MAC: <macaddr>) | Warning | |
| | Enable Admin failed through Telnet due to AAA server timeout or improper configuration | Enable Admin failed through Telnet from <userIP> due to AAA server timeout or improper configuration (Username: <username>, MAC: <macaddr>) | Warning | |
| | Successful Enable Admin through SSH authenticated by AAA server | Successful Enable Admin through SSH from <userIP> authenticated by AAA server <serverIP> (Username: <username>, MAC: <macaddr>) | Informational | |
| | Enable Admin failed through SSH authenticated by AAA server | Enable Admin failed through SSH from <userIP> authenticated by AAA server <serverIP> (Username: <username>, MAC: <macaddr>) | Warning | |
| | Enable Admin failed through SSH due to AAA server timeout or improper configuration | Enable Admin failed through SSH from <userIP> due to AAA server timeout or improper configuration (Username: <username>, MAC: <macaddr>) | Warning | |
| | AAA server timed out | AAA server <serverIP> (Protocol: <protocol>) connection failed | Warning | <protocol> is one of TACACS, XTACACS, TACACS+ or RADIUS |
| Port Security | port security has reached its maximum learning size and will not learn any new addresses | Port security violation (Port: <portNum>, MAC: <macaddr>) | Warning | |

| Category | Event Description | Log Content | Severity | Remark |
|----------------------------|---|---|---------------|--------|
| <i>IP-MAC-PORT Binding</i> | Unauthenticated IP address discarded by IP mac port binding | Unauthenticated IP-MAC address and discarded by ip mac port binding (IP: <ipaddr>, MAC: <macaddr>, Port <portNum>) | Warning | |
| <i>Safeguard Engine</i> | Safeguard Engine is in normal mode | Safeguard Engine enters NORMAL mode | Informational | |
| | Safeguard Engine is in filtering packet mode | Safeguard Engine enters EXHAUSTED mode | Warning | |
| <i>Packet Storm</i> | Broadcast storm occurrence | Broadcast storm is occurring (port: <id>) | Warning | |
| | Broadcast storm has cleared | Broadcast storm has cleared (port: <id>) | Informational | |
| | Multicast storm occurrence | Multicast storm is occurring (port: <id>) | Warning | |
| | Multicast storm has cleared | Multicast storm has cleared (port: <id>) | Informational | |
| <i>Security</i> | Packet received containing a MAC address identical to the MAC address of the device's interface | Possible spoofing attack from <mac> port <u16> | Critical | |

Appendix D

Cable Lengths

Use the following table to as a guide for the maximum cable lengths.

| Standard | Media Type | Maximum Distance |
|-------------|--|------------------|
| Mini-GBIC | 1000BASE-LX, Single-mode fiber module | 10km |
| | 1000BASE-SX, Multi-mode fiber module | 550m |
| | 1000BASE-LHX, Single-mode fiber module | 40km |
| | 1000BASE-ZX, Single-mode fiber module | 80km |
| 100 BASE-FX | 100BASE-FX, Fiber Cable (100 Mbps) | 100m |
| 1000BASE-T | Category 5e UTP Cable | 100m |
| | Category 5 UTP Cable (1000 Mbps) | |
| 100BASE-TX | Category 5 UTP Cable (100 Mbps) | 100m |
| 10BASE-T | Category 3 UTP Cable (10 Mbps) | 100m |

Glossary

1000BASE-SX: A short laser wavelength on multimode fiber optic cable for a maximum length of 2000 meters

1000BASE-LX: A long wavelength for a "long haul" fiber optic cable for a maximum length of 10 kilometers

100BASE-FX: 100Mbps Ethernet implementation over fiber.

100BASE-TX: 100Mbps Ethernet implementation over Category 5 and Type 1 Twisted Pair cabling.

10BASE-T: The IEEE 802.3 specification for Ethernet over Unshielded Twisted Pair (UTP) cabling.

aging: The automatic removal of dynamic entries from the Switch Database which have timed-out and are no longer valid.

ATM: Asynchronous Transfer Mode. A connection oriented transmission protocol based on fixed length cells (packets). ATM is designed to carry a complete range of user traffic, including voice, data and video signals.

auto-negotiation: A feature on a port, which allows it to advertise its capabilities for speed, duplex and flow control. When connected to an end station that also supports auto-negotiation, the link can self-detect its optimum operating setup.

backbone port: A port which does not learn device addresses, and which receives all frames with an unknown address. Backbone ports are normally used to connect the Switch to the backbone of your network. Note that backbone ports were formerly known as designated downlink ports.

backbone: The part of a network used as the primary path for transporting traffic between network segments.

bandwidth: Information capacity, measured in bits per second that a channel can transmit. The bandwidth of Ethernet is 10Mbps, the bandwidth of Fast Ethernet is 100Mbps.

baud rate: The switching speed of a line. Also known as line speed between network segments.

BOOTP: The BOOTP protocol allows you to automatically map an IP address to a given MAC address each time a device is started. In addition, the protocol can assign the subnet mask and default gateway to a device.

bridge: A device that interconnects local or remote networks no matter what higher-level protocols are involved. Bridges form a single logical network, centralizing network administration.

broadcast: A message sent to all destination devices on the network.

broadcast storm: Multiple simultaneous broadcasts that typically absorb available network bandwidth and can cause network failure.

console port: The port on the Switch accepting a terminal or modem connector. It changes the parallel arrangement of data within computers to the serial form used on data transmission links. This port is most often used for dedicated local management.

CSMA/CD: Channel access method used by Ethernet and IEEE 802.3 standards in which devices transmit only after finding the data channel clear for some period of time. When two devices transmit simultaneously, a collision occurs and the colliding devices delay their retransmissions for a random amount of time.

data center switching: The point of aggregation within a corporate network where a switch provides high-performance access to server farms, a high-speed backbone connection and a control point for network management and security.

Ethernet: A LAN specification developed jointly by Xerox, Intel and Digital Equipment Corporation. Ethernet networks operate at 10Mbps using CSMA/CD to run over cabling.

Fast Ethernet: 100Mbps technology based on the Ethernet/CSMA/CD network access method.

Flow Control: (IEEE 802.3z) A means of holding packets back at the transmit port of the connected end station. Prevents packet loss at a congested switch port.

forwarding: The process of sending a packet toward its destination by an internetworking device.

full duplex: A system that allows packets to be transmitted and received at the same time and, in effect, doubles the potential throughput of a link.

half duplex: A system that allows packets to be transmitted and received, but not at the same time. Contrast with full duplex.

IP address: Internet Protocol address. A unique identifier for a device attached to a network using TCP/IP. The address is written as four octets separated with full-stops (periods), and is made up of a network section, an optional subnet section and a host section.

IPX: Internetwork Packet Exchange. A protocol allowing communication in a NetWare network.

LAN - Local Area Network: A network of connected computing resources (such as PCs, printers, servers) covering a relatively small geographic area (usually not larger than a floor or building). Characterized by high data rates and low error rates.

latency: The delay between the time a device receives a packet and the time the packet is forwarded out of the destination port.

line speed: See baud rate.

main port: The port in a resilient link that carries data traffic in normal operating conditions.

MDI - Medium Dependent Interface: An Ethernet port connection where the transmitter of one device is connected to the receiver of another device.

MDI-X - Medium Dependent Interface Cross-over: An Ethernet port connection where the internal transmit and receive lines are crossed.

MIB - Management Information Base: Stores a device's management characteristics and parameters. MIBs are used by the Simple Network Management Protocol (SNMP) to contain attributes of their managed systems. The Switch contains its own internal MIB.

multicast: Single packets copied to a specific subset of network addresses. These addresses are specified in the destination-address field of the packet.

protocol: A set of rules for communication between devices on a network. The rules dictate format, timing, sequencing and error control.

resilient link: A pair of ports that can be configured so that one will take over data transmission should the other fail. See also main port and standby port.

RJ-45: Standard 8-wire connectors for IEEE 802.3 10BASE-T networks.

RMON: Remote Monitoring. A subset of SNMP MIB II that allows monitoring and management capabilities by addressing up to ten different groups of information.

RPS - Redundant Power System: A device that provides a backup source of power when connected to the Switch.

server farm: A cluster of servers in a centralized location serving a large user population.

SLIP - Serial Line Internet Protocol: A protocol, which allows IP to run over a serial line connection.

SNMP - Simple Network Management Protocol: A protocol originally designed to be used in managing TCP/IP internets. SNMP is presently implemented on a wide range of computers and networking equipment and may be used to manage many aspects of network and end station operation.

Spanning Tree Protocol (STP): A bridge-based system for providing fault tolerance on networks. STP works by allowing you to implement parallel paths for network traffic, and ensure that redundant paths are disabled when the main paths are operational and enabled if the main paths fail.

stack: A group of network devices that are integrated to form a single logical device.

standby port: The port in a resilient link that will take over data transmission if the main port in the link fails.

switch: A device, which filters, forwards and floods packets based on the packet's destination address. The switch learns the addresses associated with each switch port and builds tables based on this information to be used for the switching decision.

TCP/IP: A layered set of communications protocols providing Telnet terminal emulation, FTP file transfer, and other services for communication among a wide range of computer equipment.

telnet: A TCP/IP application protocol that provides virtual terminal service, letting a user log in to another computer system and access a host as if the user were connected directly to the host.

TFTP - Trivial File Transfer Protocol: Allows you to transfer files (such as software upgrades) from a remote device using your switch's local management capabilities.

UDP - User Datagram Protocol: An Internet standard protocol that allows an application program on one device to send a datagram to an application program on another device.

VLAN - Virtual LAN: A group of location- and topology-independent devices that communicate as if they are on a common physical LAN.

VLTrunk - Virtual LAN Trunk: A Switch-to-Switch link which carries traffic for all the VLANs on each Switch.

VT100: A type of terminal that uses ASCII characters. VT100 screens have a text-based appearance.

Subject to the terms and conditions set forth herein, D-Link Systems, Inc. ("D-Link") provides this lifetime product warranty for hardware:

- Only for products purchased, delivered and used within the fifty states of the United States, the District of Columbia, U.S. Possessions or Protectorates, U.S. Military Installations, or addresses with an APO or FPO, and;
- Only with proof of purchase.

Product Warranty: D-Link warrants that the hardware portion of the D-Link product, including internal and external power supplies and fans ("Hardware"), will be free from material defects in workmanship and materials under normal use from the date of original retail purchase of the product ("Warranty Period"), except as otherwise stated herein.

The customer's sole and exclusive remedy and the entire liability of D-Link and its suppliers under this Warranty will be, at D-Link's option, to repair or replace the defective Hardware during the Warranty Period at no charge to the owner or to refund the actual purchase price paid. Any repair or replacement will be rendered by D-Link at an Authorized D-Link Service Office. The replacement hardware need not be new or have an identical make, model or part. D-Link may, at its option, replace the defective Hardware or any part thereof with any reconditioned product that D-Link reasonably determines is substantially equivalent (or superior) in all material respects to the defective Hardware. Repaired or replacement hardware will be warranted for the remainder of the original Warranty Period or ninety (90) days, whichever is longer, and is subject to the same limitations and exclusions. If a material defect is incapable of correction, or if D-Link determines that it is not practical to repair or replace the defective Hardware, the actual price paid by the original purchaser for the defective Hardware will be refunded by D-Link upon return to D-Link of the defective Hardware. All Hardware or part thereof that is replaced by D-Link, or for which the purchase price is refunded, shall become the property of D-Link upon replacement or refund.

Software Warranty: D-Link warrants that the software portion of the product ("Software") will substantially conform to D-Link's then current functional specifications for the Software, as set forth in the applicable documentation, from the date of original retail purchase of the Software for a period of ninety (90) days ("Software Warranty Period"), provided that the Software is properly installed on approved hardware and operated as contemplated in its documentation. D-Link further warrants that, during the Software Warranty Period, the magnetic media on which D-Link delivers the Software will be free of physical defects. The customer's sole and exclusive remedy and the entire liability of D-Link and its suppliers under this Limited Warranty will be, at D-Link's option, to replace the non-conforming Software (or defective media) with software that substantially conforms to D-Link's functional specifications for the Software or to refund the portion of the actual purchase price paid that is attributable to the Software. Except as otherwise agreed by D-Link in writing, the replacement Software is provided only to the original licensee, and is subject to the terms and conditions of the license granted by D-Link for the Software. Replacement Software will be warranted for the remainder of the original Warranty Period and is subject to the same limitations and exclusions. If a material non-conformance is incapable of correction, or if D-Link determines in its sole discretion that it is not practical to replace the non-conforming Software, the price paid by the original licensee for the non-conforming Software will be refunded by D-Link; provided that the non-conforming Software (and all copies thereof) is first returned to D-Link. The license granted respecting any Software for which a refund is given automatically terminates.

Non-Applicability of Warranty: The Warranty provided hereunder for D-Link's products will not be applied to and does not cover any products obtained through a special or unique pricing agreement, if such agreement provides for warranty terms different from those normally provided with the product or set forth herein, nor to any refurbished product and any product purchased through the inventory clearance or liquidation sale or other sales in which D-Link, the sellers, or the liquidators expressly disclaim their warranty obligation pertaining to the product and in that case, the product is being sold "As-Is" without any warranty whatsoever including, without limitation, the Warranty as described herein, notwithstanding anything stated herein to the contrary.

Submitting A Claim: The customer shall return the product to the original purchase point based on its return policy. In case the return policy period has expired and the product is within warranty, the customer shall submit a claim to D-Link as outlined below:

- The customer must submit with the product as part of the claim a written description of the Hardware defect or Software nonconformance in sufficient detail to allow D-Link to confirm the same, along with proof of purchase of the product (such as a copy of the dated purchase invoice for the product).
- The customer must obtain a Case ID Number from D-Link Technical Support by going to <https://support.dlink.com>, who will attempt to assist the customer in resolving any suspected defects with the product. If the product is considered defective, the customer must obtain a Return Material Authorization ("RMA") number by completing the RMA form and entering the assigned Case ID Number at <https://rma.dlink.com/>.
- After an RMA number is issued, the defective product must be packaged securely in the original or other suitable shipping package to ensure that it will not be damaged in transit, and the RMA number must be prominently marked on the outside of the package. Include any manuals or accessories in the shipping package.
- The customer is responsible for all in-bound shipping charges to D-Link. No Cash on Delivery ("COD") is allowed. Products sent COD will either be rejected by D-Link or become the property of D-Link. Products shall be fully insured by the customer and shipped to **D-Link Systems, Inc., 17595 Mt. Herrmann, Fountain Valley, CA 92708**. D-Link will not be held responsible for any packages that are lost in transit to D-Link. The repaired or replaced packages will be shipped to the customer via UPS Ground or any common carrier selected by D-Link. Return shipping charges shall be prepaid by D-Link if you use an address in the United States, otherwise we will ship the product to you freight collect. Expedited shipping is available upon request and provided shipping charges are prepaid by the customer.

D-Link may reject or return any product that is not packaged and shipped in strict compliance with the foregoing requirements, or for which an RMA number is not visible from the outside of the package. The product owner agrees to pay D-Link's reasonable handling and return shipping charges for any product that is not packaged and shipped in accordance with the foregoing requirements, or that is determined by D-Link not to be defective or non-conforming.

What Is Not Covered: The Warranty provided herein by D-Link does not cover: Products that, in D-Link's judgment, have been subjected to abuse, accident, alteration, modification, tampering, negligence, misuse, faulty installation, lack of reasonable care, repair or service in any way that is not contemplated in the documentation for the product, or if the model or serial number has been altered, tampered with, defaced or removed; Initial installation, installation and removal of the product for repair, and shipping costs; Operational adjustments covered in the operating manual for the product, and normal maintenance; Damage that occurs in shipment, due to act of God, failures due to power surge, and cosmetic damage; Any hardware, software, firmware or other products or services provided by anyone other than D-Link; and Products that have been purchased from inventory clearance or liquidation sales or other sales in which D-Link, the sellers, or the liquidators expressly disclaim their warranty obligation pertaining to the product. While necessary maintenance or repairs on your Product can be performed by any company, we recommend that you use only an Authorized D-Link Service Office. Improper or incorrectly performed maintenance or repair voids this Warranty.

Disclaimer of Other Warranties: EXCEPT AS SPECIFICALLY SET FORTH ABOVE OR AS REQUIRED BY LAW, THE PRODUCT IS PROVIDED "AS-IS" WITHOUT ANY WARRANTY OF ANY KIND WHATSOEVER INCLUDING, WITHOUT LIMITATION, ANY WARRANTY OF MERCHANTABILITY, FITNESS FOR A PARTICULAR PURPOSE AND NON-INFRINGEMENT. IF ANY IMPLIED WARRANTY CANNOT BE DISCLAIMED IN ANY TERRITORY WHERE A PRODUCT IS SOLD, THE DURATION OF SUCH IMPLIED WARRANTY SHALL BE LIMITED TO NINETY (90) DAYS. EXCEPT AS EXPRESSLY COVERED UNDER THE WARRANTY PROVIDED HEREIN, THE ENTIRE RISK AS TO THE QUALITY, SELECTION AND PERFORMANCE OF THE PRODUCT IS WITH THE PURCHASER OF THE PRODUCT.

Limitation of Liability: TO THE MAXIMUM EXTENT PERMITTED BY LAW, D-LINK IS NOT LIABLE UNDER ANY CONTRACT, NEGLIGENCE, STRICT LIABILITY OR OTHER LEGAL OR EQUITABLE THEORY FOR ANY LOSS OF USE OF THE PRODUCT, INCONVENIENCE OR DAMAGES OF ANY CHARACTER, WHETHER DIRECT, SPECIAL, INCIDENTAL OR CONSEQUENTIAL (INCLUDING, BUT NOT LIMITED TO, DAMAGES FOR LOSS OF GOODWILL, LOSS OF REVENUE OR PROFIT, WORK STOPPAGE, COMPUTER FAILURE OR MALFUNCTION, FAILURE OF OTHER EQUIPMENT OR COMPUTER PROGRAMS TO WHICH D-LINK'S PRODUCT IS CONNECTED WITH, LOSS OF INFORMATION OR DATA CONTAINED IN, STORED ON, OR INTEGRATED WITH ANY PRODUCT RETURNED TO D-LINK FOR WARRANTY SERVICE) RESULTING FROM THE USE OF THE PRODUCT, RELATING TO WARRANTY SERVICE, OR ARISING OUT OF ANY BREACH OF THIS WARRANTY, EVEN IF D-LINK HAS BEEN ADVISED OF THE POSSIBILITY OF SUCH DAMAGES. THE SOLE REMEDY FOR A BREACH OF THE FOREGOING WARRANTY IS REPAIR, REPLACEMENT OR REFUND OF THE DEFECTIVE OR NON-CONFORMING PRODUCT. THE MAXIMUM LIABILITY OF D-LINK UNDER THIS WARRANTY IS LIMITED TO THE PURCHASE PRICE OF THE PRODUCT COVERED BY THE WARRANTY. THE FOREGOING EXPRESS WRITTEN WARRANTIES AND REMEDIES ARE EXCLUSIVE AND ARE IN LIEU OF ANY OTHER WARRANTIES OR REMEDIES, EXPRESS, IMPLIED OR STATUTORY.

Lifetime Warranty: IF LOCAL LAW MANDATES THE USE OF A DEFINITION OF "LIFETIME WARRANTY" DIFFERENT FROM THAT PROVIDED HEREIN, THEN THE LOCAL LAW DEFINITION WILL SUPERSEDE AND TAKE PRECEDENCE, TO THE EXTENT NECESSARY TO COMPLY.

Governing Law: This Warranty shall be governed by the laws of the State of California. Some states do not allow exclusion or limitation of incidental or consequential damages, or limitations on how long an implied warranty lasts, so the foregoing limitations and exclusions may not apply. This Warranty provides specific legal rights and you may also have other rights which vary from state to state.

Trademarks: D-Link is a registered trademark of D-Link Systems, Inc. Other trademarks or registered trademarks are the property of their respective owners.

Copyright Statement: No part of this publication or documentation accompanying this product may be reproduced in any form or by any means or used to make any derivative such as translation, transformation, or adaptation without permission from D-Link Corporation/D-Link Systems, Inc., as stipulated by the United States Copyright Act of 1976 and any amendments thereto. Contents are subject to change without prior notice. Copyright 2009 by D-Link Corporation/D-Link Systems, Inc. All rights reserved.

CE Mark Warning: This is a Class A product. In a residential environment, this product may cause radio interference, in which case the user may be required to take adequate measures.

FCC Statement: This equipment has been tested and found to comply with the limits for a Class A digital device, pursuant to part 15 of the FCC Rules. These limits are designed to provide reasonable protection against harmful interference in a commercial installation. This equipment generates, uses, and can radiate radio frequency energy and, if not installed and used in accordance with the instructions, may cause harmful interference to radio communication. However, there is no guarantee that interference will not occur in a particular installation. Operation of this equipment in a residential environment is likely to cause harmful interference to radio or television reception. If this equipment does cause harmful interference to radio or television reception, which can be determined by turning the equipment off and on, the user is encouraged to try to correct the interference by one or more of the following measures:

- Reorient or relocate the receiving antenna.
- Increase the separation between the equipment and receiver.
- Connect the equipment into an outlet on a circuit different from that to which the receiver is connected.
- Consult the dealer or an experienced radio/TV technician for help.

For detailed warranty information applicable to products purchased outside the United States, please contact the corresponding local D-Link office.

Product Registration

*Register your D-Link product online at <http://support.dlink.com/register/>
Product registration is entirely voluntary and failure to complete or return this form will not diminish your warranty rights.*

LIMITED WARRANTY (Exclude USA and Europe)

D-Link provides this limited warranty for its product only to the person or entity who originally purchased the product from D-Link or its authorized reseller or distributor. D-Link would fulfill the warranty obligation according to the local warranty policy in which you purchased our products.

Limited Hardware Warranty: D-Link warrants that the hardware portion of the D-Link products described below (“Hardware”) will be free from material defects in workmanship and materials from the date of original retail purchase of the Hardware, for the period set forth below applicable to the product type (“Warranty Period”) if the Hardware is used and serviced in accordance with applicable documentation; provided that a completed Registration Card is returned to an Authorized D-Link Service Office within ninety (90) days after the date of original retail purchase of the Hardware. If a completed Registration Card is not received by an authorized D-Link Service Office within such ninety (90) period, then the Warranty Period shall be ninety (90) days from the date of purchase.

| <i>Product Type</i> | <i>Warranty Period</i> |
|---|-------------------------------|
| Product (including Power Supplies and Fans) | One (1) Year |
| Spare parts and pare kits | Ninety (90) days |

D-Link’s sole obligation shall be to repair or replace the defective Hardware at no charge to the original owner. Such repair or replacement will be rendered by D-Link at an Authorized D-Link Service Office. The replacement Hardware need not be new or of an identical make, model or part; D-Link may in its discretion may replace the defective Hardware (or any part thereof) with any reconditioned product that D-Link reasonably determines is substantially equivalent (or superior) in all material respects to the defective Hardware. The Warranty Period shall extend for an additional ninety (90) days after any repaired or replaced Hardware is delivered. If a material defect is incapable of correction, or if D-Link determines in its sole discretion that it is not practical to repair or replace the defective Hardware, the price paid by the original purchaser for the defective Hardware will be refunded by D-Link upon return to D-Link of the defective Hardware. All Hardware (or part thereof) that is replaced by D-Link, or for which the purchase price is refunded, shall become the property of D-Link upon replacement or refund.

Limited Software Warranty: D-Link warrants that the software portion of the product (“Software”) will substantially conform to D-Link’s then current functional specifications for the Software, as set forth in the applicable documentation, from the date of original delivery of the Software for a period of ninety (90) days (“Warranty Period”), if the Software is properly installed on approved hardware and operated as contemplated in its documentation. D-Link further warrants that, during the Warranty Period, the magnetic media on which D-Link delivers the Software will be free of physical defects. D-Link’s sole obligation shall be to replace the non-conforming Software (or defective media) with software that substantially conforms to D-Link’s functional specifications for the Software. Except as otherwise agreed by D-Link in writing, the replacement Software is provided only to the original licensee, and is subject to the terms and conditions of the license granted by D-Link for the Software. The Warranty Period shall extend for an additional ninety (90) days after any replacement Software is delivered. If a material non-conformance is incapable of correction, or if D-Link determines in its sole discretion that it is not practical to replace the non-conforming Software, the price paid by the original licensee for the non-conforming Software will be refunded by D-Link; provided that the non-conforming Software (and all copies thereof) is first returned to D-Link. The license granted respecting any Software for which a refund is given automatically terminates.

What You Must Do For Warranty Service:

Registration Card. The Registration Card provided at the back of this manual must be completed and returned to an Authorized D-Link Service Office for each D-Link product within ninety (90) days after the product is purchased and/or licensed. The addresses/telephone/fax list of the nearest Authorized D-

Link Service Office is provided in the back of this manual. FAILURE TO PROPERLY COMPLETE AND TIMELY RETURN THE REGISTRATION CARD MAY AFFECT THE WARRANTY FOR THIS PRODUCT.

Submitting A Claim. Any claim under this limited warranty must be submitted in writing before the end of the Warranty Period to an Authorized D-Link Service Office. The claim must include a written description of the Hardware defect or Software nonconformance in sufficient detail to allow D-Link to confirm the same. The original product owner must obtain a Return Material Authorization (RMA) number from the Authorized D-Link Service Office and, if requested, provide written proof of purchase of the product (such as a copy of the dated purchase invoice for the product) before the warranty service is provided. After an RMA number is issued, the defective product must be packaged securely in the original or other suitable shipping package to ensure that it will not be damaged in transit, and the RMA number must be prominently marked on the outside of the package. The packaged product shall be insured and shipped to Authorized D-Link Service Office with all shipping costs prepaid. D-Link may reject or return any product that is not packaged and shipped in strict compliance with the foregoing requirements, or for which an RMA number is not visible from the outside of the package. The product owner agrees to pay D-Link's reasonable handling and return shipping charges for any product that is not packaged and shipped in accordance with the foregoing requirements, or that is determined by D-Link not to be defective or non-conforming.

What Is Not Covered:

This limited warranty provided by D-Link does not cover:

Products that have been subjected to abuse, accident, alteration, modification, tampering, negligence, misuse, faulty installation, lack of reasonable care, repair or service in any way that is not contemplated in the documentation for the product, or if the model or serial number has been altered, tampered with, defaced or removed;

Initial installation, installation and removal of the product for repair, and shipping costs;

Operational adjustments covered in the operating manual for the product, and normal maintenance;

Damage that occurs in shipment, due to act of God, failures due to power surge, and cosmetic damage;
and

Any hardware, software, firmware or other products or services provided by anyone other than D-Link.

Disclaimer of Other Warranties: EXCEPT FOR THE LIMITED WARRANTY SPECIFIED HEREIN, THE PRODUCT IS PROVIDED "AS-IS" WITHOUT ANY WARRANTY OF ANY KIND INCLUDING, WITHOUT LIMITATION, ANY WARRANTY OF MERCHANTABILITY, FITNESS FOR A PARTICULAR PURPOSE AND NON-INFRINGEMENT. IF ANY IMPLIED WARRANTY CANNOT BE DISCLAIMED IN ANY TERRITORY WHERE A PRODUCT IS SOLD, THE DURATION OF SUCH IMPLIED WARRANTY SHALL BE LIMITED TO NINETY (90) DAYS. EXCEPT AS EXPRESSLY COVERED UNDER THE LIMITED WARRANTY PROVIDED HEREIN, THE ENTIRE RISK AS TO THE QUALITY, SELECTION AND PERFORMANCE OF THE PRODUCT IS WITH THE PURCHASER OF THE PRODUCT.

Limitation of Liability: TO THE MAXIMUM EXTENT PERMITTED BY LAW, D-LINK IS NOT LIABLE UNDER ANY CONTRACT, NEGLIGENCE, STRICT LIABILITY OR OTHER LEGAL OR EQUITABLE THEORY FOR ANY LOSS OF USE OF THE PRODUCT, INCONVENIENCE OR DAMAGES OF ANY CHARACTER, WHETHER DIRECT, SPECIAL, INCIDENTAL OR CONSEQUENTIAL (INCLUDING, BUT NOT LIMITED TO, DAMAGES FOR LOSS OF

GOODWILL, WORK STOPPAGE, COMPUTER FAILURE OR MALFUNCTION, LOSS OF INFORMATION OR DATA CONTAINED IN, STORED ON, OR INTEGRATED WITH ANY PRODUCT RETURNED TO D-LINK FOR WARRANTY SERVICE) RESULTING FROM THE USE OF THE PRODUCT, RELATING TO WARRANTY SERVICE, OR ARISING OUT OF ANY BREACH OF THIS LIMITED WARRANTY, EVEN IF D-LINK HAS BEEN ADVISED OF THE POSSIBILITY OF SUCH DAMAGES. THE SOLE REMEDY FOR A BREACH OF THE FOREGOING LIMITED WARRANTY IS REPAIR, REPLACEMENT OR REFUND OF THE DEFECTIVE OR NON-CONFORMING PRODUCT.

GOVERNING LAW: This Limited Warranty shall be governed by the laws of the state of California.

Some states do not allow exclusion or limitation of incidental or consequential damages, or limitations on how long an implied warranty lasts, so the foregoing limitations and exclusions may not apply. This limited warranty provides specific legal rights and the product owner may also have other rights which vary from state to state.

Trademarks

Copyright © 2002 D-Link Corporation. Contents subject to change without prior notice. D-Link is a registered trademark of D-Link Corporation/D-Link Systems, Inc. All other trademarks belong to their respective proprietors.

Copyright Statement

No part of this publication may be reproduced in any form or by any means or used to make any derivative such as translation, transformation, or adaptation without permission from D-Link Corporation/D-Link Systems Inc., as stipulated by the United States Copyright Act of 1976.

FCC Warning

This equipment has been tested and found to comply with the limits for a Class A digital device, pursuant to Part 15 of the FCC Rules. These limits are designed to provide reasonable protection against harmful interference when the equipment is operated in a commercial environment. This equipment generates, uses, and can radiate radio frequency energy and, if not installed and used in accordance with this manual, may cause harmful interference to radio communications. Operation of this equipment in a residential area is likely to cause harmful interference in which case the user will be required to correct the interference at his own expense.

Tech Support

Technical Support

You can find software updates and user documentation on the D-Link website.

D-Link provides free technical support for customers within the United States and within Canada for the duration of the service period, and warranty confirmation service, during the warranty period on this product. U.S. and Canadian customers can contact D-Link technical support through our website, or by phone.

Tech Support for customers within the United States:

D-Link Technical Support over the Telephone:

USA - 877-DLINK-55 (877-354-6555)

D-Link Technical Support over the Internet:

<http://support.dlink.com>

Tech Support for customers within Canada:

D-Link Technical Support over the Telephone:

877-354-6560

D-Link Technical Support over the Internet:

<http://support.dlink.com>

D-Link[®]
Building Networks for People

Technical Support

United Kingdom (Mon-Fri)

Home Wireless/Broadband 0871 873 3000 (9.00am–06.00pm, Sat 10.00am-02.00pm)
Managed, Smart, & Wireless Switches, or Firewalls 0871 873 0909 (09.00am – 05.30pm)
(BT 10ppm, other carriers may vary.)

Ireland (Mon-Fri)

All Products 1890 886 899 (09.00am-06.00pm, Sat 10.00am-02.00pm)
€ 0.05ppm peak, €0.045ppm off peak Times

Internet

<http://www.dlink.co.uk>
<ftp://ftp.dlink.co.uk>

Technische Unterstützung

| | | |
|--------------|----------|--|
| Deutschland: | Web: | http://www.dlink.de |
| | E-Mail: | support@dlink.de |
| | Telefon: | +49(0)1805 2787 0,14 € pro Minute |
| | Zeiten: | Mo. –Fr. 09:00 – 17:30 Uhr |
| Österreich: | Web: | http://www.dlink.at |
| | E-Mail: | support@dlink.at |
| | Telefon: | +43(0)820 480084 0,116 € pro Minute |
| | Zeiten: | Mo. –Fr. 09:00 – 17:30 Uhr |
| Schweiz: | Web: | http://www.dlink.ch |
| | E-Mail: | support@dlink.ch |
| | Telefon: | +41(0)848 331100 0,08 CHF pro Minute |
| | Zeiten: | Mo. –Fr. 09:00 – 17:30 Uhr |

* Gebühren aus Mobilnetzen und von anderen Providern können abweichen.

* Gebühren aus Mobilnetzen und von anderen Providern können abweichen.

Assistance technique

Assistance technique D-Link par téléphone : 0 820 0803 03
0,12 €/min la minute : Lundi – Vendredi de 9h à 13h et de 14h à 19h
Samedi 9h à 13h et de 14h à 16h
Assistance technique D-Link sur internet :
<http://www.dlink.fr>

Asistencia Técnica

Asistencia Técnica Telefónica de D-Link: +34 902 30 45 45
0,067 €/min
De Lunes a Viernes de 9:00 a 14:00 y de 15:00 a 18:00
<http://www.dlink.es>

Supporto tecnico

Supporto Tecnico dal lunedì al venerdì dalle ore 9.00 alle ore 19.00 con orario
continuato
Telefono: 199400057
<http://www.dlink.it/support>

Technical Support

Tech Support for customers within the Netherlands:
0900 501 2007 / www.dlink.nl / €0.15ppm anytime.
Tech Support for customers within Belgium:
070 66 06 40 / www.dlink.be / €0.175ppm peak, €0.0875ppm off peak
Tech Support for customers within Luxemburg:
+32 70 66 06 40 / www.dlink.be

Pomoc techniczna

Telefoniczna pomoc techniczna firmy D-Link: 0 801 022 021

Pomoc techniczna firmy D-Link świadczona przez Internet:

URL: <http://www.dlink.pl>

e-mail: serwis@dlink.pl

Technická podpora

Web: <http://www.dlink.cz/support/>

E-mail: support@dlink.cz

Telefon: 225 281 553

Telefonická podpora je v provozu: PO- PÁ od 09.00 do 17.00

Land Line 1,78 CZK/min - Mobile 5.40 CZK/min

Technikai Támogatás

Tel. : 06 1 461-3001

Fax : 06 1 461-3004

Land Line 14,99 HUG/min - Mobile 49.99,HUF/min

email : support@dlink.hu

URL : <http://www.dlink.hu>

Teknisk Support

D-Link Teknisk telefon Support: 820 00 755

(Hverdager 08:00-20:00)

D-Link Teknisk Support over Internettet: <http://www.dlink.no>

Teknisk Support

D-Link teknisk support over telefonen: Tlf. 7026 9040

Åbningstider: kl. 08:00 – 20:00

D-Link teknisk support på Internettet: <http://www.dlink.dk>

Teknistä tukea asiakkaille Suomessa:

Arkisin klo. 9 - 21
numerosta : **06001 5557**
Internetin kautta : <http://www.dlink.fi>

Teknisk Support

D-Link Teknisk Support via telefon: 0900-100 77 00
Vardagar 08.00-20.00
D-Link Teknisk Support via Internet: <http://www.dlink.se>

Assistência Técnica

Assistência Técnica da D-Link na Internet:
<http://www.dlink.pt>
e-mail: soporte@dlink.es

Τεχνική Υποστήριξη

D-Link Hellas Support Center
Κεφαλληνίας 64, 11251 Αθήνα,
Τηλ: 210 86 11 114 (Δευτέρα- Παρασκευή 09:00-17:00)
Φαξ: 210 8611114
<http://www.dlink.gr/support>

Tehnička podrška

Hvala vam na odabiru D-Link proizvoda. Za dodatne informacije, podršku i upute za korištenje uređaja, molimo vas da posjetite D-Link internetsku stranicu na www.dlink.eu
www.dlink.biz/hr

Tehnična podpora

Zahvaljujemo se vam, ker ste izbrali D-Link proizvod. Za vse nadaljnje informacije, podpora ter navodila za uporabo prosimo obiščite D-Link - ovo spletno stran www.dlink.eu
www.dlink.biz/sl

Suport tehnica

Vă mulțumim pentru alegerea produselor D-Link. Pentru mai multe informații, suport și manuale ale produselor vă rugăm să vizitați site-ul D-Link www.dlink.eu
www.dlink.ro

Technical Support

You can find software updates and user documentation on the D-Link website.

Tech Support for customers in

Australia:

Tel: 1300-766-868

24/7(24Hrs, 7days a week) technical support

<http://www.dlink.com.au>

e-mail: support@dlink.com.au

India:

Tel: 1800-222-002

9.00 AM to 9.00 PM. All days

<http://www.dlink.co.in/support/productsupport.aspx>

Indonesia, Malaysia, Singapore and Thailand:

Tel: +62-21-5731610 (Indonesia)

Tel: 1800-882-880 (Malaysia)

Tel: +65 6501 4200 (Singapore)

Tel: +66-2-719-8978/9 (Thailand)

24/7, for English Support Only

<http://www.dlink.com.sg/support/>

e-mail: support@dlink.com.sg

Korea:

Tel: +82-2-2028-1815

Monday to Friday 9:00am to 6:00pm

<http://www.d-link.co.kr>

e-mail: arthur@d-link.co.kr

New Zealand:

Tel: 0800-900-900

24/7(24Hrs, 7days a week) technical support

<http://www.dlink.co.nz>

e-mail: support@dlink.co.nz

D-Link[®]
Building Networks for People

Technical Support

You can find software updates and user documentation on the D-Link website.

Tech Support for customers in

Egypt:

Tel: +202-2919035 or +202-2919047
Sunday to Thursday 9:00am to 5:00pm
<http://support.dlink-me.com>
Email: support.eg@dlink-me.com

Iran:

Te: +98-21-88880918,19
Saturday to Thursday 9:00am to 5:00pm
<http://support.dlink-me.com>
Email : support.ir@dlink-me.com & support@dlink.ir

Israel:

Magshimim 20 St., Matalon center,
Petach Tikva, Israel 49348
Consumer support line: 03-9212886
Business support line: 03-9212608

Pakistan:

Tel: +92-21-4548158 or +92-21-4548310
Monday to Friday 10:00am to 6:00pm
<http://support.dlink-me.com>
E-mail: zkashif@dlink-me.com

South Africa and Sub Sahara Region:

Tel: +27-12-665-2165
08600 DLINK (for South Africa only)
Monday to Friday 8:30am to 9:00pm South Africa Time
<http://www.d-link.co.za>

Turkey:

Tel: +90-212-2895659
Monday to Friday 9:00am to 6:00pm
<http://www.dlink.com.tr>
e-mail: turkiye@dlink-me.com
e-mail: support@d-link.co.za

U.A.E and North Africa:

Tel: +971-4-4278127 (U.A.E)
Sunday to Thursday 9.00AM to 6.00PM GMT+4
Web: <http://www.dlink-me.com>
E-mail: support.me@dlink-me.com

Saudi ARABIA (KSA):

Telephone : +966 01 217 0008
Facsimile : +966 01 217 0009
e-mail: Support.sa@dlink-me.com
Saturday to Wednesday 9.30AM to 6.30PM
Thursdays 9.30AM to 2.00 PM

Техническая поддержка

Обновления программного обеспечения и документация доступны на Интернет-сайте D-Link.

D-Link предоставляет бесплатную поддержку для клиентов в течение гарантийного срока.

Клиенты могут обратиться в группу технической поддержки D-Link по телефону или через Интернет.

Техническая поддержка D-Link:
+7(495) 744-00-99

Техническая поддержка через Интернет
<http://www.dlink.ru>
e-mail: support@dlink.ru

D-Link[®]
Building Networks for People

SOPORTE TÉCNICO

Usted puede encontrar actualizaciones de softwares o firmwares y documentación para usuarios a través de nuestro sitio www.dlinkla.com

SOPORTE TÉCNICO PARA USUARIOS EN LATINO AMERICA

Soporte técnico a través de los siguientes teléfonos de D-Link

| PAIS | NUMERO | HORARIO |
|----------------------|-----------------------------|-----------------------------------|
| Argentina | 0800 - 12235465 | Lunes a Viernes 08:00am a 21:00pm |
| Chile | 800 - 835465 ó (02) 5941520 | Lunes a Viernes 08:00am a 21:00pm |
| Colombia | 01800 - 9525465 | Lunes a Viernes 06:00am a 19:00pm |
| Costa Rica | 0800 - 0521478 | Lunes a Viernes 05:00am a 18:00pm |
| Ecuador | 1800 - 035465 | Lunes a Viernes 06:00am a 19:00pm |
| El Salvador | 800 - 6335 | Lunes a Viernes 05:00am a 18:00pm |
| Guatemala | 1800 - 8350255 | Lunes a Viernes 05:00am a 18:00pm |
| México | 01800 - 1233201 | Lunes a Viernes 06:00am a 19:00pm |
| Panamá | 011 008000525465 | Lunes a Viernes 05:00am a 18:00pm |
| Perú | 0800 - 00968 | Lunes a Viernes 06:00am a 19:00pm |
| República Dominicana | 18887515478 | Lunes a Viernes 05:00am a 18:00pm |
| Venezuela | 0800 - 1005767 | Lunes a Viernes 06:30am a 19:30pm |

Soporte Técnico de D-Link a través de Internet

www.dlinkla.com

e-mail: soporte@dlinkla.com & consultas@dlinkla.com

D-Link®
Building Networks for People

Suporte Técnico

Você pode encontrar atualizações de software e documentação de usuário no site da D-Link Brasil.

A D-Link fornece suporte técnico gratuito para clientes no Brasil durante o período de vigência da garantia deste produto.

Suporte Técnico para clientes no Brasil:

Telefone

São Paulo +11-2185-9301

Segunda à sexta

Das 8h30 às 18h30

Demais Regiões do Brasil 0800 70 24 104

E-mail:

e-mail: suporte@dlinkbrasil.com.br

D-Link[®]
Building Networks for People

D-Link 友訊科技 台灣分公司 技術支援資訊

如果您還有任何本使用手冊無法協助您解決的產品相關問題，台灣地區用戶可以透過我們的網站、電子郵件或電話等方式與D-Link台灣地區技術支援工程師聯絡。

D-Link 免付費技術諮詢專線

0800-002-615

服務時間：週一至週五，早上9:00到晚上9:00

(不含周六、日及國定假日)

網 站：<http://www.dlink.com.tw>

電子郵件：dssqa_service@dlink.com.tw

如果您是台灣地區以外的用戶，請參考D-Link網站全球各地分公司的聯絡資訊以取得相關支援服務。

產品保固期限、台灣區維修據點查詢，請參考以下網頁說明：

<http://www.dlink.com.tw>

產品維修：

使用者可直接送至全省聯強直營維修站或請洽您的原購買經銷商。

D-Link®
Building Networks for People

Dukungan Teknis

Update perangkat lunak dan dokumentasi pengguna dapat diperoleh pada situs web D-Link.

Dukungan Teknis untuk pelanggan:

Dukungan Teknis D-Link melalui telepon:

Tel: +62-21-5731610

Dukungan Teknis D-Link melalui Internet:

Email : support@dlink.co.id

Website : <http://support.dlink.co.id>

D-Link[®]
Building Networks for People

Technical Support

この度は弊社製品をお買い上げいただき、誠にありがとうございます。
させていただきます。

下記弊社 Web サイトからユーザ登録及び新製品登録を行っていただくと、ダウンロードサービスにてサポート情報、ファームウェア、ユーザマニュアルをダウンロードすることができます。

ディーリンクジャパン Web サイト

URL:<http://www.dlink-jp.com>

D-Link[®]
Building Networks for People

技术支持

您可以在 D-Link 的官方网站找到产品的软件升级和使用手册

办公地址：北京市东城区北三环东路 36 号 环球贸易中心 B 座 26F
02-05 室 邮编: 100013

技术支持中心电话：8008296688/ (028)66052968

技术支持中心传真：(028)85176948

维修中心地址：北京市东城区北三环东路 36 号 环球贸易中心 B 座
26F 02-05 室 邮编: 100013

维修中心电话：(010) 58257789

维修中心传真：(010) 58257790

网址：<http://www.dlink.com.cn>

办公时间：周一到周五，早09:00到晚18:00

D-Link[®]
Building Networks for People